

# Operating Instructions

## Tumble dryer

*Dear Maytag customer,*

*Thank you for choosing this quality product from Scandinavia, made in Vara, Sweden.*

*We want you to feel assured that the inside of your new machine is just as good as the outside and that the ethics and standards that went into the production of this machine are just as high as the quality and performance that you will receive from it. We hope that this product will give you many years of pleasure.*

*To get the most out of your new machine, we recommend that you read the Use & Care Guide before using the machine.*

**MDE9651**



# Contents

<b>Contents</b>	2	<b>Technical information</b>	16
<b>Before using your machine for the first time</b>	3	Technical data	16
Do not tumble-dry	3	<b>Service</b>	17
<b>Safety instructions</b>	4	Before contacting the service division	17
General	4	<b>Installation</b>	18
Installation	4	Positioning the tumble dryer	18
Safety	4	Adjusting the feet	19
Stopping a programme	4	Condensed water	19
Transport/Winter storage	4	Electrical installation	20
Packing material	4	<b>Door hanging</b>	21
Disposal	4	<b>Search words</b>	23
<b>Child safety</b>	5	<b>Quick guide</b>	24
General	5		
<b>Options buttons</b>	7		
<b>Advice and tips before you tumble-dry</b>	8		
Has it been spun?	8		
Laundry labels	8		
Materials that must not be tumble-dried	8		
And do not tumble-dry...	8		
<b>Tumble-drying</b>	9		
Sort your fabrics	9		
Turn on the main power switch	9		
Open the door and load the washing	9		
Select programme	9		
Select options	9		
Press the Start button	10		
Drying programme finished	10		
Once drying has finished	11		
<b>Consumption values</b>	12		
<b>Care and cleaning</b>	13		
Cleaning the fluff filter	13		
Draining the condensed water container	13		
Cleaning the outside of the machine	13		
Cleaning the condenser	14		
<b>Troubleshooting</b>	15		
The machine will not start	15		
Error messages	15		

# Before using your machine for the first time

## **Do not tumble-dry**

Certain materials are sensitive to tumble-drying. Always check and follow an item's laundry label. You can read more on page 9, "Before tumble-drying".

## **Note!**

When starting the tumble dryer for the first time or after a long period without use, you may notice a slight thumping sound. This is completely normal and will stop after a few loads.

**See the Quick guide on the last page.**

# Safety instructions



## General

- Read and keep the Use & Care Guide!
- Electrical installation, if required, should be carried out by qualified professionals.
- The machine should only be used for tumble-drying as described in these instructions.
- Repairs and maintenance relating to safety or performance must be carried out by a qualified professional.
- Damaged mains cables must only be replaced by a qualified professional.
- Sufficient ventilation is required to prevent smoke from open fires or fumes from equipment burning other fuels being sucked into the room.

## Installation

See the “Installation” chapter.

## Safety

The machine must not be used for drying items that have been dry-cleaned at home or fabrics that may contain residues of flammable liquids.

The tumble dryer is protected by an overheating cut-out. This shuts off the machine if the temperature gets too high.

A float shuts off the machine in the event of a blockage in the condensed water hose or if there is a risk of the condensed water container overflowing.

## Stopping a programme

You can stop a drying programme by:

- opening the door; the drum stops automatically,
- or by pressing the main power switch.
- When you want to resume tumble-drying, simply close the door and press the Start/Stop button.
- You can also stop a programme by pressing the Start/Stop button for three seconds.

## Transport/Winter storage

If you need to move your machine or store it over the winter in unheated premises, then make sure you drain the condensed water container beforehand.

## Packing material

Sort waste in accordance with local guidelines.

## Disposal

When the machine has reached the end of its service life and is to be disposed of, it should immediately be made unusable. Contact your local authority for information about where your old machine should be disposed of and recycled in the proper way. The machine is manufactured and labelled to facilitate recycling.

## Caution



During operation, the back of the tumble dryer will get very hot. Leave the machine to cool completely before touching the back.

# Child safety



## General

**Do not allow children to play with the tumble dryer.**

The tumble dryer has a magnetic catch, allowing the door to be opened from the inside. The door has a door-switch that automatically stops the tumble dryer when the door is opened. The tumble dryer does not start automatically when the door closes (e.g. if a child closes the door from inside).

# Parts of the tumble dryer

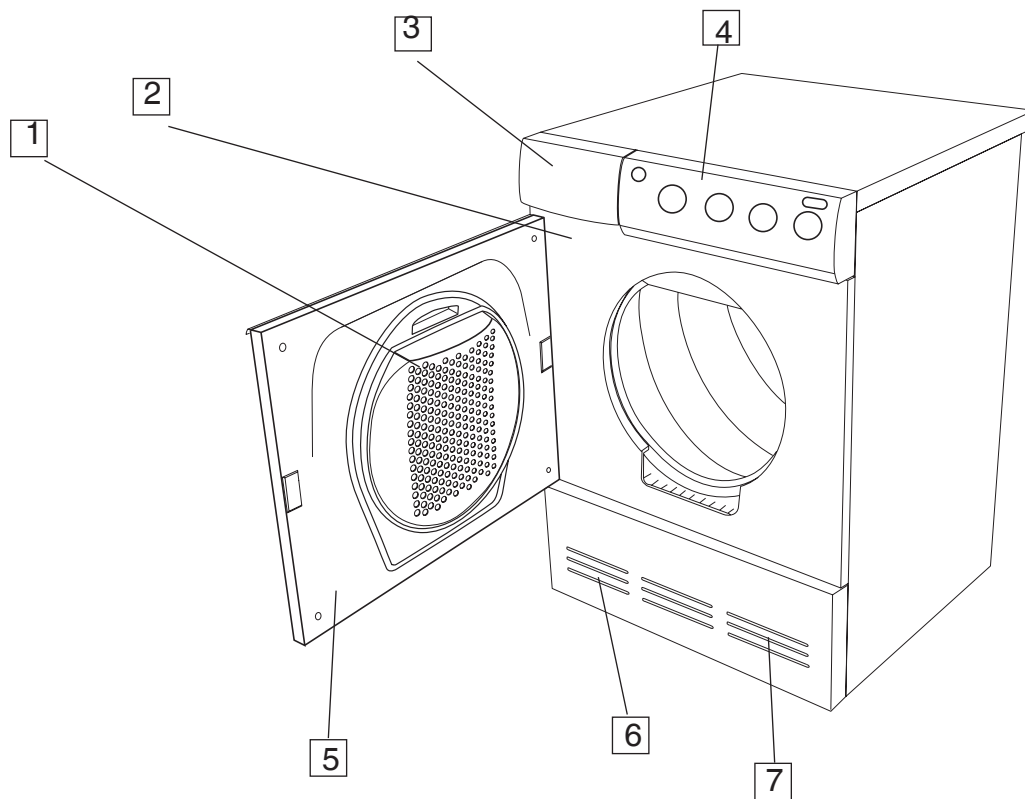

- |    |                           |    |                                    |
|----|---------------------------|----|------------------------------------|
| 1. | Fluff filter holder       | 5. | Outer door                         |
| 2. | Type plate                | 6. | Fan (behind the front plate)       |
| 3. | Condensed water container | 7. | Condenser (behind the front plate) |
| 4. | Panel                     | 8. | Fluff filter                       |

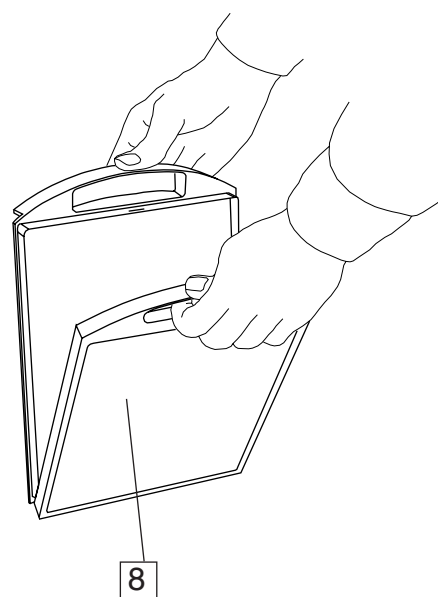

# Front panel

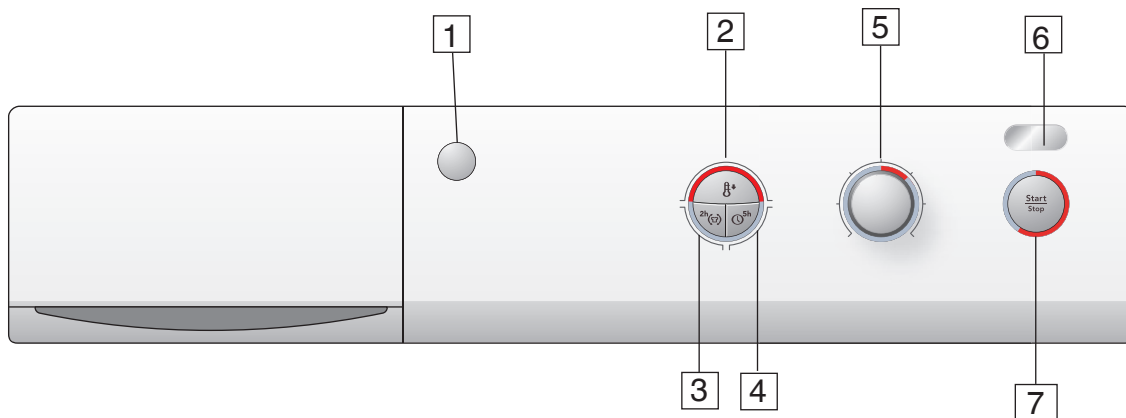

1. Main power switch
- 2-4. Options buttons
5. Programme selector
6. Display
7. Start/Stop

# Options buttons

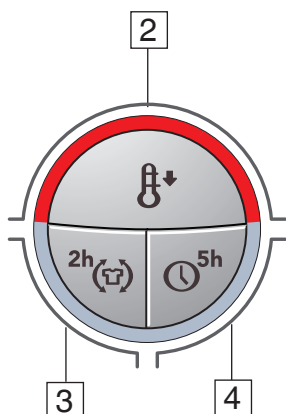

2. Button for selecting Low Temperature
3. Button for selecting Anti-crease Programme
4. Button for selecting Delayed Start 5 h

# Advice and tips before you tumble-dry

Here are some tips that may help you before you begin tumble-drying.

## Has it been spun?

Items to be tumble-dried should be spun at 1000 rpm or faster. Better spinning saves both energy and drying time.

## Laundry labels

### Materials that can be tumble-dried

This symbol means that the material is suitable for tumble-drying. Fabrics best suited to tumble-drying are cotton fabrics, terry cloth and synthetic fibres. Garments will be softer and lighter when tumbled than when hung out to dry.

### Note!

Wear to fabrics in the tumble dryer is insignificant. The fluff that gets caught in the fluff filter is dust and fibre remnants formed when the items are used.

## Materials that must not be tumble-dried

This symbol means that the material is not suitable for tumble-drying. Certain materials may melt or become a fire hazard if exposed to heat, and others lose their shape or shrink.

## And do not tumble-dry...

- materials labelled "Do not dry near heat",
- garments that have been dry-cleaned at home,
- foam plastic,
- fibreglass material,
- wool must not be tumble-dried due to the risk of felting.



# Tumble-drying

Below are step-by-step instructions to help you achieve the best possible tumble-drying results.

**1 Sort your fabrics**  
You will achieve the most uniform drying results if the items are the same material.

Do up zips and buttons, fasten belts, sort the items and adjust load and temperature.

**2 Turn on the main power switch**

**3 Open the door, load the items and then close the door**

**4 Select programme**  
The choice of programme depends on what you intend to do with the items after tumbling. The programme options are Extra Dry, Dry, Normal Dry, Iron Dry, Timed programme and Airing.

## Extra Dry

This programme is for items that are particularly difficult to dry, e.g. jeans with very thick seams.

## Note!

Knit fabrics in particular are prone to shrinkage. Use the Dry, Normal Dry or Iron Dry programmes for such items. Stretch clothes back into shape immediately after drying.

## Dry, Normal Dry

These programmes shut off the heat once the load is dry without being “bone-dry”. The Dry programme shuts off the heat slightly later than Normal Dry. Use trial and error to find out what works best. Use these programmes when you want items to be completely dry.

## Iron Dry

This programme shuts off the heat once the load is just damp enough for ironing or pressing.

## Timed dry 60 min

The Timed dry programme has a fixed drying time and tumble-dries the load for 60 minutes.

## Air fluff 60 min

Use the Air fluff programme when you just want to refresh, air or soften up items.

## 5 Select options

By selecting options, you can tailor drying programmes to suit your own laundry requirements.

The machine remembers which settings and options you choose for each programme and uses these (with one exception - Delayed start) the next time you select the programme in question. You can, of course, change them again if you wish.

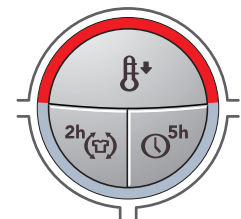

## Low temperature

Select or deselect Low Temperature by pressing the Temperature button. Once Low Temperature has been selected, the red field next to the button lights up.

## Anti-crease

This option means that the drum will rotate three seconds per minute for two hours once the drying programme has finished. This option prevents the items remaining in the same position and becoming creased. A useful feature if you are not able to remove the load as soon as tumble-drying has finished.

A lighted red field by the button indicates that the Anti-crease option has been activated.



### Delayed Start

Select or deselect this option by pressing the Delayed Start button. The machine will start the programme 5 hours after you select this option + the Start/Stop button. A lighted red field by the button indicates that the option has been activated. If you change your mind, press the Start/Stop button for three seconds. You can now start the machine as usual

## 6 Press the Start button

### Drying time remaining

An estimate of the remaining drying time will be shown in the display within 2 minutes of the drying programme starting. For example, 1:35 means that approximately 1 hour and 35 minutes remain until the load achieves the selected level of dryness. If the Anti-crease option has been selected, the drum will rotate every minute for 2 hours after cooling.

### If you want to stop or change a programme.

Press and hold the Start/Stop button for 3 seconds. The red field next to the button goes out.

### Note!

The programme is not affected if the programme selector is changed after the programme starts.

### To load or remove washing

If you want to load or remove washing once you have started the machine, open the door and the machine will stop automatically. Load more washing, close the door and press the Start/Stop button.

## 7 Drying programme finished

The text **End** in the display indicates that the programme has finished.

If the Anti-crease option has been selected, the drum will rotate every minute for 2 hours after cooling.

### Important!

- Clean the fluff filter after each load.
- Drain the condensed water container after each load.

### Caution!

If the fluff filter becomes clogged, the machine's automatic overheating cut-out may be triggered. To enable the machine to be restarted, the filter must be cleaned and the machine allowed to cool for around 30 minutes.

### Cleaning the fluff filter

1. Grasp the filter handle and pull it towards you.
2. Pull the filter out of its holder.
3. Open the filter and remove the fluff by hand.
4. Fold the filter up and re-insert it into its holder. The filter may need to be cleaned if limescale deposits occur, see "Care and cleaning" chapter.

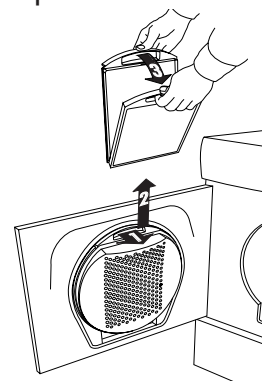

## **Draining the condensed water container**

The condensed water container must be drained after each load.

Remove the condensed water container, empty out the water and replace the container.

If the condensed water container becomes full to overflowing, the programme is interrupted and **F i** is shown in the display. Empty the container and press the Start/Stop button to restart the programme. See also Error Messages on page 16 in the “Troubleshooting” chapter.

### **Note!**

Do not remove the condensed water container while the machine is switched on.

### **Advice!**

As the condensed water is decalcified, it can be used in steam irons. Pour through a coffee filter.

## **Automatic drain**

If you want the water to drain automatically, please see Installation.



## **Once drying has finished**

Switch off the main power switch.  
Remove the clothes, and close the door to prevent small children from climbing into the machine.

# Consumption values

**For the consumption values given below, the following prerequisites apply:**

Temperature of intake air: 20 °C.

Moisture content of intake air: 65 %.

Drying temperature: Normal or low.

Element power: 2500 W.

Before tumble-drying, cotton fabrics are spun at 800 and 1600 rpm (long spin).

Before tumble-drying, other fabrics (crease-resistant and acrylic) are spun at 800 rpm (short spin).

Programme	Material	Temperature	Max. load (kg)	Energy consumption (approx. kWh)		Programme time (approx. min.)	
				800 rpm	1600 rpm	800 rpm	1600 rpm
Extra Dry	Cotton, linen	Normal	6.0	5.0	4.1	155	130
Dry	Cotton, linen	Normal	6.0	4.2	3.2	130	100
Dry	Crease-resistant, polyester/cotton	Normal	3.0	1.8	-	60	-
Normal Dry	Cotton, linen	Normal	6.0	3.8	2.9	120	95
Normal Dry	Crease-resistant, polyester/cotton	Normal	3.0	1.7	-	55	-
Normal Dry	Acrylic, rayon, acetate	Low	3.0	2.1	-	80	-
Iron Dry	Cotton, linen	Normal	6.0	3.4	2.3	105	75

# Care and cleaning

## Cleaning the fluff filter

The fluff filter must be cleaned after each load.

If you have very hard water, this can cause limescale deposits in the fluff filter. Check for any limescale deposits when cleaning the fluff filter and, if necessary, wash down the filter by hand.

1. Grasp the filter handle and pull it towards you.
2. Pull the filter out of its holder.

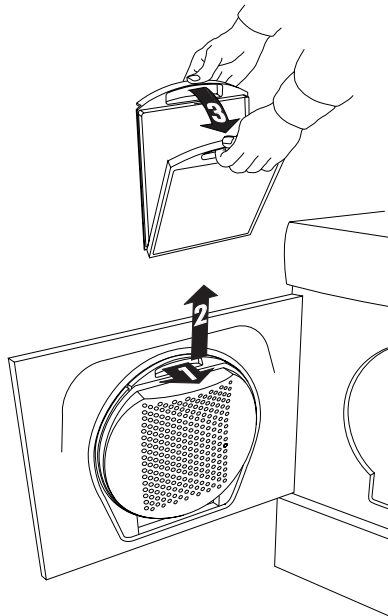

3. Open the filter and remove the fluff from all sides by hand. Use a soft dry cloth to remove any coating.

4. Replace the filter in its holder.

### Note!

If you have hard water, the filter should be washed down with water to get rid of any limescale deposits.

Dry the filter carefully with a towel.

## Draining the condensed water container

The condensed water container must be drained after each load.

Remove the condensed water container, empty out the water and replace the container.

If the condensed water container becomes full to

overflowing, the programme is interrupted and the error message F1 is shown in the display. Empty the container and press the Start/Stop button to restart the programme. See also Error Messages on page 16 in the “Troubleshooting” chapter.

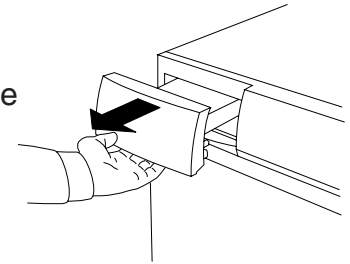

### Note!

Do not remove the condensed water container while the machine is switched on.

## Cleaning the outside of the machine

Clean the outside of the machine and the programme panel with a mild cleaner. Do not use any solvents, as these can damage the machine. Do not hose down or spray the machine with water.

### Note!

Do not allow dust to accumulate around the machine. Keep the area around the tumble dryer clean and cool; dust, heat and moisture prolong drying times.



## Cleaning the condenser

The condenser should be cleaned at least three times a year. If you have pets, the condenser must be cleaned more frequently.

1. Switch off the main power switch.

2. Remove the front plate.

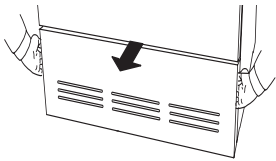

3. Open the condenser panel by turning the two knobs anticlockwise.

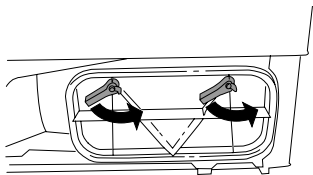

4. Remove the condenser and rinse the lamellas clean using a hand shower, for example. Do not poke around in the lamella springs, as you may damage the condenser. Do not use pointed metal objects during cleaning.

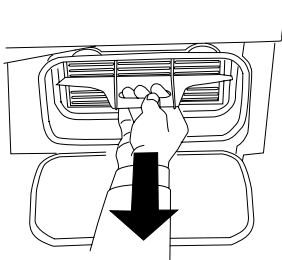

### Note!

Do not put the condenser in a dishwasher.

5. Replace the condenser. When reinstalling the condenser, check that it is replaced in the correct way. The top of the condenser is labelled “upp”, “up” and “oben”.

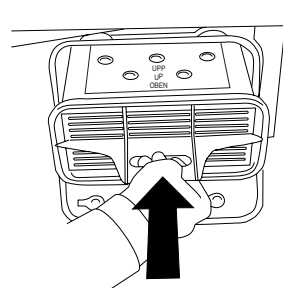

6. Replace the front plate.

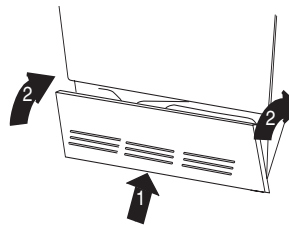

# Troubleshooting

## The machine will not start

Check

- that the outer door is properly closed
- that the main power switch is pressed
- that you have set the programme correctly
- that the Delayed Start option has not been selected. If so, the time remaining until start will be shown in full hours in the display (e.g. 5, 4, 3h). To cancel the programme, see page 10
- that any plug is connected
- that your home's fuses (circuit breakers) are intact, swap two circuit breakers. You cannot always tell from outside if a circuit breaker is broken
- that the overheating cut-out has not been triggered (see below).

## Overheating cut-out

The overheating cut-out shuts off the tumble dryer if the temperature is too high, e.g. because dust is clogging the fluff filter.

- Clean the filter.
- Check also that the condensed water container is not full and, if necessary, clean the condenser. See "Care and cleaning" on page 14.
- The overheating cut-out will reset automatically once the machine has cooled.

## Drying takes too long

- Empty the condensed water container and check that neither the fluff filter nor the condenser is clogged. See "Care and cleaning" on page 14.
- Prolonged drying times may also be due to the condenser dryer being placed in a room that is too small and the air in the room (cooling air) being too hot.
- Make sure that the tumble dryer has access to more cold air, e.g. by opening doors and/or windows.

## Error messages

- If **F1** flashes in the display, the condensed water container is full.  
Empty the container and restart.
- If **F2** flashes in the display, the maximum permitted programme time has been reached. For remedial action, read "Drying takes too long" in the "Troubleshooting" section.

# Technical information

## Technical data

Height:	850 mm
Width:	595 mm
Depth:	585 mm
Weight:	47 kg
Cylinder volume:	111 l
Max. drying capacity:	6.0 kg
RPM:	52 rpm
Rated power:	See type plate.
Drying drum material:	Stainless steel.
Outer casing material:	Powder-coated and hot-galvanized sheet steel or stainless steel.
Setup:	Stacking or freestanding.
Drain:	2.0 m rubber hose

## Standard tests

Europe:

Drying performance:	EN 611 21 (95/13/EEC). Dry, 6.0 kg cotton, temperature Normal.
Energy declaration:	EN 611 21 (95/13/EEC). Dry, 6.0 kg cotton, temperature Normal. The machine has been tested for single-phase 10/16A.
Test method noise measurement:	IEC 60 704-2-6.



# Service

## Before contacting the service division,

you should find out whether the fault is anything you can take care of yourself. See the chapters “Troubleshooting” and “Care and cleaning”. If you do need to contact the service division after all, make sure you know the model designation, type designation and serial number.

The model designation can be found in the stamped hole on the first page of the Use & Care. Type designation and serial number can be found on the type plate.

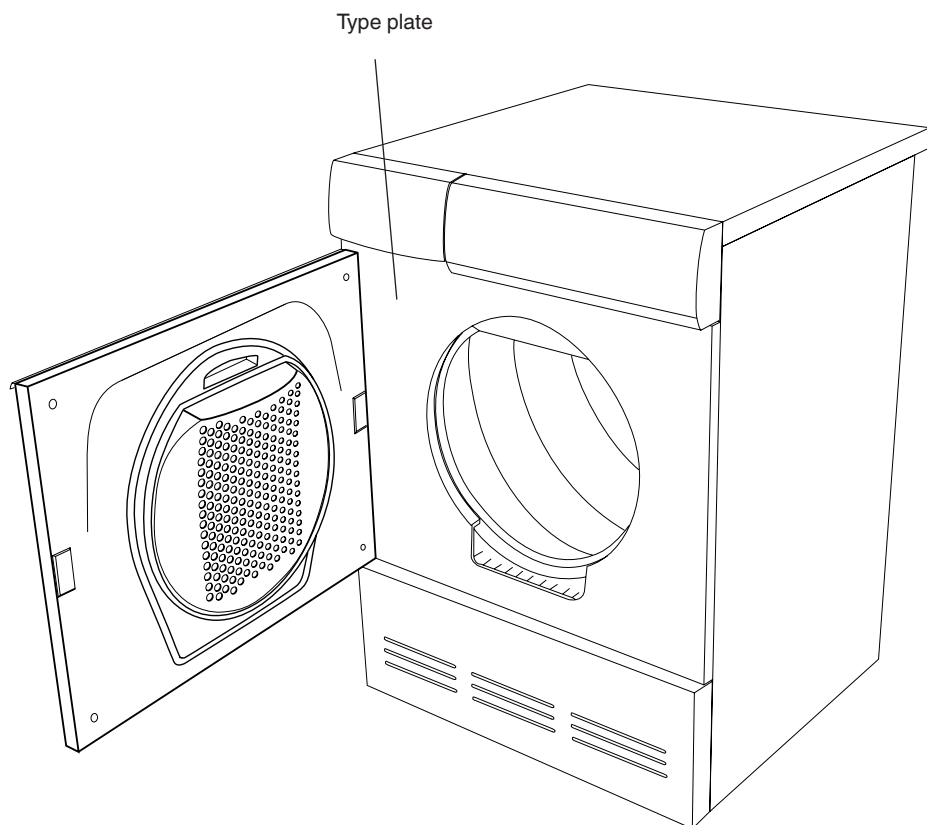

# Installation

## Positioning the tumble dryer

The tumble dryer can be positioned as freestanding or in a stack. Remember that the tumble dryer produces heat and should therefore not be located in a room that is too small. If the room is very small, drying will take longer due to the limited quantity of air.

### Caution!



The machine must not be installed behind a lockable door, a sliding door or a door with hinges on the opposite side to those of the tumble dryer.

### Advice!

To improve ventilation, leave the door to the room where the tumble dryer is located open.

### Caution!



Any electrical installation must be carried out by qualified professionals.

## A. Freestanding

The tumble dryer can be positioned beside the washing machine.

## B. Stacking

The tumble dryer can be placed on top of an Asko washing machine. In this case you use the stacking attachments that come with the machine:

2 foot cups. These can be found in a bag in the drum.

2 anti-tilt devices. These come attached to the bottom left corner on the back of the machine.

Extending plates can be ordered from your local retailer.

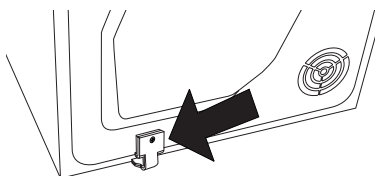

## How to fit the stacker

1. Undo the two screws indicated on the back of the washing machine.

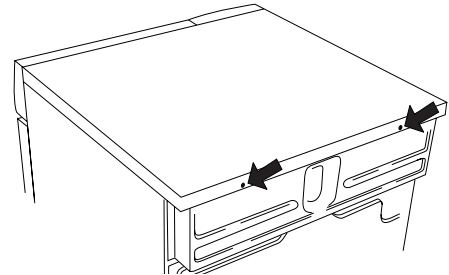

2. Secure the anti-tilt device using the screws as shown in the picture.

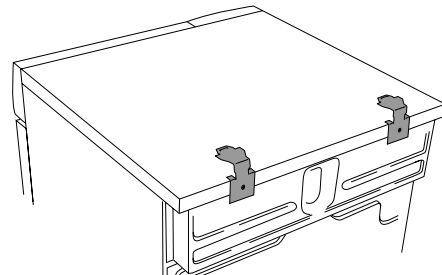

3. Attach the plastic cups that will hold the tumble dryer's front feet to the washing machine's top cover. This is essential, as once the tumble dryer's feet are resting in the plastic cups you know the dryer is correctly positioned on the washing machine.

Break off tag **A** on the cup fitted on the right side and tag **B** on the cup fitted on the left side. Then remove the paper from the self-adhesive surface under the plastic cups.

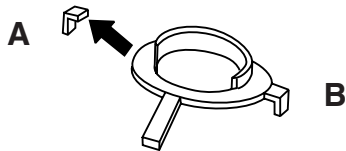

4. Fit the plastic cups so that the “tags” marked with arrows are against the front edge of the cover and side edge and press firmly onto the cover. Then break off the remaining tags.

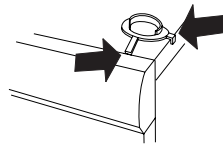

5. Push the tumble dryer in under the metal angles, keeping the front edge raised 1 - 2 cm.

6. Lower the tumble dryer’s front feet into the plastic cups and adjust so that the dryer is balanced.

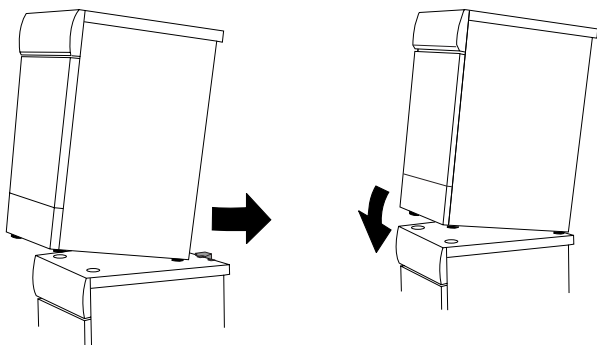

## Adjusting the feet

Screw the feet in or out so that the tumble dryer is steady and balanced on the floor or on the washing machine. Then tighten the locking nuts.

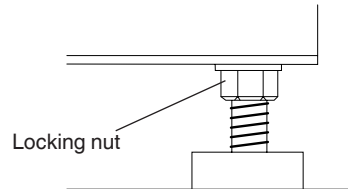

## Condensed water

The machine is supplied as shown in Option 1 (inset). This means that the condensed water is pumped into the condensed water container. This must then be removed and emptied by hand.

Option 2 allows you to remove the small short hose from the blue nipple. Then attach the enclosed rubber hose to the blue nipple. The water can then be pumped out into a laundry sink or a floor drain (2a).

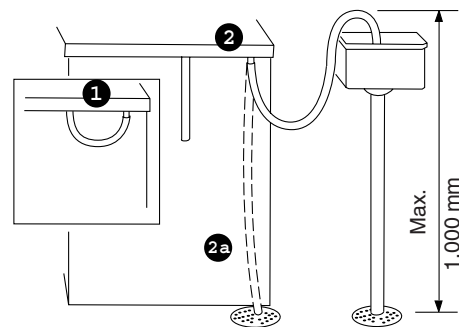



## Electrical installation

The machine must only be connected to an earthed wall socket.

### Connection on delivery

The machine is supplied as single-phase, 230V, heat output 2500W (see type plate) and has a 16A fuse. Any earth fault fuses must be type A.

### Alternative connection

It is possible to switch over **from** 16A (heat output 2500) **to** 10A (heat output 1950W). Switching must be carried out as follows:

1. Shut off the power.
2. Press and hold the Start/Stop button, and switch on the power.
3. Release the Start/Stop button once the programme indicator lights up.
4. Press the Start/Stop button 5 times (within 10 seconds).
5. Adjust the programme selector so that the Extra Dry light comes on (10 o'clock).
6. Press the Start/Stop button to store the setting.

If you want to reset the machine to a 16A connection:

1. Repeat steps 1-4.
2. In step 5, adjust the programme selector so that the Extra Dry light goes out.
3. Press the Start/Stop button to store the setting.

The machine now has a 16A connection.

# Door hanging

The tumble dryer comes with the door hung on the left. However, it is possible to change the door to right hung.

**Proceed as follows:**

**1.** Remove the lower front plate and undo the three screws holding the hinge attachment.

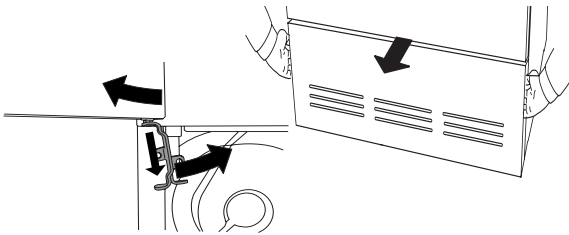

**2.** Angle the lower edge of the door out to the left while turning the hinge attachment as indicated by the arrows.

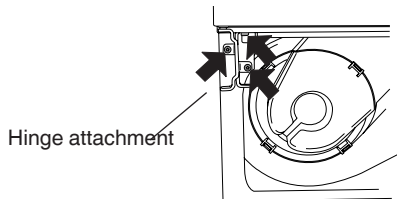

**3.** Move the hinge pin. For right hanging, the hinge attachment must then be turned upside down.

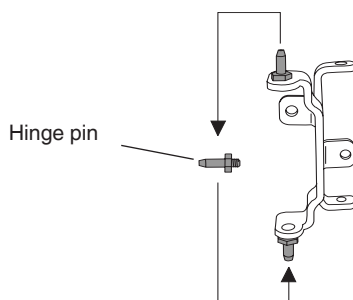

**4.** Then move the hinge pin in the panel's lower edge.

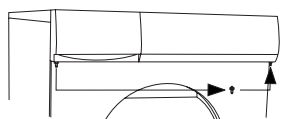

**5.** Next you must move the plastic plugs on the upper and lower edges of the door. Use a flat screwdriver.

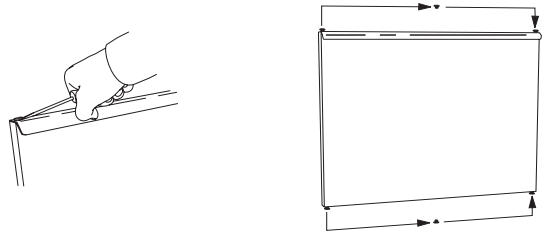

**6.** Unscrew the two screws on the sides of the door, around five millimetres, to allow the door magnet and cover washer on the inside of the door to be removed.

**7.** Then remove the door magnet (1) and cover washer (2).

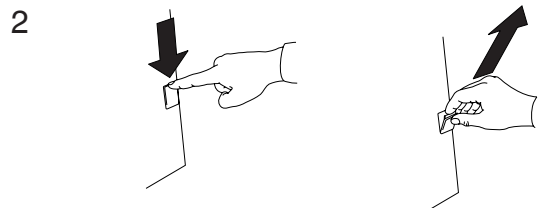
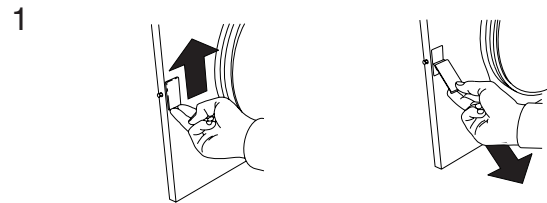

**8.** Insert the door magnet in place of the cover washer.

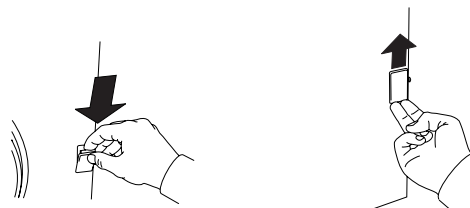

**9.** Insert the cover washer in place of the door magnet.

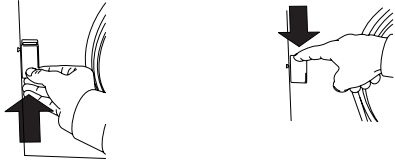

**10.** Insert the screws so that the door magnet and cover washer are held in place.

**11.** Remove the screw indicated. If using a condenser dryer, you must also open the condenser panel.

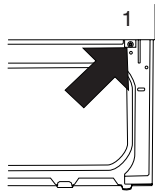

**12.** Then fit the door securely on the right side of the machine.

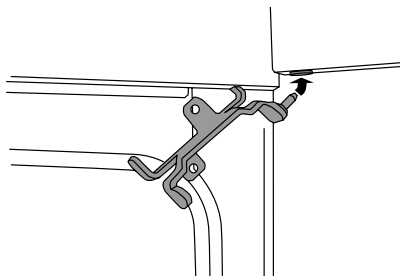
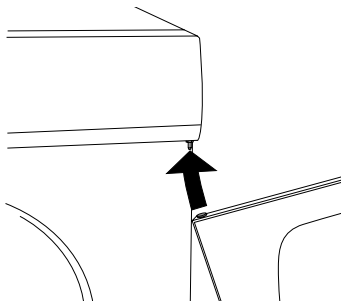

**13.** Secure the hinge attachment using the screws in the sequence shown in the picture.

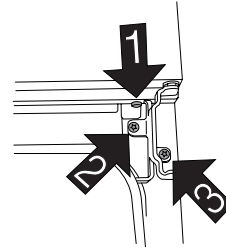

**14.** Replace the screw unfastened in point 11.

**15.** Replace the lower front plate.

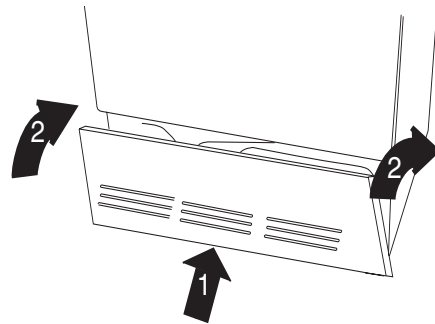

# Search words

## A

Anti-crease 7, 9

## C

Care 10, 13

Child safety 5

Cleaning 10, 13, 14

Condensed water container 4, 6, 10, 11, 13

Condenser 6, 14

Cotton 8

## D

Display 7, 10

Disposal 4

Door hanging 21

Do not tumble-dry 3, 8

## E

Electrical installation 4, 18, 20

Error messages 15

## F

Felting 8

Fluff filter 6, 13

## I

Installation 18, 20

## L

Laundry labels 3, 8

## O

Options 7, 9

Overheating cut-out 4, 10, 15

## P

Packaging 4

Programmes 7, 9

## Q

Quick guide 24

## S

Safety 4

Service 17

Sort 4

Spinning 8

## T

Technical information 16

Temperature 7, 9

Troubleshooting 15

## W

Wool 8

# Quick guide

## 1 Fabrics

- Sort fabrics of the same kind to ensure as uniform drying as possible.



## 2 Press the main power switch

## 3 Load the laundry

- Close the door.

## 4 Select a programme and any options

- Turn the Programme selector to the required programme.

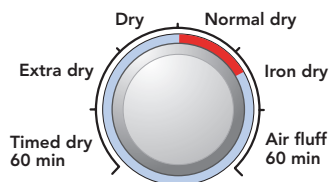

- Select any options and settings.

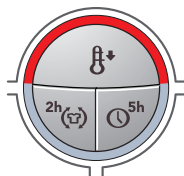

## 5 Press the Start/Stop button

## 6 Drying programme finished

- The text **End** in the display indicates that the programme has finished.
- Clean the fluff filter after each load.
- Empty the condensed water container.

## 7 Once tumble-drying has finished

- Switch off the main power switch, and close the door.

Item No.: 80 799 89. Rev. 01 We reserve the right to make changes.

Printed on environmentally-friendly paper that meets the demands of the Swedish environmental organisations Miljöförbundet and Naturskyddsföreningen.





## Free Manuals Download Website

<http://myh66.com>

<http://usermanuals.us>

<http://www.somanuals.com>

<http://www.4manuals.cc>

<http://www.manual-lib.com>

<http://www.404manual.com>

<http://www.luxmanual.com>

<http://aubethermostatmanual.com>

Golf course search by state

<http://golfingnear.com>

Email search by domain

<http://emailbydomain.com>

Auto manuals search

<http://auto.somanuals.com>

TV manuals search

<http://tv.somanuals.com>