

**Use & Care Guide
Tumble Dryer
MAYTAG
MDE 9701
MDE 9801**



CONTENTS

READ FIRST	Page
1 Before tumble drying for the first time	3
2 Safety instructions	4
General, Installation, Safety, Interrupting a programme, Transport/Winter storage, Packing materials, Disposal	
3 Child safety	5
General, Child lock on Start button	
4 Parts of the tumble dryer	6
5 Panel	7
6 Option buttons	7

INSTALLATION

See Installation Instructions

TUMBLE DRYING

7 Before tumble drying	8-10
Spin-dried? Recommended washing marking, Sorting fabrics, programmes, Options, Temperature, Drying time	
8 Tumble dry	11-14
Tumble dry – step-by-step	
9 Consumption values	15

CARE	Page
10 Care and cleaning	16-18
Cleaning the lint filter, Draining the condensation water container, Cleaning the outside of the machine, Cleaning the fan, Cleaning the condenser	

PROBLEMS?

11 Trouble shooting	20-21
Machine will not start, Overheating protection, Drying takes too long, Fault indication on the display, Normal indications on the display	

MISCELLANEOUS

12 Technical information	23
Technical data, Standard tests	
13 Service and guarantee	25
14 Quick guide	26
15 Index	27

1 BEFORE TUMBLE DRYING THE FIRST TIME

READ THE OPERATING INSTRUCTIONS

Please read through this Use and Care Guide before attempting to use the machine, particularly Chapter 2, Safety instructions, and 3, Children's safety.

DO NOT TUMBLE-DRY

Some fabrics are sensitive to tumble drying. Check the Recommended washing marking on the items concerned, and study Chapter 7, Before tumble drying.

NOTE.

When you start the tumble dryer the first time, or after a long period when it has not been in use, you may hear a light rumbling noise. This is quite normal and the sound will disappear after a few drying operations.

For brief operating instructions; see Chapter 14, Quick guide.

2 SAFETY INSTRUCTIONS



GENERAL

- Study and save this Use and Care Guide for future reference.
- Electrical installation, if required, must be carried out by an authorized electrician.
- The machine may only be used for tumble drying in accordance with this Use and Care Guide.
- Repairs and maintenance which affect safety or performance must be carried out by an authorized specialist.
- Damaged mains cables must only be replaced by an authorised professional.
- Sufficient ventilation is required to prevent smoke from open fires or fumes from equipment burning other fuels being sucked into the room.

INSTALLATION

See the accompanying installation instructions.

SAFETY

This machine may not be used for drying fabrics that have been dry-cleaned at home, or which can be suspected of containing residues of flammable fluids.

The tumble dryer is fitted with an overheating protection device, which switches the machine off in the event of excessive temperature.

A float valve switches the machine off if the condensation water hose becomes clogged, or if there is danger of water flowing over from the container.

INTERRUPTING THE PROGRAMME

You can interrupt a drying programme by opening the door, causing the drum to stop auto-

matically. The machine will then “remember” the point in the drying programme at which it was interrupted. Restarting: close the door and press the  button. The machine will restart automatically from the point at which the programme was interrupted.

You can also interrupt a programme by pressing the  button for three seconds. If you interrupt a programme with this button, the machine will forget where it was in the programme, and you will have to select a new programme to restart.

TRANSPORT/WINTER STORAGE

If the machine is to be transported or stored during the winter, on unheated premises, ensure that the water container is drained.

PACKING MATERIAL

Sort the packing material for recycling according to recommendations by the local authorities.

DISPOSAL

When the machine is no longer useful and is to be scrapped it should be made unusable.

Get in touch with the refuse collection service or your local authorities for advice on how to scrap the machine in a proper manner.

The machine is made and marked to facilitate recycling.

CAUTION!



During the programme, the back of the tumble dryer will get very hot. Leave the machine to cool completely before touching the back.

3 CHILDREN'S SAFETY



GENERAL

Do not allow children to play with the tumble dryer.

The tumble dryer is fitted with a magnetic catch, which allows the door to be opened from the inside. The door is equipped with a switch, which automatically stops the tumble dryer when the door is opened. The machine will not start automatically on closing the door (eg, if a child should close the door from the inside).



CHILD LOCK ON BUTTON



You can prevent a child from starting the tumble dryer by mistake. You can do this by locking the  button, as follows.

Child lock On/Off:

Set the programme selector knob to the position in which it points directly upwards.

Turn off the main power switch  and then turn it on again so that the machine is in stand-by mode.

Press the  button five times, and then press the  button five times. These ten presses must be completed within 15 seconds.

Within three seconds after pressing the  button for the last time, you must then use the  button to select Child lock On (the figure 3 appears in the display) or Off (the figure 0 appears in the display).

Start a programme with the button locked:

To start the machine, you must hold the  button down for three seconds.

4 PARTS OF THE TUMBLE DRYER

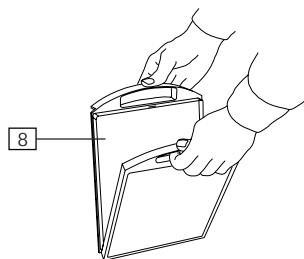
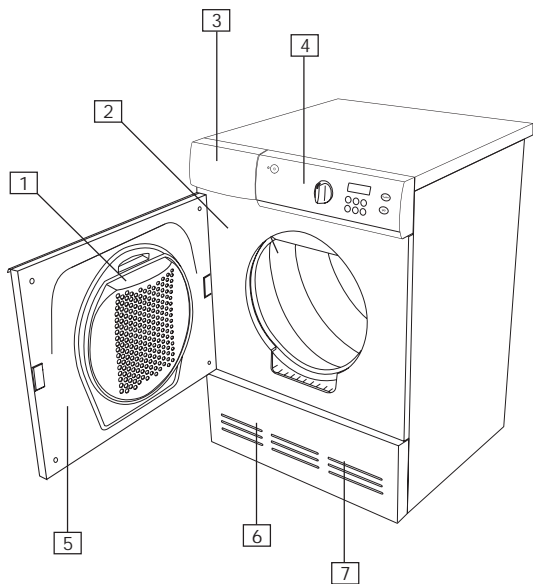

1. FLUFF-FILTER HOLDER

2. DATA PLATE

3. CONDENSATION WATER CONTAINER

4. PANEL

5. OUTER DOOR

6. FAN (BEHIND THE LOWER COVER)

7. CONDENSER (BEHIND THE LOWER COVER)

8. LINT FILTER

5 PANEL

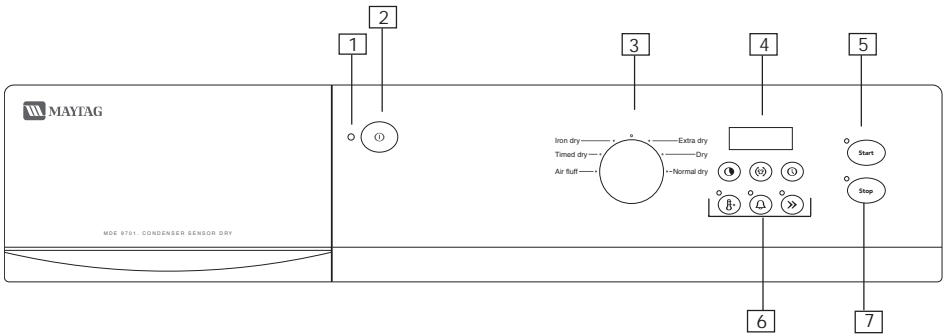

1. INDICATOR LAMP ON/OFF

2. MAIN POWER SWITCH

3. PROGRAMME SELECTOR KNOB
THE PROGRAMMES ARE DESCRIBED IN CHAPTER 7, BEFORE TUMBLE DRYING.

4. DISPLAY

5. START BUTTON WITH LED TO INDICATE STARTED PROGRAMME

6. SETTING AND OPTION BUTTONS

7. STOP BUTTON WITH LED TO INDICATE THAT THE PROGRAM IS COMPLETED

6 OPTION BUTTONS

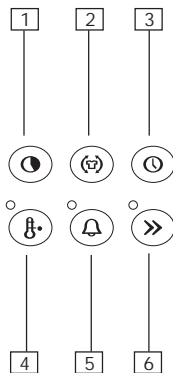

1. TIME ADJUSTMENT BUTTON FOR TIMED DRY AND AIR FLUFF PROGRAMME

2. ANTI-CREASE PROGRAMME BUTTON

3. DELAYED START BUTTON

4. LOW TEMPERATURE BUTTON

5. BUZZER BUTTON

6. QUICK COOLING BUTTON

The LEDs indicate that the associated choice has been activated.

7 BEFORE TUMBLE DRYING

Before you start tumble drying, here is some advice that can be useful.

SPIN-DRIED?

Items that are to be tumble dried should first be spin-dried, preferably at 800 revs per minute or more. Better spin drying saves both energy and drying time.

RECOMMENDED WASHING MARKING



Material suitable for tumble drying

The symbol above indicates that the material can be tumble-dried. Cotton fabrics, towelling and synthetic fibres are best suited to tumble drying. Clothes and fabrics become softer and fluffier when tumble-dried than when dried on a line.

NOTE

Wear and tear of fabrics in a tumble dryer is minimal. The lint caught in the lint filter consists of dust and fibre residue that has been formed when wearing the garments.



Material which should not be tumble-dried

This symbol indicates that the material will not withstand tumble-drying.

Certain materials will melt or become dangerously flammable if heated, while others will lose their shape or shrink.

Do not tumble-dry...

- Materials that are marked "Do not dry close to heat".
- Items that have been dry-cleaned at home.
- Foam plastic.
- Glass-fibre materials
- Woollen items, because of the risk of felting.

SORTING FABRICS

Best results are obtained if all articles are of the same material.

Close zip-fasteners, button up garments, tie belts, and sort the fabrics and adapt the load and the temperature as shown in the table below.

TYPE OF FABRIC		LOAD	TEMPERATURE
White, coloured and synthetic	Cotton and linen	1/1 (6.0 kg)	Normal
	Polyester/cotton	1/2 (3.0 kg)	Normal
Delicate and mild	Acrylic, rayon, acetate etc.	1/2 (3.0 kg)	Low

Sort a suitable amount and type of fabric.

PROGRAMMES

Your choice of programme will depend on what you wish to do with the fabrics after tumble drying. The available programmes are Extra dry, Dry, Normal dry, Iron dry, Timed dry programme and Air fluff.

Extra dry

This programme is designed for washing that is extremely difficult to dry, eg, jeans with very thick seams.

NOTE

Knitted fabrics in particular are liable to shrink. Use the Dry, Normal dry or Iron dry programme for these materials. Always stretch garments out directly after drying.

Dry, Normal dry

These programmes turn off the heat when the washing is dry, but not bone-dry.

The Dry programme turns off the heat a little later than Normal dry. Choose what you prefer by trial and error. Use these programmes when you want dry fabrics.

Iron dry

This programme turns off the heat when the washing is just damp enough for ironing or mangling.

Timed dry

The programme length that you should choose depends on what you wish to do with the fabrics after tumble drying. Dry different times for different materials to find the right combination.

When using a timed dry programme with mixed washing it may happen that some of the items will not be sufficiently dried. Such items can suitably be dried by running the timed programme for a further 10 minutes or so.

Timed dry programmes automatically operate at temperature Low, but you can change it yourself to Normal.

NOTE

When using a timed programme it is possible to over-dry fabrics if you set too long a time. This can cause fabrics to shrink or crease and feel rough. Synthetic materials can also become charged with static electricity. Set a shorter time if you tumble dry at temperature Normal.

Air fluff

Use the air fluff programme just to shake dust out of garments, air them or soften them up.

To select Timed dry programme or Air fluff programme, see Chapter 10, Making own drying programmes.

OPTIONS

To choose these options, see Chapter 10, Making own drying programmes.

Cooling

You can choose between Normal cooling and Quick cooling (⏏). Normal cooling lasts 20 minutes and Quick cooling lasts 5 minutes.





Buzzer

The machine offers you the possibility of hearing when the cooling period ends. Set the option Buzzer on  and it will sound for three seconds when the programme is completed.

Anti-crease

You can select the anti-crease option  to prevent the fabrics from lying still and becoming creased at the end of tumble drying. This is a helpful option if you are unable to take out the fabrics promptly at the end of the tumbling phase.

You can choose a programme duration of 1, 2 or 3 hours. The drum will then continue to rotate intermittently, i.e., three seconds every minute for the number of hours chosen.

If you choose Buzzer ON, a signal will sound each time the drum rotates.

TEMPERATURE

You can select Low temperature  for the Extra dry, Dry, Normal dry and Iron dry programmes.

DRYING TIME

The drying time may be influenced by a number of factors, such as the size of the load, the program selected, the moisture content of the load, the materials being washed, connection capacity and the ambient temperature and humidity. Drying time remaining is calculated within four minutes of the start of the drying program. The estimated time is shown in the bottom right-hand corner of the display, together with the – symbol.

If the actual drying time is less than that calculated, the time display may jump ahead, e.g. from 50 to 20 minutes, at the end of the program.

If the actual drying time is longer than that calculated, the countdown will stop at the end of the program until the load is dry.

Please note that times include a cooling period.

The remaining drying time is estimated approximately (within four minutes of the start of the drying programme) and is shown on the display in intervals of five minutes.

8 TUMBLE DRY

The following step-by-step instructions are provided to help you to achieve the best possible drying result.

1 SORT FABRICS

For tips and advice, see Chapter 7 – Before tumble drying.

NOTE

Empty the pockets. Coins, nails and similar items can cause damage to the machine and textiles.

2 TURN ON THE MAIN POWER SWITCH

3 OPEN THE DOOR, PUT IN THE WASHING AND CLOSE THE DOOR

Close the door carefully, and do not slam it. See Chapter 7 for the recommended quantity of washing – Before tumble drying.

SELECT A PROGRAMME

4

Select the programme that you wish to use with the programme selector knob. Your choice of programme will depend on what you wish to do with the fabrics after tumble drying. See also Chapter 7 – Before tumble drying.

The choice of programmes is:

Extra dry, Dry, Normal dry, Iron dry, Timed dry and Air fluff.

5 SET THE TIME FOR AIR FLUFF AND TIMED DRY PROGRAMMES

For the Air fluff programme and the Timed dry programme, you can set the duration by indexing forwards with the  button. The selected time is shown in the display.

You can select times between 5 and 90 minutes.

Try different drying times for yourself. Then note the times that you find best for different fabrics.

NOTE

When using the Timed dry programme, the garments may become “over-dry” if the set drying time is too long. This can cause the fabrics to shrink or crease and take on a rough feel. Synthetic materials can also become charged with static electricity. Try to find the suitable drying time by selecting a shorter time on the first few occasions.

6 SELECT AN OPTION

By selecting an option, you can obtain a drying programme that is ideal for your garments,

The machine will remember the settings and options that you make for each programme and will start with these (with one exception – Delayed start) the next time you select the programme concerned. Of course, you can then make a further change if you wish.



Anti-crease

Select anti-crease by indexing forwards with the  button. You can select an active period of between 1 and 3 hours for this option.

 indicates that the option is disconnected.

You can select a duration of 1-3 hours for the active option.

This option means that the drum will rotate for three seconds per minute after the drying programme is complete. The programme prevents the fabrics from lying in the same position and becoming creased.

This is helpful if you are unable to take out the fabrics promptly at the end of the tumbling phase.

If you have selected the Buzzer option, a buzzer will be heard every time the drum rotates during this programme. This is to remind you that the drying programme has ended.

Delayed start

Set the number of hours by which the start will be delayed by indexing forwards with the  button. The selected time is shown in the display as you index forwards. A delay of 5 hours thus means that the machine will start the programme 5 hours after pressing the start button.

You can select a delay of between 1 and 24 hours.

 indicates that the option is disconnected and the programme will start directly as usual.

Low temperature

You can switch the Low temperature option on or off by pressing the  button.

The LED next to the button will light when Low temperature is switched on.

Low temperature is not available with the Air fluff programme.

Buzzer

You can switch the Buzzer option on or off by pressing the  button.

The LED next to the button will light when the Buzzer option is switched on.

This option means that the buzzer will sound for three seconds when the drying programme has ended.

Quick cooling

You can switch the Quick cooling option on or off by pressing the  button.

The LED next to the button will light when Quick cooling is switched on.

Cooling normally continues for 20 minutes. Quick cooling reduces the cooling period to 5 minutes.

Quick cooling is not available with the Air fluff programme.

7 START THE DRYING PROGRAMME WITH THE BUTTON

The LED next to the button will light to indicate that the programme has started.

NOTE

If the child lock is on, the button must be held down for 3 seconds.

Remaining drying time

The remaining drying time is shown in the display while the programme is operating. (indica-

ted in steps of 5 minutes, within four minutes after the start of the start of the drying programme). **2h35** indicates 2 hours and 35 minutes, for example. Only the time for the Time programme and Air fluff drying is indicated for venting dryers.

During cooling, **⏸** is indicated in the display together with the number of minutes remaining.

If the Anti-crease option is selected, the drum will rotate every minute for a certain period after cooling. The text **RC** is indicated in the display during this period. The programme will stop as soon as the door is opened.

DURING THE DRYING PROGRAMME

If you wish to interrupt or change the programme

Hold down the **Stop** button for three seconds. An extinguished LED next to the button indicates that the programme has been interrupted.

Changing the programme selector knob after starting will not affect the programme.

Putting in or taking out washing

If you wish to put in or take out washing after you have started the machine, opening the door will cause the machine to stop automatically. Put in more washing, close the door and press the **Start** button. The programme will restart automatically from the point at which it was interrupted.

8 DRYING PROGRAMME ENDED

The text **End** in the display indicates that the programme has ended.

If the Anti-crease option is selected, the drum will rotate every minute for a certain period after cooling. The text **RC** is indicated in the display during this period. The programme will stop as soon as the door is opened.

- Clean the lint filter after each tumble drying operation.
- Drain the condensation water container.

WARNING



If the lint filter becomes completely clogged, this may cause the overheating protection to trip. The filter must then be cleaned and the overheating protection must be reset before restarting the machine; see Chapter 11, Trouble shooting.

Cleaning the lint filter

1. Grasp the filter handle and pull it towards you.
2. Pull the filter up out of the holder.
3. Open the filter and brush away any lint with your hand.
4. Fold the filter together and replace it in the filter holder.

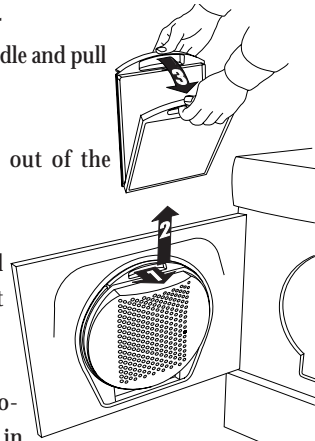

▶

The filter may require cleaning if lime scale deposits are present; see Chapter 10, Care and Cleaning.

Draining the condensation water container

The condensation water container must be emptied after each tumble drying.

Pull out the condensation water container, drain any water and replace the container.

If the condensation water container becomes too full, the programme will be interrupted and **F !** will appear in the display. Drain the container and press the **Start** button, and the programme will now continue from where it was interrupted; see also Chapter 11, Trouble shooting, heading Fault indications.

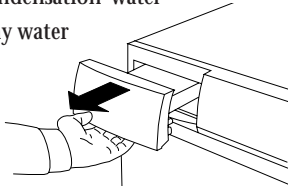

9 AFTER TUMBLE DRYING

Turn off the main switch **⓪**.

Take out the clothes, and close the door to prevent small children from crawling into the machine.

NOTE

Do not pull out the condensation water container while the tumble dryer is running.

TIP

The condensation water is soft, which makes it suitable for use in a steam iron. Strain the water through a coffee filter before use.

Automatic emptying

See the Installation instructions if you prefer the water to be emptied automatically.

9 CONSUMPTION VALUES

The following conditions apply for the consumption values indicated below:

Temperature of intake air: 20 °C.

Humidity of intake air: 65 %.

Drying temperature: Normal (g*), Low (g-).

Element power: 2500 W.

The cotton fabrics are, before tumble drying, spin-dried at 800 and 1600 rpm (long spin) with MAYTAG washing machine.

Other fabrics (creasfree and acrylics) are, before tumble drying, spin-dried at 800 rpm (short spin) with MAYTAG washing machine.

PROGRAMME	WASHING	AMOUNT OF WASHING	ENERGY CONSUMPTION		PROGRAMME TIME	
			(ca kWh)		(ca minutes)	
			800 rpm	1600 rpm	800 rpm	1600 rpm
P1 Extra dry	Cotton, linen, g*	1/1 (6.0 kg)	4.5	3.7	115	95
P2 Dry	Cotton, linen, g*	1/1 (6.0 kg)	4.0	3.2	100	80
	Crease free, polyester/cotton, g*	1/2 (3.0kg)	1.8	---	45	---
P3 Normal dry	Cotton, linen, g*	1/1 (6.0 kg)	3.8	2.9	90	70
	Crease free, polyester/cotton, g*	1/2 (3.0kg)	1.6	---	45	--
	Acrylics, rayon, acetate, g-	1/2 (3.0 kg)	2.1	---	75	---
P4 Iron dry	Cotton, linen, g*	1/1 (6.0 kg)	3.0	2.0	80	50

10 CARE AND CLEANING

CLEANING THE LINT FILTER

Clean the lint filter after each tumble drying operation.

If your water is very hard a deposit of lime may be formed on the filter. Check when cleaning lint from the filter if there is any sign of lime, if so wash the lint filter by hand to remove any deposits.

1. Grasp the filter handle and pull towards you.

2. Pull the filter up out of the holder.

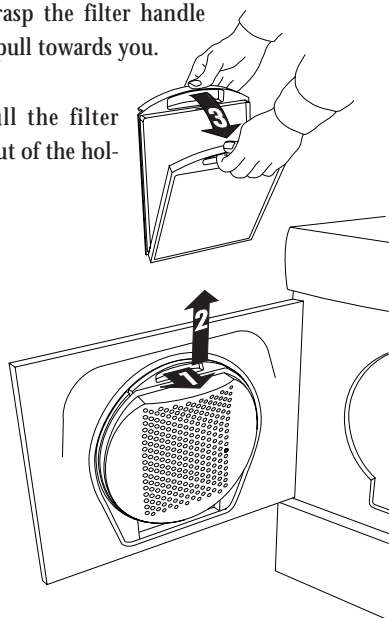

3. Open the filter and remove fluff from all sides of the filter by hand. Use a soft dry cloth to remove any remaining fluff.

4. Replace the filter in the filter holder.

If limescale develops on the filter, rinse it in water to remove the limescale.

Dry the filter thoroughly with a hand towel.

EMPTYING THE CONDENSATION WATER CONTAINER

Empty the condensation water container after each tumble drying.

Pull out the condensation water container, empty the water and put the container back.

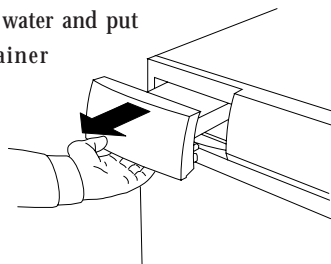

If the condensation water container becomes too full, the programme will be interrupted and **F i** will appear in the display. Empty the container and press the **Start** button and the programme will continue from where it was interrupted, see also Chapter 11, Trouble shooting.

NOTE

Do not pull out the condensation water container while the machine is running.

CLEANING THE OUTSIDE OF THE MACHINE

Use a mild detergent to clean the outside of the machine. Do not use any solvents, they can damage the machine. Do not spray the machine with water.

NOTE

Do not allow dust to accumulate round the machine. Keep clean and cool around the tumble dryer. Dust, heat and moisture prolong the drying time.

CLEANING THE FAN

The fan should be cleaned at least once a year. If you have any household pets the fan must be cleaned more often.

1. Turn off the main power switch.
2. Remove the lower cover.

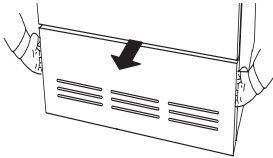

3. Remove the safety screw (1). Prise out the four clips in the order shown and remove the fan cover.

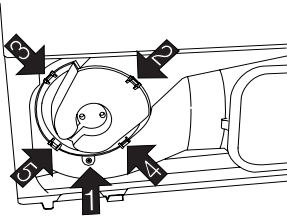

4. Unscrew the nut while holding the fan.

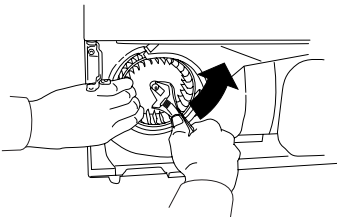

5. Take out the fan and clean it with a brush and water.

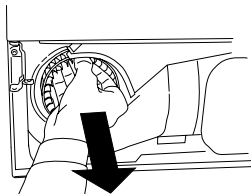

6. Put the fan back into place and screw on the nut.

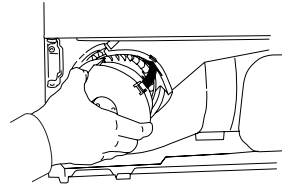

8. Fit the lower cover back in place.

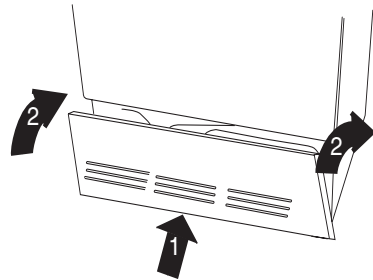

CLEANING THE CONDENSER

The condenser should be cleaned at least three times a year. . If you have any household pets the condenser must be cleaned more often.

1. Turn off the main power switch.
2. Remove the lower cover.

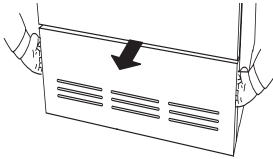

3. Turn the two levers anticlockwise to open the condenser cover.

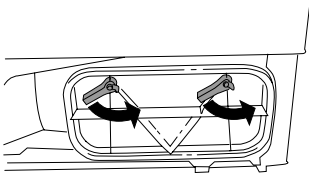

4. Take the condenser out and rinse the condenser fins clean, eg, using a hand-held shower. Do not poke anything between the fins, you might damage the condenser. Do not use any sharp object when cleaning the fins.

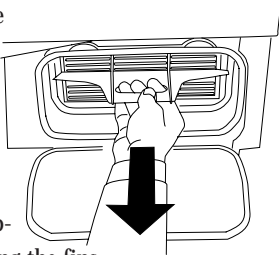

5. Refit the condenser, taking care to fit it the right way up.

The top of the condenser is marked "upp", "up" and "oben".

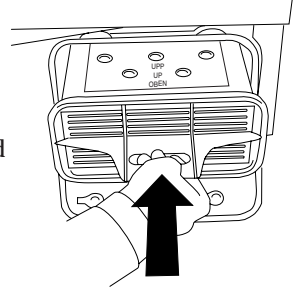

6. Fit the lower cover back in place.

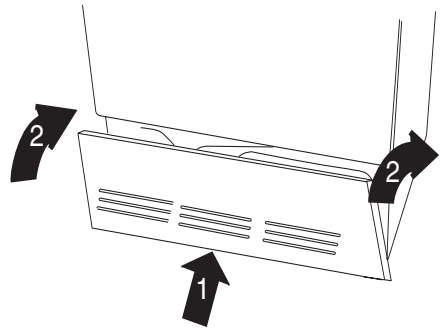

NOTE

Do not attempt to clean the condenser in a dishwasher.

This page has been left blank for technical printing reasons.

11 TROUBLE SHOOTING

THE MACHINE WILL NOT START

Check that:

- The door is properly closed.
- The main switch is pressed in.
- You have correctly set the required programme or the required time in the timed dry programme.
- the Delayed start option is not switched on.

In this case, the time remaining to start in whole hours will be indicated in the display (e.g. 24h). To interrupt the programme, see Chapter 8 – Tumble dry.

- The electric plug, if any, is firmly inserted in its socket.
- All fuses are intact. Switch two fuses over. It is not always possible to see directly if a fuse has blown.
- The overheating device has not triggered, see below.

OVERHEATING PROTECTION

The dryer is designed with an overheat protection switch that will automatically turn the machine off if the temperature gets too high. The machine will not start until it has cooled down sufficiently.

If the unit shuts down because of overheating, check that the lint filter exhaust hose, vent duct, and the condenser unit are free of lint. These components need to be cleaned on a regular basis. Additionally, the lint filter may need to be cleaned with warm, soapy water and a soft brush a few times a year to ensure the filter screen is not blocked. Using dryer sheets (not recommended) can also cause this problem.

Should the machine turn itself off because of overheating, it will not be possible to restart the unit until it has cooled down sufficiently. This could possibly take up to thirty minutes. To restart the unit once it has cooled down, press the "Start" button.

NOTE:

If your dryer overheats frequently, it may not be vented properly or the room in which it is located may not have sufficient air circulation. Contact your installer to have these issues checked out.

EXCESSIVE DRYING TIME

Empty the water container and check that the lint filter and the condenser are not clogged, see Chapter 10, Care and Cleaning. Excessive drying times can also be caused by the machine being installed in a very confined space and by the air in the room (which cools the machine) becoming too warm. In this situation make sure that ventilation is improved, eg, by opening doors and/or windows.

If this does not help, check the fuses.

FAULT INDICATIONS ON THE DISPLAY

If a fault or a failure occurs during the programme, an indication will be given on the display.

The table below shows the various fault codes.

NOTE

The main power switch  must be turned off in order to reset the fault message.

Display shows	Explanation	Proposed measure
F1	Overflow This means that the condensation water container is full. If the condensation water is pumped out directly via the drain hose, check that the hose is free from kinks or blockages. If this does not help, call service.	Empty the condensation water container and restart. If the fault message appears again, this may mean that the lower water reservoir is full because the pump or the hoses are blocked or worn.
F2	Maximum programme time	The machine stops after it has operated for the maximum period (3 hours). Check and replace any blown fuses in the electrical distribution box for the building. To exit from the fault message, switch off the machine or open the door. If this does not help, call service.
F3	Thermistor fault	Call service.
F4	Thermal protection (Not fitted to all machines.)	Clean the filter and the condenser.
F5	Sensor fault	Fault in the moisture sensor. This fault message can also be displayed if you are already operating with dry clothes or an empty machine. The message should disappear if you open the door. If not, call service.

NORMAL INDICATIONS ON THE DISPLAY

Display shows	Explanation	
00	No programme selected.	
24h	One or two digits, followed by an h. Delayed start is selected, and the programme has started. The display shows the number of hours remaining until the programme starts.	
2h35 18	One digit and one H followed by two digits, or 1-2 digits on their own, indicate that a programme is running. The display indicates in steps of 5 minutes the length of the programme time remaining in hours and minutes.	
End	Programme complete. Take out the washing.	
E	Programme in the cooling sequence. Wait until the programme ends.	
AC	When the Anti-crease option is activated, the drum will rotate every minute. This text appears in the display during this period. You can interrupt the at any time by opening the door.	

This page has been left blank for technical printing reasons.

12 TECHNICAL INFORMATION

TECHNICAL DATA

Height:	850 mm
Width:	595 mm
Depth:	585 mm
Weight:	47 kg
Drum volume:	111 litre
Max. drying capacity:	6.0 kg
Speed:	52 r/min
Rated power:	See data plate
Material: Cylinder and water container	Stainless steel
Material: Outer cover	Hot-galvanized, powder-lacquered steel or stainless steel
Positioning:	Washing tower or free-standing
Drain	2.0 polypropylene hose

STANDARD TESTS

Europe:	EN 61 121 (95/ 13/ EEC).
Drying performance:	Programme 3, (Normal dry), 6.0 kg, cotton, temperature Normal.
Energy declaration:	EN 61 121 (95/ 13/ EEC). Programme 3, (Normal dry), 6.0 kg, cotton, temperature Normal.
Procedure for acoustic measurement:	IEC 704-2-6.

This page has been left blank for technical printing reasons.

13 SERVICE AND GUARANTEE

SERVICE

Before calling for service, check to see whether the faults is due to something that you can put right yourself. See chapter 11, Trouble shooting.

If you do require service, telephone your local MAYTAG retailer or the MAYTAG representative for your country. See guarantee card for address and telephone number.

GUARANTEE

For guarantee details, see the guarantee card.

BEFORE CONTACTING THE SERVICE DEPARTMENT

Before contacting the Service Department, make a note of the model designation, type designation and serial number.

The model designation is on the panel. The type designation and the serial number are on the type plate located inside the door.

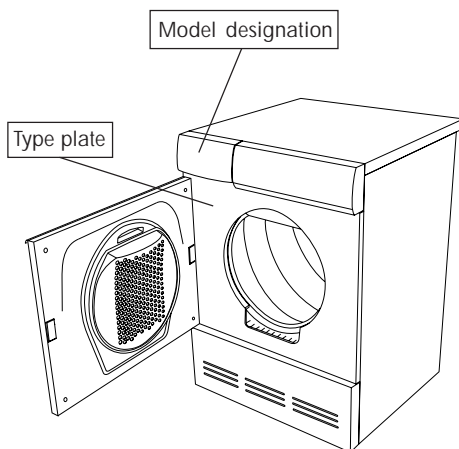
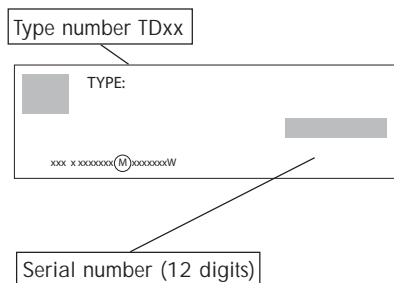

14 QUICK GUIDE

1. Sort the fabrics.

2. Turn on the main switch .

3. Open the door, load the fabrics and close the door again.

Close the door carefully; it must not be slammed.

4. Select a programme with the knob.

The available programmes are:

- 1. Extra dry, 2. Dry, 3. Normal dry, 4. Iron dry,
- 5. Timed dry and 6. Air fluff.

If you select a Timed dry programme or an Air fluff programme, you can adjust the time with .

5. Select any options.

6. Start the programme by pressing the  **button.**

You can interrupt the programme by opening the door.

7. Drying programme completed.

The text **End** in the display indicates that the programme has ended.

Clean the lint filter and drain the condensation water container after each tumble drying operation.

8. When tumble drying is completed.

Turn off the main power switch  and close the door.

WASHING →	Washing Options		
	Cotton, linen etc.	Polyester / cotton	Acrylics, rayon, acetates, (temperature sensitive materials)
Load (kg)	6.0	3.0	3.0
SET THE: Programme	1 to 4 Extra dry, Dry Normal dry, Iron dry	2 or 3 Dry or Normal dry	2 or 3 Dry or Normal dry
Temperature	Normal	Normal	Low ()

15 INDEX

	Chapter		Chapter	Chapter	
A		F		P	
Acetate	7, 14	Fabric marking	7	Packing materials	2
Acrylate	7, 8, 14	Fabric wear	7	Panel	5
After tumble drying	8, 14	Fault indications	11	Parts of the tumble dryer	4
Air fluff programme	7, 8, 14	Felting	7	Polyester	7, 14
		Flammable materials	2, 7	Pre-set drying programmes	8
B		Foamed plastic	7	Programmes	7, 8, 14
Before tumble drying for the first time	1	G		Quick guide	14
Before tumble drying	7	Glass-fibre materials	7	R	
Buzzer	7, 8	Guarantee	13	Rayon	7, 14
		I		Remaining drying time	7
C		Installation; see Installation instructions		Restarting	8
Care	10	Interrupting the programme	2	Rough feel	7
Change programme after starting	8	Iron dry	7, 8, 14	S	
Child safety start	3	Ironing	7	Safety	2
Child safety	3	J		Service	13
Cleaning	10	Jeans	7	Sort fabrics	7
Coloured wash	7	K		Spin-dried	7
Condensation water container	8, 10, 11	Knitted fabrics	7	Start	8, 14
Condenser	10, 11	L		Synthetic materials	7
Cooling	7, 8	Language	11	T	
Cotton	7, 14	LC display	8	Technical data	12
Crease-free	7, 8	Linen	7, 14	Temperature	7, 8
		Lint filter	8, 10	Timed dry programme	7, 8, 14
D		Low temperature	7, 8	Tumble dry	8, 14
Delayed start	8	M		Wool	7
Delicate washing	7	Mangling	7	Z	
Display indications	11	N		Zip fasteners	7
Display; see LC display		Normal dry	7, 8, 14		
Disposal	2	Option buttons	6		
Do not tumble dry	7	Options	7, 8		
Dry cleaning	2, 7	Overheating protection	2, 11		
Dry	7, 8, 14				
Drying time	7				
E					
Emergency stop; see Interrupting the programme					
Energy consumption	9				
Extra dry	7, 8, 14				



Free Manuals Download Website

<http://myh66.com>

<http://usermanuals.us>

<http://www.somanuals.com>

<http://www.4manuals.cc>

<http://www.manual-lib.com>

<http://www.404manual.com>

<http://www.luxmanual.com>

<http://aubethermostatmanual.com>

Golf course search by state

<http://golfingnear.com>

Email search by domain

<http://emailbydomain.com>

Auto manuals search

<http://auto.somanuals.com>

TV manuals search

<http://tv.somanuals.com>