

# Marshall Electronics

**V-R171-IMD-HDSDI**

High Definition LCD Monitor with In-Monitor Display

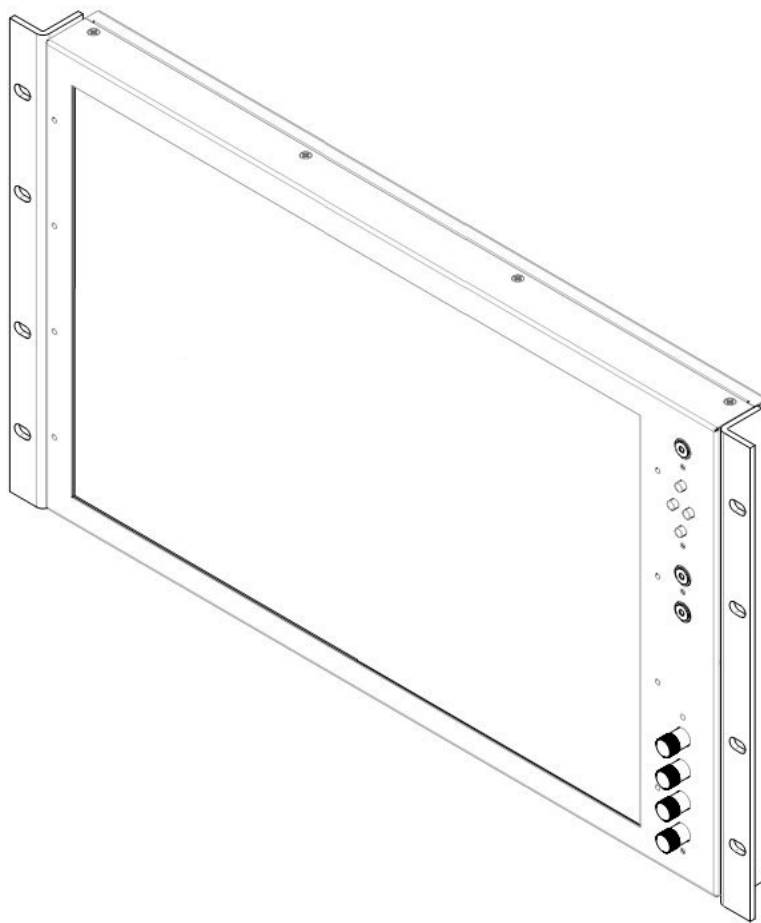

## Operating Instructions



# Contents

<b>Product Overview</b> .....	4
<b>Features</b> .....	4
<b>Installation and Initial Setup</b> .....	5
Unpacking.....	5
Installation.....	5
Connections and Power-On, and Initial Setup.....	5
<b>Top and Front Panel Features</b> .....	6
Power Button.....	6
Menu Navigation Buttons.....	6
User-Definable Function Buttons.....	6
RotoMenu™ Knob.....	6
Image Adjustment Knobs.....	6
LED Tally.....	6
<b>Rear Panel Features</b> .....	7
HD-SDI Input and Output.....	7
Power Input.....	7
Tally Interface (HD-15).....	7
RS-422/485 Serial Interface.....	7
<b>Compatible Input Formats</b> .....	8
<b>On-Screen Menu</b> .....	8
STRUCTURE OVERVIEW.....	8
MAIN MENU AND NAVIGATION.....	9
MARKER SETUP SUBMENU.....	10
16:9 Markers.....	10
4:3 Markers.....	11
Marker Background.....	11
Center Marker.....	11
VIDEO CONFIGURATION SUBMENU.....	12
Ctemp/Gamma.....	12
Monochrome Mode.....	12
Blue-Only Mode.....	12
Pixel-to-Pixel Mode.....	13
Aspect Ratio Settings.....	13
Curtain Color.....	14
SYSTEM CONFIGURATION SUBMENU.....	15
Gray Levels.....	15
User-Definable Function Buttons.....	15
Saving and Loading User Presets.....	15
Software Version Display.....	15
OSD CONFIGURATION SUBMENU.....	16
IMD State.....	16
Status Display.....	16
OSD Tally.....	17
LED Tally.....	18
Anc. Time Code.....	18
Audio Monitor.....	18
IMD CONFIGURATION SUBMENU.....	19
Overview.....	19
IMD Protocol.....	19
IMD ID#.....	20
IMD Group #.....	20
IMD Name(S/N).....	20
IMD Baud Rate.....	20
IMD Fixed Align.....	20
IMD Fixed Color.....	20
IMD Fixed String.....	20
Tally Source.....	21
IMD Tally Mode.....	21
SERVICE SUBMENU.....	21
Overview.....	21
<b>Specifications</b> .....	22
<b>Maintenance</b> .....	24
<b>Warranty</b> .....	24

# Product Overview

---

The V-R171-IMD-HDSDI is a full resolution 17" LCD monitor with an HD-SDI input and In-Monitor Display functionality – a cost-effective "all-in-one" solution for post-production houses, broadcasters, and mobile units. This fully integrated approach eliminates the need for additional or separate Under Monitor Displays and allows UMD information and tallies to be displayed directly within a Marshall flat panel monitor, while saving precious rack space. A variety of features are readily available including on-screen Video Time Code, three-color "Soft" Tallies, Audio Presence Indicator, and a new RotoMenu™ feature that allows fast, direct, and easy menu navigation.

The V-R171-IMD-HDSDI integrates easily with existing Tally systems and controllers, including Image Video, TSL, and MEI protocols. This 7RU unit also ships ready to rack mount and provides up to 20% more screen when compared to our competitors' LCD and CRT models that occupy the same space. This is in addition to the benefits of low weight and power consumption when compared to similar CRT products and separate Under Monitor Display configurations. The V-R171-IMD-HDSDI is a perfect solution for video wall applications and systems.

The V-R171-IMD-HDSDI offers a single HDSDI/SDI input with active loop-through capability. Additional features include ultra-wide viewing angles, adjustment settings memory, frame markers, Pixel-to-Pixel mode, Blue Only mode, and user-definable function buttons. The V-R171-IMD-HDSDI can also be used as a standalone display with HD-SDI loop-through.

## Features

---

### ■ 1920 x 1200 Full Resolution 17" Panel

The V-R171-IMD-HDSDI features an all-digital TFT-MegaPixel™ active matrix LCD systems with 1920x1200 native resolution. The LCD panel features a brightness of 400 cd/m<sup>2</sup> and a 600:1 contrast ratio making it ideal in a variety of environments and lighting conditions.

### ■ In-Monitor Display

In-Monitor Display allows on-screen text and tally indication, controlled locally or remotely via a variety of industry standard protocols.

### ■ OSD Features

Embedded time code and an embedded audio presence indicator can be displayed on the screen in a variety of configurations.

### ■ Advanced Features

Aspect ratio settings, blue-only mode, and monochrome mode are a few of the advanced features allowing the V-R171-IMD-HDSDI to be at home in any broadcast environment. Pixel-to-Pixel mode also allows native display of any incoming image format.

### ■ Flexible Screen Markers

A variety of screen markers in both 4:3 and 16:9 modes allow accurate monitoring of the different aspect ratios used in broadcast environments.

### ■ User-Definable Function Buttons

Two user-definable function buttons allow quick access to numerous settings and features including aspect ratio, screen markers, monochrome mode, color temperature, and more.

# Installation and Initial Setup

---

## ■ Unpacking

Carefully unpack the V-R171-IMD-HDSI monitor and verify that the following items are included:

- V-R171-IMD-HDSI Monitor
- V-PS12-5V-1 Power Supply with 2-Pin Twist Lock Connector
- Operating Instructions

Inspect the unit for any physical damage that may have occurred during shipping. Should there be any damage, immediately contact Marshall Electronics at (800) 800-6608. If you are not located within the continental United States, call +1 (310) 333-0606.

## ■ Installation

The V-R171-IMD-HDSI can be mounted in any standard EIA 19" equipment rack. The attached rack ears can be angled to provide the user control over the viewing angle. Adequate ventilation is required when installed to prevent possible damage to the monitor's internal components.

A VESA standard 75mm hole pattern also allows custom mounting installations. Alternately, the V-R171-IMD-HDSI can be used in a desktop configuration with optional stand (Marshall part number **V-ST15**).

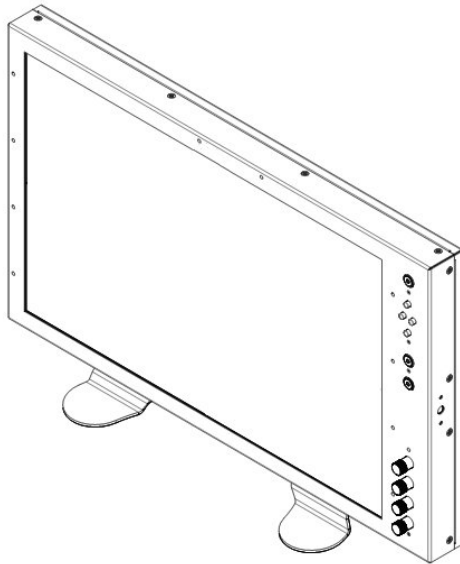

V-R171-IMD-HDSI with optional desktop stand  
(Marshall Part Number V-ST15)

## ■ Connections, Power-On and Initial Setup

Plug the V-PS12-5V-1 power supply into an AC power source (100-240 V @ 50/60 Hz). Attach the 2-pin twist lock connector to the back of the monitor. Connect the required cables for video signal input and output. (Power must be applied to the V-R171-IMD-HDSI for the active loop-through output to be activated.) The monitor defaults to 'ON' when power is supplied. Video will automatically be detected and displayed on the screen.

**For IMD setup details, see IMD Configuration Submenu on page 19.**

# Top and Front Panel Features

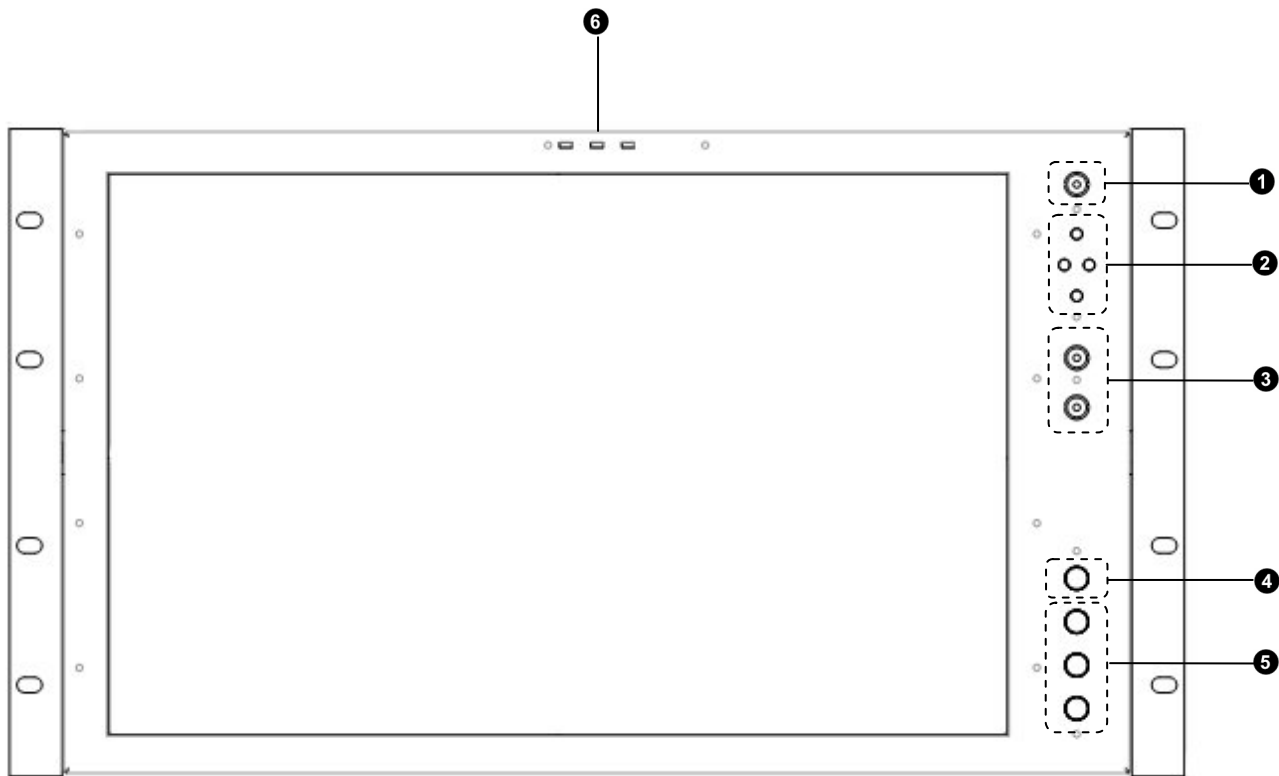

Front View

- 1 Power Button**  
Turn the monitor off or on by pressing the power button. In the ON state, the LED above the power button will illuminate green.
- 2 Menu Navigation Buttons**  
Use the **Menu**, **↑**, **↓**, and **Select** buttons to display and navigate the on-screen menu (**See Main Menu and Navigation – Page 9**).
- 3 User-Definable Function Buttons**  
Two user-definable function buttons can be used for direct access to various settings. Functions are assigned using the on-screen menu (**See User-Definable Function Buttons – Page 15**).
- 4 RotoMenu™ Knob**  
The RotoMenu™ knob is alternate means of accessing and navigating the main menu, using only a single control.
- 5 Image Adjustment Knobs**  
Use the image adjustment knobs to adjust color saturation, brightness and contrast of the image. The status of each image adjustment parameter is shown on the bottom left of the screen, with values ranging from 0 to 100. Pressing each knob resets the corresponding adjustment to its default setting (50).
- 6 LED Tally**  
Three LED tally lights (yellow, red, green) are available above the screen. Each tally light can be controlled from a variety of sources (**See Tally Source – Page 21**).

# Rear Panel Features

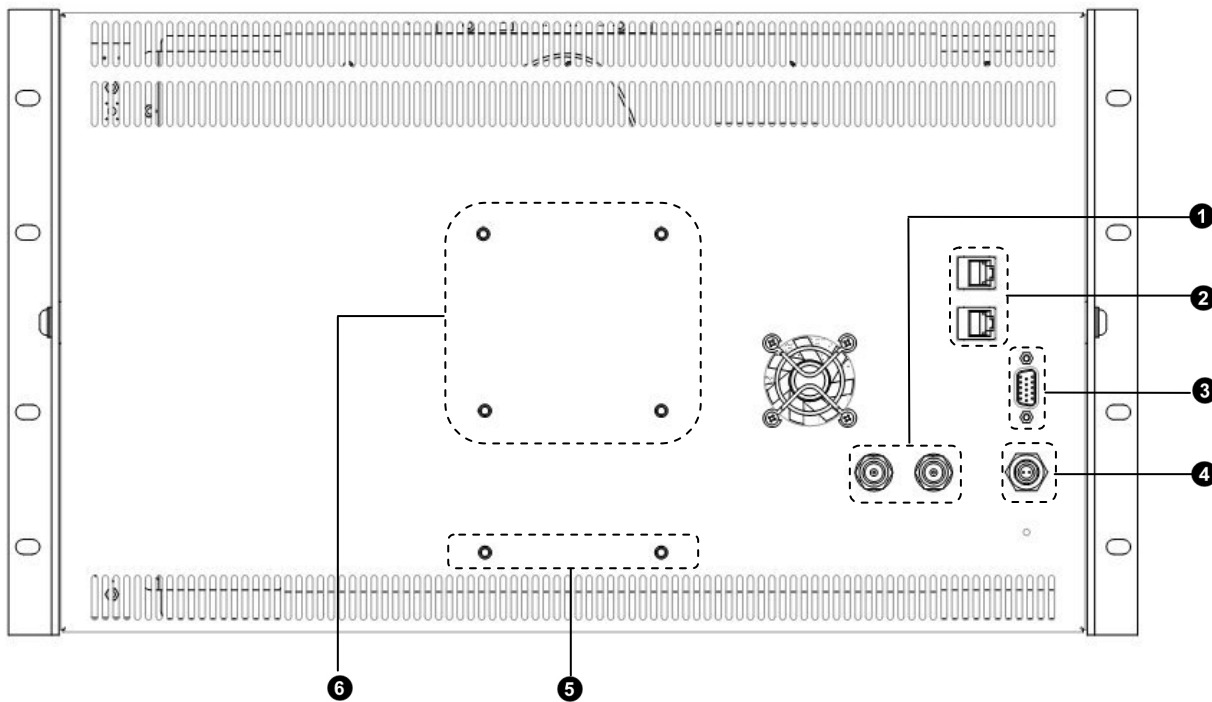

## 1 HD-SDI Input and Output

The V-R171-IMD-HDSDI has one HD-SDI input and one active loop-through output. *Note: No more than 4 screens should be connected in one loop.*

## 2 RS-422/485 Serial Interface

The RS-422/485 ports are used to remotely control the IMD or all V-R171-IMD-HDSDI features, using a variety of industry standard protocols. **(Note: Connector/pin-out may need to be adapted depending on protocol and controlling device used. See pin-out details on page 22.)** Only one connection to either port is needed to control the monitor. The second port can be used to loop multiple monitors in the same bus.

## 3 Tally Interface (HD-15)

Both LED tally and OSD tally can be activated via the HD-15 connector by connecting the corresponding pin to ground. A variety of external devices can be used to perform the contact closure. No additional power should be supplied to the HD-15 port. **See pin-out details on page 22.**

## 4 Power Input

Connect the 12VDC input to the 2-Pin twist lock power input connector. Power can be supplied from the included power supply, or from a variety of DC sources supplying at least 3.0 Amps at 12 Volts.

**IMPORTANT:** If using a power source other than the included power supply, be sure that the polarity of the DC input is correct:



## 5 Mounting Slots

These slots are used when attaching the monitor to the optional desktop stand. **See page 5 for details.**

## 6 VESA 75mm Hole Pattern

A VESA-standard 75 mm hole pattern is provided to accommodate a variety of custom mounting options.

# Compatible Input Formats

The following SDI standards are supported by the V-R171-IMD-HDSDI:

525i, 625i  
 1035i/60, 1035i/59.94  
 1080i/60, 1080i/59.94, 1080i/50  
 1080psF/24, 1080psF/23.98  
 720p/60, 720p/59.94, 720p/50

## On-Screen Menu

### STRUCTURE OVERVIEW

Main	Marker Setup	Marker 16:9	Off, 95%, 93%, 90%, 88%, 80%, 1.85:1, 2.35:1, 4:3, 14:9, 13:9
		Marker 4:3	Off, 95%, 93%, 90%, 88%, 80%
		Marker Backgrd	Off, 50% Gray, Black
		Center Marker	Off, On
	Video Config	CTemp/Gamma	55K, 65K, 93K, Linear
		Monochrome	Off, On
		Blue Only	Off, On
		Pixel to Pixel	Off, On
		Aspect Ratio	4:3, Scaled 4:3, 16:9, Full Screen
		Curtain Color	Blue, Red, Green, White, Black
	System Config	Gray Levels	RGB = 000 - 255 (8 unit steps)
		Function 1	Marker, Center Marker, Marker Background, IMD, Time Code, OSD Tally, Audio Monitor, Aspect Ratio, Pixel to Pixel, CTemp/Gamma, Blue Only, Monochrome
		Function 2	Marker, Center Marker, Marker Background, IMD, Time Code, OSD Tally, Audio Monitor, Aspect Ratio, Pixel to Pixel, CTemp/Gamma, Blue Only, Monochrome
		Load Config	Mfg, User 1, User 2, User 3, User 4, User 5, User 6
		Save Config	User 1, User 2, User 3, User 4, User 5, User 6
		Main Board	(Main board firmware version number displayed)
		Keypad	(Keypad firmware version number displayed)
		CPLD	(CPLD firmware version number displayed)
	OSD Config	IMD State	Off, On
		Status Display	Off, On
		OSD Tally	Off, RGY, RG, GR, IMD
		LED Tally	Off, On
		Anc. Time Code	Off, LTC, VITC
		Audio Monitor	Off, On
	IMD Config	IMD Protocol	Marshall, Image Video, TSL v4.0, Marshall-IV
		IMD ID #	000-255
		IMD Group #	001-254
		IMD Name (S/N)	User Defined (16 chars max.)
		IMD Baud Rate	300, 600, 1200, 2400, 4800, 9600, 19200, 38400, 57600, 115200
		IMD Fixed Align	Center, Right, Left
		IMD Fixed Color	Red, Green, Yellow
		IMD Fixed Str	User Defined (16 chars max.)
		Tally Source	Standard, Image Video HW, Image Video 422, Standard + IV422, TSL/Marshall 422
IMD Tally Mode	T1, T2, T1T2, T2T1, T1-, T2-, T1T2-, T2T1-		
Service	Serial Chars	Rx, Tx	
	Serial Errors	P, F, O	
	Packets	Rec, Exe	
	Packet Errors	CRC, Err	
	Last Command	R, E	
	Software State	000:000 1010111	



### MAIN MENU AND NAVIGATION

Access and navigate the main menu using the 4 menu buttons or the RotoMenu™ knob:

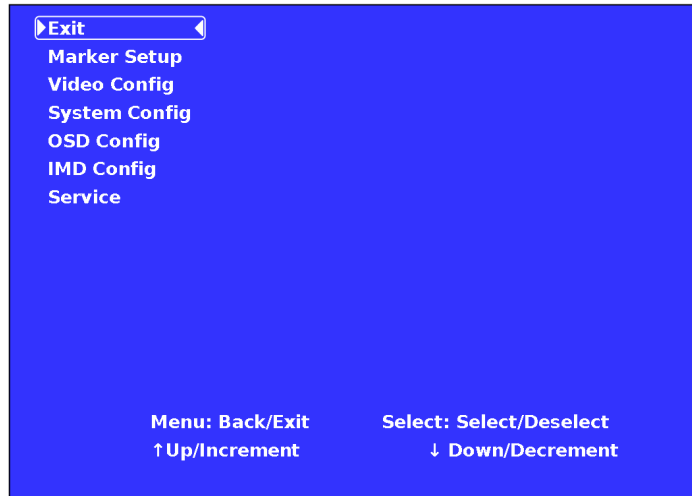

*Main Menu*

#### Using the menu buttons

- Press the **MENU** button to enter the main menu.
- Use the ↑ and ↓ buttons to scroll through the main menu or each submenu.
- Press the **SELECT** button to enter a submenu or choose a setting.
- Press the **MENU** button to exit the main menu, or return to the main menu from a submenu.

#### Using the RotoMenu knob

- Press the **RotoMenu™** knob to enter the main menu.
- Rotate the knob to scroll up or down in the main menu or each submenu.
- Press the **RotoMenu™** knob to enter a submenu or choose a setting.

The menu will automatically time out after 15 seconds of being idle.

## MARKER SETUP SUBMENU

Use the Marker Setup submenu to select various types of markers and settings in 4:3, 16:9, or Full Screen modes.

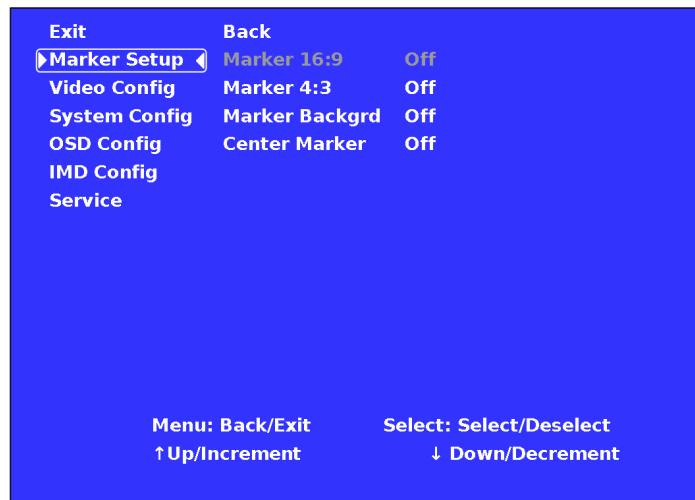

Marker Setup Submenu

### ■ 16:9 Markers

Use this setting to superimpose one of 10 markers on the screen when in 16:9 or Full Screen mode. This setting is disabled when the aspect ratio is set to 4:3, or when Pixel-to-Pixel mode is enabled. Note that in Full Screen mode, markers are vertically “stretched” along with the picture to fit the 16:10 screen.

- Off (No Marker)
- 95% Safe Area
- 93% Safe Area
- 90% Safe Area
- 88% Safe Area
- 80% Safe Area
- 1.85:1 Aspect Ratio
- 2.35:1 Aspect Ratio
- 4:3 Aspect Ratio
- 14:9 Aspect Ratio
- 13:9 Aspect Ratio

#### 16:9 Marker Examples:

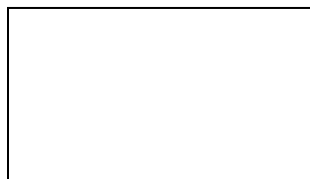

OFF (No Marker)

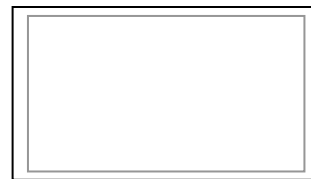

90% Safe Area

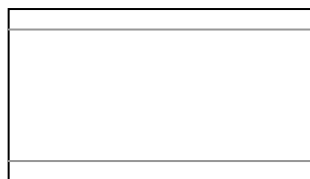

2.35:1 Aspect Ratio



4:3 Aspect Ratio Marker

## MARKER SETUP SUBMENU (continued)

### ■ 4:3 Markers

Use this setting to superimpose one of 5 markers on the screen when in 4:3 mode. This setting is disabled when the aspect ratio is set to 16:9 or Full Screen, and when Pixel-to-Pixel mode is enabled.

- Off (No Marker)
- 95% Safe Area
- 93% Safe Area
- 90% Safe Area
- 88% Safe Area
- 80% Safe Area

#### 4:3 Marker Examples:

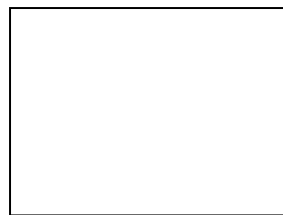

*OFF (No Marker)*

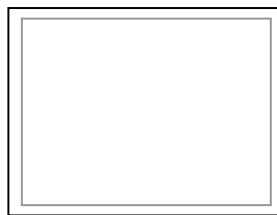

*90% Safe Area*

### ■ Marker Background

Use this setting to choose how selected markers are displayed on the screen:

- Off The marker is superimposed on the complete image.
- 50% Gray Screen area beyond the marker is shown at 50% intensity.
- Black Screen area beyond the marker is shown as black.

#### Example (80% Marker in 4:3 Mode):

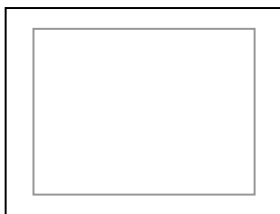

*Background OFF*

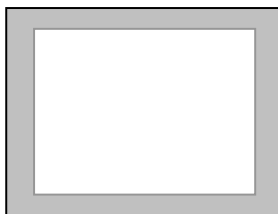

*50% Gray Background*



*Black Background*

### ■ Center Marker

Use this setting to display a center marker on the screen.



*Center Marker*

### VIDEO CONFIGURATION SUBMENU

Use the Video Configuration submenu to select various video settings, such as color temperature, monochrome mode, or blue-only mode.

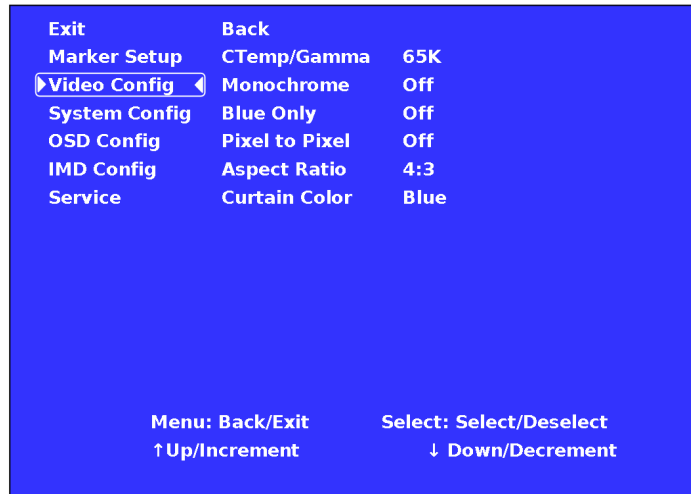

*Video Configuration Submenu*

#### ■ Ctemp/Gamma

Use this setting to choose one of three color temperature / gamma presets:

- D55 (5500K)
- D65 (6500K)
- D93 (9300K)
- Linear (No gamma applied)

#### ■ Monochrome Mode

Use this setting to enable monochrome mode. Only the luminance of the image will be displayed as a grayscale picture.

#### ■ Blue-Only Mode

Use this setting to enable Blue-Only mode. This mode displays only the blue color component of the image, switching off the red and green components. Use this mode when calibrating the monitor to SMPTE color bars with the following procedure:

1. Allow the monitor to warm up for at least 5-10 minutes.
2. Display SMPTE split-field color bars on the monitor using an external source.
3. Enable **Monochrome mode**.
4. Locate the pluge pattern (super black, black, and gray bars) at the lower-right corner of the screen. Adjust the **Brightness** knob until there is no visible difference between the super black and black bars, but the gray bar is still visible.
5. Adjust the **Contrast** knob until an even grayscale appears along the top bars.
6. Disable **Monochrome mode**.
7. Enable **Blue-Only mode** and adjust the **Color** knob so that the outermost bars (white and blue) appear to match in brightness.

### VIDEO CONFIGURATION SUBMENU (continued)

#### ■ Pixel-to-Pixel Mode

Use this setting to enable Pixel-to-Pixel mode.

This mode bypasses the monitor's internal scaling function and displays images in their native resolution and aspect ratio, with a one-to-one mapping of incoming image pixels to screen pixels:

- For incoming formats smaller than the native resolution of the screen (or selected aspect ratio), the image will be displayed in the center of the screen using only the necessary LCD pixels. For example, NTSC or PAL images will occupy exactly 720 x 486 or 720 x 576 pixels respectively. The surrounding screen area will be black.
- For incoming formats exceeding the screen resolution (or selected aspect ratio), only the center portion of the incoming image will be displayed, with the remainder of the picture cropped. For example, 1080i/p formats will both be cropped depending on the selected aspect ratio.

#### ■ Aspect Ratio Settings

Use this menu option to switch between several aspect ratio settings

As the V-R171-IMD-HDSDI monitor has a native resolution of 1680 x 1050 RGB pixels, incoming images are automatically scaled to fit the screen:

- In **4:3** mode, images are scaled up or down to fill the maximum 4:3 portion of the screen (1600 x 1200). IMD text and time code are superimposed on the lower portion of the image. The audio presence indicator and on-screen tally are displayed at the bottom of the screen, outside the image.
- In **Scaled 4:3** mode, images are scaled to a smaller 4:3 portion of the screen, leaving space for IMD text, tally, and audio presence indicator to be displayed below or around the image. Time code is superimposed on the lower portion of the image.
- In **16:9** mode, images are scaled to fill the maximum 16:9 portion at the top of the screen (1920 x 1280). In this mode, IMD text and on-screen tally are displayed below the image. Time code and the audio presence indicator are superimposed on the lower portion of the image.
- In **Full Screen (16:10)** mode, images are scaled to fill the entire 16:10 screen (1920 x 1200). In this mode, all OSD features are superimposed on the image. **Note that when using a 16:9 input image in this mode, the image will be slightly vertically stretched.**

The diagrams on the following page show how IMD text, timecode, and the audio monitor icon are simultaneously displayed on the screen in each aspect ratio setting. The white area represents the video image.

### VIDEO CONFIGURATION SUBMENU (continued)

#### ■ Aspect Ratio Settings (continued)

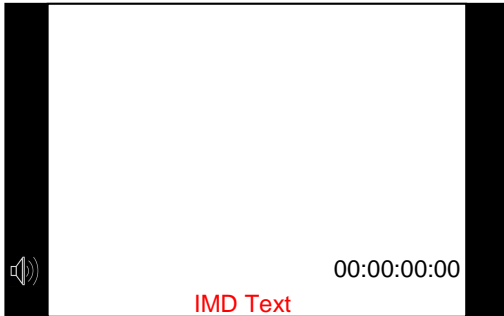

4:3



Scaled 4:3

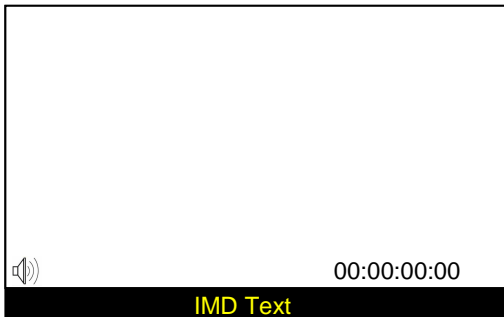

16:9

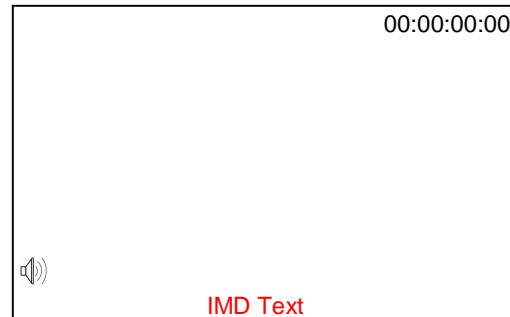

Full Screen (16:10)

#### ■ Curtain Color

Use this setting to choose the default color displayed on the screen when no video input is present. Available colors are **blue**, **red**, **green**, **white**, and **black**.

## SYSTEM CONFIGURATION SUBMENU

Use the System Configuration submenu to control various system parameters.



System Configuration Submenu

### ■ Gray Levels

Use the Gray Levels menu option to view 32 levels of flat field gray. This feature is useful for color temperature comparison and calibration.

### ■ User-Definable Function Buttons

Use the **Function 1** and **Function 2** menu items to define each function button on the front panel of the monitor. The following options are available for each button:

- Marker Enable and rotate amongst marker settings (choices depend on aspect ratio setting)
- Center Marker Enable/disable center marker
- Marker Backgrd Rotate amongst marker backgrounds
- IMD Display/hide IMD text
- Time Code Display/hide time code
- OSD Tally Rotate amongst types of OSD Tally
- Audio Monitor Display/hide audio presence indicator
- Aspect Ratio Toggle between 4:3 and 16:9 aspect ratios
- Pixel to Pixel Enable/disable Pixel-to-Pixel mode
- Ctemp/Gamma Rotate amongst color temperature settings
- Blue Only Enable/disable Blue Only mode
- Monochrome Enable/disable Monochrome mode

### ■ Saving and Loading User Presets

Use the SAVE CONFIG and LOAD CONFIG menus to save current settings to one of 6 presets, or load a preset. Each Preset saves all monitor settings except for IMD configuration.

- Use the LOAD CONFIG menu to load one of presets USR1 – USR6. Factory default settings can also be loaded by selecting MFG. (Factory defaults cannot be overwritten.)
- Use the SAVE CONFIG menu to save the current settings to a preset from USR1- USR6.

### ■ Software Version Display

The Main Board, Keypad, and CPLD software version numbers are displayed.

### OSD CONFIGURATION SUBMENU

Use the OSD Configuration submenu to select a variety of information to be displayed on the screen.



*OSD Configuration Submenu*

#### ■ IMD State

Use this setting to turn the IMD text display on or off. This setting affects both fixed string IMD text and remote IMD text commands (see **IMD Configuration Submenu for details – page 19**).

#### ■ Status Display

Use this setting to enable or disable status display. When enabled, the current video input standard is displayed on the top left of the screen. When disabled, status is only displayed for 2 seconds when the monitor is powered on, when an input is applied, or when the input video standard changes. The status display reads “No Input” when no video input is present.



*Status Display*



## OSD CONFIGURATION SUBMENU (continued)

### ■ OSD Tally

Use this setting to choose how tally is displayed on the screen. The available OSD Tally options depend on the Tally Source selected in the IMD Configuration submenu (**see page 19**).

When the Tally Source is set to Standard (contact closure), OSD Tally can be set to **Off**, **RGY**, **RG**, or **GR**:

- Off On-screen tally is disabled
- RGY Red, yellow, or green tally signals are indicated at both the bottom left and bottom right corners of the screen. Two or three colors are shown simultaneously by subdividing each tally indicator
- RG Red tally is shown at the bottom left of the screen, and green is shown at the bottom right.
- GR Green tally is shown at the bottom left of the screen, and red is shown at the bottom right.

The following diagrams show RGY, RG, and GR OSD Tally modes:

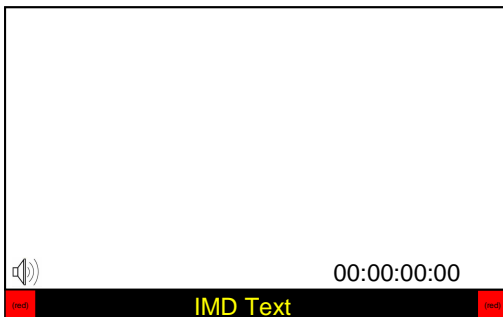

*RGY mode: single color activated*

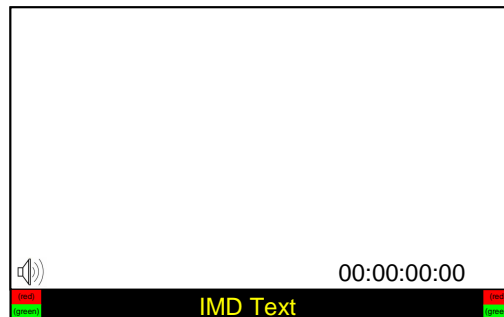

*RGY mode: two colors activated*

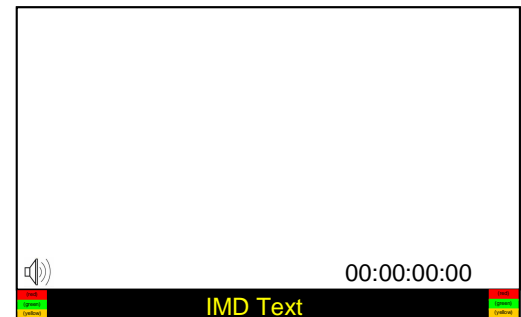

*RGY mode: three colors activated*

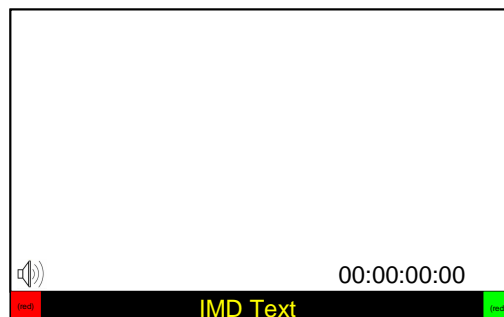

*RG Mode: both colors activated*

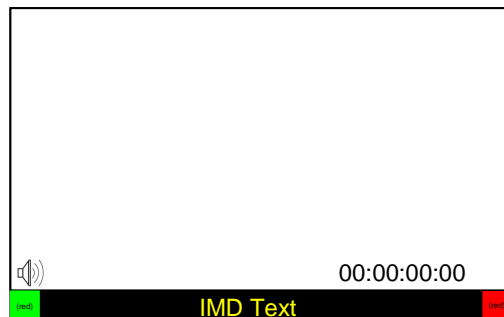

*GR Mode: both colors activated*

When the Tally Source is set to TSL/Marshall 422, OSD Tally can be set to **Off** or **IMD**:

- Off On-screen tally is disabled
- IMD Red, yellow, and green tally is displayed according the protocol commands. Green, red, and yellow colors are shown individually on either the bottom left or right of the screen.

### OSD CONFIGURATION SUBMENU (continued)

#### ■ LED Tally

Use this setting to enable or disable the LED Tally. When enabled, the yellow, red and green LEDs above each display will respond to tally commands, according to the Tally Source setting (see page 21).

#### ■ Time Code

Use this setting to enable time code display on the screen. Time code is de-embedded from the vertical ancillary data (VANC) within the SDI signal. Two types of time code can be selected to display on the screen: **LTC (linear time code)** or **VITC (vertical interval time code)**.

The position of the time code display varies based on the aspect ratio setting and presence of IMD text (see **Aspect Ratio diagrams on page 14**).

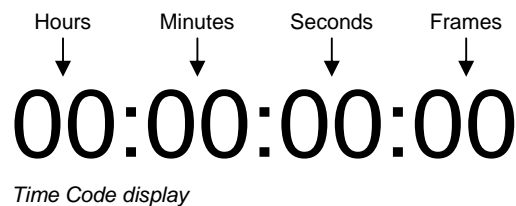

#### ■ Audio Monitor

Use the Audio Monitor menu option to enable or disable the audio presence indicator icon. When enabled, this icon indicates whether embedded audio is present in the SDI video input. A red circle and cross will flash on the icon if no embedded audio is present.



*Embedded Audio Present*



*No Embedded Audio*

## IMD CONFIGURATION SUBMENU

### ■ Overview

The V-R171-IMD-HDSDI features an In-Monitor Display (IMD) with the ability to display on-screen text and tally in three colors. IMD text, color, and alignment can be assigned to each screen locally using menu options (see below). Alternately, IMD text and tally can be remotely controlled via the RS-422/485 serial interface using several industry-standard protocols, including TSL and Image Video. Multiple V-R171-IMD-HDSDI monitors can be looped together and each addressed individually via the protocol. All menu features of the V-R171-IMD-HDSDI can also be controlled via the Marshall Network Controller box and Marshall protocol. (Contact Marshall Electronics for additional information).

Use the IMD Configuration submenu to configure various IMD parameters as described below.

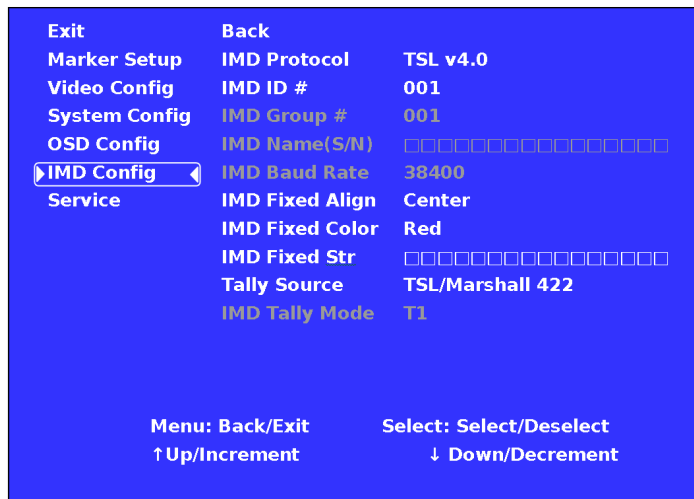

IMD Configuration Submenu

### ■ IMD Protocol

Use the IMD Protocol menu option to choose the protocol with which the V-R171-IMD-HDSDI receives remote commands. Currently, four protocols are available. Contact Marshall Electronics for the latest protocol compatibility.

#### Image Video

Use the Image Video protocol setting when controlling the IMD from an Image Video tally controller (e.g. TSI-1000) or other controlling device which utilizes the Image Video protocol. The **IMD #**, **IMD Name(S/N)**, and **Baud Rate** parameters must be set for each screen in conjunction with the controlling device.

#### TSL v4.0

Use the TSL v4.0 protocol setting when controlling the IMD from a TSL tally controller, or other controlling device which utilizes the TSL v4.0 protocol. The **IMD #** must be set for each screen in conjunction with the controlling device.

#### Marshall

Use the Marshall protocol setting when controlling the V-R171-IMD-HDSDI using the Marshall Network Controller box. This protocol allows remote control of all features on the V-R171-IMD-HDSDI, including marker setup, video configuration, system configuration, and image adjustments (brightness, contrast, etc.). The **IMD #**, **IMD Group #**, and **Baud Rate** parameters must be set in conjunction with the Network Controller Box.

#### Marshall-IV

This protocol setting accepts Image Video commands via the Marshall protocol, for use when an Image Video controller is connected to the Marshall Network Controller box.

### IMD CONFIGURATION SUBMENU (continued)

#### ■ IMD ID #

The IMD ID # identifies each screen to the controlling device. When using the TSL protocol, the ID # of each screen should be manually set in conjunction with the controlling device. When using the Image Video protocol, the ID # may be set automatically by the controlling device, after each IMD is initially identified by IMD Name (see "IMD Name[S/N]" below). Available ID #s are **000-255**. When using the Marshall protocol, available ID #s are **001-254**.

#### ■ IMD Group #

Each screen can be assigned an IMD Group # when using the Marshall protocol. Available Group #s are **01-254**.

#### ■ IMD Name (S/N)

Use this setting to assign a name to each screen when using the Image Video or Marshall-IV protocols. **The IMD name is equivalent to the Image Video serial number and is used by the Image Video controlling device to identify each screen.** The default IMD Name(S/N) is "M00000." It is recommended to maintain this naming scheme in order to avoid serial number conflicts with other Image Video devices on the same serial bus. Each name can be up to 16 ASCII characters.

Press **ENTER** to edit the IMD Name. Use the **↑** and **↓** buttons to move the cursor. Press **ENTER** with the cursor on the character to be changed and use the **↑** and **↓** buttons to scroll through character options. Press **ENTER** to choose a character.

#### ■ IMD Baud Rate

Use this setting to choose the baud rate. The baud rate must be set in conjunction with the controlling device. Available baud rates are **300, 600, 1200, 2400, 4800, 9600, 19200, 38400, 57600, 115200**. The TSL v4.0 protocol is fixed at 38400 bauds.

#### ■ IMD Fixed Align

Use this setting to choose the horizontal alignment of the IMD text. IMD text can be justified on the **left, center** or **right** of the screen. This setting is overridden when using IMD text via the Image Video protocol (alignment is set via Image Video protocol).

#### ■ IMD Fixed Color

Use this setting to choose the color of the IMD Fixed String text (see below). Available colors are **red, green,** and **yellow**. This setting does not affect text color when using IMD text via the Image Video or TSL v4.0 protocols (text color is set via the protocols).

#### ■ IMD Fixed String

Use this setting to display static IMD text on the screen. This setting is used to enter IMD text locally, when a serial protocol is not used for remote control. The IMD Fixed String is saved after power cycle. *The IMD Fixed String will be overridden by serial protocol commands.*

Press **ENTER** to edit the IMD Fixed String. Use the **↑** and **↓** buttons to move the cursor. Press **ENTER** with the cursor on the character to be changed and use the **↑** and **↓** buttons to scroll through character options. Press **ENTER** to choose a character.

## On-Screen Menu (continued)

### IMD CONFIGURATION SUBMENU (continued)

#### ■ Tally Source

The V-R171-IMD-HDSDI tally (OSD and LED) can be controlled in a variety of different ways. Use the Tally Source setting to choose how tally is controlled:

##### Standard

Use the Standard setting to control tally via contact closure on the HD-15 tally interface.

##### Image Video HW

Use the Image Video HW setting to control Image Video tally states via contact closure on the HD-15 tally interface. Contact closure of the **Red** pin corresponds to **Image Video Tally 1**, and the **Green** pin maps to **Image Video Tally 2**. Contact closure (ground) corresponds to a LOW state, and open circuit corresponds to a HIGH state. This mode requires the IMD Tally Mode parameter to be set. Consult Image Video documentation for further information.

##### Image Video 422

Use the Image Video 422 setting to control Image Video tally states via the Image Video serial protocol. LED and OSD tally will be disabled in this mode, as Image Video tally states are manifested in the text color and other parameters. This mode requires the IMD Tally Mode parameter to be set. Consult Image Video documentation for further information.

##### Standard + IV422

Use the Image Video 422 setting to control Image Video tally states via the Image Video serial protocol, while controlling LED and OSD tally using contact closure on the HD-15 tally interface. This mode requires the IMD Tally Mode parameter to be set. Consult Image Video documentation for further information.

##### TSL/Marshall 422

Use the TSL/Marshall 422 setting to control OSD and LED tally via the TSL or Marshall serial protocols.

#### ■ IMD Tally Mode

Use this setting when using Image Video tally control. Choose one of the following settings, in conjunction with the Image Video controlling device. **T1, T2, T1T2, T2T1, T1-, T2-, T1T2-, T2T1-**. Consult Image Video documentation for further information.

### SERVICE SUBMENU

#### ■ Overview

The Service submenu displays the status of the serial interface, for troubleshooting or debugging purposes only. Contact Marshall Electronics for further information. The following information is displayed:

• Serial Characters	Rx:	Total number of characters received by the UART
	Tx:	Total number of characters transmitted by the UART
• Serial Errors	P:	Number of parity errors
	F:	Number of framing errors
	O:	Number of FIFO overrun errors
• Packets	Rec:	Number of packets received
	Exe:	Packets Executed
• Packet Errors	CRC:	Number of packets that failed CRC check
	Err:	Number of other packet errors
• Last Command	R:	Last command received
	E:	Last command executed
• Software State	State:	000:000 1010111 (correct value)

# Specifications

## ■ PANEL

Screen Size	17" Diagonal
Display Area (h x v)	367.20 x 229.50 mm
Aspect Ratio	16:10 Native (4:3/16:9 Modes)
Pixels	1920 x RGB x 1200
Color Depth	24-bit (16,777,216 Colors)
Viewing Angle (h x v)	140° x 120°
Brightness	400 cd/m <sup>2</sup>
Contrast Ratio	600:1
Dot Pitch (h x v)	0.064 x 0.191 mm
Pixel Pitch (h x v)	0.191 x 0.191 mm

## ■ VIDEO INPUT/OUTPUT

**HD-SDI Input / Output**  
Supports ITU-R BT.656, SMPTE 259M, 292M, 274M

## ■ CONNECTORS

**Video Input**  
1 x BNC Female (75 Ω)

**Video Output (Active Loop-Through)**  
1 x BNC Female (75 Ω)

**Power Input**  
2-Pin Twist Lock Connector

**Tally Hardware Interface**  
HD-15 Female

**RS-422/485 Interface**  
2 x RJ12 (Modular 6P6C)

## ■ TALLY HARDWARE INTERFACE (HD-15)

Activation requires contact closure of pin to ground on the HD-15 connector:

Pin No.	Signal
1	Green
2	Red
3	Yellow
4	N/C
5	Ground
6	N/C
7	N/C
8	N/C
9	N/C
10	N/C
11	N/C
12	N/C
13	N/C
14	N/C
15	N/C

## ■ RS-422/485 SERIAL INTERFACE (RJ12)

Protocols: Image Video, TSL v4.0, Marshall

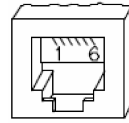

Pin No.	Signal
1	Tx-
2	Ground
3	Rx+ (Receive from host)
4	Rx- (Receive from host)
5	N/C
6	Tx+

## ■ ELECTRICAL

Power Consumption 5.0A @ 12VDC (60 W)  
Voltage Requirement 12 VDC

V-PS12-5V-1 Power Supply:  
Input 100V-240V, 2.5A, 50-60Hz  
Output 12-17VDC, 5A, 60W Max

## ■ MECHANICAL

Dimensions (w x h x d): 18.9" x 10.45" x 1.40"

Weight (with rack ears): 5.10 lbs

Operating Temperature 32°F to 120°F (0°C to 50 °C)  
Storage Temperature -4°F to 120°F (-20°C to 50°C)

Compliance CE, FCC-Class A, ANSI-63.4 (Certificates on file)

RoHs Do not dispose. Return to Manufacturer or Authorized Recycle Facility.

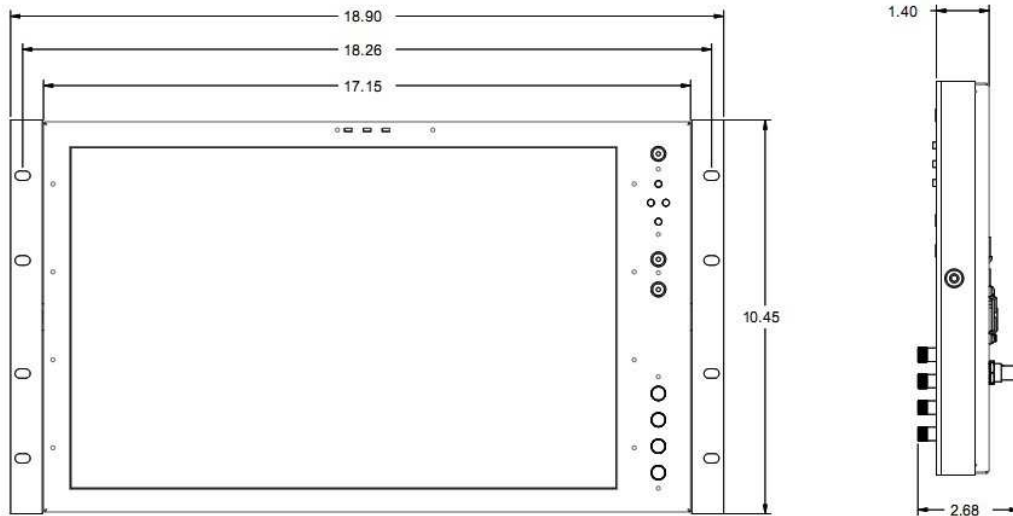

## Maintenance

### ■ Screen Cleaning

Periodically clean the screen surface using ammonia-free cleaning wipes (Marshall Part No. **V-HWP-K**). A clean micro-fiber cloth can also be used using only non-abrasive and ammonia-free cleaning agents. Do not use paper towels. Paper towel fibers are coarse and may scratch the surface of the polycarbonate faceplate or leave streaks on the surface. Antistatic and fingerprint resistant cleaning agents are recommended. Do not apply excessive pressure to the screen to avoid damaging the LCD.

### ■ Faceplate Dusting

Dust the unit with a soft, damp cloth or chamois. Dry or abrasive cloths may cause electrostatic charge on the surface, attracting dust particles. Neutralize static electricity effects by using the recommended cleaning and polishing practice.

# Warranty

---

Marshall Electronics warranties to the first consumer that this **V-R171-IMD-HDSI** LCD monitor will, under normal use, be free from defects in workmanship and materials, when received in its original container, for a period of one year from the purchase date. This warranty is extended to the first consumer only, and proof of purchase is necessary to honor the warranty. If there is no proof of purchase provided with a warranty claim, Marshall Electronics reserves the right not to honor the warranty set forth above. Therefore, labor and parts may be charged to the consumer. This warranty does not apply to the product exterior or cosmetics. Misuse, abnormal handling, alterations or modifications in design or construction void this warranty. *It is considered normal for a minimal amount of pixels, not to exceed three, to fail on the periphery of the display active viewing area.* Marshall Electronics reserves the option to refuse service for display pixel failure if deemed unobtrusive to effective use of the monitor by our technicians. No sales personnel of the seller or any other person is authorized to make any warranties other than those described above, or to extend the duration of any warranties on behalf of Marshall Electronics, beyond the time period described above. Due to constant effort to improve products and product features, specifications may change without notice.

V1.0

**Marshall Electronics, Inc.**

1910 East Maple Ave.

El Segundo, CA 90245

Tel: (800) 800-6608 / (310) 333-0606 • Fax: 310-333-0688

[www.LCDRacks.com](http://www.LCDRacks.com) • [sales@lcdracks.com](mailto:sales@lcdracks.com)



## Free Manuals Download Website

<http://myh66.com>

<http://usermanuals.us>

<http://www.somanuals.com>

<http://www.4manuals.cc>

<http://www.manual-lib.com>

<http://www.404manual.com>

<http://www.luxmanual.com>

<http://aubethermostatmanual.com>

Golf course search by state

<http://golfingnear.com>

Email search by domain

<http://emailbydomain.com>

Auto manuals search

<http://auto.somanuals.com>

TV manuals search

<http://tv.somanuals.com>