

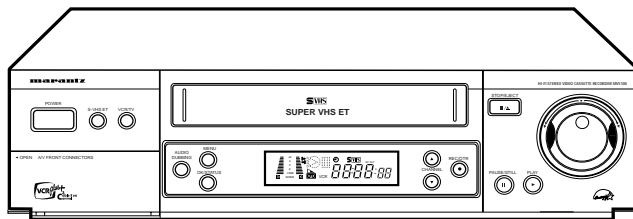

marantz®

Model MV5100 User Guide

Video Cassette Recorder



Hi-Fi **SVHS**



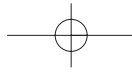

SAFETY PRECAUTIONS



	CAUTION RISK OF ELECTRIC SHOCK DO NOT OPEN	
<p>CAUTION: TO REDUCE THE RISK OF ELECTRIC SHOCK, DO NOT REMOVE COVER (OR BACK). NO USER-SERVICEABLE PARTS INSIDE. REFER SERVICING TO QUALIFIED SERVICE PERSONNEL.</p>		

Introduction

Congratulations on purchasing your new VCR. You can't wait to get it working, but before you do, spare a few moments to read this brief introduction to the world of video recording. It may repay you handsomely in terms of improved results, and avoiding of costly mistakes.



This "bolt of lightning" indicates uninsulated material within your unit may cause an electrical shock. For the safety of everyone in your household, please do not remove product covering.



This "exclamation point" calls attention to features for which you should read the enclosed literature closely to prevent operating and maintenance problems.

Positioning

Do not place the VCR directly on top of, or underneath, your TV set. Ensure that there is at least 20 cm between the VCR and the TV set, and that air can circulate freely through the ventilation openings of the VCR.

WARNING: TO PREVENT FIRE OR SHOCK HAZARD, DO NOT EXPOSE THIS EQUIPMENT TO RAIN OR MOISTURE.

CAUTION: To prevent electrical shock, match wide blade of plug to wide slot, and fully insert.

ATTENTION: Pour éviter les chocs électriques, introduire la lame la plus large de la fiche dans la borne correspondante de la prise et pousser jusqu'au fond.

FCC Warning: Any unauthorized changes or modifications to this equipment void the user's authority to operate it.

For Customer Use
 Enter below the Serial No. which is located on the rear of the cabinet.
 Retain this information for future reference.

Model No. _____

Serial No. _____

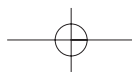



Introduction 3

Welcome to your VCR owner's manual.

This manual has seven sections: Setting Up Your VCR; Description of Controls; Basic Operations; Recording; Playing; Additional Features; and Information You May Need. The instructions explain all of the VCR's features, which are listed below.

Features

- Automatic Channel Setup
- Automatic Clock Setting
- Automatic Head Cleaner/Head Cleaning Warning
- Audio Dubbing
- Blue Background
- Child Lock
- Controller for Cable Box or Direct Broadcasting System (DBS)
- Daylight-Savings Time
- Digital Studio Picture Control (DSPC)
- Hi-Fi Stereo Tape Playback
- Index Search
- Multi-Channel Television Sound (MTS) System
- 19 Micron Head
- On-Screen Menus in English, Spanish, or French
- Program Overlap Warning
- Quick Programming
- Record Link
- Remote Control with Capability to Operate TV, Cable Box, and Direct Broadcast System (DBS)
- Repeat Play
- S-VHS ET
- S-VHS Recording
- ShowGuard™-Indefinite Timer Recording Memory
- Skip Search
- SmartPicture™
- Tape Manager
- Turbo Timer
- VCR Plus+ Programming System
- Video Stabilizer

This VCR, equipped with a High Quality (HQ) System, is compatible with existing Video Home System (VHS) equipment. It also has a 19 micron head that provides a better picture when you view tapes recorded in slow speed (SLP). The S-VHS feature provides the best picture quality when the VCR uses S-VHS tapes. MARANTZ AMERICA, Inc. recommends that you use only video cassette tapes that are labelled with the  mark or the  mark. The use of other tapes may result in poor picture quality and excessive deposits on the video heads, which may not be covered by the warranty if damage occurs.

Safety Precautions

Warning: To prevent fire or shock hazard, do not expose this equipment to rain or moisture.
Federal Communications Commission (FCC) Warning: Any unauthorized changes or modifications to this equipment void the user's authority to operate it.

Note to the Cable TV System Installer: This reminder is provided to call the Cable TV system installer's attention to Article 820-40 of the National Electrical Code, which provides guidelines for proper grounding – in particular, specifying that the cable ground shall be connected to the grounding system of the building, as close to the point of cable entry as possible.

Declaration of Conformity

Model Number: MV5100
 Trade Name: MARANTZ
 Responsible Party: MARANTZ AMERICA, Inc
 440 Medinah Road,
 Roselle, IL 60172
 (630) -307-3100

This device complies with part 15 of the FCC Rules. Operation is subject to the following two conditions: (1) This device may not cause harmful interference, and (2) this device must accept any interference received, including interference that may cause undesired operation.



The ENERGY STAR® name and logo are registered marks of the U.S. Environmental Protection Agency. As an ENERGY STAR® Partner, Marantz America, Inc. has determined that this product meets the ENERGY STAR® guidelines for energy efficiency.



SmartPicture and ShowGuard are trademarks of Marantz America, Inc. VCR Plus+ and PlusCode are registered trademarks of Gemstar Development Corporation. The VCR Plus+ system is manufactured under license from Gemstar Development Corporation.
 Copyright 2000 Marantz America Inc. All rights reserved.

Helpful Hint

- Your new product, its packaging, and this manual contain materials that can be recycled and reused. Specialized companies can recycle your product to increase the amount of reusable materials and to minimize the amount that needs to be properly disposed. Your product uses batteries that should not be thrown away when depleted but should be disposed of as small chemical waste. Please find out about the local regulations on disposal of your old products, batteries, manual, and packaging whenever you replace existing equipment.

4 Table of Contents

Setting Up Your VCR

Introduction	3
Table of Contents	4
Before Using Your VCR	5
Hookups without a Cable Box	6-7
Hookups with a Cable Box/Direct Broadcast System	8-9
Turning on Your VCR	10-11
Automatic Channel Setup	12-13
Setting the Clock	14-18
Daylight-Savings Time	19
Language Selection	20

Description of Controls

Display Panel	21
Front Panel	22
Rear Panel	23
Remote Control Buttons	24-25
On-Screen Status Displays	26
Setting the Remote Control to Operate a TV	27
Setting the Remote Control to Operate a Cable Box/DBS	28

Basic Operations

Playing	29
Recording	30

Recording

S-VHS Recording	31
S-VHS ET	32
Recording One Channel/Watching Another	33
One-Touch Recording	34
Record Link	35
Setting Up the VCR Plus+ Programming System	36-37
Timer Recording with the VCR Plus+ Programming System	38-39
Quick Programming	40-43
Turbo Timer	44
Program Review	45
Program Overlap Warning	46
Timer Recording Speed Setting	47
Rerecording (Tape Duplication)	48
Audio Dubbing	49
Connecting the Controller	50
Setting the Controller to Operate a Cable Box	51-52
Setting the Controller to Operate a DBS	53-54

Playing

Multi-Channel Television Sound System	55-56
Hi-Fi Stereo Tape Playback	57
Video Stabilizer	58
SmartPicture	59
Digital Studio Picture Control	60
Search Options	61
Playback Options	62-63

Additional Features

Tape Manager	64-73
Child Lock	74
Blue Background	75
Automatic Operation Features	76

Information You May Need

Glossary	77
Helpful Hints	78-79
Specifications	80
Index	81

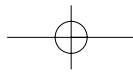

Before Using Your VCR 5

Putting Batteries in the Remote Control

1

To remove the battery compartment lid, push in the tab, then pull up the lid.

2

Place two AA batteries inside the battery compartment with their + and - ends aligned as indicated.

3

Replace the battery compartment lid.

1

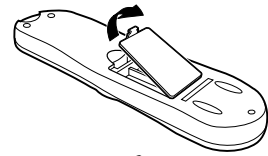

2

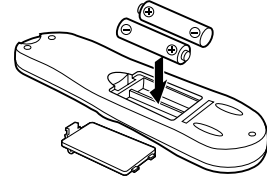

3

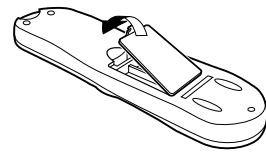

Using the Remote Control

- Do not put objects between the remote control and the VCR.
- Point the remote control at the device you are operating.
- Press the VCR button before pressing other VCR buttons; press the TV button before pressing other TV buttons; press the SAT/CBL/DBS button before pressing other Cable Box/DBS buttons. *Details are on pages 24-25 and 27-28.*

Erase Protection

Video cassettes have record tabs to ensure that recordings are not erased accidentally.

1

To prevent accidental erasure, break off the tab with a screwdriver.

2

To record again, cover the hole with cellophane tape.

1

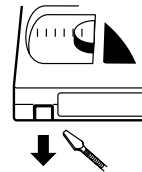

2

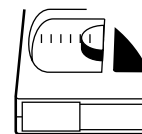

VCR Maintenance/Video Head Cleaning

- Remove any light adhesive stick-on notes from the video cassette before putting the cassette in the VCR. Removable labels can jam the VCR.
- Periodic maintenance is required to maintain your VCR's performance. Your VCR automatically cleans the video heads each time you insert a tape. However, the heads may become dirty. "USE CLEANING CASSETTE" may appear on the screen, or "U:01" may appear on the VCR display panel. *Details are on page 79.*

Helpful Hints

- The remote control and its batteries are supplied.
- Do not mix alkaline and manganese batteries.
- Do not mix old and new batteries.
- A thin, plastic cover may protect the front panel of your VCR. Before using the VCR, lift a corner of the plastic, then peel it off.

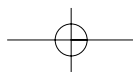

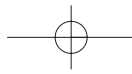

6 Hookups without a Cable Box

The basic VCR/TV connection – antenna/cable to VCR to TV – is shown below. If you have a Cable Box or a Direct Broadcast System, please refer to pages 8-9. After you hook up the VCR, please go to pages 10-11 to turn on the VCR.

1

Disconnect the antenna or cable from your TV.

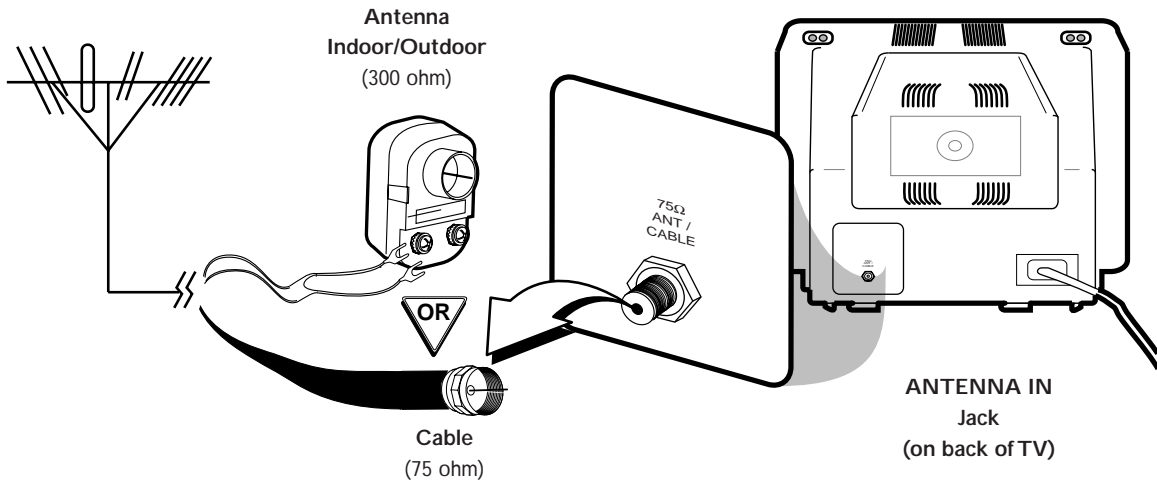

2

Connect the antenna or cable to the ANTENNA IN Jack on the back of the VCR.

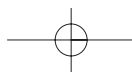
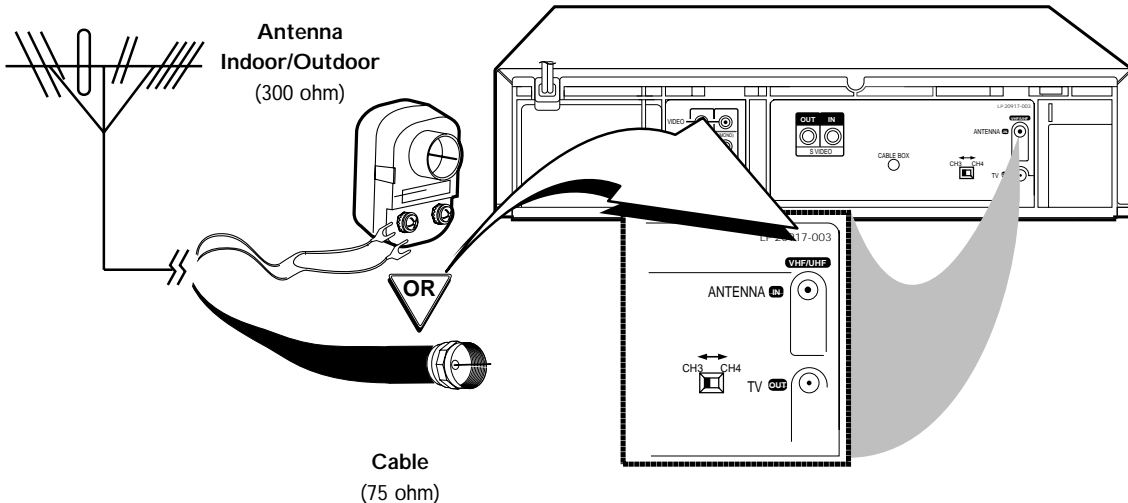

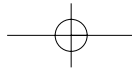

Hookups without a Cable Box (cont'd) 7

3

Connect the RF coaxial cable (supplied) to the TV OUT Jack on the back of the VCR and to the ANTENNA IN Jack on the TV. (You may use either a snap-on type or screw-on type of coaxial cable, whichever you prefer. A snap-on type is supplied.)

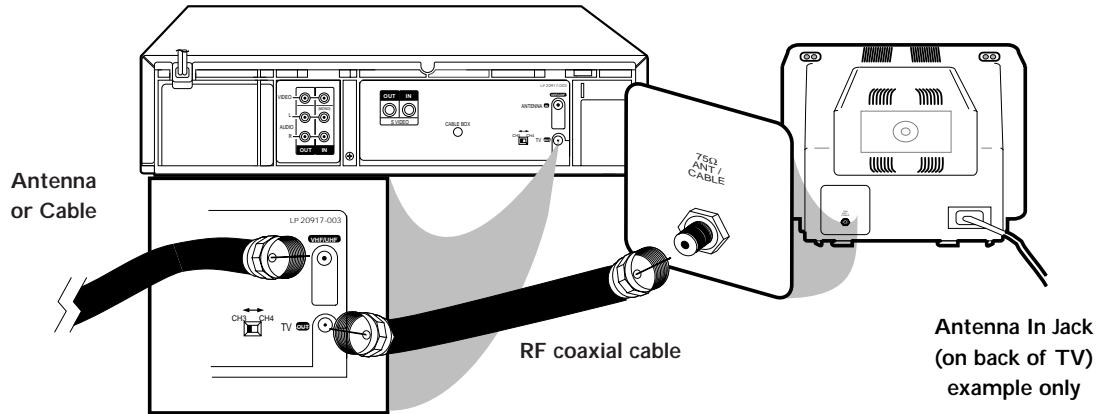

4

Plug in the TV and the VCR.

5

Set the CH3/CH4 switch on the back of the VCR to CH3 or CH4, whichever channel is not used or least used in your area. To operate your VCR with your TV, set the TV to the same channel. For example, when playing a tape, if the CH3/CH4 switch is set to CH3, the TV should be on channel 3.

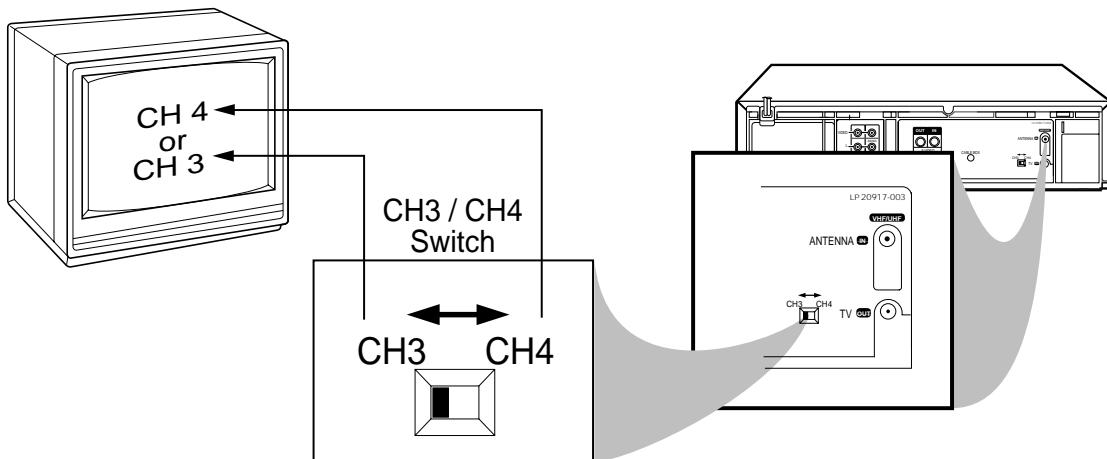

6

You are ready to turn on the VCR. Please go to pages 10-11 before turning on the VCR.

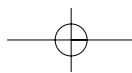

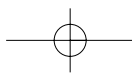

8 Hookups with a Cable Box/Direct Broadcast System

There are two ways to connect your Cable Box/DBS to the VCR. With this connection:

- You may view any channel.
- You must select channels at the Cable Box/DBS. Channels cannot be changed at the VCR.
- You may not view a channel other than the one you are recording.
- You may not set up channels at the VCR.
- You can only program a timer recording for one channel at a time if you are not using the Controller. Set the TV and the VCR to the Cable Box/DBS output channel (channel 03 or 04); set the CH3/CH4 switch to the same channel. Set your Cable Box/DBS to the channel you want to record. When you enter the channel you want to record in a timer recording, select channel 03 or 04 (the Cable Box/DBS output channel). (This is step 3 on page 40.) Leave the Cable Box/DBS on for a timer recording.
- To set up the Controller, see pages 50-54.

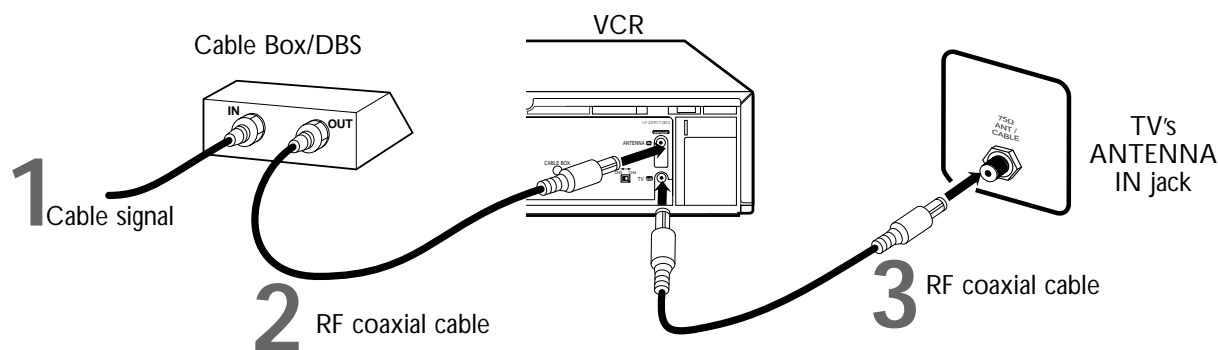

Connections

1

Connect a Cable signal to the IN jack on the Cable Box/DBS.

2

Use an RF coaxial cable (supplied) to connect the OUT jack on the Cable Box/DBS to the ANTENNA IN jack on the VCR.

3

Use a second RF coaxial cable to connect the TV OUT jack on the VCR to the TV's ANTENNA IN jack.

Recording/Viewing Any Channel

1

With the VCR on and in VCR position (the VCR light will appear on the display panel), use the CH(annel) ▲/▼ button to set the VCR to the Cable Box/DBS output channel (channel 03 or 04).

2

Set the TV to the same channel to which you set the VCR. Set the CH3/CH4 switch on the VCR to the same channel.

3

Select the channel you want to view/record at the Cable Box/DBS.

Helpful Hint

- If you are using Record Link, use audio and video cables to connect the AUDIO/VIDEO OUT jacks on the Cable Box/DBS to the AUDIO/VIDEO IN jacks on the back of the VCR. Details are on page 35.

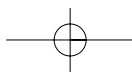

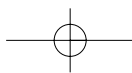

Hookups with a Cable Box/Direct Broadcast System (cont'd) 9

With this connection:

- You may watch one channel while recording another.
- You may not record scrambled channels.

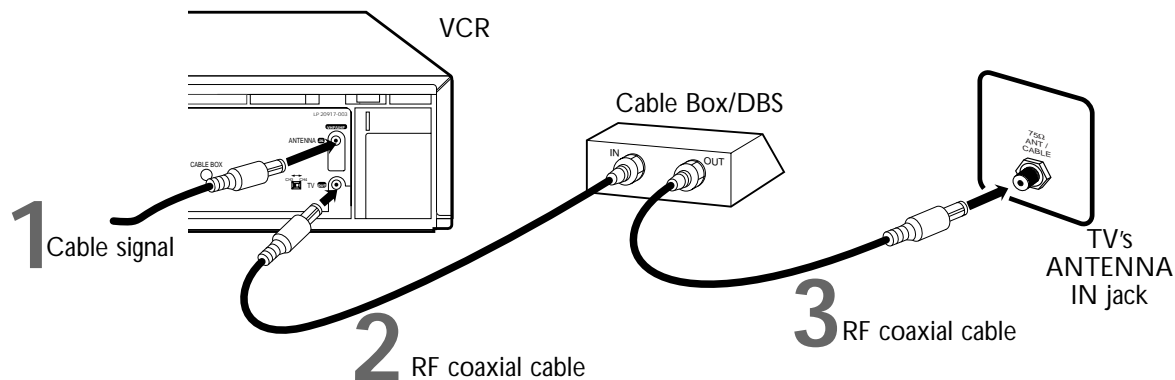

Connections

1

Connect a Cable signal to the VCR's ANTENNA IN jack.

2

Use an RF coaxial cable (supplied) to connect the TV OUT jack on the VCR to the IN jack on the Cable Box/DBS.

3

Use a second RF coaxial cable to connect the OUT jack on the Cable Box/DBS to the TV's ANTENNA IN jack.

Recording One Channel/Watching Another

1

Put the Cable Box/DBS on the same channel as the VCR's CH3/CH4 switch. Set the TV to the Cable Box/DBS output channel (03 or 04).

Then, with the VCR in VCR position (the VCR light will appear on the display panel), use the CH(annel) ▲/▼ button to select the channel you want to record at the VCR. Start the recording.

2

Press the VCR/TV button once to put the VCR in TV position. (The VCR light will disappear.)

3

Select the channel you want to watch at the Cable Box/DBS.

Helpful Hint

- When you play a tape, make sure the Cable Box/DBS is set to the same channel as the CH3/CH4 switch on the VCR. Set the TV to the Cable Box/DBS output channel (03 or 04).

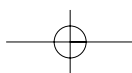

10 Turning on Your VCR

- Before turning on your VCR, make sure there are batteries in the remote control and the VCR, TV, and Cable Box/DBS (if applicable) are connected.
- The menu will continue to appear every time you turn on the VCR until you complete the steps on pages 10-11.
- If you want to set up the Controller now, you must first connect the Controller. See page 50 before continuing.
- Leave the Cable Box turned on if you plan to set up the Cable Box Controller now.
- If you plan to set up the Controller now, set the Cable Box to a channel other than channel 09.
- Read through these steps before you begin; the process will be easier if you familiarize yourself with this information before beginning.

1
Press the VCR button, then press the POWER button.

2
Turn on the TV. Set it to channel 3 or 4, whichever channel the CH3/CH4 switch on the back of the VCR is set to (or your Cable Box/DBS output channel, if applicable). The menu shown below will appear.

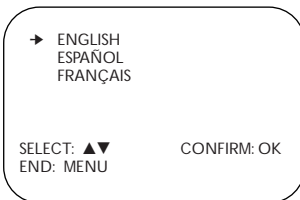

3
Press the PLAY ▲ or STOP ▼ button to select the language of the on-screen displays and menus.

4
Press the OK/STATUS button. The menu shown below will appear.

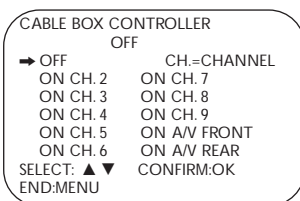

2 Turn on the TV.

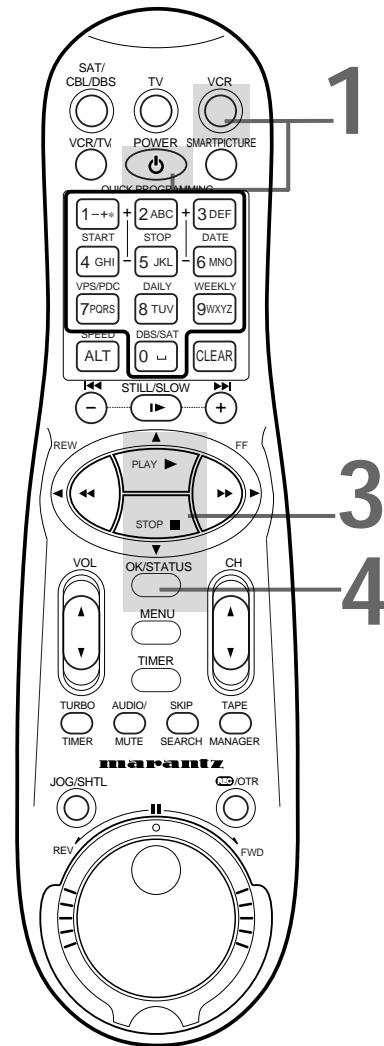

Helpful Hints

- Auto or -- : -- may appear on the display panel until the clock is set.
- If you do not want to set up channels now, press the MENU button at step 6. TUNER NOT SET will appear on the screen briefly.
- You may not set up channels at step 6 if you are using a Cable Box/DBS.

Turning on Your VCR (cont'd) 11

5

If you do not want to set up the Cable Box Controller now, press the OK/STATUS button to leave the Controller turned OFF. The display shown below will appear on the screen. Proceed to step 6. You may set up the Controller later by following the instructions on pages 50-54.

If you do want to set up the Cable Box Controller now, follow steps 5-8 on pages 51-52 now.

CONNECT ANTENNA OR CABLE
TO VCR FOR AUTO CH. SET

READY: OK
END: MENU

6

Press the OK/STATUS button to begin automatic channel setup. AUTO CH. SET PROCEEDING PLEASE WAIT will appear on the screen. The VCR will memorize all of the channels you receive, so when you scan through channels using the CH(annel) ▲/▼ button, you'll only scan through channels that you receive.

7

When channels are set up, AUTO CH. SET COMPLETED will appear on the screen briefly.

7

Wait for the VCR to set up channels.

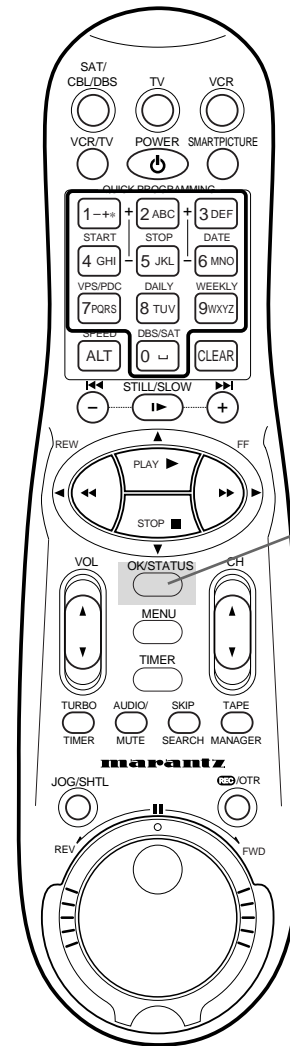

12 Automatic Channel Setup

Although your VCR may automatically memorize the channels you receive when you turn it on for the first time, this function lets you set up channels again. Make each entry within one minute of the previous entry.

1

Press the **VCR** button, then press the **MENU** button.

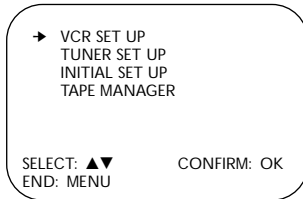

2

Press the **PLAY ▲** or **STOP ▼** button to select **TUNER SET UP**, then press the **OK/STATUS** button.

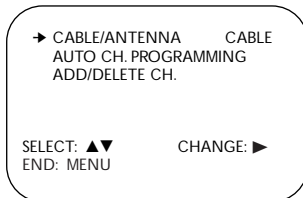

3

Press the **FF ►** button repeatedly so that **ANT** (if you have an antenna) or **CABLE** (if you have a cable connection) appears beside **CABLE/ANTENNA**.

4

Press the **STOP ▼** button to select **AUTO CH. PROGRAMMING**, then press the **OK/STATUS** button. **AUTO CH. SET PROCEEDING PLEASE WAIT** and a scale that shows the progress of channel setup will appear on the screen. The VCR will memorize all the channels you receive.

5

Wait for a few minutes while the VCR sets up channels. When programming is complete, **AUTO CH. SET COMPLETED** will appear on the screen. Then, the programming of the lowest channel number placed in the VCR's memory will appear on the screen. Now when you press the **CH(annel) ▲/▼** button, you will scan only through channels you receive.

5

Wait for the VCR to set up channels.

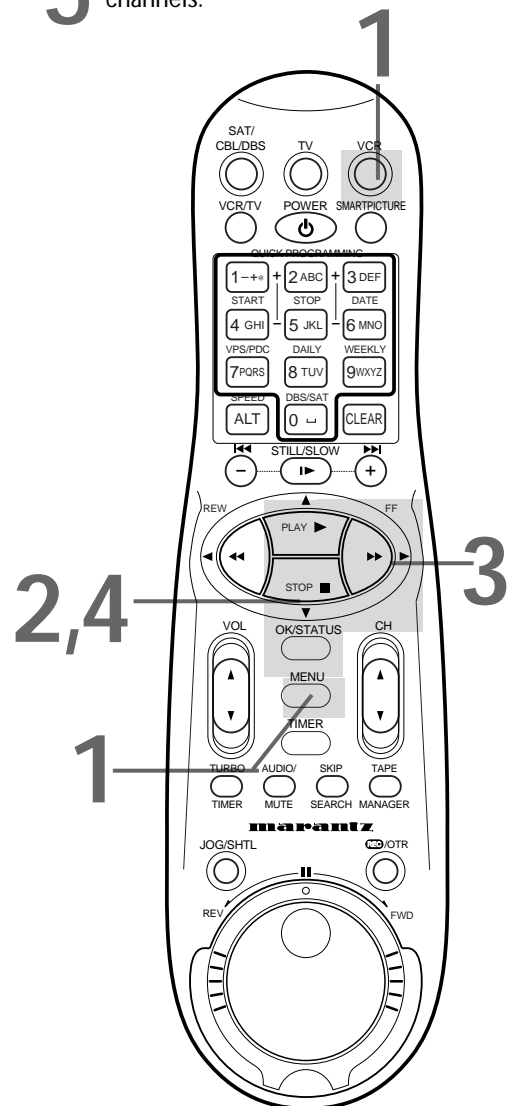

Helpful Hints

- The two Line Input modes will always be stored in the VCR's memory at channel 00. To select **A/V IN FRONT** or **A/V IN REAR**, press 0, 0 so that **A/V IN** appears briefly, then press the **CH(annel) ▲/▼** button so that **A/V IN FRONT** or **A/V IN REAR** appears on the screen briefly. To exit Line Input mode, use the **CH(annel) ▲/▼** button to select a channel other than 00.
- The VCR may automatically set **CABLE** or **ANT** even if you do not select it.

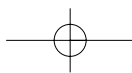

Automatic Channel Setup (cont'd) 13

Adding/Deleting Channels

1

Press the **VCR** button, then press the **MENU** button.

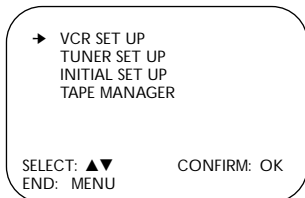

2

Press the **PLAY ▲** or **STOP ▼** button to select **TUNER SET UP**, then press the **OK/STATUS** button.

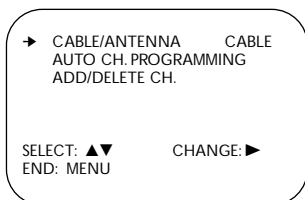

3

Press the **PLAY ▲** or **STOP ▼** button to select **ADD/DELETE CH.**, then press the **OK/STATUS** button.

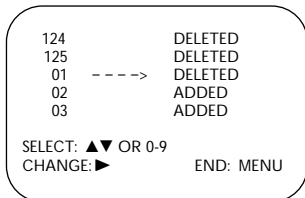

4

Use the **Number** buttons, the **CH(annel) ▲/▼** button, or the **PLAY ▲** or **STOP ▼** buttons to select the channel you want to add or delete. An arrow will appear beside the selected channel.

5

Press the **FF ►** button so that **DELETED** or **ADDED** appears beside the channel number.

6

Press the **MENU** button. Programming of the last channel you added or deleted will appear on the screen.

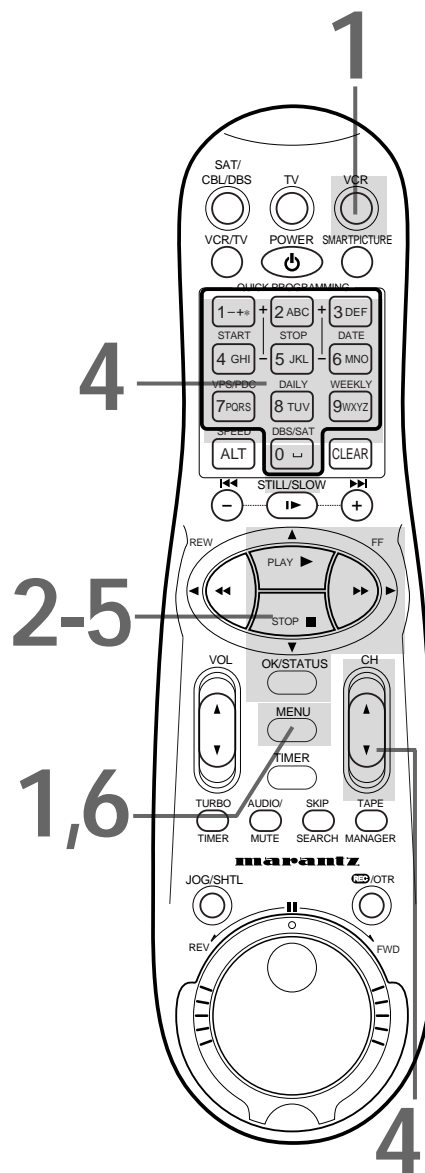

14 Setting the Clock

There are four ways to set the VCR's clock: Manually, with Time Zone Selection, with Manual PBS Channel Selection, or with Automatic PBS Channel Selection. Cable Box/DBS users must set the clock manually. Before you set the clock, make sure:

- The VCR power is on.
 - The VCR light appears on the display panel. If it does not, press the VCR/TV button once.
 - Channels are set up. *Details are on page 12.*
 - You make each entry within one minute of the previous entry.
- To set the clock manually, follow the steps on pages 14-15. To use Time Zone Selection, go to page 16. To use Manual PBS Channel Selection, go to page 17. To use Automatic PBS Channel Selection, go to page 18.

Manual Clock Setting

1

Press the VCR button, then press the MENU button.

→ VCR SET UP
TUNER SET UP
INITIAL SET UP
TAPE MANAGER

SELECT: ▲▼ CONFIRM: OK
END: MENU

2

Press the PLAY ▲ or STOP ▼ button to select INITIAL SET UP, then press the OK/STATUS button.

→ CLOCK LANGUAGE ENGLISH
VCR PLUS+ CH.
CABLE BOX
DBS RECEIVER

SELECT: ▲▼ CONFIRM: OK
END: MENU

3

Press the PLAY ▲ or STOP ▼ button to select CLOCK, then press the OK/STATUS button. CABLE BOX USERS SET CLOCK MANUALLY will appear briefly.

TIME --:-- AM
DATE 01/01/00

AUTO CLOCK ON
PBS CH. AUTO
D.S.T. AUTO
TIME ZONE AUTO

SET: ▲▼ NEXT: OK
END: MENU

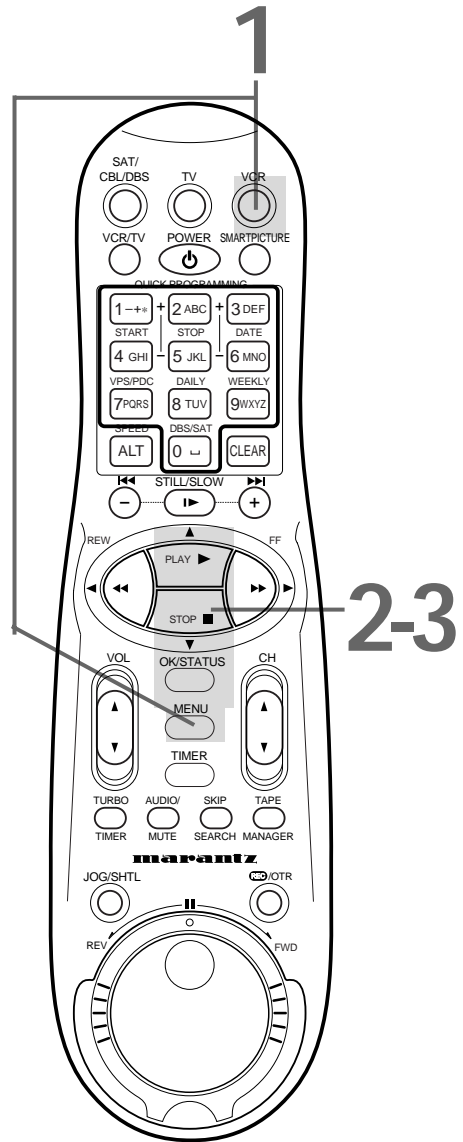

Helpful Hints

- To program the VCR so its clock will automatically move forward one hour in April and turn back one hour in October, see page 19.
- To make corrections, follow steps 1-3, then press the OK/STATUS button until the item you want to correct is flashing. Press the PLAY ▲ or STOP ▼ button to enter the correct information. When you are finished, press the MENU button.
- The menu may appear differently at step 3 if you are using a Controller or a Cable Box/DBS.

Setting the Clock (cont'd) 15

4

Press the **PLAY ▲** or **STOP ▼** button repeatedly to set the **TIME**. Every time you press the **PLAY ▲** or **STOP ▼** button, the time changes in one-minute increments. If you press and hold the **PLAY ▲** or **STOP ▼** button, the time changes in 30-minute increments.

When the time is correct, press the **OK/STATUS** button.

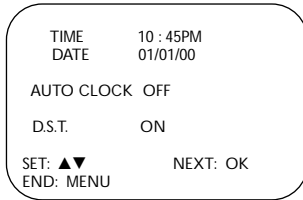

5

Press the **PLAY ▲** or **STOP ▼** button repeatedly to set the **DATE (month and day)**. Every time you press the **PLAY ▲** or **STOP ▼** button, the day changes in one-day increments. If you press and hold the **PLAY ▲** or **STOP ▼** button, the day changes in 15-day increments.

When the month and day are correct, press the **OK/STATUS** button.

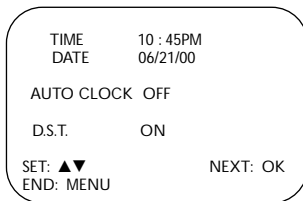

6

Press the **PLAY ▲** or **STOP ▼** button repeatedly to set the **YEAR**. When the year is correct, press the **OK/STATUS** button. The day of the week will appear automatically.

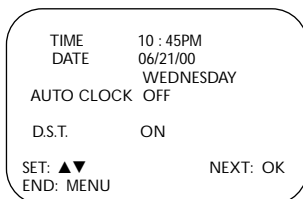

7

Press the **OK/STATUS** button once again to skip "AUTO CLOCK" and go to "D.S.T." (Daylight Savings Time). Press the **PLAY ▲** or **STOP ▼** button to set D.S.T. to **ON** or **OFF**. If **AUTO CLOCK** is **OFF**, you may set D.S.T. to **ON** or **OFF** only. For more information, please see page 19.

8

Press the **MENU** button.

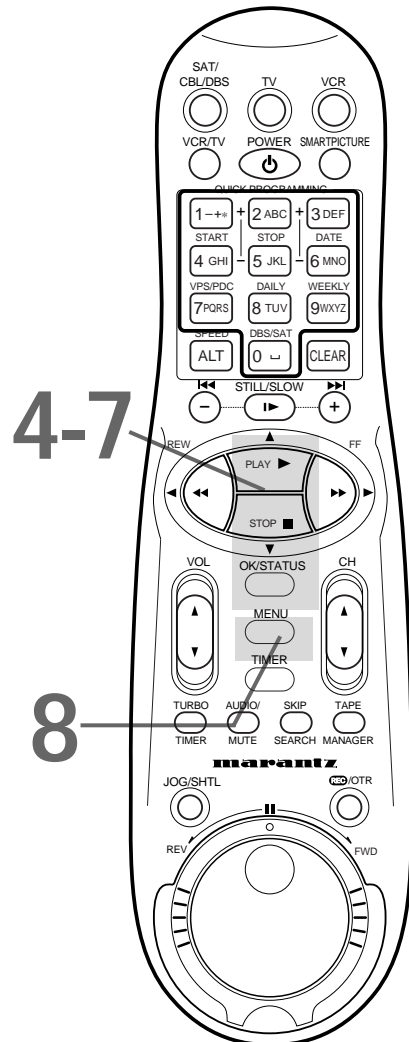

16 Setting the Clock (cont'd)

Time Zone Selection

1

Press the VCR button, then press the MENU button.

2

Press the PLAY ▲ or STOP ▼ button to select INITIAL SET UP, then press the OK/STATUS button.

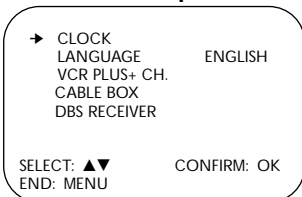

3

Press the PLAY ▲ or STOP ▼ button to select CLOCK, then press the OK/STATUS button. CABLE BOX USERS SET CLOCK MANUALLY will appear briefly.

(If AUTO CLOCK is set to OFF, TIME ZONE will not be available in the menu. If this happens, press the OK/STATUS button to select AUTO CLOCK, then press the PLAY ▲ or STOP ▼ button to set AUTO CLOCK to ON.)

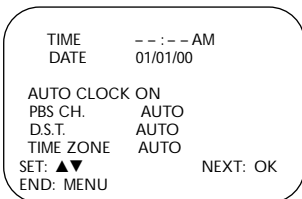

4

Press the OK/STATUS button repeatedly to select TIME ZONE.

5

Press the PLAY ▲ or STOP ▼ button repeatedly to select your Time Zone, then press the OK/STATUS button.

6

Press the MENU button.

7

An on-screen message will ask you to turn off the VCR.

Press the POWER button to turn off the VCR.

Auto will flash in the display panel until the clock is set. Leave the VCR turned off until the time appears on the display panel.

If --:-- appears on the display panel after you turn off the VCR, the VCR could not find the time. Use a different method to set the clock.

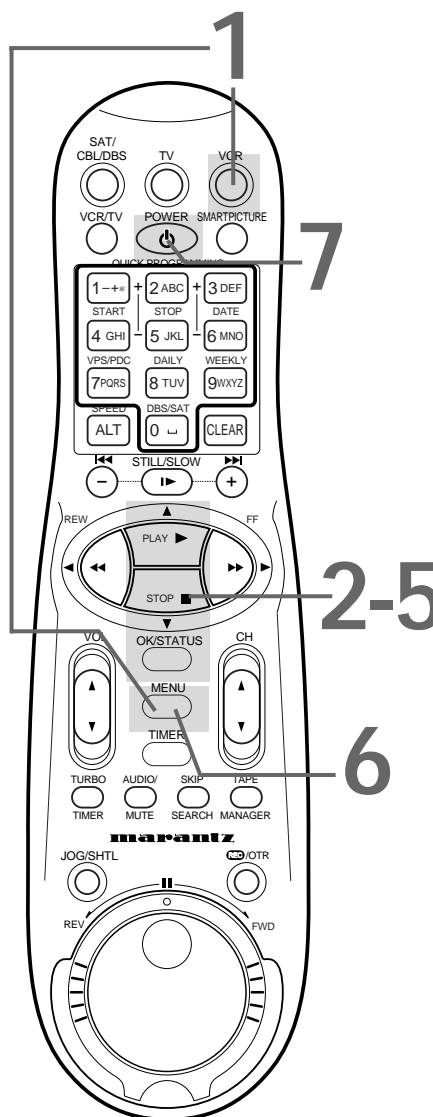

Helpful Hints

- When the power plug is connected to an AC outlet, the correct time will appear on the display panel of the VCR when the power is off.
- Press the OK/STATUS button repeatedly to make the time appear on the display panel when the VCR power is on.

Setting the Clock (cont'd) 17

Manual PBS Channel Selection

1

Press the **VCR** button, then press the **MENU** button.

2

Press the **PLAY ▲** or **STOP ▼** button to select **INITIAL SET UP**, then press the **OK/STATUS** button.

3

Press the **PLAY ▲** or **STOP ▼** button to select **CLOCK**, then press the **OK/STATUS** button. (If **AUTO CLOCK** is set to **OFF**, **PBS CH.** will not be available in the menu. If this happens, press the **OK/STATUS** button to select **AUTO CLOCK**, then press the **PLAY ▲** or **STOP ▼** button to set **AUTO CLOCK** to **ON**.)

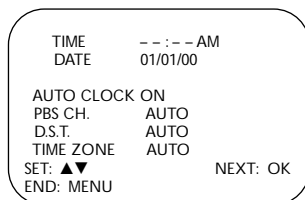

4

Press the **OK/STATUS** button repeatedly to select **PBS CH.**

5

Press the **PLAY ▲** or **STOP ▼** button repeatedly to select the station number of your PBS channel.

6

Press the **MENU** button.

7

An on-screen message will ask you to turn off the **VCR**.

Press the **POWER** button to turn off the **VCR**.

Auto will flash in the display panel until the clock is set. Leave the **VCR** power off until the clock is set.

If --:-- appears on the display panel after you turn off the **VCR**, the **VCR** could not find the time. Repeat steps 1 - 6 above, entering a different **PBS** channel at step 5. Or, use a different method to set the clock.

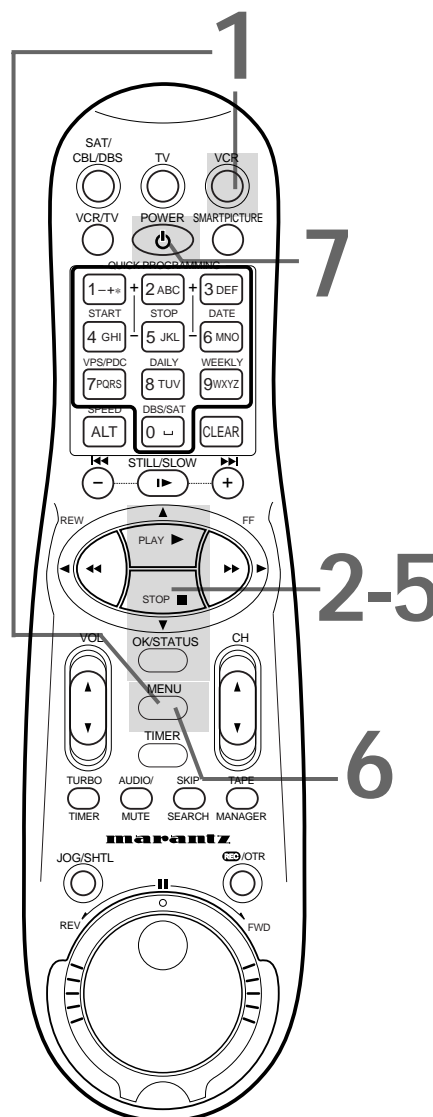

18 Setting the Clock (cont'd)

Automatic PBS Channel Selection

1

Press the **VCR** button, then press the **MENU** button.

2

Press the **PLAY** ▲ or **STOP** ▼ button to select **INITIAL SET UP**, then press the **OK/STATUS** button.

3

Press the **PLAY** ▲ or **STOP** ▼ button to select **CLOCK**, then press the **OK/STATUS** button. (If **AUTO CLOCK** is set to **OFF**, **PBS CH.** will not be available in the menu. If this happens, press the **OK/STATUS** button to select **AUTO CLOCK**, then press the **PLAY** ▲ or **STOP** ▼ button to set **AUTO CLOCK** to **ON**.)

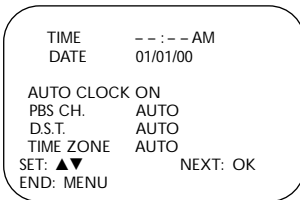

4

Press the **OK/STATUS** button repeatedly to select **PBS CH.**

5

Press the **PLAY** ▲ or **STOP** ▼ button repeatedly so that **AUTO** flashes beside **PBS CH.**

6

Press the **MENU** button.

7

An on-screen message will ask you to turn off the **VCR**. Press the **POWER** button to turn off the **VCR**.

Auto will flash in the display panel until the clock is set. Leave the **VCR** power off until the clock is set. If --:-- appears on the display panel after you turn off the **VCR**, the **VCR** could not find the time. Use a different method to set the clock.

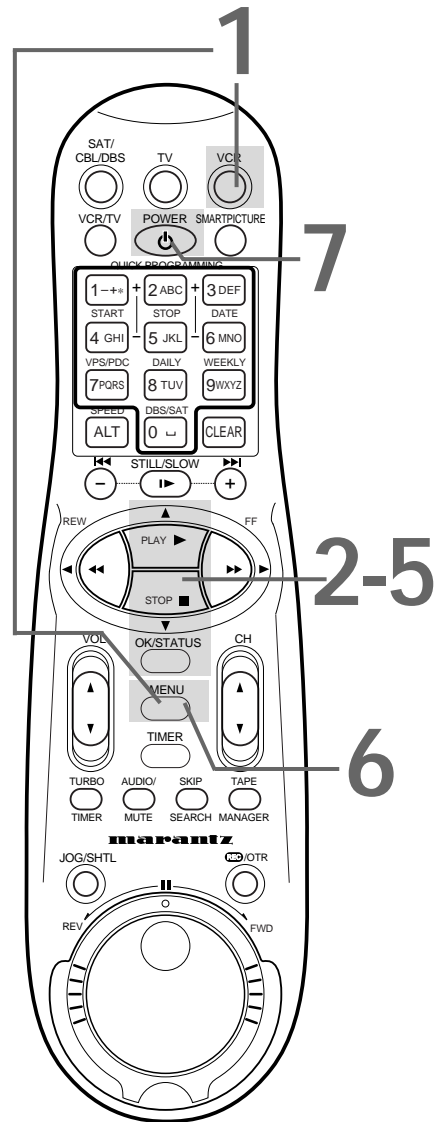

Helpful Hints

- To display the time on the display panel, press the **OK/STATUS** button repeatedly.
- If you live near the boundary of an adjacent time zone, your **PBS channel** may come from a different time zone. Use **Time Zone Selection** to set your clock. Details are on page 16.

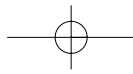

Daylight-Savings Time 19

Follow the steps below to program the VCR so its clock will move forward one hour in April and turn back one hour in October.

1

Press the VCR button, then press the MENU button.

2

Press the PLAY ▲ or STOP ▼ button to select INITIAL SET UP, then press the OK/STATUS button.

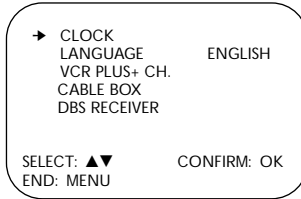

3

Press the PLAY ▲ or STOP ▼ button to select CLOCK, then press the OK/STATUS button. (If AUTO CLOCK is set to OFF, PBS CH. and TIME ZONE will not appear in the menu.) CABLE BOX USERS SET CLOCK MANUALLY will appear on the screen briefly.

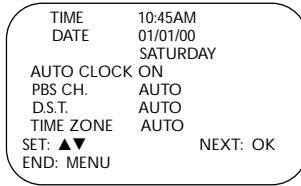

4

Press the OK/STATUS button repeatedly to select D.S.T.

5

Press the PLAY ▲ or STOP ▼ button so that ON, OFF, or AUTO appears beside D.S.T.

Select ON to make the clock adjust itself according to the VCR's calendar. Select OFF to turn off the feature. Select AUTO to make the clock adjust itself according to the signal it receives from the PBS channel. If AUTO CLOCK is set to OFF, you may only set D.S.T. to ON or OFF.

6

Press the MENU button.

7

An on-screen message may ask you to turn off the VCR. Press the POWER button to turn off the VCR. Auto will flash in the display panel until the clock is set. Leave the VCR power off until the clock is set. If -- : -- appears on the display panel after you turn off the VCR, the VCR could not find the time. Use a different method to set the clock.

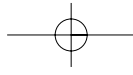
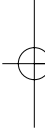
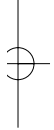
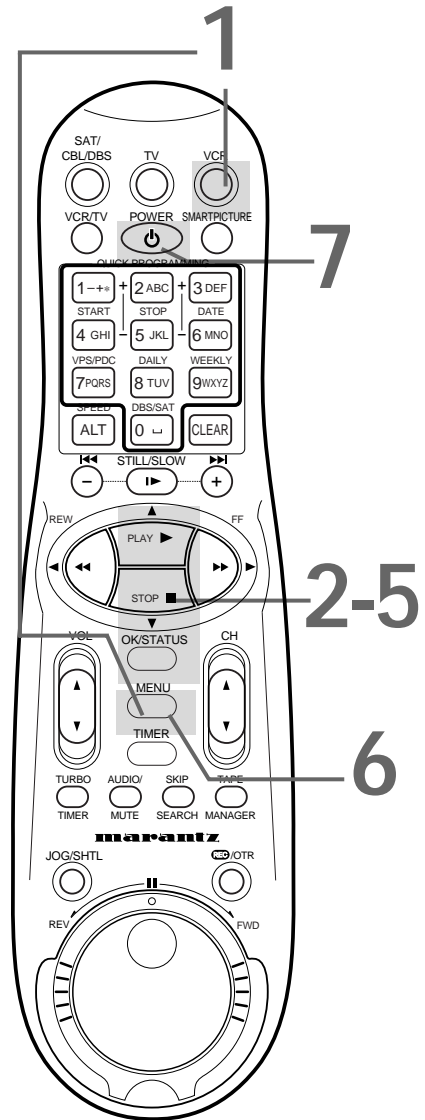

20 Language Selection

Follow the steps below to change the language of the on-screen displays and menus.

1

Press the VCR button, then press the MENU button.

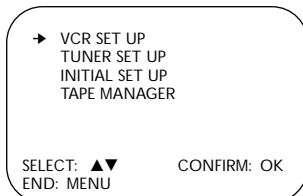

2

Press the PLAY ▲ or STOP ▼ button to select INITIAL SET UP, then press the OK/STATUS button.

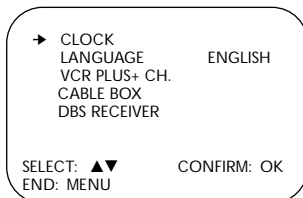

3

Press the PLAY ▲ or STOP ▼ button to select LANGUAGE.

4

Press the FF ► button repeatedly until your preferred language appears.

5

Press the MENU button.

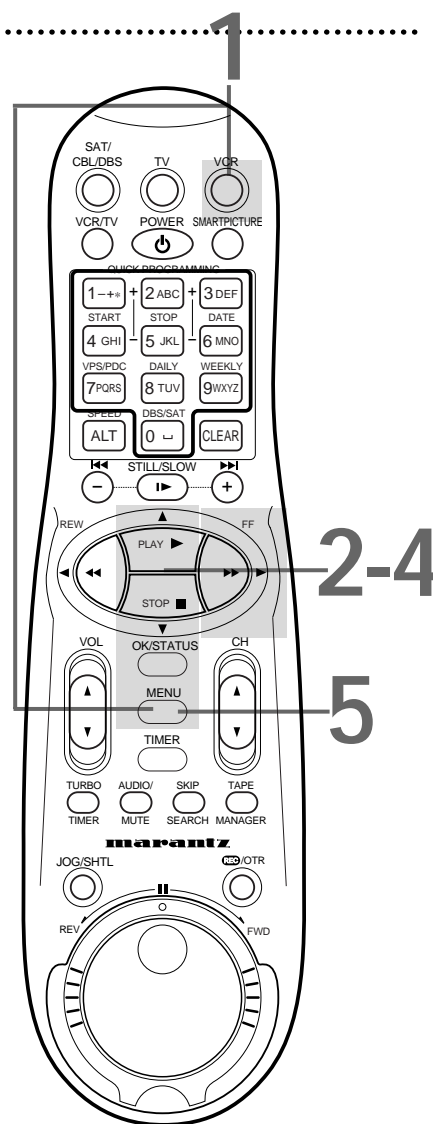

Helpful Hint

- If you accidentally select Spanish or French and need English, follow these steps.
 - 1) Press the VCR button, then press the MENU button.
 - 2) Press the PLAY ▲ or STOP ▼ button to select SISTEMA INICIAL or PROGRAMM. INITIALE, then press the OK/STATUS button.
 - 3) Press the PLAY ▲ or STOP ▼ button to select LENGUAJE or LANGUE.
 - 4) Press the FF ► button repeatedly so that the English menu appears.

Display Panel 21

VCR Display Panel

Information about VCR operations appears here. Different information appears at different times. The display is brighter when the VCR power is on. The display dims automatically when you turn off the VCR power.

Cassette Compartment

Insert a tape here.

TIMER Light

This light appears when a timer recording is programmed or is in progress. *Details are on pages 38-44.* This light blinks rapidly if the VCR is turned off to set a Timer Recording but a tape is not in the VCR.

Audio Level indicator

This indicates the audio playback levels. NORM appears only when MONO is selected. *Details are on page 57.*

TURBO TIMER indicators

These indicate the START time and STOP time when you are setting a TURBO TIMER. *Details are on page 44.*

Remaining Tape Time Indicator

This indicates that the remaining tape time currently appears on the display panel.

Cassette-Inside Light

This light appears when a tape is in the VCR. It blinks when a tape is being ejected. This light blinks rapidly if the VCR is turned off to set a Timer Recording but there is not a tape in the VCR.

Operation indicators

These indicators tell you the current operation of the VCR.

- ▷: Play, Forward and Reverse Searching
- : Record
- ||: Record Pause
- ▷||: Still Picture
- ⊗: Audio Dubbing
- ⊗||: Audio Dubbing Pause

S-VHS Indicator

Appears while playing a tape recorded in S-VHS or S-VHS ET format, or while recording on an S-VHS tape or in S-VHS ET format.

Tape Speed Lights

These lights indicate the current tape speed. This VCR will play tapes recorded in LP speed, but LP will not appear on the display panel. This VCR will not record in LP speed. *Details are on pages 41 and 77.*

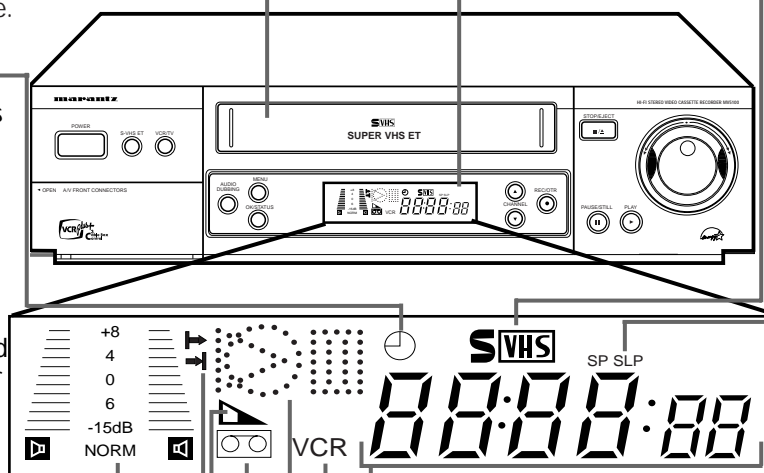

Clock/Counter/Remaining Tape Time/Channel Display

Each time you press the OK/STATUS button, information on the display panel will change. When tape playback is stopped, press the OK/STATUS button repeatedly to see: the current time (when the clock is set); the real-time counter; remaining tape time; and the current channel number. During tape playback, press the OK/STATUS button repeatedly to see the real-time counter, the remaining tape time or the current time.

If CL is flashing beside the clock when the VCR power is off, Child Lock is activated. *Details are on page 74.*

Line Input Mode

When L-F appears on the display panel, you have selected A/V IN FRONT. Your audio and video or S-Video cables should be connected to the AUDIO/VIDEO In or AUDIO/S-VIDEO In jacks on the front of the VCR if you are dubbing tapes.

When L-1 appears here, you have selected A/V IN REAR. Your audio and video or S-Video cables should be connected to the AUDIO/VIDEO IN or AUDIO/S-VIDEO IN jacks on the back of the VCR if you are dubbing tapes. To select A/V IN FRONT or A/V IN REAR, press 0, then press the CH(annel) ▲/▼ button so that A/V IN FRONT or A/V IN REAR appears on the screen.

To exit Line Input mode, press the Number buttons or the CH(annel) ▲/▼ button to select another channel. *Details are on page 48.*

TURBO TIMER Mode

Turbo Timer information appears here. *Details are on page 44.*

VCR Light

This light appears when the VCR is in VCR position.

22 Front Panel

POWER Button

Press to turn the VCR power on and off.

VCR/TV Button

Press to select the signal that your TV receives.

VCR Position:

Use to watch a tape, to watch a program while recording it, or to watch a TV broadcast using the CH(annel) ▲/▼ or Number buttons to change channels at the VCR. The VCR light will appear on the display panel when the VCR is in VCR position.

TV Position:

Use to watch TV (changing channels at the TV) or to watch one program while recording another. *Details are on page 33.* The VCR light will not appear on the display panel when the VCR is in TV position.

S-VHS ET Button

Press to select S-VHS ET recording mode. The lamp (the button itself) will lit. S-VHS ET allows recording with S-VHS picture quality on VHS cassettes. *Details are on page 32.*

Remote Sensor

Receives a signal from your remote control so you can operate your VCR from a distance. Press the VCR button on the remote control before pressing other VCR operation buttons.

PAUSE/STILL Button

During tape playback, press once to freeze the picture. Press repeatedly to advance the Still picture frame by frame. During tape playback, press and hold for three seconds to start Slow Motion playback. *Details are on page 62.* During recording, press to temporarily stop the recording. *Details are on page 30.*

STOP/EJECT Button

Press once to stop the tape. When tape playback is stopped, press to eject the tape.

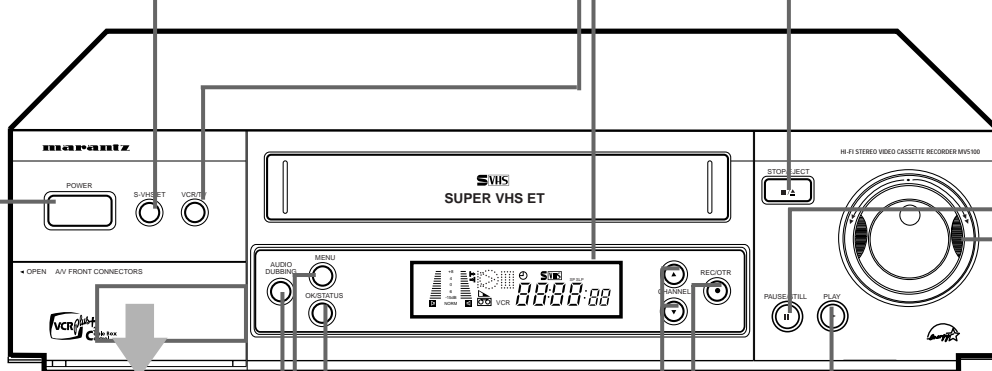

* Pull the door to access the jacks.

*S-VIDEO Input Jack

Use an S-Video audio cable to connect to the S-Video output jack on another VCR or camcorder.

*VIDEO Input Jack

Use a video cable to connect this jack to the video output jack on another VCR or camcorder.

*AUDIO Input Jacks

Use audio cables to connect this jack to the audio output jacks on another VCR or camcorder.

AUDIO DUBBING Button

Replaces the normal audio sound of a previously recorded tape with a new soundtrack, using an audio component. *Detail are on page 49.*

MENU Button

Press to access or remove the VCR menu.

OK/STATUS Button

Press to go to the next VCR menu. Press to see the status display. *Details are on page 26.* Press repeatedly to see the real-time counter, remaining tape time, the current channel, or the current time on the display panel. *Details are on page 21.*

CHANNEL ▲/▼ Buttons

Press to scan through the VCR's channels. During tape playback, press to manually adjust the tracking. *Details are on page 76.* Press to select an item in the VCR menu.

REC(ord)/OTR Button

Press once to record. *Details are on page 30.* Press repeatedly to start a One-Touch Recording. *Details are on page 33.*

PLAY Button

Press to play a tape. Press to release Slow, Still or Search mode and return to normal playback. *Details are on page 62.*

Jog Dial/Shuttle Ring

Turn the Jog Dial for frame by frame tape playback. Turn the Shuttle Ring in either direction for forward or reverse searching of a tape. *Details are on page 63.*

When using the menus, turn the Shuttle Ring to the right to change the setting of a menu item, or to the left to return to a previous menus.

Rear Panel 23

ANTENNA IN Jack

Connect your antenna or cable here. *Details are on pages 6-9.*

CABLE BOX Jack

Connect the Controller here. You may use the Controller with either a Cable Box or DBS receiver. *Details are on pages 50-54.*

VIDEO IN Jack

Connect a video cable coming from the VIDEO OUT jack of a camcorder, a Cable Box/DBS, or another VCR here. *Details are on pages 35 and 48.*

VIDEO OUT Jack

Connect a video cable going to the VIDEO IN jack of a camcorder or another VCR here. *Details are on pages 48 and 56.*

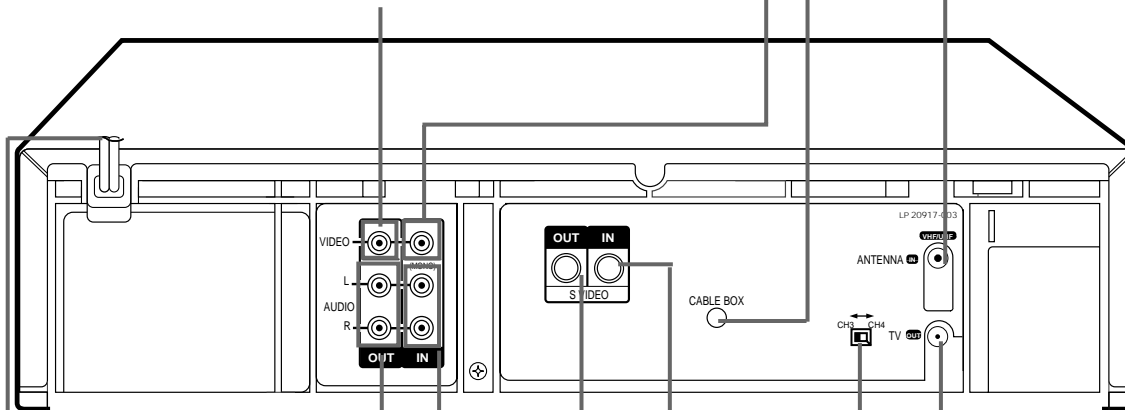

AUDIO OUT Jacks

Connect audio cables going to the AUDIO IN jacks of a camcorder, another VCR, or an audio system here. *Details are on pages 48 and 56.*

AUDIO IN Jacks

Connect audio cables coming from the AUDIO OUT jacks of a camcorder, another VCR, a Cable Box/DBS, or an audio source here. *Details are on pages 35 and 48.*

S-VIDEO OUT Jack

Connect an S-Video cable going to the S-VIDEO In jack of a TV here. You may use S-Video connections instead of the standard RCA-style video (yellow) connections. S-Video connections provide a better picture.

S-VIDEO IN Jack

Connect an S-Video cable coming from the S-VIDEO OUT jack of a camcorder or another VCR here.

AC Power Cord

Connect to a wall outlet (120V) to supply power to the VCR.

TV OUT Jack

Use the supplied RF coaxial cable to connect this jack to the ANTENNA IN Jack on your TV or to the IN Jack on your Cable Box/DBS (if applicable). *Details are on pages 6-9.*

CH3/CH4 Switch

Set to channel 3 or 4 to use your TV with your VCR. Set your TV to the same channel. *Details are on pages 6-9.*

24 Remote Control Buttons

TV Button

Press this button before pressing other TV operation buttons.

PLAY ▲ Button

When operating the VCR, press to play a tape. Also, press to release Slow, Still, or Search mode and to return to normal playback. *Details are on page 62.* Press to select an item in the VCR menu.

For some PHILIPS or PHILIPS MAG-NAVOX TVs only:

After pressing the TV button, press this button to select an item in the TV menu.

REW(ind)◀ Button

When tape playback is stopped, press to rewind the tape at high speed. During tape playback, press to rewind the tape while the picture stays on the screen. *Details are on page 62.* When operating the VCR, press to return to a previous menu.

For some PHILIPS or PHILIPS MAG-NAVOX TVs only:

After pressing the TV button, press this button to adjust an item in the TV menu.

OK/STATUS Button

Press to go to the next item on the VCR menu or to the next menu. Press to see the status display for five seconds. *Details are on page 26.* When tape playback is stopped, press repeatedly to see the current channel, the current time, the real-time counter, or the remaining tape time on the display panel. During tape playback, press repeatedly to see the current time, the real-time counter, or the remaining tape time on the display panel.

For some PHILIPS and PHILIPS MAG-NAVOX TVs only:

Press the TV button, then press this button to access the TV on-screen displays or to exit the TV menu. *For some other manufacturers' TVs or Cable Box/DBS:*

After pressing the TV or SAT/CBL/DBS button, the OK/STATUS button will function as an ENTER button at the TV or Cable Box/DBS.

VOL(ume) ▲/▼ Button

Press to increase or decrease the TV's volume.

Helpful Hint

- The glow-in-the-dark buttons that are shaded in the illustration are helpful when using the remote control in dark rooms.

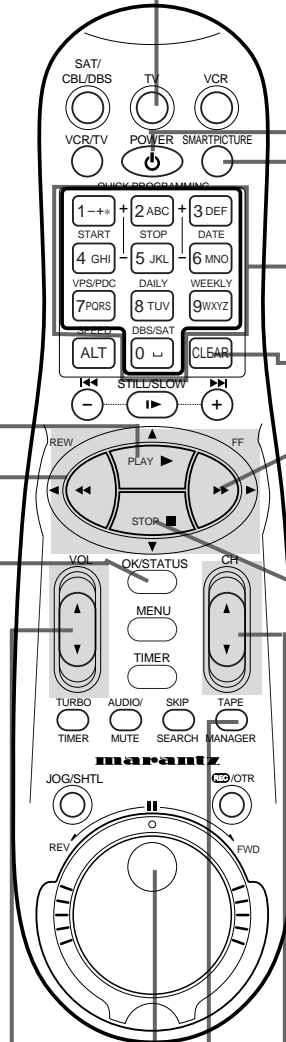

POWER Button

After pressing the SAT/CBL/DBS, VCR, or TV button, press to turn on or off the Cable Box/DBS, VCR, or TV. Press and hold to set Child Lock. *Details are on page 74.*

SMARTPICTURE Button

Press to select the SmartPicture mode. *Details are on page 59.*

Number Buttons

After pressing the SAT/CBL/DBS, TV, or VCR button, press to select a channel at the Cable Box/DBS, TV, or VCR. Press to enter characters in the "EDIT TITLE" screen. *Details are on page 67.*

CLEAR Button

Press to reset the real-time counter to zero.

FF ▶ Button

When tape playback is stopped, press to advance the tape at high speed. During tape playback, press to advance the tape while the picture stays on the screen. *Details are on page 62.* When operating the VCR, press to change the setting of a menu item.

For some PHILIPS or PHILIPS MAG-NAVOX TVs only:

After pressing the TV button, press this button to adjust an item in the TV menu.

STOP ▼ Button

Press to stop the tape. When operating the VCR, press to select an item in the menu.

For some PHILIPS or PHILIPS MAG-NAVOX TVs only:

After pressing the TV button, press this button to select an item in the TV menu.

CH(annel) ▲/▼ Button

After pressing the SAT/CBL/DBS, TV, or VCR button, press to scan through the channels of the Cable Box/DBS, TV, or VCR.

TAPE MANAGER

Press to access the Tape Manager directory screen. *Details are on page 64.*

Jog dial

Turn this dial for frame by frame tape playback. The tape moves backward or forward frame by frame at the speed with which the dial is turned. *Details are on page 63.*

Remote Control Buttons (cont'd) 25

SAT/CBL/DBS Button

Press this button before pressing Cable Box/DBS operation buttons.

VCR/TV Button

After pressing the VCR button, press this button to select the signal that your TV receives.

- VCR Position

Use to watch a tape, to watch a program while recording it, or to watch a TV broadcast using the CH(annel) ▲/▼ or Number buttons to change channels at the VCR. The VCR light will appear on the display panel when the VCR is in VCR position.

- TV Position

Use to watch TV (selecting channels at the TV) or to watch one program while recording another. *Details are on page 33.* The VCR light will not appear when the VCR is in TV position.

After pressing the TV button, press this button to select TV mode or Auxiliary mode at some televisions.

ALT(ernate) (Channel)/SPEED Button

For some PHILIPS or PHILIPS MAGNAVOX TVs only:

After pressing the TV button, press to go back to the previously selected channel on the TV.

After pressing the VCR button, press to select the recording speed (SP or SLP). *Details are on pages 41 and 77.*

TURBO TIMER Button

Press to set a timer recording using Turbo Timer. *Details are on page 44.*

MENU Button

Press to access the main VCR menu.

Press again to remove the menu.

For some PHILIPS or PHILIPS MAGNAVOX TVs only:

After pressing the TV button, press this button to access the TV menu.

JOG/SHTL (Shuttle) Button

Press to use the Jog Dial or the Shuttle Ring on the remote control. The button will light for one minute. You may operate the jog dial or shuttle ring on the remote control only when the JOG/SHTL button is lit. *Details are on page 63.*

REC(ord)/OTR Button

Press once to start a recording. *Details are on page 30.* Or, press repeatedly to start a One-Touch Recording. *Details are on page 34.*

VCR Button

Press this button before pressing VCR operation buttons.

STILL/SLOW Buttons/Index Search (I◀◀/▶▶I) Buttons

While recording, press STILL/SLOW ▶▶ to temporarily stop the recording. Press a second time to resume normal recording. *Details are on page 30.* During tape playback, press STILL/SLOW ▶▶ once to freeze the picture. Press repeatedly to advance the Still picture frame by frame. *Details are on page 62.*

During tape playback, press and hold STILL/SLOW ▶▶ for more than three seconds to play the tape in slow motion. *Details are on page 62.*

When tape playback is stopped or during tape playback, press the I◀◀/▶▶I (STILL/SLOW -/+) buttons to search for index codes recorded on the tape. *Details are on page 61.*

TIMER Button

Press to access the timer recording menu. *Details are on pages 38-43 and 45.*

AUDIO/MUTE Button

Press the TV button, then press the AUDIO/MUTE button to eliminate the TV's sound. Press again to restore the sound. Or, press the VCR button, then press the AUDIO/MUTE button to select MONO or HIFI. *Details are on page 57.*

SKIP SEARCH Button

Press during tape playback to fast forward 30 seconds of a tape. This feature will only work with tape segments recorded in SP or SLP speed. *Details are on page 61.*

Shuttle Ring

Turn this ring in either direction for forward or reverse searching of a tape. The farther the ring is rotated, the faster the search speed. Releasing the ring stops the picture in the Still mode. *Details are on page 63.*

Helpful Hint

- This remote control may or may not operate your TV or Cable Box/DBS. Or, it may only work some features of this equipment. See pages 27-28 for details.

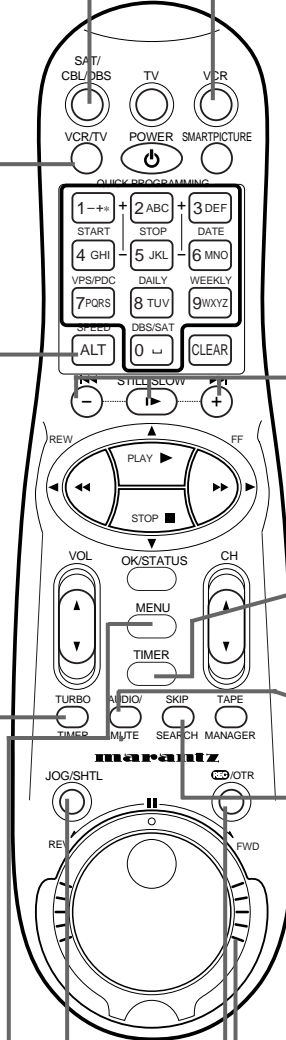

26 On-Screen Status Displays

An on-screen status display will appear when you press the OK/STATUS button or certain function buttons. The contents of the status display will vary; the status display describes the current operations of the VCR.

ON SCREEN MODE ON:

- Whenever you press the PLAY ▲ button or the STOP ▼ button, some of the contents of the status display will appear for five seconds.

ON SCREEN MODE COUNTER:

- The real-time counter will appear on the screen during normal tape playback and when playback is stopped. Whenever you press the PLAY ▲ button or the STOP ▼ button, some of the contents of the status display will appear for five seconds. After five seconds, only the counter will remain on the screen.

ON SCREEN MODE OFF:

- No status display will appear when you press function buttons or the OK/STATUS button.

To select a status display mode, follow these steps.

1

Press the VCR button, then press the MENU button.

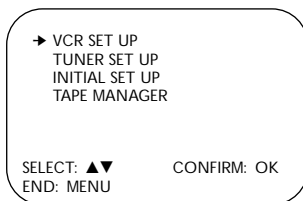

2

Press the PLAY ▲ or STOP ▼ button to select VCR SET UP, then press the OK/STATUS button.

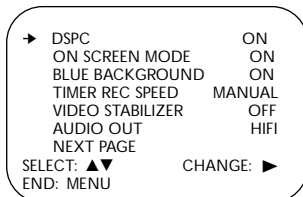

3

Press the PLAY ▲ or STOP ▼ button to select ON SCREEN MODE.

4

Press the FF ► button repeatedly so that ON, COUNTER, or OFF appears beside ON SCREEN MODE.

5

Press the MENU button.

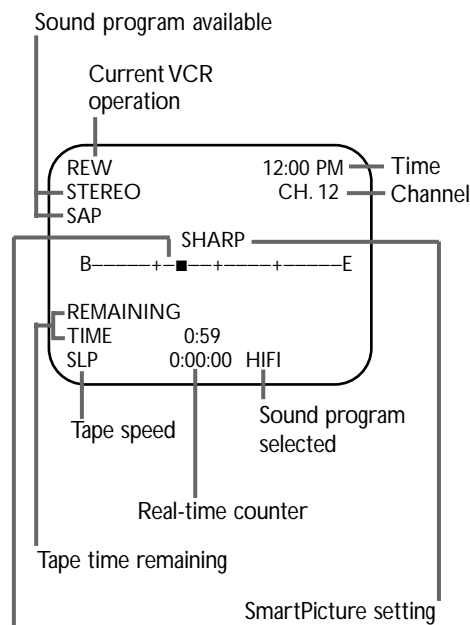

Current tape position (B is the beginning of the tape; E is the end of the tape. A flashing square indicates the current place you are at on the tape during fast forwarding or rewinding.)

Helpful Hints

- If ON SCREEN MODE is set to ON or COUNTER:
 - You may bring up the status display at any time by pressing the OK/STATUS button. (The exception is during Slow, Search, or Still mode.) The display will appear for about five seconds.
 - Channel numbers (if memorized by the VCR) will appear for a few seconds.
- When tape playback is stopped, press the OK/STATUS button repeatedly to see the current time, real-time counter, remaining tape time or current TV channel number on the display panel. During tape playback, press the OK/STATUS button repeatedly to see the current time, real-time counter or remaining tape time on the display panel. The current TV channel will not appear.
- Depending on the type of tape used, the remaining tape time may not appear right away, or may not be correct. Also, "-- : --" may appear, or the display may flash if the VCR is still calculating the remaining tape time.

Setting the Remote Control to Operate a TV 27

Your VCR remote control may operate your TV. Follow these steps to set the remote control code.

1

Point the remote control at your TV. Press the TV button, then press the POWER button. If your TV turns on or off, try the CH(annel) ▲/▼ button. If your remote control operates the TV, you're finished. If your TV doesn't turn on or off, or if the CH(annel) ▲/▼ button doesn't work, go to step 2.

2

Find the brand of your TV on the list below, and remember the two-digit number beside it.

TV CODES	
EMERSON14	RCA10
GOLDSTAR (LG)04	SAMSUNG18
HITACHI12	SANYO11
JVC05	SHARP16
MAGNAVOX01, 02, 03	SONY09
mitsubishi13	TOSHIBA08
PANASONIC07, 17	ZENITH06, 15
PHILIPS01	
PHILIPS MAGNAVOX	
.01, 02, 03	

3

While you press and hold the TV button, press two Number buttons to enter the two-digit code for your TV. For example, if you have a Zenith TV, press Number buttons 1, 5. Then, still holding the TV button, press the STOP ▼ button. Your TV may turn on or off automatically.

4

Repeat step 1. If the remote control works your TV, you're finished. If the remote control still doesn't work your TV, repeat steps 2-3, using a different code for your brand (if available).

2

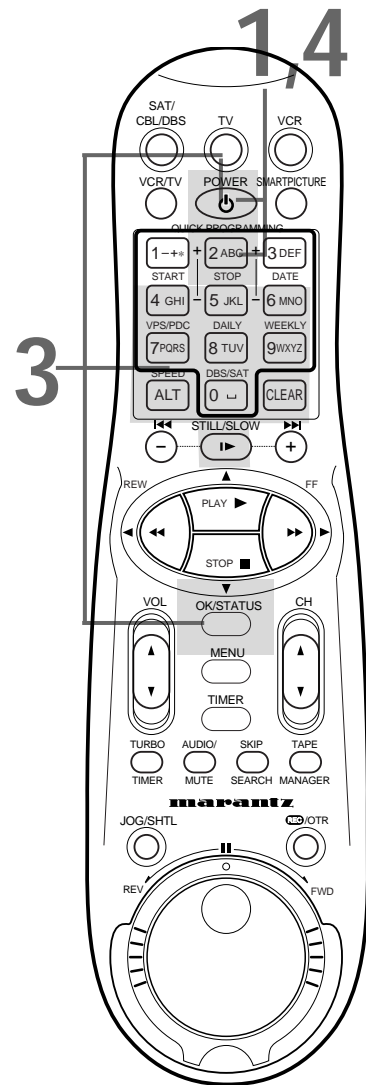
 Find the code for your TV.

Helpful Hints

- If you had to program the remote control to operate your TV, whenever you replace the batteries in the remote control, you will have to program the remote control again.
- There is no guarantee that the remote control will work your TV.
- The remote control may only operate some features of your TV.

28 Setting the Remote Control to Operate a Cable Box/DBS

Your VCR remote control may operate your Cable Box/DBS. Follow these steps to set the remote control code.

1

Turn on your Cable Box/DBS.

Point the remote control at your Cable Box/DBS. Press the **SAT/CBL/DBS** button, then press the **POWER** button. If your Cable Box/DBS turns off, turn on the power again and try the **CH(annel) ▲/▼** button. If the remote control operates the Cable Box/DBS, you're finished. If your Cable Box/DBS does not turn off, or if the **CH(annel) ▲/▼** button doesn't work, go to step 2.

2

Find the brand of your Cable Box/DBS on the list below and remember the two-digit number beside it.

CABLE BOX/DBS CODES	
ARCHER01, 05, 17	REGAL10, 18, 19, 23
CABLETENNA01, 17	REGENCY19
CABLEVIEW .15, 16, 17, 21, 25	REMBRANDT01, 16, 17
CITIZEN15, 16, 17, 21, 25	SAMSUNG05, 16, 24
CURTIS02, 08	SCIENTIFIC ATLANTA .02, 08
DIAMOND01, 17	SIGMA07, 20
EASTERN19	SL MARX . . .05, 16, 17, 24, 25
GC BRAND .15, 16, 17, 21, 25	SPRUCER13, 14
GEMINI15	STARGATE . . .05, 15, 16, 17,
GENERAL INSTRUMENTS21, 24, 25
.01, 04, 06, 11, 12, 15	TELEVIEW05, 16, 24
HAMLIN10, 18, 19, 23	TOCOM01, 04, 16
JASCO15	UNIKA01, 17
JERROLD	UNIVERSAL16, 17, 25
.01, 04, 06, 11, 12, 15	VIDEOWAY03, 09, 22
NOVAVISION02, 08	ZENITH03, 09, 22
OAK07, 20	
PANASONIC13, 14	MAGNAVOX DBS . . .42, 43
PULSAR . . .15, 16, 17, 21, 25	RCA DBS40
RCA13, 14	SONY DBS41

3

While you press and hold the **SAT/CBL/DBS** button, press two **Number** buttons to enter the two-digit code for your Cable Box/DBS. For example, if you have a Zenith Cable Box, press Number buttons 0, 3. Then, still pressing the **SAT/CBL/DBS** button, press the **STOP ▼** button. The Cable Box/DBS might turn off automatically.

4

Repeat step 1. If the remote control still does not work your Cable Box/DBS, repeat steps 2-3 using a different code for your brand, if available.

2

Find the code for your Cable Box/DBS.

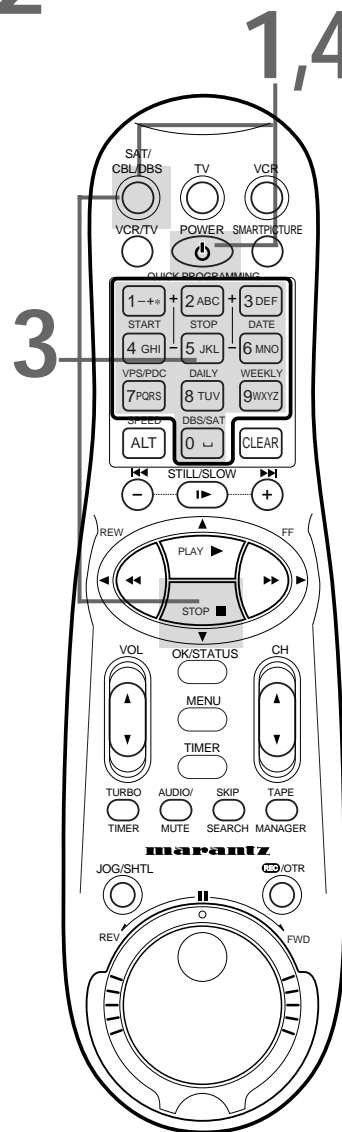

Helpful Hints

- If you had to program the remote control to operate your Cable Box/DBS, whenever you replace the batteries in the remote control, you must program the remote control again.
- The remote control may only operate some features of your Cable Box/DBS.
- Some Cable Boxes/DBSs can only be turned on at the Cable Box/DBS.
- There is no guarantee that the remote control will operate your Cable Box/DBS.

Playing 29

Read and follow the steps below to play a tape.

1

Turn on the TV and set it to channel 3 or 4, whichever channel the CH3/CH4 switch on the back of the VCR is set to.

2

Insert a tape in the VCR. The power will come on. The VCR will place itself in VCR position automatically (the VCR light will appear on the display panel of the VCR). If the VCR light does not appear, press the VCR button, then press the VCR/TV button once. If the tape's record tab has been removed, playback will start automatically.

3

If playback does not start automatically, press the VCR button, then press the PLAY ▲ button. The ▷ light will appear on the VCR display panel.

4

Press the STOP ▼ button to stop playback.

5

Press the REW(ind)◀ button to rewind the tape.

6

Press the STOP/EJECT button on the front panel to remove the tape.

1

 Turn on the TV.

2

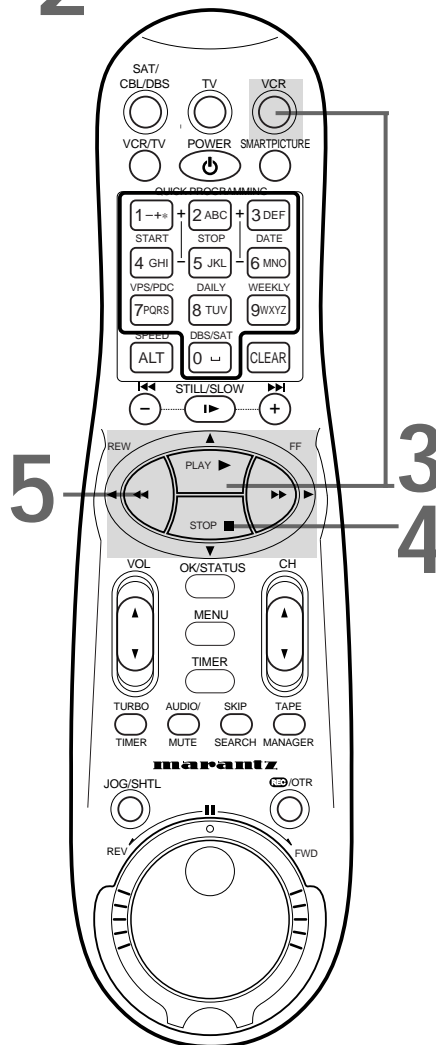
 Insert a tape.

Helpful Hints

- While " - - - " is blinking on the VCR display panel after insert a tape, the tape will run for a few seconds to search for the tape number. Details are on page 64.
- Playback options and features are on pages 55-63.
- This VCR is also equipped with Digital Studio Picture Control, which provides the highest possible recording and playback picture quality. "DSPC" may flash on the display panel after PLAY ▲ is pressed. Details are on page 60.
- The tape position indicator appears on the screen during rewinding or fast forwarding. Details are on page 26.

30 Recording

Read and follow the steps below to record a television program.

1

Turn on the TV and set it to channel 3 or 4, whichever channel the CH3/CH4 switch on the back of the VCR is set to.

2

Insert a tape with its record tab intact (details are on page 5) in the VCR. The power will come on.

3

Press the VCR button.

4

If the VCR light appears on the display panel of the VCR, go to step 5. If the VCR light does not appear, press the VCR/TV button once.

5

Press the ALT/SPEED button until the desired tape speed appears on the screen. The VCR will only record in SP or SLP. Details about tape speed are on pages 41 and 77.

6

Use the CH(annel) ▲/▼ button or the Number buttons to select the channel to be recorded.

7

Press the REC(ord)/OTR button to start recording. The ○ light will appear on the VCR display panel. If no tape is in the VCR, NO CASSETTE will appear on the screen briefly.

8

To pause the recording (for example, during commercials), press the STILL/SLOW ► button. The ○□□ light will appear on the display panel.

To resume recording, press the STILL/SLOW ► button again. The ○ light will appear on the display panel.

9

Press the STOP ▼ button to stop recording. The ○ light will disappear from the display panel.

10

Press the STOP/ EJECT button on the front panel to remove the tape. The tape number will be assigned and appears on the screen. Write the tape number on a label and affix the label to the tape for the Tape Manager. Details are on page 64-73.

1

 Turn on the TV.

2

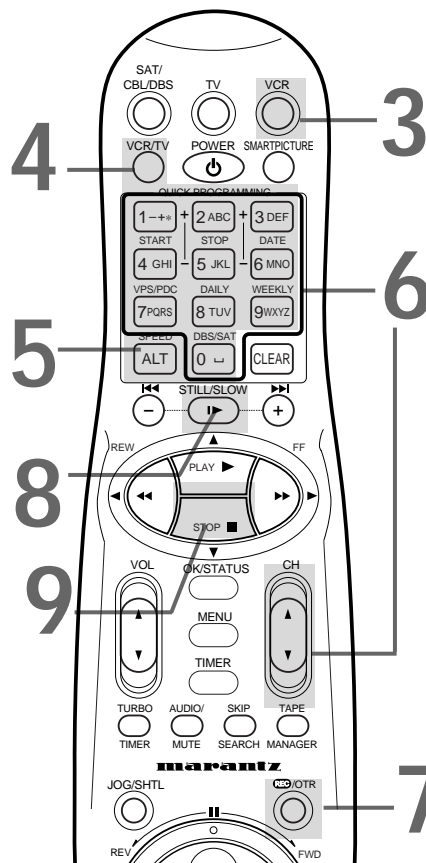
 Insert a tape.

Helpful Hints

- If the REC(ord)/OTR button is pressed while a tape without a record tab is in the VCR, PROTECTED CASSETTE CANNOT RECORD will appear on the screen briefly. The VCR will eject the tape.
- The VCR records in a preset volume.
- If the end of the tape is reached while recording, the VCR will stop recording, rewind the tape, then stop. Details are on page 76.
- While " - - - " is blinking on the VCR display panel after insert a tape, the tape will run for a few seconds to search for the tape number. Details are on page 64.
- DSPC may appear briefly on the display panel when you start a recording. Details are on page 60.

32 S-VHS ET

This VCR allows recording in Super VHS ET (Expansion Technology). You can play back those cassettes recorded in S-VHS ET on a VCR equipped with S-VHS ET. You can record with S-VHS picture quality on VHS cassettes.

1

Before you begin the recording, press the **S-VHS ET** button on the front panel so that the button lights. S-VHS ET recording cannot be turned on or off during recording with the S-VHS ET button.

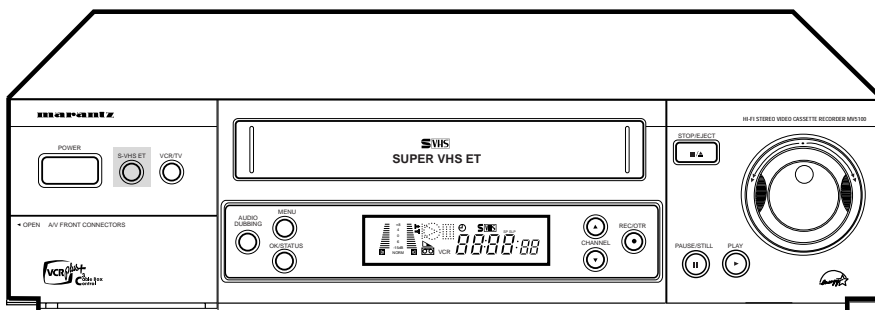

2

Press the **S-VHS ET** button again to cancel S-VHS ET recording.

Helpful Hints

- Pressing the S-VHS ET button has no effect on an S-VHS tape.
- To obtain the highest quality recording and to play pictures over a longer period, S-VHS recording on S-VHS tape is recommended.
- Label S-VHS ET recordings so you can easily distinguish them from regular VHS recordings.
- S-VHS ET recordings also can be played on an S-VHS VCR or a VHS VCR equipped with SQPB (S-VHS QUASI PLAYBACK). However, there may be cases where S-VHS ET playback is not possible on a particular VCR.
- Frequent still, frame-by-frame, and slow motion playback may damage the tape and cause the picture quality to decline.
- With some tapes, better picture quality may not be obtained even with S-VHS ET recording. Test a recording first to make sure better results can be obtained.
- Use high grade tapes for good results.

Recording One Channel/Watching Another 33

1

Press the VCR button.

2

Press the REC(ord)/OTR button to start a recording of the current channel. *Details are on page 30.*

3

Press the VCR/TV button to put the VCR in TV position. The VCR light will disappear from the display panel.

4

Use the TV remote control to select the channel you want to watch at the TV. Or, if the VCR remote control operates your TV, press the TV button, then use the CH(annel) ▲/▼ button to select the channel you want to watch at the TV.

The channel selected with the TV controls will appear on the screen while the channel you previously selected to record is being recorded. (The ○ light will appear on the display panel.)

5

To return to the channel being recorded, use the TV remote control to select channel 03 or 04 (whichever channel the CH3/CH4 switch on the back of the VCR is set to). Or, if the VCR remote control operates your TV, press the TV button, then use the CH(annel) ▲/▼ button to select channel 03 or 04.

6

Press the VCR button.

7

Press the VCR/TV button to put the VCR in VCR position. (The VCR light will appear on the display panel.) The channel being recorded will appear on the screen.

8

To stop the recording, press the STOP ▼ button.

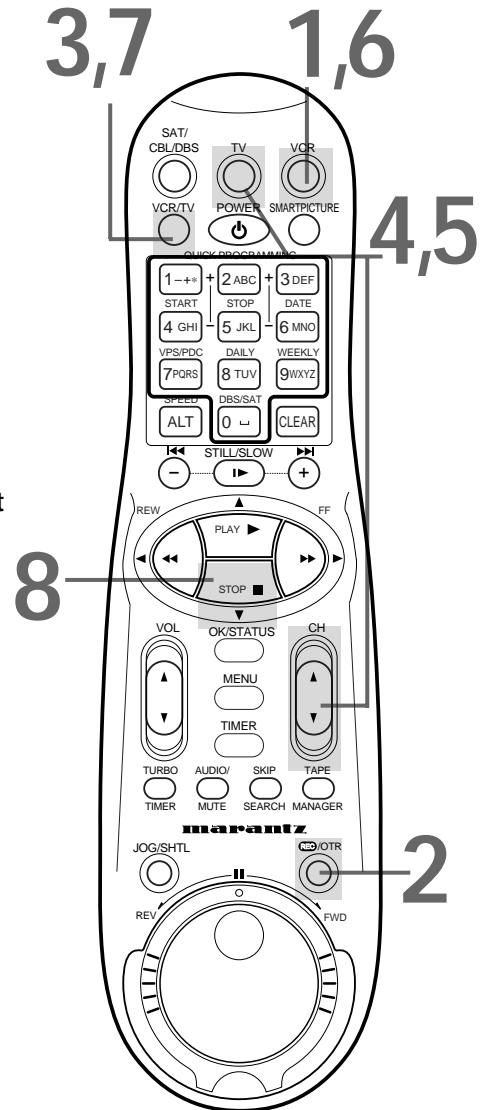

Helpful Hint

- If you use a Cable Box/DBS, you may not be able to watch one channel while recording another. See pages 8-9 for details.

34 One-Touch Recording

The One-Touch Recording (OTR) function allows you to start an immediate timed recording 30 minutes to six hours long of the channel you are watching. Before you begin, make sure:

- Channels are set up. *Details are on pages 12-13.*
- The desired recording speed (SP or SLP) has been selected with the ALT/SPEED button. *Details are on pages 41 and 77.*
- There is a tape in the VCR. Make sure the tape's record tab is intact (see page 5) and the tape is long enough to record the program(s). If the end of the tape is reached during an OTR, recording will stop. The VCR will eject the tape and turn itself off.
- The VCR is in VCR position. (The VCR light will appear on the display panel of the VCR when the VCR is in VCR position. If the VCR light does not appear, press the VCR/TV button once.)

Starting an OTR

1

Press the VCR button.

2

Use the CH(annel) ▲/▼ button or the Number buttons to select the channel you want to record.

3

Press the REC(ord)/OTR button repeatedly until the desired recording length appears briefly on the screen and on the display panel. The ○ light will flash on the display panel. (The recording length will not appear on the screen if ON SCREEN MODE is set to OFF.)

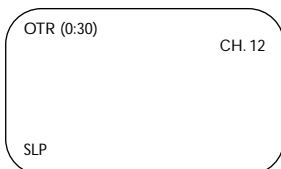

4

To stop an OTR before recording is finished, press the STOP ▼ button.

To cancel the OTR but continue recording, press the REC(ord)/OTR button repeatedly until REC appears in the upper left corner of the TV screen. (ON SCREEN MODE cannot be set to OFF. *Details are on page 26.*) The ○ light will remain on the display panel.

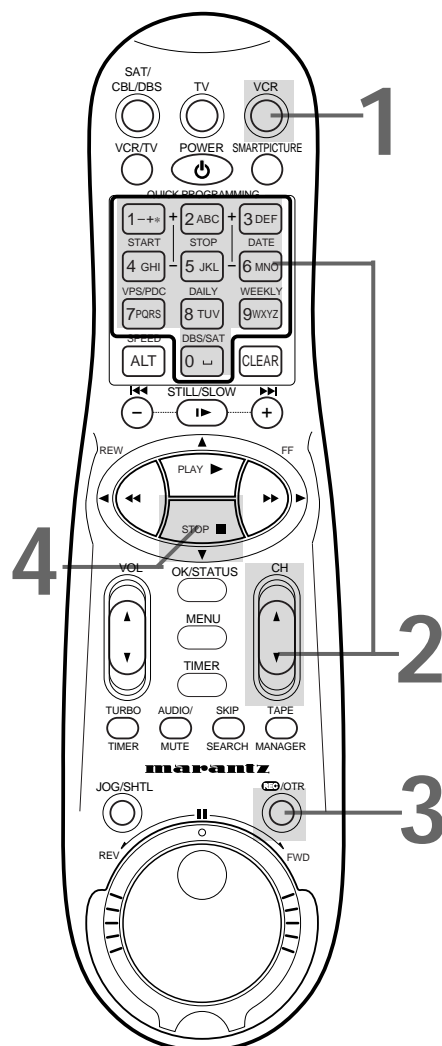

Helpful Hints

- To check the time remaining for an OTR after the OTR is in progress, press the OK/STATUS button. The remaining time will appear on the screen. (The recording length will not appear on the screen if ON SCREEN MODE is set to OFF.)
- To change the recording length while an OTR is in progress, press the REC(ord)/OTR button until the desired length appears on the VCR display panel. The desired length also will appear on the screen if ON SCREEN MODE is set to ON or COUNTER.
- If the preset time for a timer recording comes up during an OTR, the OTR has priority.

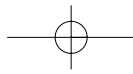

Record Link 35

This feature allows you to automatically record a satellite program that is programmed on your DBS. The VCR will start recording when it receives a signal from the DBS. The VCR stops recording when the DBS signal turns off.

1

Connect the **AUDIO** and **VIDEO OUT** jacks of the DBS to the **AUDIO** and **VIDEO IN** jacks on the back of the VCR. Set the program on the DBS. Turn off the DBS.

2

Insert a tape in the VCR.

3

Press the **VCR** button, then press the **MENU** button.

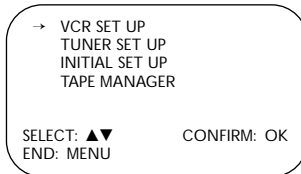

4

Press the **PLAY** ▲ or **STOP** ▼ button to select **VCR SET UP**, then press the **OK/STATUS** button.

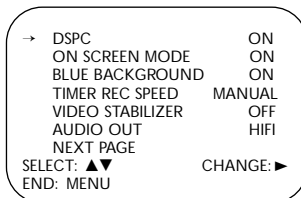

5

Press the **STOP** ▼ button repeatedly to select **AUTO DBS RECORD LINK** on the second page of the **VCR SET UP** menu. Press the **FF** ► button to set **AUTO DBS RECORD LINK** to **ON**.

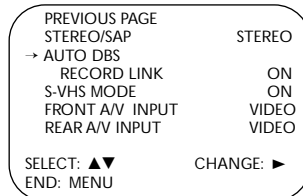
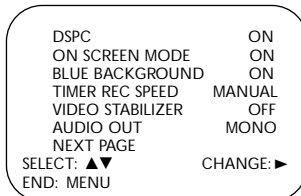

6

Press the **MENU** button. Final Record Link instructions will appear on the screen for about 30 seconds, then the VCR will turn off automatically. "L-1" will blink on the display panel.

1

Set the program on the DBS.

2

Insert a tape in the VCR.

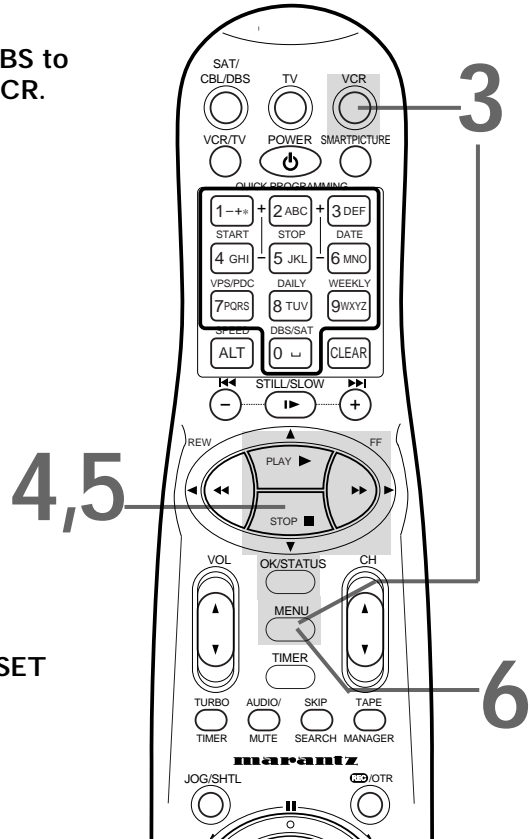

Helpful Hints

- Pressing the **POWER** button to turn on the VCR will set **AUTO DBS RECORD LINK** to **OFF** automatically.
- Do not turn on the DBS before the program starts; otherwise, the VCR will start recording when the DBS power is turned on.
- Depending on the type of DBS, the VCR may not record the first few seconds of the program. Or, the VCR may record slightly longer than the actual length of the program.
- If a Record Link is set, regular timer recordings will not occur.
- "Err L-1" will flash on the display panel after the VCR turns off if the DBS power is on. Turn off the DBS and set up the Record Link again.

Setting Up the VCR Plus+ Programming System (cont'd) 37

2

Now, compare the channel numbers you have written into the VCR PLUS+ CH. and CABLE/TV CH. columns. You'll notice that some stations have VCR Plus+ and Cable/TV channel numbers that are the same, and other stations have channel numbers that do not match. You must tell the VCR the VCR Plus+ and Cable/TV channel numbers according to the following steps.

3

Press the VCR button, then press the MENU button.

4

Press the PLAY ▲ or STOP ▼ button to select INITIAL SET UP, then press the OK/STATUS button.

5

Press the PLAY ▲ or STOP ▼ button to select VCR PLUS+ CH., then press the OK/STATUS button.

SET VCR PLUS+ CH.	
VCR PLUS+	CABLE/TV
99	---
01	---
02	---->
03	---
04	---

SELECT: ▲▼ OR 0-9
 CONFIRM: OK
 END: MENU

6

While a VCR Plus+ channel is flashing, press the PLAY ▲ or STOP ▼ button repeatedly or press the Number buttons so that the arrow appears beside the VCR Plus+ channel number you need. Press the OK/STATUS button.

7

While the space for the Cable/TV channel is flashing, press the PLAY ▲ or STOP ▼ button repeatedly or press the Number buttons to enter the Cable/TV channel number from the list on page 36. Press the OK/STATUS button. Repeat steps 6-7 until you have entered all the channels on your list.

- If you are using a Cable Box/DBS, the Cable/TV channel will be 03 or 04 (the Cable Box/DBS output channel) for every VCR Plus+ channel. You must set the Cable Box/DBS to the channel you want to record; leave the Cable Box/DBS on for the timer recording.

8

Press the MENU button.

2

Examine the lists on page 36.

3

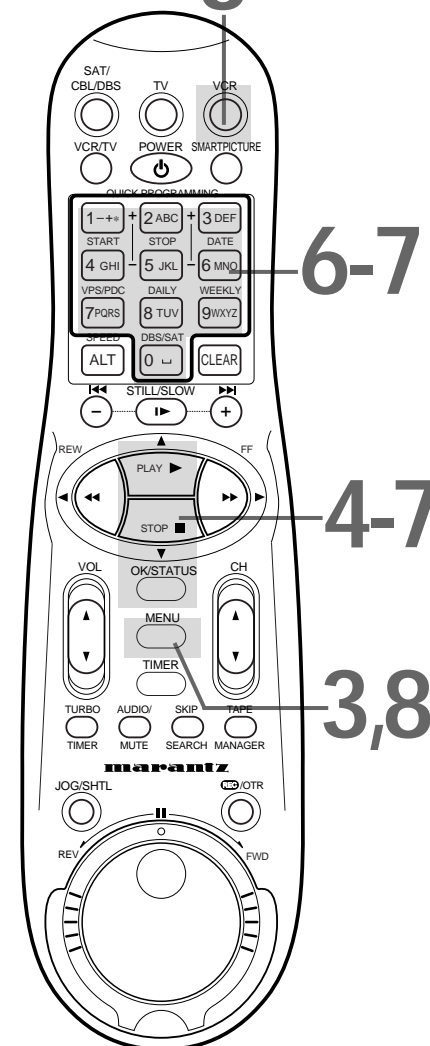

38 Timer Recording with the VCR Plus+ Programming System

Follow the steps below to program a timer recording using PlusCode programming numbers. Before you begin make sure:

- Channels are set up. *Details are on pages 12-13.*
- The clock is set. *Details are on pages 14-18.*
- There is a tape in the VCR. Make sure the tape's record tab is intact and the tape is long enough to record the program(s).
- The VCR is in VCR position (the VCR light will appear on the display panel). If the VCR light does not appear, press the VCR/TV button once.
- You have programmed the VCR Plus+ and Cable/TV channel numbers. *Details are on pages 36-37.*

Complete each step within 60 seconds of completing the previous step. If you don't, you may start again at step 1.

1

Press the **VCR** button.

2

Press the **TIMER** button.

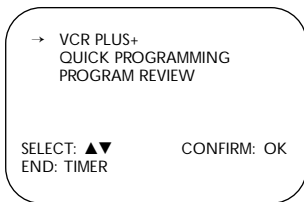

3

Press the **PLAY** ▲ or **STOP** ▼ button to select **VCR PLUS+**, then press the **OK/STATUS** button.

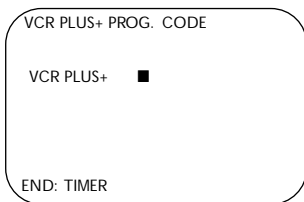

4

Use the **Number** buttons to enter the **PlusCode** programming number of the program you wish to record. (This number is different for every program.)

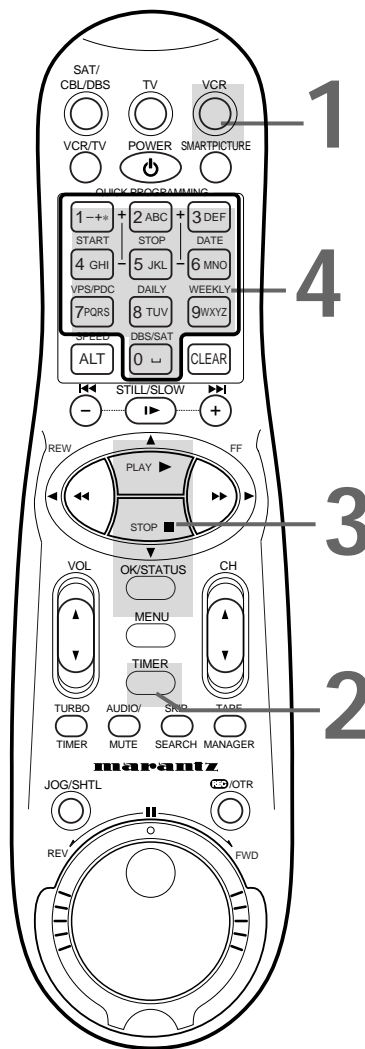
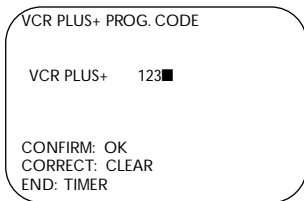

Helpful Hint

- If you enter an incorrect PlusCode programming number at step 4, **ERROR-RE-ENTER CODE** will flash on the screen after step 5. Enter the correct PlusCode programming number.

Timer Recording with the VCR Plus+ Programming System (cont'd) 39

5

Press the OK/STATUS button. If the VCR PLUS+ and CABLE/TV channel lists appear on the screen, the CABLE/TV channel has not been set for the VCR PLUS+ channel of the program you have set in step 4. Press the Number buttons to enter the CABLE/TV channel number from your list on page 36, then press the OK/STATUS button.

6

- If you want to record the program one time only, go to step 7. You also may press the Number 8/DAILY or Number 9/WEEKLY button repeatedly to select a ONE TIME PROGRAM.
- If you want to record the program daily, press the Number 8/DAILY button so that **DAILY PROGRAM** appears at the top of the screen. The VCR will record a program every day from Monday through Friday, starting at the same time and recording for the same length of time.
- If you want to record the program every week, press the Number 9/WEEKLY button so that **WEEKLY PROGRAM** appears at the top of the screen. The VCR will record a program on the same day, at the same time, for the same length of time every week.

DAILY PROGRAM (MON-FRI)	
PROGRAM	1
CHANNEL +/-	12 CABLE/TV
START +/-	08:00 PM
STOP +/-	10:00 PM
REC SPEED	SLP
DATE +/-	06/21/00
	WEDNESDAY
DAILY: 8	WEEKLY: 9
CONFIRM: OK	END: TIMER

7

Press the ALT/SPEED button to select the tape speed. The selected tape speed, SP or SLP, will appear beside REC SPEED.

8

Press the OK/STATUS or TIMER button. PROGRAM WAS COMPLETED/PLEASE TURN OFF VCR FOR TIMER RECORDING should appear on the screen. (If PROGRAM NOT COMPLETED appears, begin again from step 1.) After five seconds, the on-screen display will disappear.

9

Press the POWER button to turn off the VCR. The VCR must be turned off for a timer recording to take place. The ☺ light will appear on the display panel. The ☺ light and the Cassette-Inside light will flash when you turn off the VCR if there is not a tape in the VCR.

Turn off the VCR for a timer recording! Put a tape in the VCR. Leave the Cable Box/DBS on.

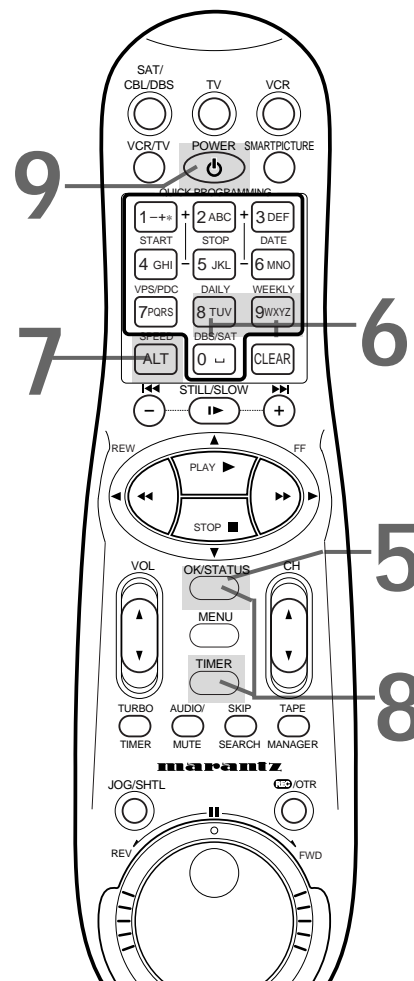

Helpful Hints

- Do not select DAILY at step 6 if the VCR Plus+ recording you chose is on a Saturday or Sunday. The recording will not occur, even though the VCR may accept the way you programmed the recording.
- To exit the VCR Plus+ programming system at any step, press the TIMER button.
- If the timer recording you just programmed overlaps another timer recording, PROGRAM NOT COMPLETED/PROGRAM OVERLAP will appear. Details are on page 46.
- If you forget to turn off the VCR, PLEASE TURN OFF VCR FOR TIMER RECORDING flashes on your TV screen two minutes before a timer recording is set to begin. To remove the message, press the CLEAR button.
- To check your timer recordings, see page 45.

40 Quick Programming

Follow the steps below to program your VCR to record TV programs while you're away from home. The VCR will turn itself on, record, and turn itself off automatically.

Before you begin, make sure:

- Channels are programmed. *Details are on pages 12-13.*
- The clock is set. *Details are on pages 14-18.* If the clock is not set, CLOCK MUST BE SET appears on the screen, followed by the menu.
- There is a tape in the VCR. Make sure the tape's record tab is intact and the tape is long enough to record the program(s).
- The VCR is in VCR position. The VCR light will appear on the display panel when the VCR is in VCR position. If the VCR light does not appear, press the VCR/TV button once.
- When you use a Cable Box/DBS, timer recordings are programmed differently. Read pages 8-9 before proceeding.

Complete each step within 60 seconds of the previous step.

1

Press the VCR button, then press the TIMER button.

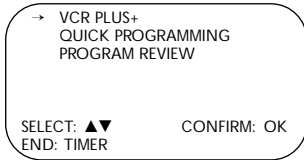

2

Press the PLAY ▲ or STOP ▼ button to select QUICK PROGRAMMING, then press the OK/STATUS button.

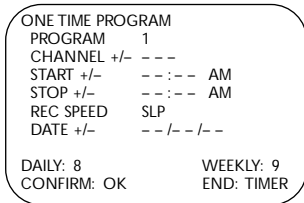

3

Press the CH(annel) ▲/▼ button to enter the channel you want to record.

- If you are using a standard antenna/cable to VCR to TV hookup (as shown on pages 6-7), enter the channel of the TV program you want to record.
- If you are using a Cable Box/DBS and are not using the Controller, enter the Cable Box/DBS output channel (03 or 04). Set the Cable Box/DBS to the channel you want to record. Leave the Cable Box/DBS on for a timer recording.
- If you are using the Controller, enter the channel number that you want to record. The Controller will select the channel at the Cable Box/DBS.

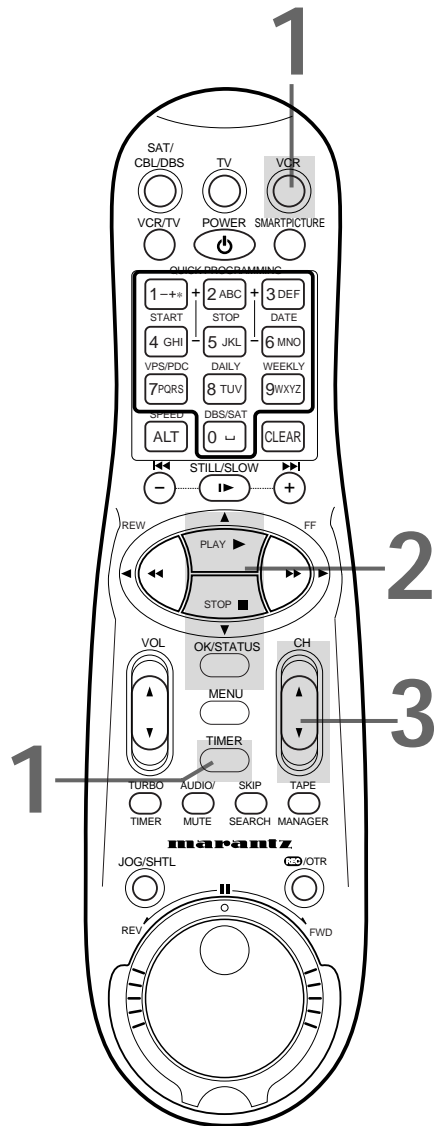
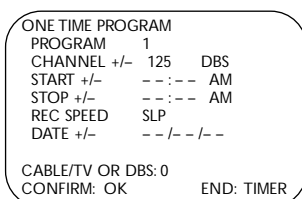
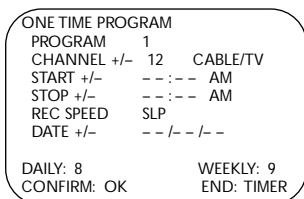

Helpful Hint

- If you are using a DBS with the Controller, CABLE/TV or DBS appears beside the channel number. You may need to clarify whether the desired channel is for Cable TV or Satellite TV (DBS). If so, "CABLE/TV OR DBS: 0" will appear at the bottom of the screen. Press the Number 0 (DBS) button to select either CABLE/TV or DBS. Press the button repeatedly to switch between the CABLE/TV and DBS settings.
CABLE/TV is to record a cable TV program received on the VCR or through a Cable Box; DBS is to record a satellite program received through a DBS.

Quick Programming (cont'd) 41

4

Press the Number 1/START + or Number 4/START- button to set the recording's start time. Every time you press a button, the start time changes in one-minute increments. If you press and hold a button, the start time changes in 30-minute increments.

ONE TIME PROGRAM	
PROGRAM	1
CHANNEL +/-	12 CABLE/TV
START +/-	08 : 00 PM
STOP +/-	-- : -- AM
REC SPEED	SLP
DATE +/-	-- / -- / --
DAILY: 8	WEEKLY: 9
CONFIRM: OK	END: TIMER

5

Press the Number 2/STOP+ or Number 5/STOP- button to set the recording's stop time. Every time you press a button, the stop time changes in one-minute increments. If you press and hold a button, the stop time changes in 30-minute increments.

ONE TIME PROGRAM	
PROGRAM	1
CHANNEL +/-	12 CABLE/TV
START +/-	08 : 00 PM
STOP +/-	10 : 00 PM
REC SPEED	SLP
DATE +/-	-- / -- / --
DAILY: 8	WEEKLY: 9
CONFIRM: OK	END: TIMER

6

Press the ALT/SPEED button to select the tape speed (SP or SLP). Details about tape speed are given below.

ONE TIME PROGRAM	
PROGRAM	1
CHANNEL +/-	12 CABLE/TV
START +/-	08 : 00 PM
STOP +/-	10 : 00 PM
REC SPEED	SLP
DATE +/-	-- / -- / --
DAILY: 8	WEEKLY: 9
CONFIRM: OK	END: TIMER

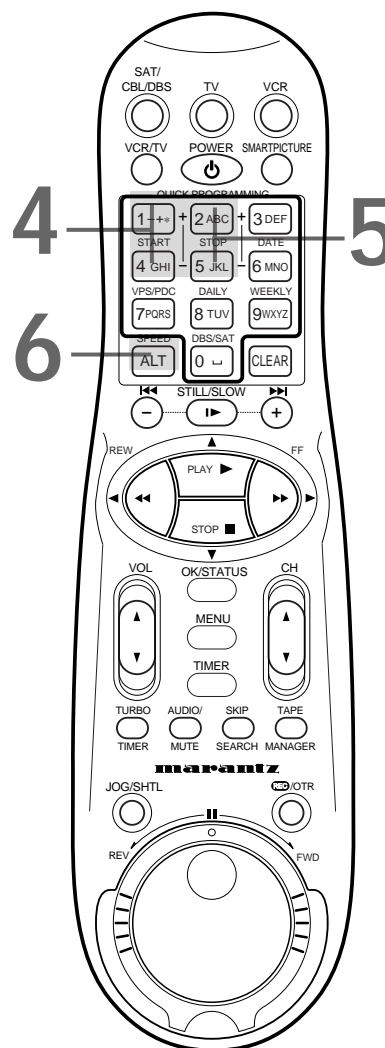

Instructions continue on page 42.

Tape Speeds This chart shows the recording/playback time for T160, T120, and T60 video cassettes. There are three playback speeds: SP, LP, and SLP. This VCR will play tapes recorded in LP, but LP will not appear on the display panel. This VCR will record only in SP and SLP.	Tape Speed	Cassette type / Playback Time		
		T160	T120	T60
	SP (standard play)	2 hrs. 40 mins.	2 hrs.	1 hr.
	LP (long play) (playback only)	5 hrs. 20 mins.	4 hrs.	2 hrs.
	SLP (super long play)	8 hrs.	6 hrs.	3 hrs.

42 Quick Programming (cont'd)

7

Press the Number 3/DATE+ or Number 6/DATE- button to set the recording date. Every time you press a button, the date changes in one-day increments. If you press and hold a button, the date changes quickly. The day of the week will appear automatically. (You cannot program the VCR to record more than one year in advance.)

ONE TIME PROGRAM	
PROGRAM	1
CHANNEL +/-	12 CABLE/TV
START +/-	08:00 PM
STOP +/-	10:00 PM
REC SPEED	SLP
DATE +/-	06/21/00
	WEDNESDAY
DAILY: 8	WEEKLY: 9
CONFIRM: OK	END: TIMER

8

- If you want to record the program one time only, go to step 9. You may also press the Number 8/DAILY or Number 9/WEEKLY button repeatedly to select a ONE TIME PROGRAM.
- If you want to record the program daily, press the Number 8/DAILY button so that DAILY PROGRAM appears at the top of the screen. The VCR will record a program every day from Monday through Friday, starting at the same time and recording for the same length of time.
- If you want to record the program every week, press the Number 9/WEEKLY button so that WEEKLY PROGRAM appears at the top of the screen. The VCR will record a program on the same day at the same time and for the same length of time every week.

DAILY PROGRAM (MON-FRI)	
PROGRAM	1
CHANNEL +/-	12 CABLE/TV
START +/-	08:00 PM
STOP +/-	10:00 PM
REC SPEED	SLP
DATE +/-	06/21/00
	WEDNESDAY
DAILY: 8	WEEKLY: 9
CONFIRM: OK	END: TIMER

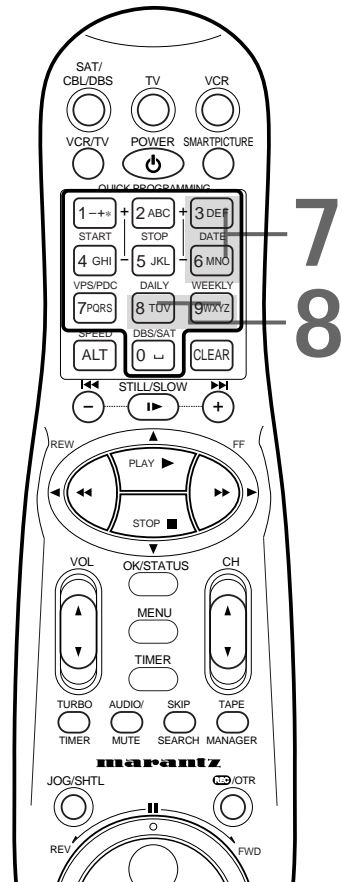

Helpful Hints

- If you leave the VCR on past the scheduled start time of a timer recording, you will not be asked again to turn off the VCR. The VCR might store the recording for the same time and day in the next year. Or, the VCR may start recording when you turn off the VCR power.
- If the end of the tape is reached during a timer recording, recording will stop. The VCR will eject the tape, then turn itself off.
- If the timer recording you just programmed overlaps another timer recording, PROGRAM NOT COMPLETED/PROGRAM OVERLAP will appear. Details are on page 46.
- If you forget to turn off the VCR, PLEASE TURN OFF VCR FOR TIMER RECORDING flashes on your TV screen two minutes before a timer recording is set to begin. To remove the message, press the CLEAR button.

Quick Programming (cont'd) 43

9

Press the **OK/STATUS** or **TIMER** button. PROGRAM WAS COMPLETED/PLEASE TURN OFF VCR FOR TIMER RECORDING will appear on the screen. If PROGRAM NOT COMPLETED appears, try again from step 1.

10

Press the **POWER** button to turn off the VCR. The \odot light will appear on the display panel. (The \odot light and the Cassette-Inside light will flash when you turn off the VCR if there is not a tape in the VCR.) **The VCR must be turned off for a timer recording to take place. Leave the Cable Box/DBS on, if applicable.**

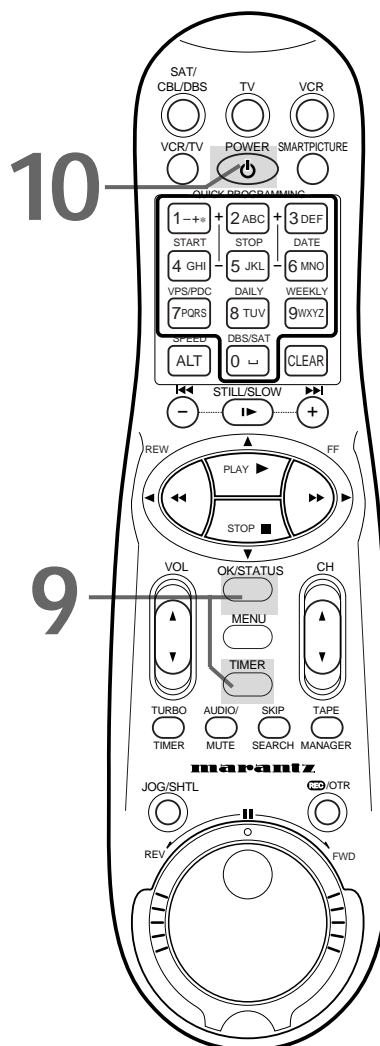

Helpful Hint

- If the power fails, the VCR keeps your timer recordings. However, the time and other menu settings may be lost if the power fails for more than three minutes. When the power is restored, the following will occur:
The VCR will automatically restore the time setting if you are using AUTO CLOCK. Auto will flash on the display panel. When the time setting is restored, the current time will appear on the display panel.
After the time setting is restored, each timer recording you have set will occur as programmed, unless the recording was to occur during the power outage.

44 Turbo Timer

This function allows you to set a timer recording without using the on-screen menus. Complete each step within one minute of the previous step. Use Turbo Timer to set a timer recording within the next 24 hours only.

1

Insert a tape into the VCR and press the **TURBO TIMER** button on the remote control. The current time will appear on the display panel. (It will not appear on the TV screen.) If "Err" (error) appears, either the clock is not set or you have set eight timer recordings already. The VCR will not let you set more than eight timer recordings.



2

To set the **START** time, press the **PLAY ▲** or **STOP ▼** button until the desired start time appears on the display panel. Every time you press a button, the start time changes in one-minute increments. If you press and hold a button, the start time changes in 30-minute increments.

When the correct **START** time appears, press the **OK/STATUS** button.



3

The **START** time will continue to appear on the display panel. To set the **STOP** time, press the **PLAY ▲** or **STOP ▼** button. Every time you press a button, the stop time changes in one-minute increments. If you press and hold a button, the stop time changes in 30-minute increments. When the correct **STOP** time appears, press the **OK/STATUS** button.



4

The current channel number will appear on the display panel. To select the channel you want to record, press the **PLAY ▲** or **STOP ▼** button. Every time you press a button, the channel changes once. If you press and hold the button, the channels will change rapidly. When the correct channel number appears, press the **OK/STATUS** button.



5

The normal display will appear, and the \odot light will appear on the display panel. Press the **POWER** button to turn off the VCR. Leave the Cable Box/DBS on if applicable.

1

Insert a tape into the VCR.

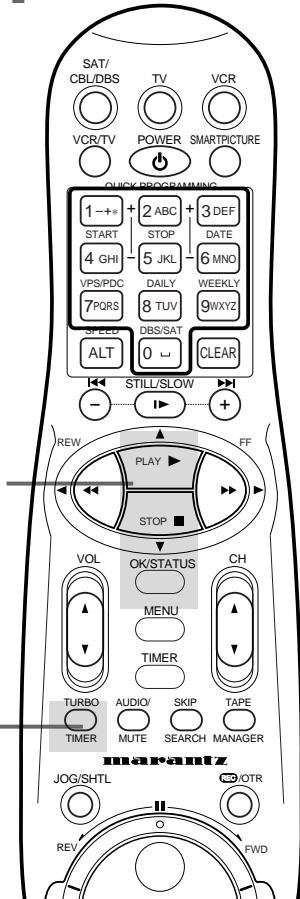

Helpful Hints

- The Program Overlap Warning does not function with Turbo Timer. The timer recording with the earliest start time will record. Then, the remaining portion of the later recording will record.
- To exit Turbo Timer mode at any time, press the **TURBO TIMER** button.
- **DAILY** or **WEEKLY** timer recordings can not be set with Turbo Timer.
- Tape speed can be selected at any time during steps 2-4 by pressing the **ALT/SPEED** button.
- If you are using a DBS with the Controller, and have selected a channel number which is between 100-199, you need to specify whether the channel is for Cable TV or Satellite TV (DBS). Press the Number 0 (DBS) button repeatedly to select either the DBS mode ("D" indicator appears on the display panel), or CABLE/TV (no indicator display appears next to channel number) for the proper channel mode.

Program Review 45

Checking, Editing, or Clearing Timer Recordings

1

Press the **VCR** button, then press the **TIMER** button.

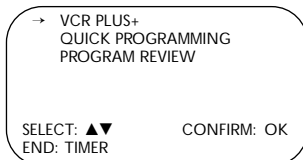

2

Press the **PLAY ▲** or **STOP ▼** button to select **PROGRAM REVIEW**, then press the **OK/STATUS** button. The list of programmed timer recordings will appear. (If no timer recordings are set, **NO PROGRAM SET** will appear briefly.)

PR	CH	START	STOP	DATE
1	12	08:00P	10:00	06/10
2				
3	20	10:00A	10:45W	11/25
4				
5	45	03:00P	03:15W	10/16
6				
7				
8	125	11:30P	01:00D	12/04
		NEXT: OK	END: TIMER	

← *W indicates a Weekly recording.*

← *D indicates a Daily recording.*

3

To see the timer recordings individually, press the **OK/STATUS** button. Information for the first program will appear.

ONE TIME PROGRAM	
PROGRAM	1
CHANNEL +/-	12 CABLE/TV
START +/-	08:00 PM
STOP +/-	10:00 PM
REC SPEED	SLP
DATE +/-	06/10/00
	SATURDAY
ERASE: CLEAR	END: TIMER
NEXT: OK	PREV: ◀

4

Press the **OK/STATUS** button repeatedly to review all programmed timer recordings. Or, press the **REW(ind) ◀** button to return to the previous screen.

5

While the information is on the screen, you may change any of the information except the program number. Refer to pages 38-43.

6

To cancel the timer recording, press the **CLEAR** button. You will either see the next timer recording or the menu will disappear.

7

When all programmed timer recordings have been displayed, the menu will disappear. Or, press the **TIMER** button to remove the menu.

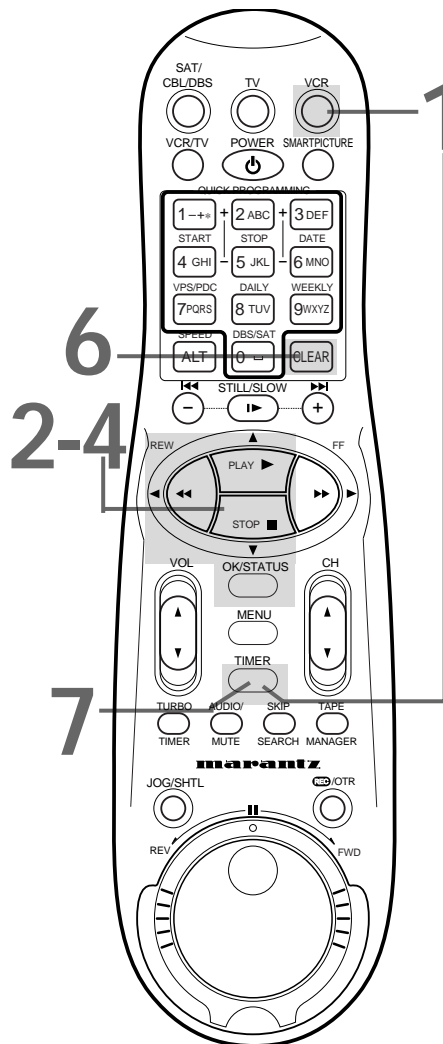

Helpful Hint

- To stop a timer recording that is in progress, press the **POWER** button on the remote control.
- See page 78 for more hints.

46 Program Overlap Warning

If the timer recording you just set overlaps a previously set program, "PROGRAM NOT COMPLETED/PROGRAM OVERLAP" will appear on the screen for five seconds. To correct the overlapping recordings, follow the steps below.

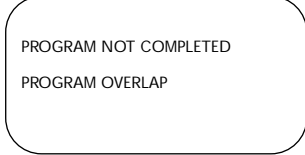

1

The program review screen will appear automatically after "PROGRAM NOT COMPLETED/PROGRAM OVERLAP." The two overlapping programs will blink. The program you set most recently will be highlighted in red.

PR	CH	START	STOP	DATE
1	12	08:00P	10:00D	07/21
2	36	10:00P	12:00	08/10
3	24	11:00P	01:00	08/10
4	45	03:00P	03:15W	10/15
5				
6				
7				
8				

SELECT: ▲▼ CONFIRM: OK

2

Press the **PLAY ▲** or **STOP ▼** button to move the red highlight to the program that you want to change.

3

Press the **OK/STATUS** button to select the program. Information about the chosen program will appear.

ONE TIME PROGRAM	
PROGRAM	3
CHANNEL +/-	24 CABLE/TV
START +/-	11:00 PM
STOP +/-	01:00 AM
REC SPEED	SLP
DATE +/-	08/10/00
	THURSDAY
ERASE: CLEAR	
CONFIRM: OK	END: TIMER

4

Refer to pages 38-43 to change any information on the selected program. When all the information is correct, press the **OK/STATUS** button.

Or, to cancel the timer recording, press the **CLEAR** button.

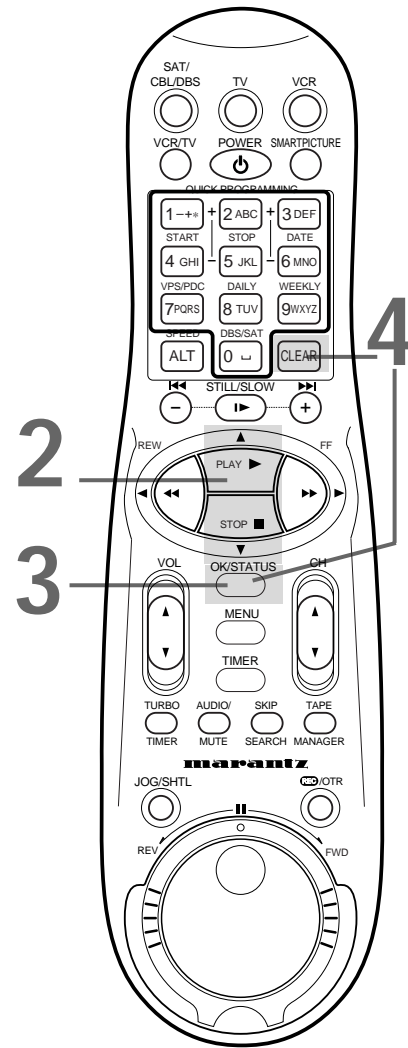

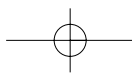

48 Rerecording (Tape Duplication)

The instructions on this page show you how to copy tapes. Different VCRs may operate differently. To duplicate a tape, make the connections shown, then follow steps 1-6. (You may use the AUDIO and VIDEO or S-VIDEO In jacks on the front of VCR 2 instead if you prefer.)

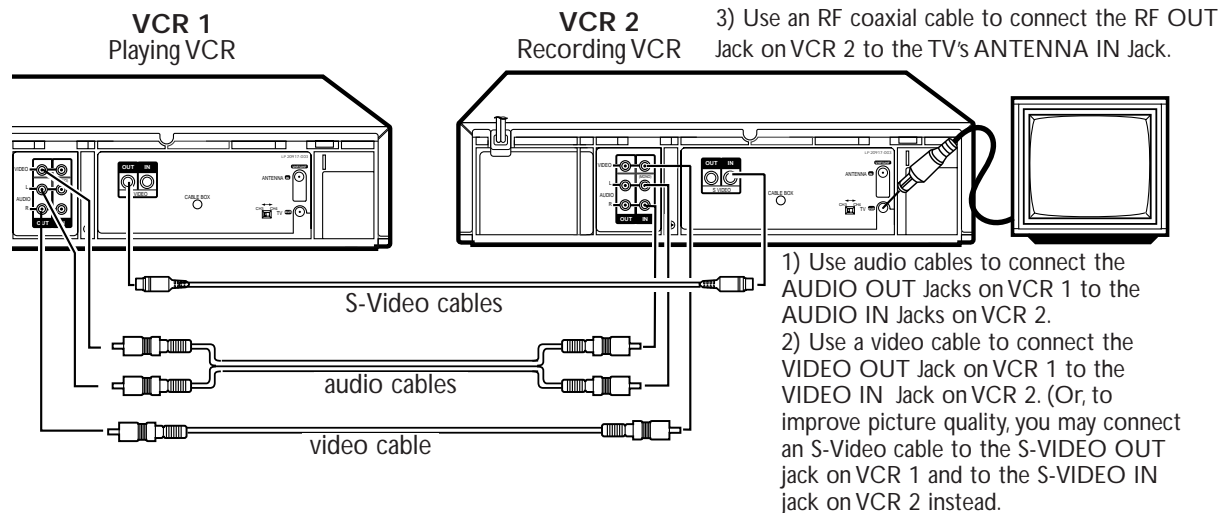

1

VCR 1 will play your tape. **Insert a prerecorded tape in VCR 1.** If the tape does not have a record tab, playback begins. If this happens, press the STOP/EJECT button on VCR 1 once.

2

VCR 2 will record your tape. **Insert a blank tape in VCR 2. Make sure the VCR power is on and the VCR is in VCR position.** (The VCR light will appear on the display panel. If it does not, press the VCR/TV button once.)

3

Turn on the TV; set it to channel 3 or 4, whichever channel the CH3/CH4 switch on VCR 2 is set to.

4

Point the remote control at VCR 2. Press the VCR button, then press the Number button 0. Press the CH(annel) ▲/▼ button so that A/V IN FRONT (for jacks on the front) or A/V IN REAR (for jacks on the back) appears on the screen.

5

Point the remote control at VCR 2. Press the ALT/SPEED button to select SP or SLP.

6

Press the PLAY button on VCR 1 and the REC(ord)/OTR button on VCR 2 at the same time. The ○ light will appear on the VCR 2 display panel.

Helpful Hints

- *Unauthorized recording of copyrighted television programs, video tapes, or other materials may infringe on the rights of copyright owners and violate copyright laws.*
- *If a program has copyright protection, it may not record clearly.*
- *Audio and video cables are not included.*
- *To stop copying tapes, press the STOP/EJECT button on VCR 2, then press the STOP/EJECT button on VCR 1.*
- *If you connect the audio and video or S-video cables to the AUDIO/VIDEO or AUDIO/S-VIDEO IN jacks on the front of VCR 2, you must select A/V IN FRONT at step 4. Then, select VIDEO or S-VIDEO at FRONT A/V INPUT in the VCR Set Up menu. If you connect the audio and video or S-Video cables to the AUDIO/VIDEO IN or AUDIO/S-VIDEO IN jacks on the back of VCR 2, you must select A/V IN REAR at step 4. Then select VIDEO or S-VIDEO at REAR A/V INPUT in the VCR Set Up menu.*

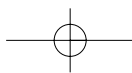

Audio Dubbing 49

Audio dubbing replaces the normal audio sound of a previously recorded tape with a new soundtrack. Use your VCR as the recorder.

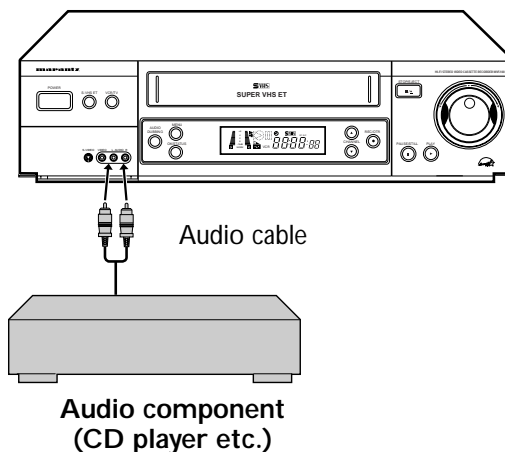
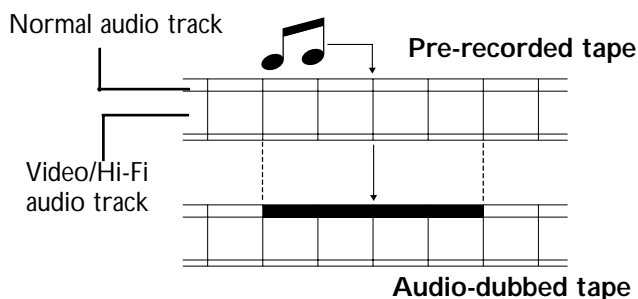

1

Connect an audio component to your VCR's AUDIO IN L+R connectors. When connecting monaural equipment, use only the VCR's AUDIO IN L connector.

2

Press the **VCR** button, then press the **Number button 0**. Press the **CH (annel) ▲/▼** button so that **A/V IN FRONT** or **A/V IN REAR** appears on the screen.

3

Press the **PLAY** button to start playback of the tape in your VCR, and press **STILL/SLOW** button (or **PAUSE/STILL** button on the front panel) when you find the point where you want to start dubbing.

4

Press **AUDIO DUBBING** on the front panel.

- Your VCR enters the Audio Dubbing Pause mode.
- blinks, ▶ and □ light up on the front display window.

5

Engage the audio component's playback mode, then press the **STILL /SLOW** button (or **PAUSE/STILL** button on the front panel) to start Audio Dubbing.

- blinks and ▶ is displayed on the front display window.
- To stop dubbing temporarily, press the **STILL/SLOW** button or **PAUSE/STILL** button. To resume dubbing, press the **STILL/SLOW** button or **PAUSE/STILL** button again.

6

Press the **STOP** button to stop the tape in your VCR, and engage the audio component's Stop mode.

Helpful Hints

- When monitoring the sound during Audio Dubbing, the normal soundtrack is automatically selected. If you wish to hear the Hi-Fi sound, Set "AUDIO OUT" to "HIFI" in the VCR SET UP menu. Details are on page 57.
- Audio dubbing stops automatically when the counter reaches "0:00:00", and the VCR enters the Play mode. Check the counter reading before dubbing.
- Audio dubbing cannot be performed on a cassette that has had its record tab removed.
- When playing back an audio-dubbed tape, Set "AUDIO OUT" to "HIFI" (for original sound) or "MONO" (for AUDIO- dubbed sound) in the VCR SET UP menu. Details are on page 57.

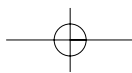

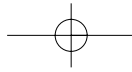

50 Connecting the Controller

If you are using a Cable Box/DBS, connect the Controller to your VCR. The Controller will automatically select channels at the Cable Box/DBS during a timer recording. Leave your Cable Box/DBS turned on during a timer recording.

1

Connect the Cable Box/DBS to the VCR as shown below. For more information, please read page 8. Or, refer to the owner's manual of your Cable Box/DBS.

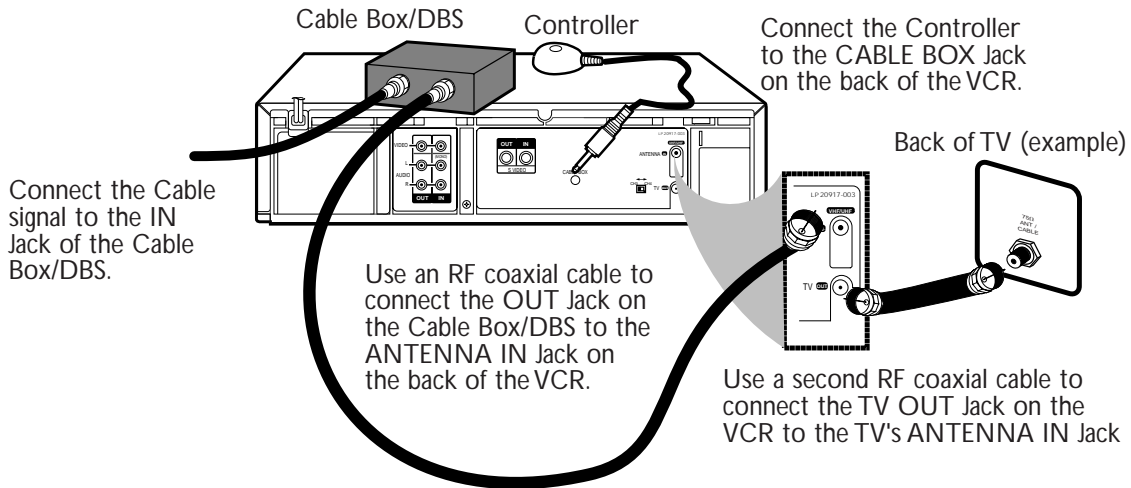

2

Connect the Controller to the CABLE BOX Jack on the back of the VCR as shown above.

3

Attach the Controller to the top of the VCR using the supplied adhesive. Make sure the Controller's transmitter (the light on the top of the Controller) is pointed toward the Cable Box/DBS remote sensor.

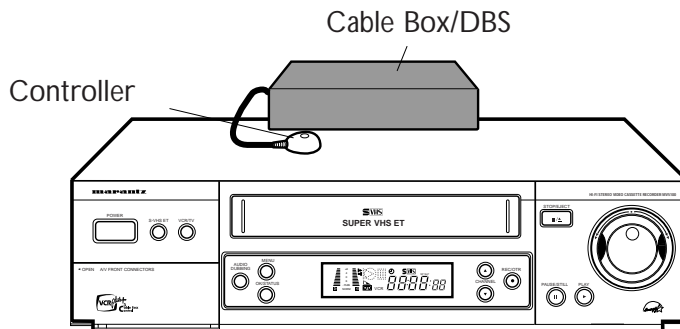

4

If you are using a Cable Box, follow the steps on pages 51-52 to make the Controller change channels at the Cable Box during timer recordings. If you are using a DBS, follow the steps on pages 53-54 to make the Controller change channels at the DBS during timer recordings.

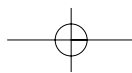

Setting the Controller to Operate a Cable Box 51

- If you use a Cable Box, you must set the clock manually. *Details are on pages 14-15.*
- Complete the steps on page 28 before proceeding. This will enable you to use the VCR remote control to operate the Cable Box, and you will learn your Cable Box code.
- Make each entry within one minute of the previous entry.

1
Turn on the Cable Box. Select a channel other than 09.

2
Press the VCR button, then press the MENU button.

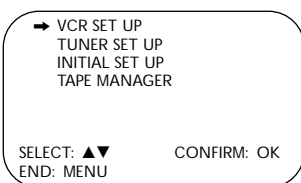

3
Press the PLAY ▲ or STOP ▼ button to select INITIAL SET UP, then press the OK/STATUS button.

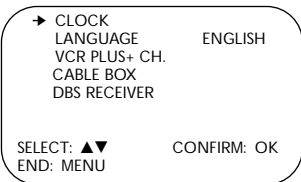

4
Press the PLAY ▲ or STOP ▼ button to select CABLE BOX, then press the OK/STATUS button.

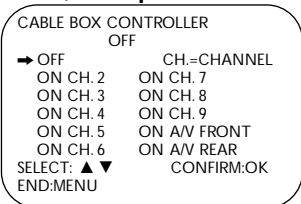

5
Press the PLAY ▲ or STOP ▼ button to select the output channel of your Cable Box, then press the OK/STATUS button. The display shown below will appear. If CABLE BOX USERS SET CLOCK MANUALLY appears, follow steps 4-8 on page 15, then go to step 6 on page 52.

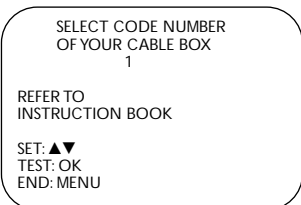

1 Turn on the Cable Box. Set it to a channel other than channel 09.

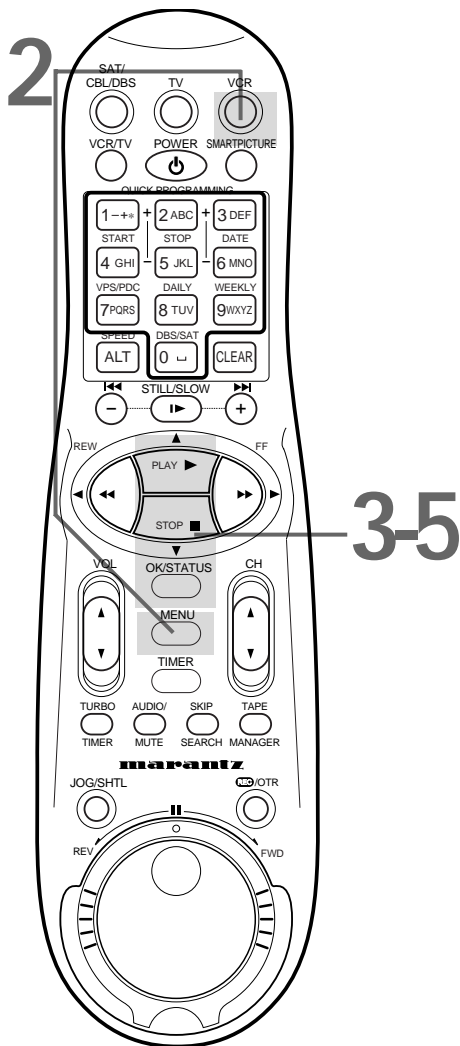

Instructions continue on page 52.

52 Setting the Controller to Operate a Cable Box (cont'd)

6

Press the **PLAY ▲** or **STOP ▼** button to set the code for your Cable Box (see list below), then press the **OK/STATUS** button.

SELECT CODE NUMBER OF YOUR CABLE BOX
12

DID CABLE BOX DISPLAY CHANGE TO CHANNEL 09?
→ YES
NO

SELECT: ▲▼ CONFIRM: OK
END: MENU

CABLE BOX CODES	
ARCHER01, 05, 17	REGAL10, 18, 19, 23
CABLETENNA01, 17	REGENCY19
CABLEVIEW .15, 16, 17, 21, 25	REMBRANDT01, 16, 17
CITIZEN15, 16, 17, 21, 25	SAMSUNG05, 16, 24
CURTIS02, 08	SCIENTIFIC ATLANTA .02, 08
DIAMOND01, 17	SIGMA07, 20
EASTERN19	SL MARX . . .05, 16, 17, 24, 25
GC BRAND .15, 16, 17, 21, 25	SPRUCER13, 14
GEMINI15	STARGATE . . .05, 15, 16, 17, 21, 24, 25
GENERAL INSTRUMENTS01, 04, 06, 11, 12, 15	TELEVIEW05, 16, 24
HAMLIN10, 18, 19, 23	TOCOM01, 04, 16
JASCO15	UNIKA01, 17
JERROLD01, 04, 06, 11, 12, 15	UNIVERSAL16, 17, 25
NOVAVISION02, 08	VIDEOWAY03, 09, 22
OAK07, 20	ZENITH03, 09, 22
PANASONIC13, 14	
PULSAR15, 16, 17, 21, 25	
RCA13, 14	

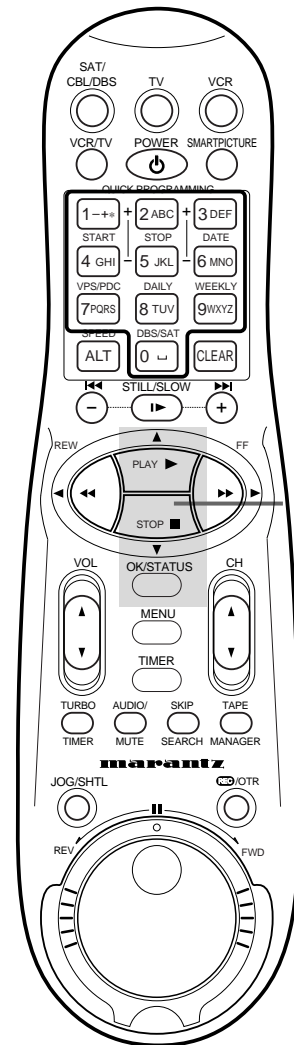

7

Wait for a few seconds.

- If the Cable Box changes to channel 09, go to step 8.
- If the Cable Box doesn't change to channel 09, press the **PLAY ▲** or **STOP ▼** button to select **NO**, then press the **OK/STATUS** button. Repeat steps 6-7 using a different code for your brand, if available.
- If the Cable Box does not respond to any of the codes, press the **MENU** button to remove the menu. **CABLE BOX CONTROL IS OFF** will appear on the screen briefly.

8

Press the **PLAY ▲** or **STOP ▼** button to select **YES**, then press the **OK/STATUS** button. "CABLE BOX CONTROL IS ON" will appear for five seconds. "AS A RESULT AUTO CLOCK WILL BE TURNED OFF" also may appear on the screen.

Helpful Hints

- If your Cable Box does not respond to any of the codes at step 7, the Controller will not change channels at the Cable Box during a timer recording. You must select the channel to be recorded at the Cable Box before a timer recording begins. Enter the Cable Box output channel (03 or 04) at step 3 on page 42. Leave the Cable Box on for the timer recording. See page eight for details. You may want to exchange your current Cable Box for one that can be controlled by the VCR's Controller.
- The Controller can change channels at the Cable Box only during a timer recording.

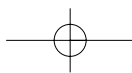

Setting the Controller to Operate a DBS 53

- If you use a DBS, you must set the clock manually. *Details are on pages 14-15.*
- Complete the steps on page 28 before proceeding. This will allow you to use the VCR remote control to operate the DBS, and you will learn your DBS code.

1

Turn on the DBS. Select a channel other than 205.

2

Press the VCR button, then press the MENU button.

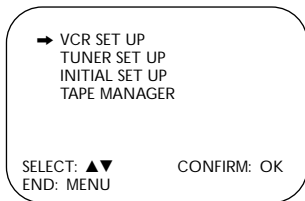

3

Press the PLAY ▲ or STOP ▼ button to select INITIAL SET UP, then press the OK/STATUS button.

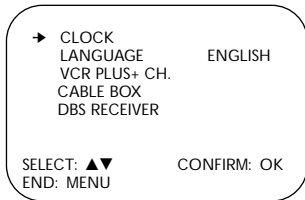

4

Press the PLAY ▲ or STOP ▼ button to select DBS RECEIVER, then press the OK/STATUS button.

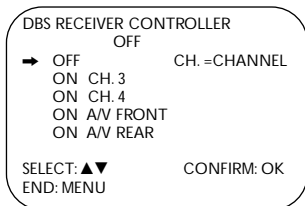

5

Press the PLAY ▲ or STOP ▼ button to select the output channel of your DBS receiver, then press the OK/STATUS button. The display shown below will appear. If DBS RECEIVER USERS SET CLOCK MANUALLY appears, follow steps 4-8 on page 15, then go to step 6 on page 54.

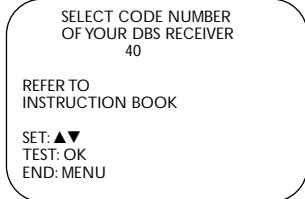

Instructions continue on page 54.

1 Turn on the DBS. Select a channel other than 205.

2

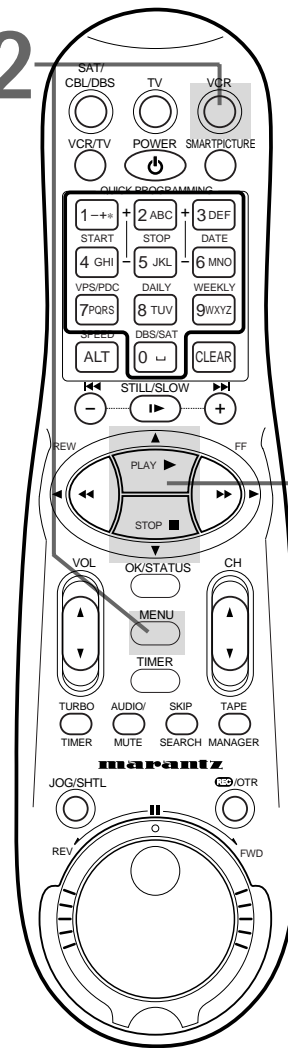

Helpful Hint

- The Controller can change channels at the DBS only during a timer recording.

54 Setting the Controller to Operate a DBS (cont'd)

6

Press the **PLAY ▲** or **STOP ▼** button to set the two-digit code for your DBS (see list below), then press the **OK/STATUS** button.

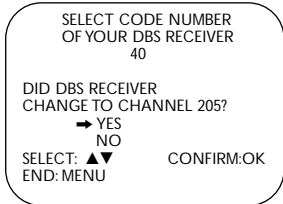

DBS CODES	
MAGNAVOX DBS	42, 43
RCA DBS.....	40
SONY DBS.....	41

7

Wait for a few seconds.

- If the DBS changes to channel 205, go to step 8.
- If the DBS doesn't change to channel 205, press the **PLAY ▲** or **STOP ▼** button to select **NO**, then press the **OK/STATUS** button. Repeat steps 6-7, using a different code for your brand (if available).
- If the DBS does not respond to any of the codes, press the **MENU** button to remove the menu. **DBS RECEIVER CONTROL IS OFF** will appear on the screen briefly.

8

Press the **PLAY ▲** or **STOP ▼** button to select **YES**, then press the **OK/STATUS** button. "DBS RECEIVER CONTROL IS ON" will appear for five seconds. "AS A RESULT AUTO CLOCK WILL BE TURNED OFF" may appear on the screen also.

7

Wait for a few seconds.

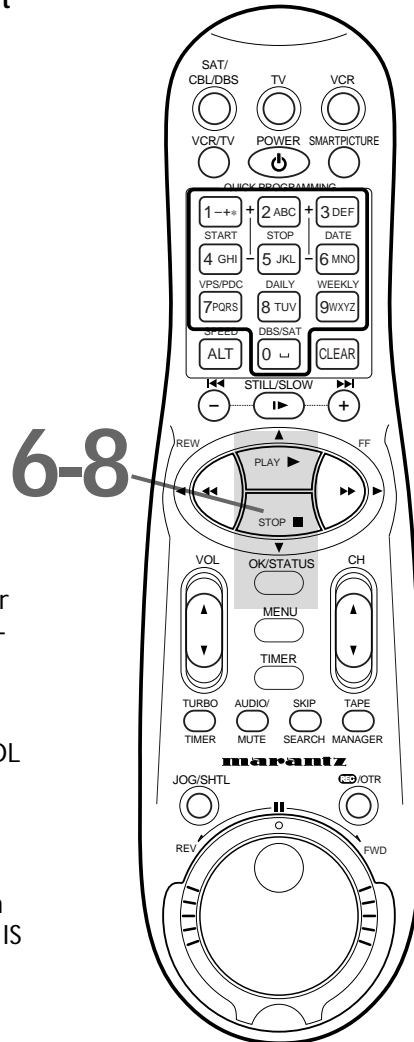

Helpful Hint

- If your DBS does not respond to the code at step 7, the Controller will not change channels at the DBS during a timer recording. In this case, you must select the channel to be recorded at the DBS before a timer recording begins. Enter the DBS output channel (03 or 04) at step 3 on page 40. Leave the DBS on for the timer recording. Details are on page eight.

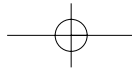

Multi-Channel Television Sound System 55

This VCR can receive and record programs broadcast in stereo or second audio. It can also play back tapes recorded in stereo or second audio.

- **Second Audio** You can program your VCR so you can hear a program that is being broadcast in second audio or a tape that was recorded in second audio. A second audio broadcast is usually a program in a second language. Follow the steps on page 56 to receive or record this type of program.
- **Hi-Fi Stereo Playback** If a tape is recorded in stereo, you can program your VCR to play a tape in Hi-Fi (high fidelity) stereo. Follow the steps on page 57.
- **Hi-Fi Stereo Recording** If a TV program is broadcast in stereo, you can program your VCR to receive and record the program in Hi-Fi stereo. You must program the VCR and make the appropriate stereo hookups. Follow the steps on page 56. To playback this type of program, follow the steps on page 57.

Receiving a Stereo Broadcast

When a TV program is being broadcast in stereo, STEREO will appear in the on-screen status display. You still have to program your VCR to receive and record the stereo broadcast. Follow the steps on page 56.

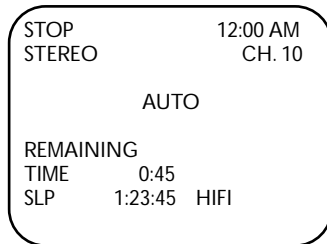

Receiving a Second Audio Program

If a program is being broadcast in second audio, SAP (Second Audio Program) will appear in the on-screen status display. You still have to program your VCR to receive and record the second audio program. Follow the steps on page 56.

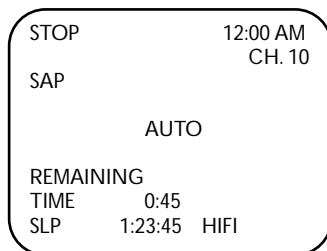

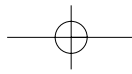

56 Multi-Channel Television Sound System (cont'd)

To receive and record programs broadcast in second audio, follow steps 1-6. To receive and record a program broadcast in stereo, make one of the connections shown, then follow steps 1-6.

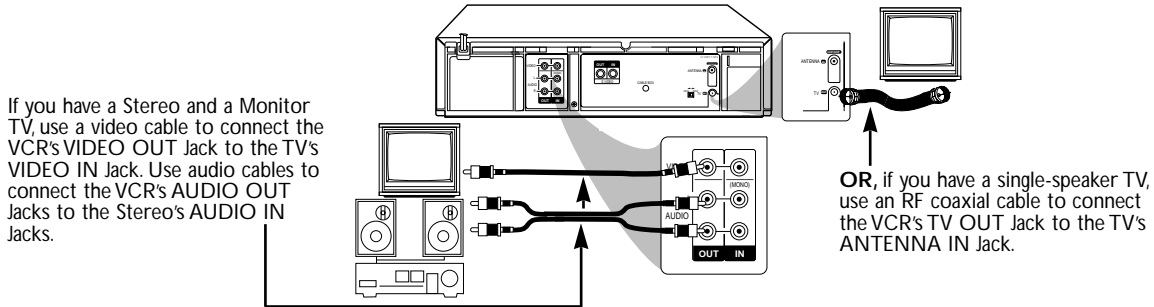

1

Press the VCR button, then press the MENU button.

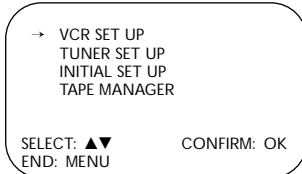

2

Press the PLAY ▲ or STOP ▼ button to select VCR SET UP, then press the OK/STATUS button.

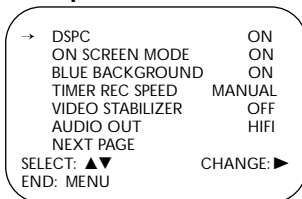

3

Press the PLAY ▲ or STOP ▼ button to select NEXT PAGE, then press the PLAY ▲ or STOP ▼ button to select STEREO/SAP on the second page of the VCR SET UP menu.

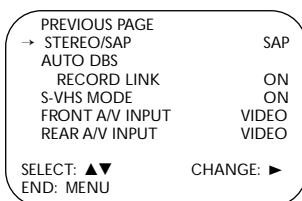

4

Press the FF ► button to select SAP (for a Second Audio Program) or STEREO, whichever you prefer.

5

Press the MENU button.

6

Record the program as usual. Details are on page 30.

Helpful Hints

- If you want to connect the VCR to a Stereo TV, follow these steps.
 - 1) Connect the antenna or cable signal to the VCR's ANTENNA IN jack.
 - 2) Use stereo audio cables to connect the VCR's AUDIO OUT jacks to the TV's AUDIO IN jacks.
 - 3) Use a video cable to connect the VCR's VIDEO OUT jack to the TV's VIDEO IN jack. (Or, to improve picture quality, you may connect an S-Video cable to the S-VIDEO OUT jack on the VCR and to the S-VIDEO IN jack on the TV instead.)
- Make sure the TV and the Stereo (if applicable) are in Line Input or Auxiliary mode. Please refer to your TV or Stereo owner's manual for details.

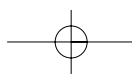

Hi-Fi Stereo Tape Playback 57

If a tape is recorded in Hi-Fi stereo, follow the steps below to play the tape in Hi-Fi stereo.

1

Press the **VCR** button, then press the **MENU** button.

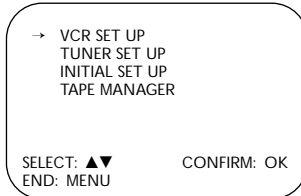

2

Press the **PLAY** ▲ or **STOP** ▼ button to select **VCR SET UP**, then press the **OK/STATUS** button.

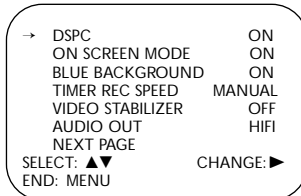

3

Press the **STOP** ▼ button repeatedly to select **AUDIO OUT** on the first page of the **VCR SET UP** menu, then press the **FF** ► button so that **HIFI** appears beside **AUDIO OUT**.

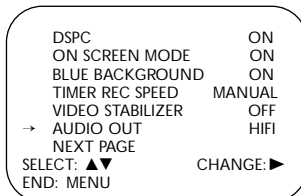

4

Press the **MENU** button.

5

Press the **PLAY** ▲ button to start tape playback.

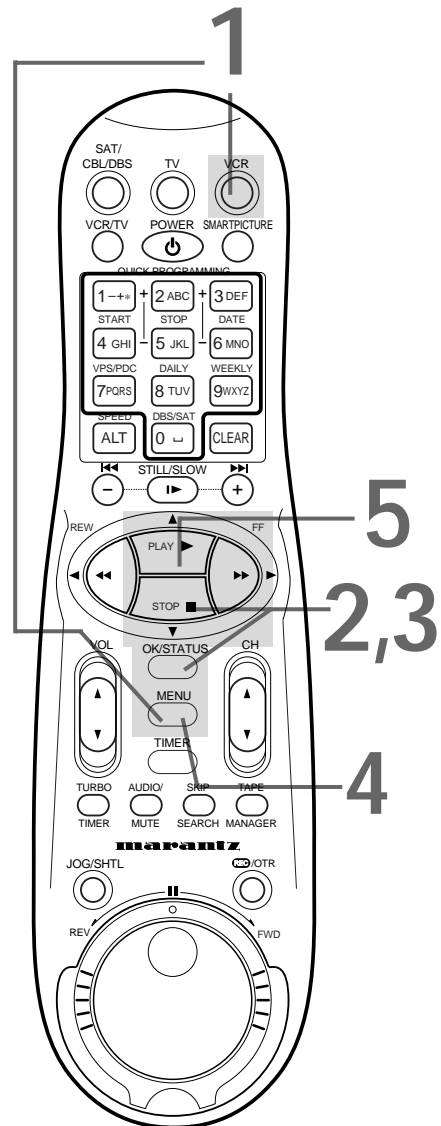

Helpful Hints

- During playback, Hi-Fi stereo may temporarily revert to normal audio when you adjust tracking. This is normal.
- If Hi-Fi stereo continually reverts to normal audio during playback, you may want to press the **FF** ► button to select **MONO** at step 3.
- Only tapes recorded in Hi-Fi stereo will play in Hi-Fi stereo. Tapes recorded in normal audio will play in normal audio.
- You may also select **HIFI** or **MONO** by pressing the **VCR** button, then repeatedly pressing the **AUDIO/MUTE** button on the remote control.

58 Video Stabilizer

You can correct vertical vibration when playing back tapes. When VIDEO STABILIZER is set to ON, vertical vibration will be corrected automatically. Follow the steps below to set VIDEO STABILIZER to ON or OFF.

1

Press the VCR button, then press the MENU button.

→ VCR SET UP	
TUNER SET UP	
INITIAL SET UP	
TAPE MANAGER	
SELECT: ▲▼	CONFIRM: OK
END: MENU	

2

Press the PLAY ▲ or STOP ▼ button to select VCR SET UP, then press the OK/STATUS button.

→ DSPC	ON
ON SCREEN MODE	ON
BLUE BACKGROUND	ON
TIMER REC SPEED	MANUAL
VIDEO STABILIZER	OFF
AUDIO OUT	HIFI
NEXT PAGE	
SELECT: ▲▼	CHANGE: ►
END: MENU	

3

Press the STOP ▼ button repeatedly to select VIDEO STABILIZER on the first page of the VCR SET UP menu, then press the FF ► button so that ON (or OFF) appears beside VIDEO STABILIZER.

DSPC	ON
ON SCREEN MODE	ON
BLUE BACKGROUND	ON
TIMER REC SPEED	MANUAL
→ VIDEO STABILIZER	ON
AUDIO OUT	HIFI
NEXT PAGE	
SELECT: ▲▼	CHANGE: ►
END: MENU	

4

Press the MENU button.

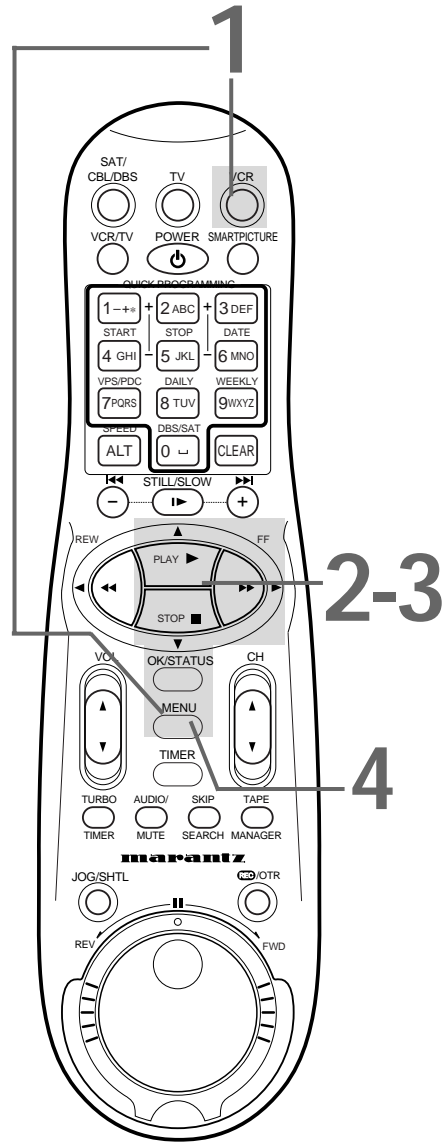

Helpful Hint

- Regardless of the setting, this feature has no effect during recording or special effects playback.

SmartPicture 59

You can make the tape playback picture softer, sharper, more natural, or more distinct by adjusting the SmartPicture setting. Follow the steps below to adjust the SmartPicture setting.

1

Press the VCR button, then press the SMARTPICTURE button. The current setting will appear on the screen for about five seconds.

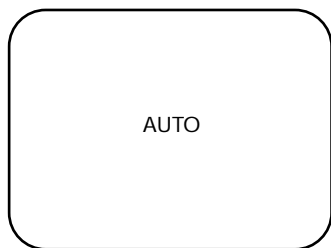

2

While the setting appears, press the SMARTPICTURE button repeatedly to choose DISTINCT, SOFT, SHARP, or AUTO/NATURAL (depending on the setting of DSPC).

AUTO/NATURAL: This is generally the preferred setting. If DSPC is ON, AUTO will be selected automatically. This means the VCR is setting the picture quality with DSPC. If DSPC is OFF, the SmartPicture setting may be NATURAL, meaning the original picture appears and the VCR does not adjust the picture quality. *Details about DSPC are on page 60.*

DISTINCT: Choose to emphasize details in the picture.

SOFT: Choose to soften the picture.

SHARP: Choose to emphasize the edge of the picture.

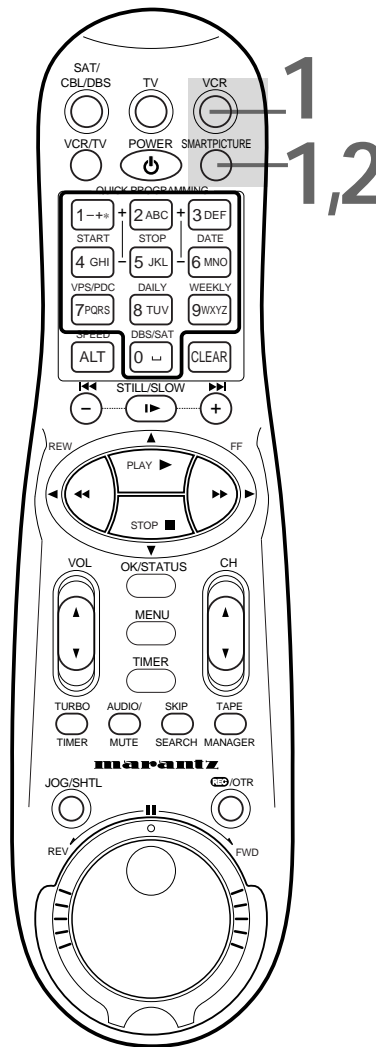

60 Digital Studio Picture Control

The Digital Studio Picture Control (DSPC) checks the condition of the tape during recording and playback, then makes adjustments to provide the highest possible picture quality. To set DSPC to ON or OFF, follow these steps.

1

Press the VCR button, then press the MENU button.

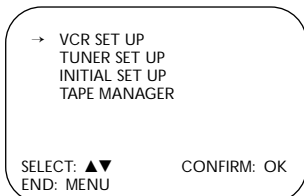

2

Press the PLAY ▲ or STOP ▼ button to select VCR SET UP, then press the OK/STATUS button.

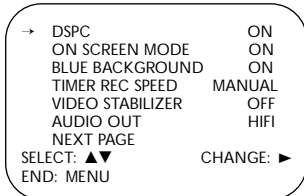

3

DSPC will be selected. Press the FF ► button so that ON appears beside DSPC.

4

Press the MENU button.

If DSPC is ON, the DSPC will work for both playback and recording.

- **For recording**, DSPC will appear briefly on the display panel when you start a recording.
- **For playback**, DSPC will appear briefly on the display panel at the beginning of playback. The VCR will adjust the picture quality based on the condition of the tape in use.

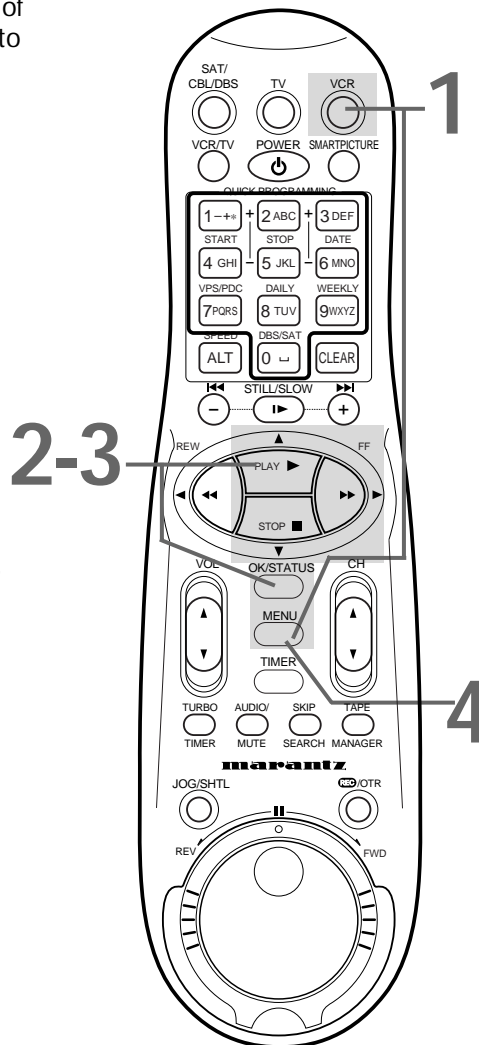

Helpful Hints

- DSPC does not work during a Record Link.
- DSPC makes its adjustments before a timer recording begins.
- Since DSPC makes its adjustments before recording actually starts, there is a brief delay after the REC(ord)/OTR button is pressed. To begin recording immediately, set DSPC to OFF.
- If you stop or pause recording or playback, DSPC may not appear on the display panel when you resume recording or playback. DSPC may appear on the display panel only immediately after you insert a tape and begin recording or playback.

Search Options 61

Index Search

When you make a recording, the VCR automatically places an index code at the beginning of the recording. Essentially, an index code is a type of "bookmark" for your tape. This feature is useful if you have several different programs recorded on a single tape.

Fast forward or rewind to the next or previous index code on the tape by following the steps below.

1

Press the VCR button. Make sure the VCR is in VCR position. (The VCR light will appear on the display panel when the VCR is in VCR position.) **If the VCR light does not appear, press the VCR/TV button once.**

2

Insert a tape in the VCR. Press the ►►/STILL/SLOW + button to fast forward to the next index code on the tape. Or, press the ◀◀/STILL/SLOW - button to rewind to the previous index code on the tape (or to the beginning of the current recording). Wait for the VCR to fast forward or rewind the tape. When the index code is reached, tape playback will begin automatically.

NOTE: You may press an ►►/STILL/SLOW + button repeatedly to skip over multiple recordings. For example, if you want to fast forward past four recordings, press the ►►/STILL/SLOW + button four times. INDEX 4 will appear in the bottom right corner of the screen. The index codes will count down on the screen as the search progresses. (ON SCREEN MODE can not be set to OFF. Details are on page 26.)

Skip Search

This function enables you to skip forward 30 seconds at a time during tape playback.

1

During tape playback, press the VCR button, then press the SKIP SEARCH button. Each time you press the SKIP SEARCH button, the VCR will skip forward 30 seconds, then resume normal playback. You can skip up to two minutes at a time using Skip Search.

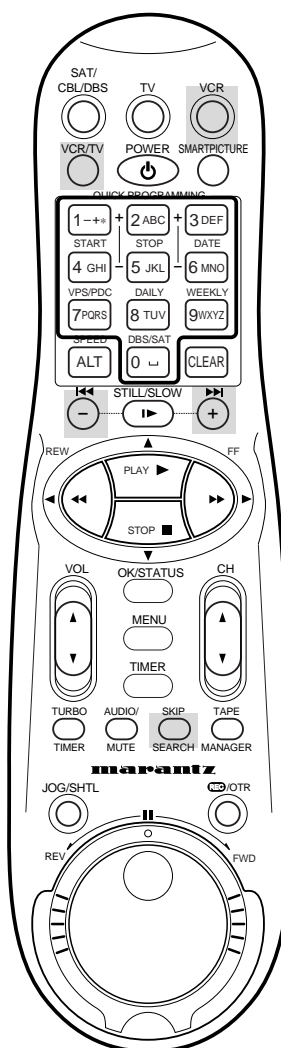

Helpful Hints

- To stop an Index Search that is in progress, press the STOP ▼ button.
- The VCR does not place an index code at the point where a recording is paused, then resumed.
- INDEX may flash on the screen briefly when you begin a recording.
- Press the STOP ▼ button to cancel a Skip Search.
- If the end of the tape is reached during a Skip Search, the VCR will cancel the search and rewind the tape.
- While the tape is searching for the tape number after inserting the tape, the Index Search will not function.

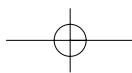

62 Playback Options

Forward and Reverse Searching

1

During tape playback, press and release the **FF ►** button or the **REW(ind) ◀** button. A fast forward or reverse picture search will begin.

2

To return to playback, press the **PLAY ▲** button.

Viewing a Still Picture

1

During tape playback, press the **STILL/SLOW ►** button. A still picture will appear on the screen.

2

To advance the still picture frame by frame, press the **STILL/SLOW ►** button repeatedly.

3

To return to playback, press the **PLAY ▲** button.

Viewing a Slow Motion Picture

1

During tape playback, press and hold the **STILL/SLOW ►** button for three seconds. The tape will play in slow motion.

2

During slow motion playback, press the **◀◀/STILL/SLOW -** button once to slow the speed of slow motion playback. Press the **◀◀/STILL/SLOW -** button again; the tape will play in reverse slow motion. During slow motion playback, press the **▶▶/STILL/SLOW +** button to quicken the slow motion playback or to change from reverse slow motion playback to forward slow motion playback.

3

To return to normal playback, press the **PLAY ▲** button.

Repeat Playback

1

Press and hold the **PLAY ▲** button until the **▷** light flashes on the display panel. Now, when a tape has finished playing, the VCR will rewind it and start playback again. The VCR will play the tape 100 times. The **▷** light on the display panel will flash during tape playback and while rewinding. TV programming will appear while the tape is rewinding.

Repeat Playback will be cancelled if you press the **STOP ▼**, **STILL/SLOW ►**, **FF ►**, or **REW(ind)◀** buttons.

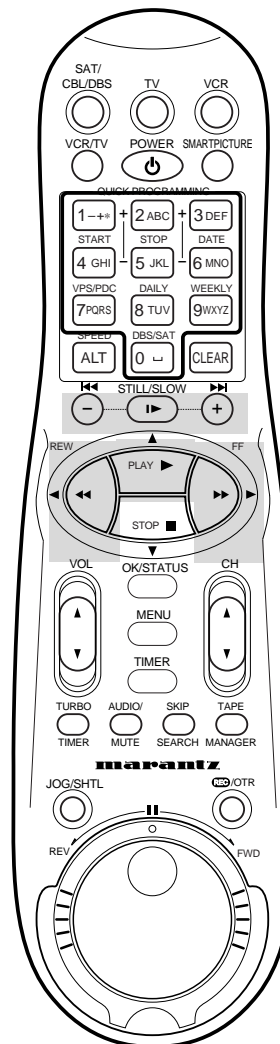

Helpful Hints

- During Search, Slow, and Still modes, there will be no sound.
- Slow and Still modes automatically switch to Stop mode after five minutes to protect the VCR and the tape from damage.
- During Forward or Reverse Searching, noise bars will appear on the screen.
- You may only view a tape in Slow Motion if the tape is recorded in SP or SLP speed.
- You may press and hold the **FF ►** button or the **REW(ind) ◀** button for a fast forward or reverse picture search. When you release the button, normal playback will resume.

Playback Options (cont'd) 63

Viewing Picture in Slow to Fast Motion

1

First, press the JOG/SHTL (shuttle) button while in the Play or Still mode. The JOG/SHTL button will light.

2

Next, turn the outer ring (the Shuttle ring) in either direction. The farther the ring is rotated, the faster the search speed. Releasing the ring stops the picture in the Still mode.

3

Or, turn the inner dial (the Jog Dial) in either direction. The tape will move frame-by-frame at the speed with which the dial is turned.

4

Press PLAY ▲ button to release the Still mode.

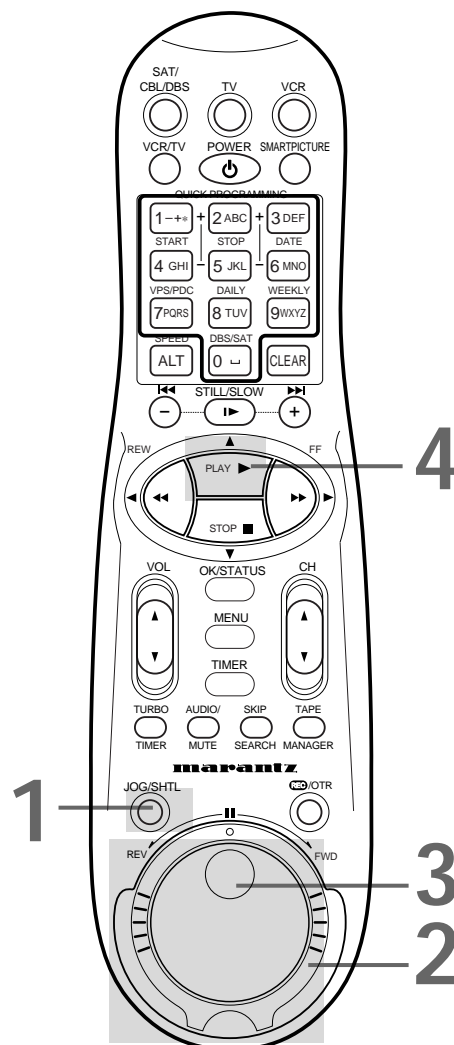

Helpful Hints

- The Jog/Shuttle Light goes off after 60 seconds if no buttons are pressed.
- You can use the Shuttle Ring/Jog Dial on the VCR in the same manner as the Shuttle Ring/Jog Dial on the remote control.

64 Tape Manager

Introduction

The Tape Manager Feature is a very helpful and powerful assistant. The Tape Manager will tell you;

- on which tape you find your recorded programs.
 - on which tape you find enough blank space for new recordings.
- Every recording will be memorised (date, start and stop time, length and channel) and tapes will be given unique numbers to identify them.

Find a Title

This function is useful when you wish to quickly find out what programs you have recorded on a tape using this VCR. It allows you to select a program to watch, and then automatically searches for the start of the program.

1

Insert a tape recorded with this VCR.

The tape will run for a few seconds to search for the tape number. Then tape number is displayed on the screen for about 5 seconds.

2

Press the VCR button, then press the TAPE MANAGER button. The directory screen will appear.

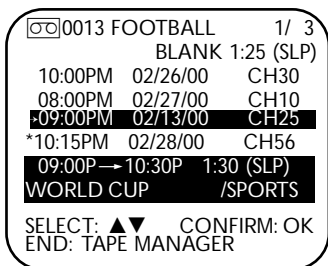

- If no cassette is inserted in the VCR, "FIND TITLE" screen appears. See page 68.

3

Press the PLAY ▲ or STOP ▼ button to select the program you want to watch.

4

Press the OK/STATUS button. Playback begins automatically after the selected program is located. Press the STOP ■ button if you wish to stop the tape at the beginning of the program.

How to read the Tape Manager Directory Screen

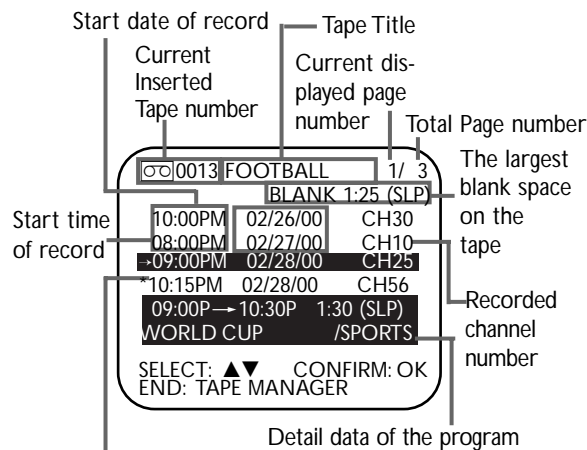

*** mark is displayed at the current tape position

Detail data of the program pointed by the cursor; recording start and stop time/Total recording time/tape speed/Program Title/Category

Helpful Hints

- It may take a few seconds to display the directory screen while the VCR searches for the program information at step 2.
- Tape Manager is possible with the cassettes recorded with this VCR only.
- To record the date and time as the program title in this VCR's memory, make sure the VCR's clock is set correctly before recording.
- To record the program information in this VCR's memory, you must record each program for over the minimum continuous recording time; 5 min. for the SP mode or 15 min. for the SLP mode.
- After recording a tape with this VCR, write the tape number on a label and affix the label to the tape in order to allow you to find the tape by its number. The tape number will be assigned and appear on the screen once you eject the recorded tape.
- If the Tape Manager does not show the content of the inserted tape, wind the tape to recent recording and press the TAPE MANAGER button again.
- The program information is stored in this VCR's memory. If the memory in this VCR should ever be damaged and the program information lost, it is impossible to restore that information.

66 Tape Manager (To Edit Tape Title and/or Program Title)

Title Editing

When you record a TV program with this VCR, the VCR automatically records the recording start and stop time, date and channel in each program title. If the tape is recorded for the first time, the tape number and the date are recorded in the tape title. You can then edit the tape title and the program titles as you like. You can also edit the category in the program title.

1

Press the VCR button, then press the MENU button. The Menu screen appears. Press the PLAY ▲ or STOP ▼ button to select TAPE MANAGER, then press the OK/STATUS button.

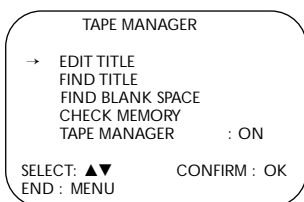

2

Press the PLAY ▲ or STOP ▼ button to select EDIT TITLE, then press the OK/STATUS button. The tape preview screen will appear.

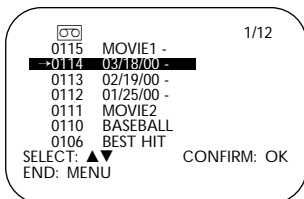

3

Press the PLAY ▲ or STOP ▼ button to select the tape you want to edit, then press the OK/STATUS button.

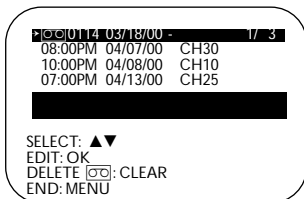

4

To edit the Tape Title, press the OK/STATUS button. To edit the Program Title and Category, skip to step 6.

5

Press the Number buttons to enter characters, then press the OK/STATUS button. Refer to "Entering Character" on the next page. To edit the Program Title and Category as well, go to step 6. To finish the Title Editing, go to step 9.

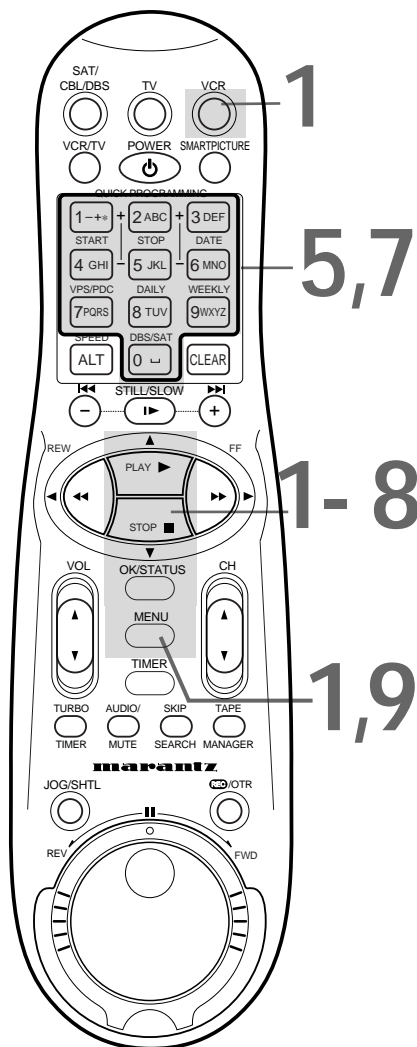

Tape Manager (To Edit Tape Title and/or Program Title) (cont'd) 67

6

To edit the Program Title and Category, press the PLAY ▲ or STOP ▼ button to select the program you want to edit, then press the OK/STATUS button.

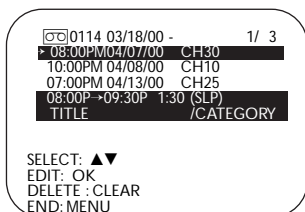

7

Press the Number buttons to enter characters for the program title, then press the OK/STATUS button. Refer to "Entering Character" in the next column.

8

Press the PLAY ▲ or STOP ▼ button to select category, then press the OK/STATUS button. Every time you press the PLAY ▲ or STOP ▼ button, the setting will change as follows;

Choice of Category



9

Press the MENU button .

Entering Character

Press the Number button, then press the FF ► button to enter each character. Refer to the example below; (Ex.) Enter "CNN NEWS"

- 1 Press the Number button 2 (ABC) three times to enter "C", then press the FF ► button.
- 2 Press the Number button 6 (MNO) twice to enter "N", then press the FF ► button.
- 3 Press the Number button 6 (MNO) twice to enter "N", then press the FF ► button.
- 4 Press the Number button 0 () twice to enter " " (space)", then press the FF ► button.
- 5 Press the Number button 6 (MNO) twice to enter "N", then press the FF ► button.
- 6 Press the Number button 3 (DEF) twice to enter "E", then press the FF ► button.
- 7 Press the Number button 6 (WXYZ) once to enter "W", then press the FF ► button.
- 8 Press the Number button 7 (PQRS) four times to enter "S", then press the FF ► button.

NUMBER BUTTON	CHARACTER
1	. , ? - + * / () 1
2	A B C 2 Ä Å À Á Â Ã Ç
3	D E F 3 Ê Ë É Ë
4	G H I 4 Î Ï Í
5	J K L 5
6	M N O 6 Ñ Ö Ô Ò Ó Õ
7	P Q R S 7
8	T U V 8 Ü Ú Ú Û
9	W X Y Z 9
0	0 _

- If you make a mistake, press the REW ◀ or FF ► button to select the character, then enter the correct character.
- If you want to delete a character, press the REW ◀ or FF ► button to select the character, then press the CLEAR button.

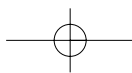

68 Tape Manager (To Find a Desired Program)

There are three ways to find which tape the desired program was recorded on.

- **Sorting by Tape Number**; This function is useful for finding what program was recorded on each tape. To find the desired program using "Sorting by Tape Number", follow the steps below.
- **Sorting by Date**; This function is useful for finding if you remember when the desired program was recorded. To find the desired program using "Sorting by Date", go to page 69.
- **Sorting by Category**; This function is useful for finding if you remember what category the desired program was sorted in. To find the desired program using "Sorting by category", go to page 70.

Sorting by Number

1

Press the **VCR** button, then press the **MENU** button. The Menu screen appears. Press the **PLAY ▲** or **STOP ▼** button to select **TAPE MANAGER**, then press the **OK/STATUS** button.

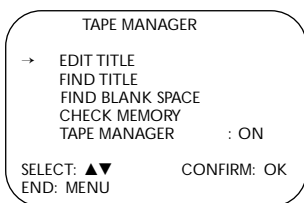

2

Press the **PLAY ▲** or **STOP ▼** button to select **FIND TITLE**, then press the **OK/STATUS** button.

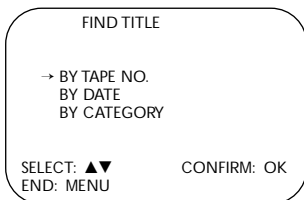

3

Press the **PLAY ▲** or **STOP ▼** button to select **BY TAPE NO.**, then press the **OK/STATUS** button.

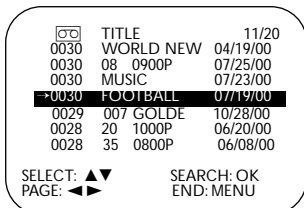

4

The program title is sorted by the tape number. Press the **PLAY ▲** or **STOP ▼** button to select the title you want, then press the **OK/STATUS** button.

If the tape inserted in the VCR corresponds to the required tape number;

The VCR searches and starts playback when the selected program is located.

If the tape inserted in the VCR does not correspond to the required tape number;

"INSERT TAPE 0030 (example)" appears and the tape is ejected. Insert the correct tape. The VCR searches and starts playback when the selected program is located.

If no cassette is inserted in the VCR;

"INSERT TAPE 0030 (example)" appears. Insert the correct tape. The VCR searches and starts playback when the selected program is located.

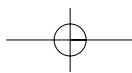
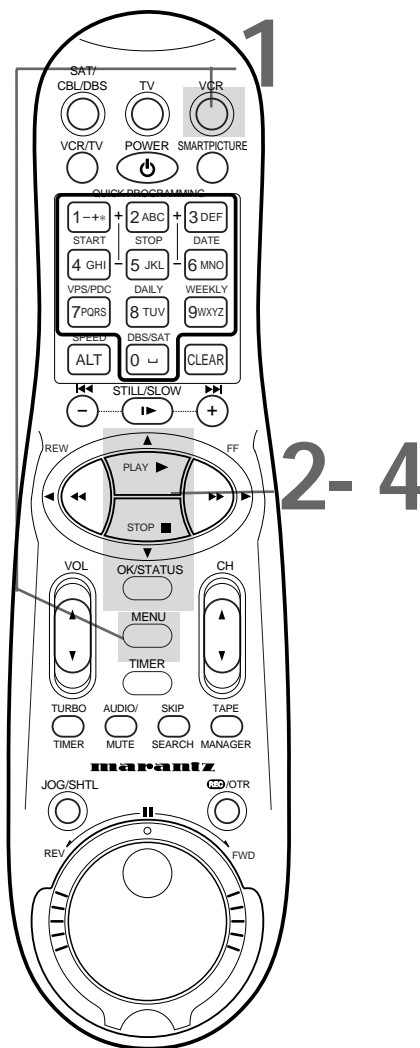

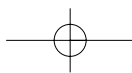

Tape Manager (To Find a Desired Program) (cont'd) 69

Sorting by Date

1

Press the VCR button, then press the MENU button. The Menu screen appears. Press the PLAY ▲ or STOP ▼ button to select TAPE MANAGER, then press the OK/STATUS button.

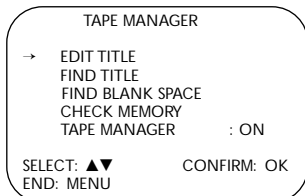

2

Press the PLAY ▲ or STOP ▼ button to select FIND TITLE, then press the OK/STATUS button.

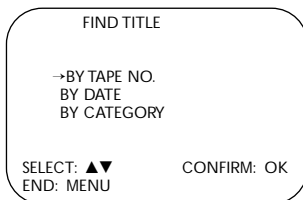

3

Press the PLAY ▲ or STOP ▼ button to select BY DATE, then press the OK/STATUS button.

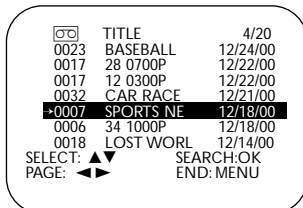

4

The program title is sorted by date. Press the PLAY ▲ or STOP ▼ button to select the title you want, then press the OK/STATUS button.

If the tape inserted in the VCR corresponds to the required tape number;

The VCR searches and starts playback when the selected program is located.

If the tape inserted in the VCR does not correspond to the required tape number;

"INSERT TAPE 0007 (example)" appears and the tape is ejected. Insert the correct tape. The VCR searches and starts playback when the selected program is located.

If no cassette is inserted in the VCR;

"INSERT TAPE 0007 (example)" appears. Insert the correct tape. The VCR searches and starts playback when the selected program is located.

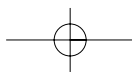
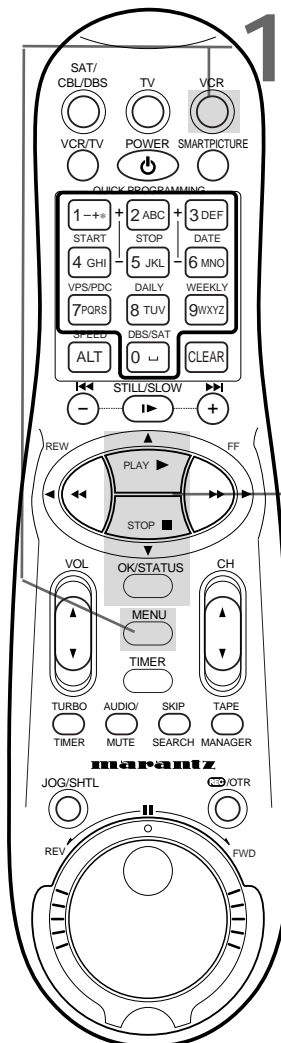

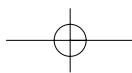

70 Tape Manager (To Find a Desired Program) (cont'd)

Sorting by Category

1

Press the VCR button, then press the MENU button. The Menu screen appears. Press the PLAY ▲ or STOP ▼ button to select TAPE MANAGER, then press the OK/STATUS button.

2

Press the PLAY ▲ or STOP ▼ button to select FIND TITLE, then press the OK/STATUS button.

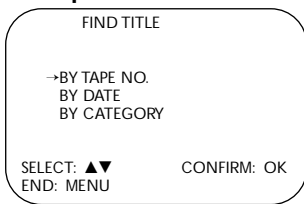

3

Press the PLAY ▲ or STOP ▼ button to select BY CATEGORY, then press the OK/STATUS button.



4

Press the PLAY ▲ or STOP ▼ button to select the category you want, then press the OK/STATUS button.

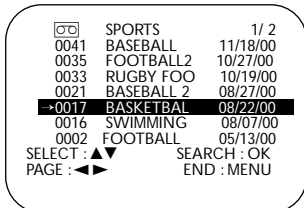

5

The program title is sorted by category. Press the PLAY ▲ or STOP ▼ button to select the title you want, then press the OK/STATUS button.

If the tape inserted in the VCR corresponds to the required tape number;

The VCR searches and starts playback when the selected program is located.

If the tape inserted in the VCR does not correspond to the required tape number;

"INSERT TAPE 0017 (example)" appears and the tape is ejected. Insert the correct tape. The VCR searches and starts playback when the selected program is located.

If no cassette is inserted in the VCR;

"INSERT TAPE 0017 (example)" appears. Insert the correct tape. The VCR searches and starts playback when the selected program is located.

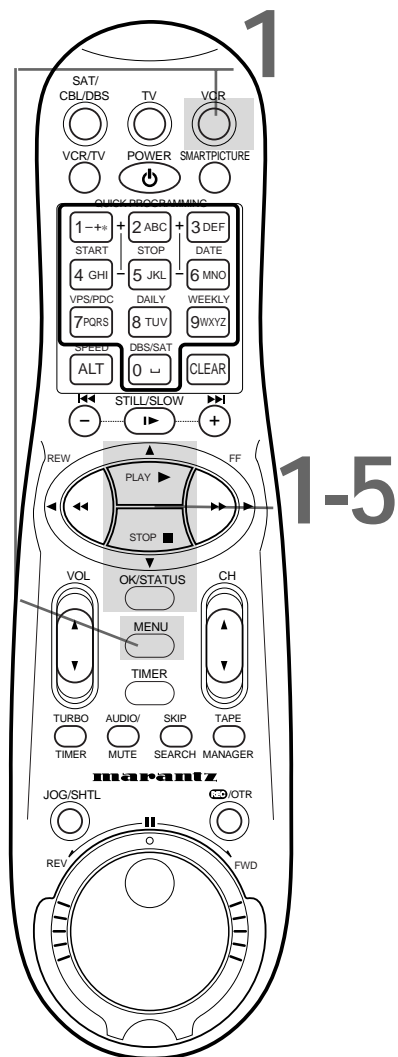

Tape Manager (To Find a Blank Space) (cont'd) 71

With this function, you can find the blank space on each tape and use the space for recording.

1

Press the **VCR** button, then press the **MENU** button. The Menu screen appears. Press the **PLAY ▲** or **STOP ▼** button to select **TAPE MANAGER**, then press the **OK/STATUS** button.

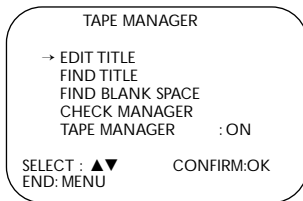

2

Press the **PLAY ▲** or **STOP ▼** button to select **FIND BLANK SPACE**, then press the **OK/STATUS** button. The list of blank space on each tape appears on the screen with the blank space length sorted. The blank space length is displayed with the current selected tape speed.

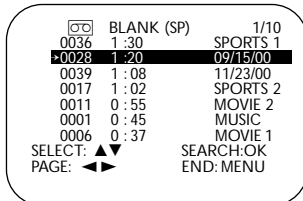

3

Press the **PLAY ▲** or **STOP ▼** button to select the tape number you want, then press the **OK/STATUS** button.

If the tape inserted in the VCR corresponds to the required tape number;
The VCR searches and stops when the selected blank space is located.

If the tape inserted in the VCR does not correspond to the required tape number;
"INSERT TAPE 0028 (example)" appears and the tape is ejected. Insert the correct tape. The VCR searches and stop when the selected blank space is located.

If no cassette is inserted in the VCR;
"INSERT TAPE 0028 (example)" appears. Insert the correct tape. The VCR searches and stop when the selected blank space is located.

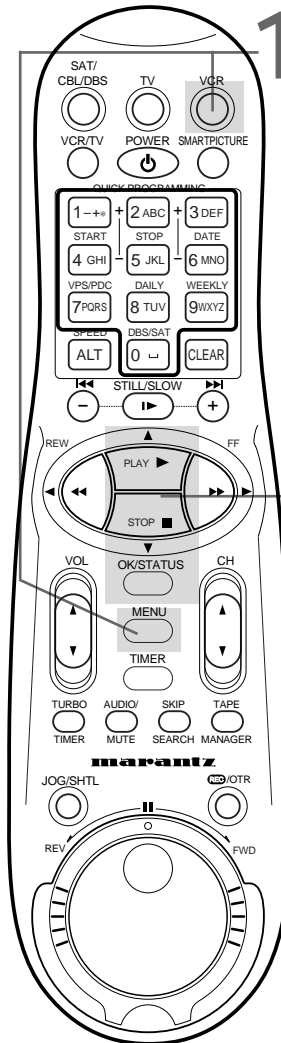

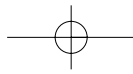

72 Tape Manager (To Delete Tape from Program Data)

Delete Tape Data

If you do not want to keep data of a particular tape in the Tape Manager memory, this function is useful to release memory.

Delete Program Data

If you want to delete a program data from the Tape Manager memory, this function is useful to increase blank space.

1

Press the VCR button, then press the MENU button. The Menu screen appears. Press the PLAY ▲ or STOP ▼ button to select TAPE MANAGER, then press the OK/STATUS button.

2

Press the PLAY ▲ or STOP ▼ button to select EDIT TITLE, then press the OK/STATUS button. The tape preview screen will appear;

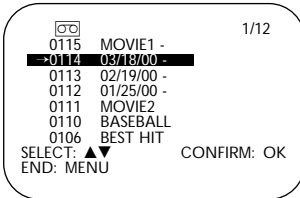

3

Press the PLAY ▲ or STOP ▼ button to select the tape you want to edit, then press the OK/STATUS button.

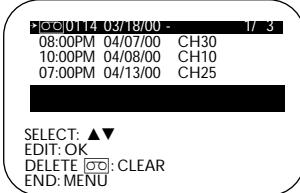

4

To delete the tape data, Press the CLEAR button. To delete the program data, press the PLAY ▲ or STOP ▼ button to select the program you want to delete, then press the CLEAR button.

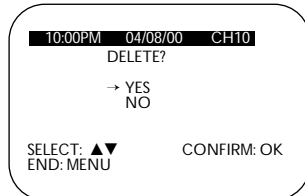
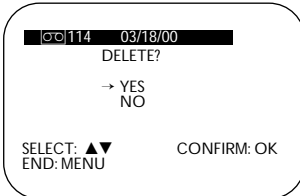

5

Press the PLAY ▲ or STOP ▼ button to select "YES", then press the OK/STATUS button.

6

Press the MENU button.

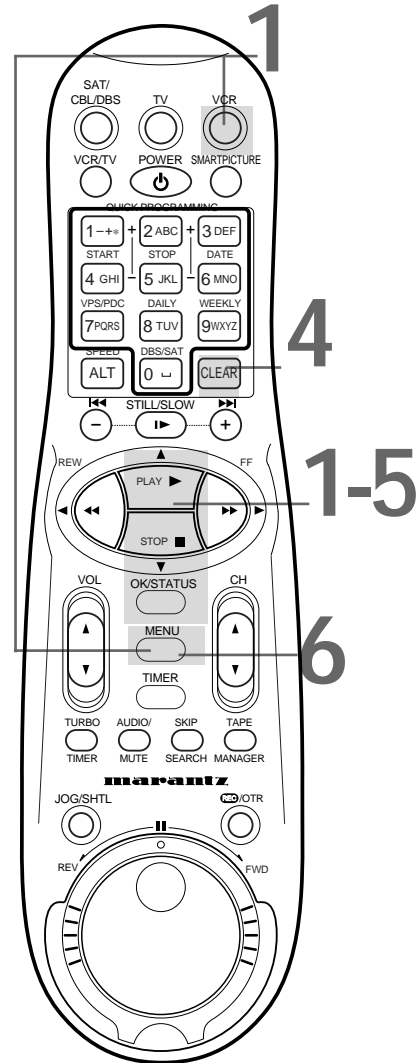

Helpful Hint

- When you delete data, only the tape and/or program information in the Tape Manager memory is deleted. The actual recording on the tape is not erased.

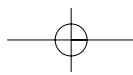

Tape Manager (To Disable Functions) 73

You can disable the Tape Manager functions if you don't want to use it.

1

Press the **VCR** button, then press the **MENU** button.
The Menu screen appears.

2

Press the **PLAY ▲** or **STOP ▼** button to select **TAPE MANAGER**, then press the **OK/STATUS** button.

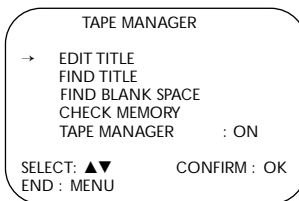

3

Press the **PLAY ▲** or **STOP ▼** button to select **TAPE MANAGER**, then press the **FF ►** button so that **OFF** appears beside **TAPE MANAGER**.

4

Press the **MENU** button.

To re-enable **TAPE MANAGER** Functions, set **TAPE MANAGER** to **ON** pressing the **FF ►** button at step 3 above.

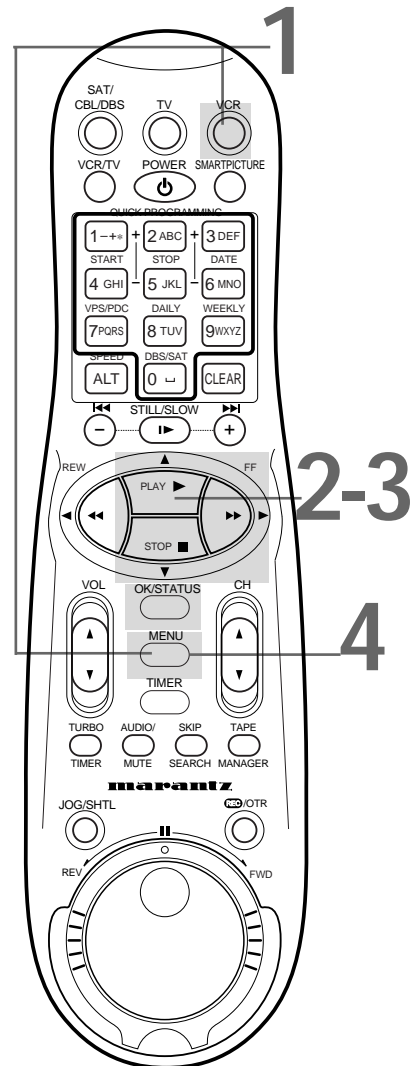

74 Child Lock

The Child Lock feature disables the buttons on the VCR and remote control.

1

When the VCR is on, press the VCR button, then press and hold the POWER button on the remote control for more than 10 seconds until "CL" flashes beside the clock on the display panel. The VCR power will turn off.

When Child Lock is activated...

- "CL" will blink on the display panel.
- The remote control will still operate your TV or Cable Box/DBS if you have set it to do so. Details are on pages 27-28.
- The VCR power will not come on automatically if you insert a tape.
- Timer recordings will take place as scheduled. Make sure a tape is in the VCR before you turn on Child Lock. Make sure the VCR power is off before the recording's scheduled start time. "CL" will reappear and blink on the display panel when the timer recording is finished.
- To stop a timer recording that is in progress, press and hold the POWER button on the remote control for more than 10 seconds. Child Lock will be cancelled and the recording will stop.

2

To cancel Child Lock, press the VCR button, then press and hold the POWER button on the remote control for more than 10 seconds until the VCR power comes on. "CL" will disappear from the display panel.

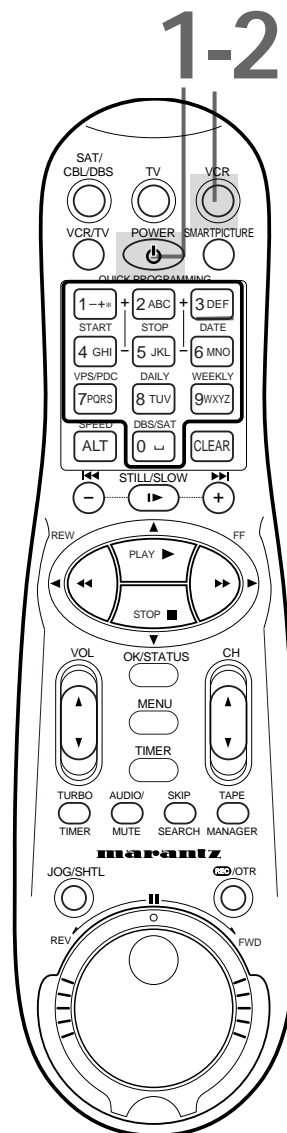

Helpful Hint

- If you lose your remote control when Child Lock is on, contact Philips.

Blue Background 75

If you want the TV screen to be solid blue when a weak signal is received, set BLUE BACKGROUND to ON. The screen will be blue and the sound will be muted. Or, if you want to receive the weak signal, set BLUE BACKGROUND to OFF. When you select a channel that is receiving a weak signal, you will see and hear the static in the TV programming. To set BLUE BACKGROUND to ON or OFF, follow these steps.

1

Press the **VCR** button, then press the **MENU** button.

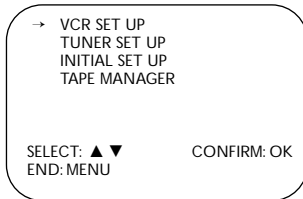

2

Press the **PLAY** ▲ or **STOP** ▼ button to select **VCR SET UP**, then press the **OK/STATUS** button.

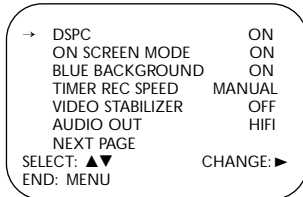

3

Press the **STOP** ▼ button repeatedly to select **BLUE BACKGROUND** on the first page of the **VCR SET UP** menu, then press the **FF** ► button repeatedly so that **ON** or **OFF** appears beside **BLUE BACKGROUND**.

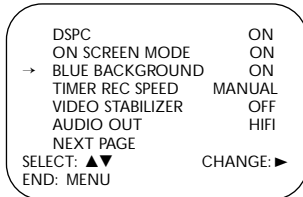

4

Press the **MENU** button.

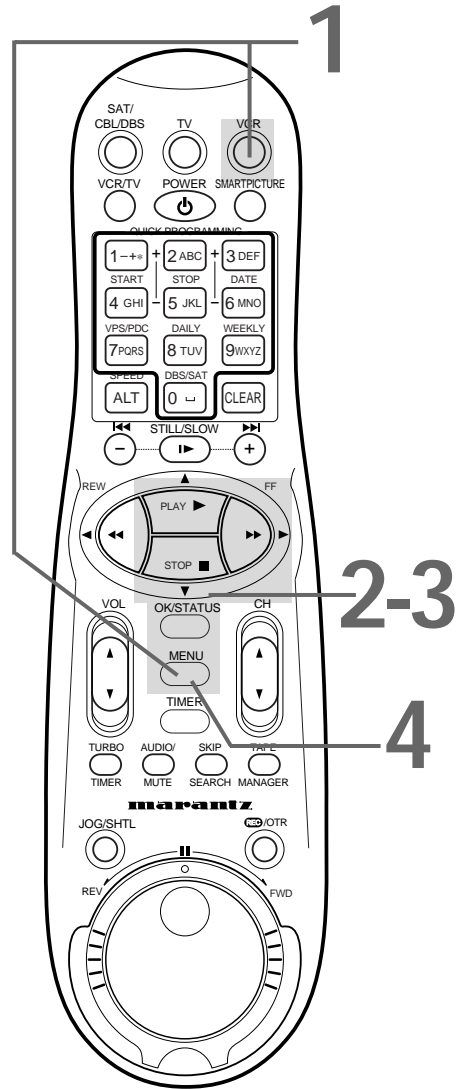

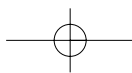

76 Automatic Operation Features

Automatic Playback

When you put a tape in the VCR, the power will come on automatically. If the tape's record tab is missing, playback will begin. You can not insert a tape without a record tab if the VCR power is off and a timer recording is set.

Automatic Rewind

When a tape is played, fast forwarded, or recorded to its end, the VCR will rewind the tape to the beginning, then stop. The VCR will not rewind the tape if the end of the tape is reached during a One-Touch Recording. *Details are on page 34.*

Memory Rewind, Power Off

When the POWER button is pressed while the VCR is rewinding a tape, REWIND→POWER OFF will appear on the screen. When the tape has finished rewinding, the VCR will stop, then turn itself off.

Tape Eject

A tape can be ejected with the VCR power on or off (but the VCR must be plugged in).

If a timer recording is programmed, the ☹ and Cassette-Inside lights will flash on the VCR's display panel after you eject a tape with the VCR power turned off.

Counter Reset

The real-time counter will reset to 0:00:00 when you insert a cassette. To reset the real-time counter to 0:00:00 at anytime, press the CLEAR button on the remote control.

Automatic Tracking Adjustment

The VCR continually adjusts tracking to give you the best possible picture quality. With some recordings, however, you may get a better picture by adjusting the tracking manually (see below).

Manual Tracking Adjustment

- Press the CHANNEL ▲/▼ buttons on the front panel or the CH(annel) ▲/▼ button on the remote control to remove jitter in a still picture.
- The CH(annel) ▲/▼ button adjusts tracking during normal tape playback and slow motion playback.
- To return to Automatic Tracking Adjustment during normal tape playback, press the CHANNEL ▲/▼ buttons **on the VCR at the same time.**
- The VCR returns to Automatic Tracking Adjustment whenever a tape is inserted.
- If USE CLEANING CASSETTE appears on the screen or if "U:01" appears on the display panel, you may need to adjust the tracking. These messages may appear briefly every seven seconds during tape playback. The messages will appear until you adjust the tracking, reinsert the tape, or clean the video heads. *Details are on page 79.*

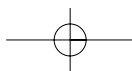
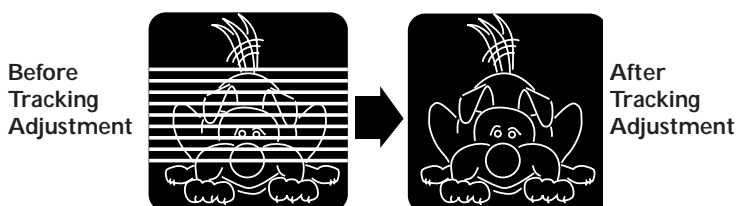

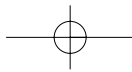

Glossary 77

AUDIO IN/OUT Jacks: jacks located on the front and back of the VCR which are used to record audio from another source (IN) or to send audio to another system (OUT).

Automatic Channel Programming: process in which the VCR scans all available channels and places the ones you receive in its memory. Then, when you press the CH(annel) ▲/▼ button, you only scan through channels you receive.

Bands: settings that allow you to tune channels.

- **Antenna** – VHF (very high frequency; channels 2-13) and UHF (ultra high frequency; channels 14-69).
- **Cable** – standard channels can be received without a Cable Box.

Cable Box/DBS Output Channel: channel 03 or 04.

DBS: Direct Broadcast System.

DSPC: Digital Studio Picture Control.

Dubbing: copying a tape using a second VCR.

Frame: a single still picture.

HQ: high quality; a feature in the VCR circuitry which provides enhanced picture detail.

OTR: one-touch recording; a timed recording that starts immediately and records for 30 minutes to six hours, whichever you specify.

Remote Control: the small electronic unit that came with your VCR; allows you to operate your VCR from a distance. The remote control also may operate some features of your TV, Cable Box, or DBS.

RF coaxial cable: the cable supplied with your VCR. Use it to connect your VCR to your TV (or Cable Box/DBS, if applicable). The supplied cable is a snap-on type. However, you also may use a screw-on type if you prefer.

S-VHS: a recording format that provides finer quality with better resolution. Available on VCRs equipped with S-VHS only.

S-VHS Expansion Technology: a feature that allows you to record with S-VHS format on VHS cassette tapes.

S-VIDEO jack: Use S-VIDEO connections instead of the standard RCA-style (yellow) video connections for better picture quality.

Special Effects: forward and reverse searching; viewing a still picture; or viewing a slow motion picture.

Tape Speeds: how fast the tape travels during a recording or playback.

- **LP (long play)** – average tape speed (playback time for a T120 tape is approximately four hours); available for playback only. Although the VCR will play tapes recorded in LP, LP will not appear on the display panel or in the on-screen status display.
- **SLP (super long play)** – slowest tape speed (recording/playback time for a T120 tape is approximately six hours).
- **SP (standard play)** – fastest tape speed (recording/playback time for a T120 tape is approximately two hours); best picture quality.

VCR: video cassette recorder.

VIDEO IN/OUT Jacks: jacks located on the front and back of the VCR which are used to record video from another source (IN) or to send video to another system

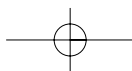

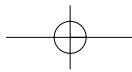

78 Helpful Hints

.....
 If you are having problems with your VCR, check the following list of problems and possible solutions before requesting service. You may be able to solve the problem yourself.

If you need to call a customer service representative, please know the model number and serial number of your product before you call. This information is displayed on the back of the product. Also, please take a moment to identify the problem you are having, and be prepared to explain this to the representative. If you believe the representative will need to help you with operations, please stay near the product. Our representatives will be happy to assist you.

The VCR has no power.

- Make sure the power plug is completely connected to an AC (alternating current) outlet.
- Make sure the power is turned on.
- Turn off the Child Lock. *Details are on page 74.*

A power failure occurred.

- Select a language if prompted to do so. *Details are on page 20.* Reset the clock if necessary. *Details are on pages 14-18.* Timer recordings will be restored after the clock and channel settings are restored. If you are using the AUTO CLOCK feature, the time, channels, and timer recordings will be restored automatically after a power failure. *Details are on page 43.*

The VCR cannot be controlled with the remote control.

- Aim the remote control directly at the VCR's remote sensor. *Details are on page 22.*
- Remove all obstacles between the remote control and the VCR.
- Inspect and/or replace the batteries in the remote control. *Details are on page 5.*
- Press the VCR button, then try the other buttons.
- Turn off the Child Lock. *Details are on page 74.*

The VCR does not respond normally to the remote control. (For example, the VCR may change channels multiple times when you press the CH(annel) ▲ button once.)

- Install new batteries (preferably alkaline) in the remote control.

The VCR will not perform a timer recording.

- Make sure the recording start and stop times are set correctly. *Details are on pages 38-45.*
- Make sure there is a tape in the VCR. Make sure the tape has a record tab. *Details are on page 5.*
- Make sure the VCR power is off.
- Make sure the clock is set. *Details are on pages 14-18.*
- Finish programming a timer recording at least five minutes before the recording is scheduled to begin.
- If the VCR power is turned off for a timer recording and there isn't a tape in the VCR, the ⊕ and Cassette-Inside lights will blink on the display panel.
- If the record tab on a tape is missing and you turn off the VCR to set a timer recording, the VCR will eject the tape. The ⊕ and Cassette-Inside lights will blink on the display panel.
- Noon is 12 p.m.; midnight is 12 a.m.
- If you are using a Cable Box/DBS and are not using the Controller, enter the Cable Box/DBS output channel (03 or 04) at step 3 on page 40, then select the channel to be recorded at the Cable Box/DBS. Leave the Cable Box/DBS on for the timer recording. *Details are on page 8.*
- Make sure no timer recordings overlap. *Details are on page 46.*
- You can not choose a DAILY recording if the program occurs on Saturday or Sunday. *Details are on pages 39 and 42.*

Tape can't be inserted.

- Insert the tape window side up, with the record tab facing you.
- Make sure a tape isn't already in the VCR by pressing the STOP/EJECT button on the VCR or the EJECT button on the remote control.
- Gently push the center of the tape as you put it in the VCR. Never force a tape into the VCR.
- If the power is off and a timer recording is set, you can not insert a tape that is missing its record tab.

Tape can't be removed.

- Make sure the power plug is completely connected to an AC (alternating current) outlet.

The motor (cylinder) rotates even when the VCR is in Stop mode.

- To enable the quick play mechanism, the cylinder will rotate for about five minutes. This is normal. The quick play mechanism enables the tape mechanism to switch from Stop mode to Play mode in one second.

There is no playback picture, or the playback picture is noisy or contains streaks.

- Make sure the TV is on the same channel as the VCR's CH3/CH4 switch. *Details are on pages 6-9.*
- Make sure the VCR is in VCR position. *Details are on pages 22 and 25.*
- Make sure channel 3 or 4 is properly adjusted at the TV.
- Adjust the tracking. *Details are on page 76.*

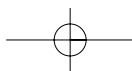

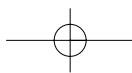

Helpful Hints (cont'd) 79

The Number buttons won't work for channels above 69; channels above 13 cannot be received.

- Select CABLE at the TUNER SET UP menu, then let the VCR set up the channels. *Details are on page 12.*

A TV program cannot be recorded.

- Check the connections between the VCR, TV, antenna/cable, and Cable Box/DBS (if applicable). *Details are on pages 6-9.*
- Make sure channels are programmed correctly. *Details are on pages 12-13.*
- Make sure the tape has a record tab. *Details are on page 5.*

TV programs cannot be watched normally.

- Put the VCR in TV position. *Details are on pages 22 and 25.*
- Check the connections between the VCR, TV, antenna/cable, and Cable Box/DBS (if applicable). *Details are on pages 6-9.*

Line Input mode is selected.

- If you accidentally enter Line Input mode (L-1 or L-F will appear on the display panel), use the CH(annel) ▲/▼ button or the Number buttons to select another channel.

Multi-Channel Television Sound System

- You can only receive and record in stereo or second audio programs that are broadcast in stereo or second audio. You can only play in stereo or second audio tapes that were recorded in stereo or second audio. *Details are on pages 55-57.*
- If you select second audio when second audio is not available, the VCR will record normal audio.
- When you program your VCR to record in stereo, broadcasts are recorded in Hi-Fi stereo.
- You will only get stereo sound if you use audio cables to connect the AUDIO OUT Jacks on the VCR to the AUDIO IN Jacks on your TV. The TV must be in Line Input (or Auxiliary) mode. See your TV owner's manual for details.
- When you connect the AUDIO OUT Jacks on your VCR to the AUDIO IN Jacks on your TV, the stereo light on the TV might not glow. This is normal. If the VCR indicates you are receiving a stereo broadcast, you are. (STEREO will appear in the status display.)

The VCR ejects the tape when the REC(ord)/OTR button is pressed or when the VCR power is turned off to set a timer recording.

- Make sure the tape has a record tab. *Details are on page 5.*

The remote control is not available or the remote control will not access the VCR's on-screen menu.

- Use the front panel buttons to access the menu. You cannot access the TIMER menu using the front panel buttons. *Details are on page 22.*

Cleaning the Video Heads

- Your VCR automatically cleans the video heads each time you insert a tape. However, the heads may become dirty. USE CLEANING CASSETTE may appear on the screen, and "U:01" will appear on the display panel. These messages will appear briefly every seven seconds during tape playback. The messages will appear until you adjust the tracking, remove and reinsert the tape, or clean the heads. (BLUE BACKGROUND should be set to ON in order for the message to appear on the screen.)
Use a commercially-available head cleaner or have an authorized servicer clean the video heads. Eventually, the heads may need to be replaced. Only an authorized servicer should perform this service.

The playback picture is too dim, too bright, or fluctuates in brightness.

- Some programs may be broadcast with copyright protection technology in order to protect the rights of copyright owners. This technology is used on programs that are recorded on video tapes or Digital Video Discs (DVDs), as well as some programs broadcast by antenna/cable/satellite television channels. Programs broadcast with copyright protection technology may not record clearly. Likewise, if you play a tape that is a recording of a copyright protected program, the picture may not be clear. Tapes of copyright protected programs may have a picture that is dark or dim, or the brightness of the picture may fluctuate. Therefore, you should avoid recording or playing copies of copyright protected programs.
This VCR incorporates copyright protection technology that is protected by method claims of certain U.S. patents and other intellectual property rights owned by Macrovision Corporation and other rights owners. Use of this copyright protection technology must be authorized by Macrovision Corporation and is intended for home and limited viewing uses only, unless otherwise authorized by Macrovision Corporation. Reverse engineering or disassembly is prohibited.

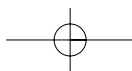

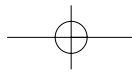

80 Specifications

Video Heads

Four video heads with two Hi-Fi stereo heads

Video Signal

EIA standards; NTSC color

Antenna

VHF/UHF – 75 ohm external antenna terminal

VHF Output Signal

Channel 3 or 4 (switchable)

75 ohms unbalanced

Power Requirement

120 V AC; 60 Hz

Power Consumption

27 W

Operating Temperature

41°F (5°C) to 104°F (40°C)

Relative Humidity

10% to 80%

Weight

10.4 lbs. (4.7 kg.)

Dimensions

(435 mm x 94 mm x 343 mm)

Tuner Broadcast Channels

VHF: 2-13

UHF: 14-69

Cable TV Channels

1-125

Accessories supplied

Remote control unit

Cable box DBS controller

RF coaxial cable

S-Video cable

Audio/Video cable

Batteries - R6(sum -3)/AA (only for checking operations)

NOTE: Designs and specifications are subject to change without notice.

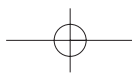

Index 81

- ac power cord23
- accessories84
- alt/speed button25
- ant(enna) in jack6-9, 23
- audio in/out jacks22-23, 48, 56
- audio dubbing49
- audio/mute button25, 57
- automatic
playback76
rewind76
- batteries5
- blue background75
- cable box
codes28
connections8-9, 50
output channel8-9, 77
- cable/tv channels36-37
- cassette compartment21
- cassette-inside light21
- ch3/ch4 switch7-9, 23
- channel
adding13
buttons22, 24
deleting13
display21
setup12
- child lock74
- clear button24, 76
- clock
display21
setting14-18
automatically17-18
manually14-15
time zone selection16
- connections6-9, 48-50, 56
- contents, table of4
- controls
remote24-25
vcr21-23
- copyright protection48, 79
- daily button39, 42
- date +/- buttons42
- daylight-savings time19
- db5
codes28
connections8-9, 50
- display panel21
- dspc60
- duplication48
- eject button25
- erase protection5
- fast forward button22
- fast forward searching62
- ff ► button24
- frame advance62
- front panel22
- glossary77
- head cleaner5, 79
- helpful hints78-79
- hi-fi stereo playback57
- hookups
with a cable box/db58-9
without a cable box/db56-7
- index search61
- index search buttons25, 61
- language selection20
- limited warranty80-81
- line input mode21, 35, 48
- long play41, 77
- lp41, 77
- maintenance5
- menu button22, 25
- mts broadcast55-56
- number buttons24
- ok/status button22, 24, 26
- on-screen mode26
- one-touch recording34
- operation indicators21
- output channel8-9, 77
- pbs channel selection
automatic18
manual17
- play button22, 24, 29
- playback29
options62-63
- pluscode programming number38
- power button22, 24, 74
- program review45
- quick programming40-43
- real-time counter21, 26, 76
- rear panel23
- rec(ord)/otr button22, 25, 30, 34
- record tab5
- recording
basic30
one channel/watching
another33
- remote control
buttons24-25
sensor22
using5
- repeat playback62
- rerecording48
- reverse searching62
- rew(ind) ◀ button22, 24, 62
- rf coaxial cable7-9, 77
- rf out jack6-9, 23
- safety precautions3
- sat/cbl/db5 button25, 28
- second audio broadcast55-56
- showguard43
- skip search button25, 61
- slow motion62
- slp41, 77
- smartclock17-18
- smartpicture59
- sp41, 77
- specifications82
- sqpb29
- standard play41, 77
- start +/- buttons41
- stereo broadcast55-56
- still/pause button22
- still/slow buttons25, 62
- still picture62
- stop ▼ button24
- stop +/- buttons41
- stop/eject button22
- super long play41, 77
- table of contents4
- tape
duplication48
eject76
manager64-73
speed41, 77
speed lights21
time remaining21, 26
- time zone selection16
- timer
button25, 38, 40, 45
light21
recording38-45
checking45
clearing45
helpful hints78
programming38-44
reviewing45
speed setting47
with vcr plus+
programming system 36-39
- tracking adjustment76
- tv
button24, 27
controls27
hookups6-9, 48, 50, 56
position22, 25
remote control codes27
- vcr
button25
light21
position22, 25
- vcr plus+ channels36-37
- vcr plus+ programming system
setting up36-37
timer recording38-39
- vcr/tv button22, 25
- video
in/out jacks22-23, 48, 56
stabilizer58
tapes5, 41
- vol(ume) ▲/▼ button24
- weekly button39, 42



COUNTRY	COMPANY	ADDRESS
ALGERIE	Azur 2000	8, Lotissement Ben Hatadi, Alger, Algeria
ARMENIA	NGYIG Ltd.	47 A/75 St. Lalaianis, 375000 Yerevan, Armenia
AUSTRALIA	Scan audio Pty. Ltd.	4 Station Street, Thornleigh NSW 2120, Australia
AUSTRIA	Huber & Prohaska GmbH	Taborstraße 95 / Ladestraße 1, Gebäude Hangartner, A-1200 Wien, Austria
BAHREIN	Ambassador Stores	P.O. Box 237,141, Government Avenue, Manama, Bahrain
BANGLADESH	Target	1078, Ramjoy Mohanja Lane Asadgonj, Chittagong 4000, Bangladesh
BELGIUM	Van der Heyden Audio N.V.	Brusselbaan 278, 9320 Erembodegem, Belgium
BULGARIA	Ariescommerce GmbH	Makedonia Blvd. 16, 1606 Sofia, Bulgaria
CANADA	Lenbrook Industries Limited	633 Granite Court, Pickering, Ontario
CYPRUS	Empire Hifi systems Ltd.	P.O. Box 5604, Nicosia, Cyprus
CZECH REPUBLIC	Audio International	Sokolska 41, 67902 Rajecsko, OKR,Blansko, Czech Republic
DENMARK	Audio Nord	Dali Allé 1, 9610 Noerager, Denmark
DUBAI	V.V.& SONS	P.O. Box 105, Dubai, U.A.E.
EGYPT	Solimco	9, El Attibaa St. Doki, Cairo, Egypt
ESTONIA	HiFi Club Estonia	Ehte 4, 90503 Haapsalu, Estonia
F.Y.R.O.M.	T.P.KODI	ul.Cedomir Kantargiev 21a, Skopje, Former Yugoslavian Republic of Macedonia
FINLAND	Audio Nord	Uudenmaankatu 4-6, Helsinki SF-00120, Finland
FRANCE	Marantz France	A division of Marantz Europe B.V., P.O. Box 301, 92 156 Suresnes Cedex, France
GERMANY	Marantz Deutschland	Hakenbusch 3, 49078 Osnabrück, Germany
GREECE	Adamco S.A.	188, Hippocratous Street, 11471 Athens, Greece
HEADQUARTERS EUROPE:	Marantz Europe B.V.	Building SFF-2, P.O. Box 80002, 5600 JB Eindhoven, The Netherlands
HONG KONG	Marantz Asia Ltd.	Unit 1706, Metroplaza II, 223 Hing Fong Road, Kwai Fong, N.T., Kowloon, Hong Kong
HUNGARY	Infovox Ltd.	Terez Krt.31, 1067 Budapest, Hungary
ICELAND	ID Electronics Ltd.	Armula 38, 108 Reykjavik, Iceland
INDIA	NOVA Audio Private	8,Punam Co-op.Society 29/30 Road#5, Union Park MUMBAI 400052, India
IRAN	Home Co.	5th floor no 878 Philips Building Enghelab ave, P.O. 11365/7844 Tehran, Iran
IRELAND	Marantz Ireland	Clonskeagh, Dublin 14, Ireland
ISRAEL	Elmor Ltd.	52 Heh Beiyar Street, Kikar Hamedina, Tel Aviv, Israel
ITALY	Marantz Italy	Via Casati 23, 20052 Monza (Milano), Italy, Servizio Consumatori 1678-20026, Numero Verde
IVORY COAST	Hifivoir	B.P. 2428, Abidjan 01, Ivory Coast
JAPAN	Marantz Japan Inc.	35-1 Sagami Ohno 7-Chome, Sagamihara-shi, Kanagawa 228-8505, Japan
KOREA	Mk Enterprises Ltd.	121-210, 2F Shinhan Bldg., 247-17 Seokyo-dong, Mapo-ku, Seoul, Korea
KUWAIT	alAlamiah Electronics Intl.	P.O. Box 8196, Salmiah 22052, Kuwait
LATVIA	Ace Ltd.	61, LacPlesa Str., Riga LV 1011, Latvia
LEBANON	AZ Electronics S.A., 1,	P.O. Box 11 2833, Beirut, Lebanon
LITHUANIA	Accapella Ltd.	Ausros, Vartu G/5, Pasazo SKG., 2001 Vilnius, Lithuania
MALAYSIA	Wo Kee Hong Electronics Sdn. Bhd.	102 Jalan SS 21/35, Damansara Utama, 47400 Petaling Jaya, Selangordarul Ehsan, Malaysia
MALTA	Doneo Co Ltd.	78 The Strand, Sliema SLM07, Malta
MAURITIUS	SKR Electronics Ltd.	P.O. Box 685, Bell Village, Port Louis, Mauritius
MILITARY MARKET EUROPE	PASCO GmbH	PO BOX 1280, Sandhausen 69200, Germany
NETHERLANDS	Marantz Domestic Sales	A division of Marantz Europe B.V., Building SFF2, P.O. Box 80002, 5600 JB Eindhoven, The Netherlands
NEW ZEALAND	Scan audio Pty. Ltd.	4 Station Street, Thornleigh NSW 2120, Australia
NORWAY	Audio Nord	Sandkerveien 64, Oslo 0483, Norway
OMAN	Mustafa & Jawad Trading CO.	P.O. Box 1918, Ruwi, Oman
POLAND	Philips Polska Sp. z.o.o.	Al.Jerozolimskie 195b, 02 222 Warszawa, Poland
PORTUGAL	Corel2	Comércio de Electrónica Lda., Av. Luis Bivar, No 85 A, 1050 Lisboa, Portugal
PROFESSIONAL EUROPE	Marantz Professional Products	Kingsbridge House, Padbury Oaks, 575-583 Bath Road, Longford, Middlesex UB7 0EH, U.K.
PROFESSIONAL U.S.A.	Marantz Professional Products	Distributed by: Superscope Technologies Inc., 1000 Corporate Blvd. Ste.D, Aurora, Illino
QATAR	Almana & Partners W.W.L.	P.O. Box 49, Doha, Qatar
REUNION	Vision +	180 Rue du Marechal Leclerc, 97400 Saint Denis, Ile de la Reunion
ROMANIA	Nova Music Entertainment	5, Zagazului Str. Bl.1G,apt.18, sector 1,Bucharest, Romania
RUSSIA	Absolute Audio	7/2, Montazhnaya Street, 107497 Moscow, Russia
SAUDI ARABIA	Adawlia Univ. Electr. Apl	P.O. Box 2154, Alkhobar 31952, Saudi Arabia
SINGAPORE	Forward Marketing (S) Pte. Ltd.	Wo Kee Hong Centre, 29 Leng Kee Road, Singapore 159099, Singapore
SLOVAKIA	Bis Audio s.r.o.	Nam. SNP 10, 96001 Zvolem, Slovakia
SLOVENIA	Bofex	Smartinska 152, HALA V/3, 61000 Ljubljana, Slovenia
SOUTH AFRICA	Coherent Imports (PTY) Ltd.	P.O. Box 1614, Alberton, 1450, South Africa
SPAIN	Marantz Spain	Martinez Villergas 2, Apartado 2065, Madrid 28027, Spain
SRI LANKA	The listening Room	Mezzanine Floor, The Landmark 385, Galle Road, Colombo - 3, Sri Lanka
SWEDEN	Audio Nord	Almedalsvagen 4, Gotenberg 402-23, Sweden
SWITZERLAND	Sound Company AG	Postfach, 8010 Zürich, Switzerland
SYRIA	Hamzeh & Partners	Hafez Ibrahim Str. No 117, Damascus Shalan, Syria
TAHITI	Covecolor	Av. Prince Hinoi, Cours de l'union sacré, P.O. Box 2334, Papeete, Tahiti
TAIWAN	Pai-Yuing Co. Ltd.	6th No 148 Sung Kiang Road, Taipei 10429, Taiwan R.O.C.
THAILAND	MRZ Standard Co. Ltd.	746-750 Mahachai Road, Wangburapa, Bangkok 10200, Thailand
TUNESIA	Societe EDEVIG	40, Avenue du Golfe Arabe, El Menzah, 1004, Tunesia
TURKEY	Türk Philips Ticaret A.S.	Yukari Dudulu Organize sanayi Bolgesi, 2.Cadde no.28, 81260 Umraniye-Istanbul, Turkey
U.K.	Marantz Hifi UK Ltd.	Kingsbridge House, Padbury Oaks, 575-583 Bath Road, Longford, Middlesex UB7 0EH, U.K.
U.S.A.	Marantz America Inc.	440 Medinah Road, Roselle, IL 60172, U.S.A.
YUGOSLAVIA	ITM Company	Omladinskih Brigada 86, 11070 Belgrade, Yugoslavia
EXPORT	Marantz Domestic Sales	A division of Marantz Europe BV,Building SFF2, P.O. Box 80002, 5600 JB Eindhoven, TheThe Netherlands

www.marantz.com

marantz® is a registered trademark.



Printed in Malaysia

LPT0440-001A

Free Manuals Download Website

<http://myh66.com>

<http://usermanuals.us>

<http://www.somanuals.com>

<http://www.4manuals.cc>

<http://www.manual-lib.com>

<http://www.404manual.com>

<http://www.luxmanual.com>

<http://aubethermostatmanual.com>

Golf course search by state

<http://golfingnear.com>

Email search by domain

<http://emailbydomain.com>

Auto manuals search

<http://auto.somanuals.com>

TV manuals search

<http://tv.somanuals.com>