



marantz®

CD player
CD6004

Owner's Manual

SAFETY PRECAUTIONS



CAUTION
RISK OF ELECTRIC SHOCK
DO NOT OPEN



CAUTION:
TO REDUCE THE RISK OF ELECTRIC SHOCK, DO NOT REMOVE COVER (OR BACK). NO USER-SERVICEABLE PARTS INSIDE. REFER SERVICING TO QUALIFIED SERVICE PERSONNEL.

The lightning flash with arrowhead symbol, within an equilateral triangle, is intended to alert the user to the presence of uninsulated "dangerous voltage" within the product's enclosure that may be of sufficient magnitude to constitute a risk of electric shock to persons.

The exclamation point within an equilateral triangle is intended to alert the user to the presence of important operating and maintenance (servicing) instructions in the literature accompanying the appliance.

WARNING:
TO REDUCE THE RISK OF FIRE OR ELECTRIC SHOCK, DO NOT EXPOSE THIS APPLIANCE TO RAIN OR MOISTURE.

CAUTION:
USE OF CONTROLS OR ADJUSTMENTS OR PERFORMANCE OF PROCEDURES OTHER THAN THOSE SPECIFIED HEREIN MAY RESULT IN HAZARDOUS RADIATION EXPOSURE. THIS PRODUCT SHOULD NOT BE ADJUSTED OR REPAIRED BY ANYONE EXCEPT PROPERLY QUALIFIED SERVICE PERSONNEL.

Laser Class (IEC 60825-1:2001)

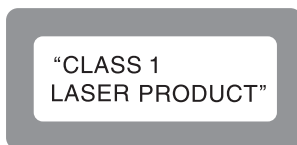

IMPORTANT SAFETY INSTRUCTIONS

1. Read these instructions.
2. Keep these instructions.
3. Heed all warnings.
4. Follow all instructions.
5. Do not use this apparatus near water.
6. Clean only with dry cloth.
7. Do not block any ventilation openings. Install in accordance with the manufacturer's instructions.
8. Do not install near any heat sources such as radiators, heat registers, stoves, or other apparatus (including amplifiers) that produce heat.
9. Do not defeat the safety purpose of the polarized or grounding-type plug. A polarized plug has two blades with one wider than the other. A grounding type plug has two blades and a third grounding prong. The wide blade or the third prong are provided for your safety. If the provided plug does not fit into your outlet, consult an electrician for replacement of the obsolete outlet.
10. Protect the power cord from being walked on or pinched particularly at plugs, convenience receptacles, and the point where they exit from the apparatus.
11. Only use attachments/accessories specified by the manufacturer.
12. Use only with the cart, stand, tripod, bracket, or table specified by the manufacturer, or sold with the apparatus. When a cart is used, use caution when moving the cart/apparatus combination to avoid injury from tip-over.
13. Unplug this apparatus during lightning storms or when unused for long periods of time.
14. Refer all servicing to qualified service personnel. Servicing is required when the apparatus has been damaged in any way, such as power-supply cord or plug is damaged, liquid has been spilled or objects have fallen into the apparatus, the apparatus has been exposed to rain or moisture, does not operate normally, or has been dropped.
15. Batteries shall not be exposed to excessive heat such as sunshine, fire or the like.



CAUTION:

To completely disconnect this product from the mains, disconnect the plug from the wall socket outlet.

The mains plug is used to completely interrupt the power supply to the unit and must be within easy access by the user.

PRECAUTION:

Pour déconnecter complètement ce produit du courant secteur, débranchez la prise de la prise murale.

La prise secteur est utilisée pour couper complètement l'alimentation de l'appareil et l'utilisateur doit pouvoir y accéder facilement.

PRECAUCIÓN:

Para desconectar completamente este producto de la alimentación eléctrica, desconecte el enchufe del enchufe de la pared.

El enchufe de la alimentación eléctrica se utiliza para interrumpir por completo el suministro de alimentación eléctrica a la unidad y debe de encontrarse en un lugar al que el usuario tenga fácil acceso.

FCC INFORMATION (For US customers)

1. PRODUCT

This product complies with Part 15 of the FCC Rules. Operation is subject to the following two conditions: (1) this product may not cause harmful interference, and (2) this product must accept any interference received, including interference that may cause undesired operation.

2. IMPORTANT NOTICE: DO NOT MODIFY THIS PRODUCT

This product, when installed as indicated in the instructions contained in this manual, meets FCC requirements. Modification not expressly approved by Marantz may void your authority, granted by the FCC, to use the product.

3. NOTE

This product has been tested and found to comply with the limits for a Class B digital device, pursuant to Part 15 of the FCC Rules. These limits are designed to provide reasonable protection against harmful interference in a residential installation.

This product generates, uses and can radiate radio frequency energy and, if not installed and used in accordance with the instructions, may cause harmful interference to radio communications. However, there is no guarantee that interference will not occur in a particular installation. If this product does cause harmful interference to radio or television reception, which can be determined by turning the product OFF and ON, the user is encouraged to try to correct the interference by one or more of the following measures:

- Reorient or relocate the receiving antenna.
- Increase the separation between the equipment and receiver.
- Connect the product into an outlet on a circuit different from that to which the receiver is connected.
- Consult the local retailer authorized to distribute this type of product or an experienced radio/TV technician for help.

For Canadian customers:

This Class B digital apparatus complies with Canadian ICES-003.

Cet appareil numérique de la classe B est conforme à la norme NMB-003 du Canada.

☐ NOTES ON USE / OBSERVATIONS RELATIVES A L'UTILISATION / NOTAS SOBRE EL USO

WARNINGS	AVERTISSEMENTS	ADVERTENCIAS
<ul style="list-style-type: none"> • Avoid high temperatures. Allow for sufficient heat dispersion when installed in a rack. • Handle the power cord carefully. Hold the plug when unplugging the cord. • Keep the unit free from moisture, water, and dust. • Unplug the power cord when not using the unit for long periods of time. • Do not obstruct the ventilation holes. • Do not let foreign objects into the unit. • Do not let insecticides, benzene, and thinner come in contact with the unit. • Never disassemble or modify the unit in any way. • Ventilation should not be impeded by covering the ventilation openings with items, such as newspapers, tablecloths or curtains. • Naked flame sources such as lighted candles should not be placed on the unit. • Observe and follow local regulations regarding battery disposal. • Do not expose the unit to dripping or splashing fluids. • Do not place objects filled with liquids, such as vases, on the unit. • Do not handle the mains cord with wet hands. • When the switch is in the OFF (STANDBY) position, the equipment is not completely switched off from MAINS. • The equipment shall be installed near the power supply so that the power supply is easily accessible. 	<ul style="list-style-type: none"> • Eviter des températures élevées. Tenir compte d'une dispersion de chaleur suffisante lors de l'installation sur une étagère. • Manipuler le cordon d'alimentation avec précaution. Tenir la prise lors du débranchement du cordon. • Protéger l'appareil contre l'humidité, l'eau et la poussière. • Débrancher le cordon d'alimentation lorsque l'appareil n'est pas utilisé pendant de longues périodes. • Ne pas obstruer les trous d'aération. • Ne pas laisser des objets étrangers dans l'appareil. • Ne pas mettre en contact des insecticides, du benzène et un diluant avec l'appareil. • Ne jamais démonter ou modifier l'appareil d'une manière ou d'une autre. • Ne pas recouvrir les orifices de ventilation avec des objets tels que des journaux, nappes ou rideaux. Cela entraverait la ventilation. • Ne jamais placer de flamme nue sur l'appareil, notamment des bougies allumées. • Veillez à respecter les lois en vigueur lorsque vous jetez les piles usagées. • L'appareil ne doit pas être exposé à l'eau ou à l'humidité. • Ne pas poser d'objet contenant du liquide, par exemple un vase, sur l'appareil. • Ne pas manipuler le cordon d'alimentation avec les mains mouillées. • Lorsque l'interrupteur est sur la position OFF (STANDBY), l'appareil n'est pas complètement déconnecté du SECTEUR (MAINS). • L'appareil sera installé près de la source d'alimentation, de sorte que cette dernière soit facilement accessible. 	<ul style="list-style-type: none"> • Evite altas temperaturas. Permite la suficiente dispersión del calor cuando está instalado en la consola. • Maneje el cordón de energía con cuidado. Sostenga el enchufe cuando desconecte el cordón de energía. • Mantenga el equipo libre de humedad, agua y polvo. • Desconecte el cordón de energía cuando no utilice el equipo por mucho tiempo. • No obstruya los orificios de ventilación. • No deje objetos extraños dentro del equipo. • No permita el contacto de insecticidas, gasolina y diluyentes con el equipo. • Nunca desarme o modifique el equipo de ninguna manera. • La ventilación no debe quedar obstruida por haberse cubierto las aperturas con objetos como periódicos, manteles o cortinas. • No deberán colocarse sobre el aparato fuentes inflamables sin protección, como velas encendidas. • A la hora de deshacerse de las pilas, respete la normativa para el cuidado del medio ambiente. • No exponer el aparato al goteo o salpicaduras cuando se utilice. • No colocar sobre el aparato objetos llenos de líquido, como jarras. • No maneje el cable de alimentación con las manos mojadas. • Cuando el interruptor está en la posición OFF (STANDBY), el equipo no está completamente desconectado de la alimentación MAINS. • El equipo se instalará cerca de la fuente de alimentación de manera que resulte fácil acceder a ella.

☐ CAUTIONS ON INSTALLATION
PRÉCAUTIONS D'INSTALLATION
EMPLAZAMIENTO DE LA INSTALACIÓN

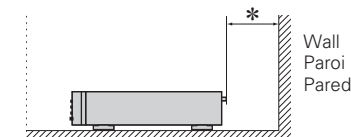
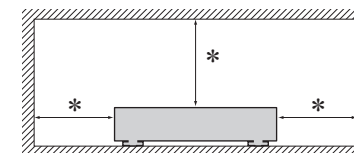

*** For proper heat dispersal, do not install this unit in a confined space, such as a bookcase or similar enclosure.**

- More than 4 in. (0.1 m) is recommended.
- Do not place any other equipment on this unit.

*** Pour permettre la dissipation de chaleur requise, n'installez pas cette unité dans un espace confiné tel qu'une bibliothèque ou un endroit similaire.**

- Une distance de plus de 4 po (0,1 m) est recommandée.
- Ne placez aucun matériel sur cet appareil.

*** Para la dispersión del calor adecuadamente, no instale este equipo en un lugar confinado tal como una librería o unidad similar.**

- Se recomienda dejar más de 4 pulg. (0,1 m) alrededor.
- No coloque ningún otro equipo sobre la unidad.

Getting started

Thank you for purchasing this marantz product. To ensure proper operation, please read this owner's manual carefully before using the product. After reading the manual, be sure to keep it for future reference.

Contents

Getting started	1	Basic operation	8	Advanced operations	15
Accessories	2	Before use	8	Playback of MP3, WMA and AAC files	15
About this manual	2	Set the power to standby	8	Playable MP3, WMA and AAC formats	15
Main features	2	Switching the input source	8	Playing MP3, WMA and AAC files	16
Cautions on handling	3	Playback CDs	9	MP3, WMA or AAC playback order of	
Discs	3	Playing CDs	9	MP3, WMA or AAC files	16
Discs playable on this unit	3	Changing the brightness of the display	9	Playback iPod®	17
Holding discs	3	To change time display	9	Playing an iPod®	17
Loading discs	3	Listening with headphone	10	Disconnecting the iPod	18
Cautions on loading discs	3	Playing repeatedly (Repeat playback)	10	Playing a USB memory device	18
Cautions on handling	4	Repeatedly listening to the specified section		Playable USB memory formats	18
Cautions on storing discs	4	(A-B repeat playback)	10	Playing files stored on USB memory devices	19
Cleaning discs	4	Playing in random order (Random playback)	10	Removing the USB memory device	20
About the remote control	4	Displaying CD-TEXT	10	Performing menu settings	20
Inserting the batteries	4	Playing tracks in a specific order (Program playback)	11	CD D-OUT (CD digital output settings)	20
Operating range of the remote control	4	Skipping tracks you don't want to hear		USB OUT (USB audio output settings)	20
Part names and functions	5	(Delete program playback)	12	Timer Play (Timer play setting)	21
Front panel	5	Searching for a specific track (AMS playback)	12	CD Setup	
Display	5	Rewinding tracks slightly to listen again (Quick replay)	12	(Operating MP3, WMA and AAC files recorded on the disc)	22
Rear panel	6	Turning digital output off	12	USB Setup (USB memory device operation)	23
Remote control	6	Switching Audio EX	12	iPod Setup (iPod operation)	25
				Auto STB (Auto standby function)	27
Basic connections	7	Advanced connections	13	Explanation of terms	27
Preparations	7	Preparations	13	Troubleshooting	28
Connecting cables	7	Connecting cables	13	Specifications	29
Analog connection	7	Digital connection	13	Index	30
Connecting the power cord	7	Digital audio output	13		
		Connecting the flasher input jack	13		
		USB memory device/iPod connection	14		
		Remote control connection	14		

Accessories

Check that the following parts are supplied with the product.

① Owner's Manual.....	1
② AC power cord	1
③ Audio connecting cable	1
④ Remote control connecting cable.....	1
⑤ Remote controller (RC004CD).....	1
⑥ R03/AAA-size batteries.....	2
⑦ Warranty card (U.S.A.).....	1
⑧ Warranty card (Canada)	1

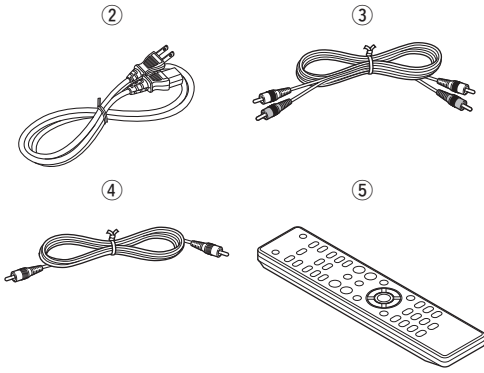

About this manual

❑ Operation buttons

The operations described in this manual are based mainly on remote control operation.

❑ Symbols



This symbol indicates a reference page on which related information is described.



This symbol indicates a supplementary information and tips for operations.

NOTE

This symbol indicates points to remember operations or function limitations.

❑ Illustrations

Note that the illustrations in this manual are for explanation purposes and may differ from the actual unit.

Main features

Using marantz original HDAM®SA2

The unit uses an HDAM®SA2, whose quality has been proved in Super Audio CD players and high-end amplifiers, as a high-speed buffer amplifier. You can enjoy the high speed and high-quality sound like that produced by high-end equipment.

Incorporates a Cirrus Logic advanced D/A converter, CS4398

A D/A converter is an essential element for the audio quality of a CD player. The CS4398 Cirrus Logic D/A Converter, which has a reputation for high precision and has been adopted for other marantz Super Audio CD players, is adopted for this unit.

Audio EX function (👉 page 12)

When digital output or the display are set to OFF, you can enjoy high quality analog output sound.

High grade headphone circuit

The high-grade headphone circuit incorporates a high-speed buffer amplifier to enable headphone listening of high quality sound reproduction, late at night or in other such situations.

Supports MP3, WMA and AAC file playback

(👉 page 15)

MP3, WMA and AAC files that have been recorded onto CD-R or CD-RW discs can be played back on this CD player.

Playback of USB audio (MP3/WMA/AAC/WAV)/ iPod

This unit can play back MP3, WMA, WAV and AAC files by connecting a USB device or iPod to its USB connector.

Quick replay function (Audio CDs only)

(👉 page 12)

Simply press the **Q.REPLAY** button on the remote control during playback, and the track rewinds the set amount of time (setting range: 5-60 seconds), and resumes playing from the rewind point.

Supports CD-TEXT display

CD-Text is an extension to the existing audio CD standard that enables text information, such as the name of the artist, album title and song titles to be stored on an audio CD. CDs with the following logos support this function.



Text information is recorded on the parts that are not used in the conventional Audio CDs. This CD player enables the text information stored on a CD-Text CD to be read (applies only to English alphanumeric text).

Cautions on handling

• Before turning the power switch on

Check once again that all connections are correct and that there are no problems with the connection cables.

- When leaving home for long periods of time, be sure to unplug the power cord from the power outlet.

• Proper ventilation

If the unit is left in a room full of the smoke from cigarettes, etc., for long periods of time, the surface of the optical pickup may get dirty, preventing it from receiving the signals properly.

• About condensation

If there is a major difference in temperature between the inside of the unit and its surroundings, condensation may form on parts inside the unit, causing the unit to fail to operate properly.

If this happens, let the unit sit for an hour or two with the power off and wait until there is little difference in temperature before using the unit.

• Cautions on using mobile phones

Using a mobile phone near this unit may result in noise. If that occurs, move the mobile phone away from the unit when it is in use.

• Moving the unit

Turn off the power and unplug the power cord from the power outlet. Next, disconnect the cables connected to other system units before moving the unit.

Discs

Discs playable on this unit

1 Music CDs

Discs marked with the logo at right can be played in this unit.



2 CD-R/CD-RW

NOTE

- Discs in special shapes (heart-shaped discs, octagonal discs, etc.) cannot be played. Do not attempt to play them, as doing so can damage the unit.



- Some discs and some recording formats cannot be played.
- Non-finalized discs cannot be played.

* What is finalization?

Finalization is the process that makes recorded CD-R/CD-RW discs playable on compatible players.

Holding discs



Do not touch the signal surface.

Loading discs

- Make sure the label side (printed side) is facing upwards.
- Make sure the disc tray is fully open when inserting the disc.
- Place the discs flat, 12 cm discs in the outer tray guide (Figure 1), 8 cm discs in the inner tray guide (Figure 2).

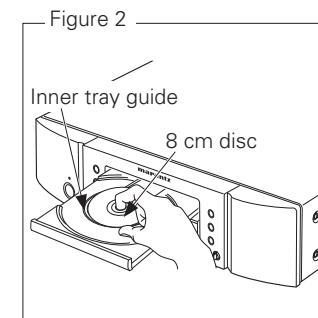
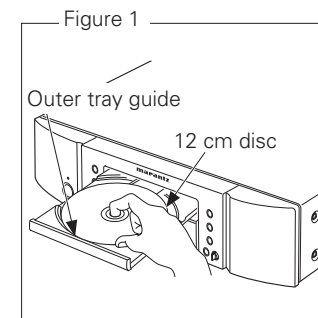

- Place 8 cm discs in the inner tray guide without using an adapter.



- If a DVD or other disc that is not supported by this unit is placed on the disc tray, "SubQ Error" is shown on the display. When the ▲ button is pressed after that, the disc tray opens after 60 seconds.
- If you place a disc that contains other than MP3 or WMA files, "No File" is displayed.

NOTE

- Do not push the disc tray in by hand when the power is turned off. Doing so could damage the set.
- Do not place any objects other than discs on the disc tray. Doing so may damage the unit.

Cautions on loading discs

- Only load one disc at a time. Loading two or more discs can damage the unit or scratch the discs.
- Do not use cracked or warped discs or discs that have been repaired with adhesive, etc.
- Do not use discs on which the sticky part of cellophane tape or labels is exposed or on which there are traces of where labels have been removed. Such discs can get caught inside the player and damage it.

Cautions on handling

- Do not get fingerprints, oil or dirt on discs.
- Take special care not to scratch discs when removing them from their cases.
- Do not bend or heat discs.
- Do not enlarge the hole in the center.
- Do not write on the labeled (printed) surface with ball-point pens, pencils, etc., or stick new labels on discs.
- Water droplets may form on discs if they are moved suddenly from a cold place (outdoors for example) to a warm place, but do not try to dry them off using a hair-dryer, etc.

Cautions on storing discs

- Be sure to remove discs after using them.
- Be sure to store discs in their cases to protect them from dust, scratches, warping, etc.
- Do not store discs in the following places:
 1. Places exposed to direct sunlight for long periods of time
 2. Dusty or humid places
 3. Places exposed to heat from heaters, etc.

Cleaning discs

- If there are fingerprints or dirt on a disc, wipe them off before using the disc. Fingerprints and dirt can impair sound quality and cause interruptions in playback.
- Use a commercially available disc cleaning set or a soft cloth to clean discs.

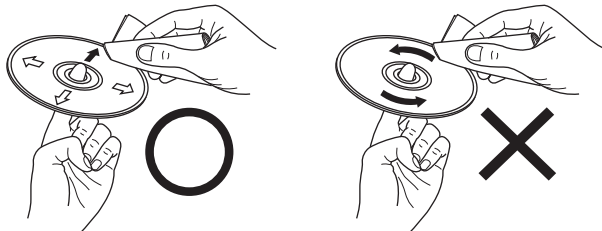

Gently wipe the disc from the inside towards the outside. Do not wipe in a circular motion.

NOTE

Do not use record spray, antistatic agents, benzene, thinner or other solvents.

About the remote control

Inserting the batteries

- ① Remove the rear cover of the remote control.
- ② Set two R03/AAA batteries in the battery compartment in the indicated direction.

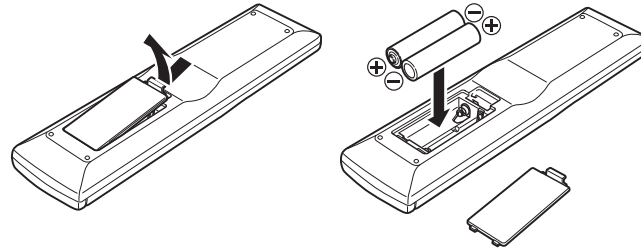

- ③ Put the rear cover back on.

NOTE

- Replace the batteries with new ones if the unit does not operate even when the remote control is operated close to the unit.
- The supplied batteries are only for verifying operation.
- Insert the batteries in the proper direction, following the ⊕ and ⊖ marks in the battery compartment.
- To prevent damage or leakage of battery fluid:
 - Do not use a new battery with an old one.
 - Do not use two different types of batteries.
 - Do not attempt to charge dry batteries.
 - Do not short-circuit, disassemble, heat or dispose of batteries in a fire.
 - Do not keep the battery in a place exposed to direct sunlight or in places with extremely high temperatures, such as near a heater.
- If the battery fluid leaks, carefully wipe the fluid off the inside of the battery compartment and insert new batteries.
- Remove the batteries from the remote control if it will not be used for a long time.
- Dispose of batteries in accordance with local regulations on battery disposal.
- The remote control unit may function improperly if rechargeable batteries are used.

Operating range of the remote control

Operate the remote control while pointing it at the remote sensor.

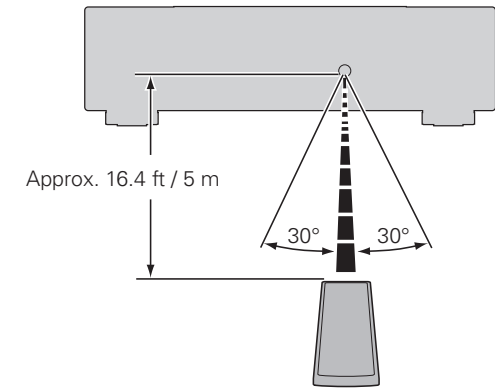

NOTE

The unit may function improperly or the remote control may not operate if the remote control sensor is exposed to direct sunlight or strong artificial light from a fluorescent or infrared light.

Part names and functions

For buttons not explained here, see the page indicated in parentheses ().

Front panel

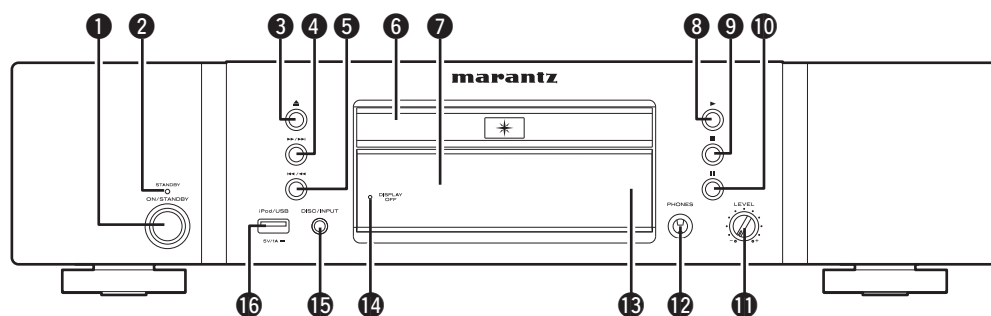

- | | |
|--|--|
| 1 Power operation switch (ON/STANDBY) (8) | 11 Headphone volume control knob (LEVEL) (10) |
| 2 Power indicator (STANDBY) (8)
Changes as shown below according to the unit status.
• Power "ON" Turn off
• Standby Red | 12 Headphones jack (PHONES) (10) |
| 3 Disc tray open/close button (▲) (9) | 13 Remote control sensor (4) |
| 4 Fast forwarding/Forward-skip button (▶▶/▶▶I) (9, 16, 19) | 14 DISPLAY OFF indicator (9) |
| 5 Fast reversing/Reverse-skip button (I◀◀/◀◀) (9, 16, 19) | 15 DISC/INPUT button (8, 9, 17, 19) |
| 6 Disc tray (9) | 16 USB port (iPod/USB) (14) |
| 7 Display (5) | |
| 8 Play button (▶) (9, 16, 19, 25) | |
| 9 Stop button (■) (9, 19) | |
| 10 Pause button (II) (9, 19) | |

Display

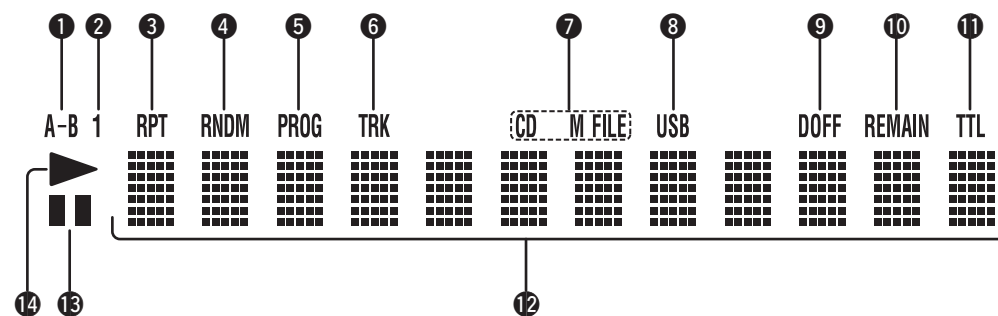

- | | |
|--|---|
| 1 A-B indicator
This indicator lights up during A-B repeat playback. | 9 D OFF (digital output OFF) indicator
This indicator lights up when the digital output setting of the audio CD signal is set to "Off" (page 20). |
| 2 1 (repeat) indicator
This indicator lights up during repeat play of one track. | 10 REMAIN (remaining time) indicator
This indicator lights up when the remaining track time is displayed. |
| 3 RPT (repeat) indicator
This indicator lights up during repeat play. | 11 TTL (total time) indicator
This indicator lights when the total remaining time or total program time is displayed. |
| 4 RNDM (random) indicator
This indicator lights up during random play. | 12 Main display area
This area displays the time display and text information of the disc to be played, as well as the setting menu items, etc. |
| 5 PROG (program) indicator
This indicator lights up during program play. | 13 II (pause) indicator
This indicator lights up when play is paused. |
| 6 TRK (track) indicator
This indicator lights up above the display of the track number currently being played. | 14 ▶ (play) indicator
This indicator lights up during disc play. |
| 7 Disc indicator
The type of disc in the disc tray is displayed.
• CD: Audio CD
• M FILE: WMA/MP3/AAC | |
| 8 USB indicator
This indicator lights up during operation in the USB/iPod mode. | |

Rear panel

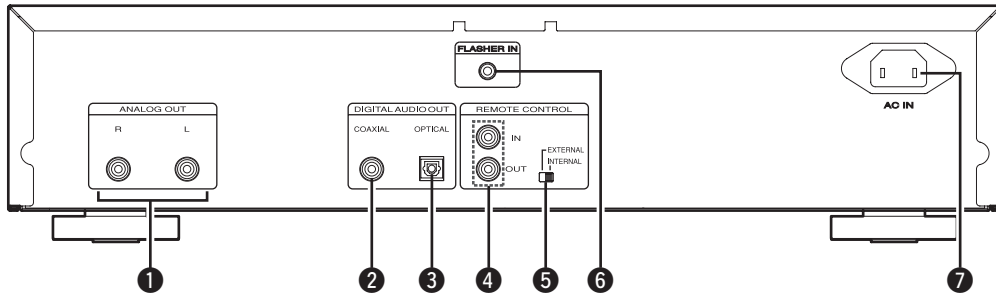

- 1 ANALOG OUT connectors (7)
- 2 DIGITAL AUDIO OUT COAXIAL connector (13)
- 3 DIGITAL AUDIO OUT OPTICAL connector (13)
- 4 REMOTE CONTROL IN / OUT connectors (14)
- 5 EXTERNAL/INTERNAL switch (14)
- 6 FLASHER IN jack (13)
- 7 AC inlet (AC IN) (7)

Remote control

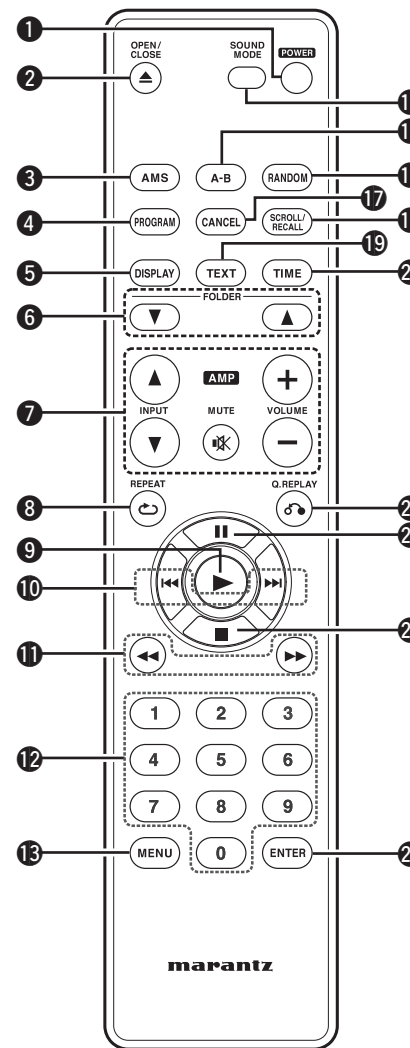

- 1 POWER button (8)
- 2 OPEN/CLOSE button (▲) (9)
- 3 Auto music scan button (AMS) (12)
- 4 PROGRAM button (11, 12)
- 5 DISPLAY button (9)
- 6 FOLDER buttons (▲, ▼) (19, 25)
- 7 Amplifier operation buttons
VOLUME button (+, -)
INPUT button (▲, ▼)
MUTE button
- 8 REPEAT button (10, 19, 26)
- 9 Play button (▶) (9, 16, 19, 25)
- 10 Track skip buttons (◀◀, ▶▶) (9, 16, 19, 20)
- 11 Search buttons (◀◀, ▶▶) (9, 19)
- 12 Number buttons (0 - 9) (9, 11, 12)
- 13 MENU button (20)
- 14 SOUND MODE button (12)
- 15 A-B button (10)
- 16 RANDOM button (10, 19, 26)
- 17 CANCEL button (11, 20)
- 18 SCROLL/RECALL button (11, 12)
- 19 TEXT button (10, 16, 18, 19)
- 20 TIME button (9, 16, 18, 20)
- 21 Q.REPLAY button (12)
- 22 Pause button (||) (9, 19)
- 23 Stop button (■) (9, 19)
- 24 ENTER button (19, 20)



- The supplied remote control can operate marantz amplifiers.
- When using it, also refer to the operating instructions of the other devices.

NOTE

The remote control may not operate some devices.

Basic connections

This chapter explains how to connect the analog device (amp) and power cord.

For other connections, see the sections below.

- ❑ **USB memory device/iPod connection** (page 14)
- ❑ **Remote control connection** (page 14)

NOTE

- Do not plug in the power cord until all connections have been completed.
- When making connections, also refer to the owner's manual of the other components.
- Insert the plugs securely. Loose connections will result in the generation of noise.
- Be sure to connect the left and right channels properly (left with left, right with right).
- Be sure to connect the input and output properly.
- Do not bundle power cords together with connection cables. Doing so can result in humming or noise.
- Do not connect the unit to the PHONO input connectors on the amplifier.

Preparations

Connecting cables

Select the cables according to the equipment being connected.

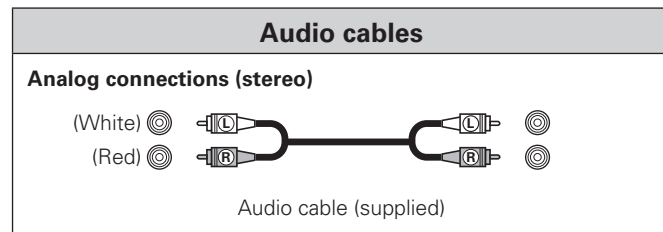

Analog connection

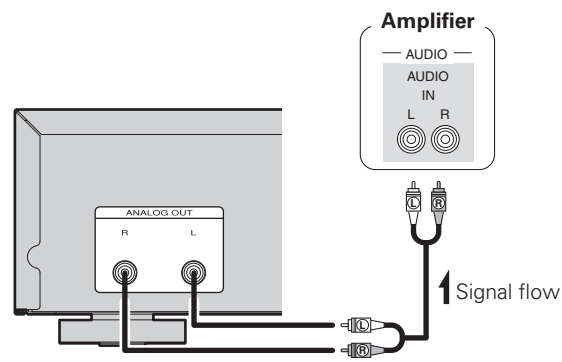

Connecting the power cord

Do not plug in the power cord until all connections have been completed.

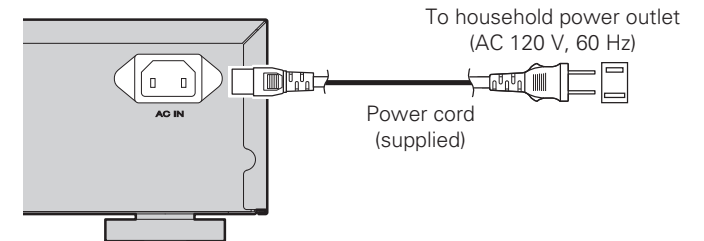

NOTE

- Insert the plugs securely. Loose connections will result in the generation of noise.
- Do not unplug the power cord while the unit is operating.
- Do not use a power cord other than the cord supplied with this unit.

Basic operation

Symbols used to indicate buttons in this manual

- Button located on both the main unit and the remote control → **BUTTON**
- Button only on the main unit → **<BUTTON>**
- Button only on the remote control → **[BUTTON]**

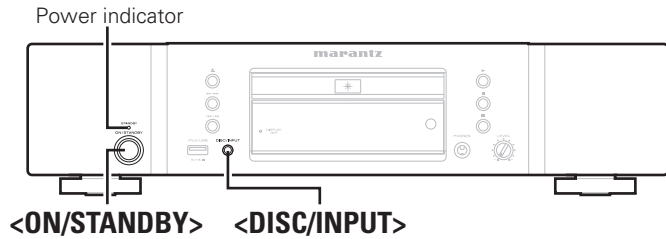

This chapter explains the procedures required to playback a CD, and the various operations that can be performed during CD playback.

For other operations, see the sections below.

- ❑ Playback of MP3, WMA and AAC files (page 15)
- ❑ Playback iPod® (page 17)
- ❑ Playing a USB memory device (page 18)
- ❑ Performing menu settings (page 20)

Before use

Set the power to standby

Press **<ON/STANDBY>** or **[POWER]**.
Power is set to standby and the power indicator lights.



Before setting power to standby, make sure the disc tray is completely closed.

NOTE

- Do not force the tray in by hand while power is set to standby. This could cause a trouble.
- Even when power is set to standby, electrical current passes through some circuits. If you do not intend to use the unit for an extended period of time, unplug the power cord from the household power outlet.

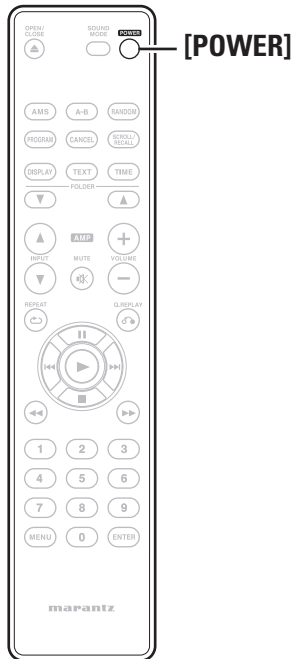

Switching the input source

This unit supports the following playback functions in addition to disc playback.

- Playing files from USB memory from the front panel USB port.
 - Playing iPod files from the front panel USB port.
- Before playing back files from a connected device, perform the following operation to switch the input source.

Press **<DISC/INPUT>** to select the input source.

The input source changes in the following order each time **<DISC/INPUT>** is pressed.

Disc ↔ USB

[Selectable items]

Disc	Playback the disc inside the disc tray (page 9).
USB	Playback files on the device connected to the front panel USB port (iPod/USB) (page 17,18).

Symbols used to indicate buttons in this manual

- Button located on both the main unit and the remote control → **BUTTON**
- Button only on the main unit → **<BUTTON>**
- Button only on the remote control → **[BUTTON]**

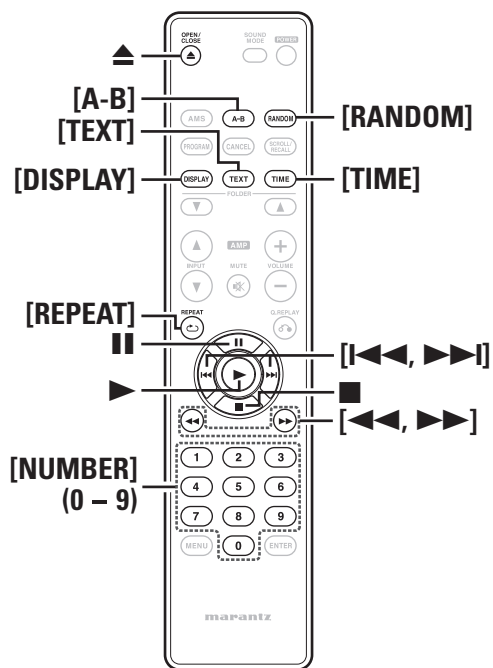
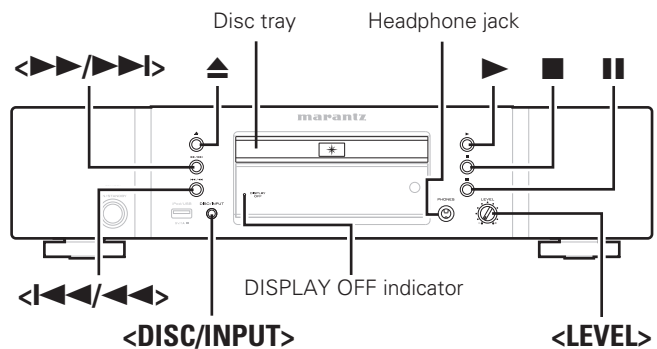

Playback CDs

Playing CDs

- 1 Press **<DISC/INPUT>** to change the input source to "Disc".
- 2 **Insert a disc.**
Press **▲** to open and close the disc tray.
 - Press **▶** to close the disc tray, and playback starts automatically.
- 3 Press **▶**.
The **▶** indicator lights, and playback begins.
 - When all of the tracks recorded on the disc have finished playing back, playback stops automatically.

Stopping playback

Press **■**.

Stopping playback temporarily

Press **||**.

- The **||** indicator lights.
- To restart playback, press **▶** or **||**.

Fast-forwarding and fast-reversing (Searching)

[Using the buttons on the main unit]

The search is started by holding down **<||<<</>>>>** or **<>>>/>>>>** during playback. Playback returns to normal when the button is released.

[Using the buttons on the remote control]

The search is started by holding down **[<<<]** or **[>>>]** during playback. Playback returns to normal when the button is released.

Moving to the beginning of tracks (Skipping)

[Using the buttons on the main unit]

During playback, press **<||<<</>>>>** or **<>>>/>>>>**.

- The disc is skipped the number of tracks equal to the number of times the button is pressed.
- When you press **<||<<</>>>>** once, playback restarts from the beginning of the current track.

[Using the buttons on the remote control]

During playback, press **[||<<<]** or **[>>>|]**.

- The disc is skipped the number of tracks equal to the number of times the button is pressed.
- When you press **[||<<<]** once, playback restarts from the beginning of the current track.

Playing a specific track (Direct searching)

Press **[NUMBER] (0 – 9)** to select the track.

[Example] : Track 4 : Press number **[4]** to select Track 4.

[Example] : Track 12 : Press numbers **[1]** and **[2]** consecutively to select Track 12.



The number you enter is set about 1.5 seconds after you press the number buttons. To enter a two-digit number, be sure to press the two number buttons, one immediately after the other.

Changing the brightness of the display

During playback, press **[DISPLAY]**.

The display brightness changes in the following order each time **[DISPLAY]** is pressed.

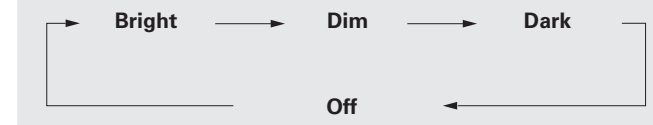

When the display is switched off, the "DISPLAY OFF" indicator lights.

NOTE

During stop mode, the display information does not turn off. The information is turned off only during playback.

To change time display

During playback, press **[TIME]**.

The time display changes in the following order each time **[TIME]** is pressed.

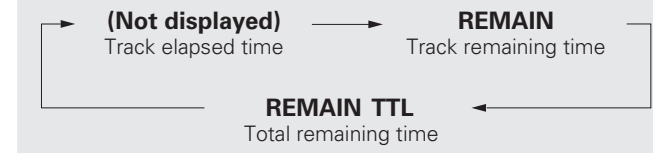

Listening with headphone

Plug the headphones into the headphone jack (PHONES).

Adjusting the volume

Turn <LEVEL>.

NOTE

To prevent hearing loss, do not raise the volume level excessively when using headphones.

Playing repeatedly (Repeat playback)

Press [REPEAT] to select repeat mode.

The repeat mode changes in the following order each time [REPEAT] is pressed.



[Selectable items]

All-track repeat "RPT"	All tracks are played repeatedly.
1-track repeat "1 RPT"	Only 1 track is played repeatedly.
Repeat off (Not displayed)	Normal playback resumes.

Repeatedly listening to the specified section (A-B repeat playback)

You can specify the section within a track that you want to hear, and play it back repeatedly.

1 During playback, press [A-B] at the point where you want to start playing repeatedly.
The "A-" indicator lights in the display.

2 Press [A-B] at the point where you want to stop playing repeatedly.
The "A-B" indicator lights in the display, and the specified section (point A to point B) is played back repeatedly.



To cancel A-B repeat playback, press [A-B] and the "A-B" indicator disappears from the display.

NOTE

A-B repeat playback cannot be used during random playback.

Playing in random order (Random playback)

During playback or stop mode, press [RANDOM].

The "RNDM" indicator lights in the display, and random playback starts.

Cancelling random playback

Press [RANDOM] or ■ during playback.

The "RNDM" indicator in the display disappears, and random playback mode is cancelled.

NOTE

- If <▶▶/▶▶▶> or [▶▶▶] is pressed during random playback, each time the button is pressed the unit switches to a different track in random order and starts playback.
- To search through the current track during random play, press and continue holding <◀◀/◀◀◀>, <▶▶/▶▶▶> or [◀◀, ▶▶].
- Random play is also cancelled when the power is switched to standby or off, or when the disc tray is opened.

Displaying CD-TEXT

You can view text information stored on a disc as CD-TEXT on this unit.

Mainly, information on the current track being played is displayed.

Press [TEXT] during playback.

The information changes in the following order each time [TEXT] is pressed.

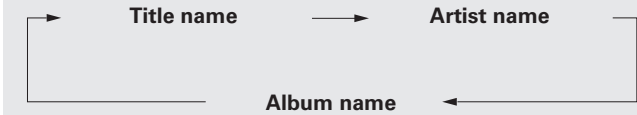

- A maximum of 32 characters can be displayed.

NOTE

As the stored information differs depending on the disc, all of the information may not be displayed.

To set which information is displayed first

You can set which information is displayed first when [TEXT] is pressed.

For details on the settings, see "File Info (File information display selection)" (🔍 page 22).

Symbols used to indicate buttons in this manual

- Button located on both the main unit and the remote control → **BUTTON**
- Button only on the main unit → **<BUTTON>**
- Button only on the remote control → **[BUTTON]**

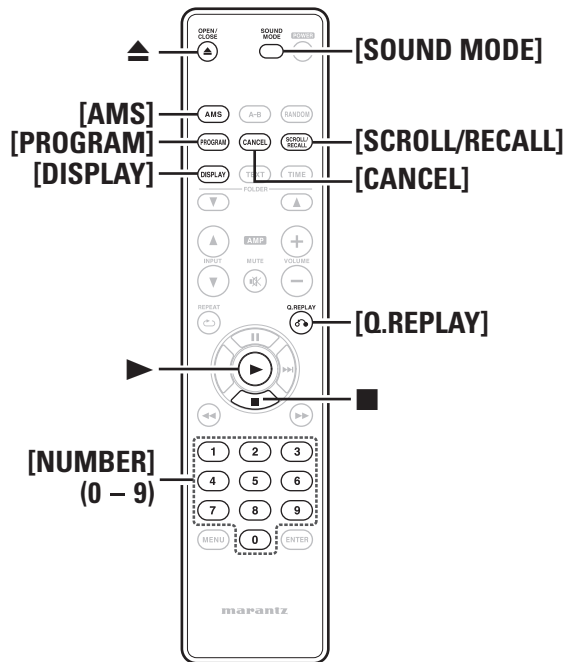
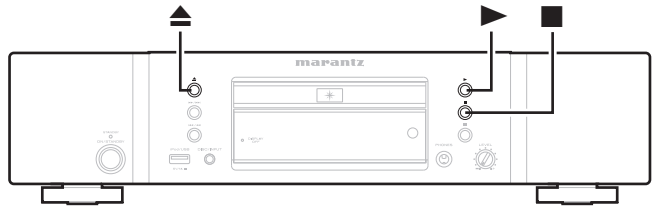

Playing tracks in a specific order (Program playback)

- 1 During stop mode, press [PROGRAM].**
The "PROG" indicator flashes in the display, and the mode switches to the program playback mode.
- 2 Press [NUMBER] (0 – 9) , and select the tracks you want to program.**
[Example] To program tracks 3 and 12 to be played in that order, press **[3]**, **[1]**, and **[2]** one after the other.
• The entered numbers are set approximately 1.5 seconds after the number buttons are pressed. To enter a two-digit number, be sure to press the two number buttons, one immediately after the other.
- 3 Press [▶].**
Playback starts in the programmed order.

Checking the program details

Press **[SCROLL/RECALL]** during programming or program playback. Each time **[SCROLL/RECALL]** is pressed, the programmed tracks are shown in order in the display.

Adding tracks for program playback

- Press **[PROGRAM]** when the unit is stopped (when the "PROG" indicator is lit).
- Press **[NUMBER] (0 – 9)**, and select the track number that you want to program.

Canceling a track from program playback

While stopped, press **[CANCEL]**. When **[CANCEL]** is pressed, tracks are deleted in order from the last programmed track.

Canceling all programmed tracks

During program playback, press **■** twice.

During stop mode, press **■** once.

- Program playback mode can also be cancelled using the following operations.
 - Switching the unit power to standby or off.
 - Pressing **▲** to open the disc tray.



- You can specify up to 30 tracks each for program playback.
- Repeat playback, random playback, and AMS playback can be used when "PROG" is lit in the display.

NOTE

Programmed playback is not possible with MP3, WMA and AAC files.

Skipping tracks you don't want to hear (Delete program playback)

1 During stop mode, press [PROGRAM] and [CANCEL] together.

The "PROG" indicator flashes in the display, and the mode switches to the delete program playback mode.

2 Press [NUMBER] (0 - 9), and select the track number that you want to skip.

[Example] If you want to skip the 3rd and 12th tracks, press [3], and then press [1] and [2].

- The entered numbers are set approximately 1.5 seconds after the number buttons are pressed. When pressing a 2-digit number, press the second digit immediately after the first.

3 Press ► Playback starts, and the selected tracks are skipped.

Checking details of the delete program

Press [SCROLL/RECALL] during delete programming or delete program playback.

Each time [SCROLL/RECALL] is pressed, the skipped tracks are shown in order in the display.

Cancelling delete program playback

During delete program playback, press ■ twice.

While stopped, press ■ once.

- All of the delete program tracks are erased when ▲ is pressed to open the disc tray.



A maximum of 30 tracks can be programmed for delete program playback.

Searching for a specific track (AMS playback)

You can play back all track intros, from the first track onward, in sequence. This function is useful when you search for a specific track you want to listen to.

(AMS playback: Auto Music Scan playback)

1 During playback or stop mode, press [AMS].

The ► indicator flashes in the display, and approximately 10-second AMS playback starts.

- When approximately 10 second AMS playback is selected, playback automatically switches to the next track.

2 When you find the track you want to listen to, press ►.

The ► indicator lights and normal playback is resumed.



AMS playback can be used during program playback and random playback.

Rewinding tracks slightly to listen again (Quick replay)

Simply press [Q.REPLAY] during playback to rewind the track the amount of time set in the menu and playback again (Default setting : 10 sec).

NOTE

Quick replay cannot be used between different tracks.

Also, if the overall time of the track being played back is shorter than the quick play setting time, or if the playback time is shorter than the quick play setting time, when [Q.REPLAY] is pressed the track is played back from the start.

Setting the quick play time

For details on the settings, see "Q Replay (Quick replay)" (page 22).

Turning digital output off

When the digital audio output terminals are not used, you can enjoy higher quality music by turning digital output off.

For details on the settings, see "CD D-OUT (CD digital output settings)" (page 20).

Switching Audio EX

This function turns the unit display and digital output off to playback higher sound quality from the audio signal.

During stop mode, press [SOUND MODE].

The Audio EX mode changes in the following order each time [SOUND MODE] is pressed.

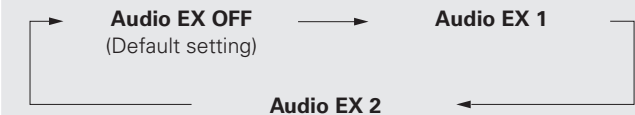

[Selectable items]

Audio EX OFF The default setting. Audio EX is not set.

- Digital output: Yes
- Display: Yes

Audio EX 1 Audio EX 1 offers better sound.

- Digital output : No
- Display: Yes

Audio EX 2 Audio EX 2 offers best sound from analog outputs.

- Digital output : No
- Display: No (during play)



Pressing [DISPLAY] shows the display for approximately 3 seconds.

Advanced connections

This chapter describes how to connect a USB memory device/ iPod and remote control.

For other connections, see the sections below.

- ❑ **Analog connection** (👉 page 7)
- ❑ **Connecting the power cord** (👉 page 7)

Preparations

Connecting cables

Select the cables according to the equipment being connected.

Audio cables

Optical digital connections



Optical cable (sold separately)

Coaxial digital connections



Coaxial digital cable (sold separately)

iPod connections



iPod cable (sold separately)

Remote control connection



Remote connector cable (supplied)

Digital connection

Use a optical transmission cable (sold separately) or coaxial digital cable to connect.

Digital audio output

You can enjoy digital recording when the player is connected to a CD recorder or other digital recording component.

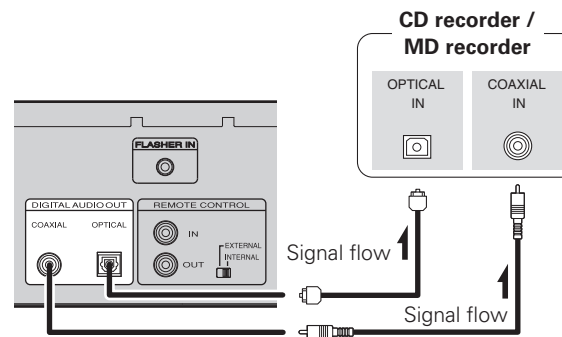

When connecting the optical digital output connector with an optical transmission cable (sold separately)

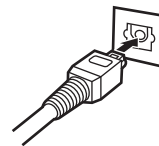

Match the shapes then insert firmly.

Connecting the flasher input jack

- This is used to control this unit using a keypad from another room. Set the remote control switch located on the rear panel of the connected audio component to "EXTERNAL" to use this feature.
- If a flasher input connector is to be used, do not use the remote control input connector.

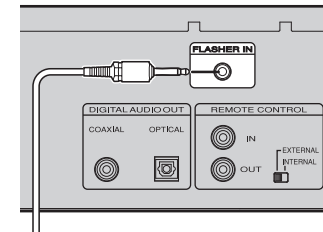

NOTE

Use the monaural mini-plug cable for connecting FLASHER IN jacks. Do not use the stereo mini-plug cable.

USB memory device/iPod connection

Connect a USB memory device or iPod to the USB port on the front panel of the unit.

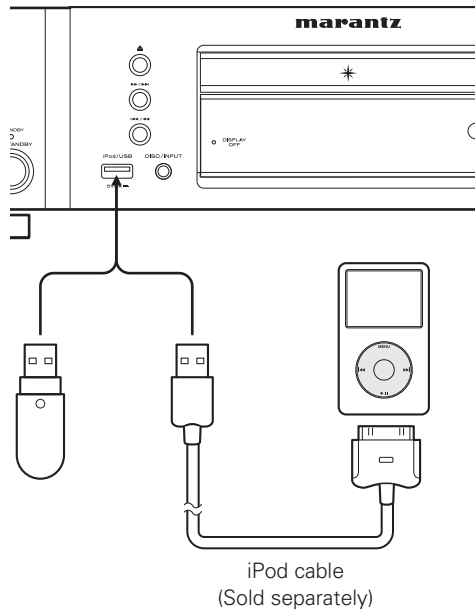

NOTE

- When connecting an iPhone to this unit, keep the iPhone at least 20 cm away from this unit. If the iPhone is kept closer to this unit and a telephone call is received by the iPhone, noise may be output from this device.
- It is not possible to connect and use a computer via the USB port of this unit using a USB cable.

Supported iPod Models

Made for

- iPod touch (4th generation)
- iPod touch (3rd generation)
- iPod touch (2nd generation)
- iPod touch (1st generation)
- iPod classic
- iPod with video
- iPod nano (6th generation)
- iPod nano (5th generation)
- iPod nano (4th generation)
- iPod nano (3rd generation)
- iPod nano (2nd generation)
- iPod nano (1st generation)
- iPhone
- iPhone 3G
- iPhone 3GS
- iPhone 4



iPhone



iPod touch
1st generation



iPod classic



iPod nano
3rd generation
(video)



iPhone 3G



iPod touch
2nd generation



iPod
5th generation
(video)



iPod nano
4th generation (video)



iPhone 3GS



iPod touch
3rd generation



iPod nano
1st generation



iPod nano
5th generation (video camera)



iPhone 4



iPod touch
4th generation



iPod nano
2nd generation
(aluminum)



iPod nano
6th generation

Remote control connection

When you use this unit connected to a marantz amplifier, this unit receives operation signals sent from the amplifier and operates accordingly.

Connection

Use the supplied remote connection cable to connect the REMOTE CONTROL IN terminal of this unit to REMOTE CONTROL OUT terminal of the amplifier.

Setting

- Turn the EXTERNAL/INTERNAL switch on the unit to "EXTERNAL".
- This setting will disable remote sensor reception of this unit.
- To operate the unit, point the remote control at the remote sensor of the amplifier.



To use this unit by itself without connecting an amplifier, turn the switch to "INTERNAL".

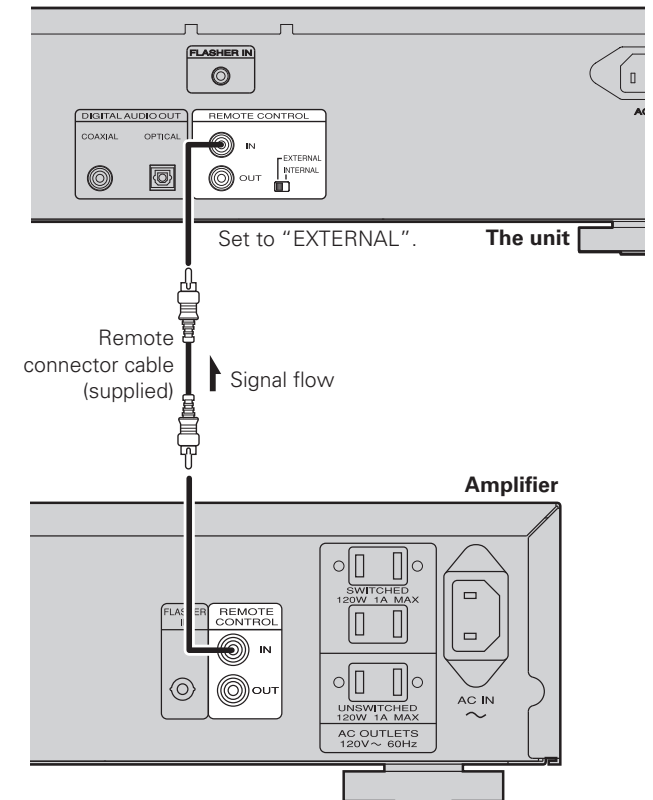

Advanced operations

Symbols used to indicate buttons in this manual

- Button located on both the main unit and the remote control → **BUTTON**
- Button only on the main unit → **<BUTTON>**
- Button only on the remote control → **[BUTTON]**

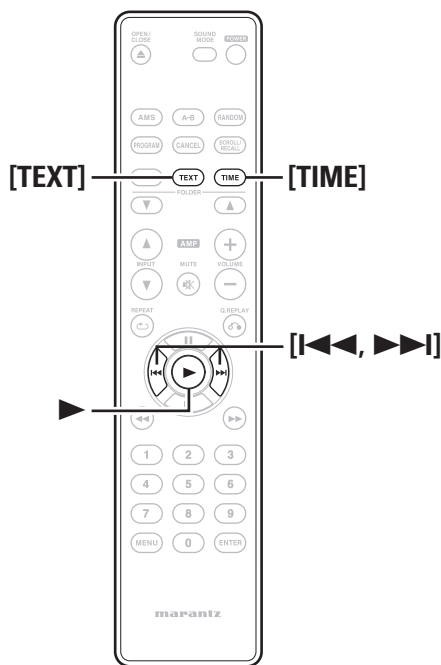
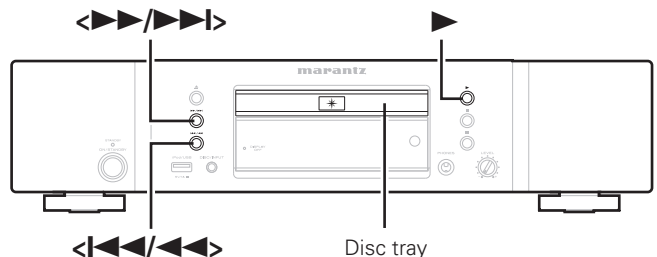

Playback of MP3, WMA and AAC files

There are many music distribution sites on the Internet allowing you to download music files in MP3 or WMA (Windows Media® Audio) formats. The music (files) downloaded from such sites can be stored on CD-R or CD-RW discs and played on the unit.

"Windows Media" and "Windows" are registered trademarks or trademarks of Microsoft Corporation in the United States and other countries.

Playable MP3, WMA and AAC formats

CD-R and CD-RW discs created in the format described below can be played.

Writing software format

ISO9660 level 1, 2
Expansion format (Juliet.Romeo)

- When written in other formats, it may not be possible to play the disc properly.

Maximum number of playable files and folders

Total number of folders and files : 511
Number of folders : 255



A maximum total of 512 folders and files can be used.

File formats

MP3 (MPEG-1 Audio Layer-3)
WMA (Windows Media Audio)
MPEG-4/AAC (Advanced Audio Coding)

Tag data

ID3-Tags (Ver. 1.x and 2.x)
META-Tags (Compatible with title, artist and album names)

Playable MP3/WMA file			
File format	Sampling frequency	Bit rate	Extension
MP3	32/44.1/ 48 kHz	For MPEG-1 Audio Layer-3, 32 – 320 kbps	.mp3
WMA	44.1 kHz	48 – 192 kbps	.wma
AAC	32/44.1/ 48 kHz	8 – 320 kbps	.m4a



- Only music files that are not copyright-protected can be played on this unit.
- Be sure to give files the extension ".mp3", ".wma" or ".m4a". Files with any other extensions or with no extensions cannot be played.
- In accordance with copyright laws, recordings you have made should only be used for your personal enjoyment and may not be used in other ways without permission of the copyright holder.

Playing MP3, WMA and AAC files

1 Load a CD-R or CD-RW disc containing music files in the MP3, WMA and AAC formats into the disc tray.

2 Press **▶**.
Playback starts.

Changing the playback file

Select the file that you want to playback by pressing **<|◀/▶|>**, **<▶▶/▶▶|>** or **[◀◀, ▶▶]**.

Switching the unit display

During playback, press **[TEXT]**.

The information changes in the following order each time **[TEXT]** is pressed.

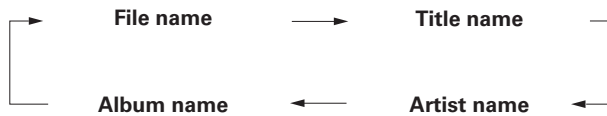

The file name scroll.

Setting which information is displayed first

You can set which information is displayed first when **[TEXT]** is pressed.

For details on the settings, see "File Info (File information display selection)" (📖 page 22).

Switching the time display

During playback, press **[TIME]**.

The time display changes in the following order each time **[TIME]** is pressed.



MP3, WMA or AAC playback order of MP3, WMA or AAC files

When there are multiple folders containing MP3, WMA or AAC files, the playback order of folders is automatically set when this unit reads the media. The files in each folder are played back in the order in which the files were recorded on the media, from the oldest date and time.

□ Playback order of folders

CD-R/CD-RW

For files recorded onto a CD-R or CD-RW disc, the files stored in the first-tier folders are played back first, followed by the files in all second-tier folders, then all files in the third-tier folders and so forth.

USB memory device

For files stored on a USB memory device, files stored in the first-tier folder are played first, followed by the files stored in the second-tier folder within the first-tier folder, followed by the files stored in the third-tier folder within the first-tier folder and so on. When all files within the first-tier folder have been played, the files in the second first-tier folder are played.



- The playback order displayed on a PC may differ from the actual playback order.
- The playback order with a CD-R/CD-RW may differ, depending on the writing software.

NOTE

The playback order may differ from the order in which the folders or files were recorded if you delete or add a folder or file on USB memory device. This occurs because of data recording specifications and is not a malfunction.

Symbols used to indicate buttons in this manual

- Button located on both the main unit and the remote control → **BUTTON**
- Button only on the main unit → **<BUTTON>**
- Button only on the remote control → **[BUTTON]**

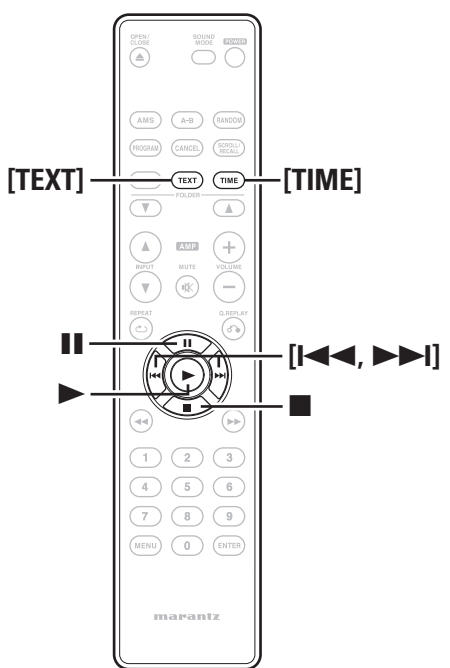
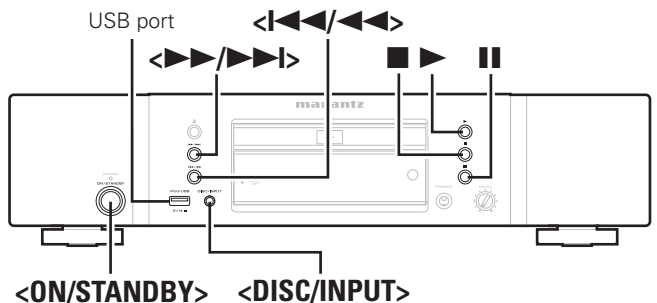

Playback iPod®

With the unit, you can listen to music on an iPod and you can also operate the iPod with the main unit or the remote control.



“Made for iPod” and “Made for iPhone” mean that an electronic accessory has been designed to connect specifically to iPod or iPhone, respectively, and has been certified by the developer to meet Apple performance standards. Apple is not responsible for the operation of this device or its compliance with safety and regulatory standards.

iPhone, iPod, iPod classic, iPod nano, iPod shuffle, and iPod touch are trademarks of Apple Inc., registered in the U.S. and other countries.

Individual users are permitted to use iPhone, iPod, iPod classic, iPod nano, iPod shuffle, and iPod touch for private copy and playback of non-copyrighted contents and contents whose copy and playback is permitted by law. Copyright infringement is prohibited by law.

NOTE

- 1st generation iPod nano and iPod with Video devices cannot be controlled from the iPod. Use the “Database (iPod database selection)” (page 25) operation to playback iPod files.
- If the iPod cannot be operated with its own controls, refer to “iPod Ctrl (Operating an iPod with its own controls)” (page 26) and change “iPod Ctrl=>” to “1 Direct”.
- Before turning off the power supply to the unit, make sure the iPod is stopped or paused.
- marantz cannot be held responsible for the loss or damage to any data stored on the iPod.
- This unit operations may not be available depending on the iPod software version.

Buttons that can be used when playing back from an iPod

Remote control buttons	iPod buttons	Operation on the unit
▶	▶	Plays the track
	▶	Pause
■	–	Return to the first track in the folder
◀◀, ▶▶	◀◀, ▶▶	Skip to previous or next track Fast forward and rewind cannot be used.

Playing an iPod®

- 1 Press **<ON/STANDBY>**.
- 2 Connect the iPod to the **USB port** on the front panel of this unit (page 14).
- 3 Press **<DISC/INPUT>** to change the input source to “USB”.
- 4 Select the file that you want to playback on the iPod.

Selecting the operating mode

You can set whether to perform iPod operations using the iPod controls, or using the unit remote control. For details on the settings, see “iPod Ctrl (Operating an iPod with its own controls)” (page 26).

Switching the unit display

During playback, press [TEXT].

The information changes in the following order each time [TEXT] is pressed.



Setting which information is displayed first

You can set which information is displayed first when [TEXT] is pressed.

For details on the settings, see "File Info (File information display selection)" (page 26).

NOTE

These settings are not reflected when "iPod Ctrl=>" is set to "1 Direct" (page 26).

Switching the time display

During playback, press [TIME].

The time display changes in the following order each time [TIME] is pressed.



Disconnecting the iPod

1 Press ■ to stop playback.

2 Disconnect the iPod cable from the USB port.

Playing a USB memory device

Playable USB memory formats

Files created in the following formats and stored on a USB memory device can be played.

USB-Compatible file systems

"FAT16" or "FAT32"

- If the USB memory device is divided into multiple partitions, only the top drive can be selected.

Maximum number of playable files and folders

Maximum number of files in a folder: 65,535

Maximum number of folders: 700

File format

MP3 (MPEG-1 Audio Layer-3)

WMA (Windows Media Audio)

MPEG-4/AAC (Advanced Audio Coding)

WAV (LINEAR PCM)

Tag data

ID3-Tags (Ver.1.x and 2.x)

META-Tags (Compatible with title, artist and album names)

Playable MP3/WMA file			
File format	Sampling frequency	Bit rate	Extension
MP3	32/44.1/ 48 kHz	For MPEG-1 Audio Layer3, 32 – 320 kbps	.mp3
WMA	32/44.1/ 48 kHz	CBR: 48 – 320 VBR: Peak 384 (display corresponds to average bit rate value)	.wma
AAC	32/44.1/ 48 kHz	8 – 320 kbps	.m4a
LINEAR PCM	Linear PCM: PCM 32/44.1/48 kHz Those other than the above, not supported.	Linear PCM: 16 bit	.wav



Only music files that are not copyright-protected can be played on this set.

- Contents downloaded from pay sites on the Internet are copyright protected. Also, files encoded in WMA format when ripped from a CD, etc., on a computer may be copyright protected, depending on the computer's settings.

Symbols used to indicate buttons in this manual

- Button located on both the main unit and the remote control → **BUTTON**
- Button only on the main unit → **<BUTTON>**
- Button only on the remote control → **[BUTTON]**

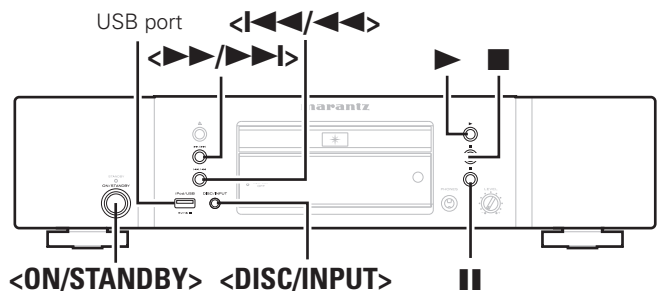

Playing files stored on USB memory devices

- 1 Press **<ON/STANDBY>**.
- 2 Connect the USB memory device to the USB port on the front panel of this unit (page 14).
- 3 Press **<DISC/INPUT>** to change the input source to "USB".
- 4 Press **▶**. Playback starts.

To switch the folder or file during playback

[Using the buttons on the unit]
During playback, press **<◀◀/◀▶>** or **<▶▶/▶▶>**.

[Using the buttons on the remote control]

- **Folder**
Use **[FOLDER ▲, ▼]** to select the folder, then press **[ENTER]**.
- **File**
Use **[◀◀]** or **[▶▶]** to select the file.

[Pencil icon]
The file numbers are set automatically when the USB memory device is loaded.

Stopping playback

Press **■**.

Stopping playback temporarily

- Press **||**.
- The **||** indicator lights.
 - To restart playback, press **▶** or **||**.

Fast-forwarding and fast-reversing (Searching)

[Using the buttons on the unit]

During playback, press and hold in **<◀◀/◀▶>** or **<▶▶/▶▶>**.
• When you remove your finger from the button, normal playback is resumed.

[Using the buttons on the remote control]

During playback, press and hold in **[◀◀, ▶▶]**.
• When you remove your finger from the button, normal playback is resumed.

NOTE

When normal playback is resumed after searching, the sound may be interrupted momentarily.

Playing repeatedly (Repeat playback)

Press **[REPEAT]**.

Playing in random order (Random playback)

During playback or stop mode, press **[RANDOM]**.

- The "RNDM" indicator lights, and random playback starts automatically.
- To cancel random playback, press **[RANDOM]** or **■**. The "RNDM" indicator goes dark and random playback is canceled.

Switching the unit display

During playback, press **[TEXT]**.
The information changes in the following order each time **[TEXT]** is pressed.

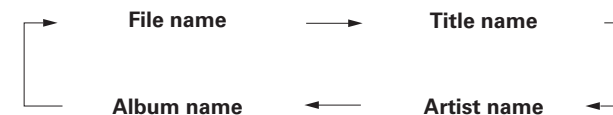

Setting which information is displayed first

You can set which information is displayed first when **[TEXT]** is pressed.
For details on the settings, see "File Info (File information display selection)" (page 23).

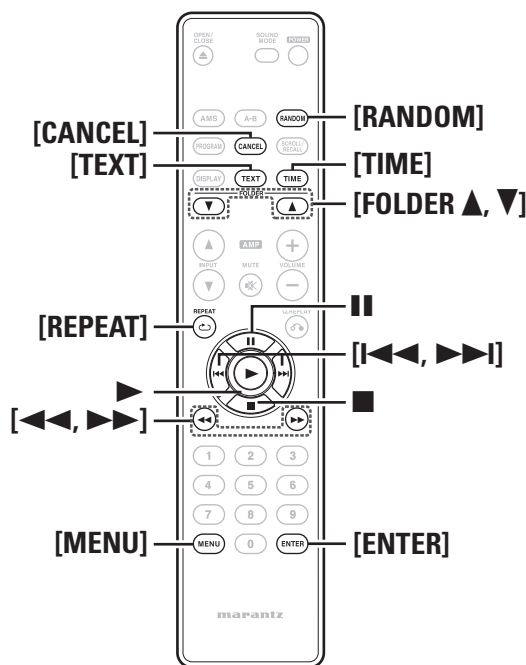

Playing a USB memory device

Switching the time display

During playback, press [TIME].

The time display changes in the following order each time [TIME] is pressed.

**NOTE**

- When a USB memory device is connected to this unit, the files recorded on the USB memory device are read. The read time differs depending on the amount of data stored on the USB memory device. If the maximum number of playable files or folders are stored on the USB memory device, it may take a few minutes to read the files.
- Before turning off the power supply to the unit, make sure the USB memory device is stopped or paused.
- If a USB memory device is connected to this unit, marantz cannot be held responsible for the loss or damage to any data stored on the USB memory device.
- The USB memory device will not operate if connected through a USB hub.
- Operation or power supply to all types of USB memory device cannot be guaranteed.

Removing the USB memory device

1 Press ■ or ■■ to stop playback.

2 Check that the communication indicator on the USB memory device is not flashing, then pull out the USB memory device.

NOTE

Do not remove the USB memory device from the unit when the USB memory communication indicator is flashing. Doing so may damage the USB memory device, or may corrupt the files recorded on the USB memory device.

Performing menu settings

You can set the following functions.

For details, see each of the explanation pages.

Menu operations

1 During stop mode, press [MENU].
The menu is shown on the unit display.

2 Press [◀◀] or [▶▶] to select the menu item you want to set.

3 Press [ENTER] to enter the settings.

- Press [CANCEL] to return to the previous item.
- To exit the menu, press [MENU] when the menu is being displayed. The menu disappears.

Selectable mode

CD D-OUT (CD digital output settings) (☞ page 20)

USB OUT (USB audio output settings) (☞ page 20)

Timer Play (Timer play setting) (☞ page 21)

CD Setup (Operating MP3, WMA and AAC files recorded on the disc) (☞ page 22)

USB Setup (USB memory device operation) (☞ page 23)

iPod Setup (iPod operation) (☞ page 25)

Auto STB (Auto standby function) (☞ page 27)

CD D-OUT (CD digital output settings)

Sets digital output for CD playback ON/OFF.

1 Select “CD D-OUT=>” using [◀◀] and [▶▶], and press [ENTER].

2 Set digital output to “1 On” or “2 Off” using [◀◀] and [▶▶], and press [ENTER].

[Selectable items]

1 On Output is digital.

2 Off Output is not digital.

3 Press [MENU].
The settings are saved, and the display returns to normal.

USB OUT (USB audio output settings)

For USB/iPod audio output, select either the digital output connector or the analog output connector.

1 Select “USB OUT=>” using [◀◀] and [▶▶], and press [ENTER].

2 Select the output connector using [◀◀] and [▶▶], and press [ENTER].

[Selectable items]

1 Analog Outputs audio from the analog output connector of the unit. Audio is not output from the digital output connector.

2 Digital Outputs audio from the digital output connector of the unit. Audio is not output from the analog output connector.

3 Press [MENU].
The settings are saved, and the display returns to normal.

 Symbols used to indicate buttons in this manual

Button located on both the main unit and the remote control → **BUTTON**

Button only on the main unit → **<BUTTON>**

Button only on the remote control → **[BUTTON]**

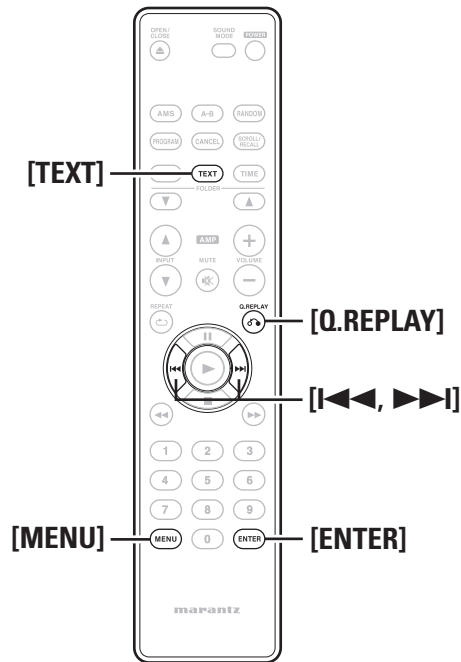

Timer Play (Timer play setting)

When this unit is connected to a commercially available external audio timer, the unit's power is switched on and media playback starts at the specified time.

- 1** Connect the audio timer to this unit.
- 2** Set the media that you want to playback in the unit.
- 3** Select "Timer Play=>" using [**I<<<**] and [**>>>I**], and press [**ENTER**].
- 4** Select "2 On=>" for the timer play settings using [**I<<<**] and [**>>>I**], and press [**ENTER**].

[Selectable items]

1 Off Timer play is not set.

2 On=> Timer play is set.

- 5** Select the playback media using [**I<<<**] and [**>>>I**], and press [**ENTER**].

[Selectable items]

1 CD Plays back the DISC media.

2 USB/iPod=> Plays back the USB memory device or iPod.

- 6** Press [**MENU**].
The settings are saved, and the display returns to normal.

- 7** Set the audio timer.

- For connection to audio timer and its operation, please refer to the instruction manual of your audio timer.

Performing menu settings

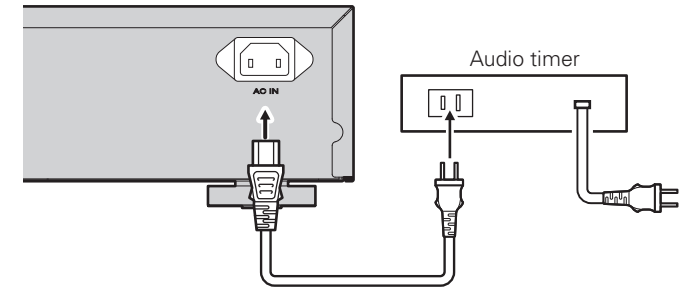

CD Setup (Operating MP3, WMA and AAC files recorded on the disc)

The "CD Setup" operating layers are as shown below.

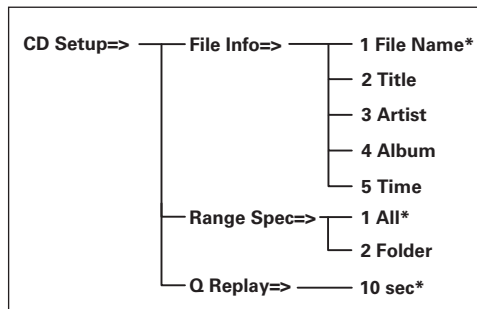

* Default setting

File Info (File information display selection)

When [TEXT] is pressed on the unit during disc playback, track information is shown on the display.

Here, you can set which information is displayed first when [TEXT] is pressed.

1 Select "CD Setup=>" using [I<<<] and [I>>>], and press [ENTER].

2 Select "File Info=>" using [I<<<] and [I>>>], and press [ENTER].

3 Select the information you want to display first using [I<<<] and [I>>>], and press [ENTER].

[Selectable items]

- | | |
|--------------------|------------------------------------|
| 1 File Name | The file name is displayed. |
| 2 Title | The track name is displayed. |
| 3 Artist | The artist name is displayed. |
| 4 Album | The album name is displayed. |
| 5 Time | The time information is displayed. |

4 Press [MENU].
The settings are saved, and the display returns to normal.

NOTE

- When playing a music CD, track information is only displayed when CD TEXT is recorded on the disc.
- Information that is not stored on the disc cannot be displayed.

Range Spec (Playback range selection)

You can set whether to play all of the files on the disc or just the files within a folder for playback.

1 Select "CD Setup=>" using [I<<<] and [I>>>], and press [ENTER].

2 Select "Range Spec=>" using [I<<<] and [I>>>], and press [ENTER].

3 Select the range you want to playback using [I<<<] and [I>>>], and press [ENTER].

[Selectable items]

- | | |
|-----------------|--|
| 1 All | Plays back all of the files on the disc. |
| 2 Folder | Plays back the files in the selected folder. |

4 Press [MENU].
The settings are saved, and the display returns to normal.

Q Replay (Quick replay)

You can set how many seconds a track is rewound when [Q.REPLAY] is pressed.

1 Select "CD Setup=>" using [I<<<] and [I>>>], and press [ENTER].

2 Select "Q Replay=>" using [I<<<] and [I>>>], and press [ENTER].

3 Set the rewind time using [I<<<] and [I>>>], and press [ENTER].
Can be selected in the 5-60 second range.

4 Press [MENU].
The settings are saved, and the display returns to normal.

Symbols used to indicate buttons in this manual

- Button located on both the main unit and the remote control → **BUTTON**
- Button only on the main unit → **<BUTTON>**
- Button only on the remote control → **[BUTTON]**

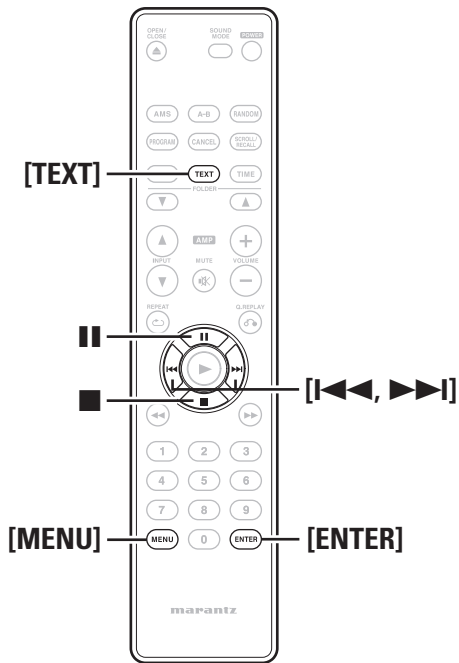
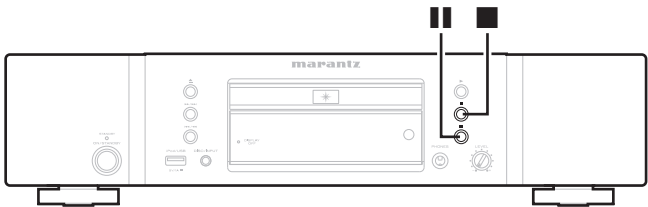

USB Setup (USB memory device operation)

The "USB Setup" operating layers are as shown below.

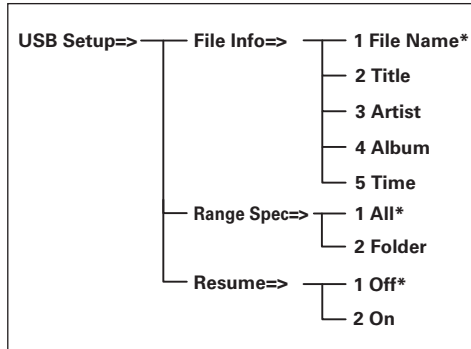

* Default setting

File Info (File information display selection)

When [TEXT] is pressed on the unit while playing back files from a USB memory device, information such as MP3 tag information is shown in the display.

Here, you can set which information is displayed first when [TEXT] is pressed.

1 Select "USB Setup=>" using [◀◀] and [▶▶], and press [ENTER].

2 Select "File Info=>" using [◀◀] and [▶▶], and press [ENTER].

3 Select the information you want to display first using [◀◀] and [▶▶], and press [ENTER].

[Selectable items]

- 1 File Name** The file name is displayed.
- 2 Title** The track name is displayed.
- 3 Artist** The artist name is displayed.
- 4 Album** The album name is displayed.
- 5 Time** The time information is displayed.

4 Press [MENU].
The settings are saved, and the display returns to normal.

Performing menu settings

Range Spec (Playback range selection)

You can set whether to play all of the files on the USB memory device, or just the files within a folder during playback.

1 Select “USB Setup=>” using [◀◀] and [▶▶], and press [ENTER].

2 Select “Range Spec=>” using [◀◀] and [▶▶], and press [ENTER].

3 Select the range you want to playback using [◀◀] and [▶▶], and press [ENTER].

[Selectable items]

1 All Plays back all of the files on the USB memory device.

2 Folder Plays back the files in the selected folder.

4 Press [MENU].
The settings are saved, and the display returns to normal.

Resume (Resume playback settings)

You can set whether to record the place where playback is stopped. When resume playback is set to on, this unit starts USB memory device playback from the start of the file that was previously being played.

1 Select “USB Setup=>” using [◀◀] and [▶▶], and press [ENTER].

2 Select “Resume=>” using [◀◀] and [▶▶], and press [ENTER].

3 Select “1 Off” or “2 On” for the resume playback settings using [◀◀] and [▶▶], and press [ENTER].

[Selectable items]

1 Off Resume playback is not set.

2 On Resume playback is set.

4 Press [MENU].
The settings are saved, and the display returns to normal.

NOTE

- Resume playback cannot be used if ■ is pressed to stop the USB memory device.
Press ■ to pause the track. Even if the input source is changed or the unit power is switched off, when the USB memory device is played again, playback starts from the start of the track that was previously being played back.
- Resume playback only works when an identical USB memory device is inserted. If another USB memory device is inserted, the unit will start playing from the first file.
- The unit may not play your desired file if files have been added to or deleted from the identical USB memory device.
- Playback will be resumed from the beginning of the current file.

Symbols used to indicate buttons in this manual

- Button located on both the main unit and the remote control → **BUTTON**
- Button only on the main unit → **<BUTTON>**
- Button only on the remote control → **[BUTTON]**

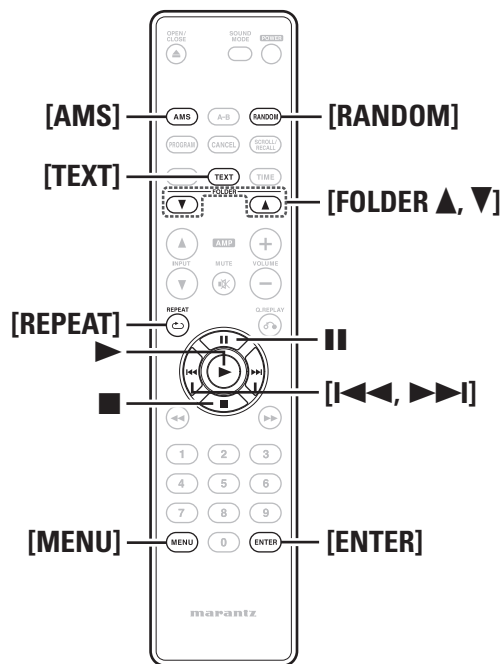
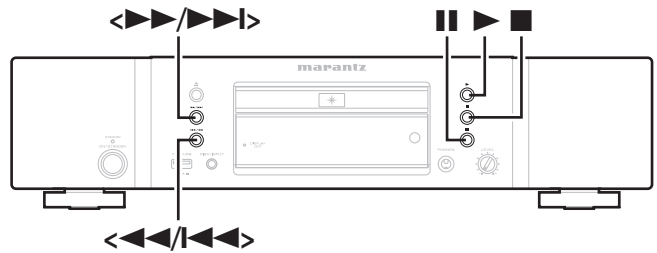

iPod Setup (iPod operation)

The "iPod Setup" operating layers are as shown below.

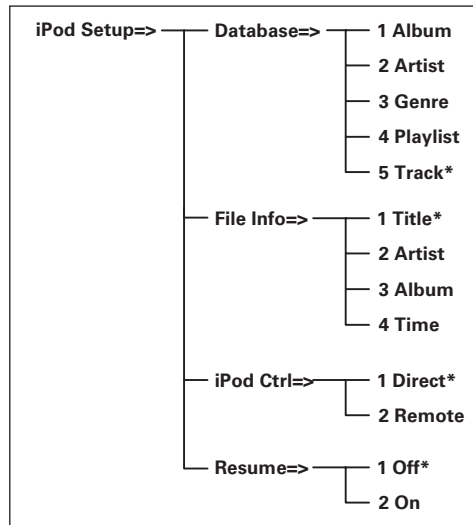

* Default setting

Database (iPod database selection)

Set which database within the iPod to playback files from.

- 1** Select "iPod Setup=>" using [**◀◀**] and [**▶▶**], and press [**ENTER**].
- 2** Select "Database=>" using [**◀◀**] and [**▶▶**], and press [**ENTER**].

- 3** Select the database from which you want to playback files using [**◀◀**] and [**▶▶**], and press [**ENTER**].

[Selectable items]

- 1 Album** Search files by album.
- 2 Artist** Search files by artist.
- 3 Genre** Search files by genre.
- 4 Playlist** Search files by playlist.
- 5 Track** Search files by track title.

- 4** Press [**MENU**].
The settings are saved, and the display returns to normal.

- 5** Select the folder that contains the files you want to playback using [**FOLDER ▲, ▼**], and press [**ENTER**].
Files included in the folder are displayed.

- 6** Select the music file that you want to playback using [**◀◀**] and [**▶▶**], and press [**▶**].
Playback starts.

NOTE

This cannot be set when "iPod Ctrl=>" (page 26) is set to "1 Direct".

File Info (File information display selection)

When [TEXT] is pressed while playing iPod files on the unit, file information is shown on the display.

Here, you can set which information is displayed first when [TEXT] is pressed.

1 Select “iPod Setup=>” using [◀◀] and [▶▶], and press [ENTER].

2 Select “File info=>” using [◀◀] and [▶▶], and press [ENTER].

3 Select the information you want to display first using [◀◀] and [▶▶], and press [ENTER].

[Selectable items]

1 Title The track name is displayed.

2 Artist The artist name is displayed.

3 Album The album name is displayed.

4 Time The time information is displayed.

4 Press [MENU].
The settings are saved, and the display returns to normal.

NOTE

When “iPod Ctrl=>” is set to “1 Direct”, the display order of file information cannot be changed.

Buttons that can be used when playing back from an iPod

Remote control buttons	Operation on the unit
▶	Plays the track
⏸	Pause
■	Return to the first track in the folder
◀◀, ▶▶	Skip to previous or next track Fast forward and rewind cannot be used
REPEAT	Switches the repeat function
RANDOM	Switches the shuffle function
AMS	Plays the first approximately 10 seconds of the track, then skips to the next track
TEXT	Switches the display

iPod Ctrl (Operating an iPod with its own controls)

You can set whether to perform iPod operations using the iPod controls, or using the unit remote control.

1 Select “iPod Setup=>” using [◀◀] and [▶▶], and press [ENTER].

2 Select “iPod Ctrl=>” using [◀◀] and [▶▶], and press [ENTER].

3 Select the device you want to operate using [◀◀] and [▶▶], and press [ENTER].

[Selectable items]

1 Direct In this mode, the iPod controls are operated directly while looking at the iPod display screen.

2 Remote In this mode, the iPod is operated while the iPod information is shown on the unit display.

Display mode		1 Direct	2 Remote
Display location		iPod display	Unit display
Playable files	Audio file	○	○
	Video file	○*	×
Active buttons	Remote control and this unit	○	○
	iPod	○	×

* Only audio is played back.

• For details on how to playback when “2 Remote” is set, see “Database (iPod database selection)” (page 25).

4 Press [MENU].
The settings are saved, and the display returns to normal.



When “1 Direct” is set, playback, pause, skip and stop can be performed using the unit remote control.

NOTE

1st generation iPod nano or iPod with Video do not support “1 Direct”. When a 1st generation iPod nano or iPod with Video is connected, the mode automatically switches to “2 Remote”.

Resume (Resume playback settings)

You can set whether to record the place where playback is stopped. When resume playback is set to on, this unit starts iPod playback from the start of the file that was previously being played.

1 Select “iPod Setup=>” using [◀◀] and [▶▶], and press [ENTER].

2 Select “Resume=>” using [◀◀] and [▶▶], and press [ENTER].

3 Select “1 Off” or “2 On” for the resume playback settings using [◀◀] and [▶▶], and press [ENTER].

[Selectable items]

1 Off Resume playback is not set.

2 On Resume playback is set.

4 Press [MENU].
The settings are saved, and the display returns to normal.

NOTE

Resume playback cannot be used if ■ is pressed to stop the iPod. Press ⏸ to pause the track. Even if the input source is changed or the unit power is switched off, when the iPod is played again, playback starts from the start of the track that was previously being played back.

 Symbols used to indicate buttons in this manual

Button located on both the main unit and the remote control → **BUTTON**

Button only on the main unit → **<BUTTON>**

Button only on the remote control → **[BUTTON]**

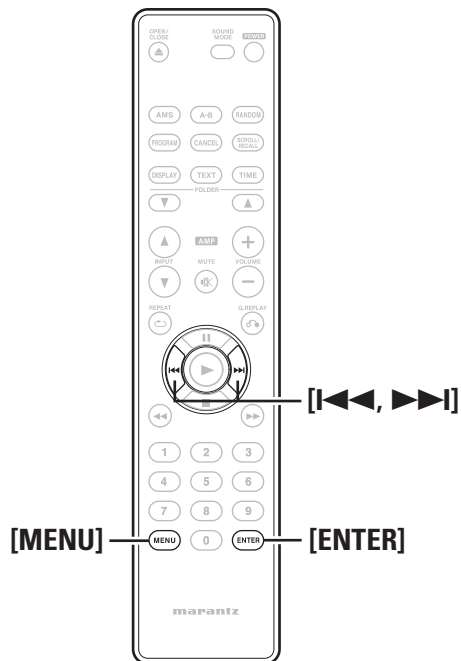

Performing menu settings

Auto STB (Auto standby function)

If the stopped state continues for more than 30 minutes, this unit automatically switches to standby mode.

1 Select “Auto STB=>” using [**<<<**] and [**>>>**], and press [**ENTER**].

2 Select “1 On” or “2 Off” for the auto standby function using [**<<<**] and [**>>>**], and press [**ENTER**].

[Selectable items]

1 On Auto standby function is enabled.

2 Off Auto standby function is disabled.

3 Press [**MENU**].
The settings are saved, and the display returns to normal.

Explanation of terms**B****Bit rate**

This expresses the read amount per 1 second of video/audio data recorded in a disc. A larger number means higher sound quality, but also means a larger file size.

M**MP3 (MPEG AudioPlayer 3)**

This is an internationally standardized audio data compression scheme, using the “MPEG-1” video compression standard. It compresses the data volume to about one eleventh its original size while maintaining sound quality equivalent to a music CD.

S**Sampling frequency**

Sampling involves taking a reading of a sound wave (analog signal) at regular intervals and expressing the height of the wave at each reading in digitized format (producing a digital signal). The number of readings taken in one second is called the “sampling frequency”. The larger the value, the closer the reproduced sound is to the original.

W**WMA (Windows Media Audio)**

This is audio compression technology developed by Microsoft Corporation.

WMA data can be encoded using Windows Media® Player Ver.7, 7.1, Windows Media® Player for Windows® XP and Windows Media® Player 9 Series.

To encode WMA files, only use applications authorized by Microsoft Corporation. If you use an unauthorized application, the file may not work properly.

Troubleshooting

If a problem should arise, first check the following:

1. Are the connections correct?

2. Is the set being operated as described in the owner's manual?

3. Are the other devices operating properly?

If this unit does not operate properly, check the items listed in the table below. Should the problem persist, there may be a malfunction.

In this case, disconnect the power immediately and contact your store of purchase.

[Disc]

Problem	Cause	Corrective action	Page
The disc fails to rotate.	• The power cord is pulled out of the socket.	• Insert the power cord plug into the socket.	7
	• Power to this unit is not ON.	• Turn the power to this unit ON.	8
	• The disc is not placed in the correct position on the disc tray.	• Place the disc in the disc tray correctly.	3
	• The disc is placed in upside down. (The disc is placed in with the label facing down).	• Place the disc in the disc tray correctly.	3
The disc stops rotating in mid-operation.	• The disc is dirty.	• Clean the disc's surface.	4
	• The disc is scratched.	• The disc may be unable to be played if it has a lot of scratches.	-
	• The disc is warped.	• The disc may be unable to be played if it is badly warped.	-
The disc is rotating but no sound is heard.	• The amplifier and speakers are not connected correctly.	• Connect the cables correctly. (See the instruction manual for the amplifier.)	7
	• The amplifier power is not ON.	• Turn ON the power to the amplifier. (See the instruction manual for the amplifier.)	-
	• The amplifier's function or selector switch is not set to "CD" or "AUX" or such (to whatever you have connected this unit to).	• Switch the amplifier's function or selector switch to "CD" or "AUX" or such (to whatever you have connected this unit to). (See the instruction manual for the amplifier.)	-
	• The amplifier's volume control is set at the minimum level.	• Adjust the amplifier volume. (See the instruction manual for the amplifier.)	-

Problem	Cause	Corrective action	Page
CD-R/CD-RW disc cannot be played.	• The disc is placed in upside down.	• Place the disc in the tray correctly.	3
	• The information recorded is not in an audio (CD-DA) format. Or the MP3/WMA/AAC file was not properly recorded.	• Record correct information that is compatible with this unit.	15

[Display]

Problem	Cause	Corrective action	Page
"OverCurrent" appears on the display.	• The voltage able to be supplied from this unit via the USB memory device has been exceeded.	• The USB memory device is not supported. Please use a USB memory device with an operating current that is less than 1 A.	-
"FAT Error" or "Cluster Err" appear on the display.	• An unsupported file system is being used. USB memory device below 128 MB cannot be supported.	• Please use a USB memory device formatted with a compatible file system (FAT32 or FAT16) and that has at least 256 MB of memory.	-
"No File" appears on the display.	• No file able to be played on this unit exists.	• Check supported formats.	15, 18
"DRM Stream" appears on the display.	• This is a file subject to digital rights management.	• Cannot play on this unit because of unsupported DRM.	16, 18

[USB/iPod]

Problem	Cause	Corrective action	Page
Sound cannot be heard even when USB memory device is connected.	• The amplifier and speakers are not connected properly.	• Connect the cables correctly. (See the instruction manual for the amplifier.)	14
	• The amplifier power is not ON.	• Turn the amplifier power ON. (See the instruction manual for the amplifier.)	-
	• The amplifier's function or selector switch is not set to "CD" or "AUX" or such (to whatever you have connected this unit to).	• Switch the amplifier's function or selector switch to "CD" or "AUX" or such (to whatever you have connected this unit to). (See the instruction manual for the amplifier.)	-
	• The amplifier's volume control is set at the minimum level.	• Adjust the amplifier volume. (See the instruction manual for the amplifier.)	-

Problem	Cause	Corrective action	Page
Sound cannot be heard even when an iPod is connected.	• Models prior to 5th generation iPods are not supported.	• For details, see "Supported iPod Models".	14
	• The amplifier and speakers are not connected correctly.	• Connect the cables correctly. (See the instruction manual for the amplifier.)	14
	• The amplifier's function or selector switch is not set to "CD" or "AUX" or such (to whatever you have connected this unit to).	• Switch the amplifier's function or selector switch to "CD" or "AUX" or such (to whatever you have connected this unit to). (See the instruction manual for the amplifier.)	–
	• The amplifier's volume control is set at the minimum level.	• Adjust the amplifier volume. (See the instruction manual for the amplifier.)	–
It takes time for USB memory device to be read.	• When connecting a high-capacity USB memory device, it will take time to read depending on its capacity. Several minutes may be required for reading when using a high-capacity device.	• Wait until reading is completed.	–
There is no sound output from this unit when music files stored on a USB memory device or iPod are played.	• The "USB OUT" setting is set to "2 Digital".	• Change the "USB OUT" setting to "1 Analog".	20

[Remote control]

Problem	Cause	Corrective action	Page
Remote control operation is not possible.	• The distance between this unit and the remote control is too great.	• Move closer to this unit, and operate the remote control within the operating range.	4
	• There is an obstacle between this unit and the remote control.	• Remove the obstacle.	4
	• The remote control's batteries are dead.	• Replace all batteries with new ones.	4
	• The remote control sensor is being subjected to strong light.	• Move so that the remote control sensor is not subjected to strong light.	4
	• The switch on the back of the REMOTE CONTROL is on "EXTERNAL".	• When using this unit independently, set the switch to "INTERNAL".	14

Specifications

Audio performance

- **Analog output**
 - Channels:** 2 channels
 - Playable frequency range:** 2 Hz – 20 kHz
 - Playable frequency response:** 2 Hz – 20 kHz
 - S/N:** 110 dB
 - Dynamic range:** 100 dB
 - Harmonic distortion:** 0.002 % (1 kHz)
 - Wow & flutter:** Crystal accuracy
- **Output level**
 - Signal type:** 2.2 V RMS stereo
 - Headphone output:** 28 mW/32 Ω (variable maximum)
- **Digital output**
 - output level (cinch JACK):** 0.5 Vp-p (75 Ω)
 - output level (optical):** -19 dBm
- **Optical Readout System**
 - Laser:** AlGaAs
 - Wave length:** 780 nm
 - Signal type:** 16-bit linear PCM
 - Sampling frequency:** 44.1 kHz

General

- Power supply:** AC 120 V, 60 Hz
- Power consumption:** 32 W
Standby: 0.3 W or less
- Operating temperatures:** +5 °C – +35 °C
- Operating humidity:** 5 – 90 % (without dew)

* For purposes of improvement, specifications and design are subject to change without notice.

Index

Numerics

1-track repeat 10

A

AAC 15, 16, 18
 A-B repeat playback 10
 Accessories 2
 All-track repeat 10
 AMS playback 12
 Audio EX 12
 Auto STB (Auto standby mode) 27

B

Batteries 4
 Bit rate 15, 18, 27

C

Cable
 Audio cable 7, 13
 Coaxial digital cable 13
 iPod cable 13, 14
 Optical cable 13
 Power cord 7
 Remote connector cord 13, 14
 CD D-OUT (CD digital output settings) 20
 CD-R/CD-RW 3, 16
 CD Setup 22
 CD-TEXT 10
 Condensation 3
 Connection
 Analog connection 7
 Coaxial digital connection 13
 Connecting cable 7, 13
 Connecting the flasher input jack 13
 iPod 14
 Optical digital connection 13
 Power cord 7
 Remote control 14
 USB memory device 14

D

Database (iPod database selection) 25
 Delete program playback 12
 Direct searching 9
 Display 5, 9

E

EXTERNAL 14

F

Fast-forwarding 9, 19
 Fast-reversing 9, 19
 File Info
 (File information display selection) 22, 23, 26
 Finalize 3
 Front panel 5

H

Headphone 10

I

INTERNAL 14
 iPod Ctrl
 (Operating an iPod with its own controls) 26
 iPod Setup 25

M

Menu operations 20
 MP3 15, 16, 18, 27
 Music CDs 3

P

Playback
 A-B repeat playback 10
 AMS playback 12
 CD 9
 Delete program playback 12
 iPod 17, 25
 Program playback 11
 Random playback 10, 19, 26
 Repeat playback 10, 19, 26
 Stopping playback 9, 19
 Stopping playback temporarily 9, 19
 USB memory device 18

Q

Q Replay (Quick replay) 22
 Quick replay 12

R

Random playback 10, 19, 26
 Range Spec (Playback range selection) 22, 24
 Rear panel 6
 Remote control 4, 6
 Inserting the batteries 4
 Operating range of the remote control 4
 Repeat playback 10, 19, 26
 Resume 24, 26

S

Sampling frequency 15, 18, 27
 Searching 9, 19
 Skipping 9
 Stopping playback 9, 19
 Stopping playback temporarily 9, 19
 Switching the input source 8
 Switching the unit display 16, 18, 19

T

Time display 9, 16, 18, 20
 Timer play 21

U

USB OUT (USB audio output settings) 20
 USB Setup 23

W

WMA 15, 16, 18, 27



Dimensions / Dimensions / Dimensions

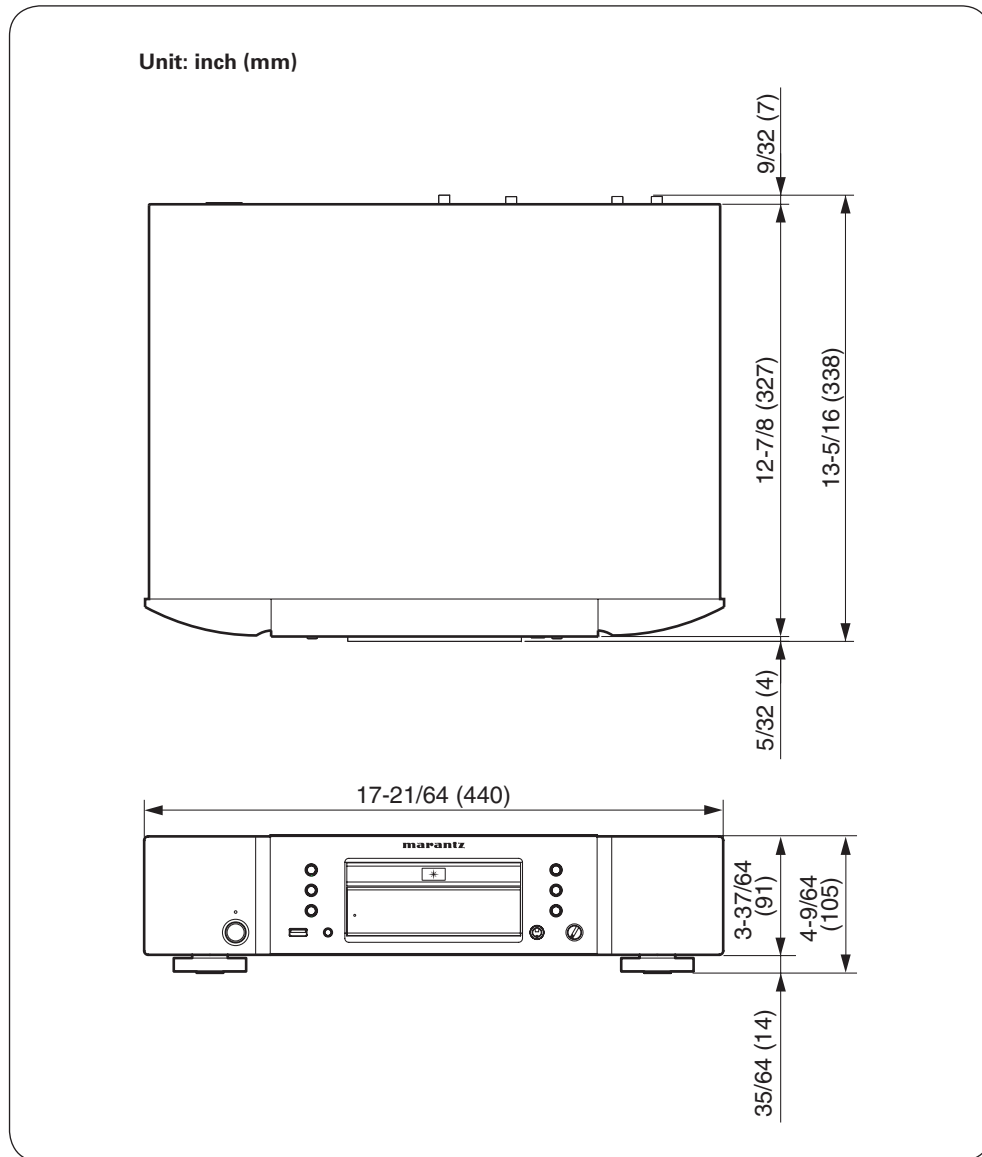

Weight / Poids / Peso

6.6 kg (14 lbs 8.8 oz)

www.marantz.com

You can find your nearest authorized distributor or dealer on our website.

marantz[®] is a registered trademark.

D&M Holdings Inc.
Printed in China 5411 10731 02AS

Free Manuals Download Website

<http://myh66.com>

<http://usermanuals.us>

<http://www.somanuals.com>

<http://www.4manuals.cc>

<http://www.manual-lib.com>

<http://www.404manual.com>

<http://www.luxmanual.com>

<http://aubethermostatmanual.com>

Golf course search by state

<http://golfingnear.com>

Email search by domain

<http://emailbydomain.com>

Auto manuals search

<http://auto.somanuals.com>

TV manuals search

<http://tv.somanuals.com>