

ENGLISH

FRANÇAIS

ESPAÑOL

marantz[®] Integrated Amplifier **PM6005**

Getting Started

Mise en route

Antes de empezar

Welcome

Thank you for choosing a Marantz amplifier. This guide provides step-by-step instructions for setting up your amplifier.

If you have setup problems:

If you need additional help in solving problems, contact Marantz customer service in your area.

For details, see the Marantz homepage. www.marantz.com

1-855-ONE-MARANTZ

1-855-663-6272

Call for Assistance: 9:00AM to 8:00PM M-F E.S.T.







For frequency asked questions please visit

<http://marantz.custhelp.com/app/answers/list>

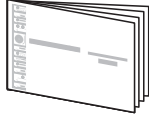
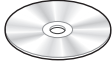
For US and Canada only

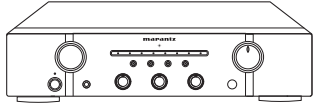
Before You Begin

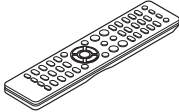
What's In the Box

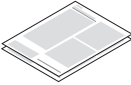
 Getting Started	 Owner's Manual	 Safety Instructions
 Amplifier	 Power cord	
 Remote control unit	 R03/AAA batteries	 Warranty (for USA) (for CANADA)

Setup

There are six steps to the setup process.

- 1** Install batteries in the remote control unit
- 2** Connect the speakers to the amplifier
- 3** Connect the CD player to the amplifier
- 4** Plug the power cord into a power outlet
- 5** Turn the amplifier's power on
- 6** Begin playback

1

Install batteries in the remote control unit

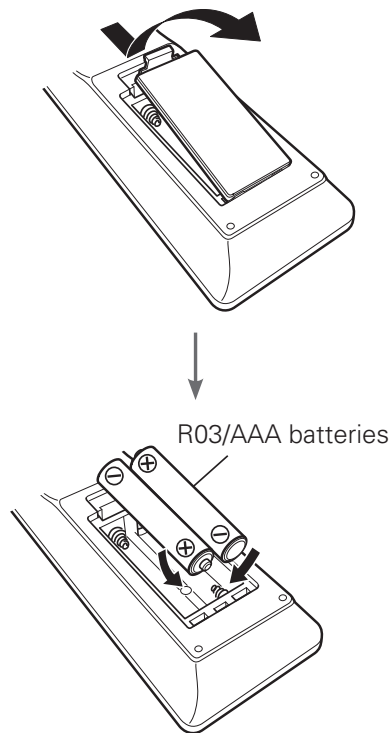

2 Connect the speakers to the amplifier

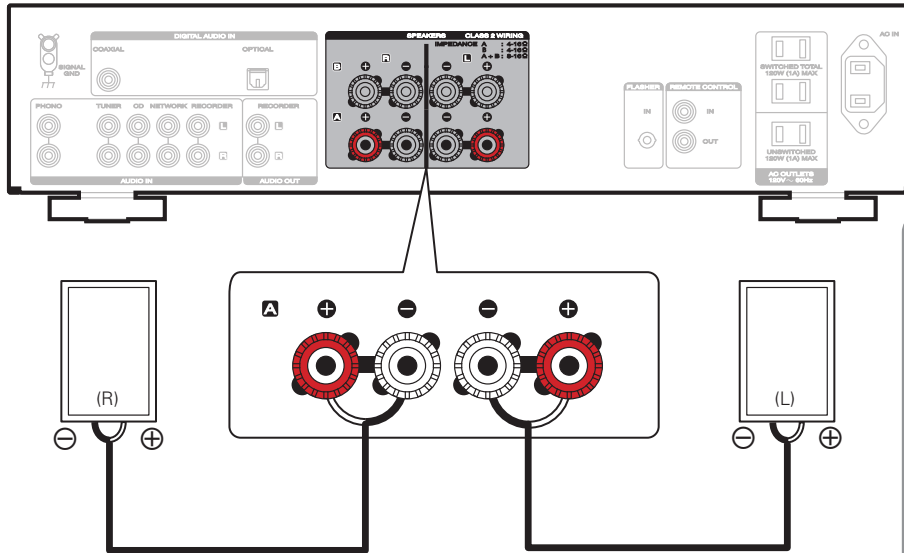

Connecting the speaker cables

- 1 Peel off about 3/8 inch (10 mm) of sheathing from the tip of the speaker cable, then either twist the core wire tightly or apply solder to it.
- 2 Turn the speaker terminal counterclockwise to loosen it.
- 3 Insert the speaker cable's core wire to all the way into the speaker terminal.
- 4 Turn the speaker terminal clockwise to tighten it.



3 Connect the CD player to the amplifier

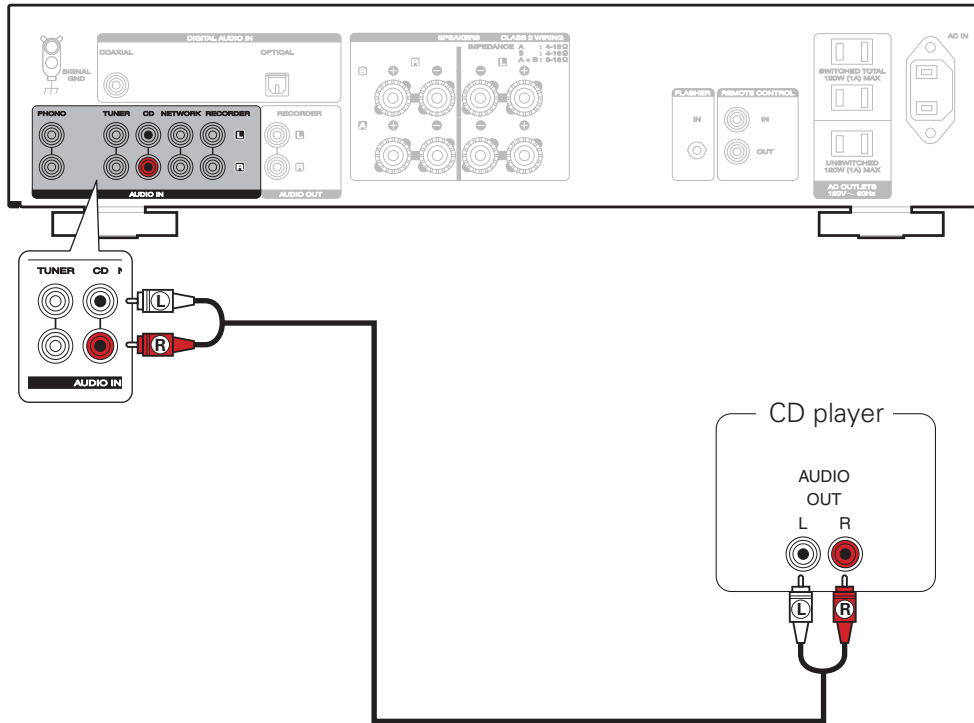

4 Plug the power cord into a power outlet

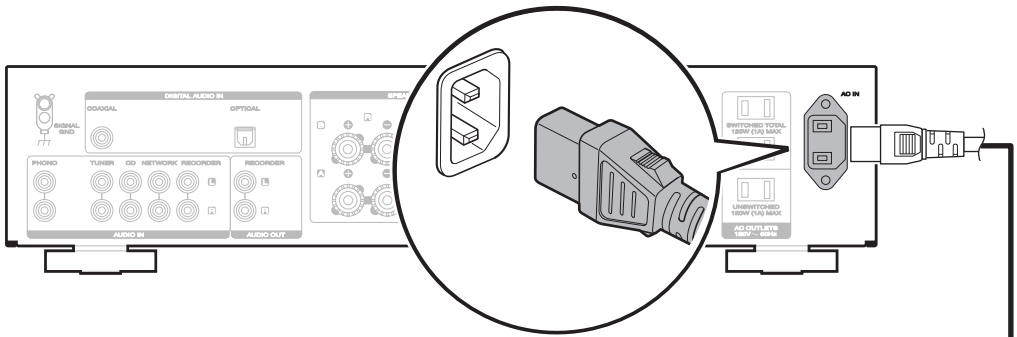

Connect to household power outlet (AC 120 V, 60 Hz)

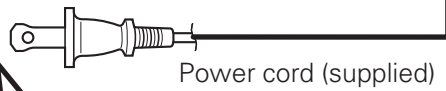

Power cord (supplied)

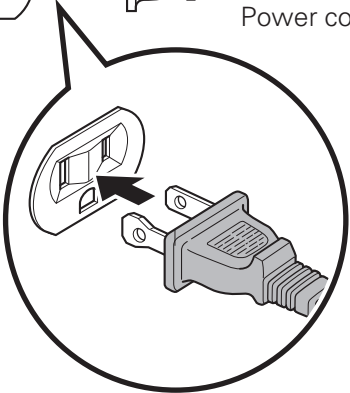

5 Turn the amplifier's power on

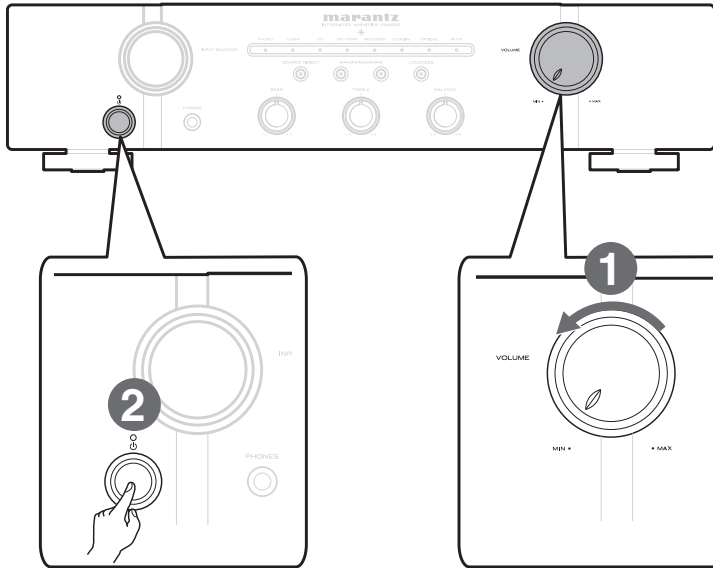

- 1 Reduce the volume to the minimum level.
- 2 Press the power operation button.

6 Begin playback

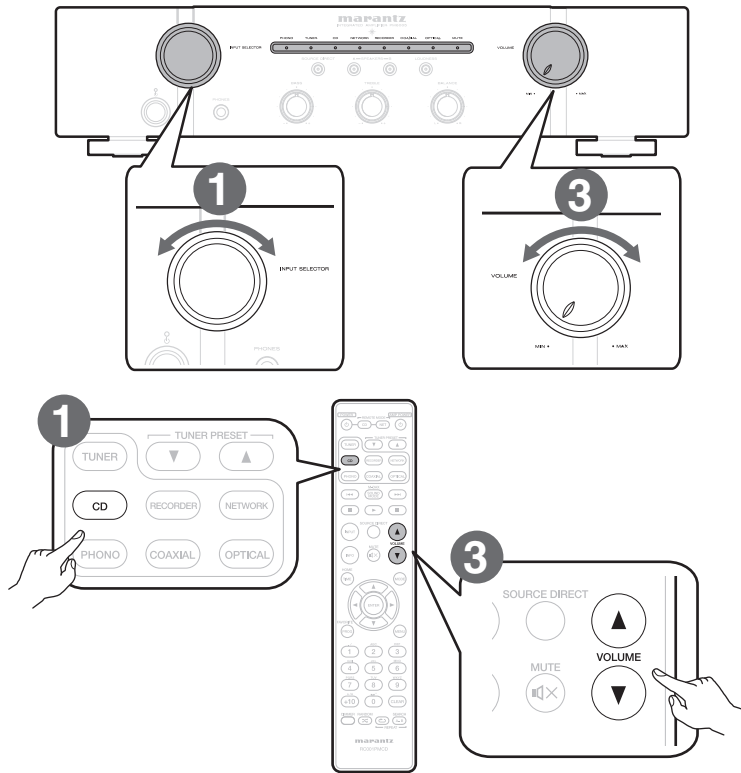

1 Set the input source to “CD”.

2 Play the CD player.

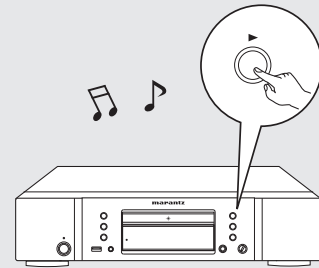

3 Adjust the volume.

Owner's Manual

The included CD-ROM contains an Adobe PDF version of the full owner's manual for the amplifier.
Please reference this manual for more details about the setup and operation of the amplifier and its features.

1 Insert the disc into your PC.

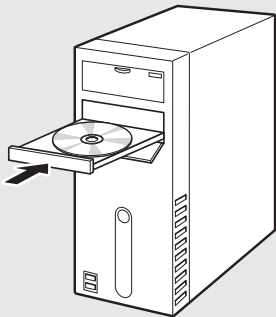

2 Follow the screen or double click on the PDF file.

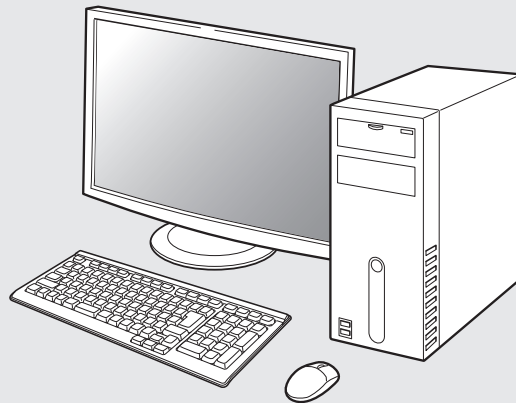

www.marantz.com

You can find your nearest authorized distributor or dealer on our website.

marantz[®] is a registered trademark.

D&M Holdings Inc.
Printed in China 5411 11112 00AM

Free Manuals Download Website

<http://myh66.com>

<http://usermanuals.us>

<http://www.somanuals.com>

<http://www.4manuals.cc>

<http://www.manual-lib.com>

<http://www.404manual.com>

<http://www.luxmanual.com>

<http://aubethermostatmanual.com>

Golf course search by state

<http://golfingnear.com>

Email search by domain

<http://emailbydomain.com>

Auto manuals search

<http://auto.somanuals.com>

TV manuals search

<http://tv.somanuals.com>