

PROFESSIONAL

Model CDR300 User Guide

CD Recorder

marantz®

CLASS 1 LASER PRODUCT
KLASSE 1 LASER PRODUKT
I.H.T. IEC 825

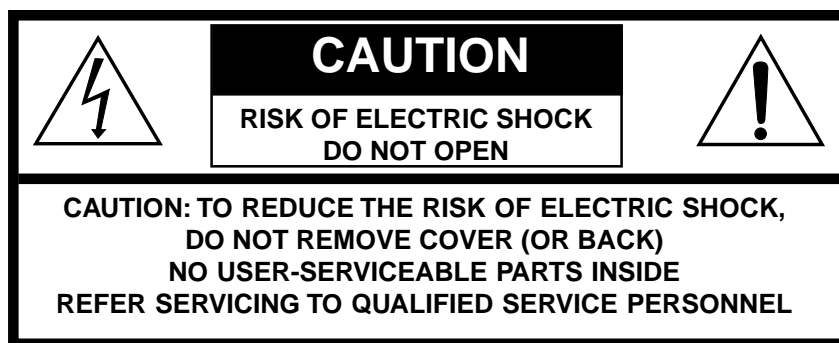

The lightning flash with arrowhead symbol, within an equilateral triangle, is intended to alert the user to the presence of uninsulated "dangerous voltage" within the product's enclosure that may be of sufficient magnitude to constitute a risk of electric shock to persons.



The exclamation point within an equilateral triangle is intended to alert the user to the presence of important operating and maintenance (servicing) instructions in the literature accompanying the appliance.

LASER SAFETY

This unit employs lasers. Only a qualified service person should remove the cover or attempt to service this device, due to possible eye injury.

CAUTION

**USE OF CONTROLS OR ADJUSTMENTS
OR PERFORMANCE OF PROCEDURE
OTHER THAN THOSE SPECIFIED
HEREIN MAY RESULT IN HAZARDOUS
RADIATION EXPOSURE.**

WARNING

TO REDUCE THE RISK OF FIRE OR ELECTRIC SHOCK, DO NOT EXPOSE THIS APPLIANCE TO RAIN OR MOISTURE.

NOTE:

This equipment has been tested and found to comply with the limits for a Class B digital device, pursuant to Part 15 of the FCC Rules. These limits are designed to provide reasonable protection against harmful interference in a residential installation. This equipment generates, uses and can radiate radio frequency energy and, if not installed and used in accordance with the instructions, may cause harmful interference to radio communications. However, there is no guarantee that interference will not occur in a particular installation. If this equipment does cause harmful interference to radio or television reception, which can be determined by turning the equipment off and on, the user is

encouraged to try to correct the interference by one or more of the following measures:

- Re-orient or relocate the receiving antenna.
- Increase the separation between the equipment and receiver.
- Connect the equipment into an outlet on a circuit different from that to which the receiver is connected.
- Consult the dealer or an experienced radio/TV technician for help.

NOTE: Changes or modifications may cause this unit to fail to comply with Part 15 of the FCC Rules and may void the user's authority to operate the equipment.

This Class B digital apparatus meets all requirements of the Canadian Interference Causing Equipment Regulations.

Cet appareil numérique de la Class B respecte toutes les exigences du Règlement sur le matériel brouilleur du Canada.

SAFETY INSTRUCTIONS

READ BEFORE OPERATING EQUIPMENT

This product was designed and manufactured to meet strict quality and safety standards. There are, however some installation and operation precautions which you should be particularly aware of.

1. Read Instructions – All the safety and operating instructions should be read before the appliance is operated.
2. Retain Instructions – The safety and operating instructions should be retained for future reference.
3. Heed Warnings – All warnings on the appliance and in the operating instructions should be adhered to.
4. Follow Instructions – All operating and use instructions should be followed.
5. Cleaning – Unplug this product from the wall before cleaning. Do not use liquid cleaners or aerosol cleaners. Use a damp cloth for cleaning.
6. Attachments – Do not use attachments not recommended by the product manufacturer as they may cause hazards.
7. Water and Moisture – The do not use this product near water – for example, near a bathtub, washbowl, kitchen sink, laundry tub, in a wet basement, or near a swimming pool, and the like.
8. Accessories – Do not place this product on an unstable cart, stand, tripod, bracket, or table. The product may fall, causing serious injury to a child or adult, and serious damage to the product. Use only with a cart, stand, tripod, bracket, or table recommended by the manufacturer or sold with the product. Any mounting of the product should follow the manufacturer's instructions, and should use a mounting accessory recommended by the manufacturer.
9. A product cart combination should be moved with care. Quick stops, excessive force, and uneven surfaces may cause the product and cart to overturn.
10. Ventilation – Slots and openings in the cabinet are provided for ventilation and to ensure reliable operation of the product and to protect it from overheating, and these openings must not be blocked or covered. The openings should never be blocked by placing the product on a bed, sofa, rug, or other similar surface. This product should not be placed in built-in installations such as a bookcase or rack unless proper ventilation is provided or the manufacturer's instructions have been adhered to.
11. Power sources – This product should be operated only from the type of power source indicated on the marking label. If you are not sure of the type of power supply to your home, consult your product dealer or local power company. For products intended to operate from battery power, or other sources, refer to the operating instructions.
12. Ground or Polarization – This product may be equipped with a polarized alternating current line plug (a plug having one blade wider than the other). This plug will fit into the power supply outlet only one way. This is a safety feature. If you are unable to insert the plug fully into the outlet, try reversing the plug. If the plug should still fail to fit, contact your electrician to replace your obsolete outlet. Do not defeat the safety purpose of the polarized plug.

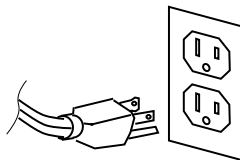

AC polarized plug and receptacle

13. Power cord protection – Power supply cords should be routed so that they are not likely to be walked on or pinched by items placed upon or against them, paying particular attention to cords at plugs, convenience receptacles and the point where they exit from the product.
14. Protective Attachment Plug – The product is equipped with an attachment plug having overload protection. This is a safety feature. See Instruction Manual for replacement or resetting of protective device. If replacement of the plug is required, be sure the service technician has used a replacement plug specified by the manufacturer that has the same overload protection as the original plug.
15. Lightning – For added protection for this product during a lightning storm, or when it is left unattended and unused for long periods of time, unplug it from the wall outlet and disconnect the antenna or cable system. This will prevent damage to the product due to lightning and power line surges.
16. Power Lines – An outside antenna system should not be located in the vicinity of overhead power lines or other electric light or power circuits, or where it can fall into such power lines or circuits. When installing an outside antenna system, extreme care should be taken to keep from touching such power lines or circuits as contact with them might be fatal.
17. Overloading – Do not overload wall outlets, extension cords, or integral convenience receptacles as this can result in a risk of fire or electric shock.
18. Object and Liquid Entry – Never push objects of any kind into this product through openings as they may touch dangerous voltage points or short-out parts that could result in fire or electric shock. Never spill liquid of any kind on the product.
19. Servicing – Do not attempt to service this product yourself as opening or removing covers may expose you to dangerous voltage or other hazards. Refer all servicing to qualified service personnel.
20. Damage Requiring Service – Unplug this product from the wall outlet and refer servicing to qualified service personnel under the following conditions:
 - a. When the power supply cord or plug has been damaged.
 - b. If liquid has been spilled or objects have fallen into the product.
 - c. If the product has been exposed to rain or water.
 - d. If the product does not operate normally by following the operating instructions. Adjust only those controls that are covered by the operating instructions as an improper adjustment of other controls may result in damage and will often require extensive work by a qualified technician to restore the product to its normal operation.
 - e. If the product has been dropped or damaged in any way.
 - f. When the product exhibits a distinct change in performance – this indicates a need for service.
21. Replacement Parts – When replacement parts are required, be sure the service technician has used replacement parts specified by the manufacturer or have the same characteristics as the original part. Unauthorized substitutions may result in fire, electric shock, or other hazards.
22. Safety Check – Upon completion of any service or repairs to this product, ask the service technician to perform safety checks to determine that the product is in proper operating condition.
23. Wall or Ceiling Mounting – The product should be mounted to a wall or ceiling only as recommended by the manufacturer.
24. Heat – The product should be situated away from heat sources such as radiators, heat registers, stoves, or other products (including amplifiers) that produce heat.

Specifications

General

System Compact Disc Digital Audio (CD-DA)
Number of channels 2 (stereo)
Applicable discs CD, CD-R, CD-RW
Power requirements AC100V-240V, 50/60 Hz, 21W

DC 13.2V, 1.5A
Max DC 16V, 2.5A
Dimensions (maximum)
Width 11 inches (279 mm)
Height 4 inches (102 mm)
Depth 9 inches (229 mm)
Weight 7 pounds (3.2 Kg)

Audio

ADC 24 Bit Resolution 64x over sampling
DAC 16 Bit Resolution 8x over sampling
Overall frequency response 20 Hz - 20 kHz

CD-R drive output

Playback S/N 85 dB
Playback Dynamic Range 85 dB
Playback Total Harmonic Distortion 0.05%
Output Voltage/Impedance (Line Output) 1.0 V/2K

MIC/LINE analog input

LINE level
S/N 80 dB
THD 0.05%
Input Sensitivity/Impedance 500 mV/2K
MIC level
S/N 60 dB
THD 0.2%
Input Sensitivity/Impedance 1.2 mV/2K
Phantom Power DC +48V

AUX analog input

S/N 85 dB
THD 0.05%
Input Sensitivity/Impedance 800 mV/23K

Digital Input

Sample rate 11 kHz ~ 58 kHz

Digital Output

Output Level/Impedance 0.5 Vp-p/75 ohm

Headphone Output (10% THD)

Level/Impedance 70 mW/32 ohm

Speaker Output (10% THD)

Level/Impedance 1.7 W/8 ohm

WARNINGS

Do not expose the equipment to rain or moisture.

Do not remove the cover from the equipment.

Do not insert anything into the equipment through the ventilation holes.

Do not cover the ventilation with any items such as tablecloths, newspapers, curtains, etc.

No open flame sources, such as lighted candles, should be placed on the equipment.

When disposing of used batteries, please comply with governmental regulations or environmental public instruction's rules that apply in your country or area.

CE marking (only EU version)

 This product is in conformity with the EMC directive and low-voltage directive.

Equipment mains working system

This product complies with household power and safety requirements in your area.

Table of Contents

Topic	page
Warnings	2
Safety Instructions	3
Specifications	4
Table of Contents	5
Introduction	5
Package contents	7
Remote batteries	7
Connections (basic)	7
Controls, Display (top)	
1 Speaker grill	8
2 Built in microphone	8
3 Tone controls	8
4 Control buttons	
1 TEXT button	8
2 PHANTOM button	8
3 PROG button	8
4 REPEAT button	8
5 MENU/STORE button	9
REC menu table	9
6 DISP button	9
7 REC MODE button	9
Recording modes	9
8 SINGLE button	10
9 A-B button	10
10 CANCEL/DELETE button	10
5 Standby POWER switch	11
6 STANDBY light	11
7 Display	11
1 TOC	11
2 Record Indicator	11
3 Pause Indicator	11
4 Play Indicator	11
5 PROG Indicator	11
6 REPEAT Indicator	11
7 DIGITAL Indicator	11
8 Level meter	11
9 CD Indicator	11
10 TEXT Indicator	11
11 A-B Indicator	11
12 TOTAL TRACK Indicator	11
13 AUTO Indicator	12
14 SYNC Indicator	12
14 Alphanumeric display	12
8 SELECT control	12
9 REC/PLAY controls	12
1 ERASE button light	12
2 FINALIZE button light	12
3 Fast backward search button	12
4 Fast forward search button	12
5 REC button light	12
6 Play/Pause button	12
7 Stop button	12

Topic	page
Controls, Connections (front)	
1 PHONE/SPEAKER LEVEL control	13
2 PHONE SELECTOR	13
3 MIC/LINE controls and input jacks	13
1 Left XLR or 1/4" input jack	13
2 Right XLR or 1/4" input jack	13
3 LINE MIC INT switch	13
4 Left level control	13
5 L/R L+R switch	13
6 Right level control	13
4 INPUT ANALOG/DIGITAL switch	14
5 REC LEVEL switch	14
6 MIC/LINE ATT switch	14
7 SPEAKER OFF/ON switch	14
8 OPEN/CLOSE switch	14
9 PHONES jack	14
10 LINE OUT level control	14
11 CDR drive (disc tray)	14
12 Remote control sensor	14
Controls, Connections (rear)	
1 MIX OUT jacks	15
2 LINE OUT jacks	15
3 AUX IN jacks	15
4 DIGITAL IN and OUT jacks	15
5 REMOTE RC-5 IN and OUT jacks	15
6 REMOTE EXT. INT. switch	15
7 FOOT PEDAL jack	15
8 Power plug	15
9 DC IN	16
10 Power switch	16
BATTERY SELECT	16
How to use a DC battery supply	16
Battery Backup	16
How to Play	
How to Play a CD (basics)	17
How to Pause	17
How to Stop	17
How to display time	18
How to select tracks	18
How to Search	18
How to play a Single Track	18
How to program tracks	19
How to erase a programmed track	20
How to clear a program	20
How to Record	
How to record your voice or instrument (basics)	21
SCMS	22

(table of contents continues)

Table of Contents continued

Topic	page
How to copy an existing CD (basics)	22
Select record mode	23
RECORD	23
MINUTE TRACK	23
SYNC RECORD	23
SYNC REC+FINAL	23
Recording tips	23
Record Adjustments	
AUTO TRACK and AUTO STOP defaults ...	23
AUTO TRACK	24
How to turn AUTO TRACK ON or OFF	24
AUTO STOP	24
How to turn AUTO STOP ON or OFF	24
REC LEVEL adjustment	24
How to adjust the MIC EQUALIZER	25
How to adjust REC BALANCE	25
How to select filters	26
How to erase	27
How to erase the last track	27
How to erase the entire disc	27
How to finalize	28
How to Finalize a CD-R or CD-RW disc	28
How to Unfinalize a CD-RW disc	28
About the Remote	29
Track Skip forward button	29
Track Skip backward button	29
AMS button (Automatic Search)	30
TR INC (Track Increment)	30
About CD discs	31
Which discs to use	31
Disc cleaning	31
CD text	32
CD text during playback	32
Recording CD text	32
TEXT EDIT	32
How to view CD text	33
How to erase CD text	34
RC-5 remote control codes	34
Troubleshooting	35
Maintenance	35
Warranty	36

Introduction

The CDR300 CD recording system is a CD recorder with playback capability.

For CD recording you can:

- record on CD-R or CD-RW discs
- record from digital or analog sources

For CD playing you can:

- add (mix in) your own microphone or instrument input
- connect to an amplifier/speaker system
- connect to an external CD recorder
- connect an additional CD player (or other line input) to the CDR300 and mix that input

Package contents

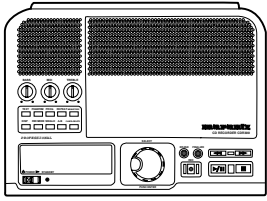

CDR300 unit

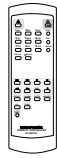

Infrared remote control

Power cord

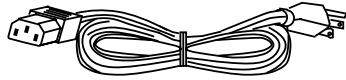

Audio cables (2)



AA batteries (2)

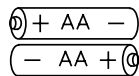

Remote batteries

Press and lift at arrow to open the remote control battery compartment.

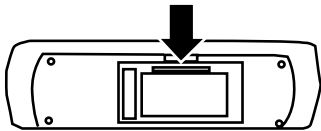

Install two AA batteries.

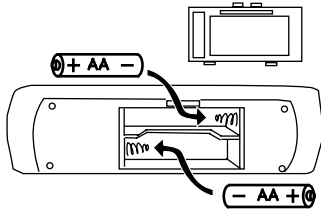

Replace compartment cover.

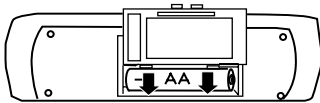

Connections (basic)

Install on a table or other flat, stable, surface.

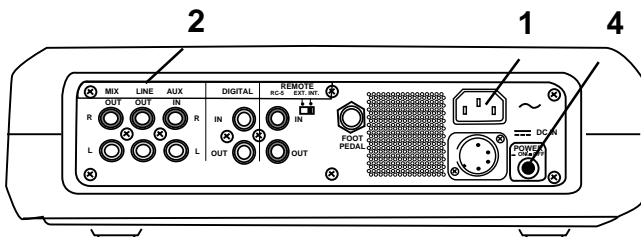

1 Plug in to
AC power

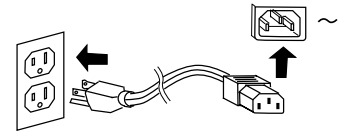

2 Connect your amplifier and speaker system
(optional)

Connect the supplied Right and Left RCA audio



cable to LINE OUT and then connect to the input of an amplifier, receiver or other external unit, typically CD input.

3 Speaker: switch the internal speaker OFF and turn your amplifier on. If an external amplifier system is unavailable switch the internal speaker ON.

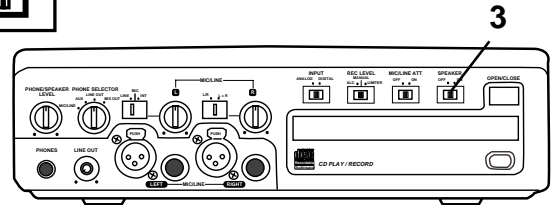
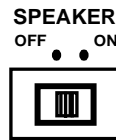

4 POWER Push the POWER OFF/ON button so it is ON (in position).

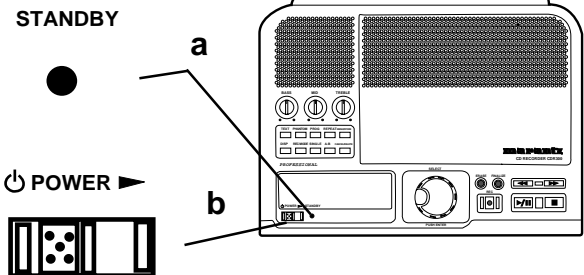

The STANDBY light **a** will be lit.
Slide the POWER switch **b** to the right.
The STANDBY light will go out.

READING will flash on the display.

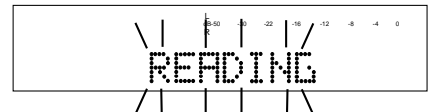

Then the display will read NO DISC.

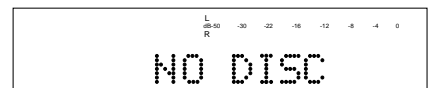

Controls, Display (top)

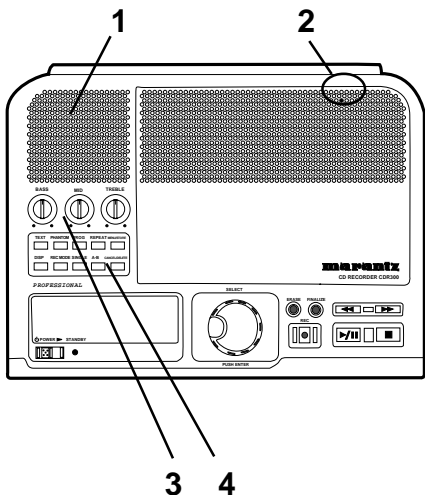

1 Speaker grill

The built in full range speaker allows listening to a CD without having to connect to other equipment for amplification.

2 Built in microphone

The built in microphone (internal mic) is near the top right corner.

3

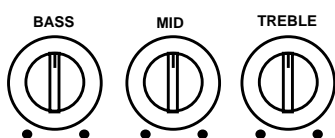

Tone controls

Turning a knob controls the level of the corresponding frequency

range of the CD being played. Level adjustments apply to the internal speaker and LINE OUT output. Turn clockwise to boost the frequency and counter-clockwise to attenuate it. Level adjustments do not apply to MIX OUT.

TREBLE High frequencies (6 kHz)
MID Middle frequencies (2 kHz)
BASS Low frequencies (150 Hz)

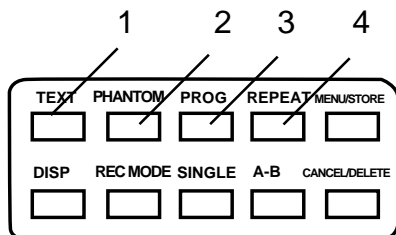

4 Control buttons

1 TEXT button

Activates scrolling text in the display. When a CD with text is first read the text is automatically displayed and scrolls across.

2 PHANTOM button

PHANTOM provides a power supply for condenser microphone(s) plugged into the XLR MIC/LINE jack(s). Phantom power is only available when the MIC/LINE/INT switch is set to MIC. Push and release to toggle PHANTOM microphone power on or off. When PHANTOM is on PH is added to the time display.

Example display.

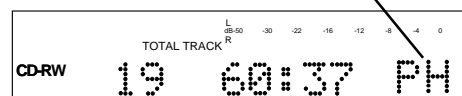

3 PROG button (program)

Push and release to enter programming mode. Programming lets you select tracks for playback. Up to 30 tracks can be selected in any order you desire. See **How to program tracks** for a full discussion of this feature.

4 REPEAT button

There are two repeat modes, Track and Entire CD.
Track: While playing a CD, push and release REPEAT to repeat the track being played.

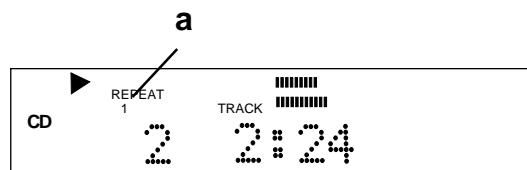

a REPEAT 1 is lit and steady in the display.

Entire CD: push and release a second time to repeat the entire CD.

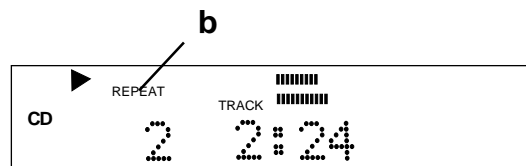

b REPEAT is lit and steady in the display.

Push and release a third time to exit REPEAT.

Controls, Display (top) continued

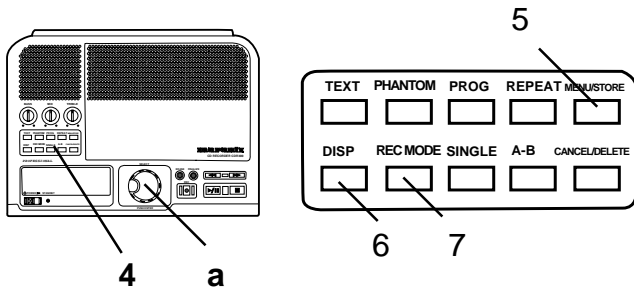

5 MENU/STORE button

Push and release to enter Menu mode.

Menu selections and changes are made using the SELECT control (a). Turn the SELECT control to scroll through the options. Push and release the SELECT control to select the option. Push and release the MENU/STORE button to store changes and exit Menu mode.

Menu selections are available depending on if the CD is stopped or in Play/Pause, or if REC is selected. The table below shows which menu selection is available under which conditions. The table also lists which page of this manual contains instructions for that menu item.

Menu Item	Stop	Play/ Pause	REC/ REC Pause	Page
AUTO TRACK			X	24
AUTO STOP			X	24
REC BALANCE			X	25
TEXT EDIT	X			32
TEXT ERASE	X			34
TEXT VIEW	X			33
MIC EQUALIZER	X	X	X	25
FILTER SELECT	X	X	X	26
BATTERY SELECT	X			16

Notes:

1. AUTO TRACK, AUTO STOP, REC BALANCE only operate in REC MODE.
2. TEXT EDIT, TEXT ERASE and TEXT VIEW only apply to unfinalized discs.

6 DISP button (display)

While playing a CD push and release once to display the remaining play time for the track.

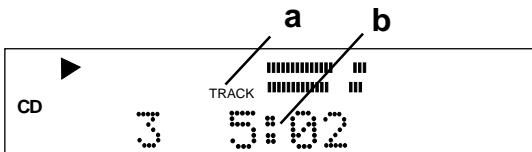

- a Only TRACK is lit and steady.
- b The countdown time is for the track being played.

Push DISP and release a second time and the remaining play time for the entire CD is displayed.

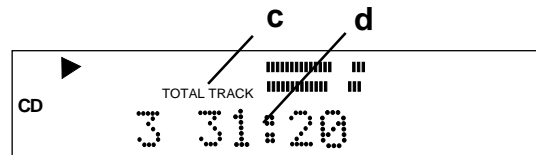

- c TOTAL TRACK is lit and steady.
- d The countdown time is for the entire CD.

Push DISP and release again to return to the default display showing elapsed track time.

7 REC MODE button

With a CD-R or CD-RW disc in the CDR drive, push and release to enter recording mode. Turn the SELECT control to select the recording mode. Then push and release the SELECT control to choose that mode.

Recording modes

RECORD

This is the first REC mode that appears in the REC mode menu. You can record using the INT mic, MIC/LINE inputs and/or AUX inputs or DIGITAL input.

MINUTE TRACK

Same as RECORD but automatically records a track every minute. During playback the tracks every minute help you locate a specific passage.

SYNC RECORD

Use this REC mode to automatically start the recording process from an outside digital or analog source including DAT, minidisk, cassette tape or LP for example.

SYNC REC+FINAL

Use this REC mode to automatically start the recording process from an outside digital or analog source including DAT, minidisk, cassette tape or LP for example. When copying a CD the entire CD is copied and automatically finalized.

Controls, Display (top) continued

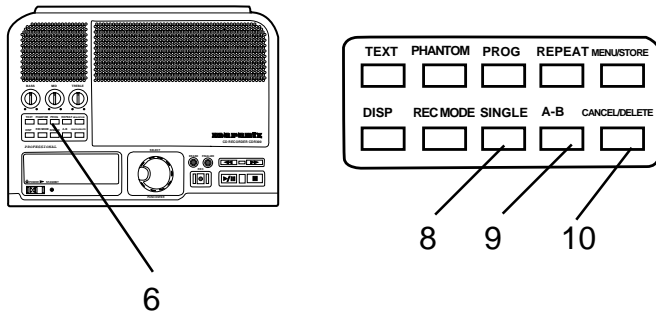

6 Control buttons continued

8 SINGLE button

Push and release to toggle Single Track Play on or off.

From Stop push SINGLE so TRACK is flashing in the display. Turn the SELECT control to select the track then push Play/Pause twice to cue and pause the track.

During Single Track Play turn the SELECT control to stop the current track and cue to the selected track. The track does not automatically start playing but is paused and cued up at the beginning of the track (example display follows), and the Play/Pause button flashes.



While playing in Single Track Play the Play (a) and TRACK (b) displays are flashing, and the time counter (c) is counting up indicating elapsed time (example display below).

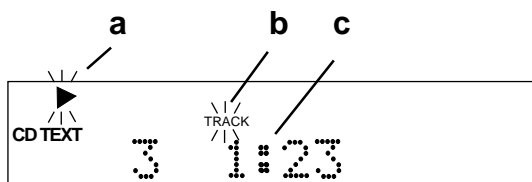

When the track is finished the CDR300 will automatically pause at the beginning of the next track.



9 A-B button

While a CD is playing push and release to start point A to point B repeat play.

Point A (starting point) is set when the A-B button is pushed and released. The next push and release of the A-B button sets point B (ending point). Play repeats between A and B. Example display:

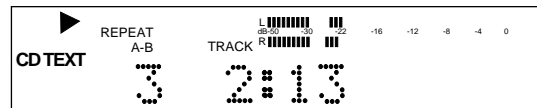

During A-B repeat push and release the A-B button. This point becomes the new A point and the next push and release of the A-B button sets a new B point.

To exit A-B repeat press the REPEAT button, play continues, or the Stop button, play ends.

10 CANCEL/DELETE button

Push and release to delete tracks from a program, to delete text when entering CD text, or return to a higher level in the Menu.

Controls, Display (top) continued

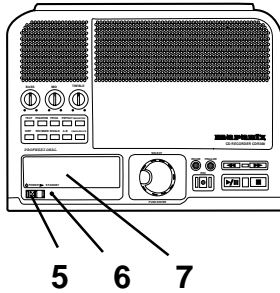

POWER ►



light must be lit).

5 Standby POWER switch

Slide the Standby POWER switch to the right to turn power on or off. POWER button on rear of unit must be ON (the red STANDBY

STANDBY



6 STANDBY light

STANDBY light (red) is lit when power is switched off by the Standby POWER switch on the unit or remote.

7 Display

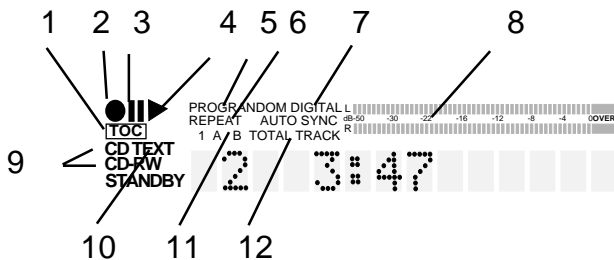

TOC

1 TOC

Lit when TOC (disc table of contents) information is held in memory. The table of contents includes the total number of tracks, playback time and other CD text if provided. Flashes during recording.



2 Record indicator

Lit when recording.



3 Pause indicator

Lit when recording or playback has been paused.



4 Play indicator

Lit during recording or playback.

PROG

5 PROG indicator

Lit during programming mode (selecting track playback sequence).

REPEAT

6 REPEAT indicator

Lit during a repeat operation.

REPEAT

1

When the 1 indicator is also lit only the currently playing track is repeated.

DIGITAL

7 DIGITAL indicator

Lit during digital recording. Not lit during playback.



8 Level meter

Displays the level of the Left and Right channels of audio from the music source. During CD playback this is the audio level of the CDR drive. During recording this is the audio level of all music sources feeding the CDR drive.

CD

9 CD indicator

CD-R

CD-RW

Displays CD, CD-R, or CD-RW telling you the type of disc that is in the CDR drive.

TEXT

10 TEXT indicator

TEXT is displayed when the CD being played includes CD TEXT information. Or when TEXT mode is selected to enter CD TEXT information onto a CD you are recording.

A-B

11 A-B indicator

A- is lit after pushing the A-B button once indicating that the beginning of audio segment to be repeated has been selected. REPEAT is also lit. A-B is lit after pushing the A-B button a second time. The audio segment from A to B is repeated indefinitely.

TOTAL TRACK

12 TOTAL TRACK indicator

TOTAL TRACK is lit when the display information (time to end) applies to the whole CD rather than the track being played.

TRACK is lit when the display information (time to end) applies to the track being played rather than the whole CD.

Controls, Display (top) continued

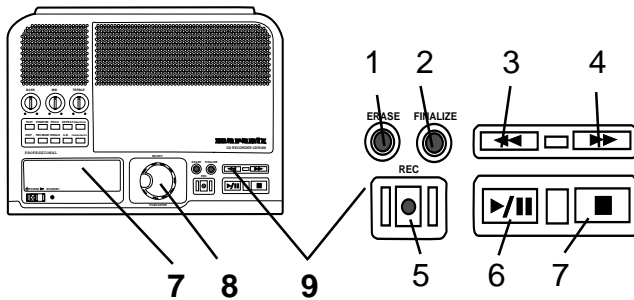

7 Display continued

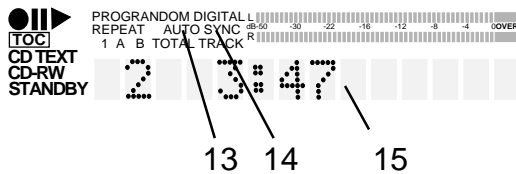

AUTO 13 **AUTO indicator**
Lit when tracks are automatically being determined (by digital subcode or audio sensing).

SYNC 14 **SYNC indicator**
Lit when a SYNC RECORD mode is on.

15 Alphanumeric display
Information, instructions and error messages can be displayed. The example shown indicates track 2 is being played and the time is three minutes and forty seven seconds.

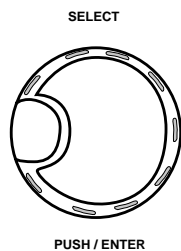

8 SELECT control
This is the "master" control for the CDR300. For most operations you turn to select, then push and release to confirm and enter your selection.

- In PROG mode turn to select track, then push and release to program the track.
- In Play mode turn to select the track.
- When recording, selects recording level.
- In MENU mode turn to scroll through menu selections.

9 REC/PLAY controls

ERASE 1 **ERASE button light**
Push and release to enter ERASE mode. See **How to erase**.

FINALIZE 2 **FINALIZE button light**
Push and release to enter FINALIZE mode. See **How to finalize**.

3 Fast backward search button

Push and hold during playback to search backward. While searching samples of audio are played to help you find the point you are searching for. Returns to playing forward when the button is released.

4 Fast forward search button

Push and hold during playback to search forward. While searching samples of audio are played to help you find the point you are searching for. Returns to playing forward when the button is released.

REC 5 **REC (record) button light**
When flashing and prompted by the display to PUSH REC KEY, push and release to start recording. See **How to Record** for recording modes. Also used when finalizing.

6 Play/Pause button

Push and release to start play of a stopped or paused disc. Push and release during play to pause. Button lit during play, flashing during pause.

Example display during pause. **paused symbol**

The display shows a paused symbol (two vertical bars) in the first segment, the track number '2' in the second segment, and the time '4:03' in the third segment. The text 'CD TEXT' is on the left and 'TRACK' is above the time.

7 Stop button

Push and release to stop play of a playing or paused disc. When a disc is not playing or paused, push and release to clear a program. Button lit when stopped.

Controls, Connections (front)

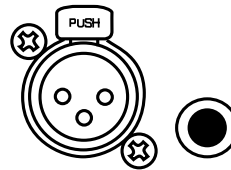
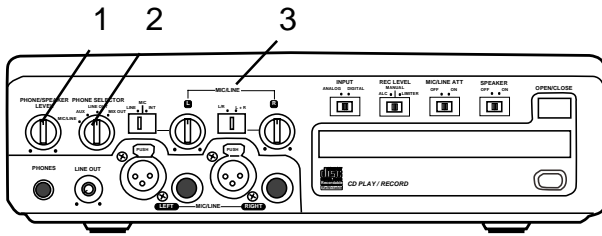

1 Left XLR or 1/4" input jack
Plug in an instrument or other line level audio device here to provide audio to the left stereo channel.

Note: To avoid feedback, turn the internal SPEAKER OFF/ON switch OFF or reduce the PHONE/SPEAKER LEVEL control, and reduce the LINE OUT level control if connected to an external amplifier.

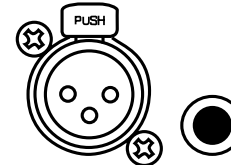

2 Right XLR or 1/4" input jack
Plug in an instrument or other line level audio device here to provide audio to the right stereo channel.

PHONE/SPEAKER LEVEL

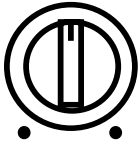

1 PHONE/SPEAKER LEVEL control

Turn to adjust the level (volume) of the built-in speaker and headphones plugged into the PHONE jack. (To listen to headphones only turn the SPEAKER OFF/ON switch to OFF.)

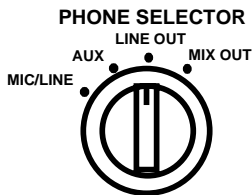

2 PHONE SELECTOR

Turn to select the audio input to the PHONE jack and internal Speaker.
MIC/LINE – Audio being input via the MIC/LINE input jacks.
AUX – Audio being input via the AUX IN jack.

LINE OUT – Audio available at the LINE OUT output jacks.

MIX OUT – Audio available at the MIX OUT output jacks.

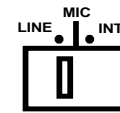

3 LINE MIC INT switch

Switch to LINE for a line level input, to MIC for a microphone level input, or to INT for input from the internal microphone.

Note: To mix two microphones from the front inputs with a stereo line input, use the AUX input on the rear for the stereo line input.

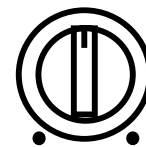

4 Left level control

Turn to adjust the level of the left input.

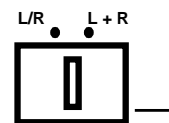

5 L/R L+R switch

L/R records the Left input onto the left channel of the recording and the Right input onto the right channel of the recording.

L+R records Left and Right inputs onto both channels of the recording.

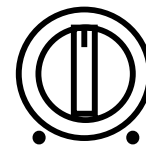

6 Right level control

Turn to adjust the level of the right input.

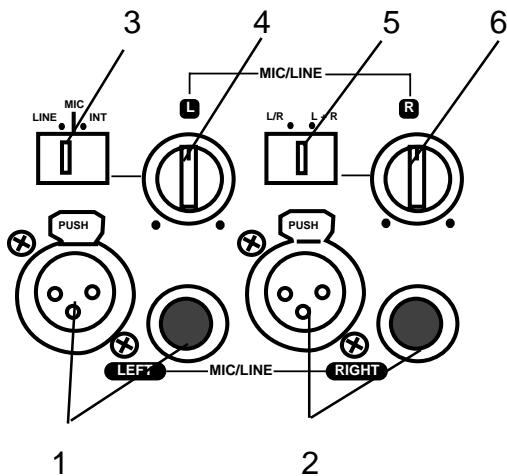

Left and right microphones or instruments via phone jacks or via XLR connectors are input here.

Note: When internal mic is selected both the Left level control and the Right level control are active. To record the internal microphone to both the left and right channels adjust both Left and Right level controls.

Controls, Connections (front) continued

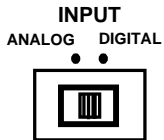
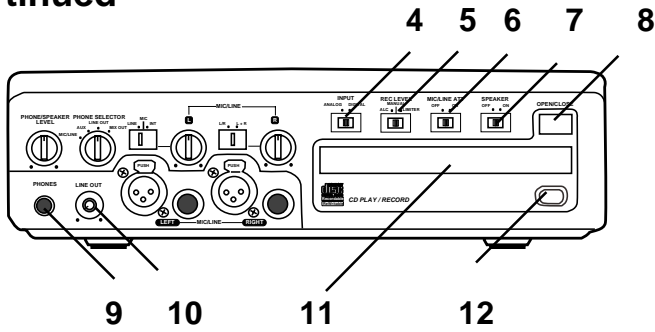

4 INPUT ANALOG/DIGITAL switch

Select between analog or digital external input. Connect digital output of the source machine to

the DIGITAL IN jack on the rear of CDR300. Connect analog input to either the MIC/LINE input jacks on the front of the CDR300 and/or the AUX IN jacks on the rear of the CDR300.

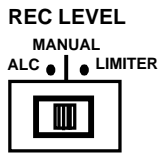

5 REC LEVEL switch

Record level limiter for analog input during recording.
ALC – Limits any input signal greater than -12 dB. Left and right MIC/LINE (or INT MIC) level

controls should be set to maximum.

MANUAL – Set level using left and right MIC/LINE (or INT MIC) level controls. When recording via AUX IN control the level using the output level control on the external device. Levels in excess of 0 dB will be recorded and will result in distorted recordings.

LIMITER – Same as manual: Set level using left and right MIC/LINE (or INT MIC) level controls. Levels in excess of -12 dB are automatically limited.

Note: REC LEVEL adjustment is not available with this switch at ALC.



6 MIC/LINE ATT switch

Determines if the signal from the MIC/LINE inputs is attenuated.
OFF – the signal(s) is not attenuated.

ON – The signal is attenuated approximately 20 dB to prevent distortion.

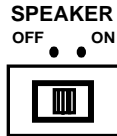

7 SPEAKER OFF/ON switch

Turns the built-in speaker OFF or ON.

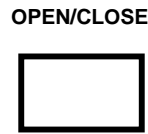

8 OPEN/CLOSE switch

Push and release to OPEN the CDR drive.

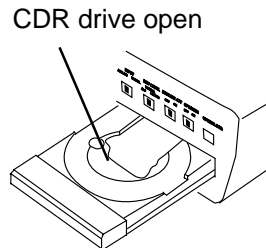

To CLOSE the CDR drive, push and release the OPEN/CLOSE switch.

9 PHONES



9 PHONES jack

Plug stereo headphones in here. Adjust headphone volume with the PHONES/SPEAKER LEVEL control.

10 LINE OUT



10 LINE OUT level control

Turn to adjust the level of the output to the LINE OUT jacks.

11 CDR drive (disc tray)

The CDR drive is used for recording and can record CD-R and CD-RW discs. The CDR drive can also playback CD, CD-R and CD-RW disks



12 Remote control sensor

Sensor for the supplied wireless remote control.

Note: Set the REMOTE EXT. INT. switch on the back to INT. to enable the wireless remote control.

Controls, Connections (rear)

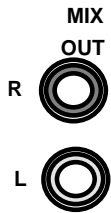
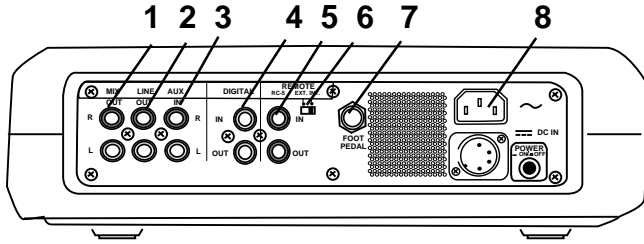

1 MIX OUT jacks
 Plug Right and Left RCA audio cables in here to connect to the input of an amplifier or other external unit. Use for recording onto an external recorder. Input from MIC/LINE (or INT MIC) and/or AUX jacks are output as

line level output to an external recorder or amplifier. The signal is output before going to the CDR drive, so it is available for monitoring or recording even if the CDR drive is stopped. This signal cannot be equalized by the CDR300 tone controls.

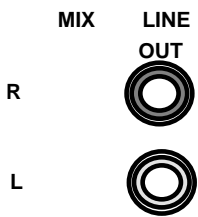

2 LINE OUT jacks
 Plug Right and Left RCA audio cables in here to connect to the input of an amplifier or other external unit. This signal can be equalized by the CDR300 tone controls.



3 AUX IN jacks
 Plug Right and Left RCA audio cables in here to connect to the output of an external unit. Use for recording onto the CDR drive from an external audio source such as a cassette deck, or CD player.



4 DIGITAL IN and OUT jacks
 Plug RCA coaxial cables in here to connect to the input and/or output of an external digital unit. Use IN for recording onto the CDR drive from an external digital audio source. Use OUT for going to an external digital device.

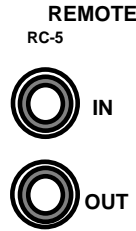

5 REMOTE RC-5 IN and OUT jacks
 Plug RCA audio cables in here to connect to the input and output of an RC-5 remote control system. The RC-5 control code list is on page 34.

Notes:

- For more information on the RC-5 system and details regarding its operation please contact Superscope Technologies at (630) 820-4800 or www.superscope-marantzpro.com.
- When an RC-5 remote control system is not used the REMOTE EXT. INT. switch should be at INT.

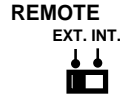

6 REMOTE EXT. INT. switch
 Switch to EXT. (external) when an external RC-5 remote control system is used.

Notes:

- Switch to INT. (internal) to enable the supplied IR (infrared) remote.



7 FOOT PEDAL jack
 An optional foot pedal can provide Play/Pause control for the CDR drive. This jack does not perform pause or continue during recording. Foot pedal (FT200) is available from Superscope Technologies at (630) 820-4800 or www.superscope-marantzpro.com.



8 Power plug
 Plug one end of the supplied power cord in here and the other into an AC outlet.

Controls, Connections (rear) continued

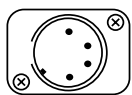
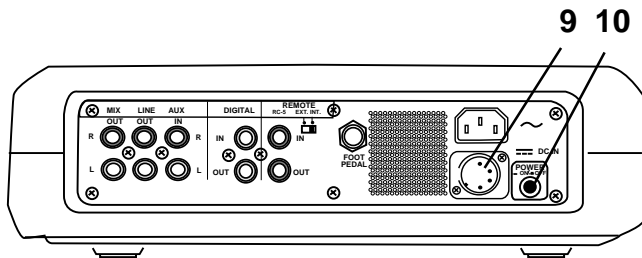

--- DC IN

9 DC IN

The CDR300 can be powered by a Lead Acid, NiCd, or NiMH battery power supply. A Lead Acid power supply is available

from Superscope Technologies (630) 820-4800 or www.superscope-marantzpro.com.

DC IN pin out

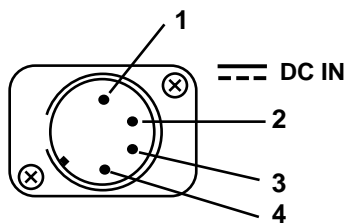

--- DC IN

- | | |
|---|----------|
| 1 | 12VDC - |
| 2 | not used |
| 3 | not used |
| 4 | 12VDC + |



10 Power switch

Push and release to turn power ON (in position). Push and release to turn power OFF (out position).

Normally, to retain memory, leave this switch at ON and turn power on and off with the Standby POWER slide switch on the top of the unit.

BATTERY SELECT

A DC power supply with Lead Acid, NiCd, or NiMH batteries can be used, but batteries differ in electrical characteristics.

Determine which battery type is used. With the CDR300 at Stop push and release the MENU/STORE button. Turn the SELECT control so BATTERY SELECT is displayed.

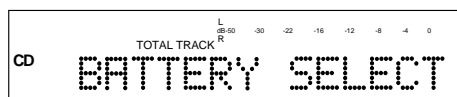

Push and release the SELECT control.

Turn the SELECT control to choose between Lead Acid and NiCd/NiMH.

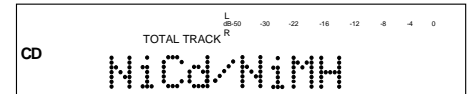
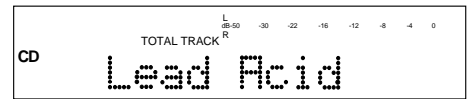

When correct push and release MENU/STORE.

How to use a DC power supply

Always begin recording sessions with a fully charged battery regardless of battery type.

Plug the DC power supply into DC IN (9). Push the Power switch (10) in to ON. Turn power on with the Standby POWER slide switch on the top of the unit.

Battery life depends on use and battery type. A low battery indicator is built in. When the CDR300 detects a low battery condition during recording the red STANDBY light flashes and the display alternates between PRESS STOP and LOW BATTERY.



Stop recording as soon as possible. When you stop recording the temporary TOC will automatically be updated so your recording is not lost.

After two minutes of LOW BATTERY the CDR300 will stop recording and will automatically update the temporary TOC.

Battery Backup

When both AC and DC power supplies are connected the DC supply serves as a battery backup when AC power is interrupted.

How to Play

How to Play a CD (basics)

1 Connect and turn on the CDR300, see Connections (basic) on page 7.

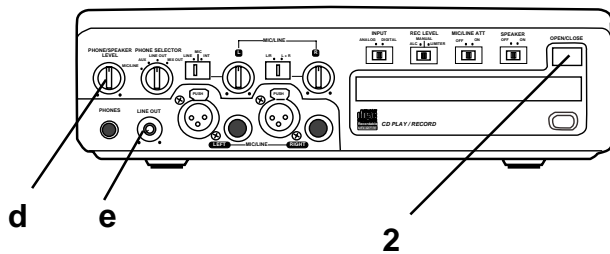
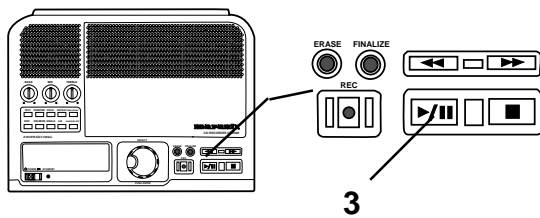

2 Push and release the OPEN/CLOSE switch to open the CDR drive. "OPEN" is displayed.

Insert your CD and push OPEN/CLOSE to close the CDR drive. "CLOSE" is displayed.

Then READING will flash on the display.

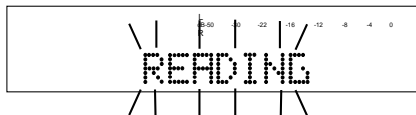

If CD text is available the CD title/artist will scroll across the display.

Then the display will show disc information (example shown).

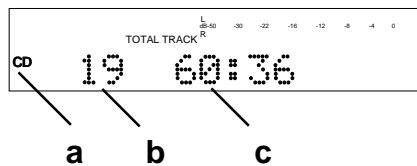

a The type of disc (CD, CD TEXT, CD-R or CD-RW) is shown.

b The number of tracks on the disc.

c The total playing time of the disc.

3 Play Push the Play/Pause button to begin play. The CD will play to the end and stop.



Adjust internal speaker or headphone volume with the PHONE/SPEAKER level control **d**.

Adjust the LINE OUT level with the control **e** and your amplifier's volume controls if using an external amplifier.

How to play

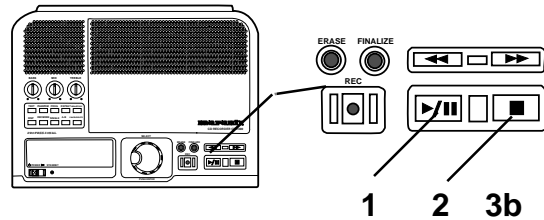

How to Pause



Push and release the Play/Pause button (1) to Pause. When paused, push and release to continue play from the same point.

How to Stop



Push and release the Stop button (2) to Stop. When Play/Pause is next pushed, play starts from the beginning of the disc.

How to play continued

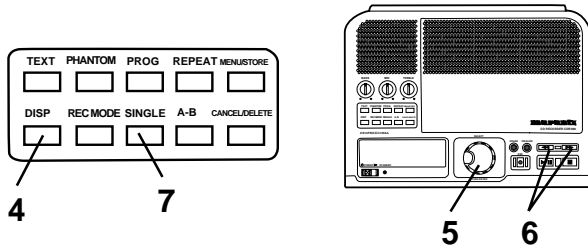

How to display time

There are three modes of time display:

- A Elapsed track time
- B Remaining track time
- C Total remaining disc time

A Elapsed track time

The default time display shows the elapsed time on the track being played.

Example display.

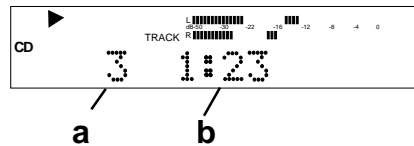

In this example track 3 (a) has been playing for 1 minute and 23 seconds (b).

B Remaining track time

Push and release DISP (4) once. The display shows the time remaining on the track counting down.

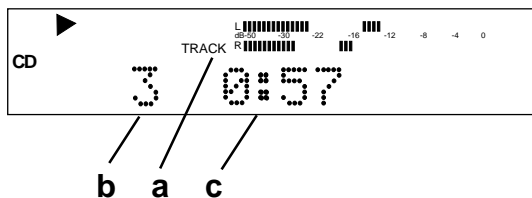

The example display indicates that track time is displayed (a) track 3 is playing (b) and has 0 minutes and 57 seconds of remaining play time (c).

C Total remaining disc time

Push and release DISP (4) another time. The display shows the total time remaining on the disc counting down.

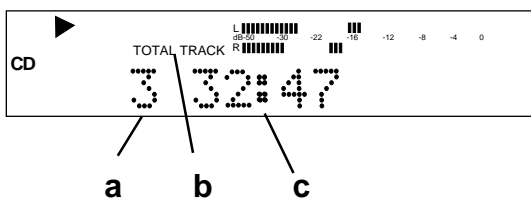

The example display indicates that track 3 (a) is playing, and total track (total disc) (b) has 32 minutes and 47 seconds to play (c).

Push and release DISP (4) a third time. The display returns to the default, track time counting up.

How to select tracks

You can select tracks during Stop, Play or Pause.

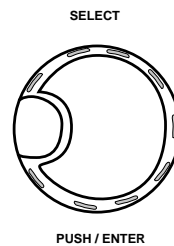

Turn the SELECT control (5) to choose the track. During play wait about a second or push and release the SELECT control to switch to the beginning of that track. During Stop or Pause push Play/Pause to begin playing the selected track.

How to Search



While playing push and hold a Fast backward search or Fast forward search button (6).

Samples of audio are played while searching backward or forward. After a couple of seconds of holding the search speeds up.

For more accurate positioning on the CDR drive push and release the Fast backward or Fast forward search button during Pause. Each push and release is approximately one half second of audio.

How to play a Single Track

While stopped push and release the SINGLE button (7).

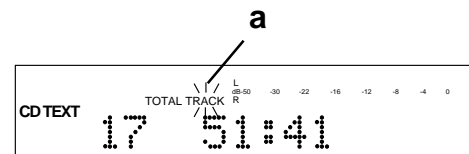

Example display shows TRACK flashing (a).

Turn the SELECT control to choose the track you wish to play.

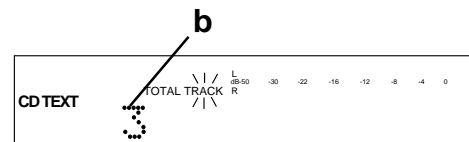

Example display shows TRACK 3 selected (b).

Push and release Play/Pause.

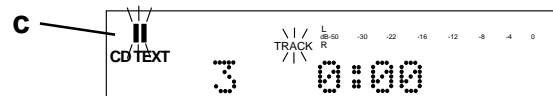

The selected track will be cued to music and paused. Paused symbol flashing (c).

How to play continued

Push and release Play/Pause.

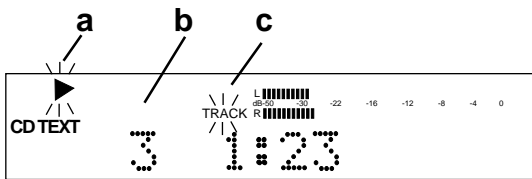

Example display:

- a Play symbol flashing indicates track is playing.
- b Example track #3 is playing
- c Flashing "TRACK" indicates single track play.

When the track is completed the CDR300 remains in Single track, paused at the beginning of the next track.

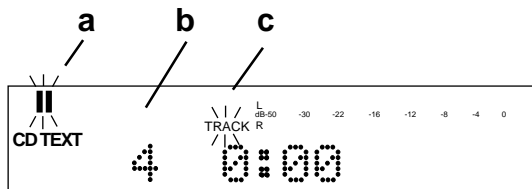

Example display:

- a Paused symbol flashing indicates track is paused.
- b Example track #4 is cued.
- c Flashing "TRACK" indicates single track play.

Push and release the Play/Pause button to play the track or push SINGLE to exit Single Track.

How to Program Tracks

Programming lets you select tracks for playback on finalized discs. Up to 30 tracks can be selected in any order you desire.

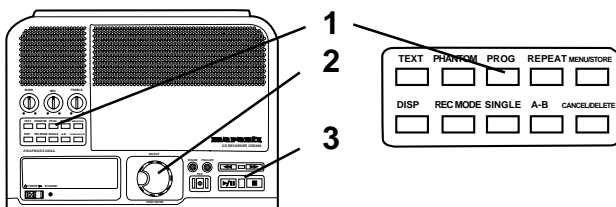

- 1 With a CD in the CDR drive and with playback stopped, push and release the PROG button to enter programming. The following display appears.

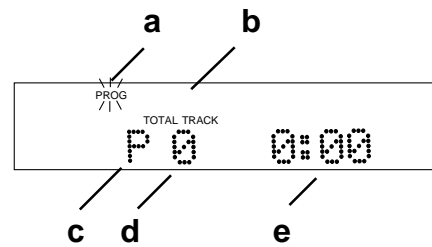

- a PROG is lit and flashing.
- b TOTAL TRACK is lit.
- c P indicates "Programmed tracks".
- d The number of tracks programmed is displayed.
- e The total playing time programmed is displayed.

- 2 Turn the SELECT control to display the track desired.

Example display shows track 3 selected.



Push and release the SELECT control to enter the selected track.

The display changes to:

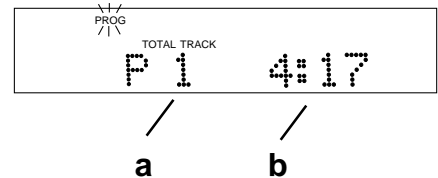

- a 1 track is programmed. (In the example track 3 is the first track to be programmed.)
- b The total playing time programmed in the example is 4 minutes and 17 seconds.

Repeat step 2 to program tracks in the order you desire. Up to 30 tracks can be programmed. When you try to program a 31st track, this display appears:



If the total time programmed exceeds 99 minutes and 59 seconds the display changes to:

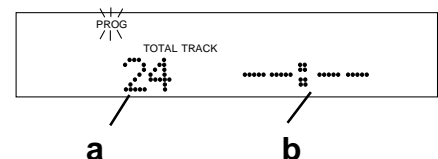

- a Number of tracks programmed (example).
- b Total time given as dashes.

How to play continued

- 3** Push Play/Pause (a) to play the program.

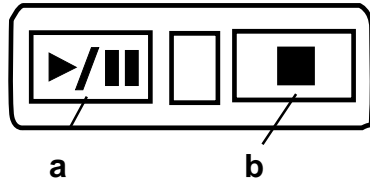

Example display shown.

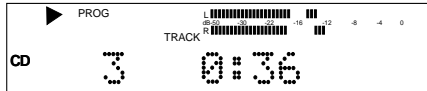

Pause, Stop: While playing the program:

- a** Push Play/Pause to pause, push again to resume play from that point in the program.
- b** Push Stop to stop. Push Play/Pause to resume play from the beginning of the program.

After programming tracks Single Track play can be selected. See How to play a Single Track.

How to erase a programmed track

- 1** In Stop mode push and release PROG to enter Program mode.
- 2** Push and release CANCEL/DELETE to erase the track. You can only erase the last track of the program. If you wish to erase a track in the middle of your program, then you must also erase any tracks that were programmed after it.

How to clear a program

Push Stop **b** twice to clear the program and exit program mode.

How to Record

How to record your voice or instrument (basics)

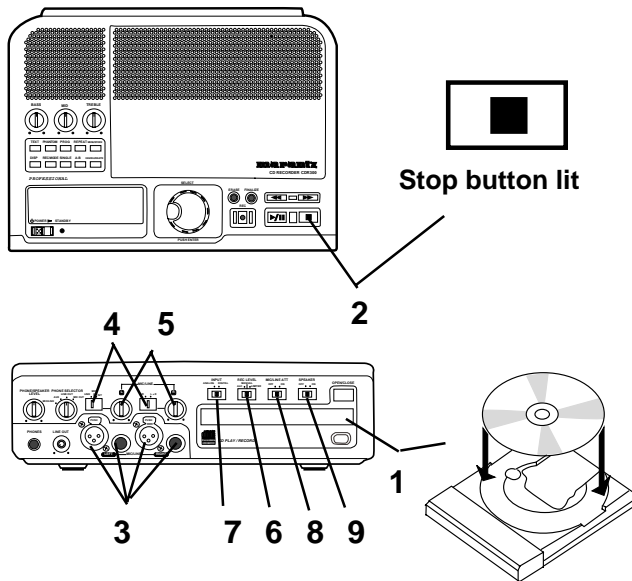

- 1 Insert a blank disc, or a recordable disc with space for additional recording in the CDR drive.
- 2 With the CDR drive at Stop.
- 3 Connect your microphone(s) or instrument(s) to the MIC/LINE jacks on the front of the CDR300.
- 4 Set the LINE MIC switches for microphone input (MIC) or for instrument input (LINE).
- 5 Turn the L and R level controls all the way up (clockwise).
- 6 We suggest switching the REC LEVEL control to ALC.
- 7 Set the INPUT switch to ANALOG.
- 8 Set the L/R L+R switch to L/R so the left input is recorded on the left channel and the right input on the right channel.

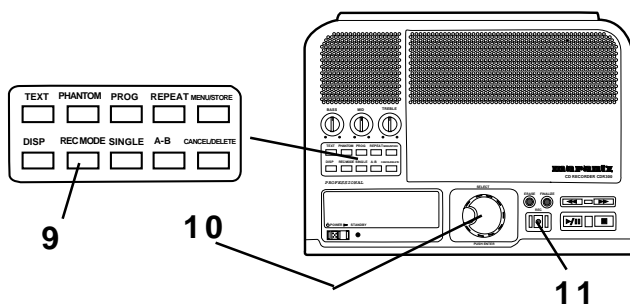

- 9 Push and release REC MODE.

- 10 Turn the SELECT control so RECORD is displayed.

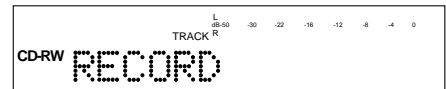

Then push and release the SELECT control to accept the RECORD recording mode.

The display changes to:

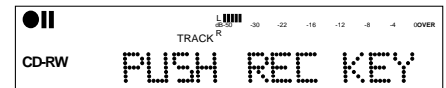

The REC button (11) is lit and flashing.

- 11 Push and release REC to begin recording.

Example display while recording.

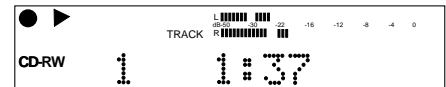

Push and release Stop or Play/Pause to stop recording and to set the end of your recording track and the beginning of the next track.

To play your new recording on other CD players your disc must first be finalized. See **How to finalize**.

How to Record

SCMS (Serial Copy Management System)

The SCMS copy management system is designed to prevent consumer recorders from making unlimited digital copies of a digital source. Most consumer CD recorders will not make a digital copy when SCMS is present in the digital source, while a professional CD recorder (CDR300) will act differently.

If the digital source being recorded on the CDR300 contains no SCMS information then the copy will also not include SCMS. If the digital source material being recorded on the CDR300 contains SCMS information then the copy will also include SCMS.

The SCMS copy management system does not apply to analog source material.

How to copy an existing CD (basics)

OBSERVE REGULATIONS REGARDING COPYRIGHT INFRINGEMENT.

1 Insert the CD to be copied into a CD player connected to the DIGITAL IN jack. Set the INPUT switch to DIGITAL.

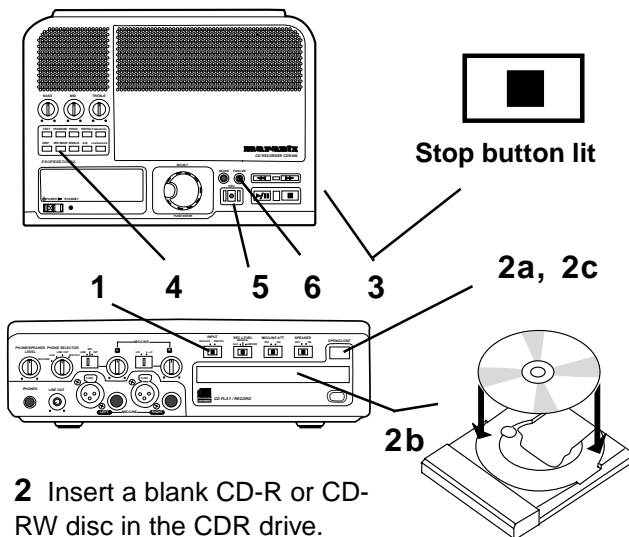

2 Insert a blank CD-R or CD-RW disc in the CDR drive.

a Push OPEN/CLOSE to open the disc tray.

b Add the blank disc.

c Push OPEN/CLOSE to close.

3 After reading the disc BLANK DISC is displayed.

Example display.

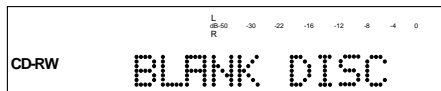

4 Push and release REC MODE. Turn the SELECT control so SYNC RECORD is displayed.

Example display.

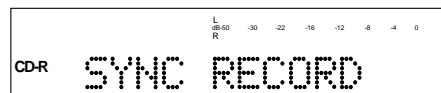

Push and release the SELECT control to accept the SYNC RECORD recording mode choice.

Example display.

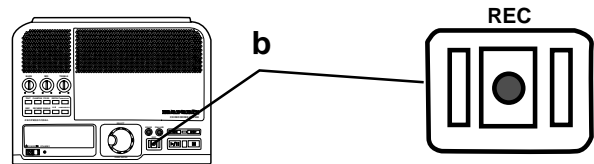

a The red REC indicator and the pause indicator in the display are lit.

b The red REC button is lit and flashing.

5 Push and release the REC button to put the CDR300 in Rec/Pause mode waiting for the external source to begin.

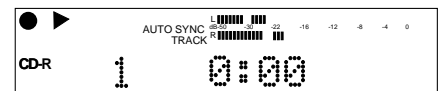

6 Start the external source to begin recording.

Example display during recording.

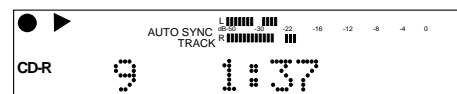

7 To finalize push and release the FINALIZE button.

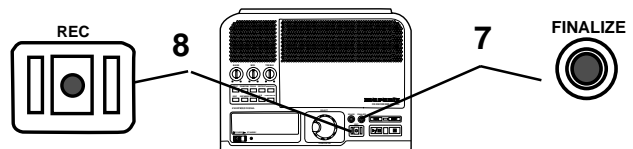

FINALIZE is displayed for a couple of seconds.

Then PUSH REC KEY is displayed.

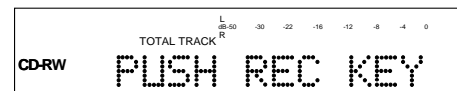
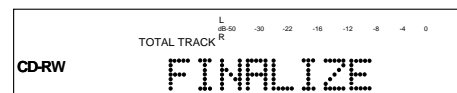

8 Push and release the REC button.

Finalizing counts down for about 2 minutes and automatically stops.

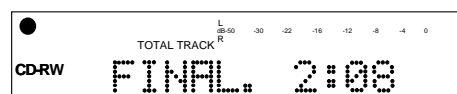

How to Record continued

Select record mode

The record mode (REC mode) sets the CDR300 to expect and accept certain inputs, outputs, and other conditions such as the settings of AUTO TRACK and AUTO STOP, and the easy availability of some adjustments such as REC LEVEL.

The following descriptions will help you select the REC mode that suits your needs.

RECORD

You can record using the INT mic, MIC/LINE inputs and/or AUX inputs or DIGITAL input.

This mode can be used to record live meetings, conferences, concerts, seminars, and also for mastering in the project studio.

CD recordings must first be finalized in order to play back on other CD drives.

MINUTE TRACK

In this mode tracks are automatically written on the disc every minute. Minute Track recording allows you to quickly locate sections of your recording because of the relationship between track numbers and time. For example, during playback select track 30 to play the 30th minute of recording. To go directly to the beginning of the 10th minute select track 10, etc.

Track 1 = 1st minute of recording
Track 2 = 2nd minute of recording
Track 3 = 3rd minute of recording
And so on . . .

Note: When recording press DISP to indicate remaining disc time.

The disc must be finalized in order to play on other CD drives.

SYNC RECORD

This REC mode is used to automatically engage the recording process from an outside digital or analog source including DAT, CD, minidisk, cassette tape or LP for example.

The disc must be finalized in order to play on other CD drives.

SYNC REC+FINAL

Use this REC mode to automatically start the recording process from an outside digital or analog source including DAT, CD, minidisk, cassette tape or LP for example.

The disc will automatically be finalized at the end of the recording session. The finalization takes approximately 2 minutes.

Recording tips

- Be sure to set the LINE MIC INT, INPUT ANALOG/DIGITAL, MIC/LINE ATT, and SPEAKER switches to the appropriate setting before entering a REC mode.
- Consider using a CD-RW (re-writable) disc. Then only the tracks that you like can be duplicated to a CD-R (write once) disc.
- To record MONO (one microphone or instrument to both channels of the CD recorder) switch the L/R L+R switch to L+R.
- Before recording using AUX inputs only always lower the MIC/LINE level controls and select LINE on the MIC/LINE/INT switch. This will improve the quality of your recording by reducing unwanted white noise resulting from an open, unused input jack.
- In order to avoid feedback during analog recording with any microphone, switch the SPEAKER to OFF or lower the level of the PHONE/SPEAKER LEVEL control. Lower the LINE OUT level control if you are connected to an external amplifier.
- Note the default conditions of AUTO TRACK and AUTO STOP outlined in this manual (see below). Each recording mode has a default setup of these functions that can be altered to fit the conditions of your specific application.
- You can use the supplied infrared remote control to write your own track ID's during the recording process by pushing the TR INC button.
- When the remaining record time on the CD-R or CD-RW becomes 5 minutes, the message DISC END will be displayed, and then the display will indicate the remaining time both in minutes and seconds as well as graphically.
- When DISC FULL is displayed there is no more available recording time on the disc.

Record adjustments

AUTO TRACK and AUTO STOP defaults

The default settings for AUTO TRACK and AUTO STOP depend on the REC mode.

REC mode	AUTO TRACK	AUTO STOP
RECORD	OFF	OFF
MINUTE TRACK	N/A	N/A
SYNC RECORD	ON	ON
SYNC REC+FINAL	ON	ON

How to Record continued

AUTO TRACK

When recording with AUTO TRACK ON the CDR300 will automatically increment tracks.

If AUTO TRACK is ON and the source of recording is a digital source that has tracks, such as a CD player connected to the AUX IN jacks or a source input via the DIGITAL IN jack (CD/MD), those tracks will be included in your recording. This source data is usually found only in an SPDIF format digital connection.

If AUTO TRACK is ON and the source is digital (without track data) or analog, the CDR300 will use a silence gap to mark a track. When the source audio signal drops below -80dB for digital, or -40dB for analog, for 3 seconds or more and then rises to above those levels, the CDR300 will mark a new track and continue recording.

You can manually introduce a new track when AUTO TRACK is ON or OFF by pushing TR INC on the remote.

How to turn AUTO TRACK ON or OFF

- 1 With the CDR300 in one of the REC modes.
- 2 Push and release MENU/STORE.
- 3 Turn the SELECT control so AUTO TRACK is displayed.

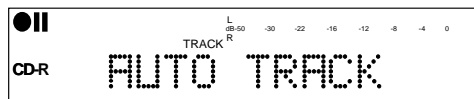

- 4 Push and release the SELECT control to select the AUTO TRACK menu item. The current status of AUTO TRACK ON or OFF is displayed.

Example shows AUTO TRACK ON.

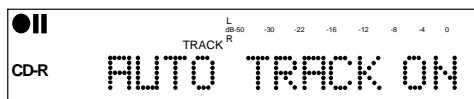

- 5 Push and release the SELECT control to select the displayed state of AUTO TRACK, or turn the SELECT control to select the other state and then push and release the SELECT control.

- 6 The display returns to AUTO TRACK.

AUTO STOP

When recording with AUTO STOP ON the CDR300 will automatically stop after a period of silence. The silence will be recorded onto the last track of the recording session.

When recording with AUTO STOP ON from an analog source, the recording will stop after recording 20 seconds of silence (a signal lower than -40dB). When recording with AUTO STOP ON from a digital source (without track and stop data), the recording will stop after recording 4 seconds of silence (a signal lower than -80dB).

How to turn AUTO STOP ON or OFF

- 1 With the CDR300 in one of the REC modes
- 2 Push and release MENU/STORE.
- 3 Check or turn the SELECT control so AUTO STOP is displayed.

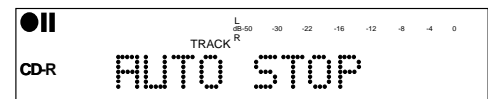

- 4 Push and release the SELECT control to select the AUTO STOP menu item. The current status of AUTO STOP ON or OFF is displayed.

Example shows AUTO STOP ON.

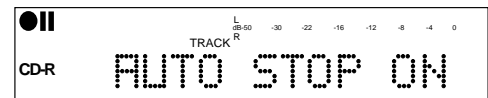

- 5 Push and release the SELECT control to select the displayed state of AUTO STOP, or turn the SELECT control to select the other state and then push and release the SELECT control.

- 6 The display returns to AUTO STOP.

REC LEVEL adjustment

With the REC LEVEL switch at MANUAL or LIMITER, in all recording modes, when at record Pause, (REC button flashing) you can adjust the final record level by turning the SELECT control. Turn clockwise for maximum record level.

Example display.

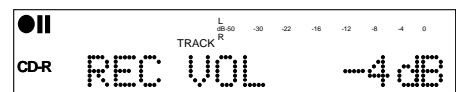

Notes:

Changes to the REC LEVEL setting are saved in memory both during STANDBY and power OFF. Turn the SELECT control to display the current REC LEVEL setting.

How to Record continued

How to adjust the MIC EQUALIZER

With the CDR300 in Stop, Play/Pause, REC or REC Pause mode.

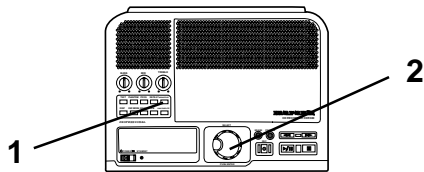

- 1 Push and release MENU/STORE.
- 2 Turn the SELECT control so MIC EQUALIZER is displayed.

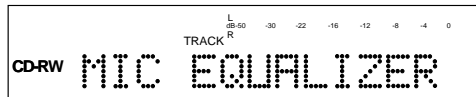

- a Push and release the SELECT control. MIC/LINE Rch is displayed.

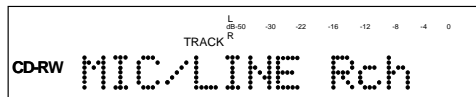

- b Push and release the SELECT control to confirm the right channel or turn the SELECT control to select the left channel. Then push and release the SELECT control to confirm.

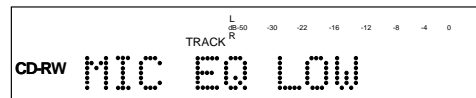

- c Push and release the SELECT control to confirm adjusting the low frequencies or turn the SELECT control to select adjusting the high frequencies. Then push and release the SELECT control to confirm.

Example display.

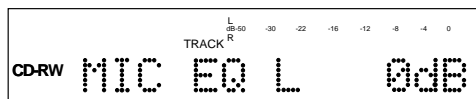

- d Turn the SELECT control to change the decibel level from -10 to +10 dB. Then push and release the SELECT control to enter the value and return to MIC EQUALIZER.

Repeat steps a, b, c and d to change the values for the other channel and High or Low.

When done push and release MENU/STORE to exit.

Record adjustments continued

How to adjust REC BALANCE

The REC BALANCE menu item lets you adjust the right left stereo balance for recording. You can adjust REC BALANCE during a recording session by pausing the recording session.

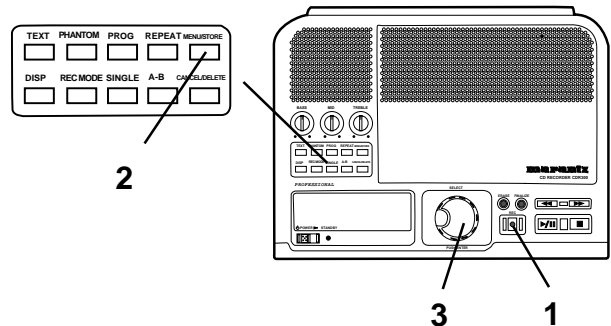

- 1 With the CDR300 in REC mode (recording mode selected and REC button lit and flashing).
- 2 Push and release MENU/STORE.
- 3 Turn the SELECT control so REC BALANCE is displayed.

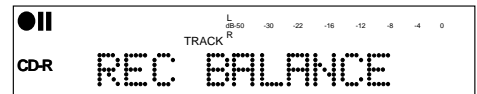

- a Push and release the SELECT control. The current balance setting is displayed

Example display shows mid point of balance.

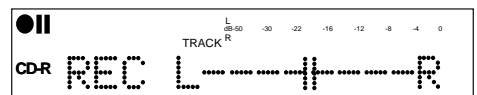

- b Turn the SELECT control clockwise to adjust balance to the Right and counter clockwise to adjust balance to the Left.

Example display shows balance partially to the Left.

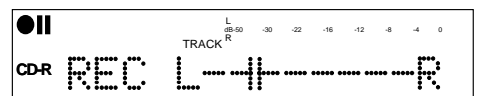

- c Push and release the SELECT control to confirm your balance adjustment. The REC BALANCE display returns.

- d Push and release MENU/STORE to exit Menu mode.

How to select filters (FILTER SELECT)

The FILTER SELECT menu item lets you turn high pass or band pass filters on the right or left MIC/LINE inputs on or off.

Frequency	FILTER SPECIFICATIONS		
	FILTER OFF	BAND PASS ON	HIGH PASS ON
20Hz	0dB	-48dB	-48dB
50Hz	0dB	-24dB	-24dB
100Hz	0dB	-6dB	-12dB
250Hz	0dB	0dB	0dB
500Hz	0dB	0dB	0dB
1kHz	0dB	0dB	0dB
5kHz	0dB	0dB	0dB
10kHz	0dB	-6dB	0dB
15kHz	0dB	-12dB	0dB
20kHz	0dB	-24dB	0dB

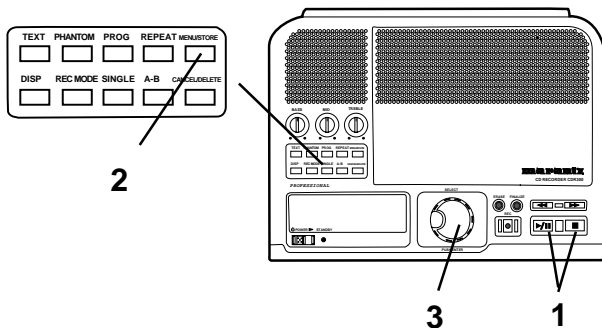

- 1 With the CDR300 in Stop, Play/Pause, REC or REC Pause mode,
- 2 Push and release MENU/STORE.
- 3 Turn the SELECT control so FILTER SELECT is displayed.

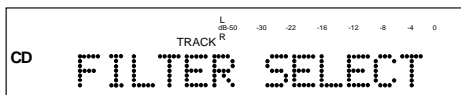

- a Push and release the SELECT control. MIC/LINE Lch or MIC/LINE Rch is displayed

Example display.

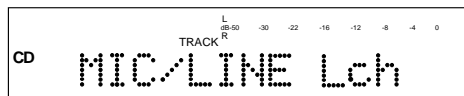

- b Turn the SELECT control to switch between Lch (left channel) and Rch (right channel). Push and release the SELECT control to confirm your selection. The display switches to one of three filter choices (BAND PASS ON, HIGH PASS ON, or FILTER OFF).

Example display.

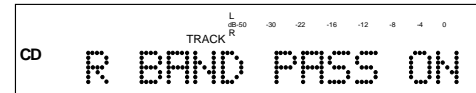

- c Push and release the SELECT control to confirm the displayed filter selection or turn the SELECT control to switch to the other choices.

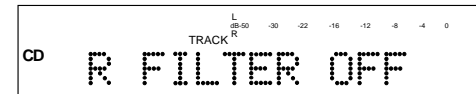
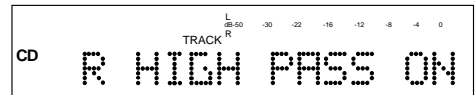

- d When you have confirmed your selection the display returns to FILTER SELECT.

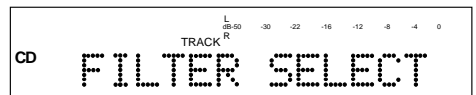

When done making filter selections push and release MENU/STORE (2) to exit Menu mode.

How to Erase

You can only erase CD-RW discs.

You can erase one or more tracks from the end of the CD-RW disc, or you can erase the entire disc. If finalized, erasing a track or the disc automatically unfinalizes the disc.

Push and release ERASE

- **Once** to select erasing the last track of the disc,
- **Twice** in succession to erase the entire disc,
- **Three** times in succession to unfinalize.

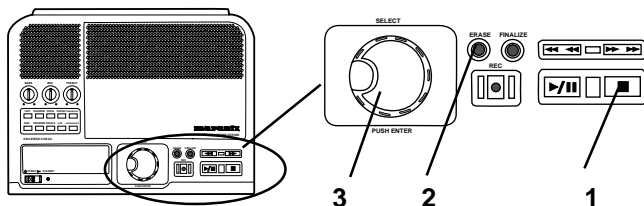

How to Erase the last track

1 Push Stop. The display shows the number of tracks and their total playing time (example shown).

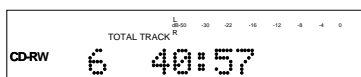

2 Push ERASE. ERASE TRACK is displayed for about 3 seconds.

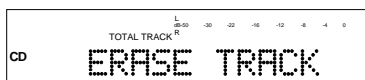

Then PUSH ENTER is displayed.

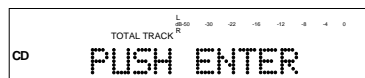

3 Push the SELECT PUSH/ENTER control. The timer (a) counts down as the track is erased.

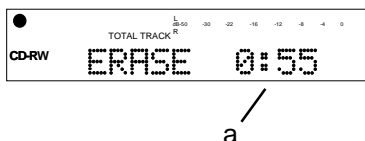

When done the display shows the remaining number of tracks and their total playing time (example shown).

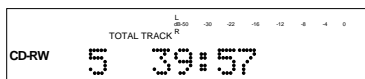

How to Erase the entire disc

1 Push Stop. The display shows the number of tracks and their total playing time (example shown).

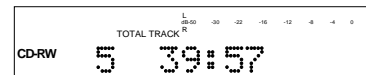

2 Push ERASE twice. After the first push ERASE TRACK is displayed.

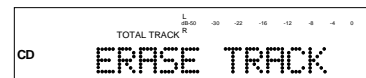

After the second push ERASE DISC is displayed for about three seconds.

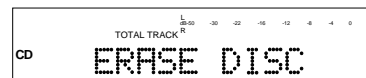

Then PUSH ENTER is displayed.



3 Push the SELECT PUSH/ENTER control. The timer (a) counts down as the disc is erased.

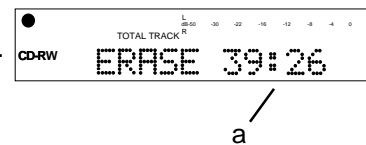

When done the display shows BLANK DISC.

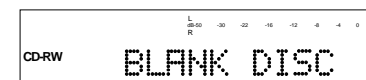

How to Finalize

Finalizing is writing the TOC (table of contents) on a disc so a CD player can recognize the number of tracks, the total time for each track, and their location on the disc. A recorded disc must be finalized to playback on a standard CD player. Once finalized a CD-R disc can be played on CD players that support CD-R playback. CD-RW discs can only be played on CD players that support CD-RW playback. Consult your CD player owner's manual to confirm supported formats.

Finalizing is necessary to:

- be able to play a recorded CD-R or CD-RW disc on a CD player
- prevent further recording on a disc
- avoid erasing tracks on a CD-RW disc
- record text information onto a disc you record

Notes:

- A finalized CD-R disc can never be recorded onto again.
- A finalized CD-RW disc can be unfinalized for more recording.
- The CDR300 can play back unfinalized CD-R or CD-RW discs.
- SYNC REC+FINAL mode automatically finalizes.

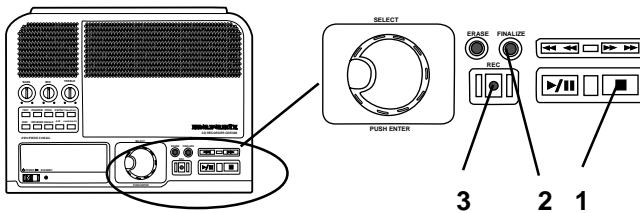

How to Finalize a CD-R or CD-RW disc:

1 Push Stop.

The display shows the number of tracks and their total playing time (example shown).



2 Push FINALIZE.

FINALIZE is displayed for about 3 seconds.



Note:

If the disc is blank or has already been finalized, NOT POSSIBLE flashes twice, then the display returns to the time display.

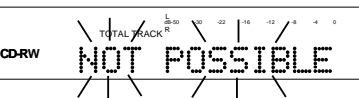

Then PUSH REC KEY is displayed.

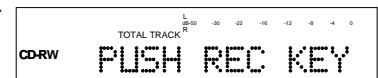

3 Push the REC button. The timer (a) counts down as the track is erased.

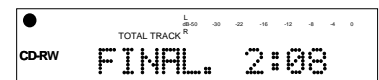

When done the display shows the number of tracks and their total playing time (example shown).



CD-RW or CD-R changes to CD (b).

How to Unfinalize a CD-RW disc

1 Push Stop. The display shows the number of tracks and their total playing time (example shown).

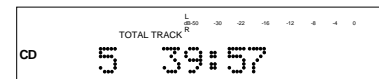

2 Push ERASE three times. After the first push ERASE TRACK is displayed.

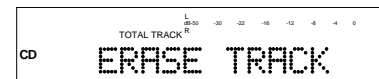

After the second push ERASE DISC is displayed.

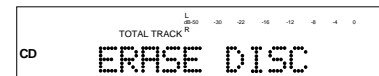

After the third push UNFINALIZE is displayed for about three seconds.

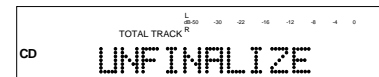

Then PUSH ENTER is displayed.



3 Push the SELECT PUSH/ENTER control. The timer (a) counts down as the finalizing is erased.

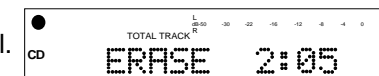

When done the display shows the number of tracks and their total playing time (example shown).



The disc has been unfinalized but not erased.

About the Remote

The supplied infrared remote control permits most functions of the CDR300 to be controlled remotely.

See **Remote batteries** for installing or changing remote batteries.

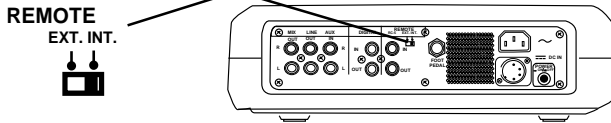

The REMOTE EXT. INT. switch on the back of the CDR300 must be at INT. for the infrared remote to work.

Most of the controls on the remote work identically to the control on the unit. The page number describing identical functioning unit controls is given below.



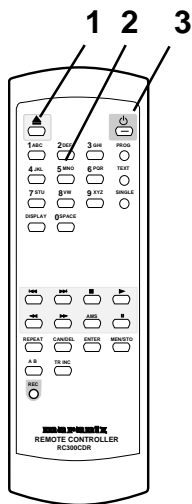







Further instruction is supplied for controls that are on the remote only or that function differently from controls on the unit.



1  = OPEN/CLOSE switch for the CDR drive.

See page 14.

2 Alphanumeric keypad

1 ABC	2 DEF	3 GHI
		
4 JKL	5 MNO	6 PQR
		
7 STU	8 VW	9 XYZ
		
0 SPACE		
		

The Alphanumeric keypad performs some of the functions of the SELECT control.

In Play and Program modes push and release a number button to select the track. Then push ENTER on the unit or remote to enter the selection.

When entering CD TEXT push a number button once to select the first of the three letters, twice for the second and three times for the third. Push ENTER on the remote or unit to enter the selected number.

3  = Standby POWER switch.
See page 11.

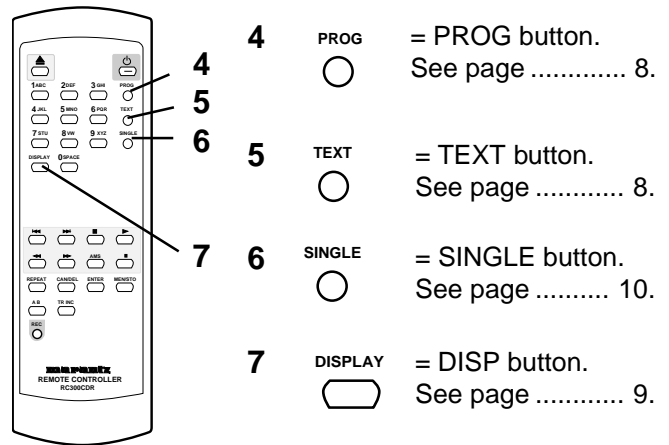



4  = PROG button.
See page 8.

5  = TEXT button.
See page 8.

6  = SINGLE button.
See page 10.

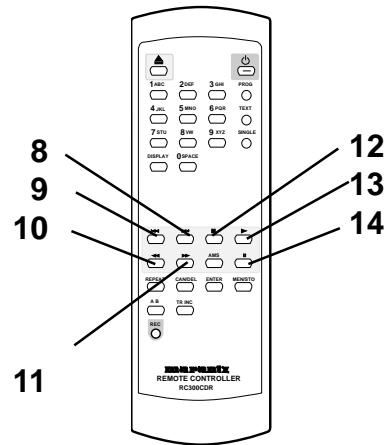
7  = DISP button.
See page 9.



8  Track Skip forward button.
Push and release during Play, Pause, or Stop to skip forward to the next track.

9  Track Skip backward button. Push and release during Play or Pause to skip backward to the beginning of the track. Push and release again to skip backward to the beginning of the previous track. Push and release during Stop to skip backward to the beginning of the previous track.

10  = Fast backward search button.
See page 12.

11  = Fast forward search button.
See page 12.

12  = Stop button.
See page 12.

13  = Play of Play/Pause button.
See page 12.

14  = Pause of Play/Pause button.
See page 12.

About the Remote continued

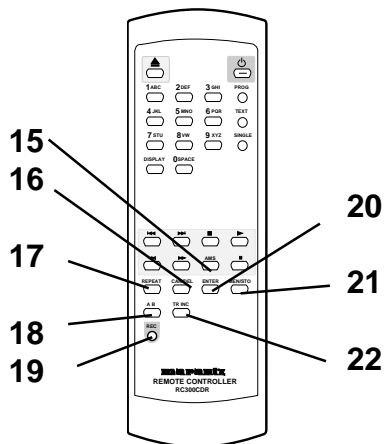



15  **AMS** AMS (Automatic Search) button.
Remote only. Push and release to play the first 10 seconds of each track. AMS is displayed in the time display while searching. Push Pause to pause the automatic search. Push Play to switch from AMS to Play. Automatically stops at the end of the disc. Push AMS to exit automatic search.

16  **CAN/DEL** = CANCEL DELETE button.
See page 10.

17  **REPEAT** = REPEAT button.
See page 8.

18  **A B** = A-B button.
See page 10.

19  **REC** = REC button.
See page 12.

20  **ENTER** ENTER button.
Performs some of the functions of the SELECT control.

- In Play and Program modes push number button to select the track. Then push ENTER to enter the selection.
- Selects settings in MENU mode.
- Programs track numbers.
- Enters a letter during finalizing text entry.
- When entering CD TEXT push ENTER to enter the selected character.

21  **MEN/STO** = MENU/STORE button.
See page 9.

22  **TR INC** TR INC button. Remote only.
During recording push and release to manually increment a new track. It is recommended to set AUTO TRACK to OFF.

About CD discs

The CDR300 can play CD, CD-R, or CD-RW discs and can record on CD-R or CD-RW discs.

CD-R (record once)

CD-R discs are only able to be recorded onto a single time but will playback in most CD players.

CD-R discs can be recognized by the following logos:



CD-RW (multiple recording)

CD-RW discs are able to be recorded onto many times but will only playback in CD players offering CD-RW compatibility. Products that offer CD-RW compatibility are available from Marantz, Marantz Professional, and Superscope. Please contact your dealer for more information on these products.

CD-RW discs can be recognized by the following logos:



Notes:

- Some DVD players cannot playback CD-R discs and CD-RW discs because of laser power differences.
- Some CD players may be able to playback finalized CD-RW discs.
- Some CD players can not play finalized CD-R discs because of the low reflectivity of such discs.

Which discs to use:

The CDR300 is able to record onto any 1X or 2X compatible CD-R and CD-RW disc, including discs for Consumer use and Professional (computer) discs.

The CDR300 records according to the Orange Book specification. Every CDR disc sold should be according to the Orange Book specification and therefore compatible with the CDR300.

In practice however, the quality of the recording depends on the match between the disc used and the writing strategy of the recorder. At 1X speed (stand alone audio) the match between disc and recorder is

important. Higher recording speeds are less critical in terms of recording quality.

Consumer CD Recorders can only record on CD-R Audio discs and those discs are optimized for single speed automatically. Professional CD Recorders can use both Audio and Data discs. When using Data discs, one should take care to use discs with a good single speed compatibility.

Recording Capacity:

Discs with higher capacity than 74 minutes (80 minutes) are out of the Orange Book standard and may perform below your expectations.

Compact disc care

The glossy side is the record side of the disc, and matted (dull) side is the label side.

Handle discs carefully so as not to damage or scratch the record side.

Avoid placing discs in the following locations:

- In direct sunlight or near a source of heat such as a heater.
- In a place that is damp or dirty.
- In a place which could be exposed to rain, such as near a window.

Disc cleaning

Always keep the disc surface clean. Up to six billion data units are recorded on the record side of the disc. When cleaning the disc surface always be sure to use a special compact disc cleaner and wipe as shown below.

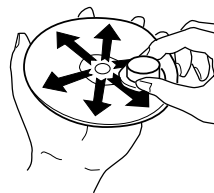

Wipe in a radial direction.

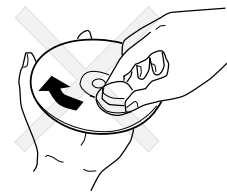

Do not wipe in circumferential direction.

- Do not use record cleaner, it will adversely affect the disc surface.
- Store discs in their disc cases.
- Do not attach a piece of paper or sticker to the label side of the disc. When a disc has a piece of plastic

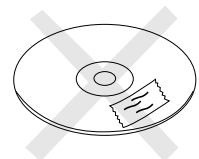

tape or rental CD label with paste protruding from the edge or when a disc has a trace of such a sticky object, do not attempt to play the disc. The disc may be impossible to take out, or another malfunction may result.

- Write only on the printed side of a CD-R or CD-RW disc, and only with a soft felt-tipped pen.
- Do not attempt to record a disc with a special shape.
- Do not attempt to play a disc with a special shape such as an octagonal or heart shaped disc. Equipment malfunction may result.



CD text

CD text, when present, provides text information such as the CD title, artist, track titles, and track artists.

The CDR300 can record text information on an unfinalized CD-R or CD-RW disc that you record.

CD text during playback

When a disc is inserted in the CDR drive the CDR300 automatically detects if a disc has text information and automatically displays the CD title. The CDR300 can display 14 characters, if the text information is longer than that the text automatically scrolls from right to left.

Recording CD text

Before finalization of a CD you can enter text information. Only the CD title and track titles can be entered.

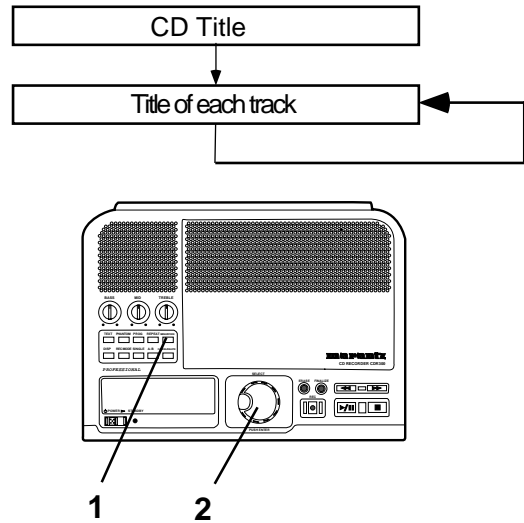

TEXT EDIT

With your unfinalized disc in the CDR drive and stopped

- 1 push and release Menu/Store.
- 2 Turn the SELECT control so TEXT EDIT is displayed.

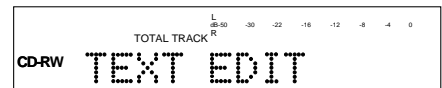

Push and release the SELECT control to select. CD TITLE is displayed.

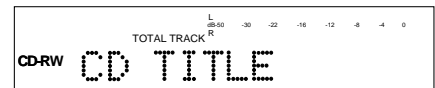

(Turn the SELECT control to select editing track titles.) Push and release the SELECT control to select editing the CD TITLE or the Track title. The first character of the title is flashing.

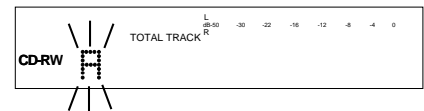

Turn the SELECT control to select the character, or from the remote push and release alphanumeric keys to select the character.

TEXT EDIT continued

The SELECT control presents the following characters in order:

```

ABCDEFGHIJKLMNPO
QRSTUVWXYZ
abcdefghijklmnop
rstuvwxyz
0123456789 _
!"#$%&'()*+,-./:;
<=>?@[#\]^_`{|}~
    
```

The _ after the 9 is recorded as a space.

Consider using the infrared remote control to enter CD text. All the numbers, the space, and all upper and lower case characters are available from the remote alphanumeric keypad.

When the correct character is flashing, push and release the SELECT control or push ENTER on the remote.

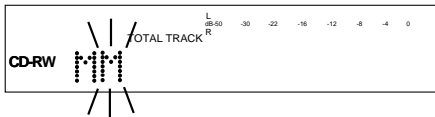

In this example M was entered. The entered character is repeated and flashing.

Continue selecting characters and entering them. Up to 23 characters.

The Fast backward search button and Fast forward search button both work as the cursor during text editing. Push and release to move the editing position one character.

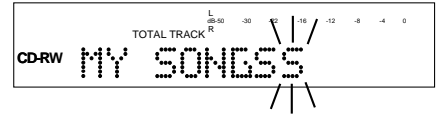
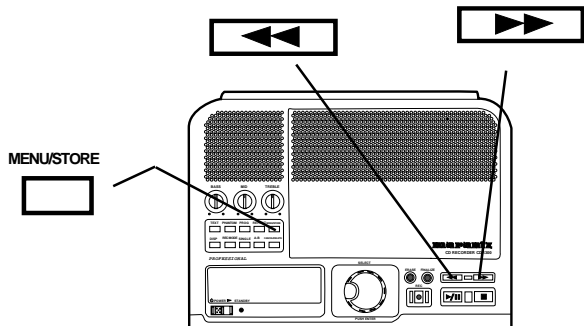

After the final character is entered, push and release MENU/STORE.

Note: All CD text entries are in short term memory until the CD is finalized. You can play, pause and stop, but if you turn off power, or open the CDR drive your editing will be lost.

How to view CD text

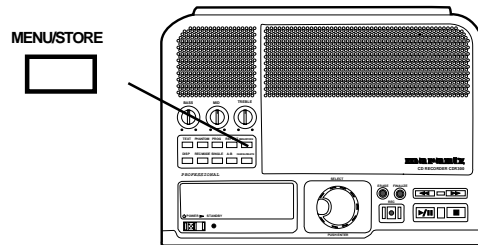

The **TEXT VIEW** menu item lets you review the CD text that has been entered before a disc is finalized.

With your disk in the CDR drive and stopped

- 1 Push and release MENU/STORE.
- 2 Turn the SELECT control so TEXT VIEW is displayed.

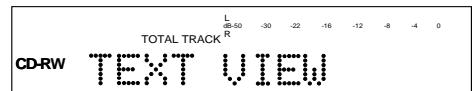

- 3 Push and release the SELECT control to confirm the selection.

Example display

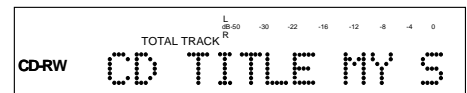

- 4 Push and release the SELECT control to review how the album title scrolls by when displayed, or,
- 5 Turn the SELECT control to switch to reviewing track text.

Example display

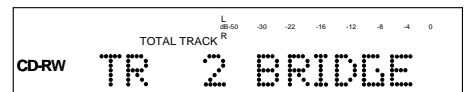

How to erase CD text

The **TEXT ERASE** menu item lets you delete CD text that has been entered.

With your unfinalized disk in the CDR drive and stopped

- 1 Push and release MENU/STORE.
- 2 Turn the SELECT control so TEXT ERASE is displayed.

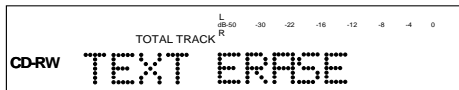

- 3 Push and release the SELECT control to confirm the selection. ALL TEXT is displayed.

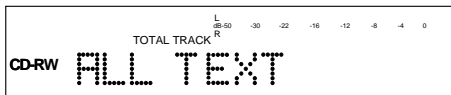

When ALL TEXT is displayed, turn the SELECT control to select erasing only the CD title or a track title.

- 4 Push and release the SELECT control to confirm the selection. ERASE? is displayed briefly, then PUSH ENTER is displayed.

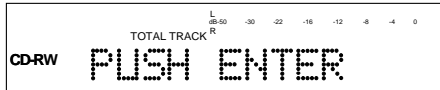
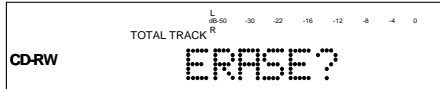

Push and release the SELECT control to erase the selected text.

RC-5 remote control codes

Function	CD-R code	
	System (dec)	Command (dec)
0 _ Space	26	00
1 ABCabc	26	01
2 DEFdef	26	02
3 GHIghi	26	03
4 JKLjkl	26	04
5 MNOmno	26	05
6 PQRpqr	26	06
7 STUstu	26	07
8 VWvw	26	08
9 XYZxyz	26	09
PLAY	26	53
STOP	26	54
PAUSE	26	48
NEXT	26	32
PREVIOUS	26	33
FF	26	52
REW	26	50
CANCEL/DELETE	26	49
DISPLAY	26	11
AMS (intro scan)	26	43
REC	26	55
OPEN/CLOSE	26	45
STANDBY	26	12
TEXT	26	15
ENTER	26	87
MENU/STORE	26	82
REPEAT	26	29
A - B	26	59
TR.INCR	26	114
SINGLE	26	5911

Troubleshooting

Warning!

Under no circumstances should you try to repair the unit yourself. That will cause a safety hazard and void the warranty.

No Power

- Check that the Power switch on the back of the CDR300 is in the in ON position.
- If the STANDBY light is lit, slide the POWER switch to the right.
- Check that the power cord is plugged in correctly.
- Switch the Power switch on the back of the unit OFF and then back ON.

No sound

- Check audio connections.
- Check position of level control (LINE OUT for attached amplifier speaker system, PHONE/SPEAKER LEVEL for internal speaker or headphones).

Amplified sound is distorted

- Check that LINE OUT is not connected to a Phone input.
- Check that the disc is not defective (try another disc.)

Disc problems

Display message	Description
DATA/DISC ERROR	Disc is not an audio CD.
DISC ERROR	Corrupt or out of specifications disc.
OPC ERROR	Optimum Power Calibration (OPC) failure. Disc problem, use new disc.
REC ERROR	Recording interrupted as a result of transport failure due to shock or a bad sector of the recordable disc.

Maintenance

- Clean the CDR300 with a soft, slightly dampened lint-free cloth. Do not use any cleaning agents as they may have a corrosive effect.
- Do not expose the CDR300, batteries or CDs to humidity, rain, sand or excessive heat (caused by heating equipment or direct sunlight).
- The lens may cloud over when the CDR300 is suddenly moved from cold to warm surroundings. It is not possible to play a CD then. Leave the CDR300 in a warm environment until the moisture evaporates.
- Always keep the tray closed to avoid dust on the lens.

Play will not start

- Check that the disc is inserted correctly.
- Check that the disc is not defective (try another disc.)

Remote control does not work

- Check that the REMOTE EXT./INT. switch is at INT.
- Point the infrared remote at the remote sensor.
- Check/replace batteries.

Recording is distorted

- Check/lower recording level.
- Check for a defective disc by trying another disc.

Will not record

- Check/clean the disc.
- Check that the disc is recordable.
- Check that the right input source is selected.
- Check that the disc is not defective. Clean the disc or try another disc.

Limited Warranty:

Your Marantz Professional product is warranted against manufacturer defects in material and workmanship for a period of one year parts and labor.

Except as specified below this warranty covers defects in material and workmanship. The following are not covered under warranty:

1.
 - a) Damage, deterioration, malfunction or failure to meet performance specifications resulting from:
 - b) Accidents, acts of nature, misuse, abuse, neglect or unauthorized product modification.
 - c) Improper installation, removal or maintenance, or failure to follow supplied instructions.
 - d) Repair or attempted repair by a non-Marantz authorized agent.
 - e) Any shipment (claims must be presented to the carrier).
 - f) Any cause other than a defect of manufacturing.
2. Cleaning, check-ups with no fault found or changes incurred for installation, removal or reinstallation of the product.
3. Any serialized product on which the serial number has been defaced, modified or removed.
4. Batteries and battery chargers.
5. Accessories, including but not limited to, cables, mounting hardware and brackets, cleaning accessories, power cords and adapters, and carry cases.
6. Product purchased outside of the United States, its possessions or territories.

Non-transferable Warranty

This warranty may be enforced only by the original purchaser.

What We Will Pay For

We will pay for all labor and material expenses for items covered by the warranty.

How You Can Get Service

1. If your unit needs service in the USA contact our service referral at the appropriate telephone number indicated below. We will advise you of the name and location of one or more authorized service centers from which service may be obtained. Please do not return the unit directly to us.
2. You must pay any shipping charges if it is necessary to ship the product for service. If the necessary repairs are covered by the warranty, we will pay return shipping charges to your location anywhere in the United States or its territories.
3. Whenever warranty service is required, you must present the original dated sales receipt, or other proof of date purchased.

Limitation of Implied Warranties

All implied warranties, including warranties of merchantability and fitness for a particular purpose, are limited in duration to the length of this warranty.

Exclusion of Damages

Liability for any defective product is limited to repair or replacement of the product at manufacturer's option. Manufacturer shall not be liable for damage to other products caused by any defects in Marantz products, damages based on inconvenience or loss of use of the product, or any other damages, whether incidental, consequential, or otherwise.

Some States do not allow limitations on how long an implied warranty lasts and/or do not allow the exclusion or limitation of incidental or consequential damages, so the above limitations and exclusions may not apply to you.

How State Law Relates to the Warranty

This warranty gives you specific legal rights, and you may have other rights which may vary from State to State.

Marantz Professional Service Number:

Marantz Professional Factory Service (630) 820-4800

This warranty is enforceable only in the United States and its possessions or territories.

marantz®

Superscope Technologies, Inc.

2640 White Oak Circle Telephone (630) 820-4800
Aurora, Illinois 60504 Fax: (630) 820-8103
Internet: www.superscope-marantzpro.com

Free Manuals Download Website

<http://myh66.com>

<http://usermanuals.us>

<http://www.somanuals.com>

<http://www.4manuals.cc>

<http://www.manual-lib.com>

<http://www.404manual.com>

<http://www.luxmanual.com>

<http://aubethermostatmanual.com>

Golf course search by state

<http://golfingnear.com>

Email search by domain

<http://emailbydomain.com>

Auto manuals search

<http://auto.somanuals.com>

TV manuals search

<http://tv.somanuals.com>