

# mz-7

Mini Hi-Fi System

Toll Free Help Line

Ligne d'assistance en service libre  
Linea de ayuda telefónica sin cargo

800-531-0039



# DESIGN



**PHILIPS**

*Let's make things better.*

## Return your Warranty Registration card today to ensure you receive all the benefits you're entitled to.

- Once your Philips purchase is registered, you're eligible to receive all the privileges of owning a Philips product.
- So complete and return the Warranty Registration Card enclosed with your purchase at once. And take advantage of these important benefits.

### Warranty Verification

Registering your product within 10 days confirms your right to maximum protection under the terms and conditions of your Philips warranty.

### Owner Confirmation

Your completed Warranty Registration Card serves as verification of ownership in the event of product theft or loss.

### Model Registration

Returning your Warranty Registration Card right away guarantees you'll receive all the information and special offers which you qualify for as the owner of your model.

Know these  
*safety* symbols



#### For Customer Use

Enter below the Serial No. which is located on the rear of the cabinet. Retain this information for future reference.

Model No. \_\_\_\_\_

Serial No. \_\_\_\_\_



This "bolt of lightning" indicates uninsulated material within your unit may cause an electrical shock. For the safety of everyone in your household, please do not remove product covering.



The "exclamation point" calls attention to features for which you should read the enclosed literature closely to prevent operating and maintenance problems.

**WARNING:** TO PREVENT FIRE OR SHOCK HAZARD, DO NOT EXPOSE THIS EQUIPMENT TO RAIN OR MOISTURE.

**CAUTION:** To prevent electric shock, match wide blade of plug to wide slot, and fully insert.

# PHILIPS

***Congratulations on your purchase,  
and welcome to the “family!”***

**Dear Philips product owner:**

Thank you for your confidence in Philips. You've selected one of the best-built, best-backed products available today. And we'll do everything in our power to keep you happy with your purchase for many years to come.

As a member of the Philips “family,” you're entitled to protection by one of the most comprehensive warranties and outstanding service networks in the industry.

What's more, your purchase guarantees you'll receive all the information and special offers for which you qualify, plus easy access to accessories from our convenient home shopping network.

And most importantly you can count on our uncompromising commitment to your total satisfaction.

All of this is our way of saying welcome—and thanks for investing in a Philips product.

Sincerely,



Robert Minkhorst  
President and Chief Executive Officer

**P.S. Remember, to get the most from your Philips product, you must return your Warranty Registration Card within 10 days. So please mail it to us right now!**



	<b>CAUTION</b>	
<b>RISK OF ELECTRIC SHOCK DO NOT OPEN</b>		
<b>CAUTION: TO REDUCE THE RISK OF ELECTRIC SHOCK, DO NOT REMOVE COVER (OR BACK). NO USER-SERVICEABLE PARTS INSIDE. REFER SERVICING TO QUALIFIED SERVICE PERSONNEL.</b>		



This symbol warns the user that uninsulated voltage within the unit may have sufficient magnitude to cause electric shock. Therefore, it is dangerous to make any kind of contact with any inside part of this unit.



This symbol alerts the user that important literature concerning the operation and maintenance of this unit has been included. Therefore, it should be read carefully in order to avoid any problems.

## WARNING

To reduce the risk of fire or electric shock, do not expose this appliance to rain or moisture.

## CAUTION

Use of controls or adjustments or performance of procedures other than herein may result in hazardous radiation exposure.

The set complies with the FCC-Rules, Part 15 and with 21 CFR 1040.10.

## Canada

This digital apparatus does not exceed the Class B limits for radio noise emissions from digital apparatus as set out in the Radio Interference Regulations of the Canadian Department of Communications.

	<b>AVIS</b>	
<b>RISQUE DE CHOC ÉLECTRIQUES NE PAS OUVRIR</b>		
<b>Attention: Afin de prévenir le risque de chocs électriques, ne pas retirer les vis. Toute réparation devrait être confiée à un personnel qualifié.</b>		



Ce symbole indique la présence d'une tension suffisamment élevée pour engendrer un risque de chocs électriques.



Ce symbole indique que le manuel d'installation fourni avec l'appareil contient d'importantes recommandations quant au fonctionnement et à l'entretien de ce dernier.

## AVIS

Afin de réduire tout risque d'incendie ou de choc électrique, il ne faut pas exposer cet appareil à la pluie ou à l'humidité.

## ATTENTION

L'utilisation des commandes ou réglages ou le non-respect des procédures ci-incluses peuvent se traduire par une exposition dangereuse à l'irradiation.

L'appareil répond aux normes FCC, Part 15 et 21 CFR 1040.10.

## Canada

Cet appareil numérique n'émet pas de bruits radioélectriques dépassant les limites applicables aux appareils numériques de Class B prescrites dans le Règlement sur le Brouillage Radioélectrique édicté par le Ministère des Communications du Canada.

	<b>AVISO</b>	
<b>RIESGO DE CHOQUE ELÉCTRICO NO ABRIR</b>		
<b>Atención: Para reducir el riesgo de choque eléctrico, no quite la tapa (o el panel posterior). En su interior no hay piezas que el usuario pueda reparar. Para servicio dirijase a personal calificado.</b>		



Este símbolo tiene por finalidad advertir al usuario de la presencia de tensión peligrosa no aislada dentro de la caja del aparato, que puede ser lo suficientemente fuerte para constituir un peligro de choque eléctrico.



Este símbolo sirve para advertir al usuario de la presencia de instrucciones de manejo y mantenimiento (servicio) importantes en el manual que acompaña al aparato.

## AVISO

Para reducir el riesgo de fuego o choque eléctrico, no exponga el aparato a la lluvia o humedad.

## ATENCIÓN

El uso de mando o ajustes o la ejecución de métodos que no sean los aquí descritos puede ocasionar peligro de exposición a radiación.

El aparato cumple las normas FCC, Parte 15 y 21 CFR 1040.10.

<b>English .....</b>	<b>5</b>
<b>Français .....</b>	<b>28</b>
<b>Español .....</b>	<b>54</b>

English  
Français  
Español



# SAFETY INSTRUCTIONS – Read before operating equipment

English

This product was designed and manufactured to meet strict quality and safety standards. There are, however, some installation and operation precautions which you should be particularly aware of.

1. **Read Instructions** - All the safety and operating instructions should be read before the appliance is operated.
2. **Retain Instructions** - The safety and operating instructions should be retained for future reference.
3. **Heed Warnings** - All warnings on the appliance and in the operating instructions should be adhered to.
4. **Follow Instructions** - All operating and use instructions should be followed.
5. **Water and Moisture** - The appliance should not be used near water - for example, near a bathtub, washbowl, kitchen sink, laundry tub or swimming pool, or in a wet basement.
6. **Carts and Stands** - The appliance should be used only with a cart or stand that is recommended by the manufacturer.
- 6A.  An appliance and cart combination should be moved with care. Quick stops, excessive force, and uneven surfaces may cause the appliance and cart combination to overturn.
7. **Wall or Ceiling Mounting** - The appliance should be mounted to a wall or ceiling only as recommended by the manufacturer.
8. **Ventilation** - The appliance should be situated so that its location or position does not interfere with its proper ventilation. For example, the appliance should not be situated on a bed, sofa, rug, or similar surface that may block the ventilation openings; or, placed in a built-in installation, such as a bookcase or cabinet that may impede the flow of air through the ventilation openings.
9. **Heat** - The appliance should be situated away from heat sources such as radiators, heat registers, stoves, or other appliances (including amplifiers) that produce heat.
10. **Power Sources** - The appliance should be connected to a power supply only of the type described in the operating instructions or as marked on the appliance.
11. **Grounding or Polarization** - Precautions should be taken so that the grounding or polarization means of an appliance is not defeated.

**CAUTION:** To prevent electric shock, match the wide blade of this plug to the wide slot and fully insert. Do not use this (polarized) plug with an extension cord, receptacle or other outlet unless the blades can be fully inserted to prevent blade exposure.

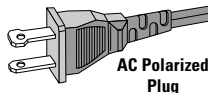

12. **Power Cord Protection** - Power supply cords should be routed so that they are not likely to be walked on or pinched by items placed upon or against them, paying particular attention to cords and plugs, convenience receptacles, and the point where they exit from the appliance.
13. **Cleaning** - The appliance should be cleaned only as recommended by the manufacturer.
14. **Power Lines** - An outdoor antenna should be located away from power lines.
15. **Outdoor Antenna Grounding** - If an outside antenna is connected to the receiver, be sure the antenna system is grounded so as to provide some protection against voltage surges and built up static charges. Section 810 of the National Electrical Code, ANSI/NFPA No. 70-1984, provides information with respect to proper grounding of the mast and supporting structure, grounding of the lead-in wire to an antenna discharge unit, size of grounding connectors, location of antenna-discharge unit, connection to grounding electrodes, and requirements for the grounding electrode. See figure on page 7.
16. **Non-use Periods** - The power cord of the appliance should be unplugged from the outlet when left unused for a long period of time.
17. **Object and Liquid Entry** - Care should be taken so that objects do not fall and liquids are not spilled into the enclosure through openings.
18. **Damage Requiring Service** - The appliance should be serviced by qualified service personnel when:
  - A. The power supply cord or the plug has been damaged; or
  - B. Objects have fallen, or liquid has spilled into the appliance; or
  - C. The appliance has been exposed to rain; or
  - D. The appliance does not appear to operate normally or exhibits a marked change in performance; or
  - E. The appliance has been dropped, or the enclosure damaged.
19. **Servicing** - The user should not attempt to service the appliance beyond that described in the operating instructions. All other servicing should be referred to qualified service personnel.

**Note to the Cable TV system installer**

This reminder is provided to call the Cable TV system installer's attention to Article 820-40 of the NEC that provides guidelines for proper grounding and, in particular, specifies that the cable ground shall be connected to the grounding system of the building, as close to the point of cable entry as practical.

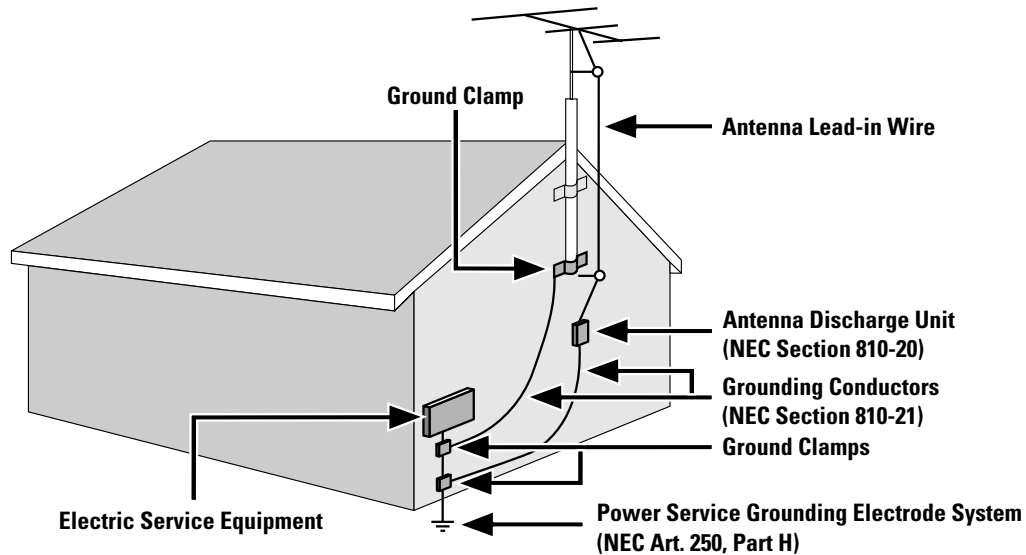
**Example of Antenna Grounding as per NEC - National Electrical Code**

# LIMITED WARRANTY

## AUDIO SYSTEM

One Year Free Labor

One Year Free Service on Parts

This product must be carried in for repair.

### WHO IS COVERED?

You must have proof of purchase to receive warranty service. A sales receipt or other document showing that you purchased the product is considered proof of purchase.

### WHAT IS COVERED?

Warranty coverage begins the day you buy your product. For one year thereafter, all parts will be repaired or replaced, and labor is free. After one year from the day of purchase, you pay for the replacement or repair of all parts, and for all labor charges.

All parts, including repaired and replaced parts, are covered only for the original warranty period. When the warranty on the product expires, the warranty on all replaced and repaired parts also expires.

### WHAT IS EXCLUDED?

Your warranty does not cover:

- labor charges for installation or setup of the product, adjustment of customer controls on the product, and installation or repair of antenna systems outside of the product.
- product repair and/or part replacement because of misuse, accident, unauthorized repair or other cause not within the control of Philips Consumer Electronics Company.
- reception problems caused by signal conditions or cable or antenna systems outside the unit.
- a product that requires modification or adaptation to enable it to operate in any country other than the country for which it was designed, manufactured, approved and/or authorized, or repair of products damaged by these modifications.
- incidental or consequential damages resulting from the product. (Some states do not allow the exclusion of incidental or consequential damages, so the above exclusion may not apply to you. This includes, but is not limited to, prerecorded material, whether copyrighted or not copyrighted.)

- a product that is used for commercial or institutional purposes.

### WHERE IS SERVICE AVAILABLE?

Warranty service is available in all countries where the product is officially distributed by Philips Consumer Electronics Company. In countries where Philips Consumer Electronics Company does not distribute the product, the local Philips service organization will attempt to provide service (although there may be a delay if the appropriate spare parts and technical manual(s) are not readily available).

### MAKE SURE YOU KEEP...

Please keep your sales receipt or other document showing proof of purchase. Attach it to this owner's manual and keep both nearby. Also keep the original box and packing material in case you need to return your product.

### BEFORE REQUESTING SERVICE...

Please check your owner's manual before requesting service. Adjustments of the controls discussed there may save you a service call.

### TO GET WARRANTY SERVICE IN U.S.A., PUERTO RICO OR U.S. VIRGIN ISLANDS...

Take the product to a Philips factory service center (see enclosed list) or authorized service center for repair. When the product has been repaired, you must pick up the unit at the center. Centers may keep defective parts. (In U.S.A., Puerto Rico and U.S. Virgin Islands, all implied warranties, including implied warranties of merchantability and fitness for a particular purpose, are limited in duration to the duration of this express warranty. But, because some states do not allow limitations on how long an implied warranty may last, this limitation may not apply to you.)

### TO GET WARRANTY SERVICE IN CANADA...

Please contact Philips at:

1-800-661-6162 (French Speaking)

1-800-363-7278 (English Speaking)

(In Canada, this warranty is given in lieu of all other warranties. No other warranties are expressed or implied, including any implied warranties of merchantability or fitness for a particular purpose. Philips is not liable under any circumstances for any direct, indirect, special, incidental or consequential damages, howsoever incurred, even if notified of the possibility of such damages.)

### REMEMBER...

Please record the model and serial numbers found on the product below. Also, please fill out and mail your warranty registration card promptly. It will be easier for us to notify you if necessary.

MODEL # \_\_\_\_\_

SERIAL # \_\_\_\_\_

*This warranty gives you specific legal rights. You may have other rights which vary from state/province to state/province.*

**Philips Service Solutions Group, P.O. Box 2976,  
Longview, Texas 75606, USA, (903) 242-4800**

EL4965E006 / MAC 4110 / 12-98



<i>General Information</i> .....	9
<i>Safety Information</i> .....	9
<i>Preparation</i> .....	10 - 11
<i>Controls</i> .....	12 - 14
<i>Operating The System</i> .....	14 - 16
<i>CD</i> .....	16 - 18
<i>Tuner</i> .....	19 - 20
<i>Tape</i> .....	20 - 21
<i>CDR/AUX</i> .....	22
<i>Recording</i> .....	22 - 23
<i>Clock</i> .....	24
<i>Timer</i> .....	24 - 25
<i>Sleep</i> .....	25
<i>Maintenance</i> .....	25
<i>Specifications</i> .....	26
<i>Troubleshooting</i> .....	27

## General Information

- **The typeplate (which contains the serial number) is located at the rear of the system.**
- **Recording is permissible if copyright or other rights of third parties are not infringed.**
- **This device complies with part 15 of the Federal Communications Commission (FCC) rules. Operation is subjected to the following two conditions:**
  - **This device may not cause harmful interference, and**
  - **This device must accept any interference received, including interference that may cause undesired operation.**

## Environmental Information

All unnecessary packaging has been omitted. We have tried to make the packaging easy to separate into three materials: cardboard (box), polystyrene foam (buffer) and polyethylene (bags, protective foam sheet).

Your system consists of materials which can be recycled and reused if disassembled by a specialized company. Please observe the local regulations regarding the disposal of packaging materials, exhausted batteries and old equipment.

## Accessories (Supplied)

- Remote control
- Batteries (two AA size) for remote control
- AM loop antenna
- FM wire antenna
- AC power cord

## Safety Information

- Before operating the system, check that the operating voltage indicated on the typeplate (or the voltage indication beside the voltage selector) of your system is identical with the voltage of your local power supply. If not, please consult your dealer. The typeplate is located at the rear of your system.
- When the system is switched on, do not move it around.
- Place the system on a solid base (e.g. a cabinet).
- Place the system in a location with adequate ventilation to prevent internal heat build-up in your system.
- The system incorporates a built-in safety feature that prevents over heating.
- Do not expose the system to excessive moisture, rain, sand or heat sources.
- Under no circumstances should you repair the system yourself, as this will invalidate the warranty!

- If the system is brought directly from a cold to a warm location, or is placed in a very damp room, moisture may condense on the lens of the CD unit inside the system. Should this occur, the CD player will not operate normally. Leave the power on for about one hour with no disc in the system until normal playback is possible.
- Electrostatic discharge may cause unexpected problems. See whether these problems disappear if you unplug the AC power cord and plug it in again after a few seconds.
- **To disconnect the system from the power supply completely, remove the AC power plug from the wall socket.**

## Rear Connections

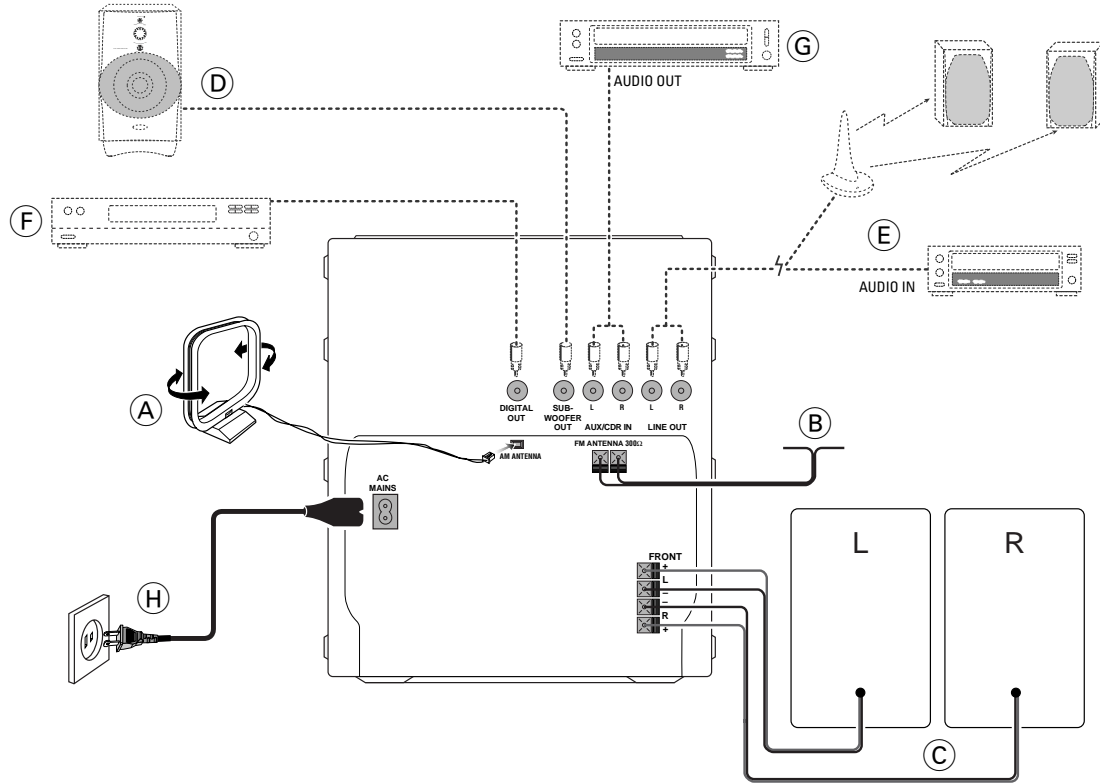

## A AM Loop Antenna Connection

Connect the supplied loop antenna to the AM ANTENNA terminal. Place the AM loop antenna far away from the system and adjust its position for the best reception.

## B FM Wire Antenna Connection

Connect the supplied FM wire antenna to the FM ANTENNA 300 Ω terminal. Adjust the position of the FM antenna for the best reception.

### Outdoor Antenna

For better FM stereo reception, connect an outdoor FM antenna to the FM ANTENNA 300 Ω terminal using a 300 Ω dipole wire.

## C Speakers Connection

- Connect the right speaker to Front terminal R, with the colored wire to + and the black wire to -.
- Connect the left speaker to Front terminal L, with the colored wire to + and the black wire to -.
- Clip the stripped portion of the speaker wire as shown.

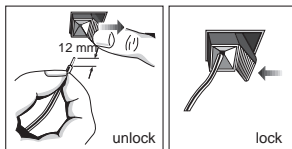

## D Subwoofer Out Connection

Connect the optional active subwoofer to the SUBWOOFER OUT terminal. The subwoofer reproduces just the low bass effect (e.g. explosions, the rumble of spaceships, etc.). Be sure to follow the instructions supplied with the subwoofer.

## E Line Out Connection (wireless ready)

You can connect the audio left and right LINE OUT terminals to a optional CD Recorder ANALOGUE IN terminals. This allows you to record in an analogue format.

You can also install additional optional front active speakers away from the system (e.g. in another room) to reduce the inconvenience of running long speaker wires across rooms. You can place as many remote speakers as you like provided they operate at the same radio frequency. Connect the wireless radio frequency transmitter to the LINE OUT terminals. Place the active speakers at your preferred location. Be sure to follow the instructions supplied with the active speakers.

### Note:

- Availability of a wireless transmitter and its peripherals is subjected to the approval of local authorities. Please check with your local safety or approving authority.

## F Digital Out Connection

You can record the digital sound from the CD, through this output, on any audio equipment with digital input (e.g. CD Recorder, Digital Audio Tape (DAT) deck, Digital to Analog Converter and Digital Signal Processor).

Connect one end of the cinch cable (not supplied) to the DIGITAL OUT socket and the other end to the audio equipment with digital input. When connecting the cinch cable, make sure it is fully inserted.

## G Connecting other equipment to your system

You can connect the audio left and right OUT terminals of a TV, VCR, Laser Disc player, DVD player or CD-Recorder to the AUX/CDR IN terminals at the rear of the system.

## H AC Power Supply

After all other connections have been made, connect the AC power cord to the system and to the wall outlet.

## Inserting batteries into the Remote Control

- Insert the batteries (Type R06 or AA) into the remote control as shown in the battery compartment.

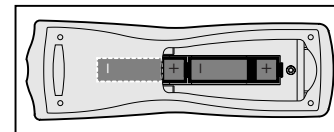

- To avoid damage from possible battery leakage, remove dead batteries or batteries that will not be used for a long time. For replacement, use type R06 or AA batteries.

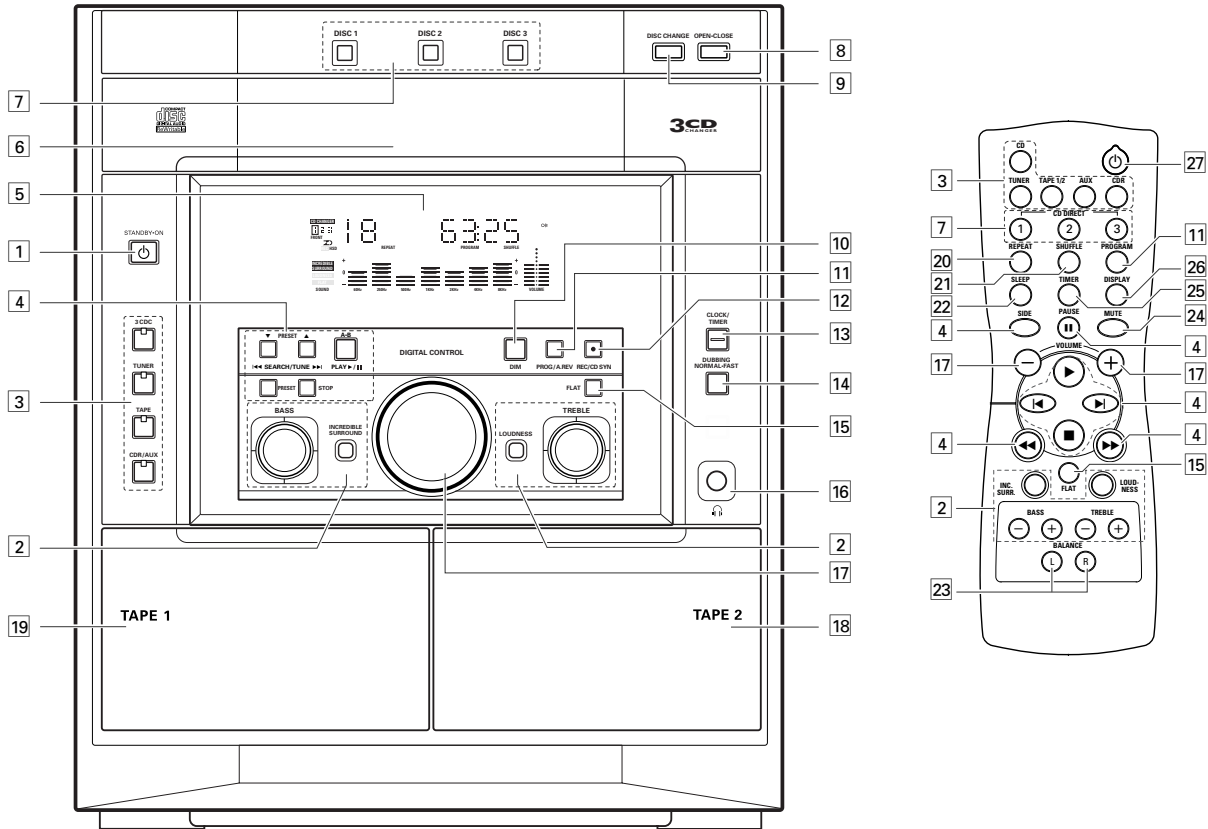

## Controls on the system and remote control

### 1 **STANDBY•ON**

- to switch the system on or to standby mode.
- to use for EASY SET.

### 2 **DIGITAL CONTROL** – to select the desired digital sound effect :

- **INCREDIBLE SURROUND**  
to switch on or off the surround sound effect.
- **BASS + / –**  
to adjust the Bass level.
- **TREBLE + / –**  
to adjust the Treble level.
- **LOUDNESS**

- to switch on or off the loudness sound effect at low volume level.

### 3 **SOURCE** – to select the following: **3 CDC**

- to select CD mode. When CD playback is stopped, press to select the disc tray 1, 2 or 3.

### **TUNER**

- to select Tuner mode. When in Tuner mode, press to select the waveband: FM or AM.

### **TAPE**

- to select Tape mode. When tape playback is stopped, press to select either tape deck 1 or 2.

### **CDR / AUX**

- to select sound from an external source (e.g. TV, VCR, Laser Disc player, DVD player or CD Recorder). When in Aux mode, press to select either AUX/DVD or CDRW.

### 4 **MODE SELECTION SEARCH / TUNE** ◀◀ ▶▶ | (PRESET ▼ ▲ )

- for CD ..... to search backward/forward.  
..... to skip to the beginning of the current, previous, or next track (*press the button for less than 0.5 seconds*).

- for TUNER ..... (if PRESET mode is OFF) to tune to a lower or higher radio frequency.

- ..... (if PRESET mode is ON) to select a preset station in memory.
- for TAPE ..... to rewind or fast forward a tape.

### **PLAY ▶ / II (A•B)**

- for CD ..... to start or interrupt playback.

- for TAPE ..... to start playback.
- ..... SIDE : when playing in Tape 2 mode, to change side.

### **PRESET**

- to switch on or off the PRESET mode.

### **STOP ■**

- for CD ..... to stop CD playback or to clear a program.
- for TUNER ..... to stop programming.
- for TAPE ..... to stop playback or recording.
- DEMO ..... (*on the system only*) to start or stop demonstration mode.

### 5 **DISPLAY SCREEN**

- to view the current setting of the system.

### 6 **CD CAROUSEL TRAY**

- 7 **DISC 1 / DISC 2 / DISC 3**  
– to select a CD tray for playback.

### 8 **OPEN•CLOSE**

- to open or close the CD carousel.

### 9 **DISC CHANGE**



- to change CD(s).

### 10 **DIM**

- to select 4 different DIM mode on the display screen, DIM 1, DIM 2, DIM 3 or DIM OFF.

- to reset the tape counter in tape mode only (*press the button for more than 2 seconds*).

### 11 **PROG / A. REV (PROGRAM / AUTO REVERSE)**

- for CD ..... to program CD tracks.
- for TUNER ..... to program preset radio stations.
- for TAPE ..... to select the desired play modes (  /  /  ) in tape deck 2 only.

### 12 **REC / CD SYN (RECORD / CD SYNCHRO)**

- to start recording or to synchronize the CD recording on tape deck 2.

### 13 **CLOCK/TIMER**

- to view the clock, set the clock or set the timer.

### 14 **DUBBING NORMAL•FAST**

- to dub a tape in normal or fast speed.

### 15 **FLAT**

- to switch on or off the digital sound control setting.

### 16

- to connect headphones.

### 17 **VOLUME**

- to adjust the volume.

### 18 **TAPE DECK 2**

### 19 **TAPE DECK 1**

### 20 **REPEAT**

- to repeat a CD track, a disc, or all the available discs.

### 21 **SHUFFLE**

- to play all the available discs and their tracks in random order.

### 22 **SLEEP**

- to switch the system to standby mode at a selected time period.

### 23 **BALANCE L/R**

- to balance the sound level of the Front Left and Right speakers.

### 24 **MUTE**

- to switch off the sound temporarily.

- 25 **TIMER**
  - to switch on or off timer.
- 26 **DISPLAY** (not functional for this model)
- 27 
  - to switch the system to standby mode.

**Notes for remote control:**

- First select the source you wish to control by pressing one of the source select keys on the remote control (e.g. CD, TUNER, TAPE 1/2 or AUX).
- Then select the desired function (▶, ◀, ▶|, etc.).

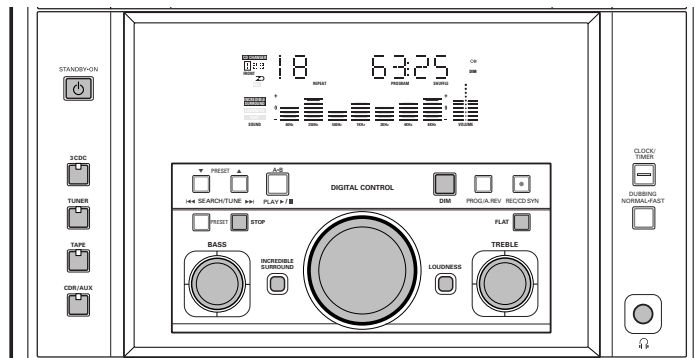

**Important:**  
**Before you operate the system, complete the preparation procedures.**

### Demonstration mode

The system has a demonstration mode that shows the various features offered by the system. **When the system is switched on for the first time, the demonstration mode will start automatically.**

**Notes:**

- During the demonstration, if you press any source (or standby-on) button, the system will switch to the respective mode (or standby).
- When the system is switched to standby mode, the demonstration will resume five seconds later.

### To stop the demonstration mode

- Press and hold **STOP** (on the system only) for **five seconds** when the system is in demonstration mode.
  - The demonstration will stop.
  - "DEMO OFF" is displayed.
  - The system will switch to standby mode.

**Note:**

- Even though the AC power cord is removed from and reconnected to the wall socket, the demonstration will remain off until it is switched on again.

### To start the demonstration mode

- Press and hold **STOP** (on the system only) for **five seconds** when the system is in standby mode.
  - The demonstration will begin.

## Easy Set

EASY SET allows you to store all available radio stations automatically.

- 1 Press and hold **STANDBY•ON** (on the system only) for **five seconds**; when the system is in standby or demonstration mode.
  - "EASY SET" will be displayed, and followed by "TUNER" and then "AUTO".
  - EASY SET will start searching for all radio on FM band and then followed by radio stations on AM band.
  - All available radio stations with sufficient signal strength will be stored. Up to 40 presets may be stored.

### Notes:

- EASY SET will start with the FM band, if there are still presets available, the system will continue to store the AM band.
- When EASY SET is used, all previously stored radio stations will be replaced.
- The last preset radio station will appear on the display when EASY SET is completed.

## Switching the system ON

- Press **STANDBY•ON** (on the system only), **3 CDC, TUNER, TAPE** or **CDR/AUX**.

You can also switch on the system by pressing any one of the CD DIRECT PLAY buttons.

## Switching the system to standby mode

- Press **STANDBY•ON** again or  on the remote control.
  - The system will switch to standby mode.

## Selecting the Source

- Press the respective source selection button: **3 CDC, TUNER, TAPE** or **CDR/AUX**.
  - The display indicates the selected source.

### Note:

- For an external source, make sure you have connected the audio left and right OUT terminals of the external equipment (TV, VCR, Laser Disc player, DVD player or CD Recorder) to the AUX/CDR IN terminals.

## Dim Mode

This feature allows you to select 4 different modes for display brightness.

- Press **DIM** to select the desired screen display brightness: DIM 1, DIM 2, DIM 3 or DIM OFF.
  - The **DIM** display lights up.
  - "DIM 1", "DIM 2", "DIM 3" or "DIM OFF" will be displayed depending on the mode selected.

## Volume Adjustment

Adjust VOLUME to increase or decrease the sound level.

## For Personal Listening

Connect the headphones plug to the  socket at the front of the system. The speakers will be muted.

## MUTE (on remote control only)

This feature allows you to temporarily switch off the sound without switching off the system when you require a moment of silence.

- Press **MUTE** on the remote control to switch off the sound.
  - "MUTE" will be displayed.
- Press **MUTE** again on the remote control or increase the VOLUME level to switch on the sound.

## BALANCE L/R (on remote control only)

Adjust the sound balance of the left and right speakers.

- Press **BALANCE L/R** on the remote control to adjust the sound of the front Left or Right speaker respectively.
  - The display will show "LEFT X", "BALANCED" or "RIGHT X".

### Note:

- "X" denotes the sound level.

## Digital Control

The Digital Control feature enables you to adjust the system to suit your type of music.

## INCREDIBLE SURROUND

Normal stereo sound is determined by the distance between the front speakers. When Incredible Surround is switched on, it magnifies the virtual distance between the front speakers for an incredibly wide, enveloping, stereo effect.

- Press **INCREDIBLE SURROUND** to switch on.
  - The **INCREDIBLE SURROUND** display lights up.
  - "INCREDIBLE SURROUND ON" will be displayed.

## To switch off Incredible Surround

- Press **INCREDIBLE SURROUND** again.
  - The **INCREDIBLE SURROUND** display is switched off.
  - "INCREDIBLE SURROUND OFF" will be displayed.

## BASS/TREBLE

There are 7 different BASS/TREBLE levels available for selection.

- Rotate the **BASS** or **TREBLE** to select the desired bass or treble level respectively.
  - The BASS/TREBLE level will increase or decrease between level +3 and -3.
  - If BASS is selected, the display will show either "BASS +X" or "-X".
  - If TREBLE is selected, the display will show either "TREBLE +X" or "-X".

Note:

- "X" denotes the sound level.

## LOUDNESS

Special sound effect that provides some kind of bass, treble accentuation effect specially for low volume level. It can be switched on additionally to all sound settings.

- Press **LOUDNESS** to switch on.
  - The **LOUDNESS** display lights up.
  - "LOUDNESS ON" will be displayed.

### To switch off Loudness sound effect

- Press **LOUDNESS** again.
  - The **LOUDNESS** display is switched off.
  - "LOUDNESS OFF" will be displayed.

## Flat

This feature allows you to temporarily switch off all the DIGITAL CONTROL setting (e.g. Bass, Treble, Incredible Surround, etc.).

- Press **FLAT** to switch off the digital control setting.
  - The **FLAT** display lights up.
  - "FLAT ON" will be displayed.
- Press **FLAT** again to restore the previous setting.
  - The **FLAT** display is switched off.
  - "FLAT OFF" will be displayed.

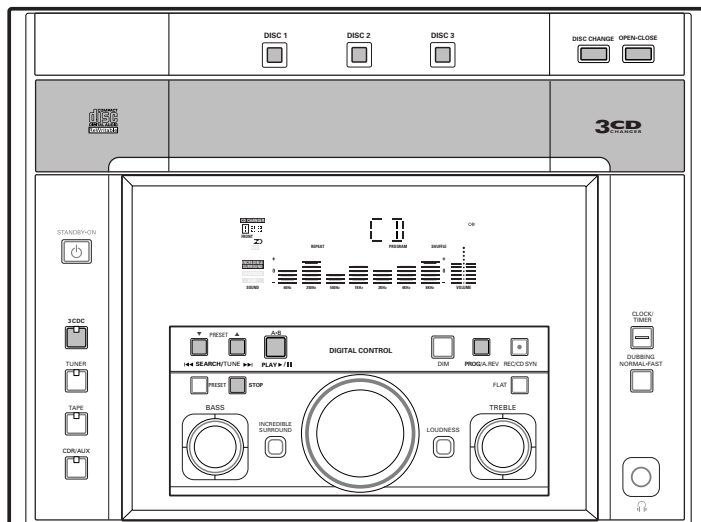

### Warning!

- 1) **This system is designed for conventional CDs. Do not use any accessories such as disc stabilizer rings or CD treatment sheets, etc., which may damage the CD mechanism.**
- 2) **Do not load more than one disc into each tray.**
- 3) **When the CD changer is loaded with CDs, do not turn over or shake the system. This may jam the changer.**

**You may load three discs in the CD changer for continuous playback without interruption.**

### Disc for playback

This system can playback all audio CD, finalized audio CD-Recordable and finalized audio CD-Rewritable format discs.





## Loading the CD Changer

- 1 Press **3 CDC** to select CD mode.
- 2 Press **OPEN•CLOSE**.  
→ The CD carousel slides out.
- 3 Load a CD with the printed side up in the right tray.
  - You can load another disc in the left tray.
  - To load the third disc, press the **DISC CHANGE** button.  
→ The CD carousel will rotate until the empty tray is ready for loading.
- 4 Press **OPEN•CLOSE** to close the CD carousel.  
→ The total number of tracks and the playing time of the last selected disc appear on the display.

### Note:

- To ensure good system performance, wait until the CD changer completely reads the disc(s) before proceeding.

## CD Direct Play

You can play a CD directly by pressing the **DISC 1**, **DISC 2** or **DISC 3** button. The CD player will stop at the end of playback of the selected disc.

- A lit button indicates that a disc is loaded in the disc tray.

## Playing a CD

- 1 Press **PLAY ▶** to start playback.  
→ The disc tray, track number and elapsed playing time of the current track appear on the display.
  - To interrupt playback, press **II**.  
→ The playing time flashes.
  - To resume playback, press **PLAY ▶** again.
- 2 To stop playback, press **STOP**.

### Note:

- All the available discs will play once, then stop.

## Disc Change

You can change the outer two discs while the third inner disc is stopped or is playing.

- 1 Press **DISC CHANGE**.  
→ The CD carousel slides out.
- 2 Replace the discs in the left and right disc trays.
  - If you press **DISC CHANGE** again during playback, the CD will stop playing.  
→ The CD carousel will rotate until the inner tray is rotated out and is ready for loading.
- 3 Press **OPEN•CLOSE** to close the CD compartment.

## Selecting a desired track

### Selecting a desired track when playback is stopped

- 1 Press **◀◀** or **▶▶** (or **◀** / **▶** on the remote control) until the desired track appears on the display.
- 2 Press **PLAY ▶** to start playback.  
→ The selected track number and elapsed playing time appear on the display.

### Selecting a desired track during playback

- Press **◀◀** or **▶▶** (less than 0.5 seconds) until the desired track appears on the display.  
→ The selected track number and elapsed playing time appear on the display.
- If you press **◀◀** (less than 0.5 seconds) it will skip to the beginning of the current track and play the track again.

## Searching for a particular passage during playback

- Press and hold **SEARCH ◀◀** or **▶▶** (or **◀** / **▶** on the remote control) until the desired passage is located.  
→ The volume will be reduced.
- Play returns to normal when **SEARCH ◀◀** or **▶▶** is released.

## Programming Tracks

Programming tracks of a loaded CD is possible when playback is stopped. The display will indicate the total tracks stored in the program. Up to 40 tracks can be stored in the memory in any order. When 40 tracks are stored and you attempt to store another track, the display will show "FULL".

- 1 Load the desired discs in the disc trays.
- 2 Press **PROGRAM** to start programming.  
→ The **PROGRAM** flag starts flashing.  
→ It will cancel any previously selected repeat mode.
- 3 Press the **3 CDC** button to select the disc.
- 4 Press **◀◀** or **▶▶** (or **◀** / **▶** on the remote control) to select the desired track.
- 5 Press **PROGRAM** to store the track.
  - Repeat steps **3** to **5** to store other discs and tracks.
- 6 Press **STOP** once to end programming.  
→ The total number of tracks programmed and total playing time appear on the display.

### Notes:

- If the total playing time is more than "99:59" or if one of the programmed tracks has a number greater than 30, then "-- : --" appears on the display instead of the total playing time.

- During programming, if no button is pressed within 20 seconds, the system will exit program mode automatically.

---

## Reviewing the program

Reviewing of the program is possible only when playback is stopped.

- Press **◀◀** or **▶▶** repeatedly to review the programmed tracks.
- Press **STOP** to exit review mode.

---

## Playing the program

- 1 Press **PLAY ▶** to start program playback.
  - "PLAY PROGRAM" appears on the display.
  - The track number and elapsed playing time of the current track will appear on the display.
- If you press **REPEAT** during program playback, the current track or all programmed tracks will be played repeatedly.
  - "TRACK" or "PROGRAM" will be displayed.
  - The **REPEAT** and **PROGRAM** flags will be displayed.
- 2 Press **STOP** to stop program playback.

Notes:

- If you press any of the CD DIRECT PLAY buttons, the system will play the selected disc or track and the stored program will be ignored temporarily. The PROGRAM flag also will disappear temporarily from the display. It will reappear when playback of the selected disc ends.
- REPEAT DISC mode will be cancelled when program playback begins.

---

## Erasing the program (when playback is stopped)

- Press **STOP**.
  - "PROGRAM CLEARED" will be displayed.

Note:

- The program will be erased when the system is disconnected from the power supply or when the CD carousel is opened. If the CD carousel is opened, the tracks belonging to the outer two trays will be erased and the display will show "TRACKS CLEARED".

---

## Shuffle (only on remote control)

In shuffle mode, the system plays all the available discs and their tracks in random order. Shuffle may be used also when tracks are programmed.

### To shuffle all the discs and tracks

- 1 Press **SHUFFLE**.
  - "SHUFFLE" will be displayed.
  - The **SHUFFLE** flag, the disc and the track selected at random appear on the display.
- The discs and the tracks will be played in random order until you press **STOP**.
- If you press **REPEAT** during shuffling, the current track or all available discs will be played repeatedly.
  - "TRACK" or "ALL" will be displayed.
  - The **REPEAT** and **SHUFFLE** flags will be displayed.
- 2 Press **SHUFFLE** again to resume normal playback.
  - The **SHUFFLE** flag disappears from the display.

Note:

- REPEAT DISC mode will be cancelled when shuffle is selected.

---

## Repeat (only on remote control)

You can play the current track, a disc or all available discs repeatedly.

- 1 Press **REPEAT** on the remote control to select the various repeat modes.
  - "TRACK", "DISC", "ALL" or "OFF" will be displayed.
  - The **REPEAT** flag appears on the display.
- The selected track, selected disc or all available discs will now be played repeatedly until you press **STOP**.
- 2 Press **REPEAT** until the "OFF" mode is displayed to resume normal playback.
  - The **REPEAT** flag disappears from the display.

Notes:

- REPEAT DISC mode is not available during program play or shuffling mode.
- You can also repeat shuffling a program.
  - "REPEAT TRACK" or "REPEAT PROGRAM" will be displayed.
  - The **REPEAT**, **PROGRAM** and **SHUFFLE** flags appear on the display.

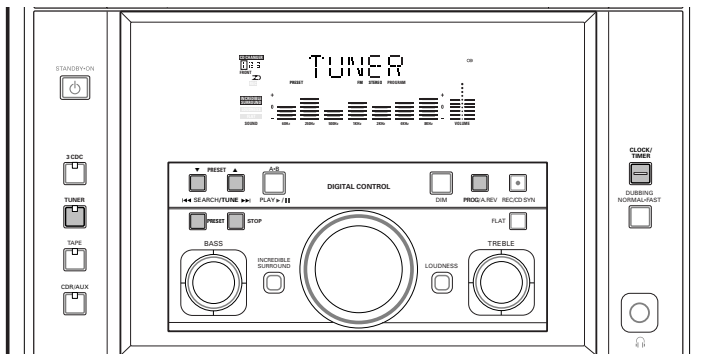
**Note:**

- For 'EASY SET' feature, please refer to page 15.

**Tuning to radio stations**

- 1 Press **TUNER** to select TUNER mode.  
→ "TUNER" will be displayed.  
A few seconds later, the current radio frequency will be displayed.
- 2 Press **TUNER** again to select the desired waveband : FM or AM.
- 3 Press **TUNE** |◀◀ or ▶▶| (PRESET mode OFF) (or ◀◀/▶▶ on the remote control) for more than one second, then release.  
→ The display will show "SEARCH" until a radio station with sufficient signal strength is found.

- Repeat this procedure until the desired station is reached.
- To tune to a weak radio station, briefly press **TUNE** |◀◀ or ▶▶| (PRESET mode OFF) repeatedly until the display shows the desired frequency and/or when the best reception has been obtained.

**Note:**

- Before activate TUNING function on the system, make sure that the PRESET mode is switched off .

**Storing Preset Stations**

You can store up to 40 radio stations in the memory. When a preset radio station is selected, the preset number appears next to the frequency on the display.

**Automatic programming**

- 1 Press **TUNER**.
- 2 Press **PROGRAM** for more than one second.  
→ The **PROGRAM** flag starts flashing and "AUTO" will be displayed.  
→ The system will search for every available station in the FM waveband first, then search the AM waveband.  
→ All available radio stations will be stored automatically. The frequency and preset number will be displayed briefly.  
→ The system will stop searching when all the available radio stations are stored or when the memory for 40 preset radio stations is used.  
→ The system will remain tuned to the last stored preset radio station.

**Notes:**

- You can cancel the automatic programming by pressing **PROGRAM** or **STOP** (on the system only).
- If you want to reserve a section of preset numbers, for example preset numbers 1 to 9, select preset 10 before starting automatic programming: only the preset numbers 10 to 40 will be programmed.

**Manual programming**

- 1 Press **TUNER**.
  - 2 Press **TUNER** again to select the desired waveband : FM or AM.
  - 3 Press **PROGRAM** for less than one second.  
→ The **PROGRAM** flag starts flashing.  
→ The next available preset number will be displayed for selection.
  - 4 Press **TUNE** |◀◀ or ▶▶| (PRESET mode OFF) (or ◀◀/▶▶ on the remote control) to tune to the desired frequency.
    - If you wish to store the radio station to another preset number, first select PRESET mode, then press **PRESET** ▼ or ▲ to select the desired preset number.  
→ The **PRESET** flag will be displayed.
  - 5 Press **PROGRAM** again.  
→ The **PROGRAM** flag disappears and the radio station will be stored.
- Repeat the **steps 3 to 5** to store other preset radio stations.

**Notes:**

- When 40 radio stations are stored and you attempt to store another radio station, the display will show "FULL". If you want to change an existing preset number, repeat steps 3 – 5.
- You can cancel manual programming by pressing **STOP** (on the system only).
- During programming, if no button is pressed within 20 seconds, the system will exit program mode automatically.

- When in programming mode, the PRESET mode will automatically be activated.

### Tuning to Preset Radio Stations

- 1 Press **PRESET** to switch on the PRESET mode.  
→ The **PRESET** flag will be displayed.
- 2 Press **PRESET** ▼ or ▲ (or ◀ / ▶) on the remote control) to select the desired preset number.  
→ The preset number, radio frequency, and waveband appear on the display.

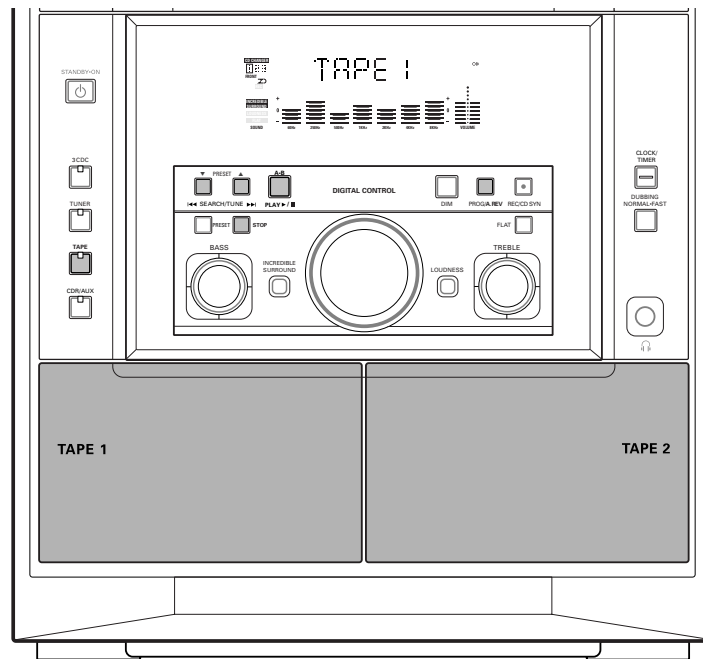

### Loading a tape

- Press on the tape deck to open the tape deck door.
- Load the tape with the open side downward and the full spool to the left.
- Close the tape deck door.

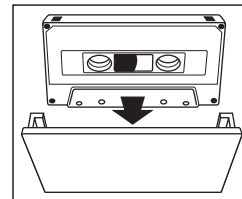

## Tape Playback

1 Press **TAPE** to select TAPE mode.  
→ "TAPE 1" or "TAPE 2" will be displayed.

• Press **TAPE** again to select either tape deck 1 or tape deck 2.

2 Load the tape into the desired tape deck.

3 Press **PLAY** ► to start playback.

**3a** (For Tape Deck 2 only)

Press **A•B** (SIDE) to switch playback between side A and B.

→ The **BACK** or **FRONT** flag appears on the display, depending on the side selected.

**3b** (For Tape Deck 2 only)

Press **A. REV** to select the different type of playback mode (see *auto reverse playback*).

4 Press **STOP** to end playback.

Note:

– To change side before playback begins, use the **SIDE** button on the remote control.

## Auto Reverse Playback *(only on tape deck 2)*

• Press **A. REV** to select the different playback modes.

⏮ ..... to record or playback on one side of the tape. The tape stops at the end of one side.

⏪ ..... to record or playback on both sides of the tape. The tape then stops.

⏩ ..... to playback continuously on both sides of the tape up to a maximum of 10 times per side unless you press **STOP**.

## Rewind/Fast Forward

### When playback is stopped

1 You can rewind or fast forward the tape by pressing **⏮** or **⏩** (or **⏪**/**⏩** on the remote control) respectively.

→ "TA 1 XXX" or "TA 2 XXX" will be displayed depending on which button is pressed.

→ The tape will stop automatically at the end of the rewinding or fast forwarding.

2 Press **STOP** to stop rewinding or fast forwarding.

## During playback

• Press and hold **⏮** or **⏩** (or **⏪**/**⏩** on the remote control) until the desired passage is located.

→ During searching, the sound is reduced to a low volume.

→ When you release **⏮** or **⏩**, the tape continues playing.

Notes:

– "000" denotes the tape counter number. It will automatically set to zero after detecting end of tape or changing tape play direction on TAPE 2. To reset the tape counter number to zero during playback, press the **DIM** button for more than 2 seconds.

– During rewinding or fast forwarding of a tape, it is also possible to select another source (e.g. 3 CDC, TUNER or CDR/AUX).

– Before use, check and tighten slack tape with a pencil. Slack tape may get jammed or may burst in the mechanism.

– C-120 tape is extremely thin and is easily deformed or damaged. It is not recommended for use in this system.

– Store the tapes at room temperature and do not put them too close to a magnetic field (for example, a transformer, TV, or speaker).

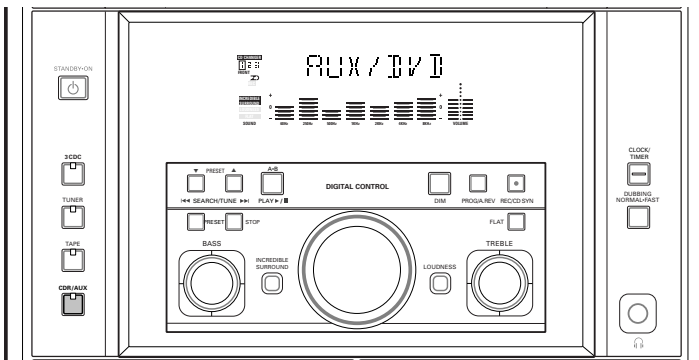

## Selecting External Equipment

If you have connected the audio out terminals of the external equipment (TV, VCR, Laser Disc player, DVD player, or CD Recorder) to the AUX/CDR IN terminals, you can hear the enhanced sound from the system.

- Press **CDR/AUX** to select AUX-DVD mode.  
→ "AUX/DVD" will be displayed.
- Press **CDR/AUX** again to select the CDRW mode.  
→ "CDRW" will be displayed.

### Notes:

- There are two external modes:
  - i. the normal AUX/DVD mode.
  - ii. the CDRW mode; where the **LINE OUT** of this mini system is muted. You will not be able to record or listen to the sound from the **LINE OUT**.
- You are advised not to listen to and record from the same source simultaneously.
- All the sound control features (e.g. Incredible Surround, Bass/Treble, etc.) are available for selection.

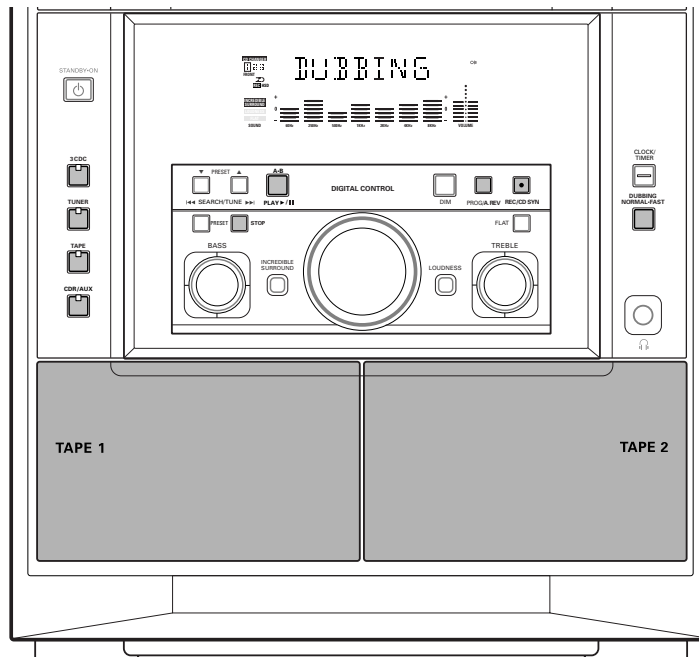

**Notes:**

- For recording, use only tape of IEC type I (normal tape) or IEC type II (CrO<sub>2</sub>).
- The tape is secured at both ends with leader tape. At the beginning and end of tape, nothing will be recorded for six to seven seconds.
- The recording level is set automatically, regardless of the position of Volume, Incredible Surround or Bass/Treble.
- To prevent accidental recording, break out the tab on the left shoulder of the tape side you want to protect.
- If "CHECK TAPE" is displayed, the protection tab has been broken. Put a piece of clear adhesive tape over the opening. Do not cover the CrO<sub>2</sub> tape detection hole when covering the tab opening.

**One Touch Recording**

- For One Touch Recording, as soon as you press **REC**, the current source (3 CDC, TUNER or CDR/AUX) will be recorded on tape deck 2

- 1 Load a blank tape in tape deck 2.
- 2 Press **REC** to start recording.  
→ The **REC** flag starts flashing.
- 3 Press **STOP** to stop recording.

**Note:**



- When you press **RECORD** while in **TAPE** mode, "SELECT SOURCE" will be displayed. One Touch Recording is not possible in **TAPE** mode.

**Recording from other sources**

(only on tape deck 2)

- 1 Press **TAPE** to select tape deck 2.
- 2 Load a blank tape into tape deck 2 with the open side downward.
- 3 Press **SIDE** on remote control to select the recording side.  
→ The **BACK** or **FRONT** flag will be displayed, depending on the side selected.
- 4 Press **3 CDC, TUNER** or **CDR/AUX**.  
• Start playback of the selected source.
- 5 Press **REC** to start recording.  
→ The **REC** flag starts flashing.
- 6 Press **STOP** to stop recording.

**Notes:**

- Only  or  mode is available during recording.
- During recording, it is not possible to listen to another source.

**Dubbing tapes** (from tape deck 1 to tape deck 2)

- 1 Press **TAPE** to select tape deck 2.
- 2 Load the prerecorded tape into tape deck 1 and a blank tape into tape deck 2.  
• Make sure the tape in tape deck 1 has its full spool to the left.
- 3 (For Tape Deck 2 only)  
Press **SIDE** on the remote control to select the recording side.



- 4 Press **DUBBING NORMAL•FAST** **once** for normal speed dubbing or **twice** (within 2 seconds) for high speed dubbing.  
→ "NORMAL" (normal speed) or "FAST" (high speed) will be displayed, followed by "DUBBING".  
→ The **HSD** flag appears on the display during high speed dubbing.
- Dubbing will start immediately.  
→ The **REC** flag starts flashing.
- 5 Press **STOP** to stop dubbing.

**Notes:**

- Only  mode is available during dubbing.
- At the end of side A, flip the tapes to side B and repeat the procedure.
- Dubbing of tapes is only possible from tape deck 1 to tape deck 2.
- To ensure good dubbing, use tapes of the same length.
- During high speed dubbing in Tape mode, the sound is reduced to a low volume.
- You can listen to another source while dubbing.

**CD Synchro Start Recording**

During CD synchro start recording,

- Do not fast forward/rewind your tape in tape deck 1.
  - Do not listen to another source.
- 1 Press **TAPE** to select tape deck 2.
  - Load a blank tape into tape deck 2 with the open side downward.
  - 2 Press **SIDE** on remote control to select the recording side.
  - 3 Press **A. REV** to select the playback mode ( or ).
  - 4 Press **3 CDC**.  
• You can program the tracks in the order you want them to be recorded (see Programming Tracks). If you do not, the tracks are recorded according to the order on the selected disc.
  - 5 Press **CD SYN** to start recording.  
→ The **REC** flag starts flashing.
  - 6 Press **STOP** to stop recording CD playback.

**Digital Recording via Digital Out**

For CD digital recording, please refer to the Instructions Manual of the CD Recorder, digital audio equipment, etc.

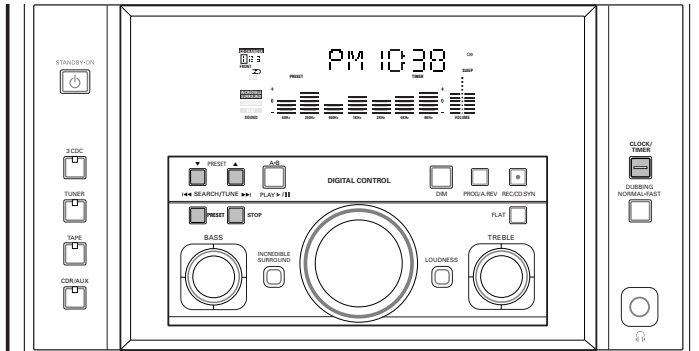

## Viewing the Clock

You can view the clock (if it is set) while the system is in standby mode or any source mode. It will be displayed for about seven seconds.

- Press **CLOCK/TIMER** briefly (*on the system only*).
  - "PM 10:38" (the current time) will be displayed.
  - "- : - : -" will be displayed if the clock is not set.

## Setting the Clock

The clock is set in 12-hour mode, e.g. "PM 12:00" or "PM 12:00". Before setting the clock, you must be in the View Clock mode.

- Press **CLOCK/TIMER** to select clock mode.
    - "PM 12:00" or the current time starts flashing.
  - Press **◀◀** or **▶▶** to set the hour (*PRESET mode OFF*).
  - Press **◀◀** or **▶▶** to set the minute (*PRESET mode ON*).
  - Press **CLOCK/TIMER** again to store the setting.
    - The clock starts.
- To exit without storing the setting, press **STOP** on the system.

### Notes:

- During clock setting, if no button is pressed within 90 seconds, the system will exit clock setting mode automatically.
- When a power interruption occurs, the clock setting is erased.

## Setting the Timer

- The system can switch on to CD, TUNER, or TAPE 2 mode automatically at a preset time. It can serve as an alarm to wake you up.
- Before setting the timer, make sure the clock is set correctly.
- The timer will always be switched on once it is set.
- The volume of the timer will start to increase from the minimum level until the volume level before the set is switched to standby mode.**

- Press and hold **CLOCK/TIMER** for more than 2 seconds to select timer mode.
  - "AM 12:00" or the last set timer starts flashing. The **TIMER** flag flashes.
  - The last selected source is lit while other available sources are flashing.
- Press **3 CDC, TUNER** or **TAPE** to select the desired source.
  - Before selecting CD or TAPE, make sure a CD or tape is loaded in the CD tray or tape deck 2.
- Press **◀◀** or **▶▶** to set the hour for the timer to start (*PRESET mode OFF*).
- Press **◀◀** or **▶▶** to set the minute for the timer to start (*PRESET mode ON*).

- Press **CLOCK/TIMER** to store the start time.
  - The timer is now set.
  - The **TIMER** flag remains on the display.
- To exit without storing the setting, press **STOP**.
- At the preset time, the timer will be activated.
  - The selected source will be played.

### Notes:

- During timer setting, if no button is pressed within 90 seconds, the system will exit timer setting mode automatically.
- If the source selected is TUNER, the last tuned frequency will be switched on.
- If the source selected is CD, playback will begin with the first track of the last selected disc. If the CD trays are empty, the TUNER will be selected instead.
- If the source selected is TAPE, and if the preset time is reached during high speed dubbing, the TUNER will be selected instead.
- If the recording is active, the timer will be cancelled.



## To switch off the **TIMER**

- 1 Press **CLOCK/TIMER** for more than 2 seconds (or **TIMER** on the remote control).
- 2 Press **STOP** on the system to cancel the timer.
  - The timer is now switched off.
  - The display will show "TIMER OFF" and the **TIMER** flag disappears.

## To start the **TIMER** again (for the same preset time and source)

- 1 Press **CLOCK/TIMER** for more than 2 seconds (or **TIMER** on the remote control).
- 2 Press **CLOCK/TIMER** again to store the start time.
  - The timer is now switched on.
  - The **TIMER** flag appears on the display.

## Sleep (only on remote control)

This feature allows you to select a length of time after which the system will switch to the standby mode automatically.

- Press **SLEEP** on the remote control repeatedly to select a period of time.
  - The selections are as follows (time in minutes):  
60 → 45 → 30 → 15 → OFF → 60 ...
  - "SLEEP XX" or "OFF" will be displayed. "XX" is the time in minutes.
- When you reach the desired length of time, stop pressing the **SLEEP** button.
  - After this amount of time passes, the system will switch to the standby mode.

## To switch off the sleep timer

- Press **SLEEP** repeatedly until "OFF" is displayed, or press the **STANDBY•ON** button.

## Maintenance

### Cleaning the Cabinet

- Use a soft cloth slightly moistened with a mild detergent solution. Do not use a solution containing alcohol, spirits, ammonia or abrasives.

### Cleaning Discs

- When a disc becomes dirty, clean it with a cleaning cloth. Wipe the disc from the center out.
- Do not use solvents such as benzine, thinner, commercially available cleaners, or antistatic spray intended for analog records.



### Cleaning the CD lens

- After prolonged use, dirt or dust may accumulate at the CD lens. To ensure good playback quality, clean the CD lens with Philips CD Lens Cleaner or any commercially available cleaner. Follow the instructions supplied with cleaner.

### Cleaning the Heads and the Tape Paths

- To ensure good recording and playback quality, clean the heads, the capstan(s), and pressure roller(s) after every 50 hours of tape operation.
- Use a cotton swab slightly moistened with cleaning fluid or alcohol.

- You can also clean the heads by playing a cleaning tape once.

### Demagnetizing the heads

- Use a demagnetizing tape available at your dealer.

## Specifications

### AMPLIFIER

Output power .....	2 x 50 W FTC <sup>(1)</sup>
Signal-to-noise ratio .....	≥ 75 dBA (IEC)
Frequency response .....	40 – 20,000 Hz, ± 3 dB
Input sensitivity	
AUX/CDR In .....	560 mV
Output	
Speakers .....	≥ 6 Ω
Headphones .....	32 Ω – 1000 Ω
Subwoofer Out .....	1.5 V ±2dB, > 22,000 Ω
Line Out .....	500 mV ±2dB, > 22,000 Ω
Digital Out .....	IEC 958, 44.1 kHz

(1) (6 Ω, 60 Hz – 12.5 kHz, 10% THD)

### CD PLAYER

Number of programmable tracks .....	40
Frequency response .....	40 – 20,000 Hz
Signal-to-noise ratio .....	≥ 76 dBA
Channel separation .....	≥ 79 dB (1 kHz)
Total harmonic distortion .....	< 0.02% (1 kHz)

### TUNER

FM wave range .....	87.5 – 108 MHz
AM wave range .....	530 – 1700 kHz
Number of presets .....	40
Antenna	
FM .....	300 Ω dipole wire
AM .....	Loop antenna

### TAPE DECK

Frequency response	
Chrome tape (type II) .....	60 – 15,000 Hz (5 dB)
Normal tape (type I) .....	60 – 15,000 Hz (5 dB)
Signal-to-noise ratio	
Chrome tape (type II) .....	≥ 50 dBA
Normal tape (type I) .....	≥ 47 dBA
Wow and flutter .....	≤ 0.4% DIN

### SPEAKERS

System .....	shielded 3-way; 1 G-bass port
Impedance .....	6 Ω
Woofer .....	1 x 6.5"
Tweeter .....	1 x 2.5"
Polydome Tweeter .....	1 x 1"
Dimensions (w x h x d) .....	260 x 325 x 310 (mm)
Weight .....	4.89 kg each

### GENERAL INFORMATION

Material/finish .....	Polystyrene/Metal
AC Power .....	120 V / 60 Hz
Power Consumption	
Active .....	70 W
Standby .....	< 15 W
Dimensions (w x h x d) .....	265 x 310 x 363 mm
Weight (without speakers) .....	7.2 kg

**Subject to modification**

**Warning! Under no circumstances you should try to repair the set yourself as this will invalidate the guarantee. Do not open the set as there is a risk of electric shock.**

- If a fault occurs, check the points listed below before taking the system for repair.
- Should any problems persist after you have made these checks, consult your nearest dealer or service center.

## CD Player Operation

**"NO DISC" is displayed.**

- The disc is inserted upside down.  
→ *Place CD with printed side up.*
- Moisture condensation at the lens.  
→ *Wait until lens has adjusted to normal room temperature.*
- There is no disc in the CD tray.  
→ *Insert a CD.*
- The CD is dirty, badly scratched or warped.  
→ *Clean or replace the CD.*
- The CD lens is dirty or dusty.  
→ *See section under Maintenance.*

**"DISC NOT FINALIZED" is displayed.**

- The CD-RW or CD-R disc is not properly recorded for the use of a standard CD player.  
→ *Read the instruction booklet of your CD-Rewritable or CD-Recorder on how to finalize a recording.*
- The CD is badly scratched or dirty.  
→ *Replace or clean CD.*

## Radio Reception

**Poor radio reception.**

- The signal is too weak.  
→ *Adjust the antenna.*  
→ *Connect an external antenna for better reception.*
- The TV or VCR is too close to the stereo system.  
→ *Separate the stereo system from the TV or VCR.*

## Tape Deck Operation

**"RECORDING ACTIVE" is displayed.**

- A recording is in progress.  
→ *Stop the recording or wait until it is finished.*

**"CHANGE TO TAPE" is displayed.**

- Tape dubbing is only possible in tape mode.  
→ *Switch to tape mode by pressing TAPE.*

**Recording or playback cannot be made or there is a decrease in audio level.**

- Dirty tape heads, capstans or pressure rollers.  
→ *See section on tape deck maintenance.*
- Magnetic build-up in the record/playback head.  
→ *Use demagnetizing tape.*

## General

**System does not react when any button is pressed.**

- Electrostatic discharge.  
→ *Press STANDBY•ON to switch the system off. Remove the AC power plug from the wall outlet, then reconnect the power plug and switch on the system again.*

**No or poor sound.**

- Volume is not turned up.  
→ *Adjust VOLUME.*
- The headphones are connected.  
→ *Disconnect the headphones.*
- Speakers are not connected or are connected wrongly.  
→ *Check that the speakers are connected correctly.*  
→ *Make sure the stripped speaker wire is clamped.*

**Reversed left and right sound.**

- Speakers are connected wrongly.  
→ *Check the speaker connections and location.*

**Lack of bass sound or apparently imprecise physical location of musical instruments.**

- Speakers are connected wrongly.  
→ *Check the speaker connection for proper phasing, colored/black wires to colored/black terminals.*

**Remote control has no effect on the system.**

- Wrong source is selected.  
→ *Select the source (CD, TUNER, etc.) before pressing the function button, (▶, ◀, ►, etc.).*
- The distance to the system is too large.  
→ *Reduce the distance.*
- Batteries are inserted incorrectly.  
→ *Insert the batteries with their polarities (+/- signs) as indicated.*
- Batteries are exhausted.  
→ *Replace the batteries.*

**Timer not working.**

- Clock is not set.  
→ *Set the clock.*
- Timer is not switched on.  
→ *Press CLOCK/TIMER to switch on the timer.*
- Recording is in progress.  
→ *Stop recording.*

**Clock setting is erased.**

- There was a power failure.  
→ *Reset the clock.*

**System displays features automatically; buttons flash continuously.**

- Demonstration mode is switched on.  
→ *Press and hold STOP (on the system only) for five seconds to switch off the demonstration.*

**A howling sound at external source.**

- You hear feedback when you are listening and recording from the same source simultaneously.  
→ *Press CDR/AUX to select CDRW mode.*

## Free Manuals Download Website

<http://myh66.com>

<http://usermanuals.us>

<http://www.somanuals.com>

<http://www.4manuals.cc>

<http://www.manual-lib.com>

<http://www.404manual.com>

<http://www.luxmanual.com>

<http://aubethermostatmanual.com>

Golf course search by state

<http://golfingnear.com>

Email search by domain

<http://emailbydomain.com>

Auto manuals search

<http://auto.somanuals.com>

TV manuals search

<http://tv.somanuals.com>