

51MP392H 51MP392S Rear Projection TV



Thank you for choosing

Need help?

Read your Quick Use Guide for
Owners ~~and first for quick tips~~
that make using your Magnavox
more enjoyable.

If you have read your instructions
and still need assistance,
you may access our online help at
www.usasupport.magnavox.com

or call

1-800-705-2000

**while with your product
(and Model / Serial number)**

Model No: _____
Serial No: _____

Return your Product Registration Card today to get the very most from your purchase.

Registering your model with MAGNAVOX makes you eligible for all of the valuable benefits listed below, so don't miss out. Complete and return your Product Registration Card at once to ensure:

*Proof of Purchase

Returning the enclosed card guarantees that your date of purchase will be on file, so no additional paperwork will be required from you to obtain warranty service.

*Product Safety Notification

By registering your product, you'll receive notification - directly from the manufacturer - in the rare case of a product recall or safety defect.

*Additional Benefits of Product Ownership

Registering your product guarantees that you'll receive all of the privileges to which you're entitled, including special money-saving offers.

MAGNAVOX

Congratulations on your purchase, and welcome to the "family!"

Dear MAGNAVOX product owner:

Thank you for your confidence in MAGNAVOX. You've selected one of the best-built, best-backed products available today. We'll do everything in our power to keep you happy with your purchase for many years to come.

As a member of the MAGNAVOX "family," you're entitled to protection by one of the most comprehensive warranties and outstanding service networks in the industry. What's more, your purchase guarantees you'll receive all the information and special offers for which you qualify, plus easy access to accessories from our convenient home shopping network.

Most importantly, you can count on our uncompromising commitment to your total satisfaction.

All of this is our way of saying welcome - and thanks for investing in a MAGNAVOX product.

P.S. To get the most from your MAGNAVOX purchase, be sure to complete and return your Product Registration Card at once.

Know these **safety** symbols



 This "bolt of lightning" indicates uninsulated material within your unit may cause an electrical shock. For the safety of everyone in your household, please do not remove product covering.

 The "exclamation point" calls attention to features for which you should read the enclosed literature closely to prevent operating and maintenance problems.

CAUTION: To prevent electric shock, match wide blade of plug to wide slot, fully insert.

ATTENTION: Pour éviter les choc électriques, introduire la lame la plus large de la fiche dans la borne correspondante de la prise et pousser jusqu'au fond.

For Customer Use

Enter below the Serial No. which is located on the rear of the cabinet. Retain this information for future reference.

Model No. _____

Serial No. _____

MAGNAVOX

Visit our World Wide Web Site at <http://www.usasupport.magnavox.com>

IMPORTANT SAFETY INSTRUCTIONS

Read before operating equipment

1. Read these instructions.
 2. Keep these instructions.
 3. Heed all warnings.
 4. Follow all instructions.
 5. Do not use this apparatus near water.
 6. Clean only with a dry cloth.
 7. Do not block any of the ventilation openings. Install in accordance with the manufacturers instructions.
 8. Do not install near any heat sources such as radiators, heat registers, stoves, or other apparatus (including amplifiers) that produce heat.
 9. Do not defeat the safety purpose of the polarized or grounding-type plug. A polarized plug has two blades with one wider than the other. A grounding type plug has two blades and third grounding prong. The wide blade or third prong are provided for your safety. When the provided plug does not fit into your outlet, consult an electrician for replacement of the obsolete outlet.
 10. Protect the power cord from being walked on or pinched particularly at plugs, convenience receptacles, and the point where they exit from the apparatus.
 11. Only use attachments/accessories specified by the manufacturer.
 12.  Use only with a cart, stand, tripod, bracket, or table specified by the manufacturer, or sold with the apparatus. When a cart is used, use caution when moving the cart/apparatus combination to avoid injury from tip-over.
 13. Unplug this apparatus during lightning storms or when unused for long periods of time.
 14. Refer all servicing to qualified service personnel. Servicing is required when the apparatus has been damaged in any way, such as power-supply cord or plug is damaged, liquid has been spilled or objects have fallen into apparatus, the apparatus has been exposed to rain or moisture, does not operate normally, or has been dropped.
 15. This product may contain lead and mercury. Disposal of these materials may be regulated due to environmental considerations. For disposal or recycling information, please contact your local authorities or the Electronic Industries Alliance: www.eiae.org
 16. **Damage Requiring Service** - The appliance should be serviced by qualified service personnel when:
 - A. The power supply cord or the plug has been damaged; or
 - B. Objects have fallen, or liquid has been spilled into the appliance; or
 - C. The appliance has been exposed to rain; or
 - D. The appliance does not appear to operate normally or exhibits a marked change in performance; or
 - E. The appliance has been dropped, or the enclosure damaged.
17. **Tilt/Stability** - All televisions must comply with recommended international global safety standards for tilt and stability properties of its cabinet design.
 - Do not compromise these design standards by applying excessive pull force to the front, or top, of the cabinet which could ultimately overturn the product.
 - Also, do not endanger yourself, or children, by placing electronic equipment/toys on the top of the cabinet. Such items could unsuspectingly fall from the top of the set and cause product damage and/or personal injury.
 18. **Wall or Ceiling Mounting** - The appliance should be mounted to a wall or ceiling only as recommended by the manufacturer.
 19. **Power Lines** - An outdoor antenna should be located away from power lines.
 20. **Outdoor Antenna Grounding** - If an outside antenna is connected to the receiver, be sure the antenna system is grounded so as to provide some protection against voltage surges and built up static charges.

Section 810 of the National Electric Code, ANSI/NFPA No. 70-1984, provides information with respect to proper grounding of the mast and supporting structure, grounding of the lead-in wire to an antenna discharge unit, size of grounding connectors, location of antenna-discharge unit, connection to grounding electrodes, and requirements for the grounding electrode. See Figure below.
 21. **Object and Liquid Entry** - Care should be taken so that objects do not fall and liquids are not spilled into the enclosure through openings.
 - a) **Warning:** To reduce the risk of fire or electric shock, this apparatus should not be exposed to rain or moisture and objects filled with liquids, such as vases, should not be placed on this apparatus.
 22. **Battery Usage CAUTION** - To prevent battery leakage that may result in bodily injury, property damage, or damage to the unit:
 - Install all batteries correctly, with + and - aligned as marked on the unit.
 - Do not mix batteries (old and new or carbon and alkaline, etc.).

Note to the CATV system installer: This reminder is provided to call the CATV system installer's attention to Article 820-40 of the NEC that provides guidelines for proper grounding and, in particular, specifies that the cable ground shall be connected to the grounding system of the building, as close to the point of cable entry as practical.

Example of Antenna Grounding as per NEC - National Electric Code

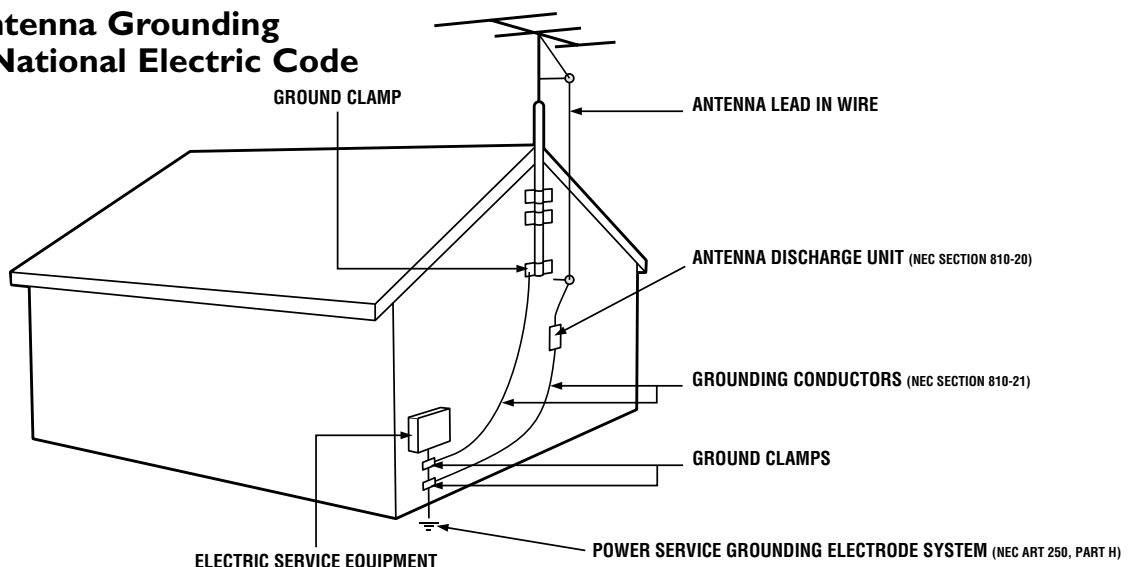

CONTENTS

INTRODUCTION

Welcome/Registration of Your TV	2
Safety/Precautions	2-3
Features	5

CONNECTING ACCESSORY DEVICES TO YOUR TV

Jacks, Cables, and Connectors	6
Panel Overviews: Standard Inputs and Outputs	7
Panel Overviews: High-definition Inputs	8
Connecting a VCR	9
Connecting a VCR and Cable Box	10
Connecting and Using an Audio Hi-fi System with Your TV	11
Connecting a Standard DVD Player	12
Connecting a DVD Player with Progressive-scan Capability	13
Connecting an S-Video Device	14
Connecting an HD Receiver to the HD INPUT-AV 4 Jacks	15
Connecting a Camcorder	16

USING THE REMOTE CONTROL

Using the AV and Source Select Button	17
Using SmartSound™	18
Using SmartPicture™	19
Using Alternate Channel (A/CH)	20

USING THE ONSCREEN SUBMENU PICTURE

Adjusting the Picture Controls	21
Setting the Smart Scan Control	22
Setting the Smart Contrast Control	23

SOUND

Adjusting the Treble, Bass, and Balance Controls	24
Using the AVL (Audio Volume Leveler) Control	25
Selecting the Surround-sound Modes	26
Selecting the Stereo/Mono Sound Mode	27
Selecting the SAP (Second Audio Program) Feature	28
Using the Bass Boost Control	29



FEATURES

The Timer	
Setting the Clock	30
Displaying the Time	31
Setting the Timer's Start Time and Stop Time	32
Selecting the Timer's Channel	33
Setting the Timer's Activate Control	34
AutoLock™	
Understanding AutoLock™	35
Setting up the AutoLock™ Access Code	36
Using Clear All	37
Using AutoLock™ to Block Channels	38
Using AutoLock™ to Block by Movie Rating	39
Using AutoLock™ to Block by TV Rating	40
Turning the AutoLock™ Blocking Control on or off	41
Using AutoLock™ to Block Unrated Broadcasts	42
Using AutoLock™ to Block Broadcasts That Have No Rating	43
Reviewing Your Current AutoLock™ Settings	44
Using the Closed Captioning Control	45
Using the Picture-format Control	46-47



APPENDICES

Appendix A: Compatibility Information for the TV's High-definition Inputs	48
Appendix B: Model Specifications	49



GENERAL INFORMATION

Care and Cleaning	50
Troubleshooting	51-52
Glossary of Television Terms	53
Index	54
Limited Warranty	56

QUICK USE AND SETUP GUIDE

Refer to the simple *Owner's Manual* (supplied with your TV) for details on the following:

- Basic TV connections
- Television and remote-control operation
- Onscreen menu controls
- How to use the installation features.

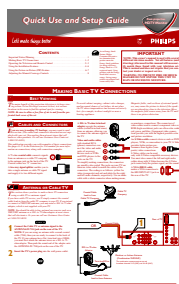

Items Included with This TV

As you unpack your TV, please note that this *Directions for Use* manual contains safety-tip information and Factory Service Center locations, as well as a Warranty Registration Card, and remote control.

Please take a few minutes to complete your registration card. The serial number for the TV is on the rear of the set. Refer to the back of this manual for instructions in the cleaning and care of the TV.

FEATURES

Alternate Channel (A/CH) button allows you to switch back and forth between the currently viewed channel and the previously viewed channel.

Automatic Phosphor Aging Compensation (APAC) Because both analog sources (cable TV and DVD) and digital sources (HD and progressive scan DVD) have different aspect ratios (4:3, 16:9, 21:9, etc.) the picture on a digital television may have black bars on the sides or top and bottom. Once black bars are detected in either the 4:3 or 16:9 viewing mode, APAC automatically shifts the television picture, pixel-by-pixel, just enough to blur image retention. Because APAC works in both the analog and digital modes, you have excellent protection.

Audio/video jacks allow direct connections with VCRs and other accessories for quality TV picture and sound playback. Component video input jacks are provided for high-fidelity color and picture resolution when using digital video source material, such as a DVD.

Audio Volume Leveler (AVL) control keeps the TV's sound at an even level. Peaks and valleys that occur during program changes or commercial breaks are reduced, making for a more consistent, comfortable sound.

AutoChrom™ automatically sets the right time of day and maintains it with digital precision through brownouts, power failures, and even Daylight Savings Time adjustments.

AutoLock™ protects young children from objectionable programming with V-chip technology.

Automatic Format automatically detects the incoming signal's format and adjusts it to fill the screen. Also, your remote control has a Format button that allows you to select the picture format you want to see.

Smart Picture™ allows you to push a button and adapt your TV's picture to various types of programs, such as sports, movies, and multimedia (games).

Smart Sound™ allows you to select from three factory-set controls and a personal control that you set according to your own preferences through the onscreen Sound submenu. The three factory-set controls—Voice, Music, and Theatre—enable you to tailor the TV sound to enhance the particular programming you are watching.

Channel Edit allows you to add or remove channels from the list of channels stored in the TV's memory. Channel Edit makes it easy to limit or expand the number of channels that are available to you when you press the CH +/- buttons on your remote control.

Closed Captioning allows you to read TV program dialog or voice conversations as onscreen text.

Smart Contrast helps you sharpen the picture quality by making the contrast between the dark and bright picture areas more noticeable as the image on screen changes.

Smart Scan gives you a choice between two different picture-scanning techniques—progressive and interlaced. Progressive scan doubles the number of visible picture lines per field by displaying all picture frame lines at once, eliminating line flicker. The interlaced mode provides for a double vertical display (interlaced) of progressive scan, which reduces annoying motion artifacts. The Interlaced mode also helps smooth out jagged lines sometimes seen on curved and angled surfaces.

High-definition component video inputs allow you to connect High-definition signals to the TV (HD INPUT-AV 4 only). The result is superb color purity, crisp color detail, and reduced color noise. Your set provides separate HD inputs for YPbPr/RGB, as well as horizontal and vertical sync.

Hi-fi stereo system, including a built-in audio amplifier and a twin speaker system. The system enables you to hear stereo sound or Second Audio Program (SAP) bilingual broadcasts when they are available.

Incredible Surround™ enhances stereo programs by making the sound broader and fuller.

Onscreen menu shows the TV controls and allows you adjust or set those controls (can be viewed in American English, French, or Spanish).

Standard broadcast (VHF/UHF) or cable TV (CATV) channel capability, as well as advanced capability for high-definition video.

Three-line comb filter provides improved chroma/luminance separation to the picture. Offering vertical-edge enhancement and virtually no "dot crawl," this filter easily supports the demands of DVD players and other advanced high-resolution video sources.



As an Energy Star® Partner, Magnavox has determined this product meets the Energy Star® guidelines for energy efficiency.

Energy Star® is a U.S. registered mark. Using products with the Energy Star® label can save energy. Saving energy reduces air pollution and lowers utility bills.

Active Control, APAC, AutoPicture, AutoSound, and Incredible Surround are trademarks of Magnavox North America. Copyright 2004 Magnavox.

End-of-life Disposal

Your new projection television and its packaging contain materials that can be recycled and reused. Specialized companies can recycle your product to increase the amount of reusable materials and minimize the amounts that need to be properly disposed. The batteries used by your product should not be thrown away when depleted but should be handed in and disposed of as small chemical waste. Please find out about the local regulations concerning how to dispose of your old television, batteries, and packaging



JACKS, CABLES, AND CONNECTORS

This page contains descriptions and illustrations of jacks, cables, and connectors you might use in making connections. The cables and connectors are not supplied with your TV, but you can purchase them at stores that sell electronics. Or you can order them by calling our Customer Care Center at 1-800-531-0039.

Component Video Input Jacks

Cables used: component video or A/V with RCA-type phono plugs

Allow you to connect accessory devices such as DVD players. Separating the video into three signals, these inputs provide excellent quality. Be sure to connect the left and right audio cables, because the Y, Pb, Pr jacks receive only the picture signal.

S-Video Jacks

Cable used: S-Video

Provide a higher quality picture than the Video (composite) jacks because the color part of the picture is separated from the black and white portion. Be sure to connect the left and right audio cables, because the S-Video jacks receive only the picture signal.

Video (called composite) Jacks

Cable used: A/V with RCA-type phono plug

Provide better picture performance than the antenna RF input. Be sure to connect the audio cables, because the video jacks receive only the picture signal.

Audio Jacks

Cables used: A/V with RCA-type phono plug

Provide sound for the video inputs. If your accessory device has only one output for audio, connect it to the left (color coded white) audio jack on the TV.

Antenna RF Jack

Cables used: RF coaxial cable (75Ω)

Allows you to connect an antenna, cable TV, or components having only RF outputs to the antenna input on the TV. RF coaxial cables are available in push-on or screw-on type.

Signal Splitter

Allows you to route an antenna or cable TV signal to two inputs.

300- to 75-ohm Twin-lead Adapter

Accepts twin-lead wires from an antenna and allows connection to the antenna input on the TV. If your antenna is already equipped with an RF coaxial cable you will not need this adapter.

Component Video Jacks
Cables Used: Component Video or A/V with RCA-type Phono Plugs

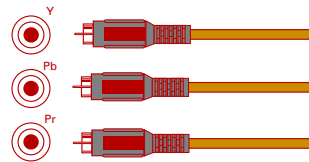

S-VIDEO Jack
Cable Used: S-Video

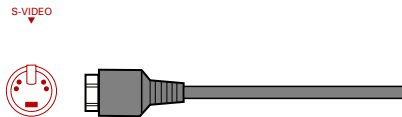

Video (Composite) Jack
Cable Used: A/V with RCA-type Phono Plug



Audio Jacks (Stereo Connection)
Cables Used: A/V with RCA-type Phono Plug

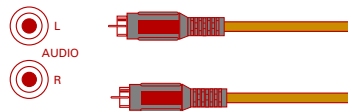

Audio Jacks (Monaural Connection)
Cable Used: A/V with RCA-type Phono Plug

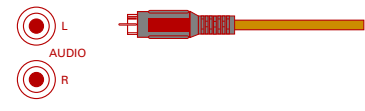

Antenna RF Jack
Cable Used: RF Coaxial (75Ω)

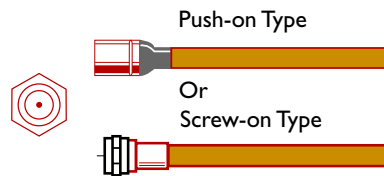

Signal Splitter
Cables Used: RF Coaxial (75Ω)

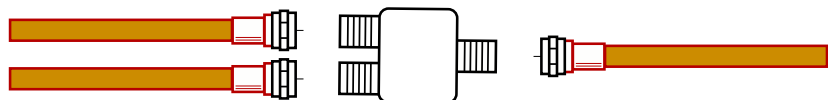

300- to 75-ohm Twin-lead Adapter

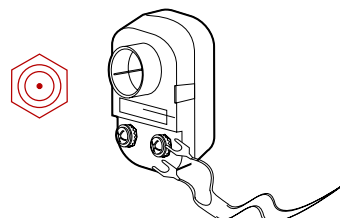



PANEL OVERVIEWS: STANDARD INPUTS AND OUTPUTS

You can connect a wide range of video and audio devices to your TV, in various ways. This page and the next one provide an overview of signal compatibilities and the types of devices you can connect to the jacks. Connection examples follow on subsequent pages. See pages 1 and 2 of the Quick Use and Setup Guide that came with your set for examples of basic connections. You may also want to refer to the user instructions that came with each particular device for information on connections.

What You Can Connect to the Standard Panel Jacks

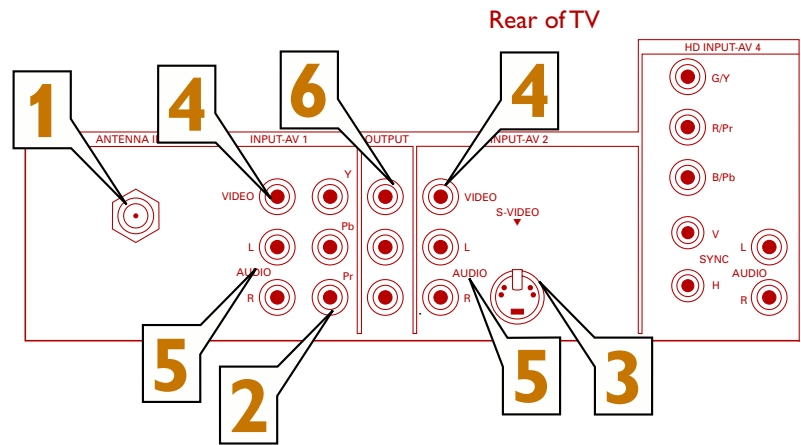

- 1 ANTENNA IN 75Ω jack**—use to connect radio-frequency (RF) signals from VHF/UHF antennas or a cable system. These are 480i signals.
- 2 YPbPr (component video input [CVI] jacks)**—compatible with 480i signals only. Use to connect accessories having component video outputs, such as DVD players, laser-disc players, video-game players, satellite receivers, or other devices. Use the INPUT-AV 1 L(ef) and R(ight) AUDIO jacks for sound connections.
- 3 S-VIDEO (super video) jacks**—compatible with 480i signals only. Use to connect accessories having Super VHS (S-VHS) outputs, such as VCRs, DVD players, laser-disc players, video-game players, satellite receivers, or other devices.
- 4 VIDEO (composite) jacks (INPUT-AV 1, INPUT-AV 2, and TV’s side jack panel [AV3])**—compatible with 480i signals only. Use to connect accessories having composite video outputs, such as VCRs, video-game players, or other devices.
- 5 AUDIO inputs (INPUT-AV 1, INPUT-AV 2, and TV’s side jack panel [AV3])**—use to connect from the audio output jacks on VCRs, DVDs, or other accessories.
- 6 OUTPUT (VIDEO/AUDIO)**—video is compatible with 480i signals only. Use to connect to a VCR to record programs from the TV. Or use the AUDIO outputs to connect to an audio hi-fi system.

Summary of signal compatibilities

Input jacks on TV	Compatible output signal from an external source or device
ANTENNA IN 75Ω, INPUT AV-1, INPUT AV-2, and side jack panel (AV3)	480i (480 lines, interlaced)

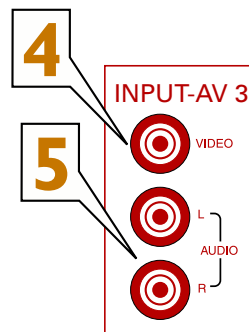

HELPFUL HINTS

- Signals connected to the HD INPUT-AV 4 inputs will provide you with the best picture. Examples of sources for such signals are a progressive-scan DVD player (480p) or an HD receiver (1080i or 480p) with YPbPr or RGB outputs. The 1080i signals will provide you with the best picture possible. Devices with RGB outputs may or may not have H and V sync outputs to connect to the HD INPUT-AV 4 H and V SYNC inputs.
- Among the 480i-compatible inputs (ANTENNA IN 75Ω, INPUT AV-1, INPUT AV-2, and the side jack panel), you will get the best picture from the component video inputs (labeled YPbPr). The S-Video inputs will provide the next-best level of picture quality.

✓ CHECK IT OUT

The side jack-panel inputs (recognized by the TV as AV3) are convenient for connecting a camcorder. See page 16.



PANEL OVERVIEWS: HIGH-DEFINITION INPUTS

The HD INPUT-AV 4 jacks allow you to digital equipment with 1080i or 480p signal output.

What You Can Connect to the High-definition Input Jacks

1 **HD INPUT-AV 4**—use to connect digital equipment with a 1080i or a 480p signal output, such as HD receivers (1080i or 480p) or DVD players with progressive-scan capability (480p). You can connect equipment with YPbPr component video or RGB outputs to the HD INPUT-AV 4 jacks. H and V Sync connections may or may not be required for RGB connections. Dedicated audio input jacks are located with the HD INPUT-AV 4 video jacks.

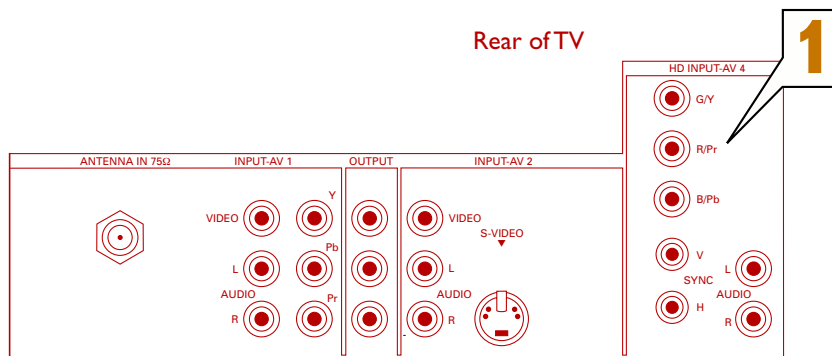

Summary of signal compatibilities

Input jacks on TV	Compatible output signal from an external source or device
HD INPUT-AV 4	1080i (1080 lines, interlaced) or 480p (480 lines, progressive scan)

HELPFUL HINTS

- This television is designed to be compatible with high-definition signal standards 1080i and 480p as specified by the Electronic Industries Association standard EIA770.3. Because output standards may vary by manufacturer, you may encounter some digital equipment that will not properly display pictures on the TV.

CONNECTING A VCR



The TV's audio/video (AV) input jacks provide for direct picture and sound connections between the TV and accessory devices such as VCRs, DVD players, and others that have AV output jacks.

This example, which uses the INPUT-AV 1 jacks, shows you one way you can connect a VCR to your TV.

Refer to the directions-for-use manual for your VCR for further information on connections.

To make the connections shown in this example, you will need:

- one coaxial cable (75Ω)
- one cable for a video connection (standard RCA connector)
- two cables for audio connections (standard RCA connectors) (only one cable is needed for a nonstereo VCR).

NOTE: The cables are not supplied with your TV. You should be able to buy them at most stores that sell electronics. Or you can call our Customer Care Center at 1-800-531-0039

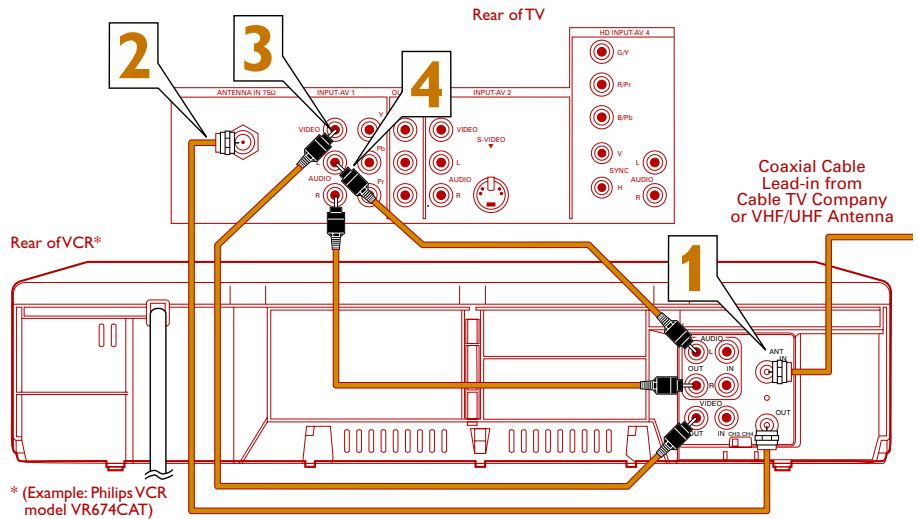

- 1** Connect a cable TV or antenna signal to the ANT IN jack on the rear of the VCR.
- 2** Connect from the OUT jack on the rear of the VCR to the ANTENNA IN 75Ω jack on the rear of the TV.
- 3** Connect the VIDEO OUT jack on the rear of the VCR to the INPUT AV1 VIDEO jack on the rear of the TV.
- 4** Connect the audio output R(ight) and L(eft) jacks on the rear of the VCR to the INPUT-AV 1 AUDIO jacks on the rear of the TV.
NOTE: If the VCR is a mono (nonstereo) unit, connect only the left audio cable, which usually has a white connector.
- 5** Press the AV button on the remote control as many times as necessary to select the AV1 source.
- 6** Turn the VCR on and press PLAY to view a videotape on the TV.

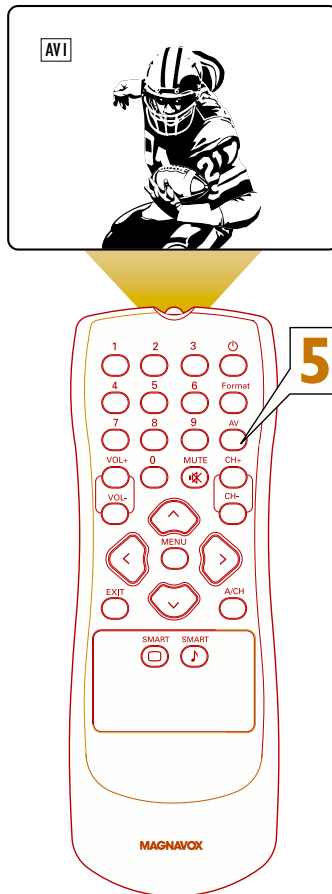

HELPFUL HINT

To simplify making connections, audio and video cables often have color-code connectors. The jacks on your TV are likewise color coded to match the connectors. The coding is as follows:

- Yellow for video (composite)
- Red for the right audio channel
- White for the left audio channel

NOTE: If your VCR is mono (nonstereo), you will connect only one audio cable. You must ensure that the TV is set to MONO for the signal source to which you've connected the VCR (INPUT-AV 1, INPUT-AV2, or the side panel inputs [AV3]). Otherwise, you will receive sound from only one of the TV's speak-

Connecting Access



*Presented here is a
involving a VCR a*

*Refer to the VCR's dir
for further information*

*To make the connection
will need:*

- one, two-way signal .
- two coaxial cables (7
- one cable for a video
RCA connector)
- two cables for audio c
RCA connectors) (only
for connection to a nor.

NOTE: The cables are no.
TV. You should be able to i
stores that sell electronics.
our Customer Care Center
1-800-531-0039.

- 1** Connect a cable TV s
way signal splitter.
- 2** Connect one of the two
splitter outputs to the L
cable box.
- 3** Connect the other two-w
splitter output to the ANT
75Ω on the rear of the TV.
- 4** Connect from the cable box
jack to the ANT IN jack on the
the VCR.
- 5** Connect the VIDEO OUT jack
the VCR to the INPUT-AV 1 VID. J
jack on the rear of the TV.

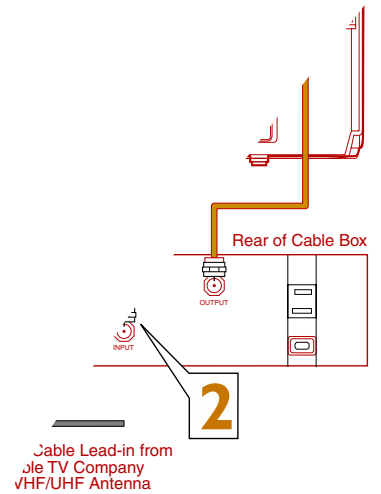
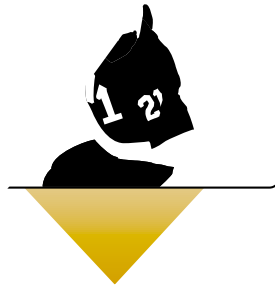

CONNECTING AND USING AN AUDIO HI-FI SYSTEM WITH YOUR TV



You can use your TV's **AUDIO OUTPUT** jacks to connect to an external audio hi-fi system. Follow the simple steps below.

To make these connections, you will need two cables for audio connections (standard RCA).

NOTE: The cables are not supplied with your TV. You should be able to buy them at most stores that sell electronics. Or you can call our Customer Care Center at 1-800-531-0039.

- 1** Connect from the **L(ef) and R(ight) AUDIO OUTPUT** jacks on the rear of the TV to the **L(ef) and R(ight) AUX/TV INPUT** jacks on the rear of the hi-fi system.

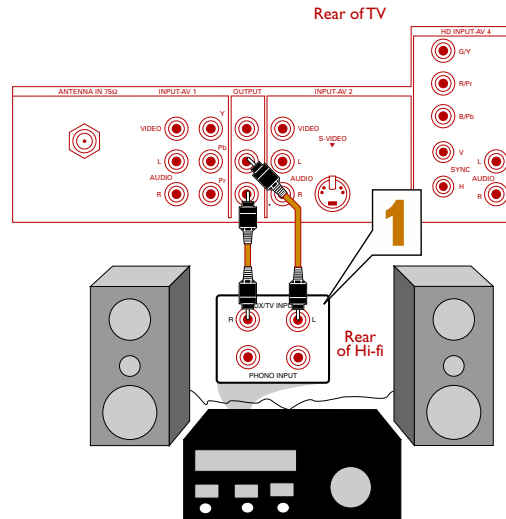

HELPFUL HINT

The sound outputs from the TV to an external hi-fi system are not affected or tailored by the **TREBLE, BASS, BALANCE, AVL, INCR. SURROUND,** and **BASS BOOST** controls in the TV's **SOUND** submenu.





CONNECTING AN S-VIDEO DEVICE

The S(uper)-Video connection on the rear (and side panel) of the TV can give you better picture detail and clarity for the playback of S-VHS VCR tapes or DVDs than the normal antenna (RF signal) or Video (composite) picture connections. The example given connects a DVD/VCR Combi unit to the INPUT-AV 2 jacks on the rear of the TV.

NOTE: The accessory device must have an S-VIDEO output jack to make the connection explained on this page.

To make the connections, you will need:

- one S-Video cable
- two cables for audio connections (standard RCA connectors).

NOTE: The cables are not supplied with your TV. You should be able to buy them at most stores that sell electronics. Or you can call our Customer Care Center at 1-800-531-0039.

- 1** Connect the S-VIDEO OUT jack on the rear of the accessory device with S-VIDEO output to the INPUT-AV 2 S-VIDEO jack on the rear of the TV.
- 2** Connect the DVD/VCR AUDIO OUT jacks on the rear of the accessory device to the INPUT-AV 2 AUDIO input jacks on the rear of the TV.
- 3** Press the AV button on the remote control as many times as necessary to select the AV2 source on the TV.
- 4** Turn the accessory device on and press play to view the video source material (DVD or videotape, for example) on the TV.

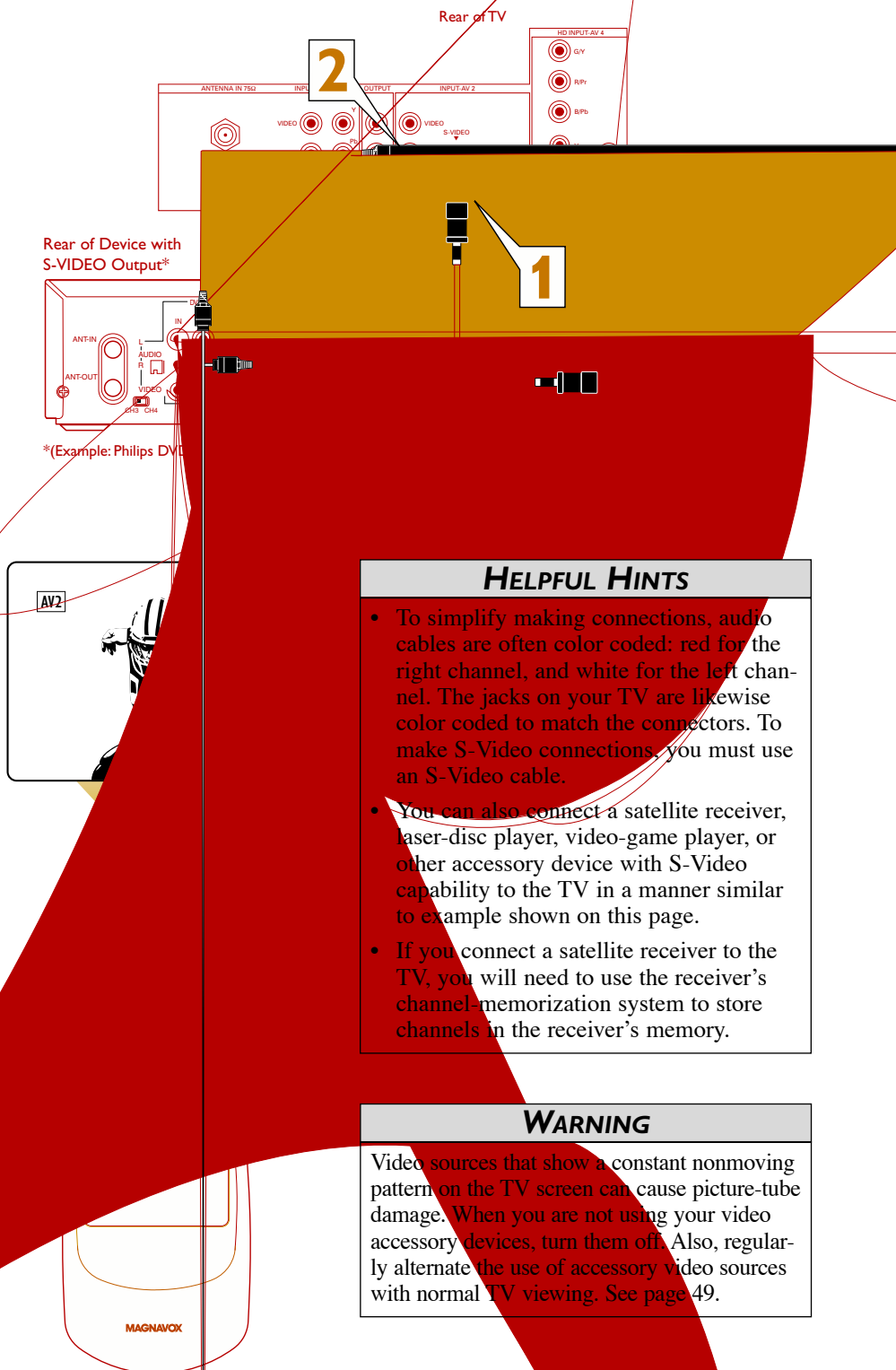

CONNECTING AN HD RECEIVER TO THE HD INPUT-AV 4 JACKS



Digital equipment with a 1080i or 480p output, is compatible with the HD INPUT-AV 4 video jacks.

NOTE: This television is designed to be compatible with high-definition signal standards 1080i and 480p as specified by the Electronic Industries Association standard EIA770.3. Because output standards may vary by manufacturer, you may encounter some digital equipment that will not properly display pictures on the TV.

To make the connections shown in this example, you will need:

- one S-VIDEO cable
- three cables for video connections (standard RCA connectors)
- four cables for audio connections (standard RCA connectors)
- one coaxial cable (75Ω).

NOTE: The cables are not supplied with your TV. You should be able to buy them at most stores that sell electronics. Or you can call our Customer Care Center at 1-800-531-0039.

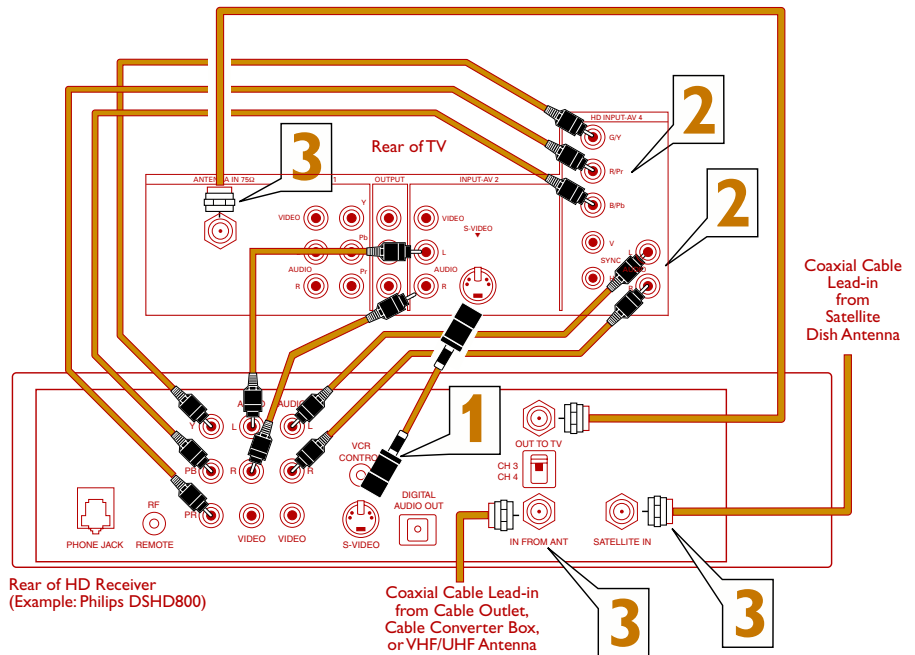

- 1 Connect S-VIDEO and audio cables.**

 - Connect an S-VIDEO cable from the HD receiver's S-VIDEO jack to the TV's INPUT-AV 2 S-VIDEO jack.
 - Connect from the HD receiver's AUDIO L(ef) and R(ight) jacks to the TV's INPUT-AV 2 L(ef) and R(ight) AUDIO jacks.
- 2 Connect component video and audio cables to the TV's HD inputs.**

 - Connect from the YPRPB jacks on the HD receiver to the TV's HD INPUT-AV 4 G/Y, R/Pr, B/Pb jacks.
 - Connect from the HD receiver's AUDIO L(ef) and R(ight) jacks to the TV's HD INPUT-AV 4 L(ef) and R(ight) AUDIO jacks.
- 3 Connect coaxial cables.**

 - Connect the coaxial cable lead-in from your cable outlet, cable converter box, or VHF/UHF antenna to the IN FROM ANT jack on the HD receiver.
 - Connect a coaxial cable from the OUT TO TV jack to the ANTENNA IN 75Ω jack on the TV.
 - Connect the coaxial cable lead-in from a satellite dish antenna to the SATELLITE IN jack on the HD receiver.
- 4 Refer to the directions-for-use manual that came with the HD receiver for setup instructions.**

HELPFUL HINTS

- Making a standard connection along with the HD connection as shown in the example (S-VIDEO) on this page will allow you to see the receiver's onscreen menu and a picture (valid signal) from the receiver should it be switched to SD mode.
- The HD INPUT-AV 4 jacks are for standard RCA connectors. Your HD receiver may use RCA or BNC output jacks. If your HD receiver comes with BNC jacks, you will need to purchase BNC-to-RCA adapters to connect the receiver to the TV. You should be able to purchase these adapters at most stores that sell electronics. Or you can call our Customer Care Center at 1-800-531-0039.

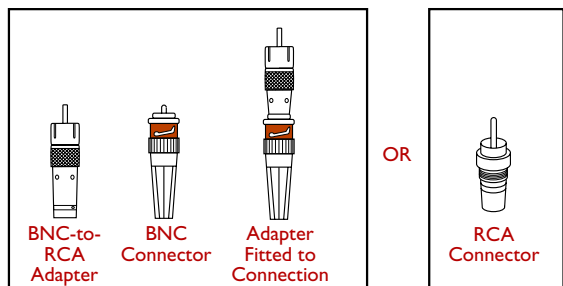

- The HD INPUT-AV 4 jacks are compatible with some digital equipment having RGB outputs with "sync on green" or RGB with "separate H and V sync." Output standards for digital equipment, however, may vary by manufacturer. No industry standards have been established for HD television RGB signal systems, timing, synchronization, and signal strengths. If the digital equipment you want to connect to your TV offers both component video and RGB outputs, component video is the suggested connection to use.
- The default color-space setting for the HD INPUT-AV 4 jacks is YPbPr. RGB is also an option. If the picture color looks grossly incorrect, try changing either the receiver's or TV's color space. See the receiver's directions-for-use manual for information on setting its color space.



CONNECTING A CAMCORDER

The side panel jacks provide a convenient way for you to connect a camcorder to your TV. The side panel jacks are recognized by your TV as AV3.

To make the connections shown in this example, you will need:

- an Component VIDEO cable
- two cables for audio connections (standard RCA connectors).

NOTE: The cables are not supplied with your TV. You should be able to buy them at most stores that sell electronics. Or you can call our Customer Care Center at 1-800-531-0039.

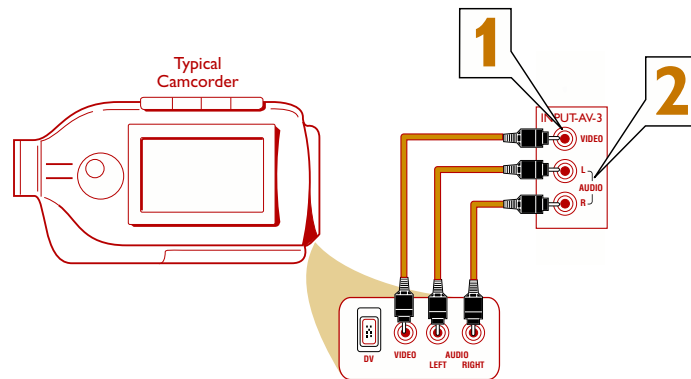

- 1** Connect from the VIDEO output on the camcorder to the VIDEO input in the TV's side panel.
- 2** Connect from the AUDIO outputs on the camcorder to the side panel AUDIO L(ef) and R(ight) inputs.
- 3** Press the AV button on the remote control as many times as necessary to select the AV3 source on the TV.
- 4** Turn the camcorder on, insert a videotape, and press PLAY to view the tape on the TV.

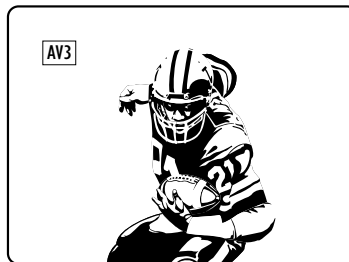

HELPFUL HINT

To simplify making connections, the connectors on audio cables are often color coded: red for the right channel, and white for the left channel. The jacks on your TV are likewise color coded to match the connectors. To make S-Video connections, you

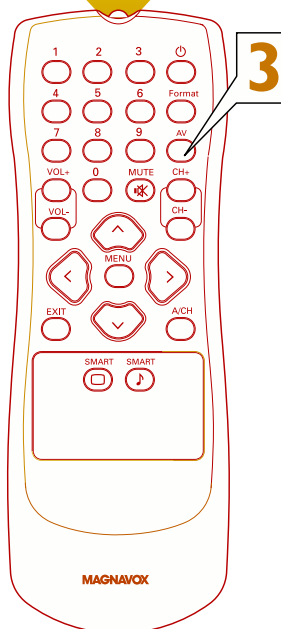

USING THE AV AND SOURCE SELECT BUTTONS



The AV button on the remote control and SOURCE SELECT button on the TV allow you to access the TV's signal-source inputs. With each press of the AV button you can access a different signal-source input. The signal-source input jacks are located on the back and side panels of your TV. (See pages 6 and 7.)

Selecting a Signal Source Using the AV Button on the Remote Control

Press the AV button on the remote control as many times as necessary to select the signal source you want to watch.

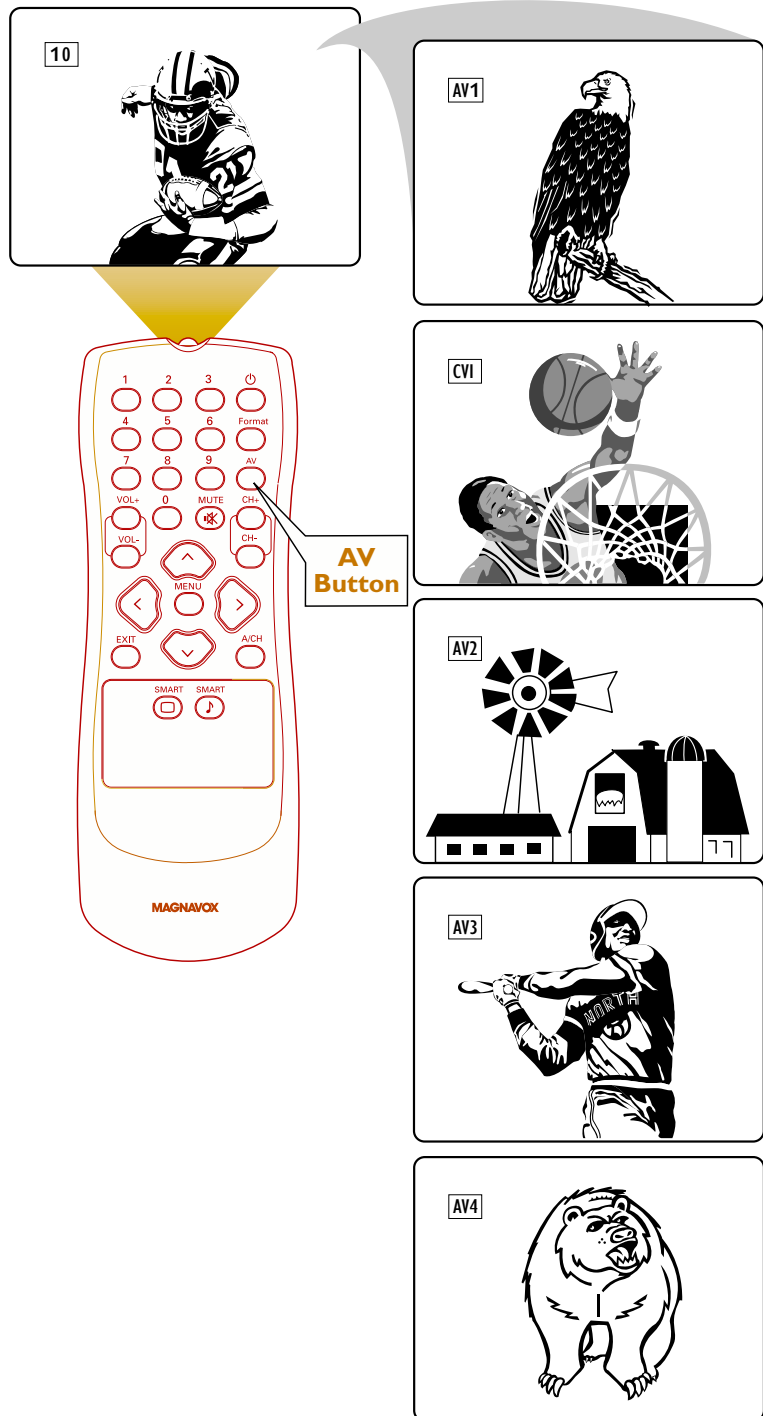

USING SMARTSOUND™

You can use the SmartSound™ options to automatically tailor the TV's sound for the type of program you are watching. The factory has set the VOICE, MUSIC, and THEATRE options. The settings for the PERSONAL option are the ones you select through the onscreen SOUND submenu. See descriptions of the options below, right.

- 1** Press the **SOUND** button on the remote control. The current SmartSound™ setting will appear on screen. Press the **SOUND** button repeatedly to cycle through the four options: PERSONAL, VOICE, MUSIC, or THEATRE.
- 2** When you see the option you want on the screen, press the **STATUS/EXIT** button to exit the menu. The SmartSound™ option you selected is then active.

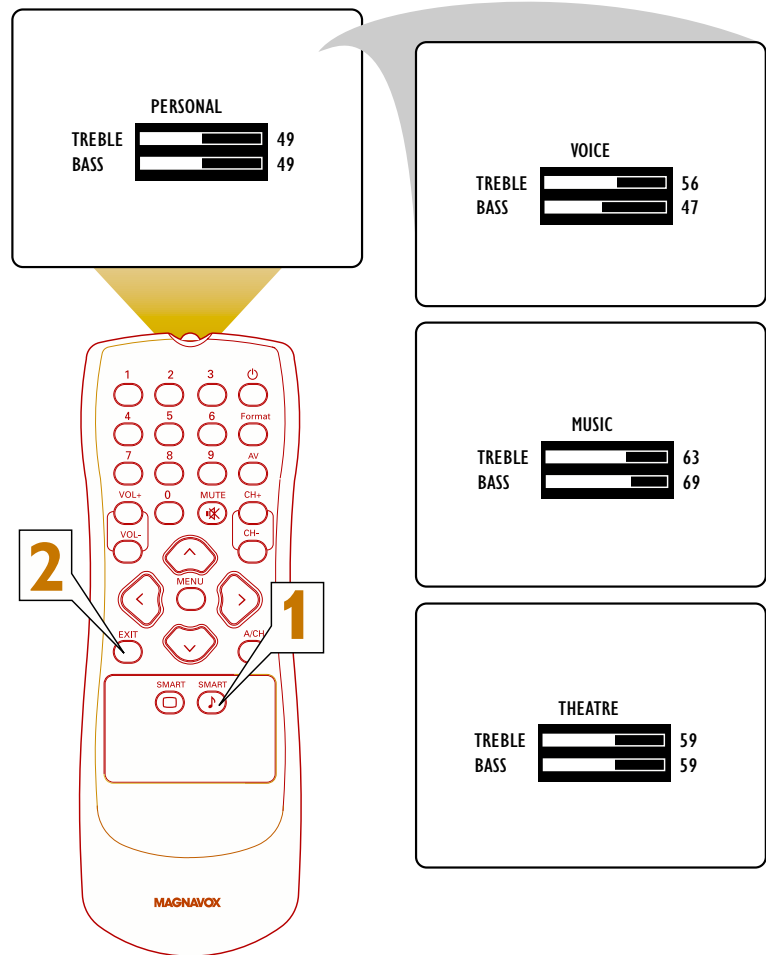

HELPFUL HINTS

- If you select an Smart Sound™ option other than PERSONAL, then the TREBLE and BASS settings specific to that option will also be written to the SOUND submenu items. At that point, the PERSONAL Smart Sound™ option settings will not be changed. Only when you go into the SOUND submenu and change the TREBLE and BASS settings will those settings be reflected in the PERSONAL Smart Sound™ option.

Smart Sound™ Options

PERSONAL presents the TV's sound according to the TREBLE and BASS settings you make within the SOUND submenu.

VOICE brings voices to the forefront and emphasizes them. Moves music to the background.

MUSIC emphasizes music over voices.

THEATRE provides a balance between voices and music.

USING SMARTPICTURE™



You can use an SmartPicture™ option to automatically tailor the TV's picture for certain types of input signals. The factory has set the MOVIES, SPORTS, WEAK SIGNAL, and MULTIMEDIA options. The settings for the PERSONAL option are the ones you select through the onscreen PICTURE submenu.

- 1** Press the **PICTURE** button on the remote control. The current SmartPicture™ setting will appear on screen. Then Press the PICTURE button repeatedly to cycle through the options: PERSONAL, MOVIES, SPORTS, WEAK SIGNAL, and MULTIMEDIA picture settings.
- 2** When you see the option you want on screen, press the **STATUS/EXIT** button to turn off the onscreen display. The SmartPicture™ option you selected is then active.

PERSONAL	
BRIGHTNESS	48
COLOR	41
PICTURE	81
SHARPNESS	46

MOVIES	
BRIGHTNESS	50
COLOR	50
PICTURE	50
SHARPNESS	84

SPORTS	
BRIGHTNESS	50
COLOR	55
PICTURE	60
SHARPNESS	70

WEAK SIGNAL	
BRIGHTNESS	50
COLOR	40
PICTURE	40
SHARPNESS	28

MULTIMEDIA	
BRIGHTNESS	50
COLOR	40
PICTURE	40
SHARPNESS	70

HELPFUL HINT

If you select an SmartPicture™ setting option other than PERSONAL, then the BRIGHTNESS, COLOR, PICTURE, and SHARPNESS settings specific to that option will also be written to the PICTURE submenu items. At that point, the PERSONAL SmartPicture™ option settings will not be changed. Only when you go into the PICTURE submenu and change the settings will those settings be reflected in the PERSONAL SmartPicture™ option.



USING ALTERNATE CHANNEL

You can press the A/CH button on your remote control to go back and forth between the current channel and one previously watched channel.

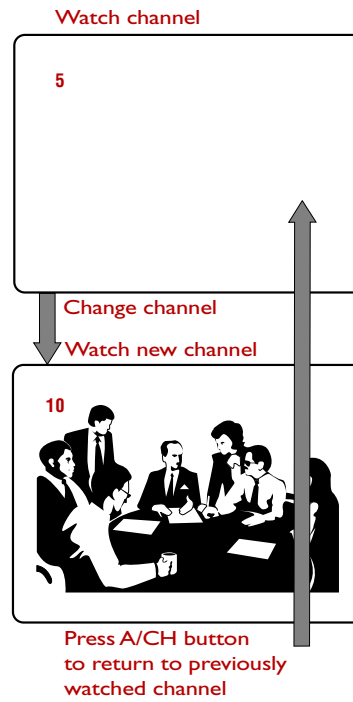

ADJUSTING THE PICTURE CONTROLS



To adjust your TV picture controls, select a channel and follow these steps. See descriptions of the picture-adjustment options below.

- 1** Press the **MENU/SELECT** button on the remote control to show the onscreen menu.
- 2** Press the **CURSOR BUTTON RIGHT**. **BRIGHTNESS** will be highlighted and an adjustment bar will be shown to the right.
- 3** Press the **CURSOR RING RIGHT** or **LEFT** to adjust the **BRIGHTNESS** level of the picture. Or press the **CURSOR BUTTON DOWN** to select another picture control to adjust.
- 4** Press the **STATUS/EXIT** button to exit the menu.

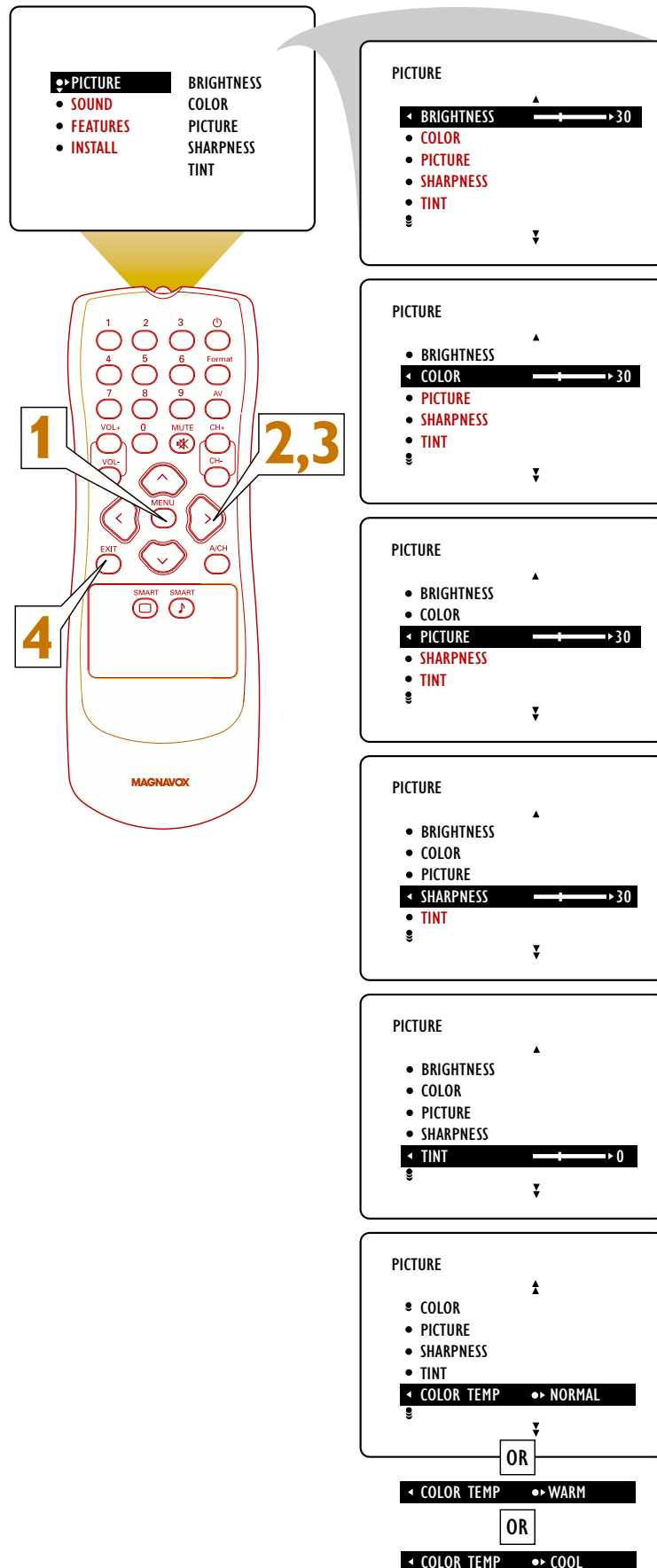

Picture-adjustment Options

Remember, when the bar scale is centered , the control settings are at mid-range levels. Picture adjustments are described as follows:

BRIGHTNESS adds or subtracts light from the darkest part of the picture.

COLOR adds or eliminates color.

PICTURE improves the detail of the lightest parts of the picture.

SHARPNESS improves the detail in the picture.

TINT adjusts the picture to obtain natural skin tones.

COLOR TEMP offers **NORMAL**, **COOL**, or **WARM** picture preferences.

NORMAL keeps whites, white.

WARM makes whites, reddish.

COOL makes whites, bluish.

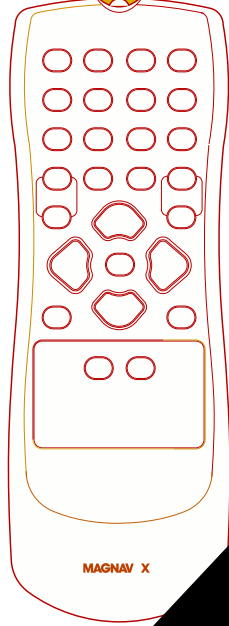

MAGNAV X

USING THE AVL (AUDIO VOLUME LEVELER) CONTROL



You may have noticed the peaks and valleys of sound that occur between program changes or at commercial breaks. The volume levels often vary considerably. By turning on the AVL (Audio Volume Leveler) control, you can make your TV produce a more consistent volume level. Follow these steps to turn the AVL control on.

- 1** Press the **MENU** button on the remote control to show the onscreen menu.
- 2** Press the **CURSOR BUTTON DOWN** once to highlight **SOUND**.
- 3** Press the **CURSOR BUTTON RIGHT** to enter the **SOUND** submenu.
- 4** Press the **CURSOR RING DOWN** repeatedly until **AVL** is highlighted. Then press the **CURSOR BUTTON RIGHT** or **LEFT** to turn **AVL ON** or **OFF**.
- 5** Press the **STATUS/EXIT** button to exit the menu.

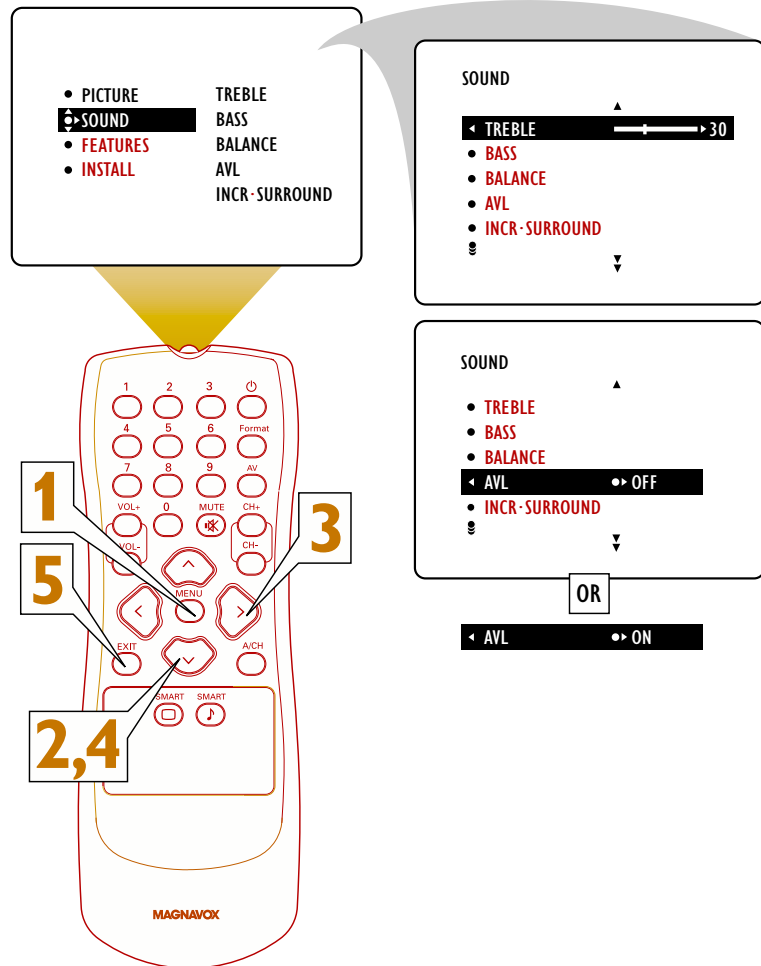

- PICTURE
- ◀ SOUND
- FEATURES
- INSTALL

- TREBLE
- BASS
- BALANCE
- AVL
- INCR-SURROUND

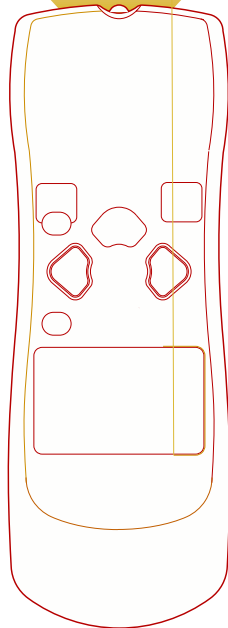

SOUND

◀ TREBLE → 30

- BASS
- BALANCE
- AVL
- INCR-SURROUND

SOUND

- TREBLE
- BASS
- BALANCE
- AVL

◀ INCR-SURROUND STEREO

OR

◀ INCR-SURROUND • INCR-SURROUND

When signals are being broadcast in mono (nonstereo):

◀ INCR-SURROUND • MONO

OR

◀ INCR-SURROUND • SPATIAL

SELECTING THE STEREO/MONO SOUND MODE



You can enjoy stereo programs on your TV. It has both an amplifier and twin speakers through which stereo sound can be heard. Follow these steps to select the STEREO mode.

- 1** Press the **MENU** button on the remote control to show the onscreen menu.
- 2** Press the **CURSOR BUTTON DOWN** once to highlight SOUND.
- 3** Press the **CURSOR BUTTON RIGHT** to enter the SOUND sub-menu.
- 4** Press the **CURSOR BUTTON DOWN** repeatedly until the STEREO control is highlighted.
- 5** Press the **CURSOR BUTTON RIGHT** or **LEFT** to select STEREO or MONO. When STEREO has been selected, the television will reproduce any stereo signal it receives.
- 6** Press the **STATUS/EXIT** button to exit the menu.

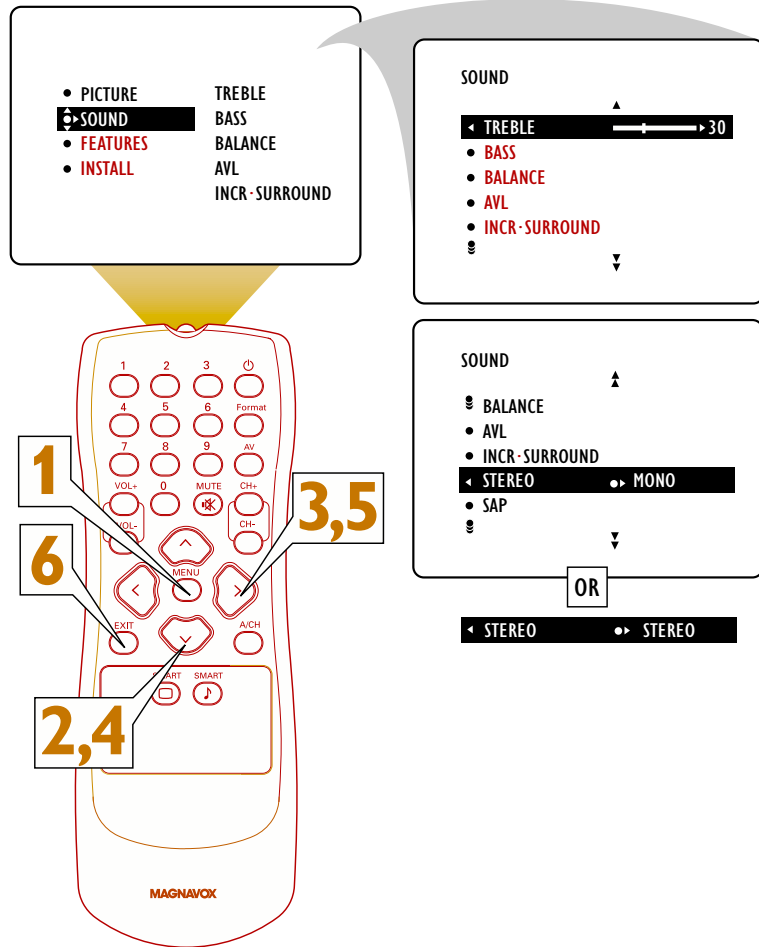



SELECTING THE SAP (SECOND AUDIO PROGRAM) FEATURE

SAP, or *Second Audio Program*, is an additional part of the stereo broadcast system. Sent as a third audio channel, an SAP can be heard apart from the current TV program sound. TV stations are free to use SAP for any number of purposes, such as the broadcast of a second language or other audio information.

If an SAP signal is not present with a selected program, the SAP option cannot be selected.

NOTE: SAP must be broadcast with the program you are watching for you to be able to select the feature.

- 1** Press **MENU** button on the remote control to show the onscreen menu.
- 2** Press the **CURSOR RING DOWN** once to highlight **SOUND**.
- 3** Press the **CURSOR BUTTON RIGHT** to enter the **SOUND** submenu.
- 4** Press the **CURSOR BUTTON DOWN** repeatedly until **SAP** is highlighted.
- 5** Press the **CURSOR BUTTON RIGHT** or **LEFT** to turn **SAP ON** or **OFF**.
- 6** Press the **STATUS/EXIT** button to exit the menu.

- PICTURE
- **SOUND**
- FEATURES
- INSTALL

- TREBLE
- BASS
- BALANCE
- AVL
- INCR-SURROUND

SOUND

◀ TREBLE 30

- **BASS**
- **BALANCE**
- AVL
- **INCR-SURROUND**

SOUND

- BALANCE
- AVL
- INCR-SURROUND
- STEREO
- ◀ **SAP** ●● OFF

IF A SECOND AUDIO PROGRAM IS BEING BROADCAST:

◀ SAP ●● ON

OR

◀ SAP ●● OFF

IF A SECOND AUDIO PROGRAM IS NOT BEING BROADCAST:

◀ SAP ●● NOT AVAILABLE

OR

◀ SAP ●● OFF

USING THE BASS BOOST CONTROL



The **BASS BOOST** control allows you to increase the low-frequency range of the TV's sound. This creates a deeper, fuller sound. Follow these steps to turn **BASS BOOST** ON.

- 1** Press **MENU** button on the remote control to show the onscreen menu.
- 2** Press the **CURSOR RING DOWN** once to highlight **SOUND**.
- 3** Press the **CURSOR BUTTON RIGHT** to enter the **SOUND** sub-menu.
- 4** Press the **CURSOR BUTTON DOWN** repeatedly until **BASS BOOST** is highlighted.
- 5** Press the **CURSOR BUTTON RIGHT** or **LEFT** to turn **BASS BOOST** ON or OFF.
- 6** Press the **STATUS/EXIT** button to exit the menu.

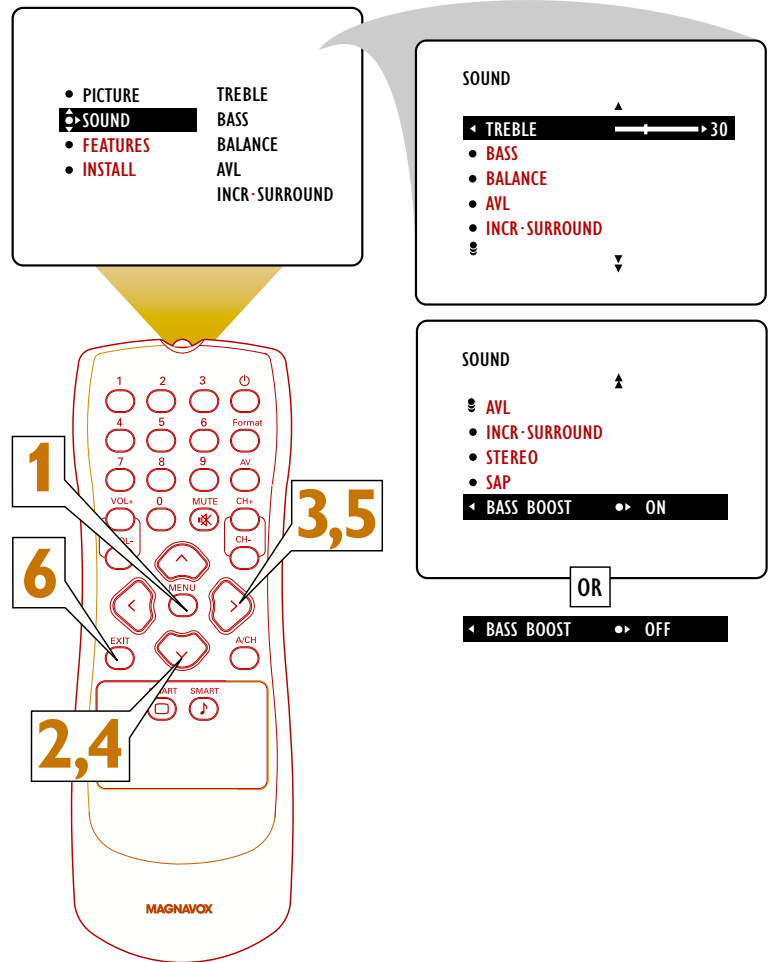



SETTING THE CLOCK

Your TV comes with an onscreen clock. You will need to set the clock before you can use the Timer feature. During normal operation, the time appears on the screen when you press the STATUS/EXIT button. You can show the time on screen constantly by turning the TIMER DISPLAY control on (see page 31).

For instructions on setting the Timer's START and STOP times, see page 32. Then go to pages 33 and 34 to learn how to select the Timer's channel and activate the Timer.

- 1** Press the **MENU** button on the remote control to show the onscreen menu.
- 2** Press the **CURSOR BUTTON DOWN** twice to highlight FEATURES.
- 3** Press the **CURSOR BUTTON RIGHT** to enter the FEATURES submenu.
- 4** Press the **CURSOR BUTTON RIGHT** again to shift the display left and highlight the TIME control.
- 5** Press the **CURSOR BUTTON RIGHT** again to highlight the time indicator area.
- 6** Press the **NUMBER** buttons to enter the correct time. If you make a mistake entering the time, press the **CURSOR BUTTON LEFT** or **RIGHT** to move among the input slots to make corrections.
- 7** Press the **CURSOR BUTTON UP** or **DOWN** to select AM or PM.
- 8** Press the **STATUS/EXIT** button to exit the menu.

NOTE: You can also press the **CURSOR BUTTON UP** or **DOWN** to cycle through digits to input the time.

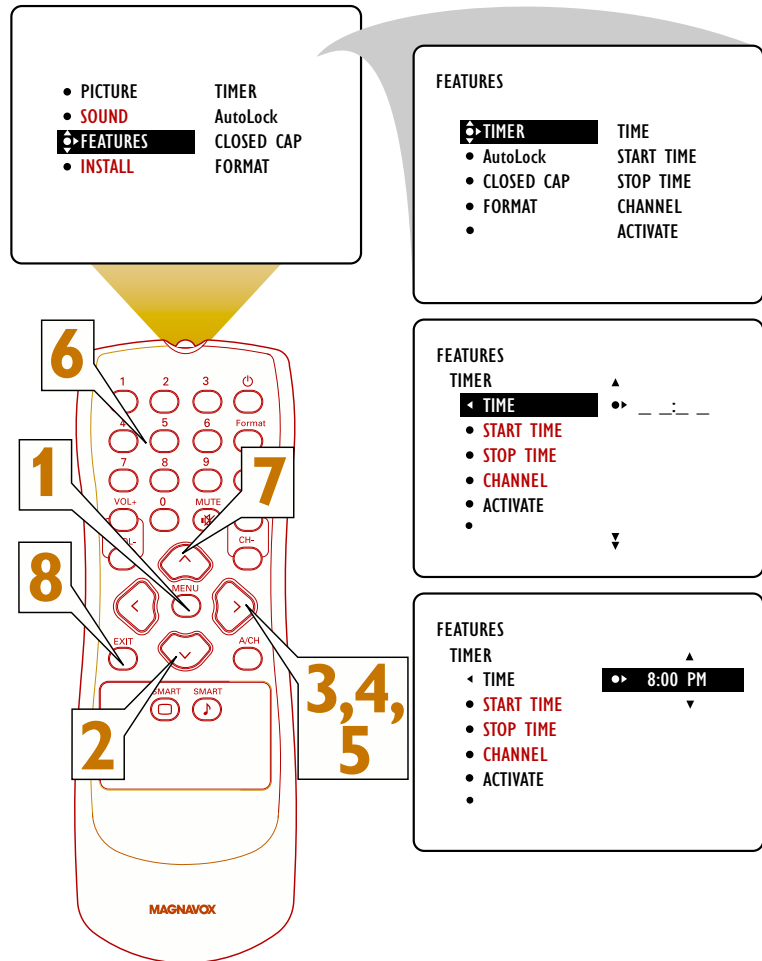

HELPFUL HINTS

- For single-digit entries, be sure to press 0 first and then the hour number.
- If you'd like, set the clock automatically using the AutoChron™ feature (page 5, Quick Use and Setup Guide).
- Clock settings may be lost when the TV is unplugged or when AC power to the set is



DISPLAYING THE TIME

After you have set the TV's clock, you can use your TV to keep up with the time on screen. You can also set the timer to switch to another channel, and, if you want, turn the TV off. The Timer's **DISPLAY** control allows you to show the time constantly in the upper right corner of the screen.

- 1** Press the **MENU** button on the remote control to show the onscreen menu.
- 2** Press the **CURSOR BUTTON DOWN** twice to highlight **FEA-TURES**.
- 3** Press the **CURSOR BUTTON RIGHT** to enter the **FEATURES** sub-menu.
- 4** Press the **CURSOR BUTTON RIGHT** again. Then press the **CURSOR RING DOWN** repeatedly until the **DISPLAY** control is highlighted.
- 5** Press the **CURSOR BUTTON RIGHT** or **LEFT** to turn the **TIMER DISPLAY** ON or OFF.
- 6** Press the **STATUS/EXIT** button to exit the menu.

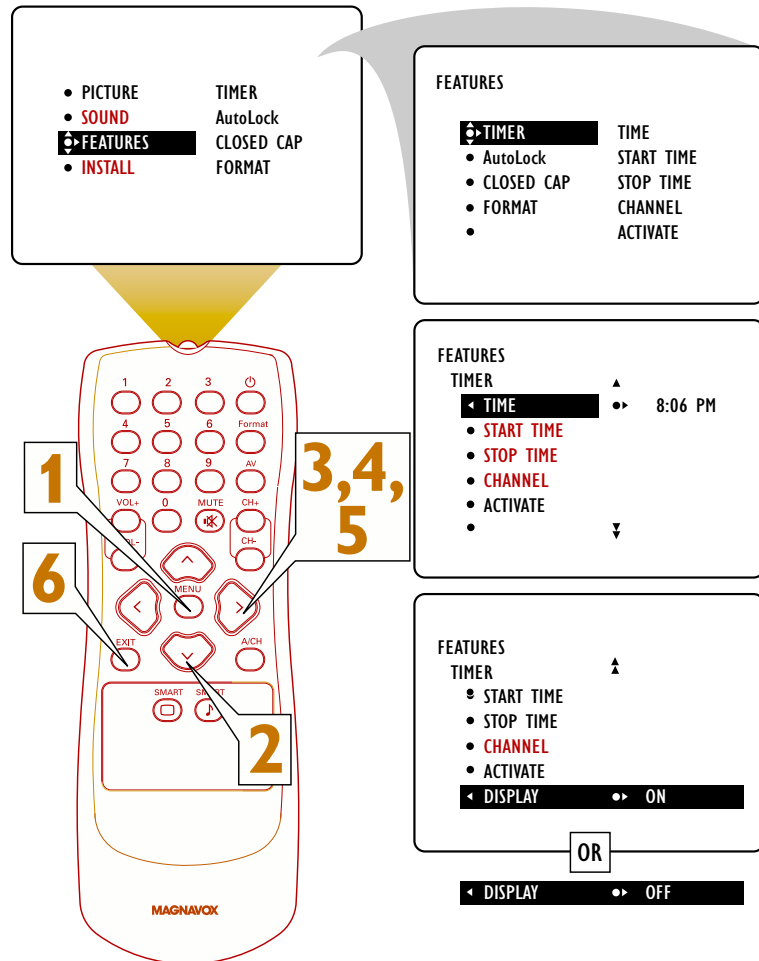

SETTING THE TIMER'S START TIME AND STOP TIME

You can set the Timer to switch to a selected channel at a specific time while you are watching another channel, or when the TV is in standby mode. (Standby mode is when the TV is plugged into the wall outlet but turned off.) If you want, you can also set the TV to turn off at some time after the TV switches channels. Follow the steps below to set the Timer's START TIME and STOP TIME.

- 1** Press the **MENU** button on the remote control to show the onscreen menu.
- 2** Press the **CURSOR BUTTON DOWN** twice to highlight **FEA-TURES**.
- 3** Press the **CURSOR BUTTON RIGHT** to enter the **FEATURES** sub-menu.
- 4** Press the **CURSOR BUTTON RIGHT** again. Then press the **CURSOR RING DOWN** once to highlight the **START TIME** control.
- 5** Press the **CURSOR BUTTON RIGHT** to highlight the time indicator area.
- 6** Press the **NUMBER** buttons to enter the correct time. If you make a mistake entering the time, use the **CURSOR BUTTON LEFT** or **RIGHT** to move among the time input slots to make corrections.
NOTE: You can also use the **CURSOR BUTTON UP** or **DOWN** to cycle through digits to input the time.
- 7** Press the **CURSOR BUTTON UP** or **DOWN** to select **AM** or **PM**.
- 8** Press the **CURSOR BUTTON LEFT** repeatedly until **START TIME** is highlighted. Then press the **CURSOR BUTTON DOWN** to highlight **STOP TIME**. If you want the TV to switch off at some time after the changing of channels, follow steps 5–7 above to set the **STOP TIME**.
- 9** Press the **STATUS/EXIT** button to exit the menu.

See pages 33 and 34 for instructions on selecting the Timer's channel and activating the timer.

- PICTURE
- SOUND
- **FEATURES**
- INSTALL

- TIMER
- AutoLock
- CLOSED CAP
- FORMAT

FEATURES

- **TIMER**
- AutoLock
- CLOSED CAP
- FORMAT
-

- TIME
- START TIME
- STOP TIME
- CHANNEL
- ACTIVATE

FEATURES

TIMER

- **TIME**
- **START TIME**
- **STOP TIME**
- CHANNEL
- ACTIVATE
-

8:06 PM

FEATURES

TIMER

- TIME
- **START TIME**
- **STOP TIME**
- CHANNEL
- ACTIVATE
-

FEATURES

TIMER

- TIME
- **START TIME**
- **STOP TIME**
- CHANNEL
- ACTIVATE
-

8:00 AM

FEATURES

TIMER

- TIME
- **START TIME**
- **STOP TIME**
- CHANNEL
- ACTIVATE
-

FEATURES

TIMER

- TIME
- **START TIME**
- **STOP TIME**
- CHANNEL
- ACTIVATE
-

9:30 AM

SELECTING THE TIMER'S CHANNEL



Follow these steps to select the channel to which the Timer will switch the TV.

- 1** Press the **MENU** button on the remote control to show the onscreen menu.
- 2** Press the **CURSOR BUTTON DOWN** twice to highlight **FEATURES**.
- 3** Press the **CURSOR BUTTON RIGHT** to enter the **FEATURES** submenu.
- 4** Press the **CURSOR BUTTON RIGHT**. Then press the **CURSOR BUTTON RING DOWN** repeatedly until the **CHANNEL** control is highlighted.
- 5** Press the **NUMBER** buttons to enter the desired start-up channel. Or press the **CURSOR BUTTON RIGHT** repeatedly to enter the start-up channel you want.
- 6** Press the **STATUS/EXIT** button to exit the menu.

NOTE: Before the Timer will work, you must activate it. See page 34.

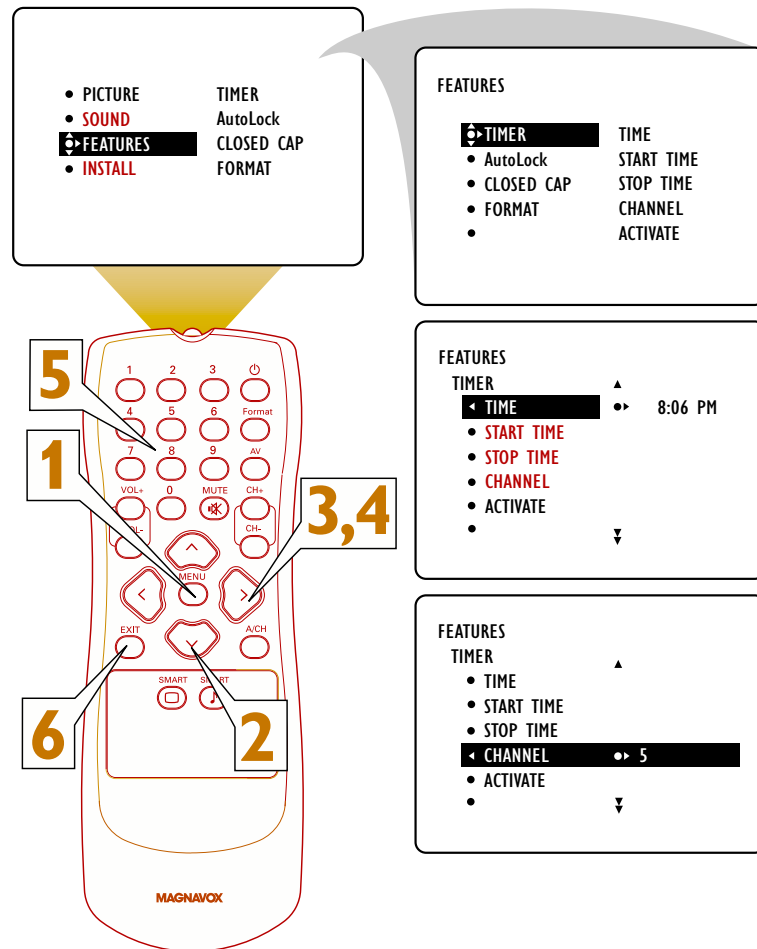



SETTING THE TIMER'S ACTIVATE CONTROL

After you have set the TIME, START TIME, STOP TIME, and CHANNEL, you must activate the Timer for it to operate. Your options are to set the Timer to work ONCE or DAILY. Set ACTIVATE to OFF if you don't want to use the Timer.

- 1 Press the **MENU** button on the remote control to show the onscreen menu.
- 2 Press the **CURSOR BUTTON DOWN** twice to highlight FEATURES.
- 3 Press the **CURSOR BUTTON RIGHT** to enter the FEATURES sub-menu.
- 4 Press the **CURSOR BUTTON RIGHT** again. Then press the **CURSOR RING DOWN** repeatedly until the **ACTIVATE** control is highlighted.
- 5 Press the **CURSOR BUTTON RIGHT** to cycle through the options and make your selection. The options are ONCE, DAILY, or OFF.
- 6 Press the **STATUS/EXIT** button to exit the menu.

- PICTURE
- SOUND
- **FEATURES**
- INSTALL

- TIMER
- AutoLock
- CLOSED CAP
- FORMAT

FEATURES

- **TIMER**
- AutoLock
- CLOSED CAP
- FORMAT
-

- TIME
- START TIME
- STOP TIME
- CHANNEL
- ACTIVATE

FEATURES

TIMER

- **TIME**
- START TIME
- STOP TIME
- CHANNEL
- ACTIVATE
-

8:06 PM

FEATURES

TIMER

- TIME
- START TIME
- STOP TIME
- CHANNEL
- **ACTIVATE**
-

ONCE

OR

• ACTIVATE • DAILY

OR

• ACTIVATE • OFF

HELPFUL HINT

- Changing the channel or adjusting the volume during the last minute of a Timer setting will cancel the shutting off of the TV.
- Thirty seconds before the set changes to the channel you set (see page 33), an announcement appears on screen.



UNDERSTANDING AUTOLOCK™



The AutoLock™ feature can help parents control what their children watch on TV. AutoLock™ does this by using the content advisories sent by broadcasters or other program providers. After you program AutoLock™, it can respond to the content advisories and block programs that contain content that you may consider objectionable—offensive language, violence, or sexual situations. You can also use AutoLock™ to block channels that you don't want your children to watch.

In this section, you'll learn how to block channels and programming that is not rated, is unrated, or has no rating. You will also find out how to turn these blocking features on or off. Following on this page are brief explanations of AutoLock™ terms and program ratings.

Terms

BLOCKING control—can be thought of as the “master switch” for AutoLock™. This control affects the settings you have chosen for blocking programs according to movie ratings or TV ratings, or for blocking programs that have no rating or are unrated. When the BLOCKING control is OFF, the blocking or censoring of programs is disabled. When the BLOCKING control is ON, blocking will occur according to the settings you have chosen.

BLOCK UNRATED control—if set to ON, blocks all unrated programs.

Unrated programming consists of the kind of shows that the MPAA (Motion Picture Association of America) or the TV broadcasters have chosen not to rate.

NO RATING control—if set to ON, blocks all programming with no content advisory data.

Programming that has No Rating is not encoded with any rating information from the MPAA or the Parental Guidelines. Any programming could fall into this category.

BLOCK CHANNEL control—enables you to block individual channels that you don't want children to see.

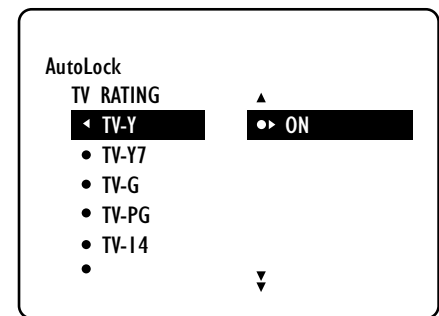
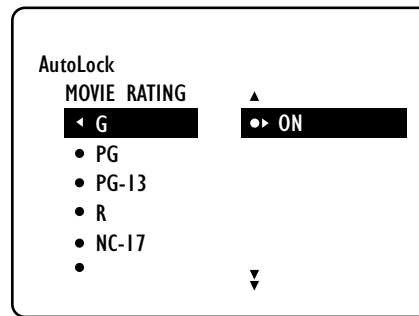

MOVIE RATINGS (MOTION PICTURE ASSOCIATION OF AMERICA)

G (General Audience)—all ages admitted. Most parents will find programs that are rated G to be suitable for children of all ages. Such programs have little or no violence, no strong language, and little or no sexual dialog or sexual situations.

PG (Parental Guidance Suggested)—contain material that parents may find unsuitable for younger children. Programs that are rated PG have one or more of the following: moderate violence, some sexual situations, infrequent coarse language, or some suggestive dialog.

PG-13 (Parents Strongly Cautioned)—contain material that parents may find unsuitable for children under the age of 13. Programs that are rated PG-13 have one or more of the following: violence, sexual situations, coarse language, or suggestive dialog.

R (Restricted)—specifically designed for adults. Anyone under the age of 17 should view programs that are rated R only with an accompanying parent or adult guardian. Such programs have one or more of the following: intense violence; intense sexual situations; strong, coarse language; or intensely suggestive dialogue.

NC-17 (No one under the age of 17 will be admitted)—should be viewed by adults only. Programs that are rated NC-17 have graphic violence; explicit sex; or crude, indecent language.

X (Adults Only)—contain one or more of the following: very graphic violence, very graphic and explicit or indecent sexual acts, or very coarse and intensely suggestive language.

TV PARENTAL GUIDELINES (TV BROADCASTERS)

TV Y (All Children)—designed to be appropriate for all children, especially ones ages 2–6. Programs rated TV-Y are not expected to frighten younger children.

TV Y7 (Directed to Older Children)—designed for children ages 7 and older. Programs rated TV-Y7 may be more appropriate for children who have acquired the development skills needed to distinguish between make-believe and reality. Such programs may include mild fantasy and comic violence (FV).

TV G (General Audience)—most parents will consider programs that are rated TV-G to be suitable for children of all ages. Such programs have little or no violence, no strong language, and little or no sexual dialogue or sexual situations.

TV PG (Parental Guidance Suggested)—contain material that parents may find unsuitable for younger children. This type of programming has one or more of the following: moderate violence (V), some sexual situations (S), infrequent coarse language (L), or some suggestive dialogue (D).

TV 14 (Parents Strongly Cautioned)—contain material that many parents will find unsuitable for children under 14 years of age. Such programs have one or more of the following: intense violence (V); intense sexual situations (S); strong, coarse language (L); or intensely suggestive dialogue (D).

TV MA (Mature Audience Only)—specifically designed to be viewed by adults and therefore may be unsuitable for children under 17. Such programs have one or more of the following: graphic violence (V); explicit sexual situations (S); or crude, indecent language (L).



SETTING UP THE AUTOLOCK™ ACCESS CODE

Your AutoLock™ access code allows you to enter the AutoLock™ submenus to set up or turn off blocking. Your access code is also the “key” that unlocks programs or channels that are being blocked by AutoLock™.

- 1** Press the **MENU** button on the remote control to show the onscreen menu.
- 2** Press the **CURSOR BUTTON DOWN** twice to highlight **FEA-TURES**.
- 3** Press the **CURSOR BUTTON RIGHT**. Then press the **CURSOR BUTTON DOWN** once to highlight the AutoLock control.
- 4** Press the **CURSOR BUTTON RIGHT** to highlight **ACCESS CODE**.
- 5** Press **0,7,1,1** on the remote control. **INCORRECT** will appear on the screen.
- 6** Press **0,7,1,1** on the remote control again. **ENTER NEW CODE** will appear on the screen.
- 7** Enter a new four-digit code using the number buttons. **CONFIRM CODE** will appear on the screen.
- 8** Enter your new four-digit code again. **CORRECT** will flash on the screen briefly.
- 9** Press the **STATUS/EXIT** button exit the menu.

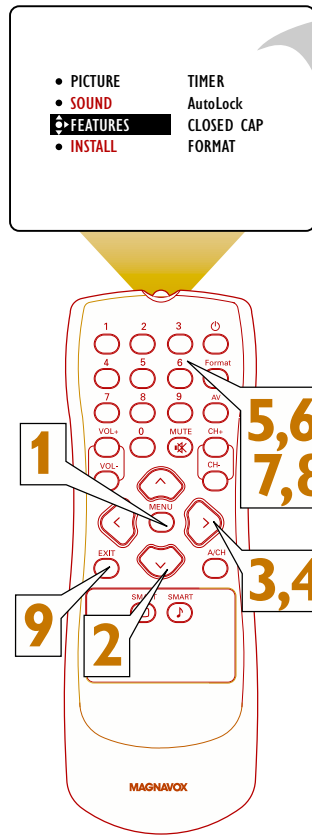

<ul style="list-style-type: none"> • PICTURE • SOUND • FEATURES • INSTALL 	<ul style="list-style-type: none"> TIMER AutoLock CLOSED CAP FORMAT
---	---

<ul style="list-style-type: none"> • TIMER • AutoLock • CLOSED CAP • FORMAT • 	<ul style="list-style-type: none"> TIME START TIME STOP TIME CHANNEL ACTIVATE
---	--

<ul style="list-style-type: none"> • TIMER • AutoLock • CLOSED CAP • FORMAT • 	<ul style="list-style-type: none"> ACCESS CODE ----
--	---

<ul style="list-style-type: none"> • TIMER • AutoLock • CLOSED CAP • FORMAT • 	<ul style="list-style-type: none"> ACCESS CODE ----
--	---

<ul style="list-style-type: none"> • TIMER • AutoLock • CLOSED CAP • FORMAT • 	<ul style="list-style-type: none"> ACCESS CODE X X X X
--	--

<ul style="list-style-type: none"> • TIMER • AutoLock • CLOSED CAP • FORMAT • 	<ul style="list-style-type: none"> ACCESS CODE X X X X INCORRECT
--	---

<ul style="list-style-type: none"> • TIMER • AutoLock • CLOSED CAP • FORMAT • 	<ul style="list-style-type: none"> ACCESS CODE ----
--	---

<ul style="list-style-type: none"> • TIMER • AutoLock • CLOSED CAP • FORMAT • 	<ul style="list-style-type: none"> ENTER NEW CODE X X X X
--	---

<ul style="list-style-type: none"> • TIMER • AutoLock • CLOSED CAP • FORMAT • 	<ul style="list-style-type: none"> ENTER NEW CODE ----
--	--

<ul style="list-style-type: none"> • TIMER • AutoLock • CLOSED CAP • FORMAT • 	<ul style="list-style-type: none"> CONFIRM CODE X X X X
--	---

<ul style="list-style-type: none"> • TIMER • AutoLock • CLOSED CAP • FORMAT • 	<ul style="list-style-type: none"> CONFIRM CODE ----
--	--

<ul style="list-style-type: none"> • TIMER • AutoLock • CLOSED CAP • FORMAT • 	<ul style="list-style-type: none"> CONFIRM CODE X X X X CORRECT
--	--

<ul style="list-style-type: none"> • TIMER • AutoLock • CLOSED CAP • FORMAT • 	<ul style="list-style-type: none"> CONFIRM CODE X X X X CORRECT
--	--

HELPFUL HINTS

- An X appears on screen to confirm the receipt of each digit by the TV as you input your AutoLock™ access code.
- Parents, it isn't possible for your child to unblock a channel without knowing your access code or changing it to a new one. If you discover that your access code has been changed, you can assume that blocked channels may have been viewed.

You can also set up a new access code from the main AutoLock™ Submenu using the SETUP CODE option. Simply enter and confirm the new Code to activate it.

<ul style="list-style-type: none"> • TIMER • AutoLock • BLOCK CHANNEL • SETUP CODE • CLEAR ALL • MOVIE RATING • TV RATING 	<ul style="list-style-type: none"> ENTER NEW CODE X X X X
---	---

<ul style="list-style-type: none"> • TIMER • AutoLock • BLOCK CHANNEL • SETUP CODE • CLEAR ALL • MOVIE RATING • TV RATING 	<ul style="list-style-type: none"> CONFIRM CODE X X X X CORRECT
---	--



USING CLEAR ALL

You can all your blocked channels and ratings at one time using the **CLEAR ALL** feature.

- 1** Press the **MENU** button on the remote control to show the onscreen menu.
- 2** Using the **CURSOR BUTTONS**, move to the **FEATURES** then **AUTOLOCK** control.
- 3** Press the **CURSOR RING RIGHT** again to highlight the **ACCESS CODE** input area. Enter your four-digit **ACCESS CODE**.
- 4** Press the **CURSOR BUTTON DOWN** repeatedly until **CLEAR ALL** is highlighted.
- 5** Press the **CURSOR BUTTON RIGHT** to clear all of your blocked channels and ratings.
- 6** Press the **STATUS/EXIT** button to exit the menu.

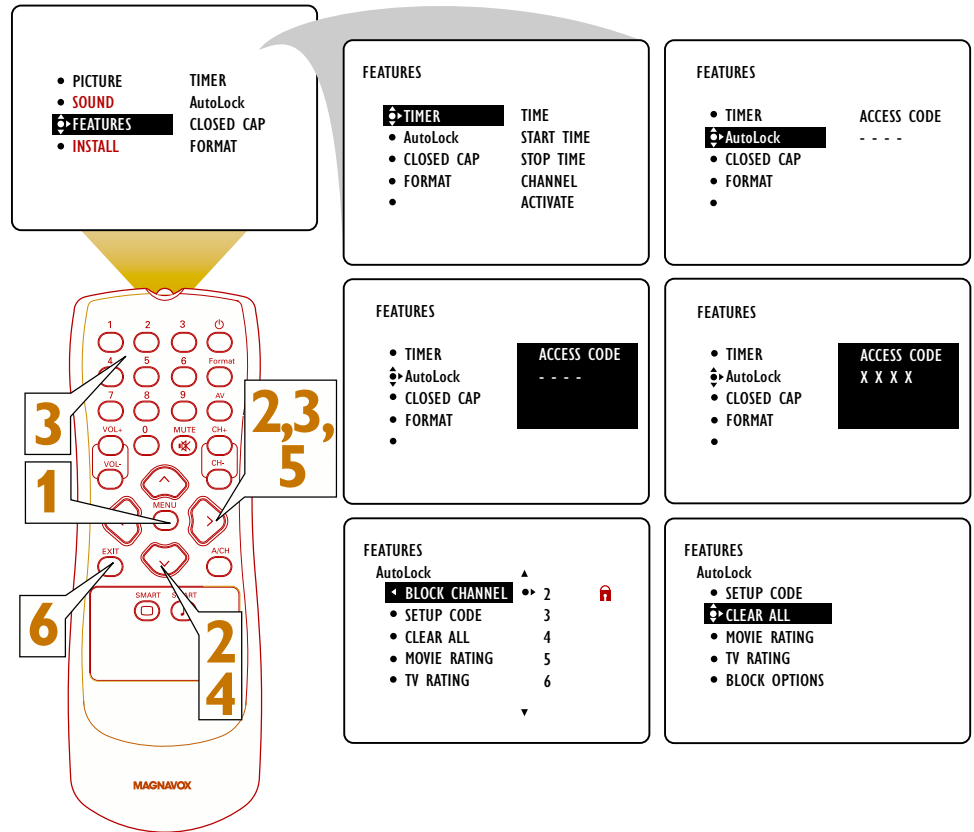

- PICTURE
 - SOUND
 - FEATURES
 - INSTALL
- TIMER
AutoLock
CLOSED CAP
FORMAT

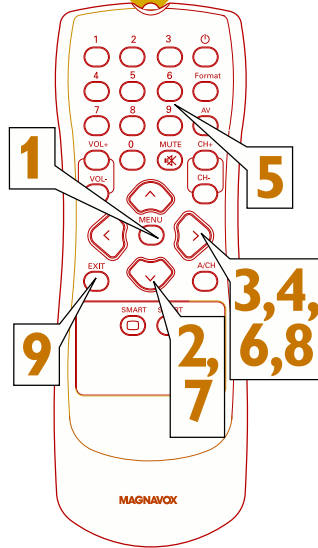

FEATURES

- **TIMER**
- AutoLock
- CLOSED CAP
- FORMAT

TIME
START TIME
STOP TIME
CHANNEL
ACTIVATE

FEATURES

- TIMER
- **AutoLock**
- CLOSED CAP
- FORMAT

ACCESS CODE
- - - -

FEATURES

- TIMER
- **AutoLock**
- CLOSED CAP
- FORMAT

ACCESS CODE
- - - -

FEATURES

- TIMER
- **AutoLock**
- CLOSED CAP
- FORMAT

ACCESS CODE
X X X X

FEATURES

AutoLock

- **BLOCK CHANNEL**
- SETUP CODE
- CLEAR ALL
- MOVIE RATING
- TV RATING

1 2 3 4 5

FEATURES

AutoLock

- **BLOCK CHANNEL**
- SETUP CODE
- CLEAR ALL
- MOVIE RATING
- TV RATING

1 2 3 4 5

FEATURES

AutoLock

- **BLOCK CHANNEL**
- SETUP CODE
- CLEAR ALL
- MOVIE RATING
- TV RATING

1 2 3 4 5

FEATURES

AutoLock

- **BLOCK CHANNEL**
- SETUP CODE
- CLEAR ALL
- MOVIE RATING
- TV RATING

2 3 4 5 6

FEATURES

AutoLock

- **BLOCK CHANNEL**
- SETUP CODE
- CLEAR ALL
- MOVIE RATING
- TV RATING

2 3 4 5 6

To block all channels at once, highlight ALL in the channel list. Then press the CURSOR RING RIGHT to block. Remove the blocks the same way.

FEATURES

AutoLock

- **BLOCK CHANNEL**
- SETUP CODE
- CLEAR ALL
- MOVIE RATING
- TV RATING

ALL 1 2 3 4

FEATURES

AutoLock

- **BLOCK CHANNEL**
- SETUP CODE
- CLEAR ALL
- MOVIE RATING
- TV RATING

ALL 1 2 3 4



USING AUTOLOCK™ TO BLOCK BY MOVIE RATING

After you have set your personal access code (see page 36), you can block programs by specific movie ratings.

- 1** Press the **MENU** button on the remote control to show the onscreen menu.
- 2** Press the **CURSOR BUTTON DOWN** twice to highlight **FEATURES**.
- 3** Press the **CURSOR BUTTON RIGHT**. Then press the **CURSOR BUTTON DOWN** once to highlight the **AutoLock** control.
- 4** Press the **CURSOR RING RIGHT** again to highlight **ACCESS CODE**.
- 5** Enter your **four-digit ACCESS CODE**. **CORRECT** will flash very briefly in red and the submenu will move to the left with **BLOCK CHANNEL** highlighted.
- 6** Press the **CURSOR BUTTON DOWN** repeatedly until **MOVIE RATING** is highlighted.
- 7** Press the **CURSOR BUTTON RIGHT** and the Rating submenu will shift to the left with **G** highlighted.
- 8** Press the **CURSOR BUTTON UP** or **DOWN** to highlight each rating you want. Then press the **CURSOR BUTTON RIGHT** to turn the rating **ON** or **OFF**. Turning the rating **ON** will block such programs from being seen.
- 9** Press the **STATUS/EXIT** button to exit the menu.

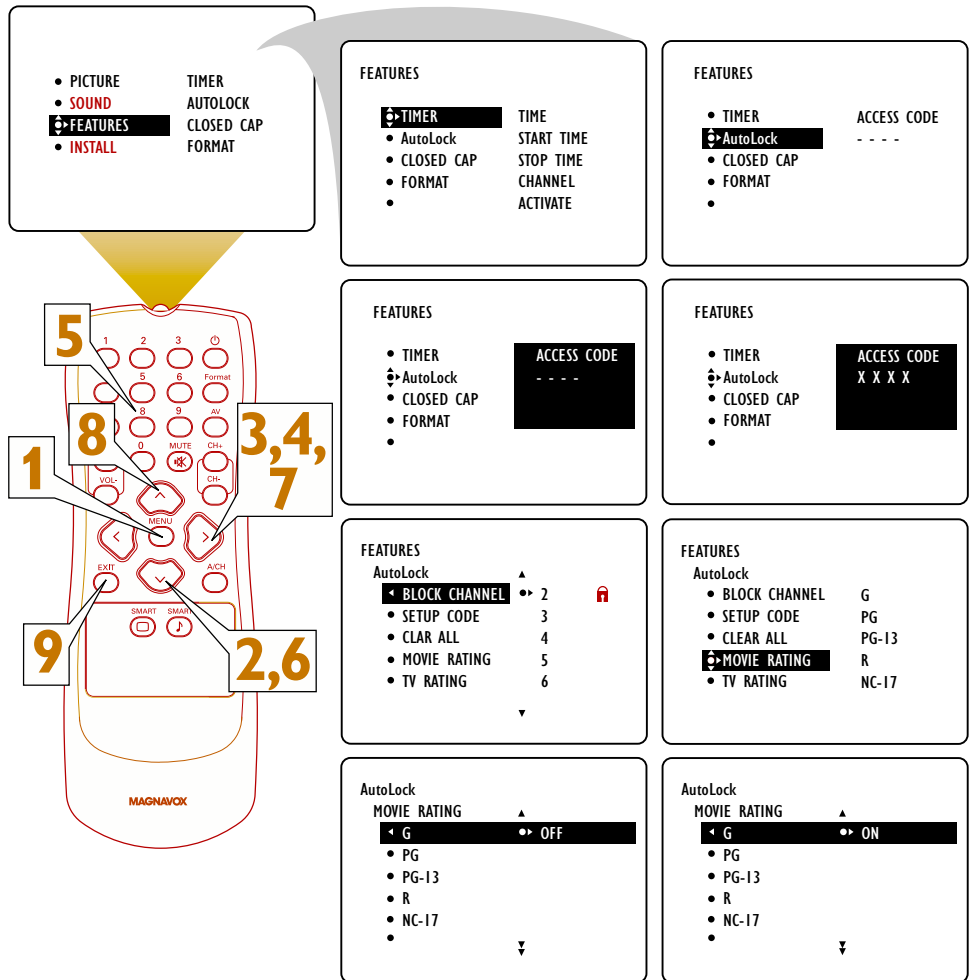

HELPFUL HINT

When a rating is set to be turned on (blocked), all higher ratings will also be blocked automatically. For example, if the R rating is turned on, the NC-17 and X ratings also will be turned on.



USING AUTOLOCK™ TO BLOCK BY TV RATING

You also can block programs by specific TV ratings. Follow these simple steps.

- 1** Press the **MENU** button on the remote control to show the onscreen menu.
- 2** Press the **CURSOR BUTTON DOWN** twice to highlight **FEATURES**.
- 3** Press the **CURSOR BUTTON RIGHT**. Then press the **CURSOR BUTTON DOWN** once to highlight the AutoLock control.
- 4** Press the **CURSOR RING RIGHT** again to highlight **ACCESS CODE**.
- 5** Enter your four-digit **ACCESS CODE**.
- 6** Press the **CURSOR BUTTON DOWN** repeatedly until **TV RATING** is highlighted.
- 7** Press the **CURSOR BUTTON RIGHT** to enter the **TV RATING** submenu.
- 8** Press the **CURSOR RING DOWN** or **UP** to select a rating.
- 9** Press the **CURSOR RING RIGHT** or **LEFT** to turn the block on the rating **ON** or **OFF**.
NOTE: More-specific subratings (for violence, sexual content, dialogue, or fantasy violence) are available for TV-Y7, TV-PG, TV-14, and TV-MA.
- 10** To access these subratings, press the **CURSOR RING RIGHT**. Press the **CURSOR RING UP** or **DOWN** to select the subrating that you want to block or unblock. Then press the **CURSOR RING RIGHT** or **LEFT** button to turn the block on the subrating **ON** or **OFF**.
- 11** Press the **STATUS/EXIT** button to exit the menu.

The sequence of onscreen menus is as follows:

- Initial menu: PICTURE, SOUND, **FEATURES**, INSTALL, TIMER, AutoLock, CLOSED CAP, FORMAT.
- Menu: **FEATURES**, AutoLock, CLOSED CAP, FORMAT, TIME, START TIME, STOP TIME, CHANNEL, ACTIVATE.
- Menu: **AutoLock**, CLOSED CAP, FORMAT, ACCESS CODE (----).
- Menu: **ACCESS CODE** (----).
- Menu: **ACCESS CODE** (XXXX).
- Menu: **AutoLock**, BLOCK CHANNEL (2), SETUP CODE (3), CLEAR ALL (4), MOVIE RATING (5), TV RATING (6).
- Menu: **AutoLock**, BLOCK CHANNEL (TV-Y), SETUP CODE (TV-Y7), CLEAR ALL (TV-G), MOVIE RATING (TV-PG), **TV RATING** (TV-14).
- Menu: **AutoLock**, **TV RATING** (TV-Y), TV-Y7, TV-G, TV-PG, TV-14.
- Menu: **TV RATING** (TV-Y), TV-Y7, TV-G, TV-PG, TV-14, **OFF**.
- Menu: **TV RATING** (TV-Y), TV-Y7, TV-G, TV-PG, TV-14, **ON**.

TV-Y (All Children)—designed to be appropriate for all children, especially ones ages 2–6. Programs rated TV-Y are not expected to frighten younger children.

TV-Y7 (Directed to Older Children)—designed for children ages 7 and older. Programs rated TV-Y7 may be more appropriate for children who have acquired the development skills needed to distinguish between make-believe and reality. Such programs may include mild fantasy and comic violence (FV).

TV-G (General Audience)—likely to be considered suitable for children of all ages. Such programs have little or no violence, no strong language, and little or no sexual dialogue or sexual situations.

TV-PG (Parental Guidance Suggested)—contain material that parents may find unsuitable for younger children. This type of programming has one or more of the following: moderate violence (V), some sexual situations (S), infrequent coarse language (L), or some suggestive dialogue (D).

TV-14 (Parents Strongly Cautioned)—contain material that many parents will find unsuitable for children under 14 years of age. Such programs have one or more of the following: intense violence (V); intense sexual situations (S); strong, coarse language (L); or intensely suggestive dialogue (D).

TV-MA (Mature Audience Only)—specifically designed to be viewed by adults and therefore may be unsuitable for children under 17. Such programs have one or more of the following: graphic violence (V); explicit sexual situations (S); or crude, indecent language (L).



TURNING THE AUTOLOCK™ BLOCKING CONTROL ON OR OFF

The BLOCKING control can be thought of as the “master switch” for AutoLock™. Use it to turn ON or OFF all of the settings (based on ratings).

- 1** Press the **MENU** button on the remote control to show the onscreen menu.
- 2** Press the **CURSOR BUTTON DOWN** twice to highlight **FEATURES**.
- 3** Press the **CURSOR BUTTON RIGHT**. Then press the **CURSOR BUTTON DOWN** once to highlight the AutoLock control.
- 4** Press the **CURSOR RING RIGHT** again to highlight **ACCESS CODE**.
- 5** Enter your **four-digit ACCESS CODE**.
- 6** Press the **CURSOR BUTTON DOWN** repeatedly until **BLOCK OPTIONS** is highlighted.
- 7** Press the **CURSOR BUTTON RIGHT** to enter the **BLOCK OPTIONS** submenu. **BLOCKING** will be highlighted.
- 8** Press the **CURSOR RING RIGHT** or **LEFT** to turn **BLOCKING ON** or **OFF**.
- 9** Press the **STATUS/EXIT** button to exit the menu.

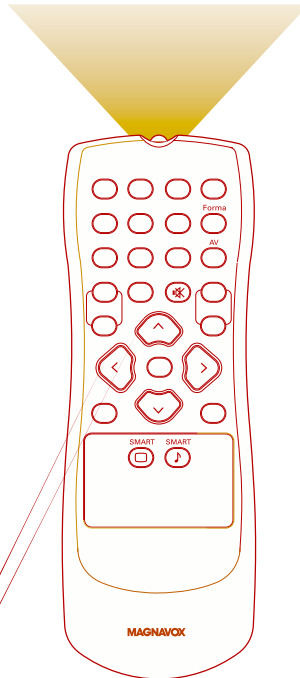

USING AUTOLOCK™ TO BLOCK UNRATED BROADCASTS



In addition to blocking rated programs or channels, you may also choose to block all programming that is unrated. Unrated programming consists of shows that the MPAA (Motion Picture Association of America) or the TV broadcasters have chosen not to rate.

- 1** Press the **MENU** button on the remote control to show the onscreen menu.
- 2** Press the **CURSOR BUTTON DOWN** twice to highlight **FEATURES**.
- 3** Press the **CURSOR BUTTON RIGHT**. Then press the **CURSOR BUTTON DOWN** once to highlight the **AutoLock** control.
- 4** Press the **CURSOR RING RIGHT** again to highlight **ACCESS CODE**.
- 5** Enter your **four-digit ACCESS CODE**.
- 6** Press the **CURSOR BUTTON DOWN** repeatedly until **BLOCK OPTIONS** is highlighted.
- 7** Press the **CURSOR BUTTON RIGHT** to enter the **BLOCK OPTIONS** submenu.
- 8** Press the **CURSOR RING DOWN** once to select **BLOCK UNRATED**.
- 9** Press the **CURSOR RING RIGHT** or **LEFT** to turn **BLOCK UNRATED** ON or OFF.
- 10** Press the **STATUS/EXIT** button to exit the menu.

The diagram shows a remote control with callouts 1 through 10. Callout 1 points to the MENU button. Callout 2 points to the DOWN arrow. Callout 3 points to the RIGHT arrow. Callout 4 points to the RIGHT arrow. Callout 5 points to the numeric keypad. Callout 6 points to the DOWN arrow. Callout 7 points to the RIGHT arrow. Callout 8 points to the DOWN arrow. Callout 9 points to the RIGHT arrow. Callout 10 points to the EXIT button.

The onscreen menu sequence is as follows:

- MAIN MENU: PICTURE, SOUND, **FEATURES**, INSTALL, TIMER, AutoLock, CLOSED CAP, FORMAT
- FEATURES: **TIMER**, AutoLock, CLOSED CAP, FORMAT, TIME, START TIME, STOP TIME, CHANNEL, ACTIVATE
- FEATURES: **AutoLock**, ACCESS CODE: - - - -
- FEATURES: **ACCESS CODE**: - - - -
- FEATURES: **ACCESS CODE**: X X X X
- FEATURES: AutoLock, **BLOCK CHANNEL** (2), SETUP CODE (3), CLEAR ALL (4), MOVIE RATING (5), TV RATING (6)
- FEATURES: AutoLock, SETUP CODE, CLEAR ALL, MOVIE RATING, TV RATING, **BLOCK OPTIONS**
- AutoLock: **BLOCK OPTIONS**, BLOCKING, **BLOCK UNRATED** (OFF), NO RATING
- AutoLock: **BLOCK OPTIONS**, BLOCKING, **BLOCK UNRATED** (ON), NO RATING

HELPFUL HINT

When the **BLOCK UNRATED** control is turned ON, attempts to view unrated programs will bring to the screen a message like the one shown to the right. To watch the program, enter your access code or go into the **BLOCK OPTIONS** submenu and turn the **BLOCK UNRATED** control OFF.

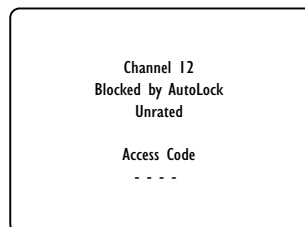



USING AUTOLOCK™ TO BLOCK BROADCASTS THAT HAVE NO RATING

Some programs contain no content advisories from the Motion Picture Association of America or the television broadcasters (see page 35). To block programs with no rating, follow these steps.

- 1** Press the **MENU** button on the remote control to show the onscreen menu.
- 2** Press the **CURSOR RING DOWN** twice to highlight **FEATURES**.
- 3** Press the **CURSOR BUTTON RIGHT**. Then press the **CURSOR BUTTON DOWN** once to highlight the **AutoLock** control.
- 4** Press the **CURSOR RING RIGHT** again to highlight the **ACCESS CODE** input area.
- 5** Enter your four-digit **ACCESS CODE**.
- 6** Press the **CURSOR BUTTON DOWN** repeatedly until **BLOCK OPTIONS** is highlighted.
- 7** Press the **CURSOR BUTTON RIGHT** to enter the **BLOCK OPTIONS** submenu.
- 8** Press the **CURSOR RING DOWN** twice to highlight **NO RATING**.
- 9** Press the **CURSOR RING RIGHT** or **LEFT** to turn **NO RATING ON** or **OFF**.
- 10** Press the **STATUS/EXIT** button to exit the menu.

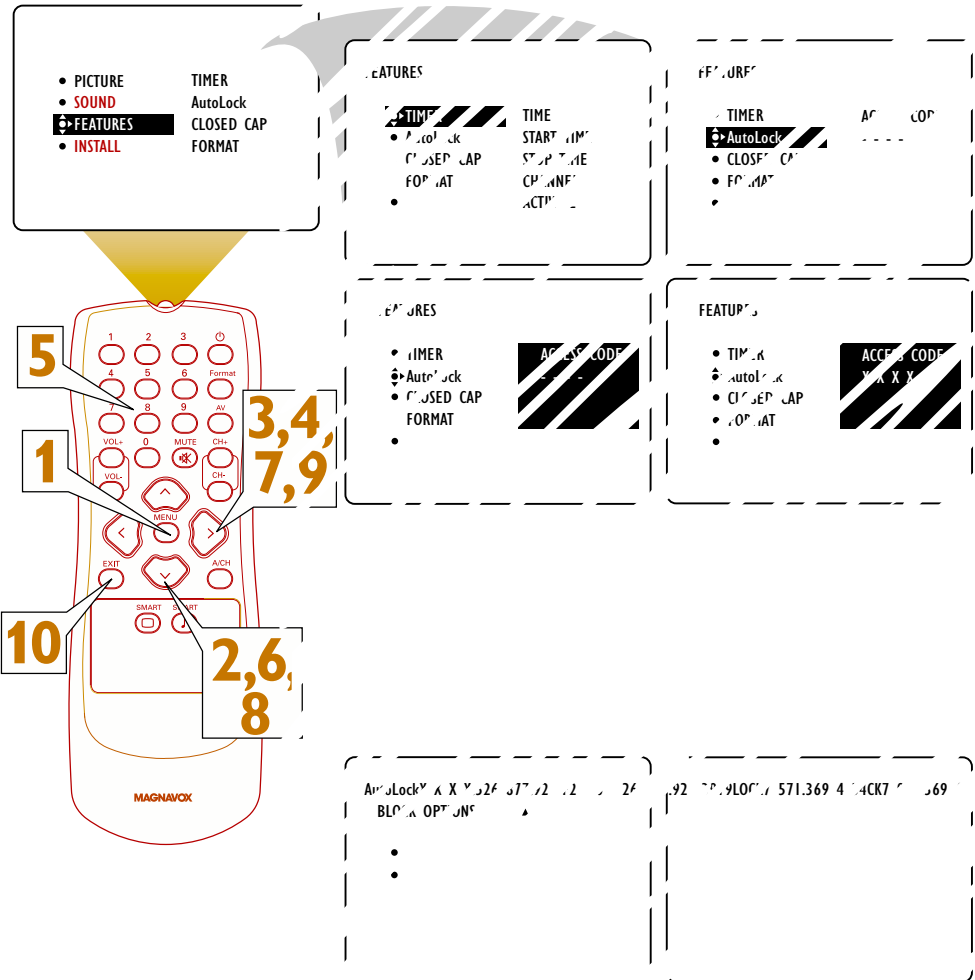

USING THE CLOSED CAPTIONING CONTROL



Closed Captioning (CC) allows you to read the voice content of television programs on the TV screen. Designed to help the hearing impaired, this feature uses onscreen text boxes to show dialogue and conversations while the TV program is in progress.

- 1** Press the **MENU** button on the remote control to show the onscreen menu.
- 2** Press the **CURSOR BUTTON DOWN** twice to highlight **FEATURES**.
- 3** Press the **CURSOR BUTTON RIGHT** to enter the **FEATURES** sub-menu.
- 4** Press the **CURSOR BUTTON DOWN** repeatedly until the **CLOSED CAP** control is highlighted.
- 5** Press the **CURSOR BUTTON RIGHT**. The submenu will shift to the left and **CAPTION MODE** will be highlighted. Then press the **CURSOR BUTTON RIGHT** again to highlight the **CAPTION MODEs** area.
- 6** Press the **CURSOR BUTTON UP** or **DOWN** to select a **CAPTION MODE**.

NOTES:

- CC1 mode is the usual setting. CC2, CC3, and CC4 may not be supported by broadcast stations.
- The **CC MUTE** option turns the Closed Captioning mode on whenever the **MUTE** button on the remote control is pushed. Select **CC MUTE** in the onscreen submenu to turn this feature on.

- 7** Press the **CURSOR BUTTON LEFT** to return to the **CLOSED CAP** submenu. Then press the **CURSOR BUTTON DOWN** to highlight **CC DISPLAY**.
- 8** Press the **CURSOR BUTTON RIGHT** to turn the onscreen display of Closed Captioning on or off. Closed Captioning will be shown only if the TV station broadcasting on the channel has the feature available.
- 9** Press the **STATUS/EXIT** button to exit the menu.

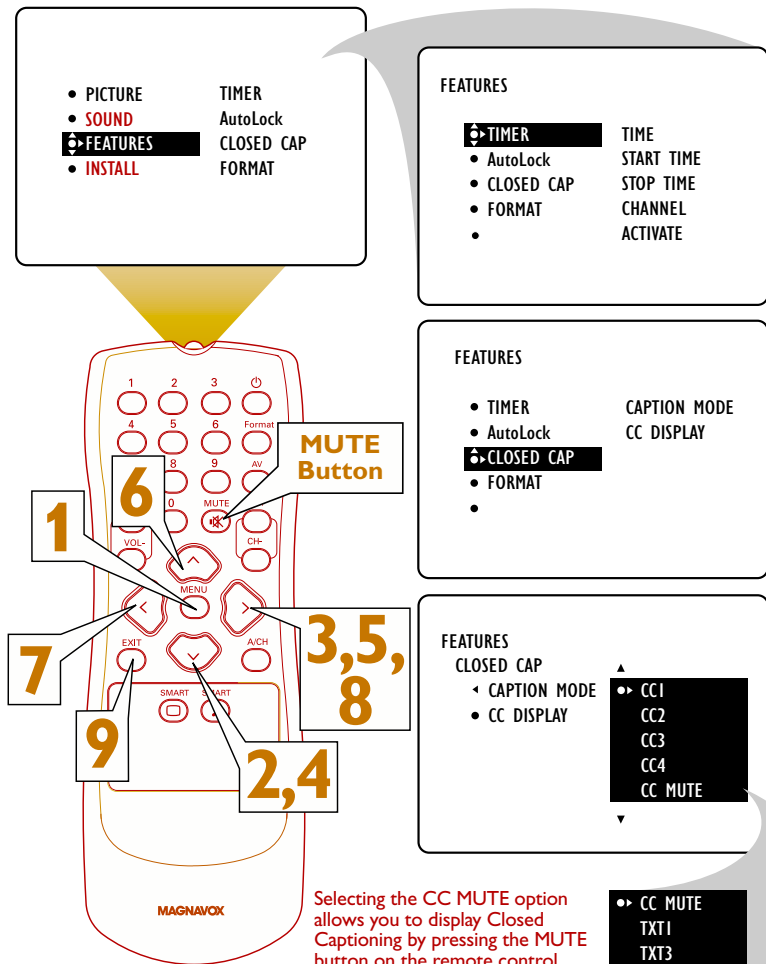

Selecting the **CC MUTE** option allows you to display Closed Captioning by pressing the **MUTE** button on the remote control. Note, however, that the program you are watching must be providing Closed Captioning. You must also be sure **CC DISPLAY** is turned ON.

HELPFUL HINTS

- Refer to your area's TV program listings for the stations and times of shows being broadcast with Closed Captioning.
- Broadcasters determine the content of captions. Any occurrences of misspellings, incorrect grammar, or strange characters are not the result of TV malfunction.

FEATURES
CLOSED CAP
• CAPTION MODE
◀ CC DISPLAY ▶ ON

OR

◀ CC DISPLAY ▶ OFF

CAPTION Mode
Example Display



TEXT Mode
Example Display
The TV program is blocked by the Text screen.



The picture-format modes are available for use only with video sources connected to the ANTENNA, AV1, CVI, AV2, and AV3 (Side Panel) inputs on the TV. Control the picture formats of video sources connected to the HD inputs through the set-top box (for HD programming) or pro-gressive-scan-capable DVD player (for DVD programs)



USING THE PICTURE-FORMAT CONTROL



Selecting a picture Format Using the Menu

In addition to the **FORMAT** button, you can also adjust the picture format by using the on-screen menu.

- 1** Press **MENU** button on the remote control to show the onscreen menu.
- 2** Press the **CURSOR RING DOWN** twice to highlight **FEATURES**.
- 3** Press the **CURSOR BUTTON RIGHT** to enter the **FEATURES** sub-menu.
- 4** Press the **CURSOR BUTTON DOWN** repeatedly until **FORMAT** is highlighted.
- 5** Press the **CURSOR BUTTON RIGHT** or **LEFT** to select a picture format: 4:3, EXPAND 4:3, PANORAMA, WIDE SCREEN, or AUTO.
- 6** Press the **STATUS/EXIT** button to exit the menu.

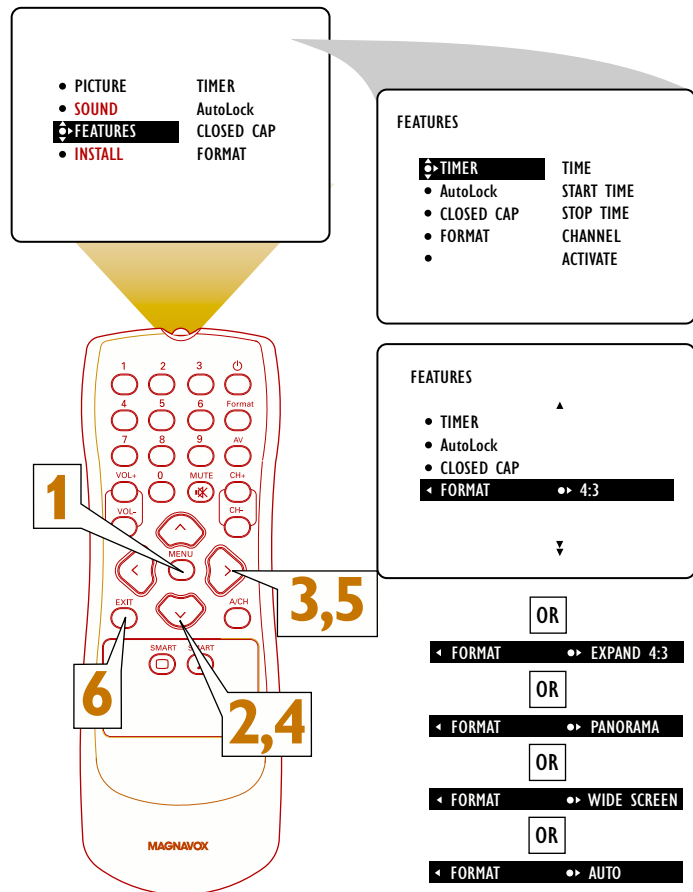

WARNING

To prevent uneven picture-tube aging, do not leave nonmoving images or border bars on the screen for an extended period. See page 49.

HELPFUL HINT

The TV's Picture-format options are available only with video sources connected to the ANTENNA, AV1, CVI, AV2, AV3 (side panel) inputs on the TV. The picture formats of video sources connected to the HD inputs are controlled through the HD set-top box or progressive-scan-capable DVD player providing the video source.



Your set's HD input, HD INPUT-AV 4 is designed to accept high-definition signal standards 480p and 1080i as specified by the Electronic Industries Association. Output standards may vary by manufacturer. Refer to the directions-for-use manual for the digital equipment before connecting.

HD INPUT-AV 4

When the Inputs Are Used with Component Video Signals

Y INPUT: 1.0 V_{p-p} (includes sync), 75 ohms

Pr INPUT: 700m V_{p-p}, 75 ohms

Pb INPUT: 700m V_{p-p}, 75 ohms

NOTES:

The Pb INPUT jack can also receive signals from outputs labeled Cb or B-Y.

The Pr INPUT jack can also receive signals from outputs labeled Cr or R-Y.

When the Inputs Are Used with RGB Video Signals

G/Y: 1.0 V_{p-p}, 75 ohms (compatible with sync on green)

R/Pr: 700 mV_{p-p}, 75 ohms

B/Pb: 700 mV_{p-p}, 75 ohms

H: 3 V_{p-p} ± 1.0 V, 1 kohm (when using separate H and V sync)

V: 3 V_{p-p} ± 1.0 V, 1 kohm (when using separate H and V sync).

HELPFUL HINTS

- No industry standards have been established for HD television RGB signal systems, timing, synchronization, and signal strengths. The HD INPUT-AV 4 RGB inputs on your Magnavox TV will not be compatible with all digital equipment that offers RGB outputs. If the digital equipment you want to connect offers both component video and RGB, component video is the suggested type of connection to use.
- Your TV's onscreen INSTALL submenu provides the option of switching the AV4 signal sources between YPbPr and RGB color-space settings. The option is available only when have selected the AV4 signal source (using the AV button on the remote or the Source Select button on the TV). The default setting for AV4 is YPbPr.

MODEL SPECIFICATIONS**Product Type**

Rear-projection HDTV Monitor

Television System

NTSC standard

Channel Coverage

VHF: 2–13

UHF: 14–69

Cable TV: Midband

Superband

Hyperband

Ultraband

Power SourceAC 110V $\pm 10\%$, 60 Hz**Power Consumption**

255 W (average), standby <1W

Audio Power2 x 5 W, 100 Hz–10 kHz at 5% THD (flat response),
8-ohm load**Speaker Type**

4 x 6 oval

Video/Audio Terminals**INPUT-AV 1**

VIDEO (composite): 1 Vp-p, 75 ohms

AUDIO: 500 mVrms, 30 kohm

COMPONENT VIDEO INPUTS (YPbPr)

Y INPUT: 1.0Vp-p (includes sync), 75 ohms

Pb INPUT: 700mVp-p, 75 ohms

Pr INPUT: 700mVp-p, 75 ohms

(The Pb INPUT jack can also receive signals from outputs labeled Cb or B-Y. The Pr INPUT jack can also receive signals from outputs labeled Cr or R-Y.)

S-VIDEO INPUT (INPUT-AV2)

Y-INPUT: 1 Vp-p (includes sync), 75 ohms

C-INPUT: 300 mVp-p, 75 ohms

INPUT-AV 2

VIDEO (composite): 1 Vp-p, 75 ohms

AUDIO: 500 mVrms, 30 kohm

HD INPUT-AV 4

Component Video YPrPb/RGB

AUDIO: 500 mVrms, 30 kohm

Side Panel (AV3)

VIDEO (composite): 1 Vp-p, 75 ohms

AUDIO: 500 mVrms, 30 kohm

Picture Visible Area

1295 mm (51 in.)

Dimensions

1250 mm (W) x 1250 mm (H) x 580 mm (D)

(49 in. x 49 in. x 27.8 in.)

Weight (does not include carton)

83 kg (183 lb)

Supplied Accessories

Remote control.

Design and specifications are subject to change without notice.



WARNING Concerning Stationary Images on the TV Screen:

Do not leave picture border bars or stationary images on screen for extended periods of time. This can cause uneven picture-tube aging.

Normal use of the TV should involve the showing of pictures that contain constantly moving and changing images that fill the screen. Be careful not to leave nonmoving images on screen for extended periods of time, or to display the same images on screen too frequently, because subtle ghost images can be left on the picture tubes. Avoid showing pictures with border bars or the same stationary images more than 15 percent of your total viewing in any one week. Sources of stationary images may be broadcast channels, cable channels, satellite channels, digital television boxes, DVD discs, laser discs, video games, CD-i discs, videotapes, and others. **Here are some examples of stationary images (this is not an all-inclusive list; you may encounter others in your viewing):**

- **Border bars**—solid bars shown when viewing a standard (4:3) picture and some widescreen movies on your widescreen (16:9) TV
- **DVD menus**—listings of DVD disc content
- **Video-game images and scoreboards**
- **Television station logos**—present a problem if they are bright and stationary; moving or low-contrast graphics are less likely to cause uneven aging of the picture tube
- **Stock-market tickers**—presented at the bottom of the TV screen
- **Shopping channel logos and pricing displays**—bright and shown constantly or repeatedly in the same location on the TV screen.

All picture tubes age with use, with their light output diminishing over time. But by maintaining normal use—mixing television picture types—you will create conditions in the tubes age at an even rate. The result will be a TV picture that is evenly bright over the entire screen.

PLACEMENT OF THE TV

- To avoid cabinet warping, cabinet color changes, and increased chance of set failure, do not place the TV where temperatures can become excessively hot; for example, in direct sunlight or near a heating appliance.
- Be sure to allow a free flow of air to and from the perforated back cover of the set.

CLEANING

- To avoid possible shock hazard, be sure the TV is unplugged from the electrical outlet before cleaning.
- Regularly dust the TV with a dry, non-scratching duster to keep the TV clean.
- When cleaning the TV, take care not to scratch or damage the screen surface. Avoid wearing jewelry or using anything abrasive. Do not use household cleaners. Wipe the front screen with a clean cloth dampened with water. Use even, easy, vertical strokes when cleaning.
Specially designed screen-cleaning kits are also available. These kits contain anti-static cleaners and cloths designed to get into the ridges of the TV screen. Purchase the kits at stores that sell electronics. Or call our Customer Care Center at 1-800-531-0039.
- Gently wipe the cabinet surfaces with a clean cloth or sponge dampened in a solution of cool, clear water and a mild soap or detergent. Use a clean, dry cloth to dry the wiped surfaces.
- Occasionally vacuum the ventilation holes or slots in the back cover of the set.
- Never use thinners, insecticide sprays, or other chemicals on or near the cabinet, as they might cause permanent marring of the cabinet finish.



TROUBLESHOOTING

Check This List of Symptoms and Possible Solutions Before Requesting Service

You may be able to solve the problem yourself. Charges for TV installation and adjustment of customer controls are not covered under your warranty.

If you need to call a customer service representative, please know the model number and serial number of your product before you call. This information is displayed on the back of the product. Also, please take a moment to identify the problem you are having, and be prepared to explain this to the representative. If you believe the representative will need to help you with operations, please stay near the product. Our representative will be happy to assist you. **To reach our Customer Care Center, call 1-800-531-0039.**

Difficulties and Possible Solutions

***Q refers to the Quick Use and Setup Guide that came with your TV.**

The TV remote control does not work

- Check that the batteries are installed correctly. *See page Q-2*.*
- If the batteries are dead, replace them with two “AA” size heavy duty (zinc chloride) or alkaline batteries. *See page *Q-2.*
- Be no farther than 30 feet from the TV when using the remote control and point the remote toward the remote-sensor window on the TV. *See page *Q-2 for the location of the remote-sensor window.*
- Clean the remote control and the remote-sensor window on the TV. *See page *Q-2 for the location of the remote-sensor window.*
- Check the TV power cord. Unplug the TV, wait 10 seconds, then reinsert the plug into the outlet and push the remote power or TV power/standby button again. *To locate the TV power/standby button, see page *Q-2.*
- If you have your TV plugged into an AC power strip, ensure that the fuse on the power strip is not blown.
- Check to see if the TV is on a wall switch.

The TV has no power

- Check the TV’s power cord. Unplug the TV, wait 10 seconds, then reinsert the plug into the outlet and push the remote-control power or TV power/standby button again. *The location of the TV power/standby button is illustrated on page *Q-2.*
- Check that the outlet is not on a wall switch.
- If you are using an AC power strip, be sure the fuse on the power strip is not blown.

You cannot get a picture

- Be sure that you have made signal connections correctly and securely. *See pages *Q-1, *Q-2, 6–9, and 11–16.*
- Check the Tuner Mode control for the correct tuner setting. *See page *Q-4.*
- Try running the Auto Program feature. *See page *Q-4.*
- Ensure that you have selected the correct picture signal source using the AV (remote) or Source Select (TV) buttons. *See page 17.*
- If you are attempting to view a picture from a progressive-scan-capable DVD player connected to the HD INPUT-AV 4 jacks, ensure that you have switched the DVD player to progressive-scan mode. *See page 12, as well as the DVD player’s directions-for-use manual.*
- If you are using an HD receiver, ensure that its output is set correctly (HD or SD) based on the connection to the TV you have made. *See pages 14 and 15. Also, refer to the directions-for-use manual that came with the HD receiver.*

Picture is fuzzy or out of focus

Check the set’s convergence and adjust if necessary. *See page *Q-7.*

You cannot see a picture when you play a VCR tape

Press the AV button on the remote control or the Source Select button on the TV until you have selected the source to which you connected the VCR. *See page 17 (AV button) or page *Q-3 (Source Select button).*

You cannot tune to a particular channel

- Use the number buttons on the remote instead of the CH +/- buttons. *See page *Q-3 (remote-control buttons).*
- If necessary, select the Tuner Mode and run Auto Program to store channels to the set’s memory. *See page *Q-4.*

You see scrolling images

Check to ensure that you have made connections correctly. *See pages *Q-1, *Q-2, 6–9, and 11–16.*



TROUBLESHOOTING (CONTINUED)

Difficulties and Possible Solutions (*Q refers to the Quick Use and Setup Guide that came with your TV.)

The picture has no color or colors are not correct

- Check to ensure that you have made connections correctly. *See pages *Q-1, *Q-2, 6–9, and 11–16.*
- If the picture has red or blue fringes, you may need to adjust the convergence. *See page *Q-7.*

You are not able to get sound

- Check the Volume buttons on the remote control or on the TV. *See pages *Q-2 (TV buttons) and *Q-3 (remote-control buttons).*
- Check the Mute button on the remote. *See page *Q-3 for the location of the Mute button.*
- Check the Audio Out and Speaker controls. *See page 11.*
- If you have connected auxiliary sound equipment, check to ensure that you have made the audio connections correctly. *See pages 6–16.*

TV displays wrong channel or no channels above 13

- Try selecting the channel again.
- Add the desired channel numbers into the TV using the Channel Edit control. *See page *Q-5.*
- Check to ensure that the Tuner Mode is properly set and run Auto Program. *See page *Q-4.*



GLOSSARY OF TELEVISION TERMS

Alternate Channel • The feature that allows you to toggle between the last two channels viewed by pressing the A/CH button on the remote control.

Audio/Video Inputs • Jacks (standard RCA), located on the rear of the TV, used for the input of audio and video signals. These jacks are designed for use with VCRs (or other accessories) to receive higher picture resolution and offer sound-connection options.

Auto Program • The feature that, when activated, scans for all available channels from regular antenna or cable signals and stores only active broadcast stations in the TV's memory.

Channel Edit • The feature that allows you to add or delete channels from the list of channels stored in the TV's memory. Channel Edit makes it easy to limit or expand the number of channels that are available to you when you press the CH +/- buttons on your remote control.

Closed Captioning • The broadcast standard feature that allows you to read the voice content of television programs on the TV screen. Designed to help the hearing impaired, Closed Captioning uses onscreen text boxes to show dialogue and conversations while a TV program is in progress.

Coaxial Cable • A single solid wire normally matched with a metal plug (F-type) end connector that screws (or pushes) directly onto a 75-ohm input found on the television or VCR.

Comb Filter • TV filter that removes distortion, resulting in a sharper and purer color display. The comb filter addresses the annoying cross-color distortion that may occur in TV broadcasts when, for example, the presenter wears a striped or checked jacket.

Component Video Inputs • Inputs that allow the separate reception of blue, red, and luminance signals. These inputs provide the highest possible color and picture resolution in the playback of digital signal-source material, such as the kind available from DVD players. Component video inputs allow for improved bandwidth information not possible through composite video or S-Video connections.

Composite Video Input • An input in which all the components required for displaying the onscreen image are combined in one signal.

Convergence • The technique used in color TV for bringing the red, green, and blue color beams together so that they hit the same part of the picture tube screen at the same time. This avoids color fringes around images in the picture.

High-definition Television (HDTV) • High-resolution digital television. HDTV is high-resolution digital television. It has life-like pictures, and with it films retain their original width, enhancing the home theater experience.

Incredible Surround™ • False acoustic management of the audio signal that produces a dramatic expansion of the wall of sound that surrounds the listener and heightens overall viewing pleasure.

Interlaced • A picture-scanning technique that improves the appearance of onscreen motion. It also helps smooth jagged lines that are sometimes seen on curved and angled surfaces in the picture.

Menu • An onscreen list of feature controls available for you to adjust or set.

NTSC • National Television Standards Committee format devised in the 1940s for TV broadcast analog video signals (525

lines: 30 Hz).

Onscreen Displays (OSD) • The wording or messages generated by the television (or VCR) to help you with specific feature controls (color adjustment or programming, for example).

Progressive Scan • A picture-scanning technique that doubles the number of picture lines, eliminating the flicker and providing a jitter-free picture.

PTV • Projection Television. (Rear- and/or front-projection design systems are available.)

Remote-control Sensor Window • The window or opening found on the television control panel through which infrared remote-control command signals are received.

RGB • Red, green, and blue signal. These are the primary colors of light that are used to produce a picture in television. By mixing levels of R, G, and B, all colors (chrominance and luminance) are reproduced.

RF • Radio Frequency or modulated signal design used as the carrier for television broadcasts.

Second Audio Program (SAP) • An additional audio channel provided for in the Multichannel Television Sound (MTS) broadcast standard. A monaural soundtrack included within the recorded or video signal (usually containing a second language translation for the displayed programming).

Status/Exit Button • Remote-control button that, when pressed, shows the current channel number, name (if set), time (if set), and sound setting (stereo, mono, SAP, or mute). Pressing the button twice shows the current AutoLock™ settings. Pressing the button once when an onscreen display is showing removes the onscreen display. You can use Status/Exit rather than having to wait for the displays to "time out," or automatically disappear from the screen.

S-Video Input • Signal input that allows direct connection of high-resolution video sources, such as a satellite receiver, DVD player, S (Super)-VHS videocassette recorder, or video games. Provides improved picture resolution, sharpness, and clarity.

480p • Digital picture format with 704 x 480 pixels, sent at 60 complete frames per second. This is the output format of progressive-scan DVD players.

1080i • Digital high-definition picture format with 1920 x 1080 pixels, sent at 60 interlaced frames per second (30 complete frames per second).

Tint • TV function that allows you to change the general color balance between cool and warm. Adjust tint according to your personal preference.

Twin-lead Wire • The more commonly used name for the two-strand, 300-ohm antenna wire used with many indoor and outdoor antenna systems. In many cases, this type of antenna wire requires an additional adapter (or balun) in order to connect to the 75-ohm input terminals designed into the more recent TVs and VCRs.



- A**
 Alternate Channel (A/CH), 20, 53
 APAC™, 5
 Audio/Video Inputs (Definition), 6, 53
 AutoChron™ Control, *Q-5
 AutoLock™ Control
 Access code, 36
 Blocking channels, 38
 Clear All, 37
 Movie ratings, 39
 No rating broadcasts, 43
 On/off control, 41
 Settings review, 43
 Setup Code, 36
 TV ratings, 40
 Understanding AutoLock™, 35
 Unrated broadcasts, 41
 Smart Picture™, 19
 Auto Program, *Q-4, 53
 Smart Sound™, 18
 AV Button, 17
 AVL Control, 25
- B**
 Balance Control, 24
 Bass Boost Control, 29
 Bass Control, 24
 Brightness Control, 21
 Buttons (TV), *Q-2
 Buttons (Remote), *Q-3
- C**
 Cables/connectors, *Q-1, 6
 Channel Edit Control, *Q-5, 53
 Cleaning (TV/Screen), 50
 Clock (See Timer Control)
 Closed Captioning Control, 45, 53
 Coaxial Cable (Definition), 53
 Color Control, 21
 Color Temp Control, 21
 Component Video Inputs (Definition), 53
 Composite Video Input (Definition), 53
 Connections
 Antenna/cable, *Q-1
 Cable converter box, *Q-1
 Camcorder, 16
 Compatibility, 6, 7, 48
 DVD player, 12–13
 HD receiver, 15
 Hi-fi system, 11
 Satellite receiver (standard), 12, 14
 S-Video device, 14
 VCR, 9
 VCR and cable box, 10
 Convergence Controls
 Red/blue, *Q-7
 Restore factory, *Q-7
 Multipoint red/blue, *Q-7
 Save multipoint settings, *Q-7
 Undo multipoint, *Q-7
- G**
 Glossary, 53
- H**
 High-definition Television (Definition), 53
- I**
 Inputs (See Panel Jacks)
- L**
 Language Control
 (See Menu Language Control)
- M**
 Menu, *Q-3, 53
 Menu Language Control, *Q-4
 Movie Ratings, 35
 MPAA, 35, 53
 Mute Button, *Q-3, 45
- N**
 Name Control, *Q-6
 NTSC, 52
- O**
 Onscreen Displays (Definition), 53
- P**
 Panel Jacks (Overviews), 6, 7
 Picture Button (see Smart Picture™)
 Picture Control, 21
- R**
 Registration/Welcome, 2
 Remote Control
 Battery installation/caution, *Q-2
 Button descriptions, *Q-3
 Sensor Window, *Q-2, 53
 Usage, *Q-2
 RF (Definition), 53
- S**
 Safety/Precautions, *Q-2, 2, 3
 SAP, 28, 52
 Sharpness Control, 21
 Smart Contrast Control, 23
 Smart Scan Control, 22
 Source Select Button, *Q-2, 17
 Specifications, 48
 Stationary Images/Warning, 50
 Status/Exit Button, *Q-3, 53
 Stereo/Mono Control, 27
 Surround-sound Modes, 26
 S-Video, *Q-1, 6, 14
- T**
 Timer Control,
 Activate, 34
 Channel, 33
 Clock, 30
 Start time, 32
 Stop time, 32
 Time display, 31
 Tint Control, 21, 53
 Treble Control, 24
 Troubleshooting, 51–52
 Tuner Mode, *Q-4
 Twin-lead Wire (Definition), 52
- V**
 Volume Control, *Q-2, *Q-3
- W**
 Warranty, 60

This page intentionally left blank.

MAGNAVOX LIMITED WARRANTY

One (1) Year Labor & One (1) Year Parts & One (1) Year Display Repair

MAGNAVOX warrants this product against defect in material or workmanship, subject to any conditions set forth as follows:

PROOF OF PURCHASE:

You must have proof of the date of purchase to receive repair on the product. A sales receipt or other document showing the product and the date that you purchased the product as well as the authorized retailer included, is considered such proof.

COVERAGE:

(If this product is determined to be defective)

LABOR: For a period of one (1) year from the date of purchase, Magnavox will repair or replace the product, at its option, at no charge, or pay the labor charges to any Magnavox authorized service center. After the period of one (1) year, Magnavox will no longer be responsible for charges incurred.

PARTS: For a period of one (1) year from the date of purchase, Magnavox will supply, at no charge, new or rebuilt replacement parts in exchange for defective parts. Magnavox authorized service centers will provide removal and installation of the parts for one (1) year.

DISPLAY: For a period of one (1) year from the date of purchase, Magnavox will supply, at no charge, a new or rebuilt active display device in exchange for the defective display. Magnavox authorized service centers will provide removal and installation of the parts under the specified labor warranty. (PTV screens carry a thirty (30) day replacement warranty)

EXCLUDED FROM WARRANTY COVERAGE

Your warranty does not cover:

- Labor charges for installation or setup of the product, adjustment of customer controls on the product, and installation or repair of antenna systems outside of the product.
- Product repair and/or part replacement because of improper installation, connections to improper voltage supply, abuse, neglect, misuse, accident, unauthorized repair or other cause not within the control of Magnavox.
- A product that requires modification or adaptation to enable it to operate in any country other than the country for which it was designed, manufactured, approved and/or authorized, or repair of products damaged by these modifications.
- Damage occurring to product during shipping when improperly packaged or costs associated with packaging
- Product lost in shipment and no signature verification of receipt can be provided.
- A product used for commercial or institutional purposes (including but not limited to rental purposes).
- Products sold AS IS or RENEWED.

TO OBTAIN WARRANTY SERVICE IN THE U.S.A., PUERTO RICO, OR U.S. VIRGIN ISLANDS...

Contact Magnavox Customer Care Center at:
1-800-705-2000

TO OBTAIN WARRANTY SERVICE IN CANADA...

1-800-661-6162 (French Speaking)
1-800-705-2000 (English or Spanish Speaking)

REPAIR OR REPLACEMENT AS PROVIDED UNDER THIS WARRANTY IS THE EXCLUSIVE REMEDY FOR THE CONSUMER. MAGNAVOX SHALL NOT BE LIABLE FOR ANY INCIDENTAL OR CONSEQUENTIAL DAMAGES FOR BREACH OF ANY EXPRESS OR IMPLIED WARRANTY ON THIS PRODUCT. EXCEPT TO THE EXTENT PROHIBITED BY APPLICABLE LAW, ANY IMPLIED WARRANTY OF MERCHANTABILITY OR FITNESS FOR A PARTICULAR PURPOSE ON THIS PRODUCT IS LIMITED IN DURATION TO THE DURATION OF THIS WARRANTY.

Some states do not allow the exclusions or limitation of incidental or consequential damages, or allow limitations on how long an implied warranty lasts, so the above limitations or exclusions may not apply to you. In addition, if you enter into a service contract agreement with the MAGNAVOX partnership within ninety (90) days of the date of sale, the limitation on how long an implied warranty lasts does not apply.

This warranty gives you specific legal rights. You may have other rights which vary from state/province to state/province.

Magnavox, P.O. Box 520890, Miami, FL 33152 (402) 536-4171

EL6596E001 / 01-04

56

Free Manuals Download Website

<http://myh66.com>

<http://usermanuals.us>

<http://www.somanuals.com>

<http://www.4manuals.cc>

<http://www.manual-lib.com>

<http://www.404manual.com>

<http://www.luxmanual.com>

<http://aubethermostatmanual.com>

Golf course search by state

<http://golfingnear.com>

Email search by domain

<http://emailbydomain.com>

Auto manuals search

<http://auto.somanuals.com>

TV manuals search

<http://tv.somanuals.com>