

MAGNAVOX

AZ 7453 Portable Compact Disc Player

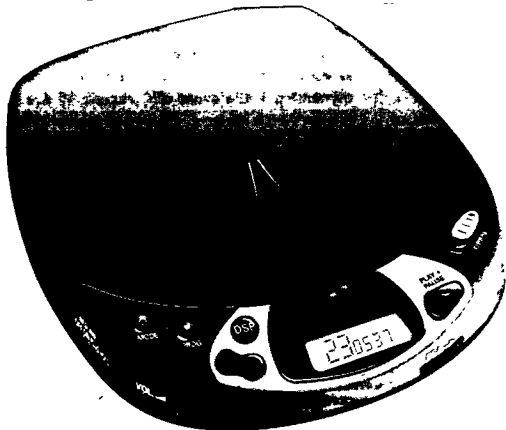

Owner's Manual

Toll Free Help Line
Ligne d'assistance en service libre
Línea de ayuda telefónica sin cargo

800-531-0039



Return your Warranty Registration card today to ensure you receive all the benefits you're entitled to.

- Once your MAGNAVOX purchase is registered, you're eligible to receive all the privileges of owning a MAGNAVOX product.
- So complete and return the Warranty Registration Card enclosed with your purchase at once. And take advantage of these important benefits.

Warranty Verification

Registering your product within 10 days confirms your right to maximum protection under the terms and conditions of your MAGNAVOX warranty.

Owner Confirmation

Your completed Warranty Registration Card serves as verification of ownership in the event of product theft or loss.

Model Registration

Returning your Warranty Registration Card right away guarantees you'll receive all the information and special offers which you qualify for as the owner of your model.

Know these
safety symbols



 This "bolt of lightning" indicates uninsulated material within your unit may cause an electrical shock. For the safety of everyone in your household, please do not remove product covering.

 The "exclamation point" calls attention to features for which you should read the enclosed literature closely to prevent operating and maintenance problems.

For Customer Use

Enter below the Serial No. which is located on the rear of the cabinet. Retain this information for future reference.

Model No. _____

Serial No. _____

WARNING: TO PREVENT FIRE OR SHOCK HAZARD, DO NOT EXPOSE THIS EQUIPMENT TO RAIN OR MOISTURE.

CAUTION: To prevent electric shock, match wide blade of plug to wide slot, and fully insert.

MAC5097

Introduction	2-7
Controls	8-9
Accessories	10
Power Supply	11
Connections	12-13
Operation	14-18
Maintenance	19
Troubleshooting	20-21
Limited warranty	22-23

Canada

English: This digital apparatus does not exceed the Class B limits for radio noise emissions from digital apparatus as set out in the Radio Interference Regulations of the Canadian Department of Communications.

Français: Cet appareil numérique n'émet pas de bruits radioélectriques dépassant les limites applicables aux appareils numériques de Classe B prescrites dans le Règlement sur le Brouillage Radioélectrique édicté par le Ministère des Communications du Canada.

Mexico

DOM

Es necesario que lea cuidadosamente su instructivo de manejo.



MAGNAVOX
Smart. Very smart.®



***Congratulations on your purchase,
and welcome to the "family!"***

Dear MAGNAVOX product owner:

Thank you for your confidence in MAGNAVOX. You've selected one of the best-built, best-backed products available today. And we'll do everything in our power to keep you happy with your purchase for many years to come.

As a member of the MAGNAVOX "family," you're entitled to protection by one of the most comprehensive warranties and outstanding service networks in the industry.

What's more, your purchase guarantees you'll receive all the information and special offers for which you qualify, plus easy access to accessories from our convenient home shopping network.

And most importantly you can count on our uncompromising commitment to your total satisfaction.

All of this is our way of saying welcome—and thanks for investing in a MAGNAVOX product.

Sincerely,

Robert Minkhorst
President and Chief Executive Officer

P.S. Remember, to get the most from your MAGNAVOX product, you must return your Warranty Registration Card within 10 days. So please mail it to us right now!

SAFETY INSTRUCTIONS – Read before operating equipment

This product was designed and manufactured to meet strict quality and safety standards. There are, however, some installation and operation precautions which you should be particularly aware of.

1. **Read Instructions** – All the safety and operating instructions should be read before the appliance is operated.
2. **Retain Instructions** – The safety and operating instructions should be retained for future reference.
3. **Heed Warnings** – All warnings on the appliance and in the operating instructions should be adhered to.
4. **Follow Instructions** – All operating and use instructions should be followed.
5. **Water and Moisture** – The appliance should not be used near water - for example, near a bathtub, washbowl, kitchen sink, laundry tub, in a wet basement or near a swimming pool, etc.
6. **Carts and Stands** – The appliance should be used only with a cart or stand that is recommended by the manufacturer.
 - 6A.  An appliance and cart combination should be moved with care. Quick stops, excessive force, and uneven surfaces may cause the appliance and cart combination to overturn.
7. **Wall or Ceiling Mounting** – The appliance should be mounted to a wall or ceiling only as recommended by the manufacturer.
8. **Ventilation** – The appliance should be situated so that its location or position does not interfere with its proper ventilation. For example, the appliance should not be situated on a bed, sofa, rug, or similar surface that may block the ventilation openings; or, placed in a built-in installation, such as a bookcase or cabinet that may impede the flow of air through the ventilation openings.
9. **Heat** – The appliance should be situated away from heat sources such as radiators, heat registers, stoves, or other appliances (including amplifiers) that produce heat.
10. **Power Sources** – The appliance should be connected to a power supply only of the type described in the operating instructions or as marked on the appliance.
11. **Power-Cord Protection** – Power supply cords should be routed so that they are not likely to be walked on or pinched by items placed upon or against them, paying particular attention to cords and plugs, convenience receptacles, and the point where they exit from the appliance.
12. **Cleaning** – The appliance should be cleaned only as recommended by the manufacturer.
13. **Power Lines** – An outdoor antenna should be located away from power lines.
14. **Nonuse Periods** – The power cord of the appliance should be unplugged from the outlet when left unused for a long period of time.
15. **Object and Liquid Entry** – Care should be taken so that objects do not fall and liquids are not spilled into the enclosure through openings.
16. **Damage Requiring Service** – The appliance should be serviced by qualified service personnel when:
 - A. The power-supply cord or the plug has been damaged; or
 - B. Objects have fallen, or liquid has spilled into the appliance; or
 - C. The appliance has been exposed to rain; or
 - D. The appliance does not appear to operate normally or exhibits a marked change in performance; or
 - E. The appliance has been dropped, or the enclosure damaged.
17. **Servicing** – The user should not attempt to service the appliance beyond that described in the operating instructions. All other servicing should be referred to qualified service personnel.

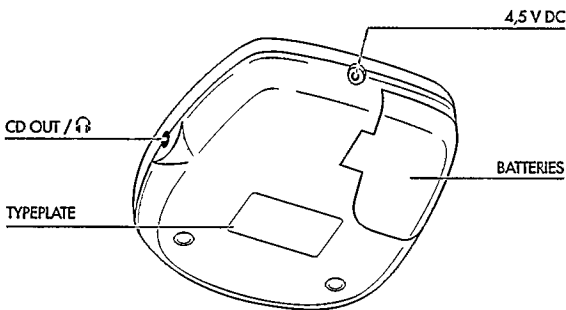
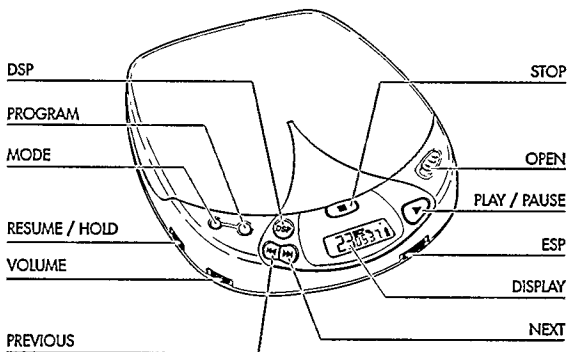

CAUTION

Use of controls or adjustments or performance of procedures other than herein may result in hazardous radiation exposure.

The set complies with the FCC-Rules, Part 15 and with 21 CFR 1040. 10.

CONTROLS

- DISPLAY** Window for showing the different playing modes, tracks and times
- ▶▶** Button for selecting the next music track or, if held down, for searching forward for a particular passage on the CD
- ◀◀** Button for selecting the previous music track or, if held down, for searching-backward for a particular passage on the CD
- VOLUME** Control for adjusting the volume of the headphone
- RESUME/HOLD** Switch for activating the RESUME function (resuming CD play) and/or HOLD (blocking all buttons) function
- MODE** ○ Button for selecting the different playing modes:
SHUFFLE→SHUFFLE REPEAT ALL→REPEAT 1→REPEAT ALL
→SCAN→off
- PROG P** Button for storing tracks in a program and for reviewing the program
- DSP** **Digital Sound Processing:** Button for selecting the different sound settings at the headphone output:
ROCK→POP→CAR→INCREDIBLE SOUND→off
- STOP** ■ Button for stopping CD play, deleting various settings, switching off the CD player.
- OPEN** Slide control for opening the lid of the CD player
- PLAY PAUSE** ▶|| Button for starting and pausing CD play
- ESP** **Electronic Skip Protection:** Switch for activating the electronic buffer memory for an undisturbed sound
- CD OUT** /  Headphone socket (3.5 mm)
- 4,5 V DC** Socket for external power supply
- Battery compartment** for inserting batteries

ACCESSORIES

Accessories

Note: Please ask your dealer for detailed information since not all accessories may be available in your country.

Accessories for power supply

AY 3160 power adapter 4.5 V/400 mA Direct current, plus-pole to the center pin

Note: Use only the AY 3160 adapter, other products may damage the set.

Car accessories

AY 3545 - car voltage converter (4.5 V/600 mA, Direct Current, plus-pole to the center pin)

AY 3500 - car adapter cassette

POWER SUPPLY

Power adapter

- 1 Make sure that the local voltage corresponds to the voltage of the adapter (see accessories).
 - 2 Connect the power adapter to the player's 4.5 V DC socket and to the wall outlet.
- Always disconnect the adapter when you are not using it.

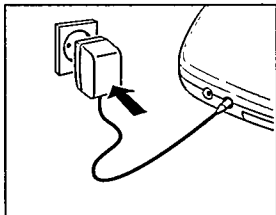

Batteries, type LR6, UM3 or AA (supplied or optional available)

- Open the battery compartment and insert 2 alkaline batteries.

Typical playing times under normal conditions:
Alkaline batteries: 5.5 hours (ESP off)
4.5 hours (ESP on)

- Remove the batteries if they are dead or if the CD player is not to be used for a long period of time.

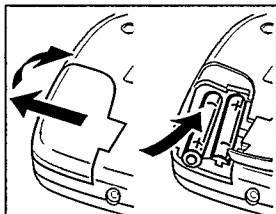

Note: In the right-hand corner of the display the battery condition will be indicated:

-Full batteries: no indication.

-Weak batteries:  -symbol lights up. This symbol is not available when rechargeable batteries are used.

-Dead batteries:  -symbol flashes and the message *b A t t* appears. Replace the batteries or connect the power adapter.

Batteries contain chemical substances, therefore they should be disposed of properly.

CONNECTIONS

Connecting headphones (supplied)

- Connect the supplied headphones (16 ohms/ 3.5mm plug) at the CD OUT /  jack.

Note : Use this jack also for connecting your HiFi system (signal lead) or your car radio (adapter cassette or signal lead). In both cases, the volume of the CD player has to be set to maximum position (10).

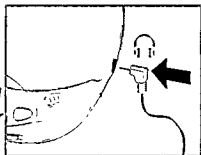

Use your head when using headphones

Hearing safety: Do not play your headphones at a high volume. Hearing experts advise that continuous use at high volume can permanently damage hearing.

Traffic safety: Do not use headphones while driving a vehicle. It may create a hazard and it is illegal in many countries. Even if your headphones are an open-air type designed to let you hear outside sounds, do not turn up the volume so high that you cannot hear what is going on around you.

CONNECTIONS

Connections for in-car use *(supplied or optional available)*

- 1 Find a safe place for the CD player on a horizontal, vibration-free and stable surface where it is no danger to or in the way of the driver or passengers.
- 2 Connect the DC plug of the voltage converter to the DC socket of your CD player

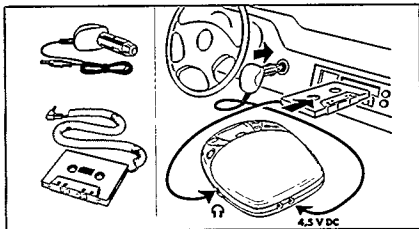

(only for a 12 V car battery, negative grounding).

- 3 Insert the voltage converter into the cigarette lighter socket. If necessary, clean the cigarette lighter socket to obtain a good electrical contact.
 - 4 Turn down the volume and ***switch off the autoreverse function (if present) of your car radio cassette player.***
 - 5 Connect the adapter cassette plug to the CD OUT /  socket of the CD player.
 - 6 Slide the adapter cassette carefully into the car radio's cassette compartment.
 - 7 Make sure that the cord does not hinder your driving.
 - 8 Start the CD player, turn its volume to maximum position (10) and adjust the sound with the car radio controls.
- To remove the adapter cassette press the eject button of the car radio.
 - Always remove the voltage converter from the cigarette lighter socket when the CD player is not in use.

Notes on In-car Use:

- Avoid excessive heat from the car heating or from direct sunlight (e.g., in a parked car in the summer).
- If your car radio has a LINE IN jack, it is best to use it for the car radio connection instead of the adapter cassette. Connect the signal lead to this LINE IN jack and the CD OUT /  jack of the CD player.

OPERATION

Inserting the CD

- Push gently on the CD center so that it fits onto the hub.



Removing the CD

- Hold the CD by its edge and press on the hub gently.

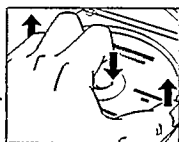

Playing a CD

- 1 Open the lid by pushing the OPEN slide control to the side.

- 2 Insert an audio CD, printed side up.

- 3 Close the lid by pushing down on the right-hand side.

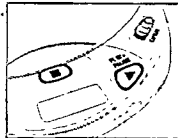

- Display indication of: (example)

17 = total number of tracks / 51:06 = total playing time

17 51:06

- 4 Press the **▶||** button to start CD play.

- Display indication of: (example)

4 = current track / 2:56 = elapsed time of current track

4 2:56

- 5 Adjust the sound using the controls VOLUME and DSP.

- 6 You can interrupt CD play by pressing the **▶||** button. Continue CD play by pressing the **▶||** button again.

- Display indication: time of the current position (flashing).

- 7 Press the **STOP ■** button to stop CD play.

- Display indication of: total number of tracks / the total playing time.

- If you press the **STOP ■** button again, you will switch off the set.

Note: If no button is pressed for 90 seconds, the set will switch off automatically.



Selecting another track

- Briefly press the ◀◀ or ▶▶ button once/several times to skip to the beginning of the current/previous or next track(s).
 - Display indication of: selected track number.
 - During play: CD play continues automatically with the selected track.
 - In stop position: press the ▶II button to start CD play.

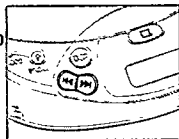

Searching for a passage during CD play

- 1 Hold down the ◀◀ or ▶▶ button to find a particular passage in forward or backward direction.
 - After 2 seconds, searching will start at high speed.
- 2 Release the button when you have reached the desired passage.

Note: Searching is only possible within the particular track when you are in one of these modes: SHUFFLE, REPEAT 1 or PROGRAM. Searching is not possible in the SCAN mode.

OPERATION

MODE ○ – different playing modes

- By pressing the MODE ○ button, you can successively activate the playing modes:



SHUFFLE: The tracks are played *in random order* until all of them have been played once.

SHUFFLE REPEAT ALL: All tracks are played *repeatedly in random order* until you leave this mode.

REPEAT 1: The track is played *repeatedly* until you leave this mode.

REPEAT ALL: The CD is played *repeatedly* until you leave this mode.

SCAN: Each track is scanned for 10 seconds until you leave this mode or all tracks have been played once.

- The selected playing mode is indicated in the display.
- During play: CD play continues automatically with the selected playing mode.
- In stop position: press the ►|| button to start CD play.

Notes:

- You can choose from 12 different playing modes when you combine all the above-mentioned modes with PROGRAM.
- Deactivate all modes with the MODE ○ button.

PROG P – programming of tracks (max. 25 tracks)

- 1 Select the desired track with PREV ◀◀ or NEXT ▶▶.
- 2 As soon as the desired track is displayed, press the PROG button to store the track in the memory.

→ Display indication of: track number
/ P / total number of stored tracks, e.g.

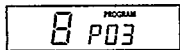

Notes:

- When you try to store more than 25 tracks, the display indicates **FULL**.
- When you press **PROG** and there is no track selected, the display indicates **SELECT**.

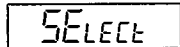
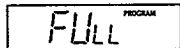

Playing the program:

- If you have selected the tracks in **STOP** mode, press the **PLAY/PAUSE ▶||** button.
- If you have selected the tracks during **CD** play, first press **STOP ■** and then the **PLAY/PAUSE ▶||** button.
 - Display indication: **PROGRAM**.
 - Your program will be played in the selected playing mode (e.g. shuffle).

Reviewing the settings:

- Press the **PROG** button for more than 2 seconds.
 - Display indication: each stored track successively flashes for a short moment.

Erasing the program in **STOP** mode:

- Press the **STOP ■** button to erase the program.
 - **PROGRAM** disappears on the display and your program is erased.
 - **CLERR** lights up briefly on the display.

Note: Interrupting the power supply or opening the lid will also erase the program.

OPERATION

ESP – Electronic Skip Protection Memory

- Activate the ESP memory by sliding the ESP switch to the right.
 - The ESP symbol lights up in the display.
 - The ESP memory continuously stores in advance the CD data to be played. This is to prevent sound skipping during play due to shock and vibration.
 - Prolonged shocks and vibrations may empty the ESP memory completely. Then the display shows *SOFFS* and there will be no sound.

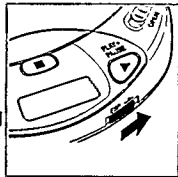

Note: When switching the ESP feature on and off, CD play will be delayed or interrupted for a short time.

RESUME / HOLD

RESUME – playing from where you have stopped

- Activate the RESUME feature by sliding the RESUME/HOLD switch to the middle.
- If you stop CD play by pressing the STOP ■ button, the last played position will be stored.
- Press ►II to resume CD play from the position where it was stopped.

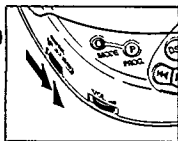

HOLD – deactivating all buttons

- Activate the HOLD feature by sliding the RESUME/HOLD switch to the far right.
 - Now all buttons are deactivated and will not function until you switch the feature off again. If you press a button (except OPEN), the display will indicate HOLD.

Notes:

-In the hold position, the resume function is automatically activated.

-Do not open the lid as this erases the information about the last position played.

GENERAL INFORMATION

Maintenance

- The lens (X) of the CD player should never be touched!
- Do not expose the CD player, batteries or CDs to rain, dampness, sand, dust or excessive heat caused by heating equipment, or to direct sunlight.
- The lens may cloud over when the set is suddenly moved from cold to warm surroundings. Playing a CD is not possible then. Leave the CD player in a warm environment until the moisture evaporates.
- You can clean the CD player with a soft and slightly dampened chamois leather. Do not use any cleaning agents as they may have a corrosive effect.
- Always pick up the CD by the edge and put it back in its box after use.
- To clean the CD, wipe it off in a straight line from the center toward the edge using a soft, lint-free cloth. A cleaning agent may damage the disc!
- When a new CD does not stay on the hub, this is caused by small burrs around the center hole of the CD. Remove the burrs by rubbing the edge of the center hole with a pen or similar instrument.

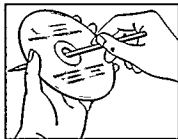
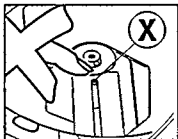

Environmental information

- Please observe the local regulations regarding the disposal of packing materials, exhausted batteries and obsolete equipment.
- All redundant packaging material has been omitted. We have tried to make the packaging easy to separate into three mono-materials: cardboard (box), expandable polystyrene (buffer), and polyethylene (bags, protective foam sheet).
 - Your set consists of materials which can be recycled if disassembled by a specialized company.
 - Do not dispose of exhausted batteries with your household waste.

TROUBLESHOOTING

- If a fault occurs, please check the points listed below before taking your set for repair.
- If you are not able to solve a problem by following these hints, consult your dealer or service facility.

PROBLEM	POSSIBLE CAUSE	SOLUTION
No power or CD play won't start	Batteries	
	Batteries incorrectly inserted	Insert the batteries correctly.
Display: no indication	Use of new batteries	Press ►II .
	Batteries are dead.	Change/recharge the batteries.
	Contact pins are dirty.	Clean them with a cloth.
	power adapter	
	Loose connection	Connect the adapter securely.
CD play does not start or is interrupted.	<i>HOLD feature is activated.</i>	<i>Switch off the HOLD feature.</i>
	CD lid is not closed securely.	Close the lid securely.
	Moisture condensation	Leave the player in a warm place until the moisture evaporates.
Display: no indication or no disc	CD is not or incorrectly inserted.	Insert a CD, label facing up.
	CD is badly scratched	Use another CD.
	CD is dirty.	Clean the CD.
Play does not start from the first track.	RESUME, SHUFFLE or PROGRAM is activated.	Switch off RESUME, SHUFFLE or PROGRAM.

TROUBLESHOOTING

Under no circumstances should you try to repair the unit yourself, as this will invalidate the warranty.

PROBLEM	POSSIBLE CAUSE	SOLUTION
No sound or bad sound quality	PAUSE is activated.	Press ►II .
	Loose or wrong connections	Check connections.
	Volume is not turned up.	Adjust the volume.
	Headphones worn the wrong way	Pay attention to the L (left) and R (right) indications.
	Headphone plug is dirty.	Clean the headphone plug.
	Strong magnetic fields near the CD player	Change the player's position or connections.
	Electrostatic discharge from the user via the CD player	Press ◀◀ or ▶▶ once or press ►II twice.
	In car use	
	Strong vibrations	Find another place for the set.
	Adapter cassette is incorrectly inserted.	Insert the adapter cassette correctly.
Hum or noise in car	Temperature inside car is too high/low.	Let the CD player adjust to the temperature.
	Cigarette lighter/socket is too dirty.	Clean the cigarette lighter/socket.
	Wrong playback direction of the autoreverse feature of the car cassette player	Change the autoreverse direction.
	Unfit car radio input socket	Use the adapter cassette.

LIMITED WARRANTY

MAGNAVOX PORTABLE COMPACT DISC

One Year Free Exchange

This product must be carried in for an exchange.

WHO IS COVERED?

You must have proof of purchase to exchange the product. A sales receipt or other document showing that you purchased the product is considered proof of purchase. Attach it to this owner's manual and keep both nearby.

WHAT IS COVERED?

Warranty coverage begins the day you buy your product. For one year thereafter, a defective or inoperative product will be replaced with a new, renewed or comparable product at no charge to you. A replacement product is covered only for the original warranty period. When the warranty on the original product expires, the warranty on the replacement product also expires.

WHAT IS EXCLUDED?

Your warranty does not cover:

- labor charges for installation or setup of the product, adjustment of customer controls on the product, and installation or repair of antenna systems outside of the product.
- product repair and/or part replacement because of misuse, accident, unauthorized repair or other cause not within the control of Philips Consumer Electronics Company.
- reception problems caused by signal conditions or cable or antenna systems outside the unit.
- a product that requires modification or adaptation to enable it to operate in any country other than the country for which it was designed, manufactured, approved and/or authorized, or repair of products damaged by these modifications.
- incidental or consequential damages resulting from the product. (Some states do not allow the exclusion of incidental or consequential damages, so the above exclusion may not apply to you. This includes, but is not limited to, prerecorded material, whether copyrighted or not copyrighted.)
- a product that is used for commercial or institutional purposes.

WHERE IS EXCHANGE AVAILABLE?

You may exchange the product in all countries where the product is officially distributed by Philips Consumer Electronics Company. In countries where Philips Consumer Electronics Company does not distribute the product, the local Philips service organization will attempt to provide a replacement product (although there may be a delay if the appropriate product is not readily available).

BEFORE REQUESTING EXCHANGE...

Please check your owner's manual before requesting an exchange. Adjustments of the controls discussed there may save you a trip.

Philips Service Company, P.O. Box 555,
Jefferson City, Tennessee 37760, (423) 475-8869

EXCHANGING A PRODUCT IN U.S.A., PUERTO RICO OR U.S.VIRGIN ISLANDS...

Contact your dealer to arrange an exchange. Or, ship the product, insured and freight prepaid, and with proof of purchase enclosed, to the address listed below.

Small Product Service Center
Philips Service Company
907 Snapps Ferry Road, Plant 2, Building 6
Greeneville, TN 37743

(In U.S.A., Puerto Rico and U.S.Virgin Islands, all implied warranties, including implied warranties of merchantability and fitness for a particular purpose, are limited in duration to the duration of this express warranty. But, because some states do not allow limitations on how long an implied warranty may last, this limitation may not apply to you.)

EXCHANGING A PRODUCT IN CANADA...

Contact your dealer to arrange an exchange. Or, ship the product, insured and freight prepaid, and with proof of purchase enclosed, to one of the Philips consumer service centers listed below.

Philips Electronics Ltd.
601 Milner Avenue, Scarborough, Ontario, M1B 1M8
(416) 292-5161
4977 Levy Street, St. Laurent, Québec, H4R 2N9
(514) 956-0120
1741 Boundary Road, Vancouver, B.C., V5M 3Y7
(604) 294-3441

(In Canada, this warranty is given in lieu of all other warranties. No other warranties are expressed or implied, including any implied warranties of merchantability or fitness for a particular purpose. Philips is not liable under any circumstances for any direct, indirect, special, incidental or consequential damages, howsoever incurred, even if notified of the possibility of such damages.)

TO GET OUT-OF-WARRANTY EXCHANGE...

In U.S.A., Puerto Rico or U.S.Virgin Islands, contact Philips Service Company at (800) 851-8885 to obtain the cost of out-of-warranty exchange. Then carefully pack the product and ship it to the Small Product Service Center (address listed above). In Canada, contact the nearest Philips consumer service center (phone number and address listed above) to obtain the cost of out-of-warranty exchange. Then carefully pack the product and ship it to that service center.

REMEMBER...

Please record the model and serial numbers found on the product below. Also, please fill out and mail your warranty registration card promptly. It will be easier for us to notify you if necessary.

MODEL # _____

SERIAL # _____

*This warranty gives you specific legal rights. You may have other rights
which vary from state/province to state/province.*

PHILIPS CONSUMER ELECTRONICS COMPANY

A Division of Philips Electronics North America Corporation
Knoxville, Tennessee 37914-1810, U.S.A.



**CLASS 1
LASER PRODUCT**

Free Manuals Download Website

<http://myh66.com>

<http://usermanuals.us>

<http://www.somanuals.com>

<http://www.4manuals.cc>

<http://www.manual-lib.com>

<http://www.404manual.com>

<http://www.luxmanual.com>

<http://aubethermostatmanual.com>

Golf course search by state

<http://golfingnear.com>

Email search by domain

<http://emailbydomain.com>

Auto manuals search

<http://auto.somanuals.com>

TV manuals search

<http://tv.somanuals.com>