

# Owner's Manual

26MF605W/32MF605W Series  
LCD TV

**MAGNAVOX**  
SMART. VERY SMART.



## **NEED HELP? CALL US!**

**MAGNAVOX REPRESENTATIVES ARE READY TO HELP YOU WITH ANY QUESTIONS ABOUT YOUR NEW PRODUCT. WE CAN GUIDE YOU THROUGH CONNECTIONS, FIRST-TIME SETUP, AND ANY OF THE FEATURES. WE WANT YOU TO START ENJOYING YOUR NEW PRODUCT RIGHT AWAY.**

**CALL US BEFORE YOU CONSIDER RETURNING THE PRODUCT.**

**1-800-705-2000**

**OR VISIT US ON THE WEB AT [WWW.USASUPPORT.MAGNAVOX.COM](http://WWW.USASUPPORT.MAGNAVOX.COM)**

**Important!**

**Return your Warranty Registration Card within 10 days.**

3138 155 23445

## RETURN YOUR PRODUCT REGISTRATION CARD TODAY TO GET THE VERY MOST FROM YOUR PURCHASE.

Registering your model with MAGNAVOX makes you eligible for all of the valuable benefits listed below, so don't miss out. Complete and return your Product Registration Card at once to ensure:

### \*Proof of Purchase

Returning the enclosed card guarantees that your date of purchase will be on file, so no additional paperwork will be required from you to obtain warranty service.

### \*Product Safety Notification

By registering your product, you'll receive notification - directly from the manufacturer - in the rare case of a product recall or safety defect.

### \*Additional Benefits of Product Ownership

Registering your product guarantees that you'll receive all of the privileges to which you're entitled, including special money-saving offers.

# MAGNAVOX

*Congratulations on your purchase, and welcome to the "family!"*

#### Dear MAGNAVOX product owner:

Thank you for your confidence in MAGNAVOX. You've selected one of the best-built, best-backed products available today. We'll do everything in our power to keep you happy with your purchase for many years to come.

As a member of the MAGNAVOX "family," you're entitled to protection by one of the most comprehensive warranties and outstanding service networks in the industry. What's more, your purchase guarantees you'll receive all the information and special offers for which you qualify, plus easy access to accessories from our convenient home shopping network.

Most importantly, you can count on our uncompromising commitment to your total satisfaction.

All of this is our way of saying welcome - and thanks for investing in a MAGNAVOX product.

**P.S. To get the most from your MAGNAVOX purchase, you must return your Warranty Registration Card within 10 days. So please mail it to us right now!**

Know these **safety** symbols



 This "bolt of lightning" indicates uninsulated material within your unit may cause an electrical shock. For the safety of everyone in your household, please do not remove product covering.

 The "exclamation point" calls attention to features for which you should read the enclosed literature closely to prevent operating and maintenance problems.

**WARNING:** To reduce the risk of fire or electric shock, this apparatus should not be exposed to rain or moisture and objects filled with liquids, such as vases, should not be placed on this apparatus.

**CAUTION:** To prevent electric shock, match wide blade of plug to wide slot, fully insert.

**ATTENTION:** Pour éviter les choc électriques, introduire la lame la plus large de la fiche dans la borne correspondante de la prise et pousser jusqu'au fond.

#### For Customer Use

Enter below the Serial No. which is located on the rear of the cabinet. Retain this information for future reference.

Model No. \_\_\_\_\_

Serial No. \_\_\_\_\_

# MAGNAVOX

Visit our World Wide Web Site at <http://www.usasupport.magnavox.com>

# IMPORTANT SAFETY INSTRUCTIONS

## READ BEFORE OPERATING EQUIPMENT

1. Read these instructions.
2. Keep these instructions.
3. Heed all warnings.
4. Follow all instructions.
5. Do not use this apparatus near water.
6. Clean only with a dry cloth.
7. Do not block any of the ventilation openings.  
Install in accordance with the manufacturers instructions.
8. Do not install near any heat sources such as radiators, heat registers, stoves, or other apparatus (including amplifiers) that produce heat.
9. Do not defeat the safety purpose of the polarized or grounding-type plug. A polarized plug has two blades with one wider than the other. A grounding type plug has two blades and third grounding prong. The wide blade or third prong are provided for your safety. When the provided plug does not fit into your outlet, consult an electrician for replacement of the obsolete outlet.
10. Protect the power cord from being walked on or pinched particularly at plugs, convenience receptacles, and the point where they exit from the apparatus.
11. Only use attachments/accessories specified by the manufacturer.
12.  Use only with a cart, stand, tripod, bracket, or table specified by the manufacturer, or sold with the apparatus. When a cart is used, use caution when moving the cart/apparatus combination to avoid injury from tip-over.
13. Unplug this apparatus during lightning storms or when unused for long periods of time.
14. Refer all servicing to qualified service personnel. Servicing is required when the apparatus has been damaged in any way, such as power-supply cord or plug is damaged, liquid has been spilled or objects have fallen into apparatus, the apparatus has been exposed to rain or moisture, does not operate normally, or has been dropped.
15. This product may contain lead and mercury. Disposal of these materials may be regulated due to environmental considerations. For disposal or recycling information, please contact your local authorities or the Electronic Industries Alliance: [www.eiae.org](http://www.eiae.org)
16. **Damage Requiring Service** - The appliance should be serviced by qualified service personnel when:
  - A. The power supply cord or the plug has been damaged;
  - B. Objects have fallen, or liquid has been spilled into the appliance;
  - C. The appliance has been exposed to rain
  - D. The appliance does not appear to operate normally or exhibits a marked change in performance;
  - E. The appliance has been dropped, or the enclosure damaged.
17. **Tilt/Stability** - All televisions must comply with recommended international global safety standards for tilt and stability properties of its cabinet design.
  - Do not compromise these design standards by applying excessive pull force to the front, or top, of the cabinet which could ultimately overturn the product.
  - Also, do not endanger yourself, or children, by placing electronic equipment/toys on the top of the cabinet. Such items could unsuspectingly fall from the top of the set and cause product damage and/or personal injury.
18. **Wall or Ceiling Mounting** - The appliance should be mounted to a wall or ceiling only as recommended by the manufacturer.
19. **Power Lines** - An outdoor antenna should be located away from power lines.
20. **Outdoor Antenna Grounding** - If an outside antenna is connected to the receiver, be sure the antenna system is grounded so as to provide some protection against voltage surges and built up static charges. Section 810 of the National Electric Code, ANSI/NFPA No. 70-1984, provides information with respect to proper grounding of the mast and supporting structure, grounding of the lead-in wire to an antenna discharge unit, size of grounding connectors, location of antenna-discharge unit, connection to grounding electrodes, and requirements for the grounding electrode. See Figure below.
21. **Object and Liquid Entry** - Care should be taken so that objects do not fall and liquids are not spilled into the enclosure through openings.
22. **Battery Usage CAUTION** - To prevent battery leakage that may result in bodily injury, property damage, or damage to the unit:
  - Install all batteries correctly, with + and - aligned as marked on the unit.
  - Do not mix batteries (old and new or carbon and alkaline, etc.).
  - Remove batteries when the unit is not used for a long time.

**Note to the CATV system installer:** This reminder is provided to call the CATV system installer's attention to Article 820-40 of the NEC that provides guidelines for proper grounding and, in particular, specifies that the cable ground shall be connected to the grounding system of the building, as close to the point of cable entry as practical.

## Example of Antenna Grounding as per NEC - National Electric Code

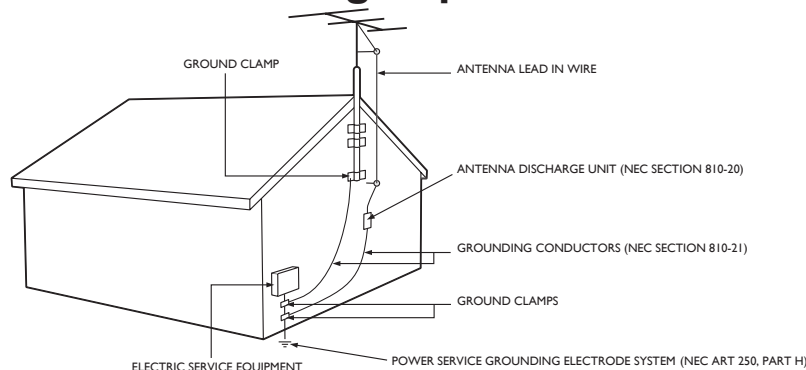

## Introduction

Welcome/Registration of Your TV.....	2
IMPORTANT SAFETY INSTRUCTIONS.....	3
Table of Content.....	4

## Getting Started

Before Installation.....	5
Installing LCD TV on The Wall.....	6
Basic TV and Remote Control Operations.....	7
Remote Control.....	8
Antenna Connection.....	9
Connecting the Power cord.....	9
Basic Cable TV Connection.....	9
Cable Box Connections.....	10
VCR, DVD Player, or other Devices with RCA Connectors.....	11
DVD Player or other Video Devices with Component Video Connectors.....	12
Digital TV Receiver, or a Digital Satellite Receiver with HD (High Definition) Output.....	13
Digital Satellite Receiver with DVI connector.....	14
PC (Monitor) Connection.....	15
AV Output.....	16



## Install Menu

Language Settings.....	17
Tuner Mode Control.....	18
Auto Program (Setting Up Channels).....	19
Channel Edit Control.....	20
Factory Reset.....	21



## Smart Picture and Smart Sound

Smart Picture Control.....	22
Smart Sound Control.....	22



## Picture Menu

TV Picture Menu Controls.....	23
-------------------------------	----



## Sound Menu

TV Sound Menu Controls.....	24
-----------------------------	----



## Features Menu

Auto Lock.....	25
Auto Lock Access Code.....	26
Auto Lock Program.....	27
Auto Lock - Movie Ratings.....	28
Auto Lock - TV Ratings.....	29
Using The Picture Format.....	30
Closed Captions.....	31



## PC Mode

PC Picture Controls.....	32
PC Audio Controls.....	33
Using PC PIP (Picture In Picture) Feature.....	34
Setting Up The PC Mode.....	35
(Personal Computer Monitor).....	35



## General Information

Trouble Shooting Tips.....	36
Care And Cleaning.....	37
Index.....	38
Regulatory.....	39
Regulatory.....	40
Factory Service Locations.....	41
Limited Warranty.....	42

Here are a few of the special features of your new LCD TV.

**Audio/Video In Jacks:** Use to quickly connect other equipment to your LCD TV.

**Automatic Channel Programming (Auto Program):**

Quick and easy setup of available channels.

**Closed Captioning:** Allows the viewer to read TV program dialog or voice conversations as on-screen text.

**On-screen Menus:** Helpful messages (in English, Spanish or French) for setting TV controls.

**Remote Control:** Works your LCD TV features.

**Sleep Timer:** Turns off the LCD TV within an amount of time you specify (15-240 minutes from the current time).

**AutoLock:** Lets you block viewing of certain TV channels if you do not want your children viewing inappropriate material.

**Standard broadcast (VHF/UHF) or Cable TV channel capability**

**Stereo capability:** Includes a built-in amplifier and twin-speaker system, allowing reception of TV programs broadcast in stereo.

**Treble, Bass, and Balance:** Enhance the LCD TV's sound.

**NOTE:** This manual covers different versions and models. Not all features described in this manual will match those of your LCD TV. This is normal and does not require you contacting your dealer or requesting service.

## END-OF-LIFE DISPOSAL

Your new LCD TV and its packaging contain materials that can be recycled and reused. Specialized companies can recycle your product to increase the amount of reusable materials and minimize the amounts that need to be properly disposed. Your product also uses batteries that should not be thrown away when depleted, but should be handed in and disposed of as small chemical waste.

When you replace your existing equipment, please find out about the local regulations regarding disposal of your old television, batteries, and packing materials.

## Positioning the LCD TV.

- Place the LCD TV on a solid, stable surface. Be sure the surface is strong enough to handle the weight of the LCD TV.
- Try to leave at least 6" of space around each side of the LCD TV cabinet to allow for proper ventilation.

- Do not place the LCD TV near a radiator or other source of heat.
- Do not place the LCD TV where it can be exposed to rain or excessive moisture.

## IDENTIFYING ALL CONNECTORS (BACKSIDE)

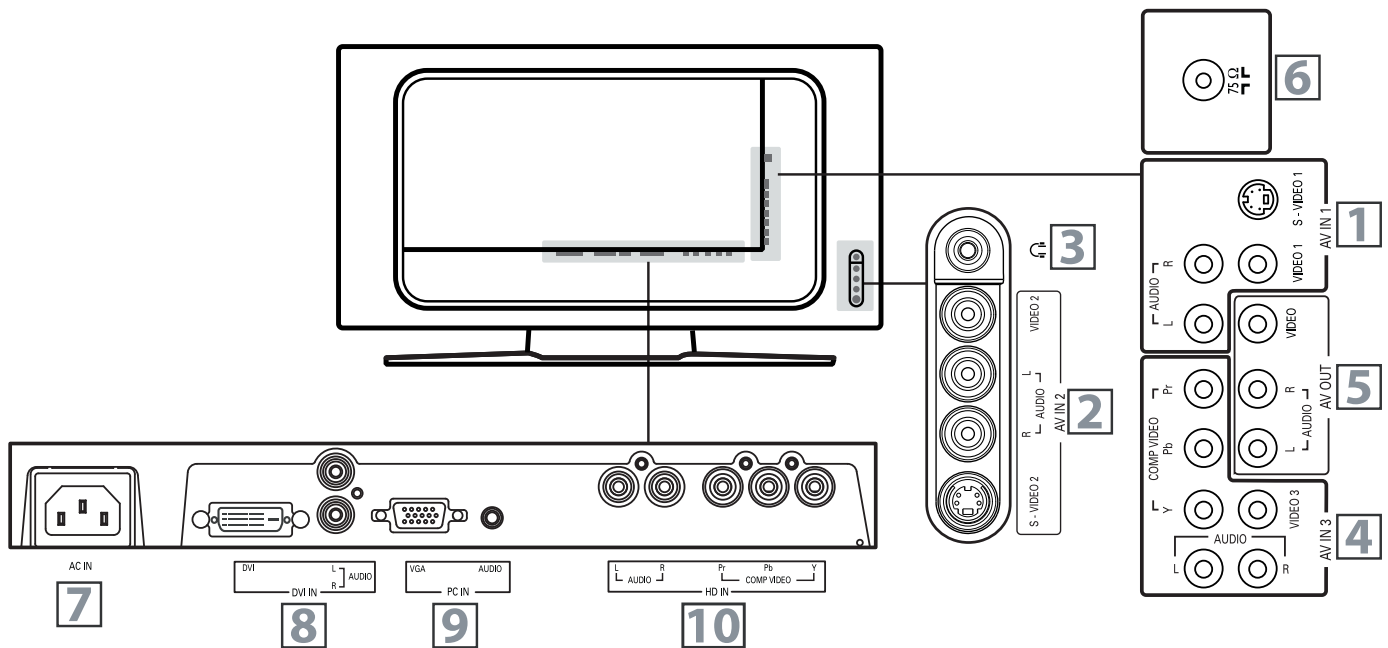

- AV IN 1**  
Connects to the output jacks of your VCR or other video equipment.
- AV IN 2**  
Connects to the output jacks of your VCR or other video equipment.
- Headphones jack**  
Connect to your headphones.
- AV IN 3**  
Y, Pb, Pr Input jacks  
Connects to the component video connectors of your DVD player or other video equipments with SD (Standard Definition) video format.
- AV OUT**  
Connects to the input jacks of your video and audio equipment.
- VHF/UHF**  
Connect to your VHF/UHF antenna or cable.
- AC IN**  
Connects the supplied AC power cord.
- DVI IN (HDCP)**  
Connect to your DVD player or other video equipment with DVI/HDCP output connectors.
- PC IN**  
Connect to your PC with VGA type video output.
- HD (High Definition) IN**  
Connect to the Digital Satellite Receiver or other video equipments that supports YPbPr HD (High Definition) video format.

# INSTALLING LCD TV ON THE WALL

*Before you can install your LCD TV on the wall, you must first remove the base using the steps below:*

- 1** Place the set facing down on a flat surface with a protective sheet or cloth beneath the TV.

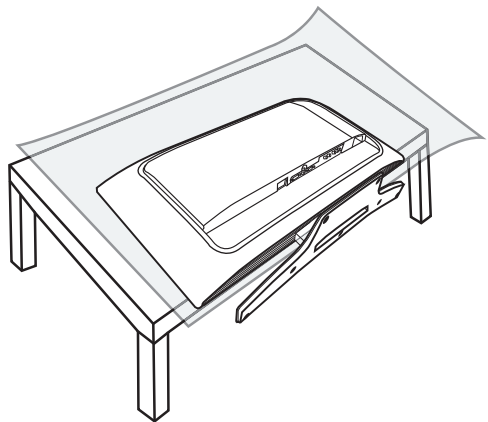

- 2** Remove 3 screws from the base. Grasp the base and pull it out.

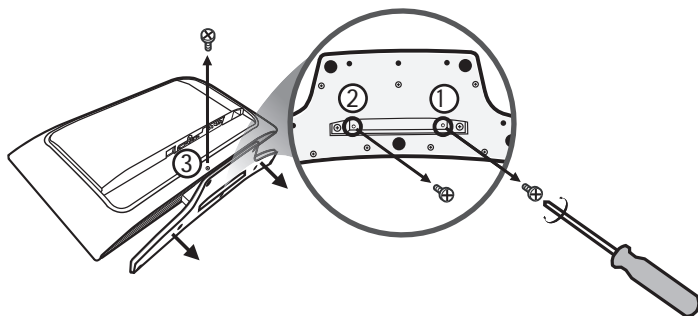

- 3** Remove the 2 metal pins.

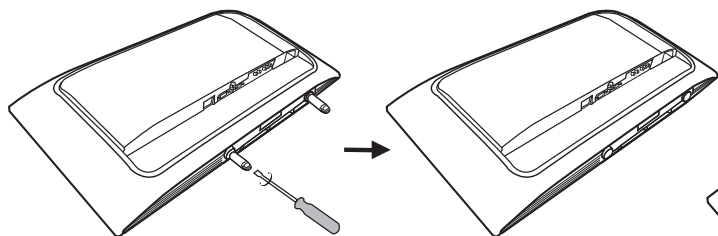

- 4** Attach the supplied base cover. Your LCD TV is now ready for wall mounting.

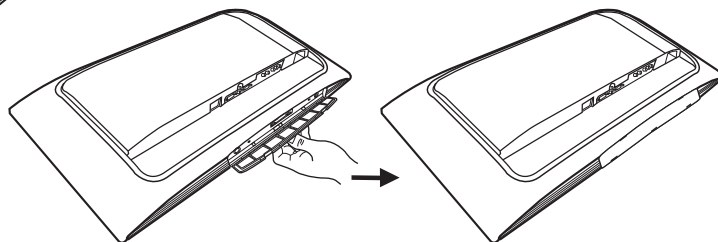

**When installing the LCD TV on the wall, please consult a professional technician for proper installing.**

**The manufacture accepts no liability for installations not performed by professional technician.**

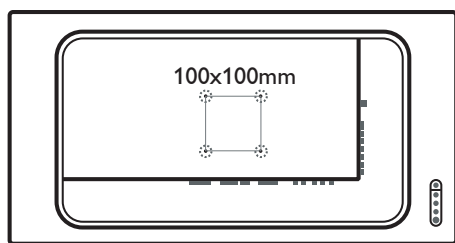

**26"**

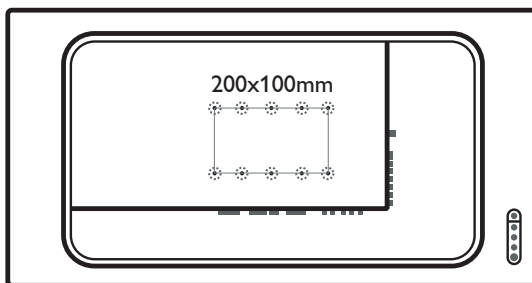

**32"**

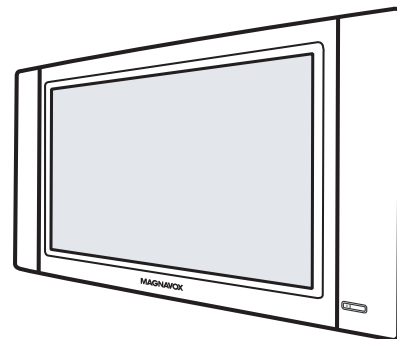

## TELEVISION AND REMOTE CONTROL

- 1 Press POWER to turn on the LCD TV.
- 2 Press VOLUME + to increase the sound level. Or, press VOLUME- to lower the sound level.
- 3 Press CH+ or CH- to select channels.
- 4 Point the remote control toward on the front of the LCD TV when operating the LCD TV with the remote.

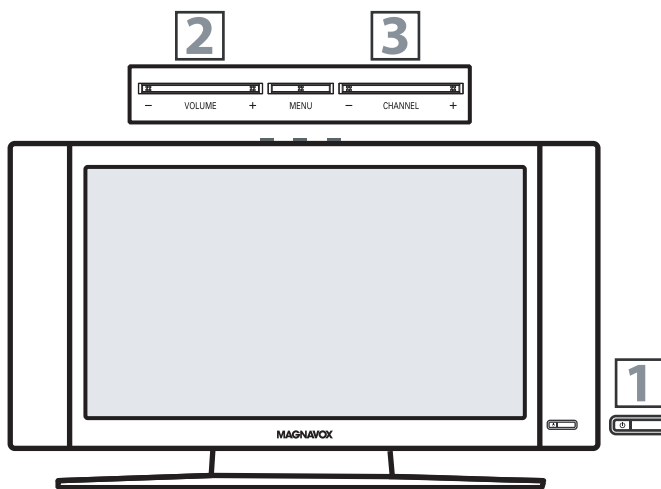

## BATTERY INSTALLATION

- 5 Remove the battery compartment lid on the back of the remote.
- 6 Place two AAA batteries in the remote. Be sure the (+) and (-) ends of the batteries line up as marked inside the battery compartment.
- 7 Reattach the battery compartment lid.

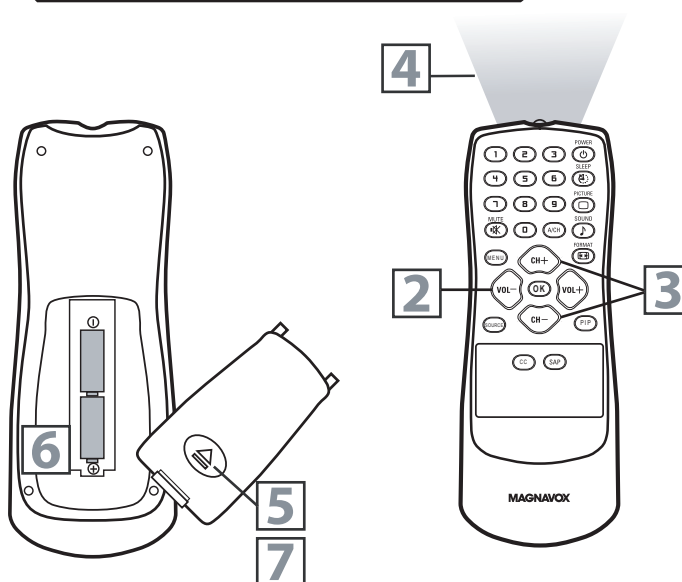





## Number buttons

Press to select TV channels. When selecting single-digit channels, press the number of the desired channel. The LCD TV will pause for a few seconds then tune to the selected channel.

## Mute button

Press to eliminate or restore the LCD TV sound. Mute will appear on the screen when the sound is muted.

## Menu button

Press to activate onscreen menu, back to previous level inside the onscreen menu, also press to exit the onscreen menu.

## Volume button

Press to increase or decrease the sound level, also press to navigate left/right in onscreen menu.

## Source button

Press to select the video input source: PC, DVI, AV1, AV2, AV3, S-V1, S-V2, Component, HD

## OK button

Press to confirm the option you selected in the onscreen menu.

## C.C button

Press the C.C button to select CC on or CC off.

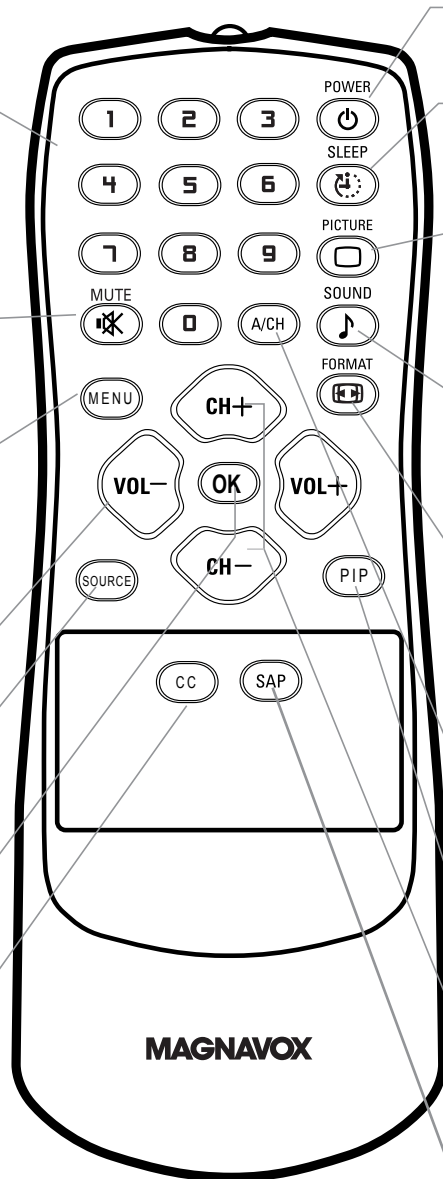

## Standby (Power) button

Press to turn the LCD TV on or off.

## Sleep button

Press to set the LCD TV to turn itself off within a certain time.

## Smart Picture button

Press repeatedly to select either Personal, Movie, Sports, Weak signal, Multimedia or Night picture setting.

## Smart Sound button

Press repeatedly to select among the 4 settings; Personal, News, Music, or Theater.

## Picture Format button

Press the FORMAT button repeatedly to toggle among the four screen format sizes; 4:3, SUPERWIDE, ZOOM 16:9 or WIDESCREEN.

## Previous Channel button

Press to go to previously selected channel.

## PIP button

Press repeatedly to change the size of PIP window in PC mode.

## Channel button

Press to adjust the channel up or down. Also press to select or navigate up/down in onscreen menu.

## SAP button

Press to select a sound mode if available with the TV programming: Mono, Stereo, or SAP.



## ANTENNA CONNECTION

A combination antenna receives normal broadcast channels (VHF 2–13 and UHF 14–69). Your connection is easy because there is only one 75 Ω antenna jack on the back of your TV, and that's where the antenna goes.

**1** If your antenna has a round cable (75 Ω) on the end, then you're ready to connect it to the LCD TV. If your antenna has flat, twin-lead wire (300Ω), you first need to attach the antenna wires to the screws on a 300-75Ω adapter (not supplied).

**2** Connect the antenna (or adapter) to the TV jack (marked 75 Ω) on the rear of the LCD TV. If the end of the antenna wire is threaded, screw it down finger tight.

Outdoor or Indoor Antenna  
(Combination VHF/UHF)

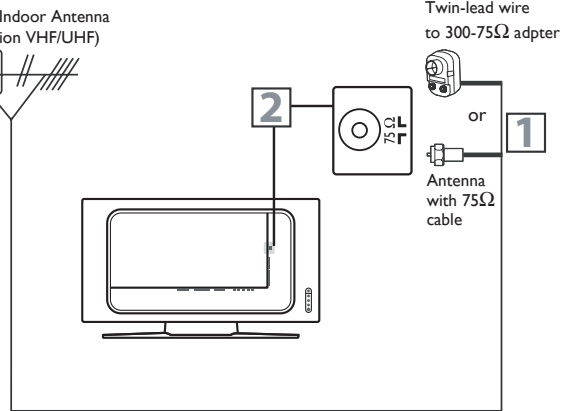

### HELPFUL HINT

Select weak signal mode via the smart picture settings in case your antenna connection is showing a lot of noise or strange patterns.

## BASIC CABLE TV CONNECTION

Your Cable TV signal into your home may be a single, 75 Ω cable. If so, this connection is very simple. Follow the step below to connect your Cable TV signal to your new LCD TV.

**1** Connect the cable TV signal to the TV jack (marked 75 Ω) on the rear of the LCD TV. Screw it down finger tight.

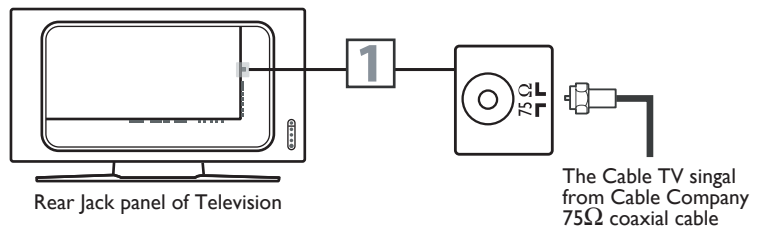

## CONNECTING THE POWER CORD

Complete other connections prior to connecting the power cord.

**1** Connect the power cord to the AC IN connector of the LCD TV.

**2** Connect the other plug of the power cord to a wall outlet.

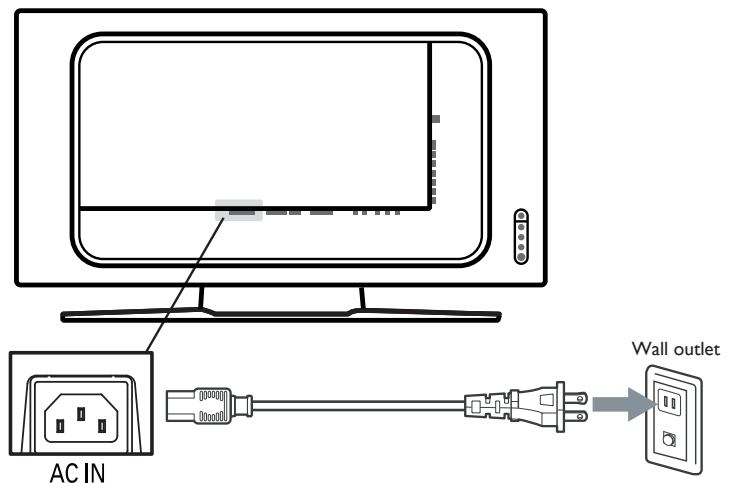

If you have a Cable Box, follow either set of these steps to complete your connections.

**Disconnect all power sources before making any connections.**

## Cable Box with RF In/Out Jacks

This connection will not supply Stereo sound to the LCD TV.

- 1** Connect the Cable TV signal to the IN jack (or RF IN or CABLE IN) on the Cable Box.
- 2** Connect an RF coaxial cable (not supplied) to the OUT jack (or TO TV or RF OUT) of the Cable Box.
- 3** Connect the other end of the coaxial cable to the TV jack (marked 75 Ω) on the rear of the LCD TV.
- 4** Set the Channel (or Output channel) switch of the Cable Box to 3 or 4. Set the TV to the same channel. When watching TV programming, change channels at the Cable Box, not the LCD TV.

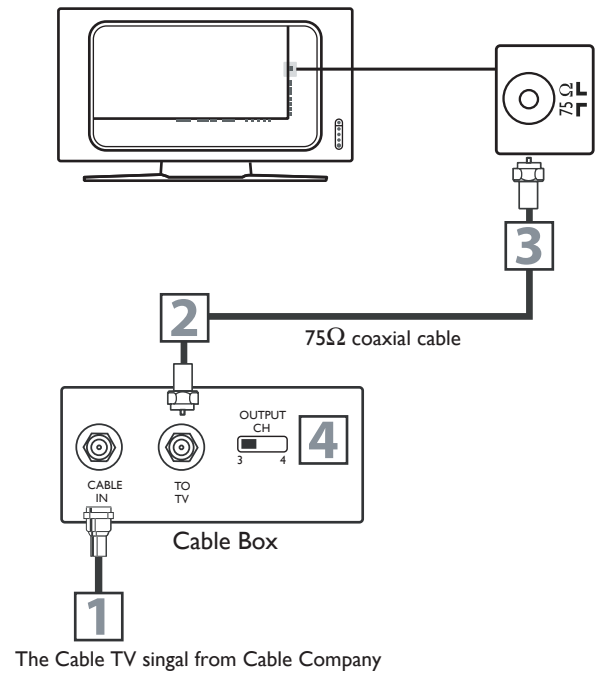

## Cable Box with AV (Audio/Video) Out Jacks

This connection will supply Stereo sound to the LCD TV.

- 1** Connect the Cable TV signal to the IN jack (or RF IN or CABLE IN) on the Cable Box.
- 2** Using an RCA-type Video and Audio cable (marked with yellow, red, and white), connect the Cable Box's Video and Audio Out jacks to the TV's Video and Audio In jacks.

Note:

1. If your Cable Box is equipped with a S-Video Out Jack, use the S-Video connection for a better picture detail and clarity. Use the S-Video cable to connect the Cable Box's S-Video Out jacks to the TV's S-Video In jacks.
2. You can also use the Video and Audio jacks in AV IN 2 and AV IN 3 located on the rear of the TV to connect your Cable Box.
3. Use the SOURCE button on the remote control to select AV 1 (or AV2, AV3, S-Video1, or S-Video2 if you use the different jacks for this hookup) to watch Cable TV (your Cable Box must be turned on).

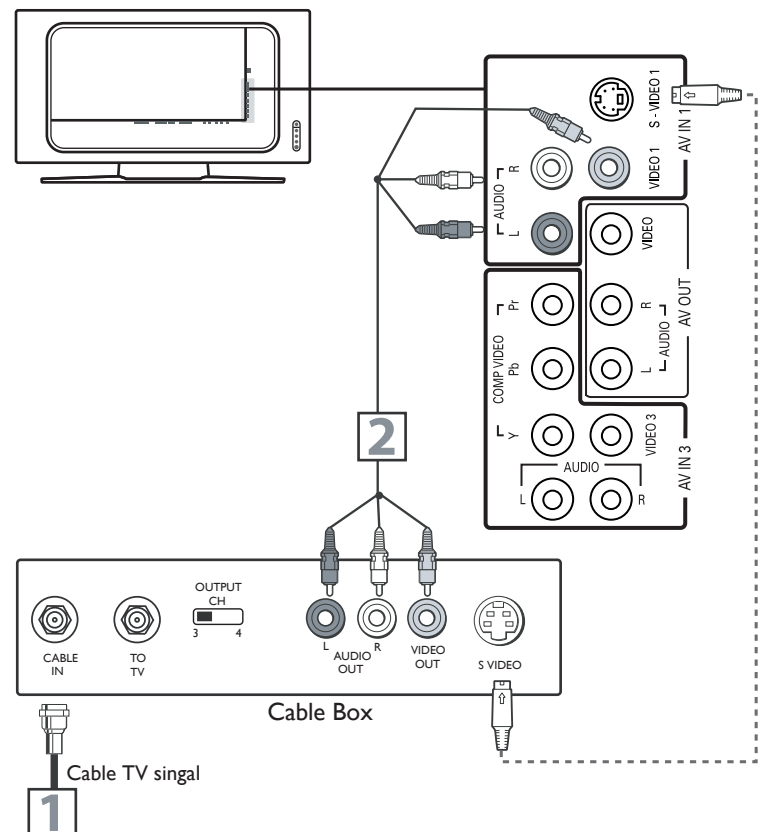

# VCR, DVD PLAYER, OR OTHER DEVICES WITH RCA CONNECTORS

The AV IN jacks on the rear of the LCD TV enable quick connections of other equipment. Connect a DVD player, VCR, Video Game, Camcorder, etc., to these jacks. To view the material playing on the other equipment, set the LCD TV to its AV mode.

**Disconnect all power sources before making any connections.**

**1** Using an RCA-type Video and Audio cable (usually marked yellow, red, and white), connect the VCR's Video and Audio Out jacks to the TV's Video and Audio In jacks.

**2** Use SOURCE button on the remote control to select AV 1 (or AV2, AV3, S-Video1, or S-Video2 if you use the different jacks for this hookup) to watch VCR.

Note:

1. If your VCR equipped with a S-Video Out jack, uses S-Video connection for better picture detail and clarity. Use the S-Video cable to connect the VCR's S-Video Out jacks to the TV's S-Video In jacks.
2. You can also use the Video and Audio jacks in AV IN 2 and AV IN 3 located on the rear of the TV to connect your VCR or other Video Devices.
3. If your DVD Player is equipped with Component (Y, Pb, Pr) Output Jacks, please refer to "Connecting a DVD Player or other Video Equipments with Component Video Connectors" section for use of Component Video Connection for highest color and picture resolution in video playback.

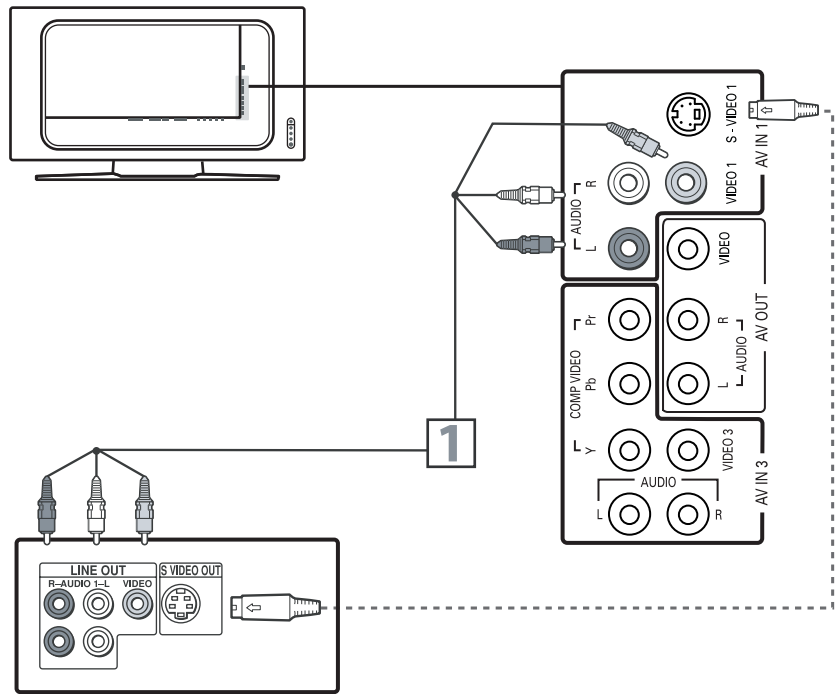

AV Player with A/V connectors

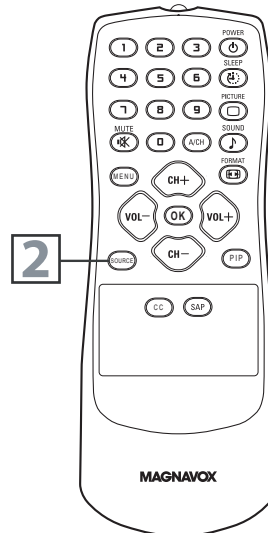

## HELPFUL HINT

- The Audio jack of AV IN is shared between Video (CVBS) and S-Video signals. If Audio and Video is connected to Video (CVBS) input, you can still hear sound if you select S-Video via Source select, even there appears no image on screen.
- Select weak signal mode via the smart picture settings in case your VCR is showing a lot of noise or strange patterns during play mode.

# DVD PLAYER OR OTHER VIDEO DEVICES WITH COMPONENT VIDEO CONNECTORS



Component Video Input (Y, Pb, Pr) provide the highest possible color and picture resolution in the playback of digital signal source material, such as with DVD player.

**Disconnect all power sources before making any connections.**

- Using a Component Video cable (not supplied), connect the DVD player's Y, Pb, Pr jacks to the Y, Pb, Pr jacks on the TV. Use the AV IN 3 connections.

Note: The Component (Y, Pb, Pr) Video Input in AV IN 3 connections can display SD (480i) image only. If your DVD player can output Progressive scanned or HD (High Definition) image, please refer to "Digital TV Receiver, or a Digital Satellite Receiver with HD (High Definition) Output" in next section.

- Using an AUDIO cable, connect the DVD player's AUDIO OUT jacks to the TV's AUDIO IN jacks in AV IN 3 connections.

- Use Source button on the remote control to select COMPONENT to watch DVD.

Note: 1. The Y, Pb, Pr jacks do not provide audio, so audio cables must be connected to provide sound.

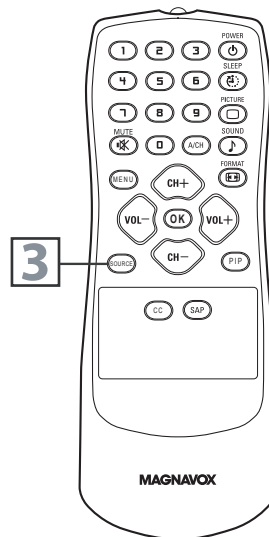
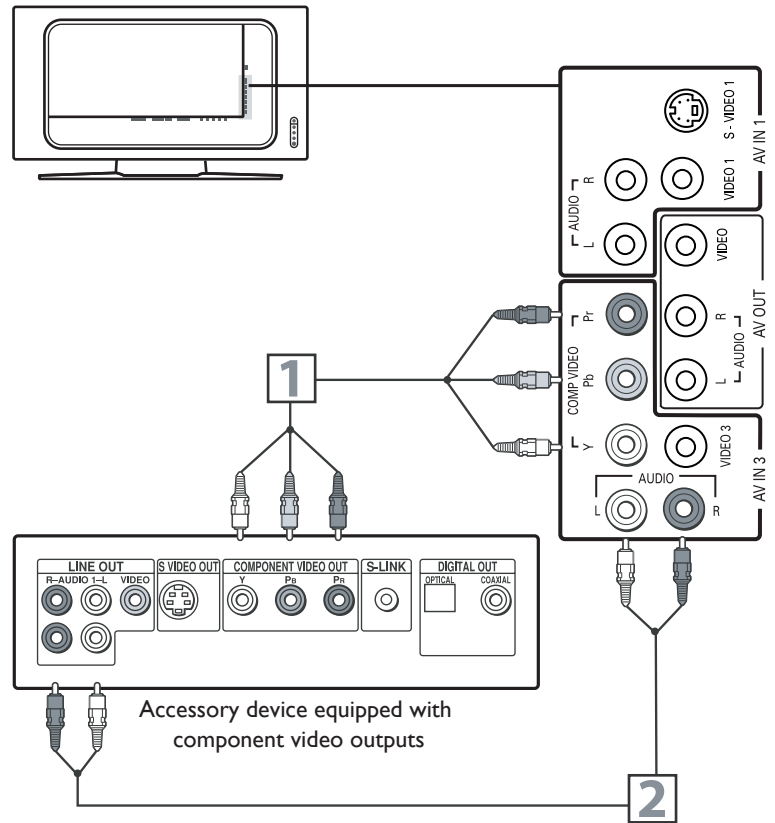

# DIGITAL TV RECEIVER, OR A DIGITAL SATELLITE RECEIVER WITH HD (HIGH DEFINITION) OUTPUT

**A** Digital TV Receiver or a Digital Satellite Receiver is able to produce HD (High Definition) video signal with 480p, 720p, and 1080i formats. A Component (Y, Pb, Pr) Connection is required for this kind of setup.

Note: This setup also support 480i.

**Disconnect all power sources before making any connections.**

**1** Using a Component Video cable, connect the Digital TV Receiver's Y, Pb, Pr jacks to the Y, Pb, Pr jacks on the TV. Use the HD IN connections.

Note: Component Video (Y, Pb, Pr) connections in HD IN connections is necessary to view 480p, 720p, and 1080i formats. Note that the Component Video Input in AV IN 3 Connections can only support 480i format.

**2** Using an Audio cable, connect the Digital TV Receiver's AUDIO OUT jacks to the TV's AUDIO IN jacks in HD IN connections.

**3** Use Source button on the remote control to select HD to watch DVD.

Note: 1. The Y, Pb, Pr jacks do not provide audio, so audio cables must be connected to provide sound.

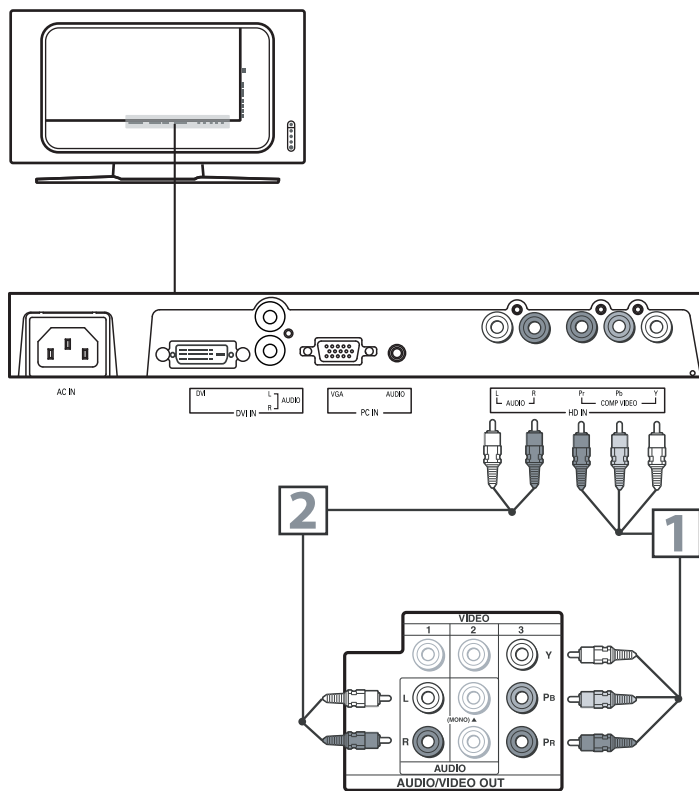

Digital Satellite Receiver with HD output

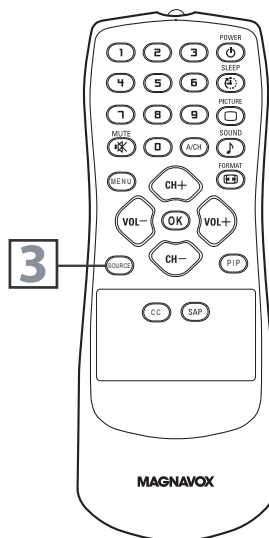



# DIGITAL SATELLITE RECEIVER WITH DVI CONNECTOR

Your LCD TV offers Digital Video Interface (DVI) with High Definition Copy Protection (HDCP) connections. This feature allows a digital connection between set-top boxes and the LCD TV, creating a more vibrant image. DVI HDCP technology allows content providers the ability to utilize the full bandwidth of high definition signals.

**Disconnect all power sources before making any connections.**

- 1** Connect the digital DVI output of your HD device (e.g. DVD player, Set Top Box..) to the DVI connector of the DVI IN connection.
- 2** Connect the AUDIO cable (if audio is present) to the Audio outputs of your HD device and to the AUDIO R (right) and L (left) inputs of the DVI IN connection.
- 3** Use Source button on the remote control to select DVI to watch the programs.

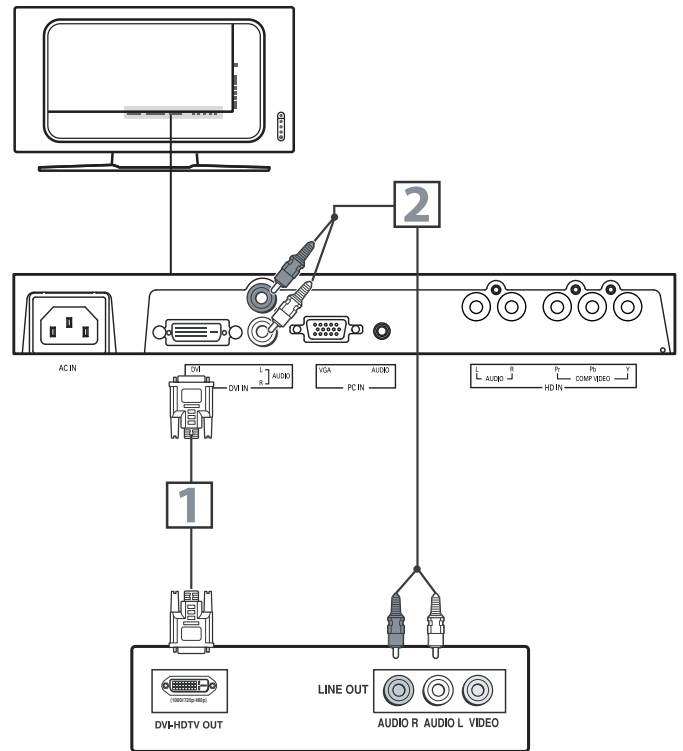

Digital Satellite Receiver with DVI connector

Note:

1. Proper working is only guaranteed with DVI compliant consumer products.
2. Digital devices from different manufactures have the possibility of differing output standards which may cause difficulties for the television to properly display.
3. It is not recommended to connect your PC to LCD TV via DVI connection, since the LCD TV may not support the PC display mode you are using.

DVI is a specific digital input allowing encrypted transmission of uncompressed HD content. DVI includes HDCP (High-Bandwidth Digital Content Protection), which is supported by Hollywood, satellite providers, and most of the consumer electronics industry. DVI is gaining momentum and quickly becoming an industry standard for the consumer to view high definition material while keeping content protected.

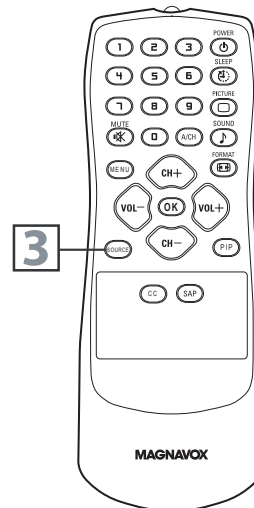

# PC (MONITOR) CONNECTION

**T**his LCD TV can be used as a PC monitor.  
Your computer will have to be equipped with a VGA type video output and VGA cable.

**Disconnect all power sources before making any connections.**

- 1** Using a VGA cable (not supplied), connect PC's VGA OUT connector to the VGA connector on the TV. Use the PC IN connections.
- 2** Using a MINI-JACK type AUDIO cable (not supplied), connect the PC's AUDIO OUT connector to the AUDIO connector on the TV. Use the PC IN connections.
- 3** Use Source button on the remote control to select PC to use your LCD TV as a PC monitor.

Note: 1. Please refer to "Setting Up the PC Mode" section for all the supported PC display modes. If possible, use the 1280 x 720@60Hz video mode to obtain the best PC image quality.

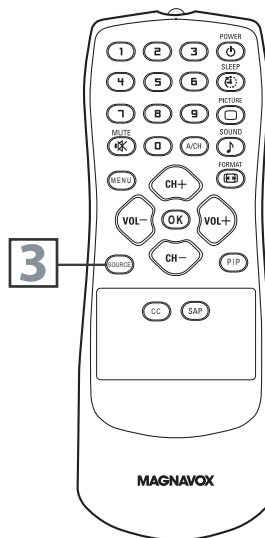
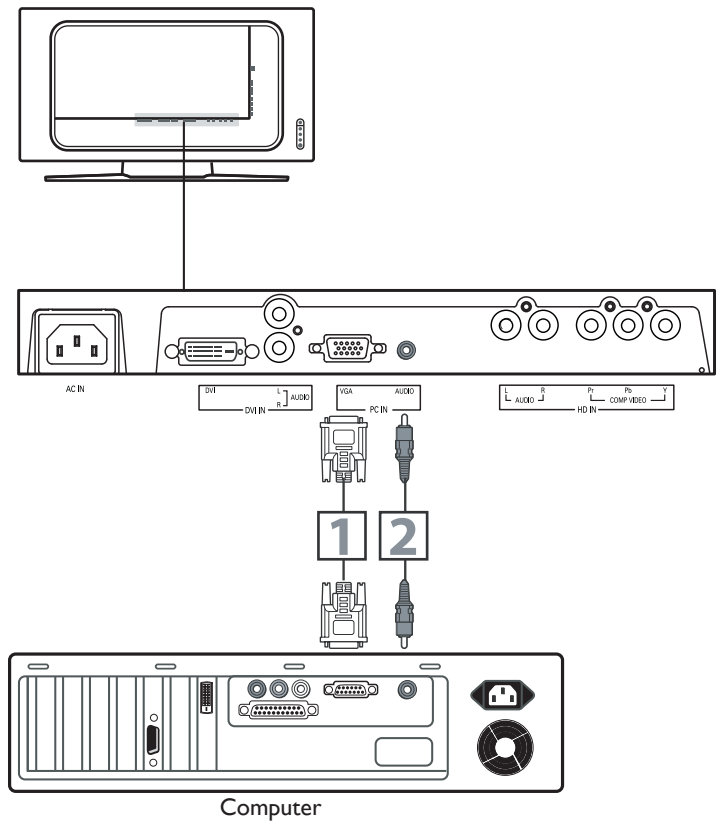





The AV (Audio/Video) out jacks are great for recording with a VCR or used to connect an external audio system for better audio.

**Disconnect all power sources before making any connections.**

**For VCR Connection/Recorder:**



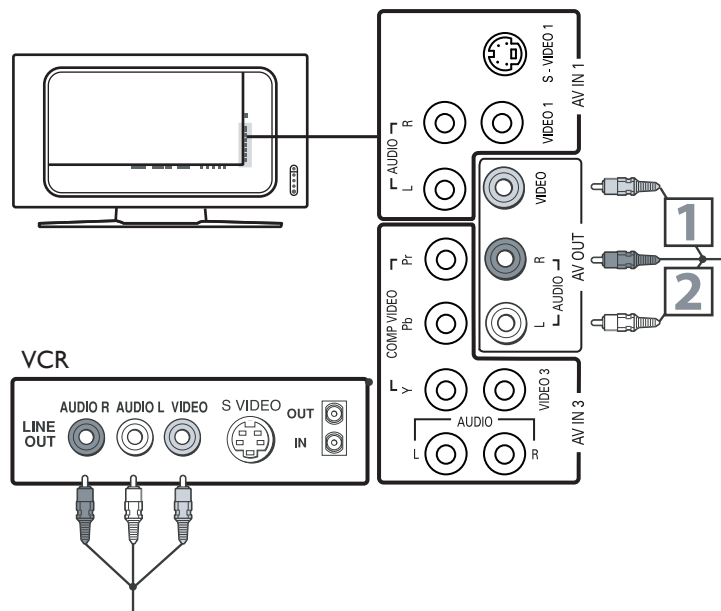

- 1** Connect one end of the yellow Video Cable to the VIDEO jack of AV OUT connection. Connect the other end to the VIDEO IN jack on the VCR.
- 2** Connect one end of the red and white Audio Cable from the L and R AUDIO jack of AV OUT connection to the AUDIO IN jack on the VCR.
- 3** Turn the VCR on, insert a blank VHS tape and it's ready to record what's being viewed on the TV screen.

Note: The Program recording is only possible when the input signal is SD (480i).





**F**or English, French or Spanish-speaking TV owners, an onscreen LANGUAGE option is present. The LANGUAGE control enables you to set the TV's onscreen menu to be shown in either English, French or Spanish.

- 1** Press the MENU  button on the remote control to see the onscreen menu.
- 2** Press the (CH-)  button to highlight the INSTALL menu.
- 3** Press the (VOL+)  button to enter the INSTALL menu.
- 4** Press the (VOL+)  button to select English, French or Spanish.
- 5** Press the MENU  button repeatedly to clear the menu from the screen.

MAIN CONTROLS	
PICTURE ▶	• LANGUAGE
AUDIO ▶	• TUNER MODE
FEATURES ▶	• AUTO PROGRAM
INSTALL	• CHANNEL EDIT
	• MANUAL FINE TUNE
	• FACTORY RESET

INSTALL	
LANGUAGE ◀	◀ ENGLISH ▶
TUNER MODE ▶	
AUTO PROGRAM ▶	
CHANNEL EDIT ▶	
MANUAL FINE TUNE ▶	
FACTORY RESET ▶	

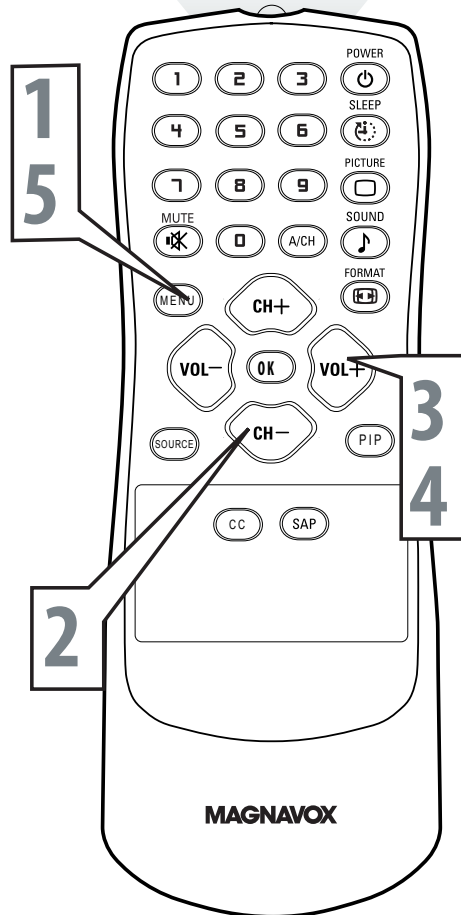

## HELPFUL HINT

Remember, the LANGUAGE control makes only the TV's onscreen MENU items appear in English, French or Spanish text. It does not change the other onscreen text features, such as Closed Captioning (CC), with TV shows.



# TUNER MODE CONTROL

The Tuner Mode allows you to change the LCD TV's signal input to Cable or Air (antenna). It's important for the LCD TV to know if you want to receive channels from a cable TV signal or an antenna signal.

Before making adjustment, press **SOURCE** button on your remote control to switch your LCD TV to the TV MODE.

- 1 Press the Menu button to see the onscreen menu.
- 2 Press the (CH-) button to highlight the INSTALL menu.
- 3 Press the (VOL+) button to enter the INSTALL menu.
- 4 Press the (CH-) button to highlight the TUNER MODE menu.
- 5 Press the (VOL+) or (VOL-) buttons to select CABLE, AIR (antenna), or AUTO.
- 6 Press the MENU button repeatedly to clear the menu from the screen.

MAIN CONTROLS	
PICTURE	• LANGUAGE
AUDIO	• TUNER MODE
FEATURES	• AUTO PROGRAM
INSTALL	• CHANNEL EDIT
	• MANUAL FINE TUNE
	• FACTORY RESET

INSTALL	
LANGUAGE	• CABLE
TUNER MODE	•
AUTO PROGRAM	•
CHANNEL EDIT	•
MANUAL FINE TUNE	•
FACTORY RESET	•

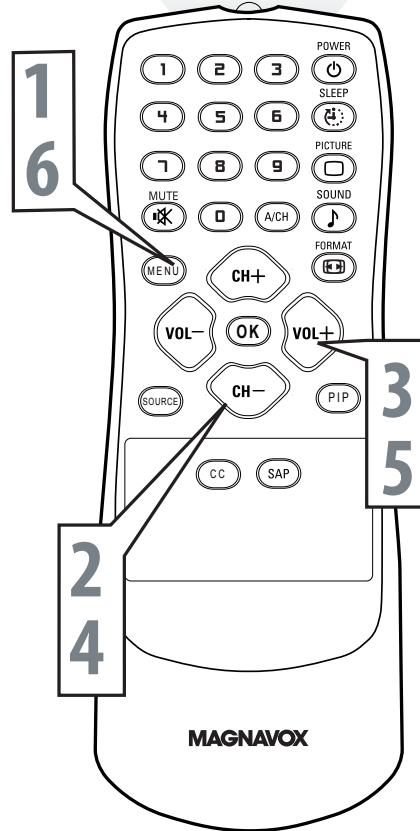

## HELPFUL HINT

- When CABLE is selected, channels 1-125 are available.
- When ANTENNA is selected, channels 2-69 are available.
- When AUTO is selected, your LCD TV will search automatically for antenna and cable channels.



Your LCD TV can automatically set itself for local area (or cable TV) channels. This makes it easy for you to select only the TV stations in your area by pressing the CH (+) or CH (-) button.

- 1 Press the MENU button on the remote control to show the onscreen menu.
- 2 Press the (CH-) button to highlight the INSTALL menu.
- 3 Press the (VOL+) button to enter the INSTALL menu.
- 4 Press the (CH-) button to highlight the AUTO PROGRAM control.
- 5 Press the (VOL+) button to start the AUTO PROGRAM scanning of channels.
- 6 Press the MENU button repeatedly to clear the menu from the screen, after AUTO STORE has finished.

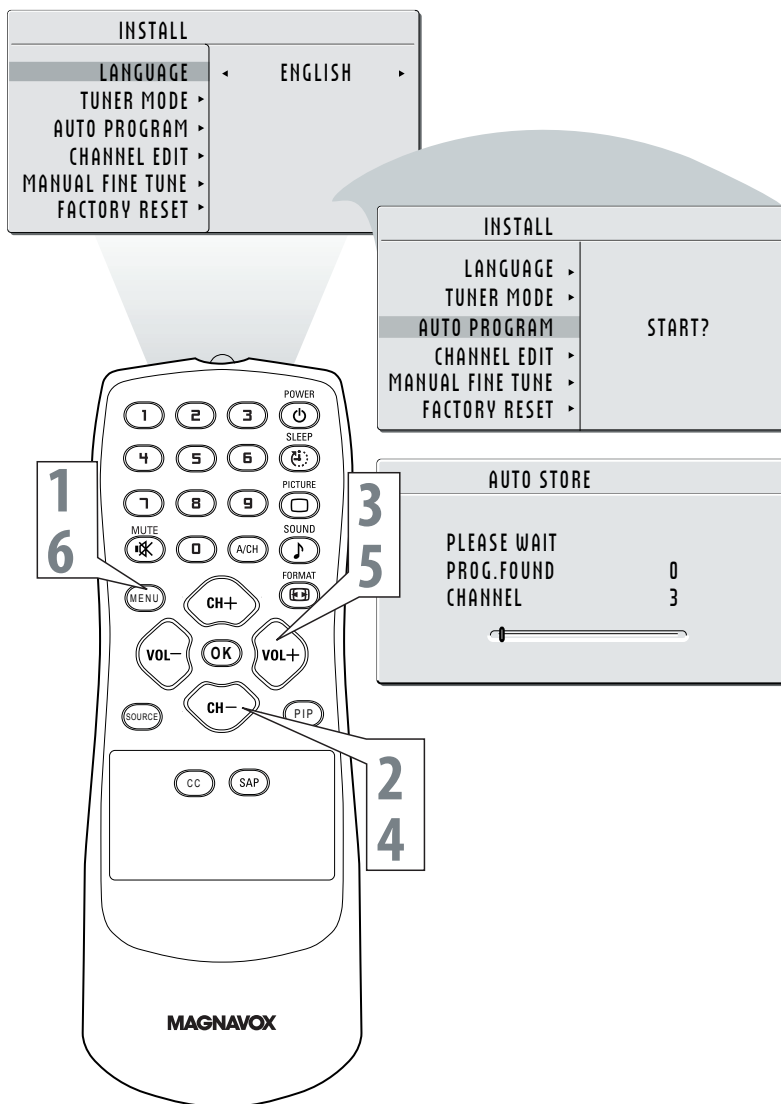

## HELPFUL HINT

After you've run Auto Program, check out the results. Press the CH+ or the CH- button and see which channels you can select.

Remember, an antenna or cable TV signal must first be connected to your LCD TV (see pages 9-10 of this owner's manual).



# CHANNEL EDIT CONTROL

Channel Edit control lets you edit the channel listing. You can add or remove a channel in the LCD TV's memory.

- 1 Press the Menu (MENU) button to see the onscreen menu.
- 2 Press the (CH-) (CH-) button to highlight the INSTALL menu.
- 3 Press the (VOL+) (VOL+) button to enter the INSTALL menu.
- 4 Press the (CH-) (CH-) button to highlight the CHANNEL EDIT menu.
- 5 Press the (VOL+) (VOL+) button to enter the CHANNEL EDIT menu.
- 6 In CHANNEL column, press (VOL+) (VOL+) or (VOL-) (VOL-) to select the channel you wish to add or remove.
- 7 In SKIPPED column, press (VOL+) (VOL+) or (VOL-) (VOL-) to select ACTIVE (to add) or SKIPPED (to delete) the channel you selected.
- 8 Press the MENU (MENU) button repeatedly to clear the menu from the screen.

MAIN CONTROLS	
PICTURE	• LANGUAGE
AUDIO	• TUNER MODE
FEATURES	• AUTO PROGRAM
INSTALL	• CHANNEL EDIT
	• MANUAL FINE TUNE
	• FACTORY RESET

INSTALL	
LANGUAGE	• CHANNEL
TUNER MODE	• SKIPPED
AUTO PROGRAM	
CHANNEL EDIT	
MANUAL FINE TUNE	
FACTORY RESET	

CHANNEL EDIT	
CHANNEL	< 2 >
SKIPPED	

CHANNEL EDIT	
CHANNEL	>
SKIPPED	< ACTIVE >

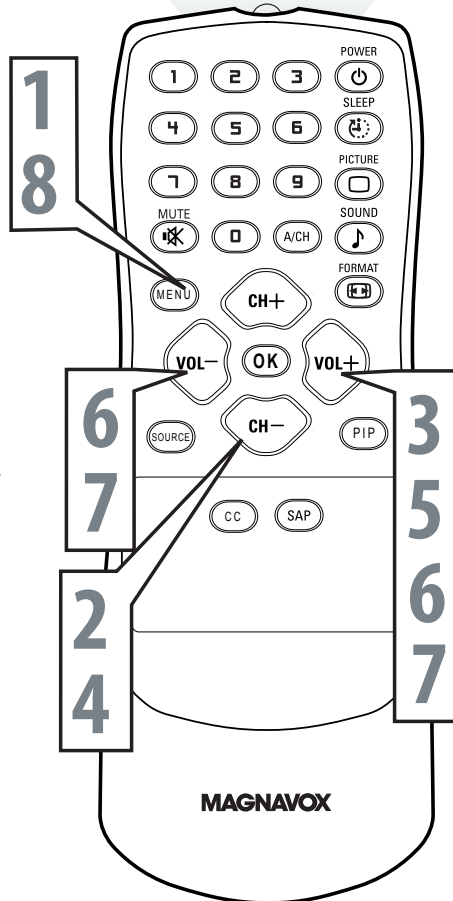







**HELPFUL HINT**

Repeat steps 6 –7 to add or delete additional channels to or from the LCD TV's memory.



Your TV can be reset to the original factory settings by performing the following steps.

- 1 Press the MENU  button on the remote control to see the onscreen menu.
- 2 Press the (CH-)  button to highlight the INSTALL menu.
- 3 Press the (VOL+)  button to enter the INSTALL menu.
- 4 Press the (CH-)  button to highlight the FACTORY RESET control.
- 5 Press the (VOL+)  button to reset the TV to the original factory settings.
- 6 Press the MENU  button repeatedly to clear the menu from the screen.

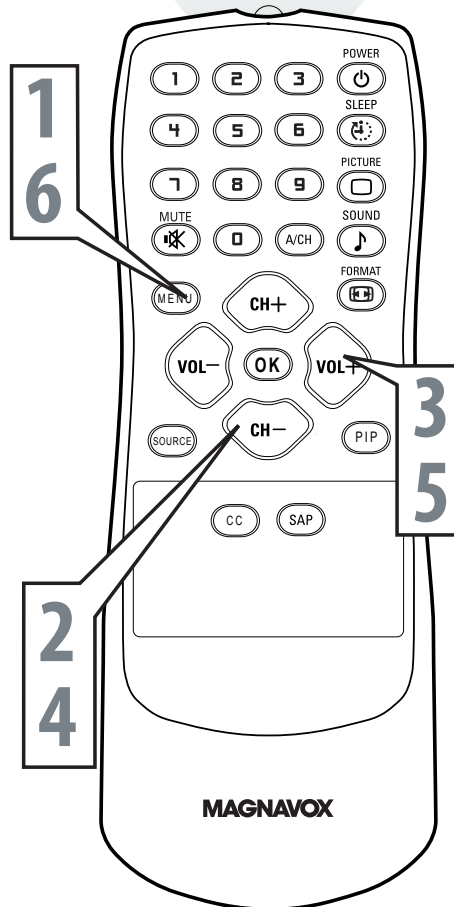
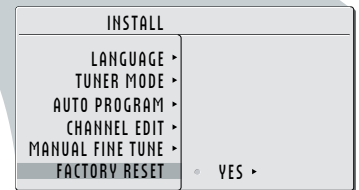
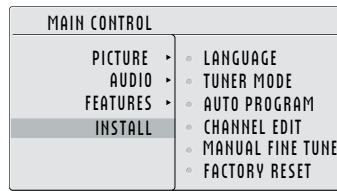



## HELPFUL HINT

If you reset the TV to the factory settings, all your present setting on picture, audio and other feature settings will be erased and replaced by the manufacture's default settings. However, your AutoLock access code will not be erased. Please refer to page 25 for details.



## SMART PICTURE CONTROL

Whether you're watching a movie or a video game, your LCD TV has video control preset that will match with your current program source or content. Smart Picture quickly resets your TV's video controls for a number of different types of programs and viewing conditions that you may have in your home. The Movies, Sports, Weak Signal, Multimedia, and Night Smart Picture controls have been preset at the factory to easily adjust the TV's brightness, color, picture, sharpness, tint, and color temperature levels. In the Personal smart picture mode you can create your own preferred video settings.

- 1 Press the PICTURE button  on the remote control. The current Smart Picture setting will appear on the screen.
- 2 Press the PICTURE button  repeatedly to select either Personal, Movies, Sports, Weak Signal, Multimedia, and Night Smart Picture settings.

Note: The settings of the Personal smart picture mode can be adjusted in picture options within the onscreen menu. The Personal mode is the only mode which can be adjusted by the user via the onscreen picture control menu.

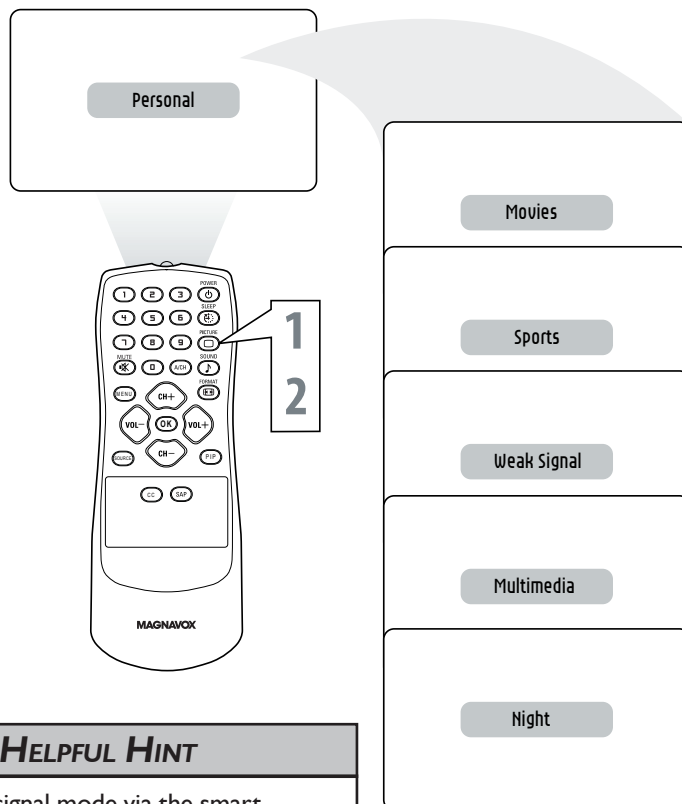

### HELPFUL HINT

Select weak signal mode via the smart picture settings in case your VCR or TV antenna signal is showing a lot of noise or strange patterns.

## SMART SOUND CONTROL

Smart Sound allows you to select from three user presets and a personal mode that you set according to your own preferences through the onscreen Sound menu. The three user presets (News, Music, and Theatre) enable you to tailor the TV sound so as to enhance the particular program you are watching. Following these steps to select any of the options.

- 1 Press the Sound button on the remote control. The current Smart Sound setting will appear on the screen.
- 2 Press the Sound button repeatedly to toggle among the four settings: Personal, News, Music, or Theatre.

Note: The settings of the Personal smart sound mode can be adjusted in sound control within the onscreen menu. The Personal mode is the only mode which can be adjusted by the user via the onscreen sound control menu.

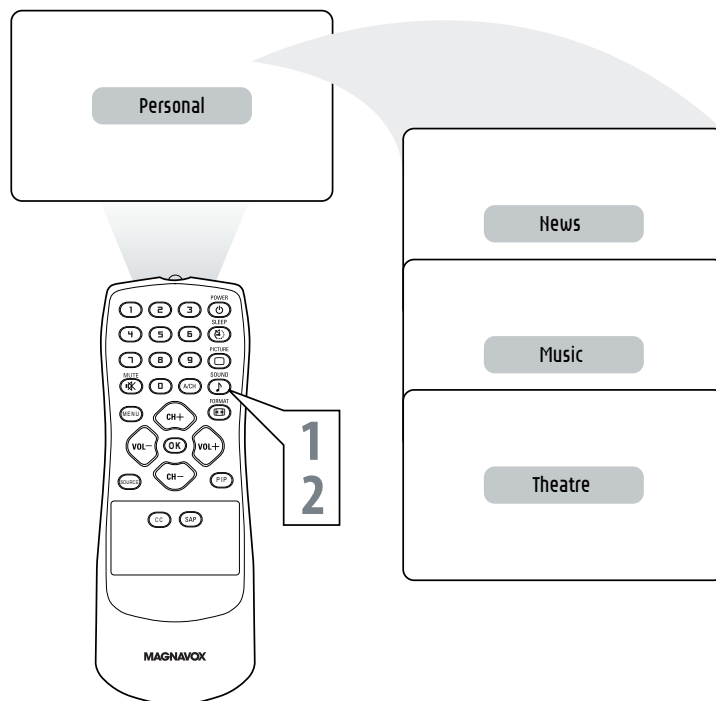





To adjust your LCD TV picture, select a channel and follow these steps.

- 1 Press the MENU button to see the onscreen menu.
- 2 When PICTURE menu is highlighted, press the (VOL+) button to enter the PICTURE menu.
- 3 Press the (CH+) or (CH-) button to choose the item you want to adjust: Smart Picture, Brightness, Color, Contrast, sharpness or Tint.
  - Smart Picture:** Please refer to page 22, for details on Smart Picture Settings.
  - Brightness:** Adjust to brighten the dark parts of the picture. This appears to add white to the color.
  - Color:** Adjust to add or reduce color.
  - Contrast:** Adjust to “sharpen” the Picture quality. The black portions of the picture become richer in darkness and the white become brighter.
  - Sharpness:** Adjust to improve detail.
  - Tint:** Adjust to obtain natural skin tones.
- 4 Press the (VOL+) or (VOL-) button to adjust the item.
- 5 Press the (CH+) or (CH-) button to select and adjust other picture controls.
- 6 Press the MENU button repeatedly to remove the menu.

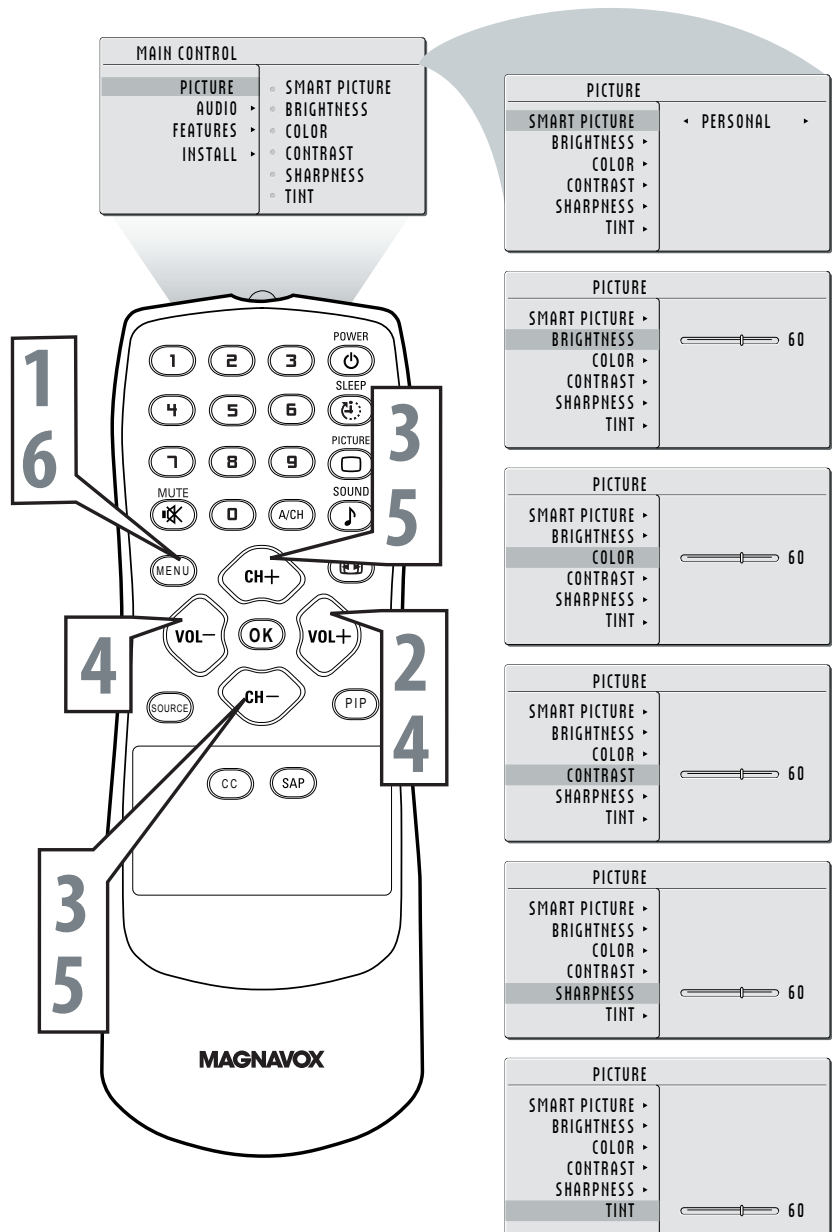

## HELPFUL HINT

Brightness, color, contrast, and sharpness can only be accessed when Smart Picture is set to PERSONAL.



# TV SOUND MENU CONTROLS

To adjust your LCD TV Sound, select a channel and follow these steps.

1 Press the MENU (MENU) button to see the menu.

2 Press the (CH-) (CH-) button to highlight the AUDIO menu.

3 Press the (VOL+) (VOL+) button to enter the AUDIO menu.

4 Press the (CH+) (CH+) or (CH-) (CH-) button to choose the item you want to adjust: Smart Sound, Treble, Bass or Balance.

**Smart Sound:** Please refer to page 22 for details on Smart Sound Settings.

**Settings:** Allows you to adjust Treble, Bass, and Balance of the sound.

**Stereo:** Adjust to select between Stereo, Mono, or SAP.

**Virtual Surround:** Adds greater depth and dimension to TV sound. Select from Virtual Surround or OFF.

**AVL (Auto Volume Leveler):** When On, AVL will level out the sound being heard when sudden changes in volume occur during commercial breaks or channel changes.

5 Press the (VOL+) (VOL+) or (VOL-) (VOL-) button to adjust the item.

6 Press the (CH+) (CH+) or (CH-) (CH-) button to select and adjust other sound controls.

7 Press MENU (MENU) to remove the menu.

MAIN CONTROL	
PICTURE	• SMART SOUND
AUDIO ▶	• SETTINGS
FEATURES	• STEREO
INSTALL ▶	• VIRTUAL SURROUND
	• AVL

AUDIO	
SMART SOUND	◀ PERSONAL ▶
SETTINGS ▶	
STEREO ▶	
VIRTUAL SURROUND ▶	
AVL ▶	

AUDIO	
SMART SOUND ▶	• TREBLE
SETTINGS ▶	• BASS
STEREO ▶	• BALANCE
VIRTUAL SURROUND ▶	
AVL ▶	

AUDIO	
SMART SOUND ▶	
SETTINGS ▶	
STEREO	◀ STEREO ▶
VIRTUAL SURROUND ▶	
AVL ▶	

AUDIO	
SMART SOUND ▶	
SETTINGS ▶	
STEREO ▶	
VIRTUAL SURROUND	◀ VIRTUAL SURROUND ▶
AVL ▶	

AUDIO	
SMART SOUND ▶	
SETTINGS ▶	
STEREO ▶	
VIRTUAL SURROUND ▶	
AVL	◀ YES ▶

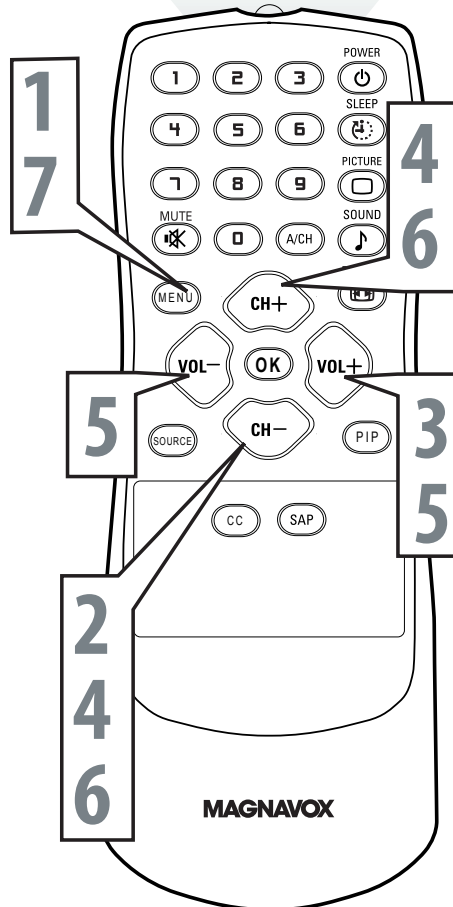

## HELPFUL HINT

- Treble and Bass can only be accessed when Smart Sound is set to Personal.
- If Stereo is not presented on a selected show and the TV is placed in Stereo mode, the sound coming from TV will remain in Mono mode.
- In case the sound from a VCR, DVD or other external AV device is poor, activate AVL [yes] and put the smart sound settings in personal mode and optimize the sound by changing the treble and bass settings.



The AUTO Lock feature is an integrated circuit that receives and processes data sent by broadcasters, or other program providers, that contain program content advisories.

When programmed by the viewer, a TV with AUTO Lock can respond to the content advisories and block program content that may be found objectionable (such as offensive language, violence, sexual situations, etc.).

This is a great feature to censor the type of viewing children may watch.

## AUTO Lock offers various BLOCKING controls from which to choose:

**Access Code** - An Access Code must be set to prevent children from unblocking questionable or censored programming set by their parents.

**Block Enable** - After an access code has been programmed, you can block programming depending on the received rating and user setting.

**Movie Ratings** - Certain blocking options exist which will block programming based on ratings patterned by the Motion Pictures Association of America.

**TV Ratings** - Just like the Movie Ratings, programs can be blocked from viewing using standard TV ratings set by TV broadcasters.

MOVIE RATING	
G	◀ ON ▶
PG ▶	
PG13 ▶	
R ▶	
NC17 ▶	
X ▶	

## MOVIE RATINGS

**G: General Audience** - All ages admitted.

Most parents would find this program suitable for all ages. This type of programming contains little or no violence, no strong language, and little or no sexual dialog or situations.

**PG: Parental Guidance Suggested** - This programming contains material that parents may find unsuitable for younger children. It may contain one or more of the following: moderate violence, some sexual situations, infrequent coarse language, or some suggestive dialog.

**PG-13: Parents Strongly Cautioned** -

This programming contains material that parents may find unsuitable for children under the age of 13. It contains one or more of the following: violence, sexual situations, coarse language, or suggestive dialog.

**R: Restricted** - This programming is specifically designed for adults. Anyone under the age of 17 should only view this programming with an accompanying parent or adult guardian. It contains one or more of the following: intense violence, intense sexual situations, strong coarse language, or intensely suggestive dialog.

**NC-17: No children under the age of 17 will be admitted.** - This type of programming should be viewed by adults only. It contains graphic violence, explicit sex, or crude, indecent language.

**X: Adults Only** - This type of programming contains one or more of the following: very graphic violence, very graphic and explicit or indecent sexual acts, and very coarse and intensely suggestive language

TV RATING	
V	◀ ON ▶
V7 ▶	
G ▶	
PG ▶	
14 ▶	
MA ▶	

## TV RATINGS

**TV-Y All children** - Appropriate for all children. Designed for a very young audience, including children ages 2-6.

This type of programming is not expected to frighten younger children.

**TV-Y7 Directed to Older Children** - Designed for children age 7 and above.

It may be more appropriate for children who can distinguish between make-believe and reality. This programming may include mild fantasy and comic violence (FV or fantasy violence).

**TV-G General Audience** - Most parents would find this programming suitable for all ages. This type of programming contains little or no violence, no strong language, and little or no sexual dialog or situations.

**TV-PG Parental Guidance Suggested** -

Contains material that parents may find unsuitable for younger children. This type of programming contains one or more of the following: Moderate violence (V), some sexual situations (S), infrequent coarse language (L), or some suggestive dialog (D).

**TV-14 Parents Strongly Cautioned** -

Contains some material that many parents would find unsuitable for children under age 14. This type of programming contains one or more of the following: intense violence (V), intense sexual situations (S), strong coarse language (L), or intensely suggestive dialog (D).

**TV-MA Mature Audience Only** -

Specifically designed to be viewed by adults and may be unsuitable for children under 17. This type of programming contains one or more of the following: graphic violence (V), explicit sexual situations (S), or crude, indecent language (L)



# AUTO LOCK ACCESS CODE

Over the next few pages you'll learn how to block programs and understand the rating terms for certain broadcasts. First, set an access code.

- 1 Press the MENU button to see the onscreen menu.
- 2 Press the (CH-) button to highlight the FEATURES menu.
- 3 Press the (VOL+) button to enter the FEATURES menu.
- 4 Press the (CH-) button to select AUTO LOCK.
- 5 Press the (VOL+) button CHANGE CODE will appear on the screen.
- 6 Enter a four-digit code using the Number buttons. The screen will prompt you to confirm the code you just entered. Enter your same new code again.
- 7 Press MENU repeatedly to remove the menu from the screen.

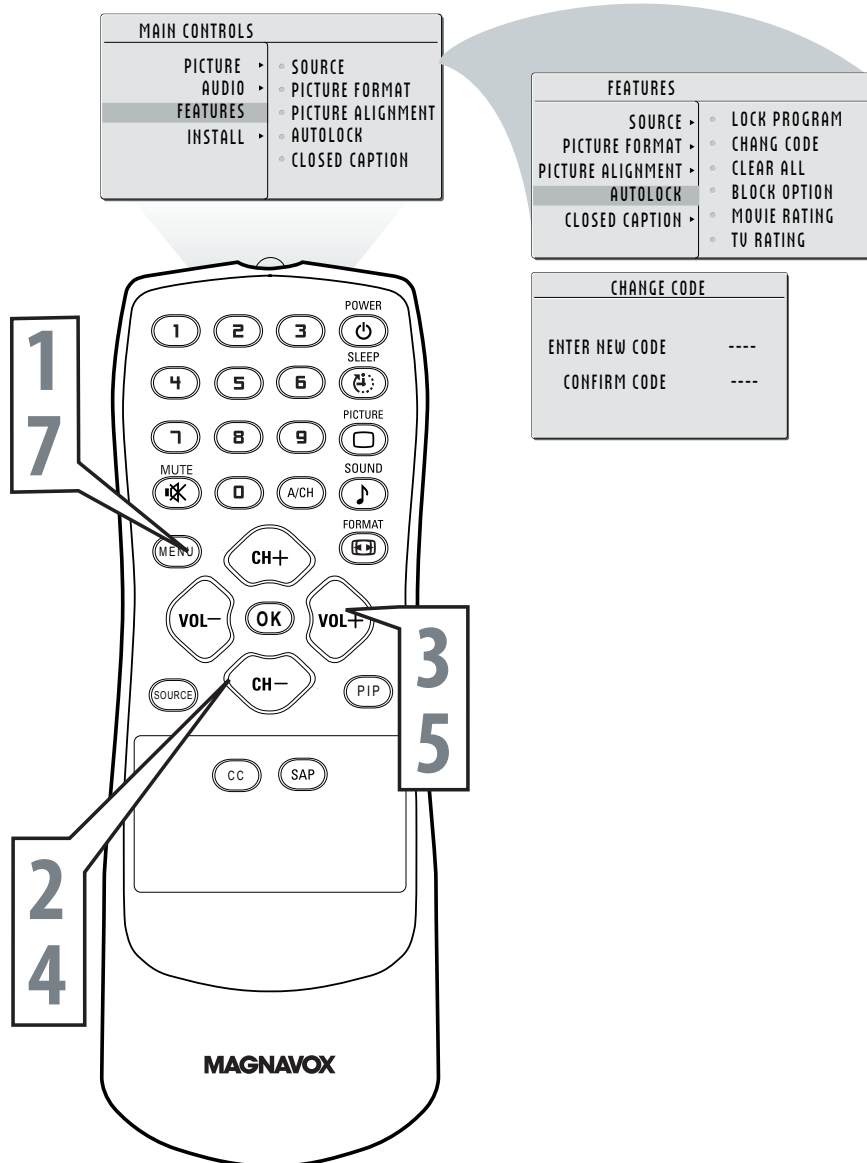







## HELPFUL HINT

Remember that 0711 is the default Auto Lock code. If your access code has been changed by someone other than you (a child, for example) or you have forgotten the code, you can always get access by inputting the default code (0711).

**NOTE TO PARENTS:** It is not possible for your child to unblock a channel without knowing your access code or changing it to a new one. If your code has been changed without your knowledge, then you will become aware that blocked channel may have been viewed.



After your personal access code has been set (see the previous page), you are ready to select the channels or inputs you want to block out or censor.

- 1 Press the MENU  button to see the onscreen menu.
- 2 Press the (CH-)  button to highlight the FEATURES menu.
- 3 Press the (VOL+)  button to enter the FEATURES menu.
- 4 Press the (CH-)  button to select AUTO LOCK.
- 5 Press the (VOL+)  button to enter AUTO LOCK menu.
- 6 Use the Number buttons to enter your access code.
- 7 Press the (VOL+)  button to block current selected channel or (VOL-) button to unblock a channel.
- 8 Press MENU  repeatedly to remove the menu from the screen.

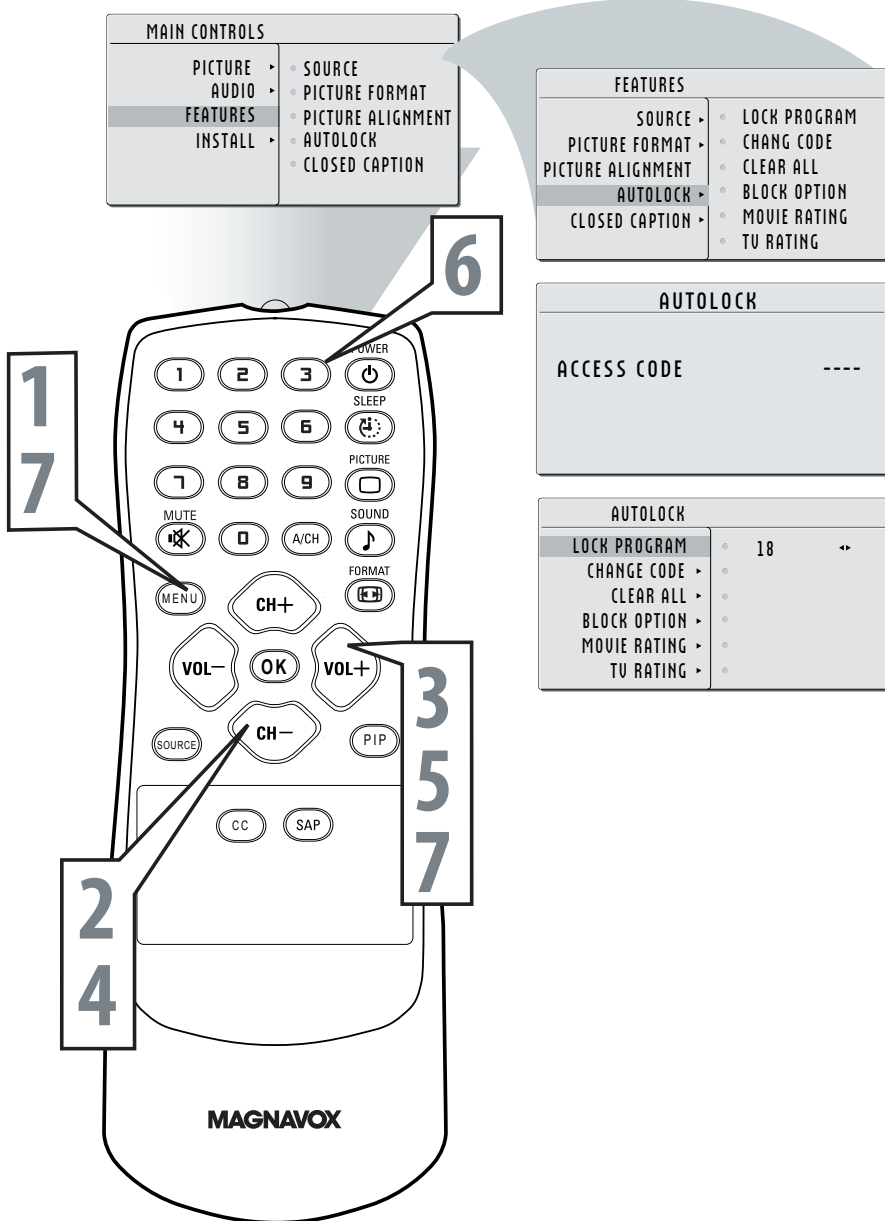

Note: You can block additional channels by using Number buttons to jump to another channel.



# AUTO LOCK - MOVIE RATINGS

The AUTO Lock feature can block programming based on the Movie Industry ratings. Once you've entered your access code and the AUTO Lock features are displayed on the screen:

- 1 Press the MENU button to see the onscreen menu.
- 2 Press the (CH-) button to highlight the FEATURES menu.
- 3 Press the (VOL+) button to enter the FEATURES menu.
- 4 Press the (CH-) button to select AUTO LOCK.
- 5 Press the (VOL+) button, INPUT USER CODE will appear.
- 6 Use the Number buttons to enter your access code.
- 7 Press the (CH-) button to select MOVIE RATING.
- 8 Press the (VOL+) button to highlight any of the Movie Rating options. When highlighted, all these options can be (ON) blocked or (OFF) unblocked.
- 9 Press MENU repeatedly to remove the menu from the screen.

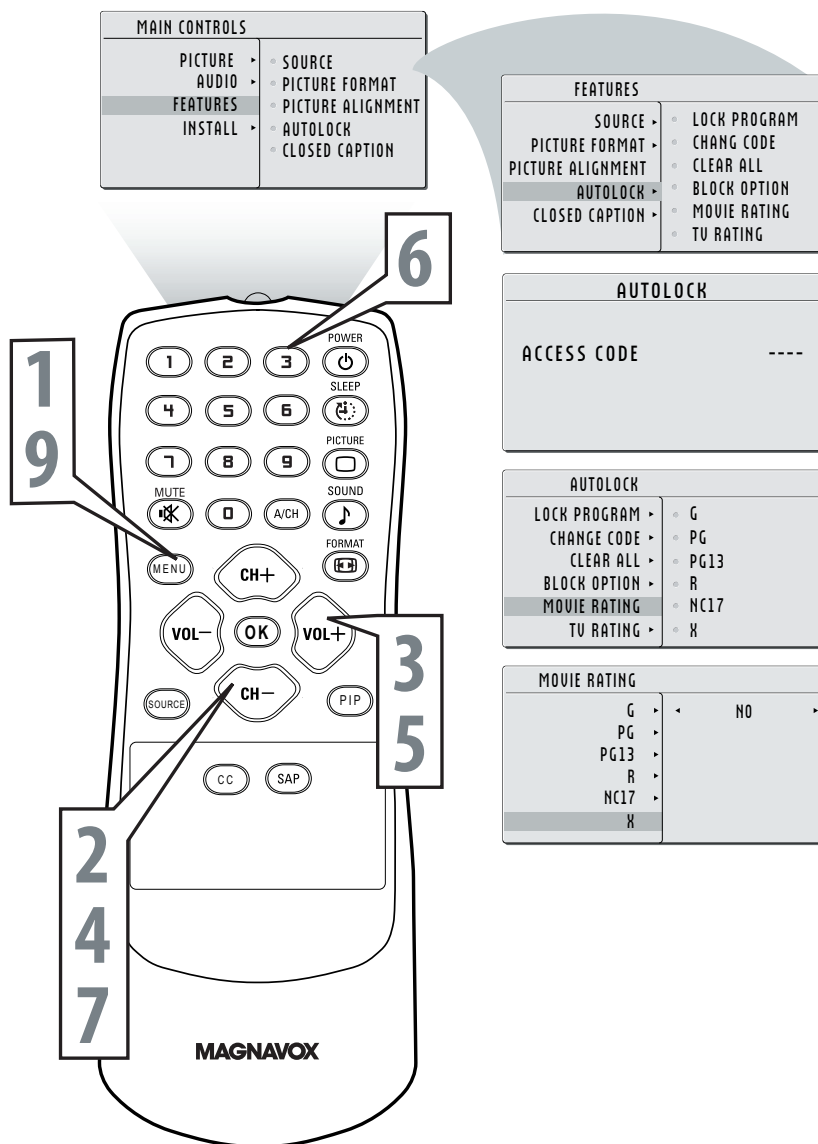

## HELPFUL HINT

When a rating is chosen to be blocked, any higher level rating will also be blocked from viewing (i.e.: If "R" is selected to be blocked, NC-17 and X will automatically be blocked.) When a rating is set to unblock, only the selected rating will be unblocked (Ratings lower will not automatically be unblocked).



The AUTO Lock feature can block programming based on the TV Industry ratings. Once you've entered your access code and the AUTO Lock features are displayed on the screen:

- 1 Press the MENU button to see the onscreen menu.
- 2 Press the (CH-) buttons to highlight the FEATURES menu.
- 3 Press the (VOL+) buttons to enter the FEATURES menu.
- 4 Press the (CH-) button to highlight AUTO Lock.
- 5 Press the (VOL+) button, INPUT USER CODE will appear on the screen.
- 6 Use the Number buttons to enter your access code.
- 7 Press the (CH-) buttons to select TV RATING.
- 8 Press the (VOL+) or (VOL-) button to highlight any of the TV Rating options. When highlighted, all these options can be (ON) blocked or (OFF) unblocked.
- 9 Press MENU repeatedly to remove the menu from the screen.

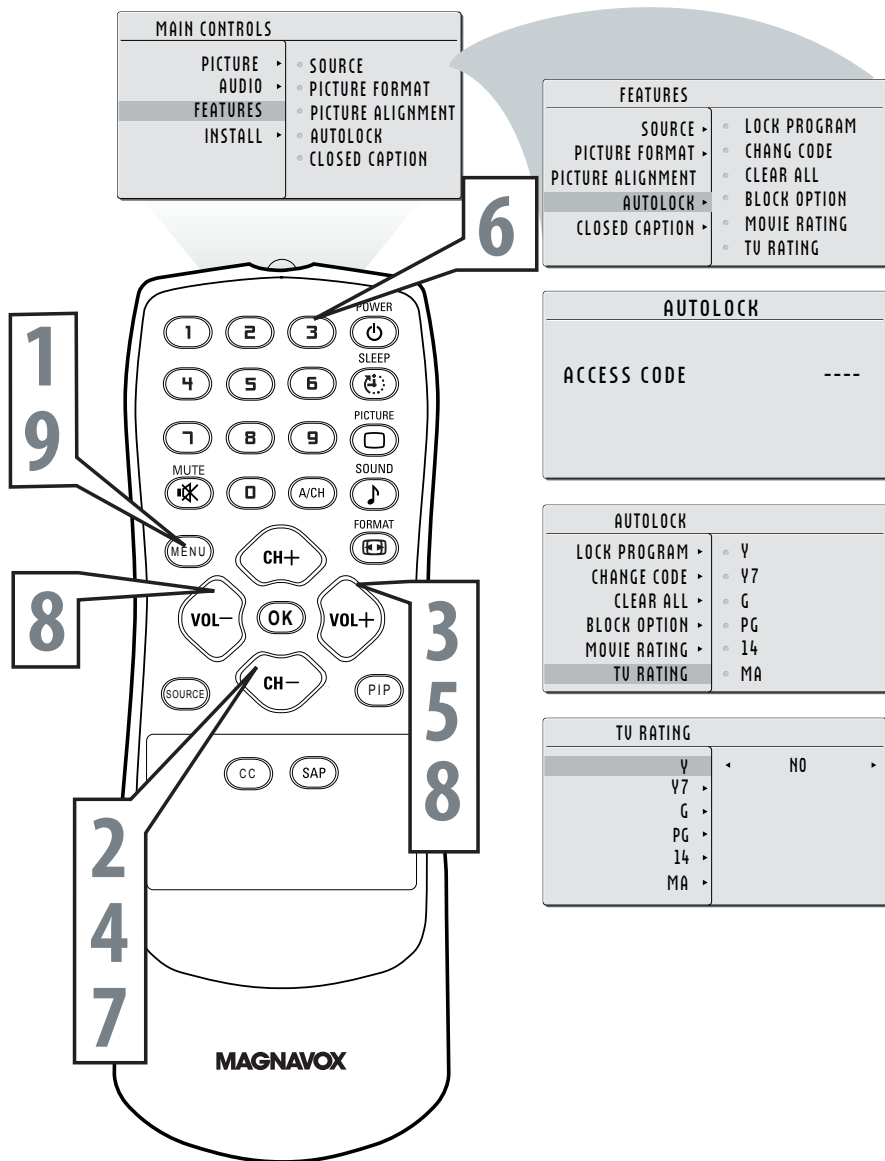

## HELPFUL HINT

When a rating is chosen to be blocked, any higher level rating will also be blocked from viewing (i.e.: If "R" is selected to be blocked, NC-17 and X will automatically be blocked.) When a rating is set to unblock, only the selected rating will be unblocked (Ratings lower will not automatically be unblocked).





# USING THE PICTURE FORMAT

You can change the picture format size to match the type of program you are watching. Select the normal 4:3, ZOOM 16:9, SUPERWIDE, or WIDESCREEN aspect ratio.

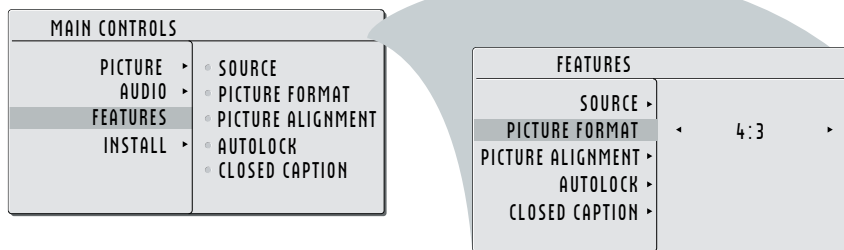

## Picture Format

### 4:3

Display pictures of normal size (i.e., a 4:3 aspect ratio).



### ZOOM 16:9

Vertically extend the height to eliminate the upper and lower part of the image. Ideal for displaying picture recorded in 2.35 :1 aspect ratio (Cinema Vision size).

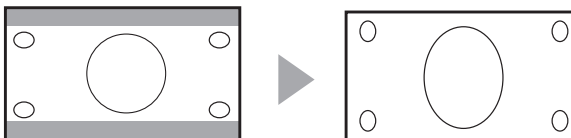

### SUPERWIDE

Displays nature-looking pictures of standard size (i.e., a 4:3 aspect ratio) on the wide screen.



### WIDESCREEN

Display pictures in wide format. Ideal for display pictures recorded in native 16:9 aspect ratio (i.e., a HDTV broadcasting program).

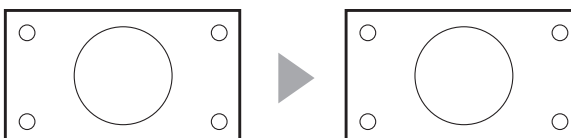

### Note:

1. You can directly change the picture format by pressing the FORMAT button on your remote control.
2. The Picture Format Function is not accessible in PC MODE.
3. In HD and DVI MODE, the Picture Format Function is only accessible when input video signal is SD (e.g. 480i/480p). If input video signal is HD (e.g. 720p/1080i), the Picture Format Function will not be accessible.



**C**losed Captioning (CC) allows you to read the voice content of television programs on the TV screen. Designed to help the hearing impaired, this feature uses onscreen "text boxes" to show dialogue and conversations while the TV program is in progress.

- 1** Press the MENU button to see the onscreen menu.
- 2** Press the (CH-) button to highlight the FEATURES menu.
- 3** Press the (VOL+) button to enter the FEATURES menu.
- 4** Press the (CH-) button to select CLOSE CAPTION.
- 5** Press the (VOL+) button to select the closed caption you want: CC MUTE, CCI, CC2, CC3, CC4, Txt1, Txt2, Txt3 or Txt4.

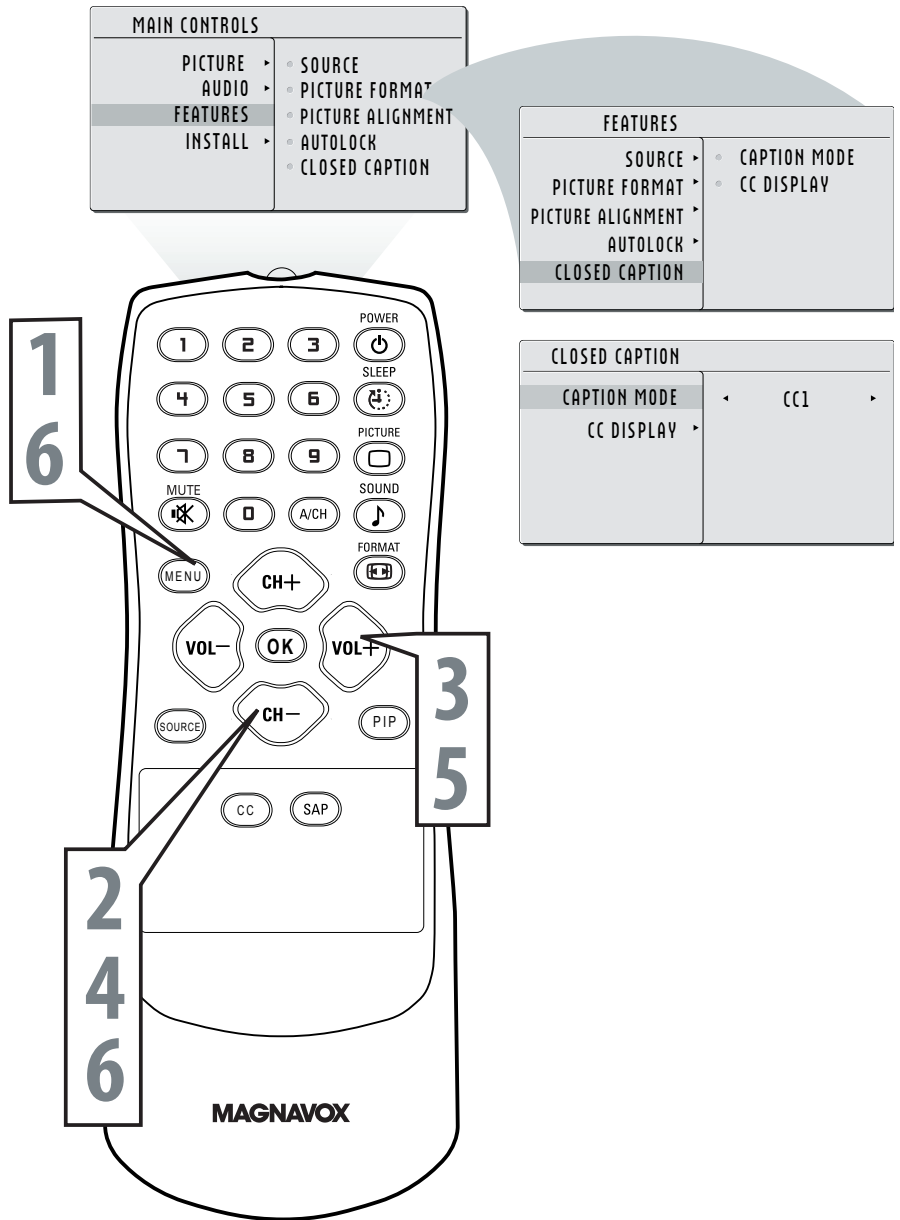

Note: Closed Caption can also be activated by pressing CC button on your remote control.

## HELPFUL HINT

Not all TV programs and product commercials are broadcast with Closed Captioning (CC). Nor are all Closed Captioning MODES (CAPTION 1-4 or TEXT 1-4) necessarily being used by broadcast stations during the transmission of a program offering Closed Captioning. Refer to your area's TV program listings for the stations and times of shows being broadcast with Closed Captioning.



# PC PICTURE CONTROLS

This TV can also be used as a PC Monitor. A PC video signal must be present or the TV will go into standby mode. The PC Picture controls allow you to adjust the picture.

Note: Make sure you are in PC mode.

- 1 Press the MENU button on the remote control to see the onscreen menu.
- 2 When the PICTURE menu is highlighted, press the (VOL+) buttons to enter the PICTURE menu.
- 3 Press the (CH +) or (CH -) button to highlight the item that you would like to adjust.
  - Smart Picture:** Adjust the color temperature of the picture. Select from Normal, Cool, or Warm.
  - Brightness:** Adjust to brighten the darkest parts of the picture.
  - Contrast:** Adjust to “sharpen” the Picture quality. The black portions of the picture become richer in darkness and the white become brighter.
  - Auto Adjust:** The LCD Monitor will automatically adjust to the best image position, phase, and clock setting.
  - Manual Adjust:** The Manual Adjust control allow you to manually fine tune the image as it appears on the screen.
  - Phase-eliminates** the horizontal interfering lines.
  - Clock-eliminates** the vertical interfering lines.
  - Horizontal-adjust** the horizontal placement of the picture.
  - Vertical-adjust** the vertical placement of the picture.
- 4 Press the (VOL+) or (VOL-) button to adjust the item.
- 5 Press MENU repeatedly to remove the menu from the screen.

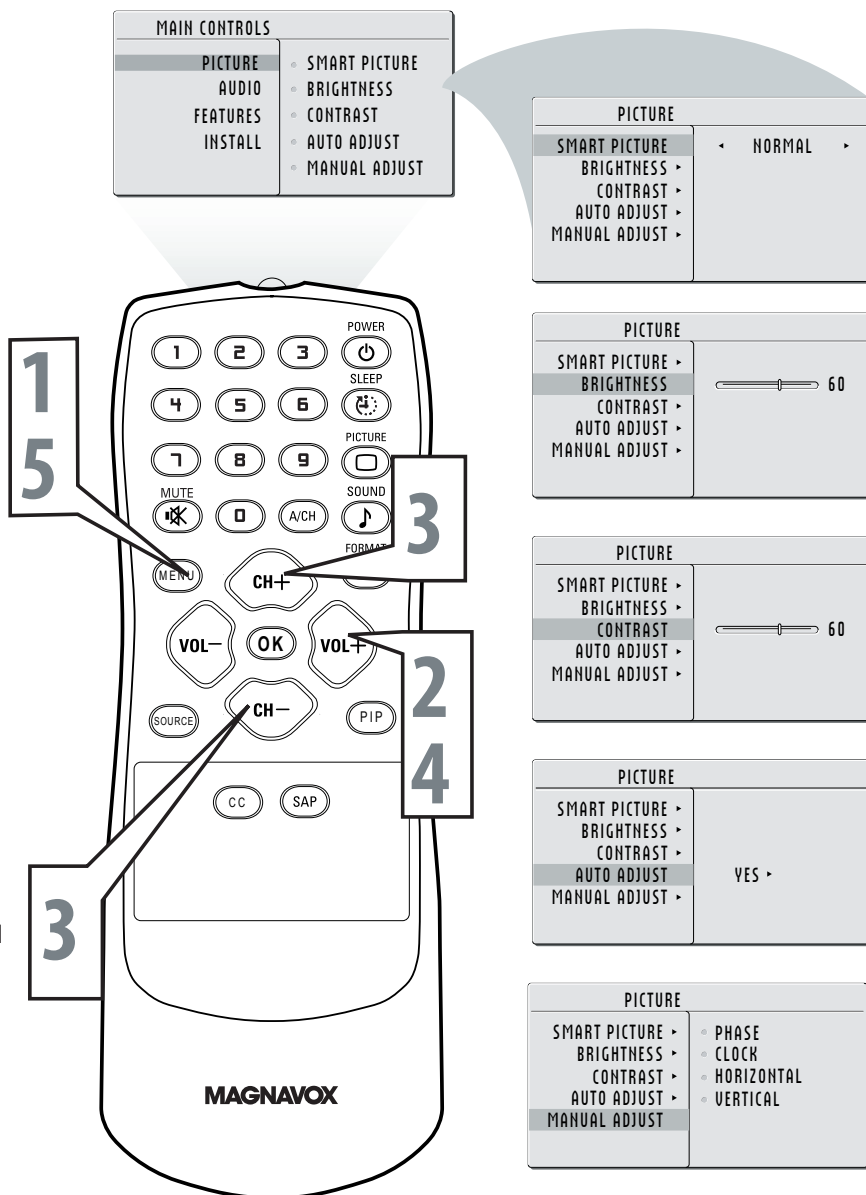

Note: To adjust other items repeat steps 4 and 5.



This TV can also be used as a PC Monitor. A PC video signal must be present or the TV will go into standby mode. The AUDIO controls allow you to adjust the sound.

Note: Make sure you are in PC mode.

- 1 Press the MENU button on the remote control to show the onscreen menu.
- 2 Press the (CH-) button to highlight the AUDIO menu.
- 3 Press the (VOL+) button to shift the menu to the right to enter the AUDIO menu.
- 4 Press the (CH+) or (CH-) button to highlight the item that you would like to adjust:  
**Smart Sound:** Allows you to select from 3 factory-set controls and a personal control. The 3 factory-set controls (News, Music, and Theatre) enhance the particular program you are watching.  
**Settings:** Allows you to adjust Treble, Bass, and Balance of the Sound.  
**Stereo:** To select from Stereo, Mono, and SAP.  
**Virtual Sound:** Adds greater depth and dimension to PC sound.  
**AVL (Auto Volume Leveler)**- When ON, AVL will level out the sound being heard when sudden changes in volume occur during commercial breaks or channel changes.
- 5 Press the (VOL+) or (VOL-) buttons to adjust the item.
- 6 Press MENU repeatedly to remove the menu from the screen.

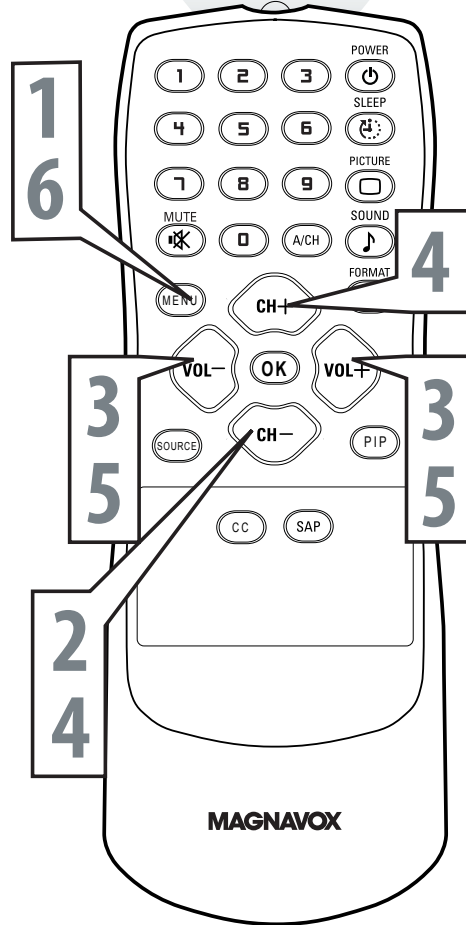
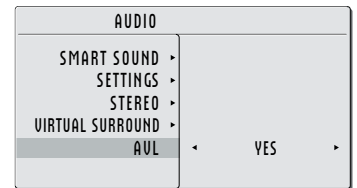
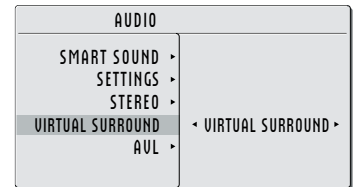
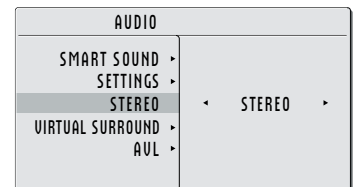
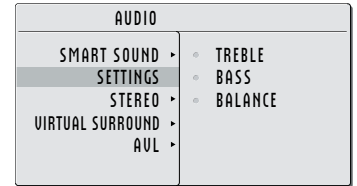
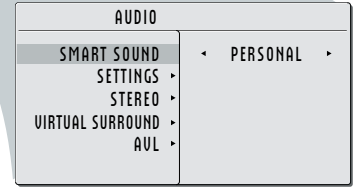
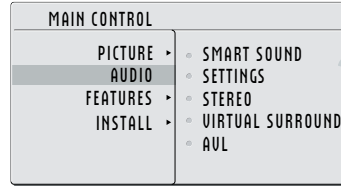

## HELPFUL HINT







To adjust other items repeat steps 4 and 5.



# USING PC PIP (PICTURE IN PICTURE) FEATURE

**P**IP (Picture-in-Picture) feature allows you to call up a subscreen when you are using your TV as a monitor.

Note: Make sure you are in PC mode.

- 1 Press the MENU  button to see the onscreen menu.
- 2 Press (CH -)  button to highlight the FEATURE menu.
- 3 Press (VOL+)  button to enter the FEATURE menu.
- 4 Press (VOL+)  button to enter the PIP menu.
- 5 Press the (CH +)  or (CH -)  buttons to highlight the item that you would like to adjust.

**SIZE:** Turn off and set the size of PIP. You can choose your preferred size of small, medium, large, or PBP (Picture Beside Picture).

**Video:** Select video source of PIP from AV, S-Video, TV, or Component.

**Audio:** Select audio source of PIP or PC.

**Display:** Select which corner of the position of PIP.

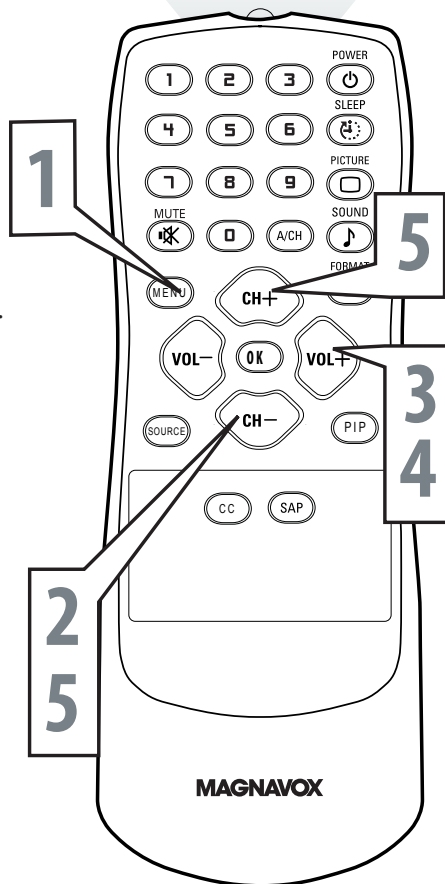
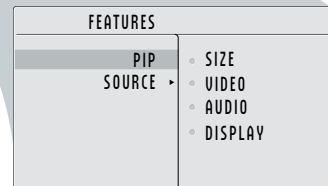
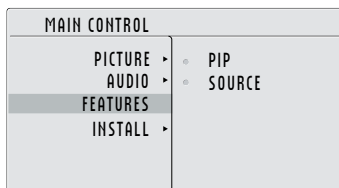

## HELPFUL HINT

PIP windows with Component video source can only support up to 480i (SD) video signal.

# SETTING UP THE PC MODE (PERSONAL COMPUTER MONITOR)



## 26MF Series (26" LCD TV)

No	Resolution	Mode	V. Frequency (Hz)	H. Frequency (kHz)
1	640 x 480	VGA VESA 60	59.940	31.469
2	800 x 600	SVGA VESA 56	56.250	35.156
3		SVGA VESA 60	60.317	37.897
4	1024 x 768	XGA VESA 60	60.004	48.363
* 5	1280 x 720	VESA CVT	59.855	44.772
6	1280 x 768	VESA CVV	60.000	47.700

\* Recommended Resolution

## 32MF Series (32" LCD TV)

No	Resolution	Mode	V. Frequency (Hz)	H. Frequency (kHz)
1	640 x 480	VGA VESA 60	59.940	31.469
2	800 x 600	SVGA VESA 56	56.250	35.156
3		SVGA VESA 60	60.317	37.897
4	1024 x 768	XGA VESA 60	60.004	48.363
* 5	1280 x 720	VESA CVT	59.855	44.772
6	1280 x 768	VESA CVV	60.000	47.700

\* Recommended Resolution



### No Power

- Check the TV power cord. Disconnect the power cord from the power outlet for 10 seconds, then reinsert the plug into the outlet. Press POWER to turn on the TV again.
- Make sure the outlet is not on a wall switch.
- Make sure a fuse has not blown at the power outlet.

### No Picture

- Check the antenna or Cable TV connections. Connect the antenna or Cable TV signal securely to the TV's 75Ω jack on the rear of the TV.
- Set TUNER MODE correctly. Details are on page 18.
- Activate AUTO PROGRAM to find all available channels. Details are on page 19.
- In case you hear only sound and don't see any picture in S-Video or Video (CVBS) mode. Please check if you have connected Video signal to S-Video or Video (CVBS) input. Only one of the two video inputs can be connected to sound. This means that the same sound can be heard in S-Video and Video (CVBS) mode.

### No Sound

- Press the VOL+ and VOL- buttons to adjust the volume.
- Press the MUTE button on the remote control to cancel or restore the volume.
- If you have connected other equipment to the TV (such as a VCR or DVD Player), make sure the audio cables are connected securely between the TV and the other equipment.
- Check the SOUND settings. Details are on page 22 or 24.
- In case you hear wrong sound in S-Video or Video (CVBS) mode. Please check if you have connected the right sound signal to AV in (S-Video or Video input). Only one of the two video inputs can be connected to sound, but both video signals can be connected. This means that only one of the two sound inputs can be heard in S-Video and Video (CVBS) mode.

### Remote Control does not work.

- Check the batteries. If necessary, replace them with two AAA heavy duty (zinc chloride) or alkaline batteries.
- Clean the remote control as well as the remote control sensor on the front of the TV.
- Check the TV power cord. Disconnect the power cord from the power outlet for 10 seconds, then reinsert the plug into the outlet. Press POWER to turn on the TV again.
- Make sure the outlet is not on a wall switch.
- Make sure a fuse has not blown at the power outlet.
- Always point the remote control toward the front of the TV (toward the remote sensor).
- Make sure that you use the supplied Magnavox Remote control, only the supplied Magnavox Remote control can be used with this LCD-TV set.

### TV displays wrong channel or no channels.

- Repeat channel selection.
- Add the channel number(s) into the TV's memory. Use STORE. Details are on page 20.
- Make sure TUNER MODE is set correctly. Details are on page 18.  
Then activate AUTO PROGRAM to set up all available channels. Details are on page 19.

### Poor Sound

- Check if AVL (audio settings menu) is switched on [yes].
- Select personal smart sound mode and optimize in the Audio onscreen menu the treble and bass settings.
- Make sure that your external device, for instance VCR, DVD or other AV device has a good quality sound output.

### Noisy Picture

- Select the Weak signal Smart Picture Mode, in this mode noise from bad quality video signals will be suppressed.

**WARNING** concerning stationary images on the TV

Screen: Do not leave fixed images on the screen for extended periods of time. This can cause uneven aging of the LCD panel.

Normal use of the TV should involve viewing of programs that have constantly moving or changing images. Do not leave nonmoving images on screen for extended periods of time. Do not display the same images too frequently; if you do, subtle “ghost” images can be left on the LCD screen. Sources of stationary images may be Laser discs, video games, Compact Discs Interactive (CD-i), or paused Digital Video Discs (DVDs) or video tapes.

Here are some common examples of stationary images:

- DVD menus list DVD content.
- Letterbox black bars appear at the top and bottom of the TV screen when a wide screen (16:9) movie is viewed on a TV with standard (4:3) aspect ratio. This is available with some DVDs.
- Video game images and scoreboards
- Television station logos cause a problem if they are bright and stationary. Moving or low-contrast graphics are less likely to damage the picture tube.
- Stock market tickers may appear at the bottom of the TV screen if the TV programming covers this news.
- Shopping channel logos, pricing displays may be bright and may appear constantly during the show. These are usually in the same location on the TV screen.

**TV Location**

- To avoid cabinet warping, cabinet color changes, and an increased chance of TV failure, do not place the TV where temperatures can become excessively hot (for example, in direct sunlight or near a heating appliance).
- Allow a free flow of air around the TV.

**Cleaning**

- To avoid possible shock hazard, remove the TV’s power cord from the electrical outlet before cleaning.
- Regularly dust the TV with a dry, non-scratching duster.
- When cleaning the TV, take care not to scratch or damage the screen surface. Avoid wearing jewelry or using anything abrasive. Do not use household cleaners. Wipe the screen with a clean cloth dampened with water. Use even, easy, vertical strokes when cleaning.
- Occasionally vacuum the vents on the rear of the TV.
- Never use thinners, insecticide sprays, or other chemicals on or near the cabinet. They may blemish the cabinet permanently.





## A

Antena Connection.....	9
Auto Program.....	4.19

## B

Balance.....	4.24.33
Bass.....	4.24.33
Batteries.....	6
Brightness.....	23.32

## C

Cable Box Connections.....	10
Cable TV Connection.....	9
Care and Cleaning.....	37
Channel Edit.....	20
Closed Captions.....	31
Color.....	23

## F

Factory Service.....	41.42
Factory Service Information.....	41
Factory reset .....	21

## I

Index.....	38
------------	----

## L

Language.....	4.17
Limited Warranty.....	42

## M

Mono.....	8.24.33
-----------	---------

## P

PC (Monitor) Connection.....	15
------------------------------	----

## R

Regulatory.....	39. 40
-----------------	--------

## S

Sound.....	4.8.22.24.33.36
Stereo.....	4.8.10.24.33

## T

Tint.....	23
Treble.....	4.24.33
Troubleshooting.....	33

## W

Warranty.....	1.2.42
Welcome.....	4



**FEDERAL COMMUNICATIONS COMMISSION (FCC) NOTICE (U.S. ONLY)**

	<p>This equipment has been tested and found to comply with the limits for a Class B digital device, pursuant to Part 15 of the FCC Rules. These limits are designed to provide reasonable protection against harmful interference in a residential installation. This equipment generates, uses and can radiate radio frequency energy and, if not installed and used in accordance with the instructions, may cause harmful interference to radio communications. However, there is no guarantee that interference will not occur in a particular installation. If this equipment does cause harmful interference to radio or television reception, which can be determined by turning the equipment off and on, the user is encouraged to try to correct the interference by one or more of the following measures:</p>
--	---

- Reorient or relocate the receiving antenna.
- Increase the separation between the equipment and receiver.
- Connect the equipment into an outlet on a circuit different from that to which the receiver is connected.
- Consult the dealer or an experienced radio/TV technician for help.

	<p>Changes or modifications not expressly approved by the party responsible for compliance could void the user's authority to operate the equipment.</p>
--	--

Use only RF shielded cable with ferrite core when connecting this monitor to a computer device.

- RF shield cable with ferrite core can be obtain from multiple retail outlets or Philips Factory Service Center.
- The RF shield cable with ferrite core part number is 3138 198 71441.
- If your RF shield cable without ferrite core, you can obtain the ferrite core from Philips Factory Service Center, installation as following.

1. Open the ferrite core.
2. Locate the video connector that goes to the computer and plugs into the unit. Place the ferrite core as close to the video connector as possible, as shown in the figure below.

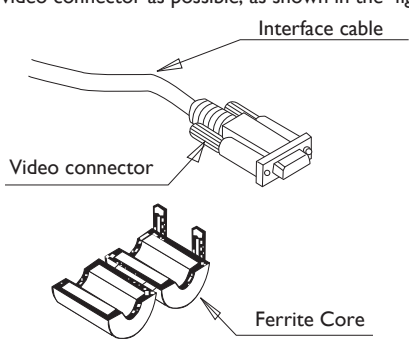

3. Lock the ferrite core.
4. Place two cable tie wrap on either side of the ferrite core to prevent it from sliding down the cable, as shown in the figure below.

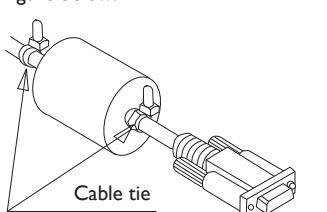

5. Draw the tie wraps tight and cut off the excess leads.

### Ferrite Core Installation

---

To ensure compliance of this unit to the Class B limits of the FCC Rules, Part 15, Subpart B.

---

This kit must be utilized when "non-ferrited" video cables are used with this unit. This instruction sheet gives the details for proper installation.

Additional FCC information may be found in the radio frequency interference statement located in the user's manual.

To prevent damage which may result in fire or shock hazard, do not expose this appliance to rain or excessive moisture.  
**THIS CLASS B DIGITAL APPARATUS MEETS ALL REQUIREMENTS OF THE CANADIAN INTERFERENCE-CAUSING EQUIPMENT REGULATIONS.**



## COMMISSION FEDERALE DE LA COMMUNICATION (FCC DECLARATION)



Cet équipement a été testé et déclaré conforme aux limites des appareils numériques de class B, aux termes de l'article 15 Des règles de la FCC. Ces limites sont conçues de façon à fournir une protection raisonnable contre les interférences nuisibles dans le cadre d'une installation résidentielle. CET appareil produit, utilise et peut émettre des hyperfréquences qui, si l'appareil n'est pas installé et utilisé selon les consignes données, peuvent causer des interférences nuisibles aux communications radio. Cependant, rien ne peut garantir l'absence d'interférences dans le cadre d'une installation particulière. Si cet appareil est la cause d'interférences nuisibles pour la réception des signaux de radio ou de télévision, ce qui peut être décelé en fermant l'équipement, puis en le remettant en fonction, l'utilisateur pourrait essayer de corriger la situation en prenant les mesures suivantes:

- Réorienter ou déplacer l'antenne de réception.
- Augmenter la distance entre l'équipement et le récepteur.
- Brancher l'équipement sur un autre circuit que celui utilisé par le récepteur.
- Demander l'aide du marchand ou d'un technicien chevronné en radio/télévision.



Toutes modifications n'ayant pas reçu l'approbation des services compétents en matière de conformité est susceptible d'interdire à l'utilisateur l'usage du présent équipement.

N'utiliser que des câbles RF blindés avec ame en ferrite pour les connections avec des ordinateurs ou périphériques.

- Vous pouvez vous procurer le câble de blindage RF avec tore magnétique dans les différents magasins de détails ou au centre de service d'usine Phillips.
- Le numéro de pièce du câble de blindage RF avec tore magnétique est 3138 198 71441.
- Si votre câble de blindage RF ne possède pas de tore magnétique, vous pouvez l'obtenir auprès du centre de service d'usine Phillips. Suivez les instructions ci-dessous pour l'installation.

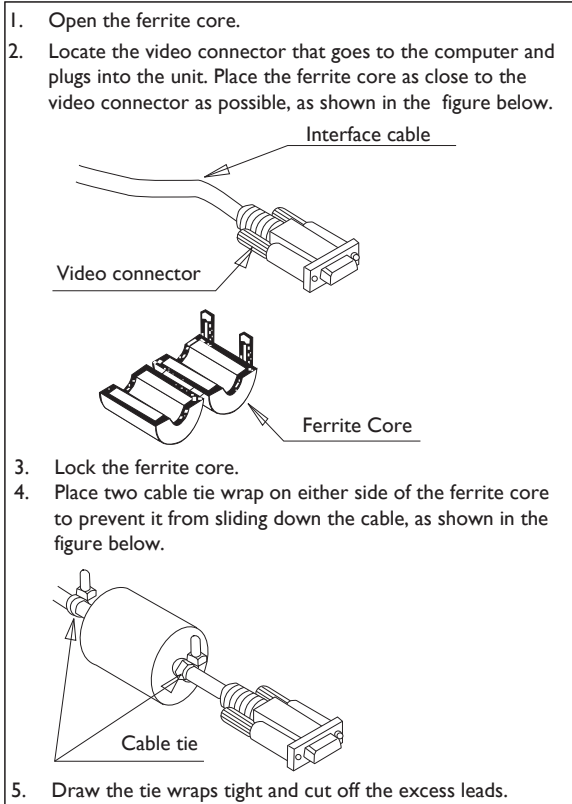

### Ferrite Core Installation

To ensure compliance of this unit to the Class B limits of the FCC Rules, Part 15, Subpart B.

This kit must be utilized when "non-ferrited" video cables are used with this unit. This instruction sheet gives the details for proper installation.

Additional FCC information may be found in the radio frequency interference statement located in the user's manual.

CET APPAREIL NUMERIQUE DE LA CLASSE B RESPECTE TOUTES LES EXIGENCES DU REGLEMENT SUR LE MATERIEL BROUILLEUR DU CANADA.

# MAGNAVOX LIMITED WARRANTY

## Ninety (90) Days Labor & One (1) Year Parts & One (1) Year Display

**MAGNAVOX** warrants this product against defect in material or workmanship, subject to any conditions set forth as follows:

### PROOF OF PURCHASE:

You must have proof of the date of purchase to receive warranted repair on the product. A sales receipt or other document showing the product and the date that you purchased the product as well as the authorized retailer included, is considered such proof.

### COVERAGE:

(If this product is determined to be defective)

**LABOR:** For a period of ninety (90) days from the date of purchase, Magnavox will repair or replace the product, at its option, at no charge, or pay the labor charges to any Magnavox authorized service center. After the period of ninety (90) days, Magnavox will no longer be responsible for charges incurred.

**PARTS:** For a period of one (1) year, Magnavox will supply, at no charge, new or rebuilt replacement parts in exchange for defective parts. Magnavox authorized service centers will provide removal and installation of the parts under the specified labor warranty.

**DISPLAY:** For a period of one (1) year from the date of purchase, Magnavox will supply, at no charge, a new or rebuilt active display device in exchange for the defective display. Magnavox authorized service centers will provide removal and installation of the parts under the specified labor warranty. (PTV screens carry a thirty (30) day replacement warranty.)

### EXCLUDED FROM WARRANTY COVERAGE

Your warranty does not cover:

- Labor charges for installation or setup of the product, adjustment of customer controls on the product, and installation or repair of antenna systems outside of the product.
- Product repair and/or part replacement because of improper installation, connections to improper voltage supply, abuse, neglect, misuse, accident, unauthorized repair or other cause not within the control of Magnavox.
- A product that requires modification or adaptation to enable it to operate in any country other than the country for which it was designed, manufactured, approved and/or authorized, or repair of products damaged by these modifications.
- Damage occurring to product during shipping when improperly packaged or cost of associated packaging.
- Product lost in shipment and no signature verification of receipt can be provided.
- A product used for commercial or institutional purposes (including but not limited to rental purposes).
- Products sold AS IS or RENEWED.

### TO OBTAIN WARRANTY SERVICE IN THE U.S.A., PUERTO RICO, OR U.S. VIRGIN ISLANDS...

Contact Magnavox Customer Care Center at:  
1-800-705-2000

### TO OBTAIN WARRANTY SERVICE IN CANADA...

1-800-661-6162 (French Speaking)  
1-800-705-2000 (English or Spanish Speaking)

REPAIR OR REPLACEMENT AS PROVIDED UNDER THIS WARRANTY IS THE EXCLUSIVE REMEDY FOR THE CONSUMER. MAGNAVOX SHALL NOT BE LIABLE FOR ANY INCIDENTAL OR CONSEQUENTIAL DAMAGES FOR BREACH OF ANY EXPRESS OR IMPLIED WARRANTY ON THIS PRODUCT. EXCEPT TO THE EXTENT PROHIBITED BY APPLICABLE LAW, ANY IMPLIED WARRANTY OF MERCHANTABILITY OR FITNESS FOR A PARTICULAR PURPOSE ON THIS PRODUCT IS LIMITED IN DURATION TO THE DURATION OF THIS WARRANTY.

Some states do not allow the exclusions or limitation of incidental or consequential damages, or allow limitations on how long an implied warranty lasts, so the above limitations or exclusions may not apply to you. In addition, if you enter into a service contract agreement with the MAGNAVOX partnership within ninety (90) days of the date of sale, the limitation on how long an implied warranty lasts does not apply.

*This warranty gives you specific legal rights. You may have other rights which vary from state/province to state/province.*

**Magnavox, P.O. Box 671539, Marietta, GA. 30006-0026**

(Warranty: 4835 710 28125)

## Free Manuals Download Website

<http://myh66.com>

<http://usermanuals.us>

<http://www.somanuals.com>

<http://www.4manuals.cc>

<http://www.manual-lib.com>

<http://www.404manual.com>

<http://www.luxmanual.com>

<http://aubethermostatmanual.com>

Golf course search by state

<http://golfingnear.com>

Email search by domain

<http://emailbydomain.com>

Auto manuals search

<http://auto.somanuals.com>

TV manuals search

<http://tv.somanuals.com>