

37MF337B/37MF437B 42MF337B/42MF437B LCD TV



Thank you for choosing
Magnavox.

Need help fast?

Read your Quick Start Guide and/or
User Manual first for quick tips
that make using your Magnavox product
more enjoyable.

If you have read your instructions
and still need assistance,
you may access our online help at
www.magnavox.com/usasupport
or call
1-800-705-2000
while with your product
(and Model / Serial number)



Magnavox vous remercie de
votre confiance.

Besoin d'une aide rapide?

Le Guide rapide de début et
Manuel de l'utilisateur regorgent
d'astuces destinées à simplifier
l'utilisation de votre produit Magnavox.

Toutefois, si vous ne parvenez
pas à résoudre votre problème,
vous pouvez accéder à
notre aide en ligne à l'adresse
www.magnavox.com/usasupport
ou formez le
1-800-705-2000
Veillez à avoir votre produit à
portée de main
(et model / serial nombre)



Gracias por escoger Magnavox.

Necesita ayuda inmediata?

Lea primero la Guía rápida del
comienzo o el Manual del usuario,
en donde encontrará consejos que
le ayudarán a disfrutar plenamente
de su producto Magnavox.

Si después de leerlo aún necesita ayuda,
consulte nuestro servicio de
asistencia en línea en
www.magnavox.com/usasupport
o llame al teléfono
1-800-705-2000
y tenga a mano el producto
(y número de model / serial)

Quick Use Guide Inside!
Guide d'usage Rapide Incluse!
Guía de Uso Rápido Incluida!

For Customer Use / À l'usage du client /
Para Uso del Cliente

Model/Modle/ModeloNo. : _____

Serial/Srie/Serie No. : _____

English

Español

How to make the optimal connection

(Need a Cable? Philips has them at: www.shopping.philips.com/cables)

Comment réaliser une bonne connexion

(Besoin d'un câble ? Philips vous en propose à l'adresse suivante : www.shopping.philips.com/cables)

Cómo realizar la mejor conexión

(¿Necesita un cable? Philips lo tiene en: www.shopping.philips.com/cables)

	<p>Best HDMI High-Definition Multimedia Interface provides an uncompressed, all-digital audio/video connection. HDMI provides the ultimate connection (Please use a certified HDMI cable.)</p>	<p>Supérieure HDMI l'interface HDMI (High-Definition Multimedia Interface) Propose une connexion décompressée audio/ vidéo entièrement numérique. HDMI propose l'ultime connexion (Veuillez utiliser un câble HDMI certifié).</p>	<p>La mejor HDMI La interfaz multimedia de alta definición (HDMI, por sus siglas en inglés) proporciona una conexión de audio/video completamente digital sin comprimir. La HDMI proporciona la mejor conexión (Sirvase utilizar un cable HDMI certificado).</p>
	<p>Better Component Video input Provides superior picture quality by separating the green, blue and red luminance signals. Typically used with red/white audio cables.</p>	<p>Excellente Entrée vidéo composant Fournit une qualité d'image supérieure en séparant les signaux de luminance vert, bleu et rouge. Utilisée généralement avec les câbles audio rouge/blanc. Remarque: l'entrée vidéo composant apparaît sur le tableau de connexions comme YPbPr.</p>	<p>Mejor Entrada de video componente Proporciona calidad de imagen superior al separar las señales de luminancia verde, azul y roja. Se usa normalmente con cables de audio rojo/blanco. Nota: La entrada de video componente se muestra en el panel de conexión como YPbPr.</p>
	<p>Good S-Video Supplies a better picture than RF and Composite connections. Used with red/white audio cables.</p>	<p>Bonne S-Vidéo Fournit une meilleure image que les connexions RF et composite. Utilisée avec les câbles audio rouge/blanc.</p>	<p>Buena S-Video Brinda una mejor imagen que las conexiones RF y compuestas. Se usa con cables de audio rojo/blanco.</p>
	<p>Basic Composite Audio/Video Separate video (yellow) and audio (red/white) cables that provide a basic connection from the cable box and other devices. Note: The color of audio inputs may differ, e.g. red/white or red/black.</p>	<p>De base Audio/Vidéo Composite Câbles vidéo (jaune) et audio (rouge/blanc) séparés fournissant une connexion de base à partir du boîtier de connexion et autres dispositifs. Remarque: La couleur des entrées audio peut varier, par ex. rouge/blanc ou rouge/noir.</p>	<p>Básica Audio/Video Compuesto Cables de video (amarillo) y audio (rojo/blanco), que proporcionan una conexión básica de la caja de cable y otros dispositivos. Nota: El color de las entradas de audio puede diferir, por ej., rojo/blanco o rojo/negro.</p>
	<p>RF Provides a basic connection for antenna or cable. Provides both audio and video.</p>	<p>RF Fournit une connexion de base pour l'antenne ou le service et la vidéo.</p>	<p>RF Proporciona una conexión de antena o cable básica. Suministra audio y video.</p>

37"

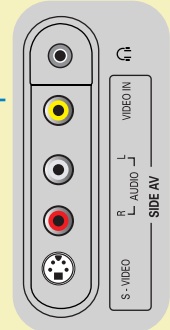
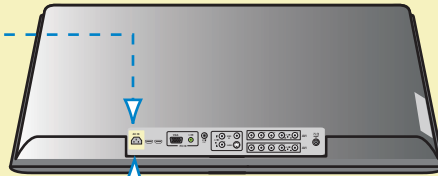
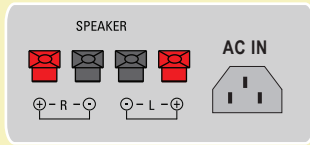

42"

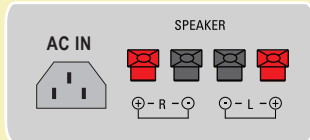

37MF337B / 37MF437B
42MF337B / 42MF437B

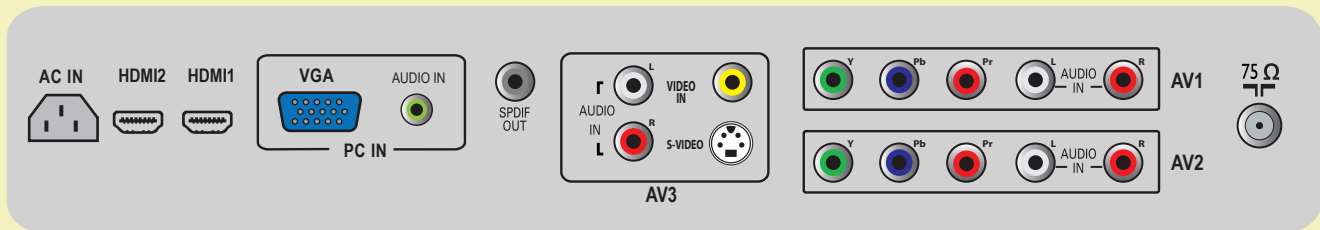

AC In
HDMI 1, HDMI 2
PC -VGA, Audio
SPDIF output (Digital Only)
AV3 - Composite Video, (Video In)
S-Video, Audio L/R input
AV2 - Component Video (YPbPr),
Audio L/R input
AV1 - Component Video (YPbPr),
Audio L/R input
75 Ω / RF
Side AV -
Earphone,
Composite Video, (Video In)
Audio L/R input
S-Video

Entrée CA
HDMI 1, HDMI 2
Ordinateur - VGA, Audio
Sortie SPDIF (numérique seulement)
AV3 - Vidéo composite (entrée Vidéo)
S-vidéo, entrée audio G/D
AV2 - Vidéo composante (YPbPr),
Entrée audio G/D
AV1 - Vidéo composante (YPbPr),
Entrée audio G/D
75 Ω / RF
Side AV -
Écouteurs,
Vidéo composite (entrée Vidéo)
Entrée audio G/D
S-vidéo

Entrada CA
HDMI 1, HDMI 2
PC -VGA, Audio
Salida SPDIF (Digital Solamente)
AV3 - Video Compuesto, (Video In)
S-Video, Entrada de Audio Izq./Der.
AV2 - Video por Componente (YPbPr),
Entrada de Audio Izq./Der.
AV1 - Video por Componente (YPbPr),
Entrada de Audio Izq./Der.
75 Ω / RF
Side AV -
Audifono,
Video Compuesto, (Video In)
Entrada de Audio Izq./Der.
S-Video

1

Set-Top Box to TV
Boîtier de décodage vers téléviseur
De la caja superior o caja de cable al TV

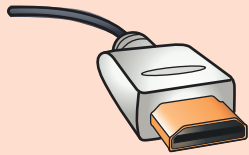

HDMI

OR/OU/O

RF

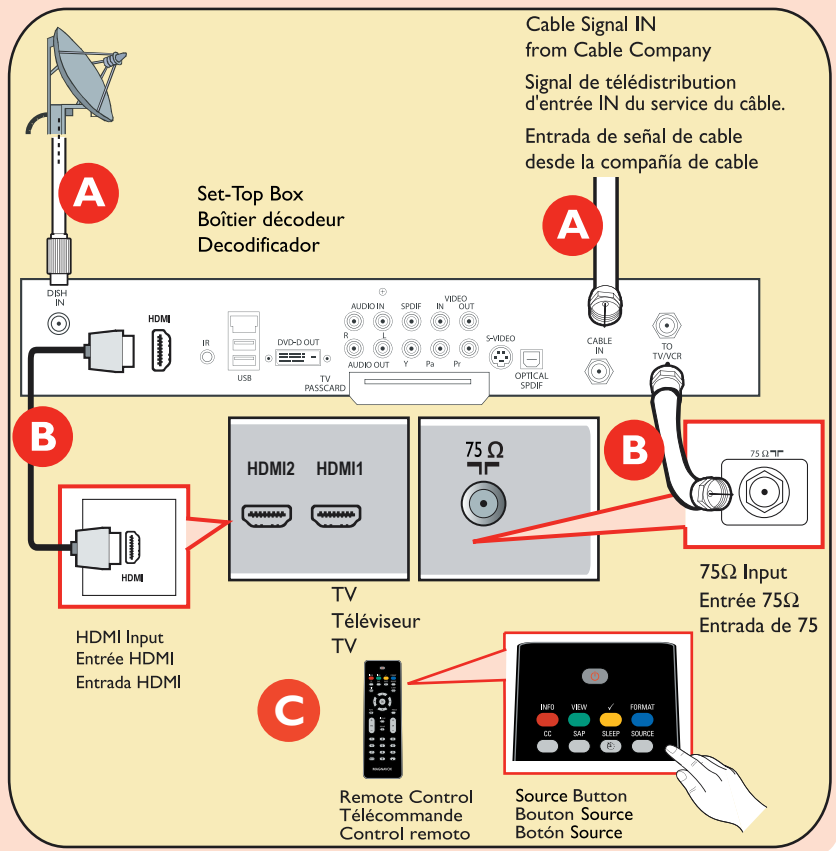
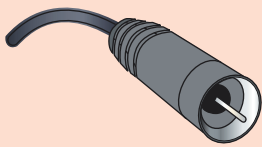

2

DVD Player/Recorder to TV
Lecteur DVD/Enregistreur
DVD vers téléviseur
Del reproductor o grabador
de DVD al TV

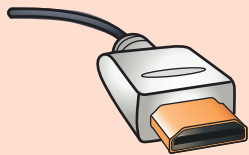

HDMI

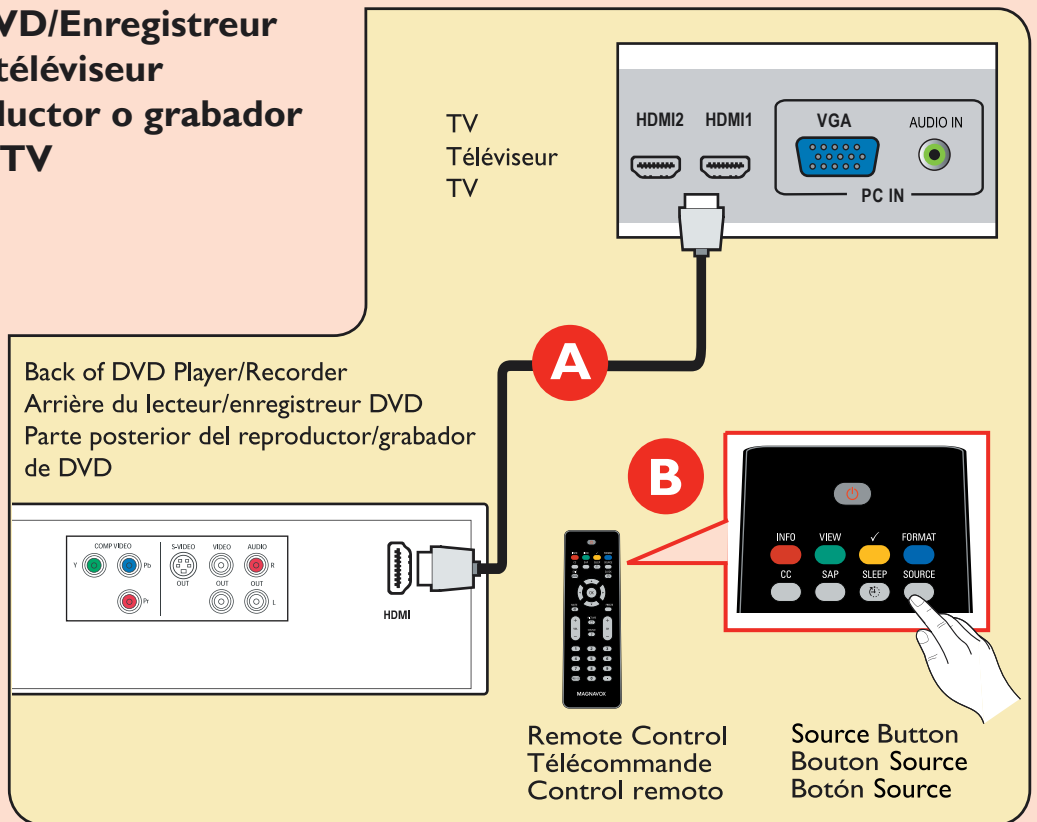

3

DVD Player or Recorder to TV
Lecteur DVD ou Enregistreur
vers téléviseur
Del reproductor o
grabador de DVD al TV

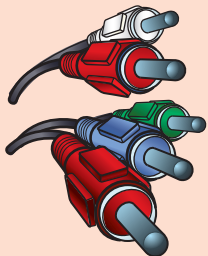

Component Video Input
 /Entrée vidéo composant
 /Entrada de video
 componente

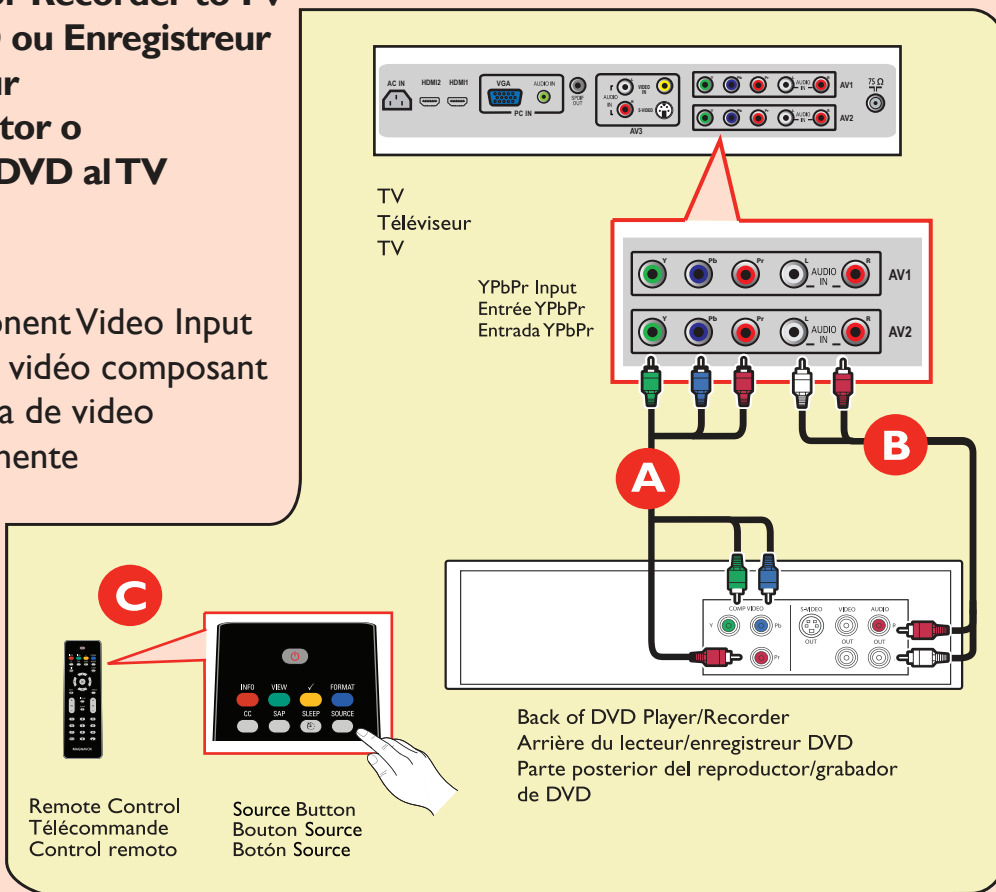

4

DVD Player/Recorder/VCR to TV
Lecteur DVD/Enregistreur
DVD/Magnétoscope vers
téléviseur
Del reproductor/grabador de
DVD/VCR al TV

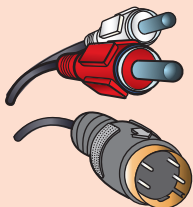

S-Video
 /S-Vidéo
 /S-Video

You can connect this input by AV3 or Side AV.
 Vous pouvez connecter cette entrée par AV3 ou AV latéral.
 Puede conectar esta entrada por medio del conector AV3
 o el conector lateral AV.

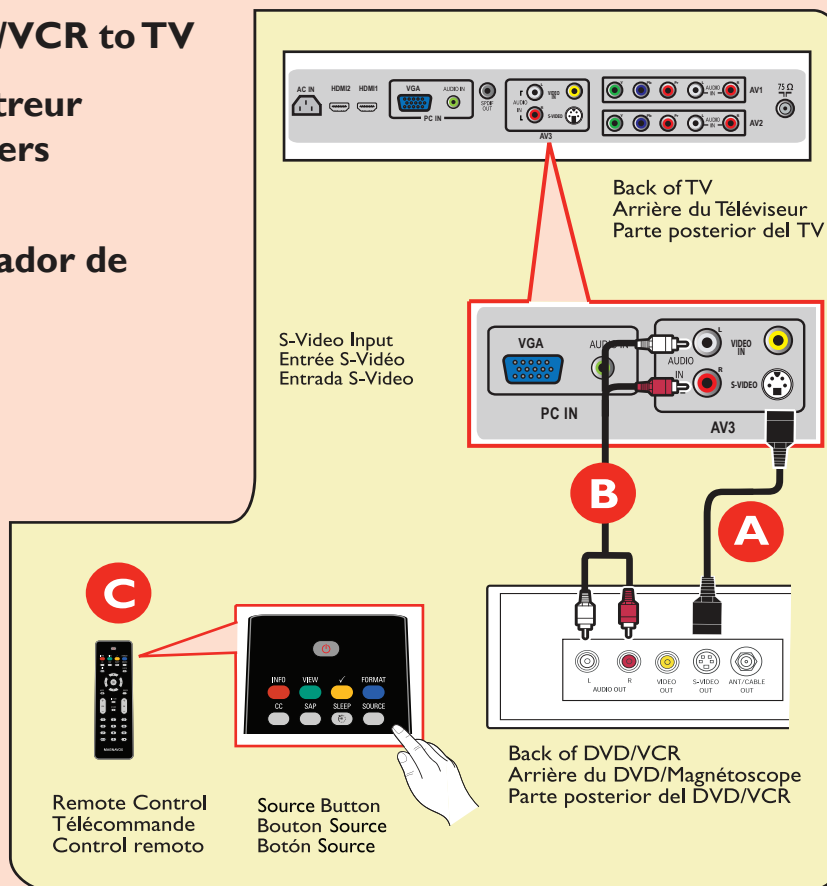

5

DVD Player/Recorder/VCR to TV
Lecteur DVD/Enregistreur DVD/Magnétoscope vers téléviseur
 Del reproductor/grabador de DVD/VCR al TV

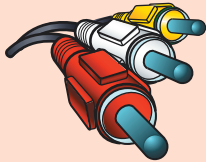

Composite Audio-video
 /Audio-Vidéo composite
 /Audio-Video compuesto

You can connect this input by AV3 or Side AV.
 Vous pouvez connecter cette entrée par AV3 ou AV latéral.
 Puede conectar esta entrada por medio del conector AV3 o el conector lateral AV.

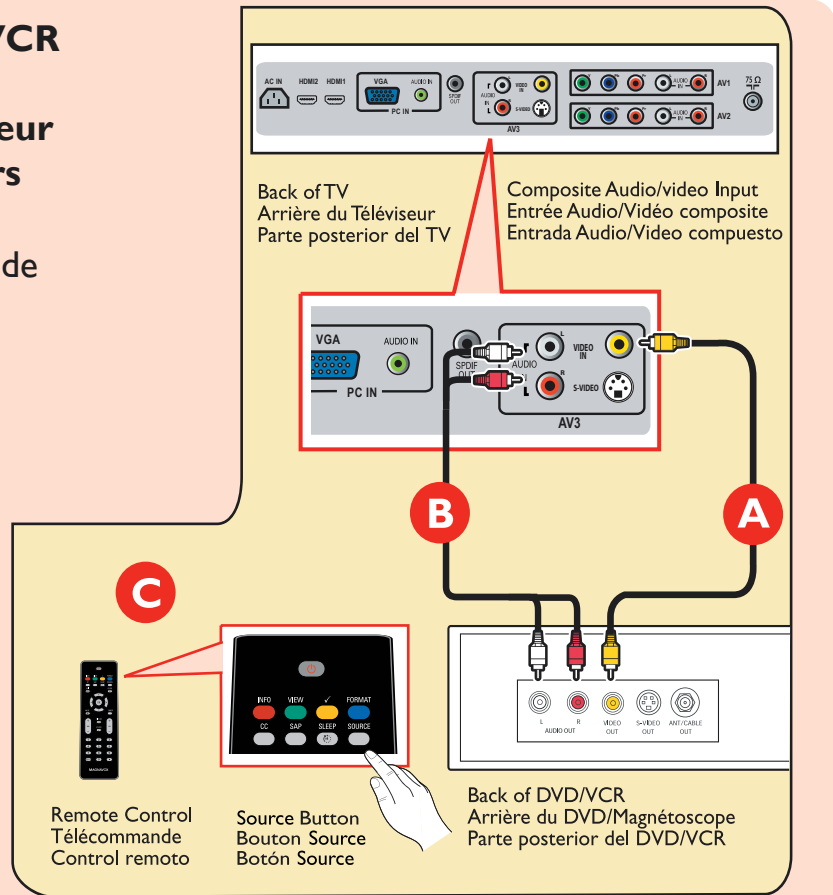

6

Video Camera /Games Console to TV
Caméra vidéo/Console de jeux vers téléviseur
 De la cámara de video/ Consola de juegos al TV

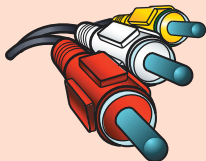

Composite Audio-video
 /Audio-Vidéo composite
 /Audio-Video compuesto

You can connect this input by AV3 or Side AV.
 Vous pouvez connecter cette entrée par AV3 ou AV latéral.
 Puede conectar esta entrada por medio del conector AV3 o el conector lateral AV.

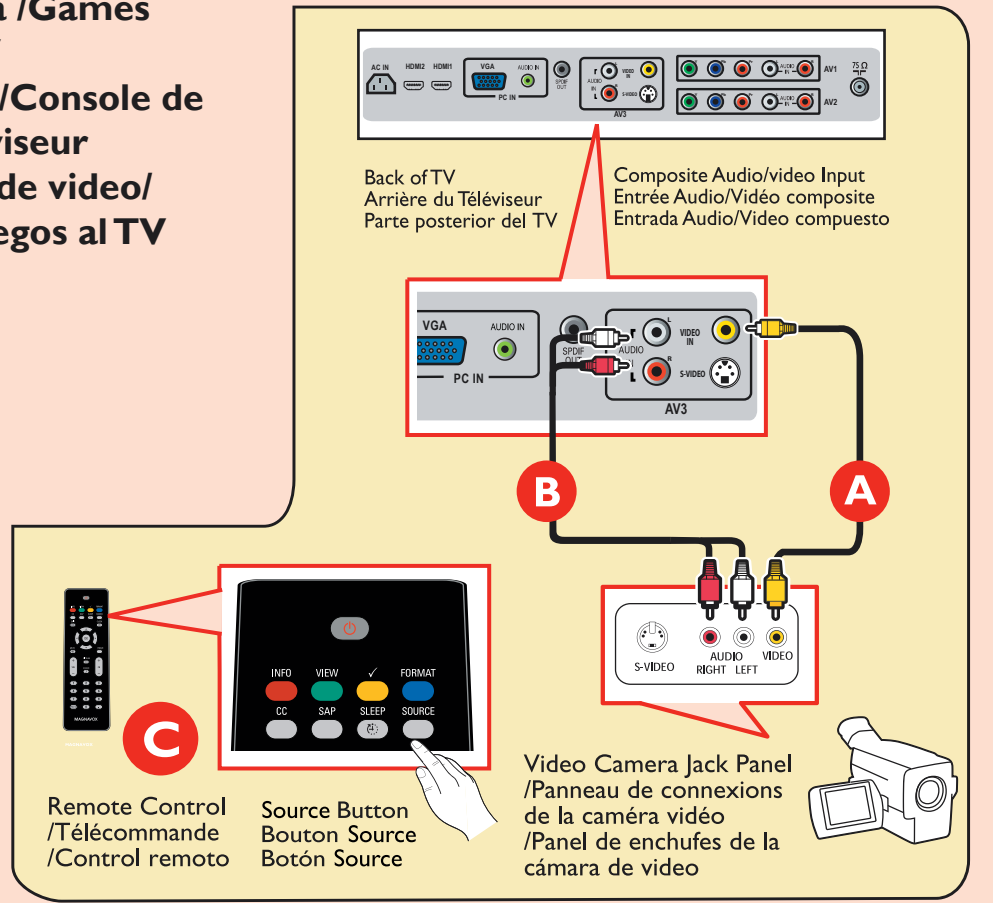

7 **Audio to Hi-fi System (Digital)**
Audio vers chaîne haute fidélité (Numérique)
Audio al sistema Hi-fi (Digital)

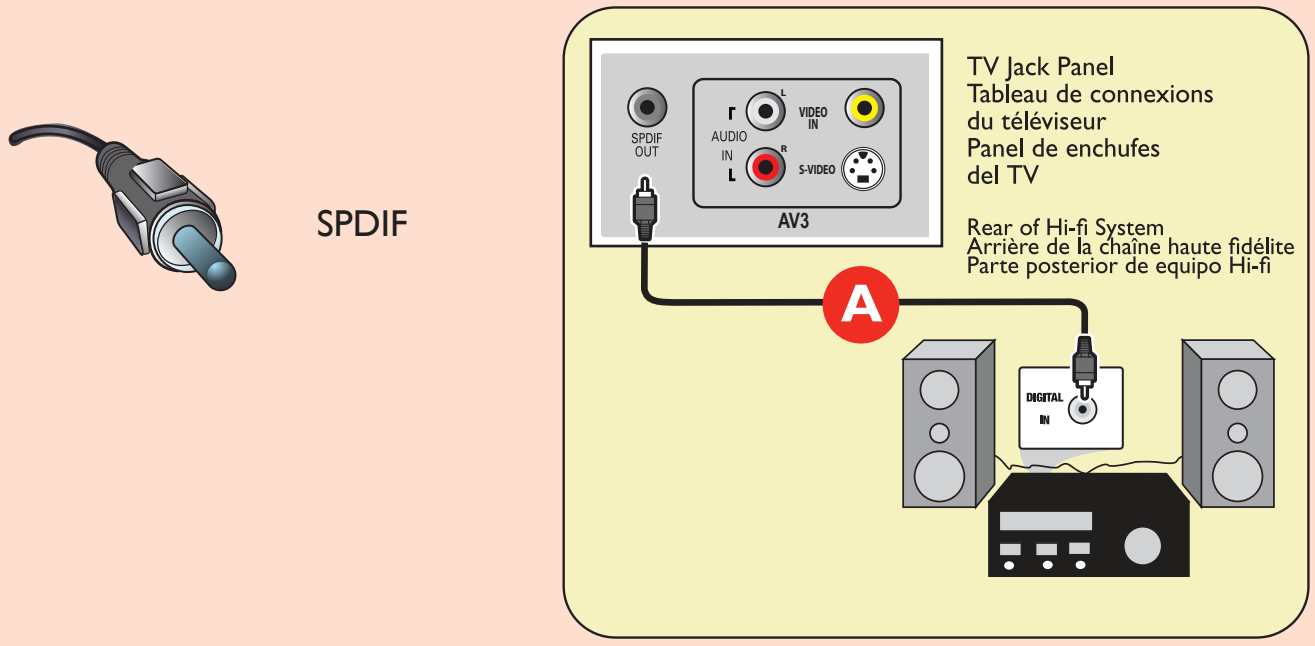

8
PC connects to TV (as PC monitor)
L'ordinateur se connecte sur un téléviseur
(en tant que moniteur d'ordinateur)
El computador (PC) se conecta al televisor
(como monitor del computador).

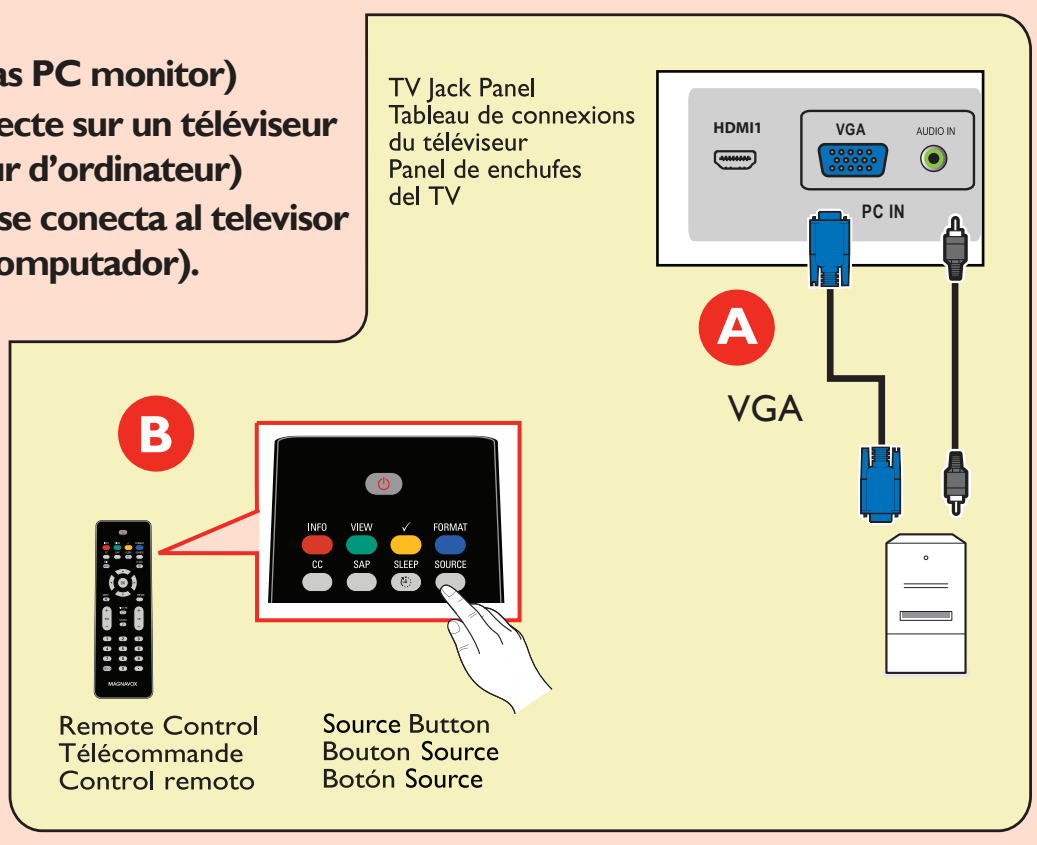

Return your Product Registration Card or register online at www.magnavox.com/usasupport today to get the very most from your purchase.

Registering your model with MAGNAVOX makes you eligible for all of the valuable benefits listed below, so don't miss out. Complete and return your Product Registration Card at once, or register online at www.magnavox.com/usasupport to ensure:

*Proof of Purchase

Returning the enclosed card guarantees that your date of purchase will be on file, so no additional paperwork will be required from you to obtain warranty service.

*Product Safety Notification

By registering your product, you'll receive notification directly from the manufacturer - in the rare case of a product recall or safety defect.

*Additional Benefits

Registering your product guarantees that you'll receive all of the privileges to which you're entitled, including special money-saving offers.

MAGNAVOX

Congratulations on your purchase, and welcome to the "family!"

Dear MAGNAVOX product owner:

Thank you for your confidence in MAGNAVOX. You've selected one of the best-built, best-backed products available today. We'll do everything in our power to keep you happy with your purchase for many years to come.

As a member of the MAGNAVOX "family," you're entitled to protection by one of the most comprehensive warranties and outstanding service networks in the industry. What's more, your purchase guarantees you'll receive all the information and special offers for which you qualify, plus easy access to accessories from our convenient home shopping network.

Most importantly, you can count on our uncompromising commitment to your total satisfaction.

All of this is our way of saying welcome - and thanks for investing in a MAGNAVOX product.

P.S. To get the most from your MAGNAVOX purchase, be sure to complete and return your Product Registration Card at once or register online at:

www.magnavox.com/usasupport

Know these **safety** symbols



 This "bolt of lightning" indicates uninsulated material within your unit may cause an electrical shock. For the safety of everyone in your household, please do not remove product covering.

 The "exclamation point" calls attention to features for which you should read the enclosed literature closely to prevent operating and maintenance problems.

WARNING: To reduce the risk of fire or electric shock, this apparatus should not be exposed to rain or moisture and objects filled with liquids, such as vases, should not be placed on this apparatus.

CAUTION: To prevent electric shock, match wide blade of plug to wide slot, fully insert.

ATTENTION: Pour éviter les choc électriques, introduire la lame la plus large de la fiche dans la borne correspondante de la prise et pousser jusqu'au fond.

For Customer Use

Enter below the Serial No. which is located on the rear of the cabinet. Retain this information for future reference.

Model No. _____

Serial No. _____

IMPORTANT SAFETY INSTRUCTIONS

Read before operating equipment

1. Read these instructions.
2. Keep these instructions.
3. Heed all warnings.
4. Follow all instructions.
5. Do not use this apparatus near water.
6. Clean only with a dry cloth.
7. Do not block any of the ventilation openings.
Install in accordance with the manufacturers instructions.
8. Do not install near any heat sources such as radiators, heat registers, stoves, or other apparatus (including amplifiers) that produce heat.
9. Do not defeat the safety purpose of the polarized or grounding-type plug. A polarized plug has two blades with one wider than the other. A grounding type plug has two blades and third grounding prong. The wide blade or third prong are provided for your safety. When the provided plug does not fit into your outlet, consult an electrician for replacement of the obsolete outlet.
10. Protect the power cord from being walked on or pinched particularly at plugs, convenience receptacles, and the point where they exit from the apparatus.
11. Only use attachments/accessories specified by the manufacturer.
12.  Use only with a cart, stand, tripod, bracket, or table specified by the manufacturer, or sold with the apparatus. When a cart is used, use caution when moving the cart/apparatus combination to avoid injury from tip-over.
13. Unplug this apparatus during lightning storms or when unused for long periods of time.
14. Refer all servicing to qualified service personnel. Servicing is required when the apparatus has been damaged in any way, such as power-supply cord or plug is damaged, liquid has been spilled or objects have fallen into apparatus, the apparatus has been exposed to rain or moisture, does not operate normally, or has been dropped.
15. **Damage Requiring Service** - The appliance should be serviced by qualified service personnel when:
 - A. The power supply cord or the plug has been damaged;
 - B. Objects have fallen, or liquid has been spilled into the appliance;
 - C. The appliance has been exposed to rain
 - D. The appliance does not appear to operate normally or exhibits a marked change in performance;
 - E. The appliance has been dropped, or the enclosure damaged.
16. **Tilt/Stability** - All televisions must comply with recommended international global safety standards for tilt and stability properties of its cabinet design.
 - Do not compromise these design standards by applying excessive pull force to the front, or top, of the cabinet which could ultimately overturn the product.
 - Also, do not endanger yourself, or children, by placing electronic equipment/toys on the top of the cabinet. Such items could unsuspectingly fall from the top of the set and cause product damage and/or personal injury.
17. **Wall or Ceiling Mounting** - The appliance should be mounted to a wall or ceiling only as recommended by the manufacturer.
18. **Power Lines** - An outdoor antenna should be located away from power lines.
19. **Outdoor Antenna Grounding** - If an outside antenna is connected to the receiver, be sure the antenna system is grounded so as to provide some protection against voltage surges and built up static charges. Section 810 of the National Electric Code, ANSI/NFPA No. 70-1984, provides information with respect to proper grounding of the mast and supporting structure, grounding of the lead-in wire to an antenna discharge unit, size of grounding connectors, location of antenna-discharge unit, connection to grounding electrodes, and requirements for the grounding electrode. See Figure below.
20. **Object and Liquid Entry** - Care should be taken so that objects do not fall and liquids are not spilled into the enclosure through openings.
21. **Battery Usage CAUTION** - To prevent battery leakage that may result in bodily injury, property damage, or damage to the unit:
 - Install all batteries correctly, with + and - aligned as marked on the unit.
 - Do not mix batteries (old and new or carbon and alkaline, etc.).
 - Remove batteries when the unit is not used for a long time.

Note to the CATV system installer: This reminder is provided to call the CATV system installer's attention to Article 820-40 of the NEC that provides guidelines for proper grounding and, in particular, specifies that the cable ground shall be connected to the grounding system of the building, as close to the point of cable entry as practical.

Example of Antenna Grounding as per NEC - National Electric Code

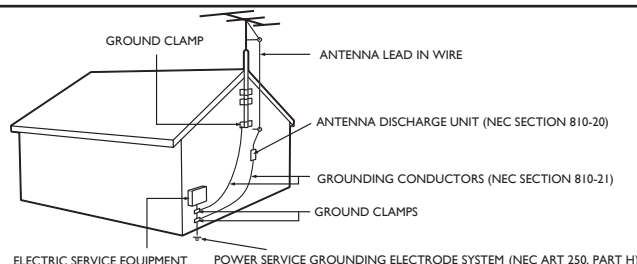

Precaution

ADDITIONAL SAFETY PRECAUTIONS

- ENSURE that LCD TV stand is tightened properly to the set on the right way of tightening of the screw of the stand to the set. Improper tightening of screw may render the set unsafe.
- If LCD TV is installed on the wall, installation should be carried out by qualified servicemen. Improper or incorrect installation may render the set unsafe.
- Disconnect main plug when :
 - cleaning the TV screen, never use abrasive cleaning agents.
 - there is a lightning storm.
 - the set is left unattended for a prolonged period of time.
- Do not shift or move the LCD TV around when it is powered on.
- Do not touch, push or rub the surface of the LCD screen with any sharp or hard objects.
- When the surface of the LCD screen becomes dusty, wipe it gently with an absorbent cotton cloth or other soft material like chamois. DO NOT USE acetone, toluene or alcohol to clean the surface of the screen. These chemicals will cause damage to the surface.
- Wipe off water or saliva as soon as possible. These liquids can cause deformation and color fading of the LCD screen when left exposed for some time.
- Be careful of condensation when temperature changes occur. Condensation can cause damage to the LCD screen and electrically parts. After condensation fades, spots or blemishes will be present on the LCD screen.

POSITIONING THE LCD TELEVISION

- Place the LCD TV on a solid, sturdy base or stand. Be sure the stand is strong enough to handle the weight of the LCD TV.
- Try to leave at least 6" of space around each side of the LCD TV cabinet to allow for proper ventilation.
- Do not place the LCD TV near a radiator or other sources of heat.
- Do not place the LCD TV where it can be exposed to rain or excessive moisture.

RECYCLING PROCEDURE/END OF LIFE DISPOSAL

- To minimize harm to the environment, the batteries supplied with the LCD TV do not contain mercury or nickel cadmium. If possible, when disposing of batteries, use recycling means available in your area.
- The LCD TV uses materials that can be recycled. To minimize the amount of waste in the environment, check your area for companies that will recover used televisions for dismantling and collection of reusable materials, or contact your dealer for TV recycling tips.
- Please dispose of the carton and packing material through the proper waste disposal management in your area.

This product contains mercury - (Hg) and must be recycled or disposed of according to local, state or federal laws. As this material maybe regulated due to environmental considerations, please contact you local authorities or the Electronic Industries Alliance: www.eiae.org.

Contents

Help

If this User Manual does not provide an answer or if the “Trouble Shooting Tips” do not solve your TV problem, you can call the Magnavox Customer Care Center at 1 800 705 2000.

Please have your model and serial number of your TV before making this call. You can find your TV’s model and serial number located on a sticker on the front of this User Manual or on the back side of the TV.

Model: 37MF337B, 37MF437B,
42MF337B, 42MF437B

Serial No: _____

Care of the screen See Tips, p. 32



End of life directives - Recycling

Magnavox has paid a lot of attention to producing an environmentally friendly product. Your new TV contains several materials that can be recycled for new uses. At the end of its life, specialized companies can dismantle and recycle this set. This will minimize the amount of materials being disposed of. Please be sure to dispose of this set in accordance with all state and local regulations. Like all LCD products, this set contains a lamp with Mercury, please dispose of according to all Local, State and Federal laws.



ENERGY STAR

As an ENERGY STAR® Partner, Magnavox has determined this product meets the ENERGY STAR® guidelines for energy efficiency. ENERGY STAR® is a U.S. registered mark. Using products with ENERGY STAR® label can save energy. Saving energy reduces air pollution and lowers utility bills.

Welcome/registration of your TV	1
IMPORTANT SAFETY INSTRUCTIONS	2
Precaution	3
Contents	4
Preparation	5
Wall mounting	5
Use of the remote control	8
Buttons on the top of the TV	10
To use the menus	11
How to navigate through the Settings menu	11
Introduction	11
TV menu	12
Installation	12
Select the menu language	12
Store TV channels	12
Weak channel installation	13
Source, Analog Audio In, Clock	14
Reset AV settings	15
Features menu	16
Picture menu	19
Sound menu	20
Parental Control menu	22
PC menu	26
Installation	26
Picture menu	27
Sound menu	28
Record with your recorder.	29
Record a TV program	29
To select connected devices	29
Trouble shooting tips	30
Glossary.	31
Care and cleaning	32
Regulatory	33
Specification	35
Limited warranty	36



Manufactured under license from Dolby Laboratories. ‘Dolby’ and the double-D symbol are trademarks of Dolby Laboratories.

Preparation

❶ Do not insert the power plug in a wall socket before all connections are made.

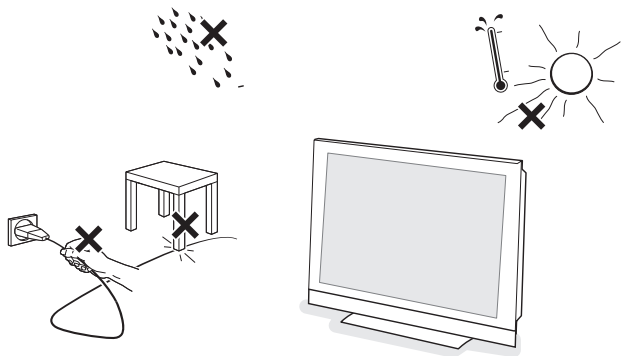

Place the TV on a solid surface.

For ventilation, leave at least 4" to 6" free all around the TV. Do not place the TV on a carpet. To prevent any unsafe situations, no naked flame sources, such as lighted candles, should be placed in the vicinity. Avoid heat, direct sunlight and exposure to rain or water. The equipment shall not be exposed to dripping or splashing.

Mounting the TV on the wall

This TV set complies with the VESA standard for wall mounting. Refer to specification page 35 for detail.

Caution: Installing the TV requires special skills that should only be performed by qualified personnel. You should not attempt to do the work yourself. Magnavox bears no responsibility for improper mounting or mounting that results in accident or injury.

Make sure that the wall mount is being fixed securely enough so that it meets safety standards.

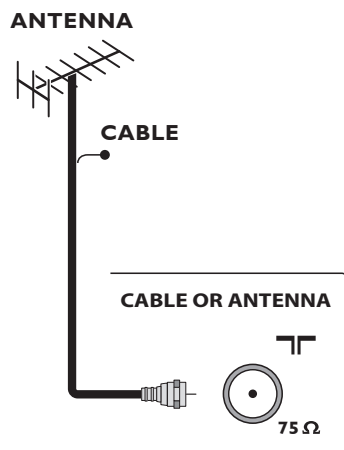

❷ Basic connections to the TV

Your integrated digital TV automatically decodes and displays the four basic DTV picture resolution standards.

- **SDTV** (Standard Definition TV) are broadcast as 480i (480-line interlaced) or 480p (480-line progressive scan) video.

- **HDTV** (High-Definition TV) are broadcast either in the 1080i or 720p formats, always with a widescreen picture.

Note: Progressive scan video (p) is more like what you see in a movie theater. Images are much more distinct, free of flicker and motion is smoother.

Your TV has an integrated HDTV tuner, which receives and decodes terrestrial ATSC and unscrambled cable (QAM) signals and displays them. There are two ways to obtain HDTV content:

- through a cable provider
- through an antenna.

Note: Use the illustrations on the left for cable or Antenna connections.

- Cable TV

Connect the cable TV signal to the **CABLE/ANTENNA 75 Ω** jack at the bottom of the TV. See page 12 for details on using Autoprogram to store channels in the TV's memory.

Note: This connection will supply stereo sound to the TV if the station you are viewing broadcasts stereo sound.

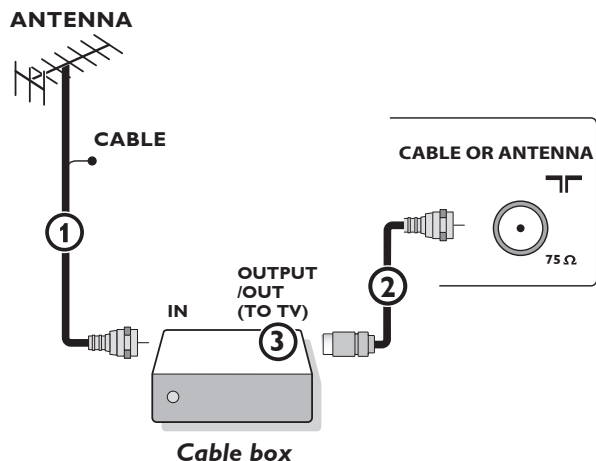

- Cable box with RF IN/OUT

- Connect the incoming cable TV signal to the cable **IN** jack ① on the back of the cable box.
- Connect a coaxial cable (not supplied) from the **TO TV** jack on the back of the cable box to the **CABLE/ANTENNA 75 Ω** jack ② at the bottom of the TV.
*Note: Your cable box may have a different label for the **TO TV** jack. Commonly used labels include **OUTPUT** or **OUT**.*
- Set the **OUTPUT CH** switch ③ on the cable box to **CH 3 or 4** (whichever is correct for your cable box), Next, tune the TV to the corresponding channel. Once tuned, change channels using the cable box, not the TV.

*Note: This connection will not supply stereo sound to the TV. The reason is that the RF output on a cable box - labeled **TO TV**, **OUT** or **OUTPUT** for example - will not send a stereo signal to the tuner (VHF/UHF) input on a TV.*

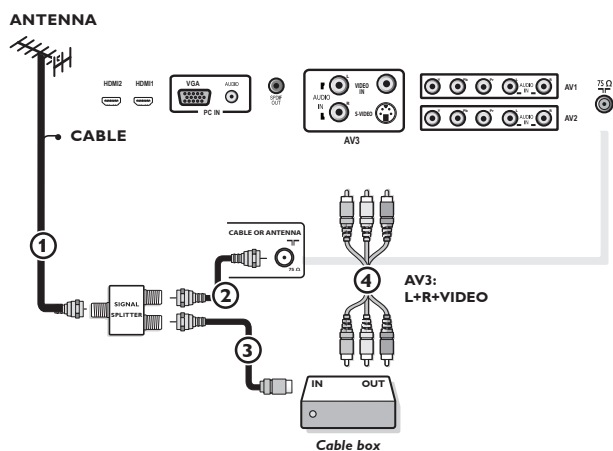

- Cable box with A/V outputs

- Connect the incoming cable TV signal ① to a signal splitter (not supplied). The signal splitter enables you to avoid having to use the TO TV jack on the back of the cable box. This jack will not supply stereo sound to the TV.
*Note: Your cable box may have a different label for the **TO TV** jack. Commonly used labels include **OUTPUT** or **OUT**.*
- Connect a coaxial cable (not supplied) to a connector on the signal splitter and to the **CABLE/ANTENNA 75 Ω** jack ② on the TV.
- Connect another coaxial cable (not supplied) to a connector on the signal splitter and to the cable **IN** jack ③ on the back of the cable box.
- Connect A/V cables (not supplied) to the **VIDEO IN** and **AUDIO L** and **R** outputs on the back of the cable box and to the **AV3** video (labeled **VIDEO IN**) and **AUDIO** (labeled **L** and **R**) jacks ④ on the back of the TV.
- To view programs from your cable box, first press the **SOURCE** button on the remote control.
- Press the cursor down or up buttons until the **AV3** signal source is selected.
- Press the **OK** button to confirm your selection. The **AV3** input source becomes current for the viewing of cable TV programs through your cable box.

Note: If your cable box audio/video outputs do not supply video and stereo audio to the TV, you will need to make the connection shown above in "Cable box with RF IN/OUT."

Watching cable TV programs that don't require the use of a cable box.

Since you've connected the cable TV signal directly to the TV's tuner, you can also watch unscrambled programs by simply tuning to the desired channel; however, you must first use Auto program to store available channels in the TV's memory. (p. 12)

Note: This connection will supply stereo sound to the TV if the station you are viewing broadcasts stereo sound.

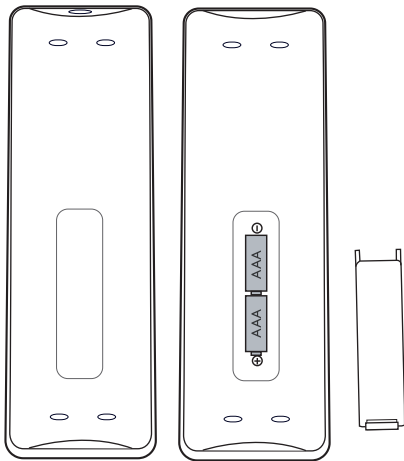
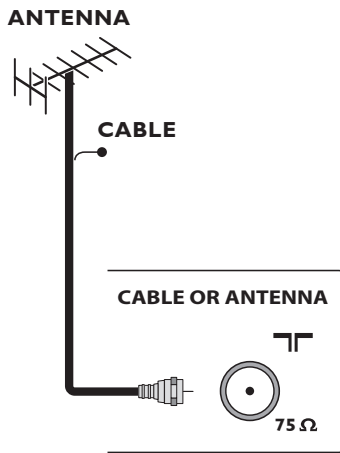

Note: The first time

(and only the first time) you turn on your set you see an installation introduction screen. The **installation procedure** consists of a series of screens that guide you through the process.

- ❶ After an introduction screen, you are asked to select a language of the TV's on-screen menus.
- ❷ Press the cursor up/down to highlight your language.
(The text of the header and the info on screen continuously change language.)
- ❸ Press the OK button.
- ❹ Follow the on-screen instructions to proceed.

- Cable box with S-Video, component video (YPbPr) or HDMI connectors

See "Cover and connection"

- Antenna

Through an antenna, you can watch any HDTV programs that are broadcast in your area without paying fees.

If you're not sure what HDTV programming is available in your area, contact your local content provider or your local electronics retailer.

Broadcasters are currently transitioning from analog to digital TV. This means that a given broadcaster will have two channels on the air, one analog and one digital.

Connect the incoming antenna signal to the **CABLE/ANTENNA 75 Ω** jack at the bottom of the TV.

See page 12 for details on using Autoprogram to store channels in the TV's memory.

Note: This connection will supply stereo sound to the TV if it is being broadcast by the station you are watching.

- Direct Broadcast Satellite (DBS)

Satellite systems offer many of the same premium channels available on cable systems, often at a lower price. To view these channels, you'll need to install a small dish antenna outside your home.

The two main DBS systems, DirecTV and DishNetwork, require separate, proprietary set-top receiver boxes to decode their signals and send them to your digital TV set. These boxes may include a digital TV tuner for off-air DTV broadcasts.

Satellite broadcasters also provide major local channels, depending on the market in which you live.

DBS also provides service in areas not covered by cable because they are in rural areas or other areas not passed by a cable line.

DBS also allows you to watch pay-per-view events.

- ❸ **To connect accessory devices**, see Cover and Connection.
- ❹ **Refer to the bottom of the set (Model label) for the correct operation voltage.**

Insert the power cord into the wall socket.

Consult your local dealer if your main power supply voltage is different than that indicated for the TV. Never place the TV on top of the (AC) cord. Placing the TV on top of the AC cord could cause a fire or electric shock.

❺ **Remote control:**

Insert the two supplied AAA batteries.

The batteries supplied do not contain the heavy metals mercury and cadmium. Please determine and comply with local regulations when disposing of depleted batteries.

❻ **Turn the TV on:**

Press the power switch  at the front side of the TV. An indicator on the front of the TV lights up.

Press the **POWER** button or the **CH + / -** button on the remote control.

Use of the remote control

*Note: Pressing most buttons once will activate the assigned function. Pressing a second time will de-activate it. When a button enables multiple options, a small list will be shown. Press repeatedly to select the next item in the list. The list will be removed automatically after six seconds or press **OK** to remove immediately.*

Color buttons

When functions attached to the color buttons are active or selected, the color buttons are shown on screen.

INFO button

Display information: Press to display (when available) information about the selected TV channel and program or accessory device.

VOL +/- Volume

Press + or - to adjust the volume.

VIEW

To display a list of all channels marked as favorite (incl. subchannels).

CC button (Close Caption)

Press the CC button to select CC On, Off or On during mute.

SAP button (Second Audio Program)

Press to select a Audio Program if available with the TV programming: Main, or SAP.

Note: With Digital signal, user can choose different languages.

MENU/EXIT

Press menu to activate on screen menu on/off.

OK

- to activate a setting
- to display the list of channels stored (according to the selection made in the Installation mode (Antenna or Cable), p.13.

MUTE

Interrupt the sound or restore it.

Smart Sound button

Press repeatedly to select among the three settings; Personal, Speech, Movies.

Smart Picture button

Press repeatedly to select among Personal, Rich, Natural, Soft, or Power saver settings.

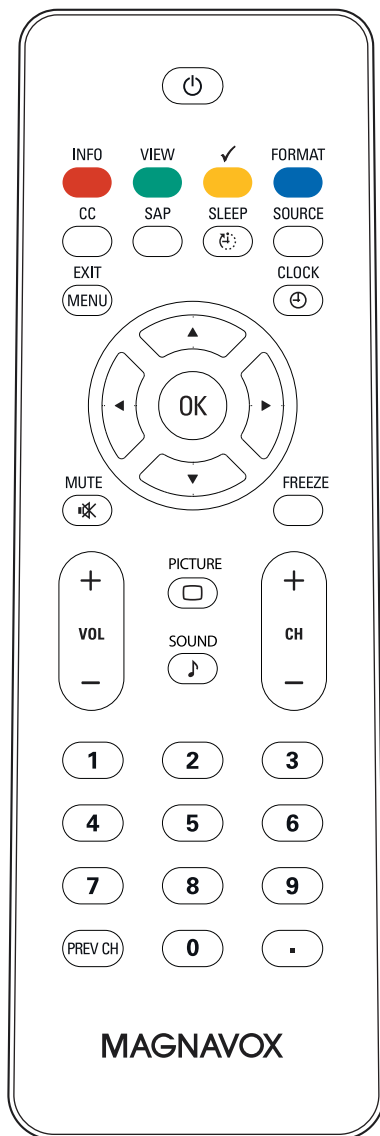

POWER

Press to turn on/off the TV from or to standby mode.

Note: The TV is never powered off completely unless it is physically unplugged.



To add or remove a channel in the favorite list of TV channels.

SOURCE

Press this button repeatedly to select TV, AVI, AV2, AV3, HDMII, HDMI2, Side or PC. When in TV mode, according to where you connected the accessory devices. (see Cover and Connection)

Sleep button

Press to set the LCD TV to turn itself off within a certain time.

Prev CH

Press to alternate between the currently viewed channel and the previously viewed channel.

. Dot button

Use the dot for digital channels.

CH +/- ▲ ▼ ◀ ▶ Channel selection

-To browse through the TV channels or sources stored in the preferred channel list (see p. 18).

-To select between Antenna or Cable TV channels, first make your selection in the Settings menu, see, p. 12.

Note: You don't have to start the installation again once you have searched for and stored the available TV channels.

FREEZE

To freeze the picture on the screen, press freeze button. To release, press FREEZE button again.

Format

Please refer to page 9.

Clock

Please refer to page 14.

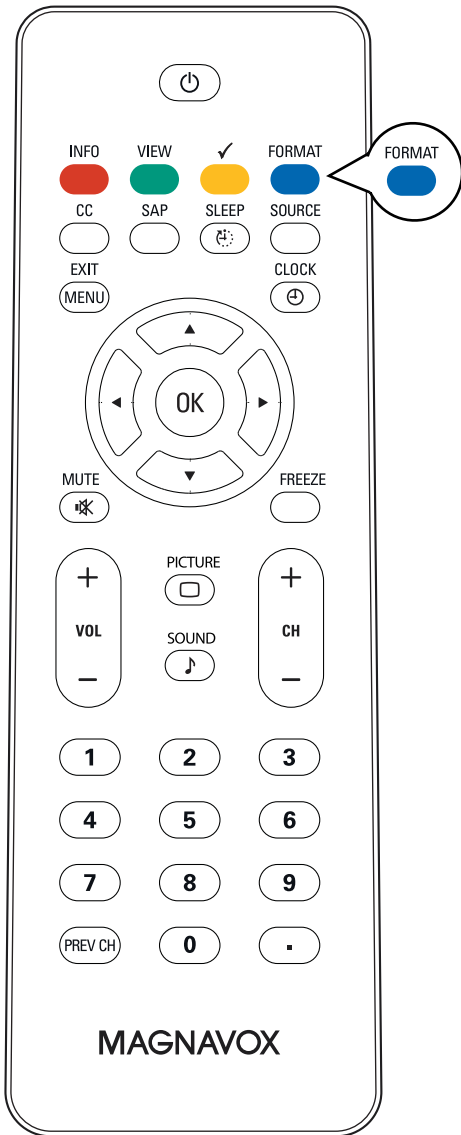

FORMAT

Press this button to display a list of available display formats. Available display formats are determined by the type of signal you are receiving.

To choose the display format you prefer, press the **FORMAT** button repeatedly:

Automatic, Super Zoom, 4:3, Movie expand 14:9, 16:9, Movie expand 16:9, 16:9 subtitle and widescreen.

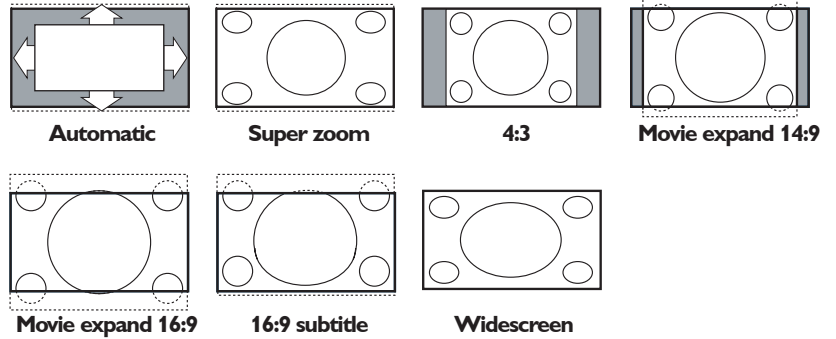

Super Zoom, Movie expand 14:9, Movie expand 16:9 and 16:9 subtitle makes the picture fill the screen as much as possible. It is recommended to press the cursor up/down key to adjust the picture position on the screen.

Super zoom removes the black bars on the sides of 4:3 programs with minimal distortion. When in the Expand 4:3, Compress 16:9, HD 4:3, Movie expand 14:9, Movie expand 16:9 or Super zoom picture format, you can make subtitles visible with the cursor up/down.

Note: Not all screen formats are available when displaying HD sources.

Buttons on the top of the TV

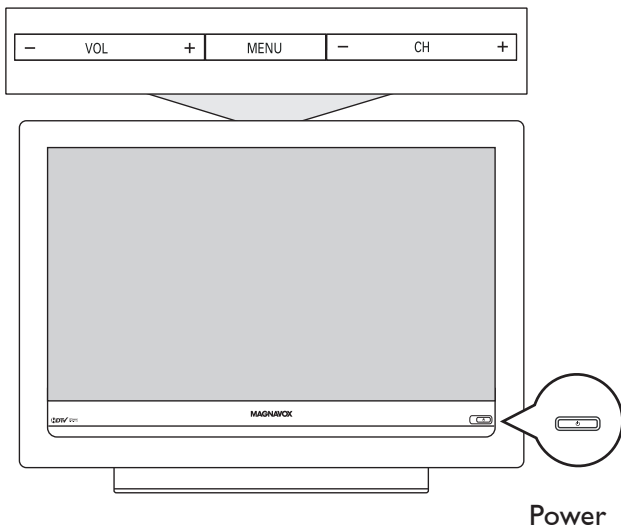

Should your remote be lost or broken you can still change some of the basic settings with the buttons on the top of your TV.

Press the power switch ϕ to switch the TV on.

Press:

- the **+ VOL** -button to adjust volume;
- the **+ CH** -buttons to select the TV channels or sources.

The **MENU** button can be used to display the Settings menu without the remote control. **MENU** button can also Exit the menu.

Use:

- the **+ VOL** - buttons and the **+ CH** - buttons to select menu items in the directions as shown;
- the **+ VOL** button to confirm your selection.

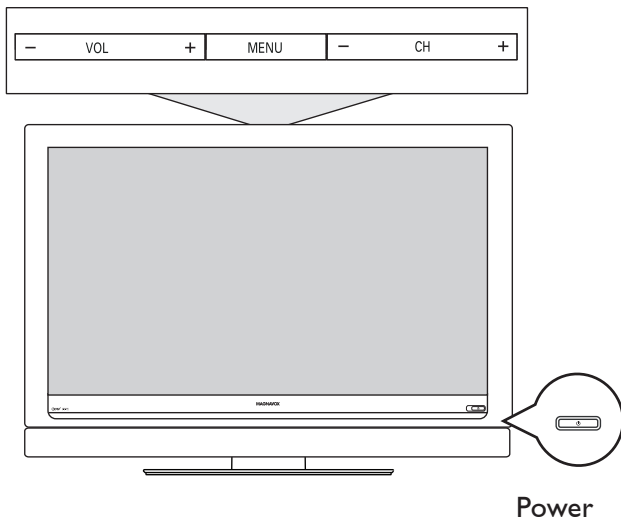

Introduction

When you use a menu or take an action, convenient instructions, help texts and messages will be displayed on your TV. Please, follow the displayed instructions and read the help text on the specific item highlighted.

The color buttons perform different actions, when using on screen menu. By pressing the corresponding color button on the remote control to perform the required action when using these menus.

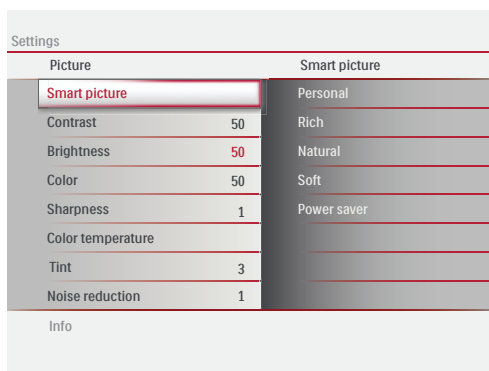
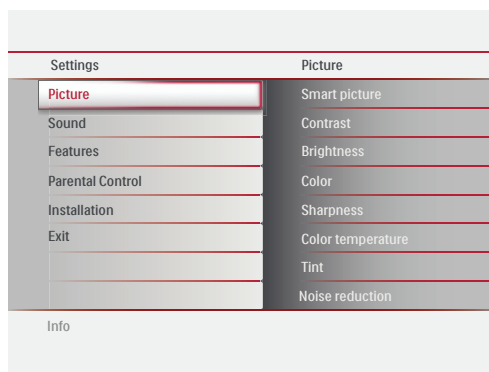

How to navigate through the Settings menus

The Settings menu allows you to access and change settings and preferences settings.

- Press the **MENU** button on the remote control to display the Settings menu.
- Use cursor up/down to highlight and select a menu item on the left panel.

The right panel shows the content of the menu you have highlighted in the left panel.

Note: Sometimes not all the menu items are visible on the screen. Use cursor down to scroll down to additional items.

- Use the cursor right to enter the right panel.

The content of the right panel is moved to the left panel and the right panel shows the content of the newly highlighted item in the left panel.

Note: In some cases, you will want to watch the picture on your screen while adjusting settings. This means that when the highlight is on the right side panel, the other menu items are hidden. When the cursor left is pressed again, the hidden menu items re-appear and the highlight moves to the left panel.

- Press the cursor left to go one menu level up again.
- Press the **OK** button on the highlighted item to activate and to dismiss the menu.
- Press the **MENU** button again to exit the Settings menu.

Note: The menu is also dismissed by pressing one of the color buttons (if present) referring to certain actions which may be executed.

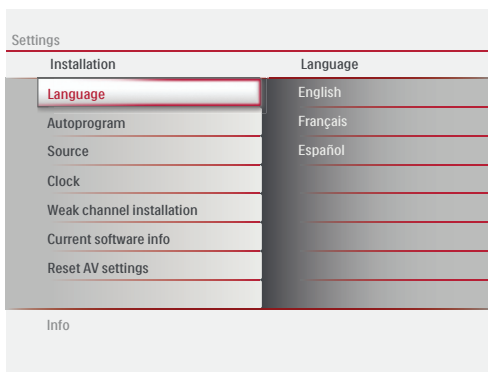

Select the menu language

- ❶ Press the **MENU** button on the remote control.
- ❷ Use the cursor down to select **Installation** in the Settings menu.
- ❸ Use the cursor right to enter the Installation menu.
- ❹ Select **Language** and enter the list of available languages with the cursor right.
- ❺ Select your preferred language with the cursor up/down and press the **OK** button to confirm your selection.
- ❻ Proceed with the Installation menu.

Store TV channels

- ❶ Select **Autoprogram** in the Installation menu.
- ❷ Use the cursor right to enter the Autoprogram menu.
- ❸ Select **Cable** or **Antenna** in the Installation mode.
When **Antenna** is selected, the TV will detect antenna signals and will search for antenna TV (NTSC and ATSC) channels available in your local area.
When **Cable** is selected, the TV will detect cable company supplied signals and will search for cable TV (NTSC, ATSC, QAM modulated) channels available in your area.
Make sure that registration with your cable TV provider and connection of equipment are completed.
- ❹ Select **Start now** with the cursor right key.
- ❺ Press the **OK** button.
- ❻ Press the green button "**Start**" to start Autoprogramming. The menu screen disappears and the progress of Autoprogramming is displayed. The progress bar indicates the number of analog and digital TV channels found.

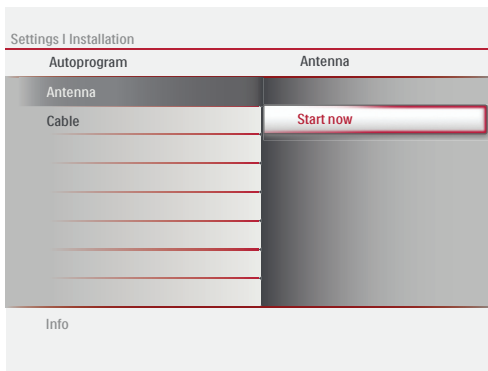

Auto programming may take up to 20 minutes to complete. Digital channels will take longer than Analog to find and program. Please wait until you see the Auto Programming complete message. The TV will then switch automatically to the first channel found.

Note: All channels must be unlocked in order to autoprogram. If requested, enter your PIN code to unlock all channels. (p. 25)

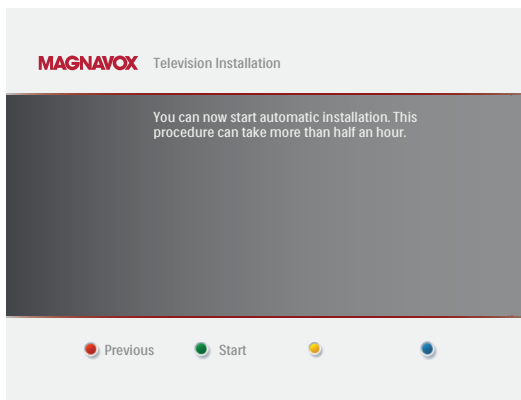

Notes:

- When you have locked TV channels before initiating Autoprogram, a message appears asking to enter your PIN code in order to complete Autoprogramming.
- When channel update is interrupted, the new updated channel information is retained along with the old un-updated channel information.
- Channel information about an ATSC channel is updated only for the ATSC channel currently tuned.
- If an NTSC channel is tuned, then in Background Autoprogramming the TV will scan all the possible ATSC frequencies and update information.
- Weak channel installation allows you to manually tune weak ATSC channels in order to adjust the antenna and thus optimize signal quality for that channel. (See Installation menu, Weak channel installation, p. 13.)
- Once you have searched for the available Antenna as well as the Cable TV channels, they are stored in the memory.
- If Antenna/cable signal is interrupted more than 30 minutes, TV will go into off mode. You are requested to press **Power** button or **CH + I -** button to turn on the TV.

Channel tuning

Available channels:

- Cable (analog NTSC or digital QAM)
- Terrestrial (analog NTSC or digital ATSC)

If a tuned channel is not yet in the master channel map, the TV will attempt to tune to the channel and it will be added to the map.

If the channel is not acquired, a message will appear reporting that the channel is not available. When you tune an audio-only digital subchannel, a display appears with the message Audio only.

Note: Subchannel selections

The new standards employed with digital broadcasting make it possible to receive multiple program channels under a single major channel number which can be selected by pressing the digit remote control direct-access channel number entry.

Important:

After the installation of the TV channels is completed, always make a selection in the Installation menu between Antenna or Cable whether you want to watch Antenna TV channels or Cable TV channels.

If you make use of a signal splitter do not forget to put the switch in the corresponding position.

Note: Digital Channel selection delay

Due to the tuning complexity of subchannel digital programming, the time to select and view a digital channel may take slightly longer than what the viewer is normally accustomed to (as compared to analog channel programs).

Digital channel broadcasts contain program and system data information that must be processed before the channel selection can be displayed.

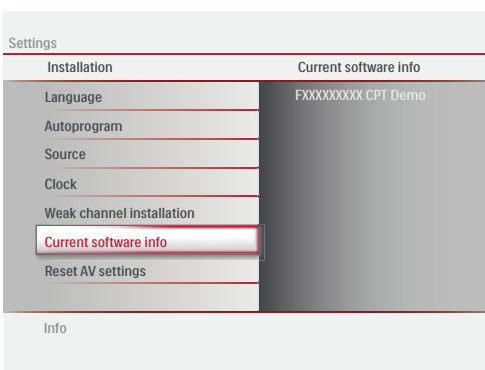
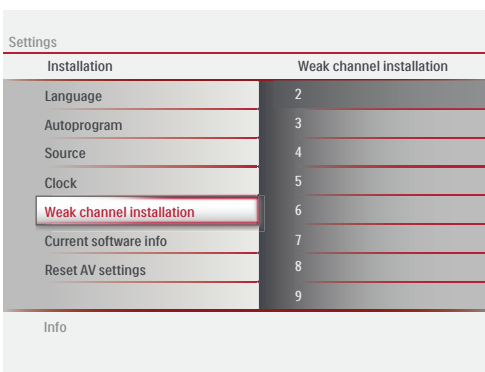

Weak channel installation

Antenna reception for broadcast channels may vary. If you are having difficulties acquiring weaker signals, we suggest you use: Weak Signal Installation feature.

Here's how:

- 1 In the antenna mode, select a channel from the displayed list of TV channels. Select the "Start" by pressing red button on the remote control; TV set will detect the signal.
- 2 The signal strength is continuously displayed and updated as you rotate the antenna.

When strength is enough to identify, user can store the channel in the channel list by pressing green button on the remote control.

Current software info

This menu will appear with your TV software information.

- 1 Press the **MENU** button on the remote control.
- 2 Use the cursor down to select **Installation** in the Settings menu.
- 3 Using the cursor up/down to choose **Current software info** the TV software information is displayed.

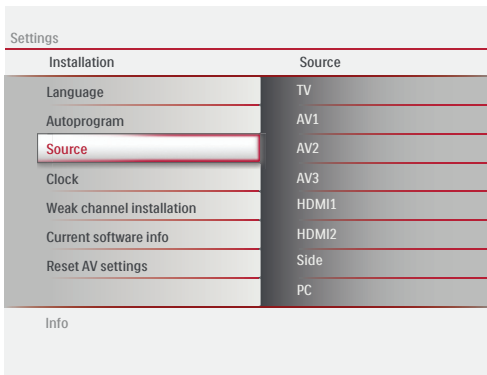

Source

This menu allows you to identify the accessory devices you have connected to the external inputs/outputs.

- 1 Select **Source** in the **Installation** menu.
- 2 Press the cursor right to enter the list, and press up/down key to the selected input.
- 3 Press **OK** button to confirm.

Analog Audio In

If your accessory device has a DVI output connector, only the video signal is transmitted in digital format. To input an audio signal, please connect the analog audio L and R outputs to the TV's L and R AV3 audio input plugs.

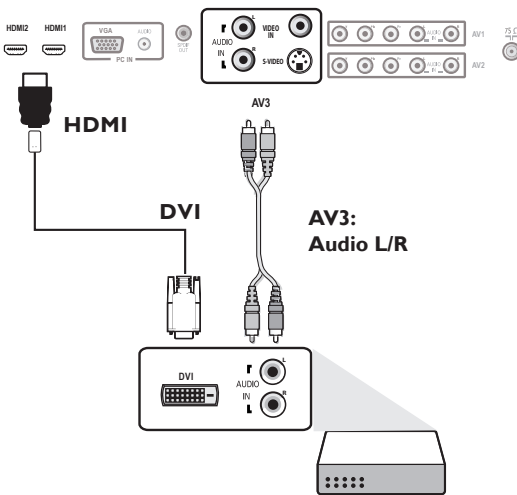

Digital Audio Out

In addition to accepting audio input through **HDMI**, the TV can output Digital audio through the **DIGITAL AUDIO OUT (SPDIF OUT)** connector to an external amplifier or receiver. If your amplifier or receiver has a matching connector for Digital Audio In, you can connect it with a single cable to the TV's **DIGITAL AUDIO OUT (SPDIF OUT)**. See Cover and Connection.

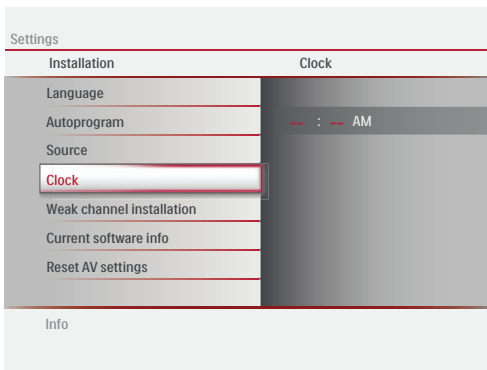

Clock

This allows you to use your TV as a clock.

- 1 Press the **MENU** button on the remote control.
- 2 Use the cursor down to select **Installation** in the Settings menu.
- 3 Press the cursor right to enter the list, and press up/down key to set the time. (hour/ minute/ AM or PM)
- 4 Press **OK** button to confirm.

Reset AV settings

This function allows you to reset most of the picture and sound settings to their default factory levels.

- 1 Select **Reset AV settings** with the cursor down key.
- 2 Press the cursor right key.
- 3 Press the **OK** button to erase settings and reset them to their default values.

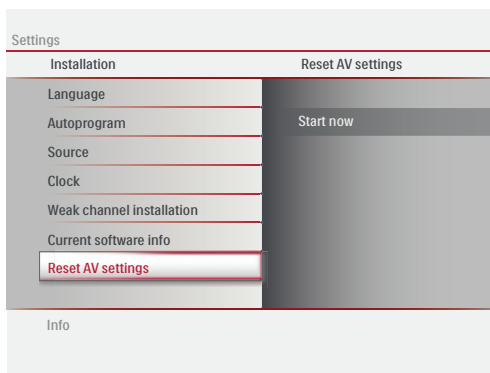

Features menu

- ❶ Select **Features** in the TV Settings menu.
- ❷ Press the cursor right key to enter the features menu.
- ❸ Select the menu items with the cursor up/down key and adjust the settings with the cursor left/right key.

Closed captions

This displays the transmitted CC- or CS-text on the screen according to your chosen CC or CS service in the **Feature** menu. This text can either be permanently displayed (assuming that the service is available in the broadcast) or only when mute is active.

- ❶ Press the cursor right key after having selected Closed captions.
- ❷ Select On, Off or On during mute.

Caption service

This allows you to select the Closed Captions service levels of analog broadcasting to be displayed. Closed Captioning allows you to read the voice content of television programs on the TV screen. Designed to help the hearing impaired, this feature uses on-screen 'text boxes' to show dialogue and conversations while the TV program is in progress. Captions will appear on the screen during captioned broadcasts.

- ❶ Select **Captions service**.
- ❷ Press the cursor right key.
- ❸ Select the desired Caption service:
 - CC 1,2,3 or 4
Dialogue (and descriptions) for the action on the captioned TV program shows on screen. Usually CCI is the most used. CC2 may be used for alternate languages if they are being transmitted.
 - T 1,2,3 or 4
Often used for channel guide, schedules, bulletin board information for Closed Captions programs, news, weather informations or stock market reports. Not all Caption services are necessarily being used by a TV channel during the transmission of a Closed Caption program.
- ❹ See Closed Caption in the TV, Features menu, to turn the Caption service On or Off.

Note: This television provides display of television closed captioning conforming with the EIA-608 standard and in accordance with Sections 15.119 of the FCC rules.

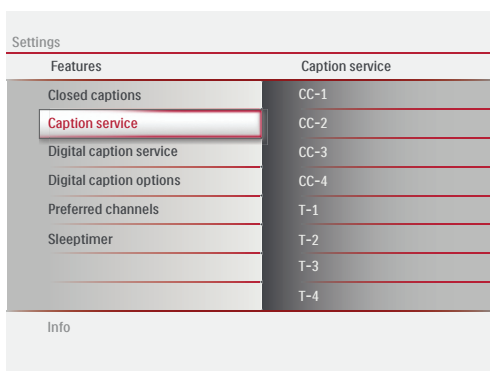
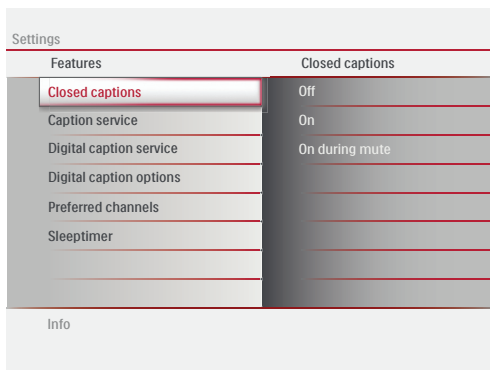
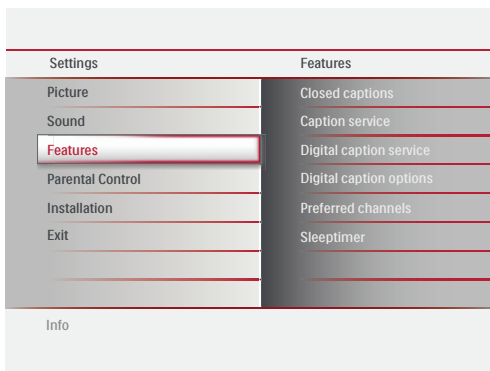

Note: The captions do not always use correct spelling and grammar. Not all TV programs and product commercials are made for broadcast with Closed Caption informations included. Refer to your area's TV program listings for the TV channels and times of Closed Caption programming. Captioned programs are usually noted in the TV listings with service marks such as 'CC'.

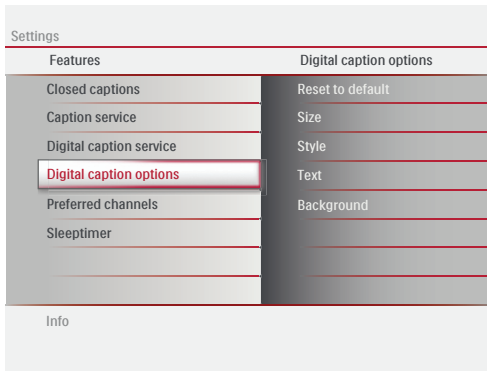
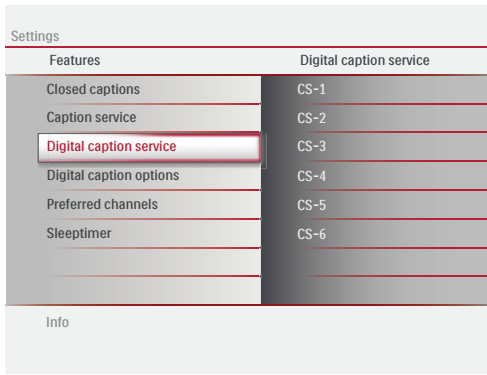

Digital caption service

This allows you to configure the way you choose to view digital captioning.

Select one of the digital service channels made available by the caption provider.

There are six standard services. Service 1 is designated as the Primary Caption Service. This service contains the verbatim, or near-verbatim captions for the primary language being spoken in the accompanying program audio.

Service 2 is designated as the Secondary Language Service.

This service contains captions in a secondary language, which is a translation of the captions in the primary Caption Service. The other service subchannels are not pre-assigned.

It is up to the discretion of the individual caption provider to utilize the remaining service channels.

Digital caption options

This allows you to modify how digital captions are displayed on your TV. Select from the following options to change the visual characteristics of your TV's digital captioning.

- **Reset to default**

Select this option to reset the digital caption options to the captions provider default settings.

Press the **OK** button to confirm.

- **Size**

Select this option to choose a caption display size according to your own preference. Select **Default (Automatic)**, **Small**, **Standard** or **Large** and press the **OK** button to confirm.

- **Style**

Select this option to choose a caption display font style according to your own preference. Select **Default**, **Mono spaced serif**, **Serif**, **Monospaced sans serif**, **Sans serif**, **Casual**, **Cursive** or **Small caps**.

- **Text**

Select this option to choose caption display text box, text color and/or the opacity according to your own preference. Select a color and an opacity option.

- **Background**

Select this option to choose caption display character background color or one of the background opacity options according to your own preference. Select a color and one of the opacity options.

Note: Opacity is transparent (allowing light to pass through)

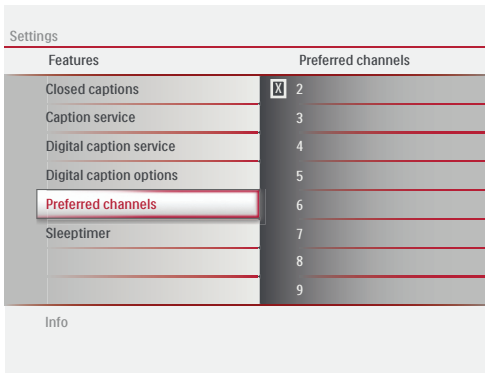

Preferred channels

A channel, when installed, is marked as preferred by default and added to the channel list. This feature provides the ability to remove a channel number from the channel list.

- ❶ Select **Preferred channels** with the cursor down key.
- ❷ Press the cursor right key to enter a list with all stored channel numbers.
- ❸ Select the channel you want to remove with the cursor down key.
- ❹ Press **OK**.
- ❺ Repeat to remove other channels.

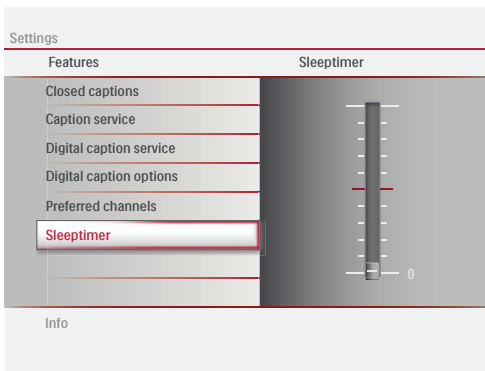

Sleeptimer

This sets a time period after which the TV automatically turns to standby.

- ❶ Select **Sleeptimer**.
 - ❷ Press the cursor right key.
 - ❸ Select a value with the cursor up/down key. The list will have values from **Off** to 180 minutes. When **Off** is selected, the sleeptimer is turned off.
- You can always turn off your TV earlier or select another time set.

Picture menu

Note: Some menu items are not available in case of HD sources.

- 1 Select **Picture** in the TV Settings menu.
- 2 Press the cursor right key again to enter the Picture menu.
- 3 Select the menu items with the cursor up/down key.
- 4 Adjust the settings with the cursor left/right key or enter the list of submenu items with the cursor right key. Select a submenu item with the cursor up/down key.

Smart picture

- 1 Select **Smart picture** to display a list of predefined picture settings, each corresponding with specific factory settings. **Personal** refers to the personal preference settings of picture in the picture menu.

Note: This Magnavox TV has been set at the factory to look best in bright store environments, which typically use fluorescent lighting. As your home will likely not be as well lit as a store, we recommend that you cycle through the various smart picture modes to find the one that best suits your own viewing conditions. Most consumers will find that **Natural** is the correct choice.

- 2 You can press the **Smart picture** button on the remote control repeatedly to select either Personal, Rich, Natural, Soft, or Power saver picture settings.

Note:

- When you watch programs by Composite Video signal, it's recommended to select **Soft or Power saving** Mode via Smart picture.
- The moment you are in a predefined Smart picture setting and you modify the Picture menu, all values of the menu will overwrite those previously made in personal setting.

Contrast

This will adjust the intensity of bright parts in the picture but keep the dark parts unchanged.

Brightness

This will adjust the light output of the complete picture, which will mainly affect the darker areas of the picture.

Color

This will adjust the saturation level of the colors to suit your personal preference.

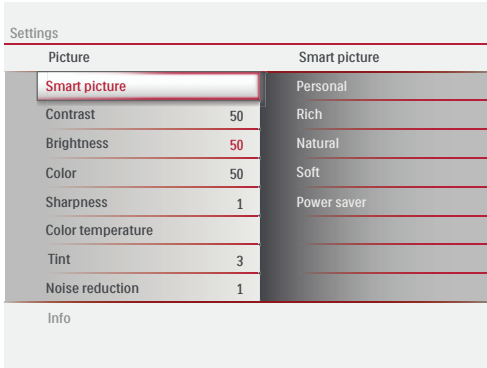
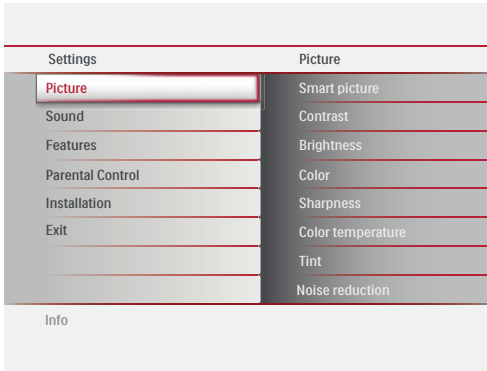

Sharpness

This will adjust the sharpness of fine details in the picture.

Color temperature

This will increase or decrease **Warm** (red) and **Cool** (blue) colors to suit personal preferences.

Select **Cool** to give the white colors a blue tint, **Normal** to give the white colors a neutral tint, **Warm** to give the white colors a red tint.

Tint

Allows you to select the picture's color mix or hue.

Noise Reduction

Reduce picture noise.

Dynamic contrast

Enhance contrast ratio.

Picture format

This menu item performs the same as the **FORMAT** button on the remote control. See Use of the remote control, p.9.

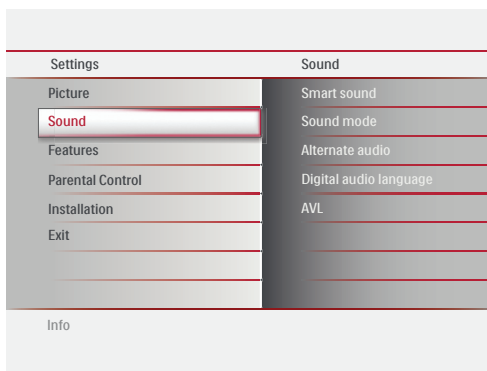

Sound menu

- 1 Select **Sound** in the TV Settings menu.
- 2 Press the cursor right key to enter the sound menu.
- 3 Select the menu items with the cursor up/down key and adjust the settings with the cursor left/right key.
- 4 Remember, control settings are at normal mid-range levels when the bar scale is entered.

Smart sound

Select Smart sound to display a list of predefined sound settings, each corresponding with specific factory settings of Treble and Bass.

- 1 Press the cursor right key to enter the list.
- 2 Press the cursor up/down key to select a predefined sound setting. Personal refers to the personal preference sound settings in the sound menu.

Note: The moment you are in a predefined Smart sound setting and you modify the Sound menu, all values of the menu will overwrite those previously made in personal setting.

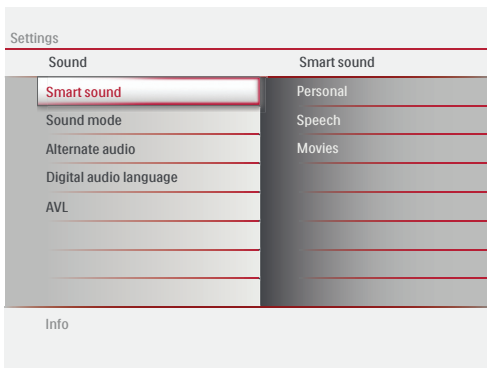

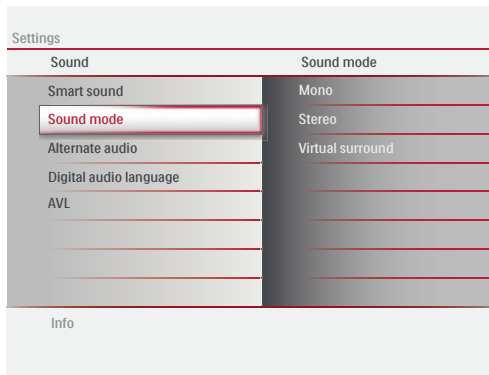

Sound mode

This select the modes for more spatial or surround sound reproduction dependent on the broadcast signals or signals from external inputs received.

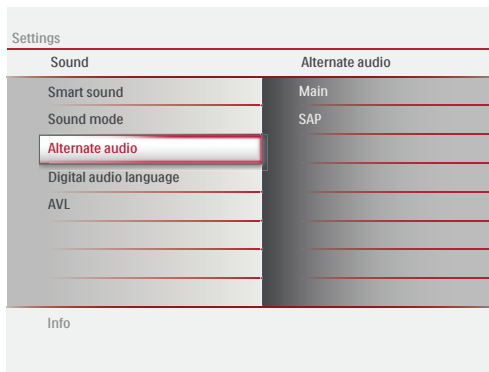

Alternate audio

This gives you the possibility to swap between “Main” and second audio program (SAP), when it is available in analog channel.

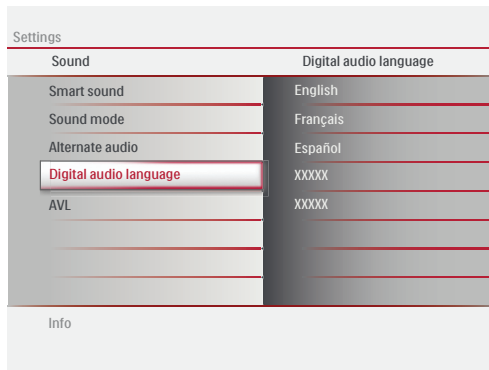

Digital audio language

This gives you the possibility to swap between main and alternative language, when it is available in digital channel.

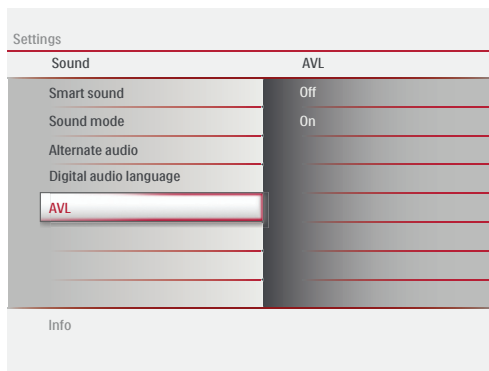

AVL (Automatic Volume Leveler)

Automatically reduces the volume differences between channels and programs, providing a more constant overall level. This will also reduce the dynamics of sound.



Manufactured under license from Dolby Laboratories. ‘Dolby’ and the double-D symbol are trademarks of Dolby Laboratories.

Parental Control menu

This menu can control special functions for the TV channels.

- ❶ Select **Parental Control** in the TV settings menu with the cursor up/down key.
- ❷ Press the cursor right to enter the channels menu.
- ❸ Press the cursor up/down key to select a channels menu item.

Channel lock

This allows you to completely lock a certain TV channel or external source. Select the channels or subchannels you want to lock and press **OK** to confirm.

TV ratings lock

Your TV is equipped with a V-chip. This allows you to control access to individual programs based on their movie and TV ratings. All settings apply to all AV inputs, except HDMI. The program content advisory data are sent by the broadcaster or program provider.

- ❶ Select **TV ratings lock** with the cursor down. A list appears, showing the age-based TV ratings and a corresponding content-based ratings list.
- ❷ Press the cursor right to enter the list.
- ❸ Select an age-based TV rating with the cursor up/down, and enter, if present, the list with content-based ratings with the cursor right, and select one content-based rating.
- ❹ Press **OK** to activate/de-activate the selected rating. You are asked to enter your PIN-code (see Set/Change PIN, p. 25). If the code is correct, the TV ratings lock menu reappears.
- ❺ Select another content-based rating if you like and press **OK** again.

You need only enter your PIN-code once while the menu is active. You can lock/unlock any number of ratings on the list without re-entering your code.

Each ratings item has a box-graphic in front of it to indicate whether or not programs carrying that rating are currently locked:

- : all items in the contents-based list are locked as well;
- : the item is unselected;
- : some content-based ratings are selected/unselected.

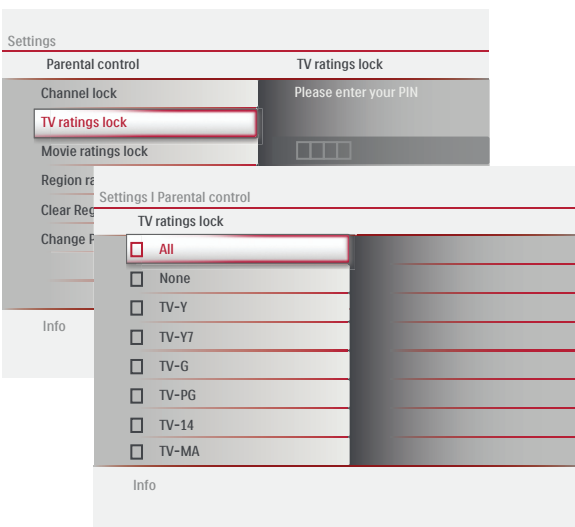
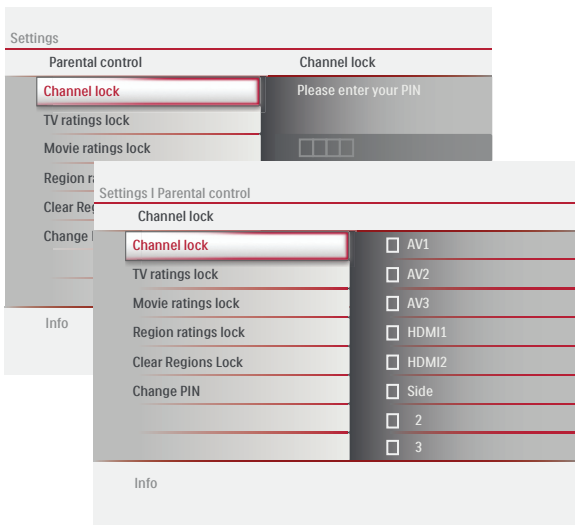
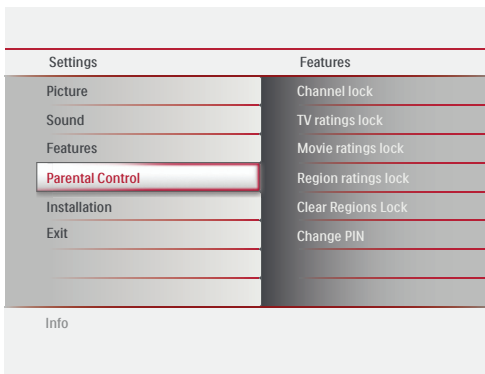

Age-based Rating	Content-based Rating
All	none
None	none
TV-Y	none
TV-Y7	(FV) Fantasy Violence
TV-G	none
TV-PG	(D) Dialog (L) Language (S) Sex (V) Violence
TV-14	(D) Dialog (L) Language (S) Sex (V) Violence
TV-MA	(L) Language (S) Sex (V) Violence

When **All** has been selected, all items in the age-based and in the contents-based lists are locked. If, while **All** is selected, any other item, either an age-based or content-based item, is unselected, then All is automatically unselected.

None is the selection for items that either have no rating information or have a rating of **None**. Both will be locked. When an item on the age-based list is selected, all items below that item of the same group are locked as well. When you select a content-based rating, all identical content-based ratings in the younger age-based categories are also selected.

TV-Y	appropriate for children of all ages with themes and elements suitable for children aged 2-6
TV-Y7	programs designed for children age 7 and older
TV-Y7-FV	programs include fantasy violence more intense than other programs in the TV-Y7 category
TV-G	programs suitable for all ages. These programs contain little or no violence, no strong language and little or no sexual dialogue or situations
TV-PG	programs contain elements that some parents may find unsuitable for younger children and which may need parental guidance. The program may contain moderate violence, sexual dialogue and/or situations and some strong language.
TV-14	programs contain elements that may not be suitable for children under 14 years of age. These programs include one or more of the following: intense violence, intense sexual situations, suggestive dialogue and strong language.
TV-MA	programs are designed to be viewed by adults and may be unsuitable for children under the age of 17. These programs may contain graphic violence, explicit sexual activity and/or crude or indecent language.

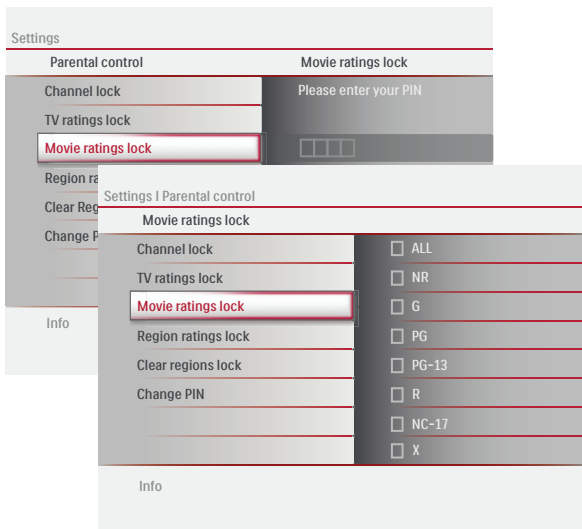

Movie Ratings Lock

This function allows you to control access to individual movies based on their MPAA ratings (Motion Picture Association of America).

- ❶ Select Movie ratings lock with the cursor down. A list appears, showing all valid MPAA content ratings.
- ❷ Press the cursor right to enter the list. You are asked to enter your code. (See Set/Change PIN, p. 25.) If the code is correct, the Movie ratings lock menu reappears.
- ❸ Select a movie rating with the cursor up/down.
- ❹ Press OK to activate/de-activate the selected rating.

Each rating item has a box-graphic in front of it to indicate whether or not programs carrying that rating are currently locked:

- : movies with this rating are locked;
- : movies with this rating are unlocked.

When **All** has been selected, all items on the movie ratings list become selected. (**All** movies are locked.) If, while All is selected, any other item is unselected, then **All** is automatically unselected.

When **NR** has been selected, no other item is selected.

When any other item has been selected, all ratings below are selected as well, thus all movies with those ratings will be locked.

NR	not rated
G	movies with a mild content, suitable for all ages
PG	movies for which parental guidance is recommended. They may contain a few racy or violent scenes or maybe some bad language
PG-13	movies for which parental guidance may be recommended if under age 13
R	restricted. The movies usually contain offensive sex or bad language and may be unsuitable for children under the age of 17. Parental guidance or permission needed.
NC-17	even with parental permission, forbidden under age 17. More offensive sex, violence or bad language.
X	movies which generally focus on sex, violence and/or bad language. Also known as pornography.

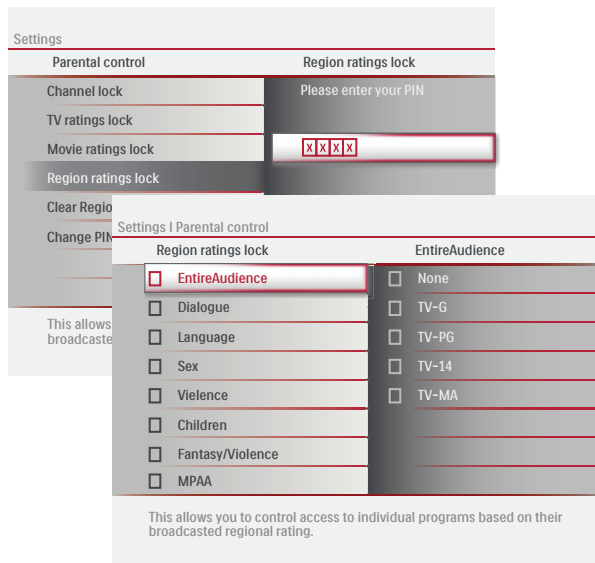

Region ratings lock

This allows you to control access to individual programs base on their broadcasted regional rating.

- 1 Select **Region ratings lock** with the cursor down. A list appears, showing the age-based Region ratings and a corresponding content-based ratings list.
- 2 Press the cursor right to enter the list.
- 3 Select an age-based Region rating with the cursor up/down, and enter, if present, the list with content-based ratings with the cursor right, and select one content-based rating.
- 4 Press **OK** to activate/de-activate the selected rating. You are asked to enter your PIN-code (see Set/Change PIN, p. 25). If the code is correct, the Region ratings lock menu reappears.
- 5 Select another content-based rating if you like and press **OK** again.

You need only enter your PIN-code once while the menu is active. You can lock/unlock any number of ratings on the list without re-entering your code.

Each ratings item has a box-graphic in front of it to indicate whether or not programs carrying that rating are currently locked:

- : all items in the contents-based list are locked as well;
- : the item is unselected;
- : some content-based ratings are selected/unselected.

Clear regions lock

This allows you to clear all the locks that you have set in the Region ratings lock table.

- 1 Select **Clear regions locks** with the cursor down.
- 2 Enter your PIN-code to clear all region ratings' status.

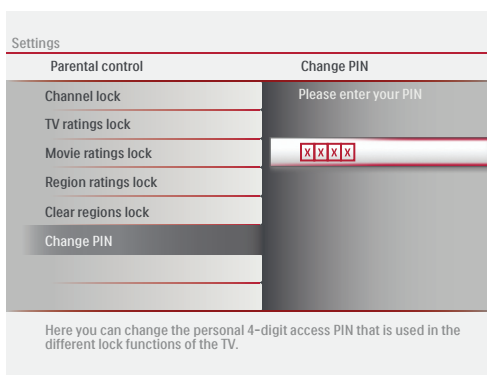
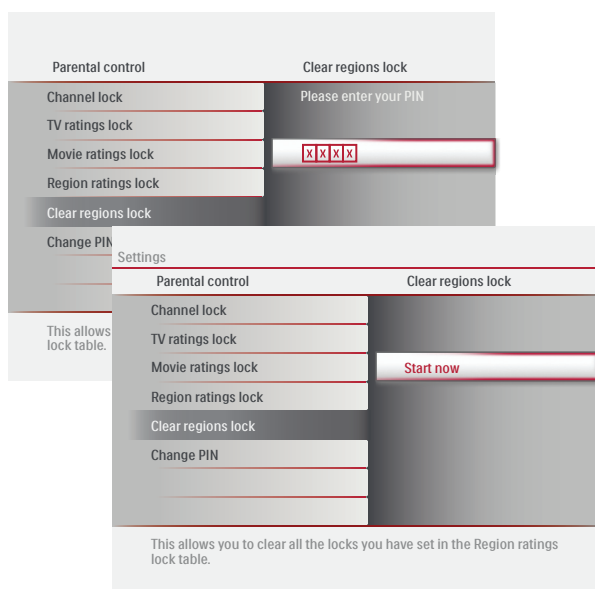

Change PIN

- 1 Select **Set** or **Change PIN** with the cursor down.
- 2 If no PIN-code exists, the menu item is set to **Set PIN**. Follow the instructions on screen. If a PIN-code has previously been entered, the menu item is set to **Change PIN**. Follow the instructions on screen. All number combinations from 0000 to 9999 are valid numbers.
- 3 The **menu** reappears with a message confirming that the PIN has been created.

Important: you have forgotten your PIN!

- 1 Select **Change PIN** in the Menu preferences menu and press the cursor right key.
- 2 Press the cursor right key to enter the overriding PIN code **0-7-1-1**.
- 3 Press the cursor again and enter a new personal 4-digit PIN code. The previous code is erased and your new PIN-code is stored.

Select the menu language

Note: Press **SOURCE** button on the remote control to make sure the source is selected in **PC** mode.

- ❶ Press the **MENU** button on the remote control.
- ❷ Use the cursor down to select **Installation** in the Settings menu.
- ❸ Use the cursor right to enter the Installation menu.
- ❹ Select **Language** and enter the list of available languages with the cursor right.
- ❺ Select your preferred language with the cursor up/down and press the **OK** button to confirm your selection.
- ❻ Proceed with the Installation menu.

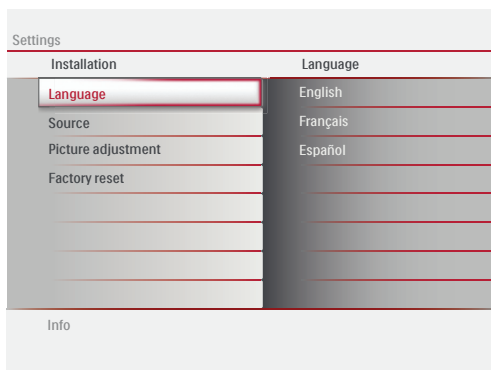

Source

- ❶ Select **Source** in the Installation menu.
- ❷ Use the cursor right to enter the Source menu.
- ❸ Select **PC** with the cursor up/down and press the **OK** button to confirm your selection.

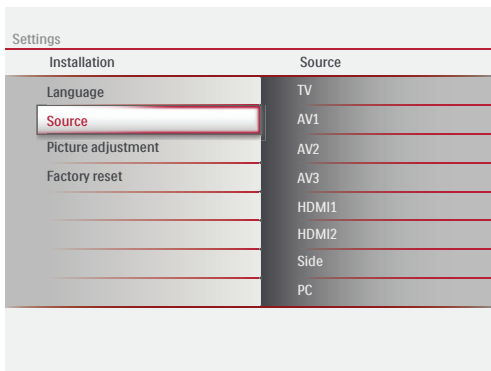

Picture adjustment

- ❶ Select **Picture adjustment** in the Installation menu.
- ❷ Use the cursor right to enter the Picture adjustment menu.
- ❸ You can choose **Auto adjust** or **Manual adjust** with cursor up/down and press **OK** button to confirm.

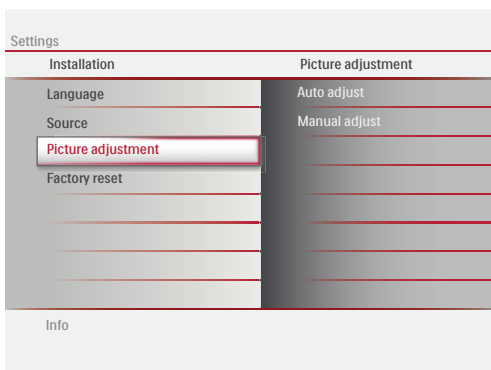

Auto adjust

Automatically adjust to the best image position, phase and clock setting.

Manual adjust

Manually fine tune the image as it appears on the screen.

- **Phase**
Eliminates the horizontal interfering lines.
- **Clock**
Eliminates the vertical interfering lines.
- **Horizontal**
Adjust the horizontal placement of the picture.
- **Vertical**
Adjust the vertical placement of the picture.

Factory reset

This function allows you to reset most of the picture and sound settings to their default factory levels.

- ❶ Select **Factory reset** in the Installation menu.
- ❷ Use the cursor right to enter the Factory reset menu.
- ❸ Press the **OK** button to erase settings and reset them to their default values.

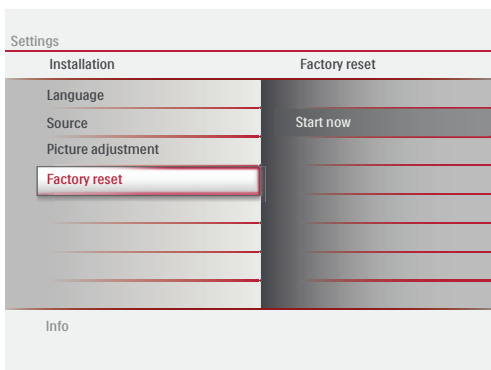

Picture menu

- ① Select **Picture** in the TV Settings menu.
- ② Press the cursor right key again to enter the Picture menu.
- ③ Select the menu items with the cursor up/down key.
- ④ Adjust the settings with the cursor left/right key or enter the list of submenu items with the cursor right key. Select a submenu item with the cursor up/down key.

Contrast

This will adjust the intensity of bright parts in the picture but keep the dark parts unchanged.

Brightness

This will adjust the light output of the complete picture, which will mainly affect the darker areas of the picture.

Color temperature

This will increase or decrease **Warm** (red) and **Cool** (blue) colors to suit personal preferences.

Select **Cool** to give the white colors a blue tint, **Normal** to give the white colors a neutral tint, **Warm** to give the white colors a red tint.

Picture format

This menu item performs **4:3** or **Full screen** in PC mode.

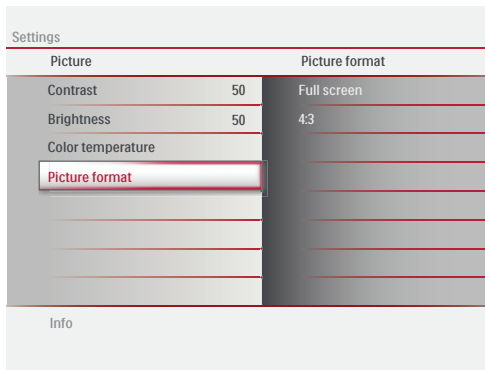
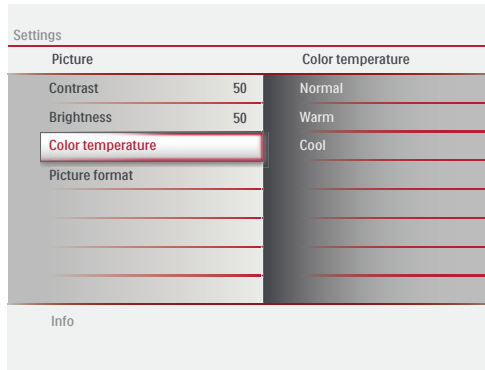
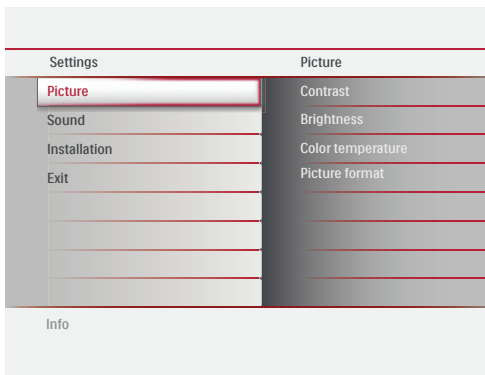

Sound menu

- ❶ Select **Sound** in the TV Settings menu.
- ❷ Press the cursor right key to enter the sound menu.
- ❸ Select the menu items with the cursor up/down key and adjust the settings with the cursor left/right key.
- ❹ Remember, control settings are at normal mid-range levels when the bar scale is entered.

Smart Sound

Select Smart sound to display a list of predefined sound settings, each corresponding with specific factory settings of Treble and Bass.

- ❶ Press the cursor right key to enter the list.
- ❷ Press the cursor up/down key to select a predefined sound setting. Personal refers to the personal preference sound settings in the sound menu.

Note: The moment you are in a predefined Smart sound setting and you modify a setting in the Sound menu, all values of the menu will overwrite the previously made in personal setting.

Virtual surround

Adds greater depth and dimension to PC sound.

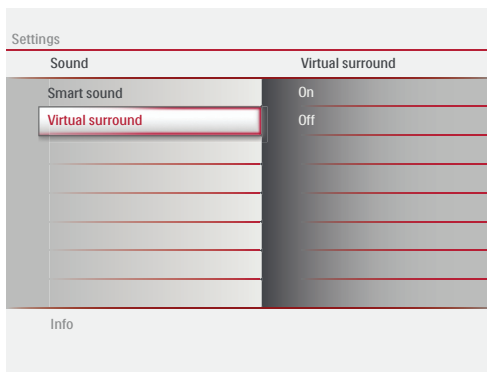
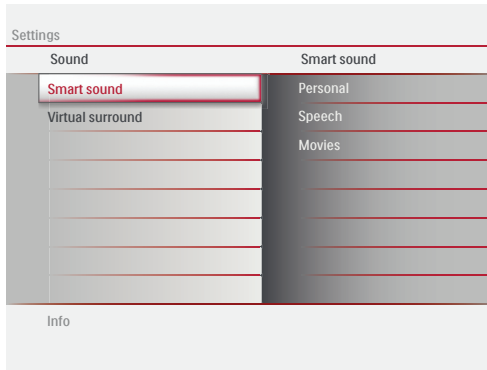
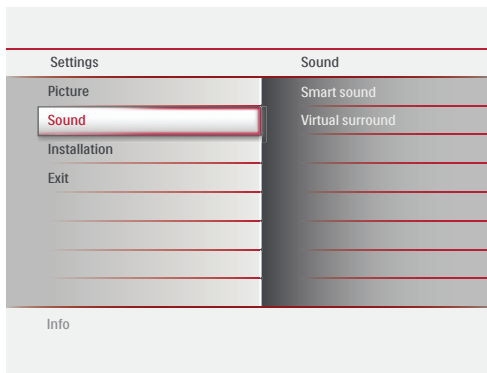

Record with your recorder

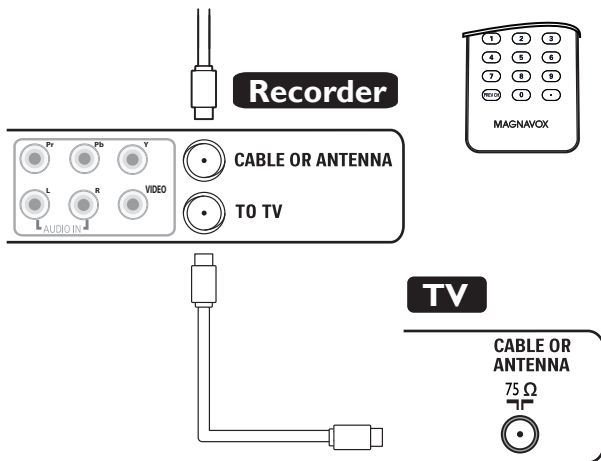

Record a TV program

You can record a TV program using your recorder's tuner without affecting your TV.

- 1 Select the channel number on your recorder.
- 2 Set your recorder to record.
See the handbook for your recorder.

Note: Switching channel numbers on your TV does not disturb recording!

To select connected devices

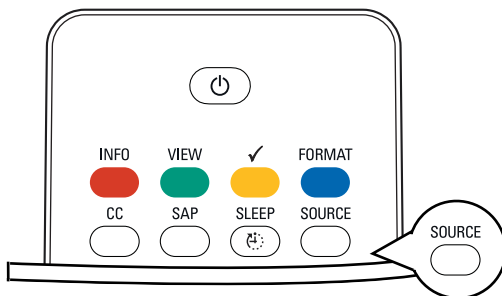

- 1 Press the **SOURCE** button repeatedly or select Source in the Settings menu (see p. 14) to select **TV, AV1, AV2, AV3, HDMI1, HDMI2, Side** or **PC**, according to where you connected your devices.
- 2 Press the cursor up/down.
- 3 Press **OK**.

Trouble Shooting Tips

Symptoms	Items to Check and Actions to follow
“Ghost” or double images	<ul style="list-style-type: none"> This may be caused by obstruction to the antenna due to high rise buildings or hills. Using a highly directional antenna may improve the picture.
No power	<ul style="list-style-type: none"> Check that the TV’s AC power cord is plugged into the mains socket. Unplug the television, wait for 60 seconds. Then re-insert plug into the mains socket and turn on the television again.
No picture	<ul style="list-style-type: none"> Check antenna connections at the bottom of the TV to see if they are properly connected to the TV. Possible broadcast station trouble. Try another channel. Adjust the contrast and brightness settings. Try another auto picture setting. Check the Closed Captions control. Some TEXT modes could block the screen. Check if you selected the correct AV source.
No picture and power switched on	<ul style="list-style-type: none"> Your TV has a protective mode in case there is too much heat build-up. Check the clearance around the vents of the device to be certain there are no blocking walls or cabinets which would limit the air flow.
Picture position adjustment	<p>When displaying a High Definition signal from the YPbPr inputs or HDMI input, if necessary, you can adjust the picture position to the center of the screen with the cursor left/right or up/down buttons on the remote control. This may be needed due to slight differences in output signals from different brands and types of HD source boxes.</p> <p><i>Notes: Most High Definition receiver boxes also have picture-positioning controls in their menu systems. If the TV cursor controls run out of range before the picture is correctly positioned, the receiver box controls will need to be adjusted.</i></p>
No photo, music or video play or in poor quality only	<ul style="list-style-type: none"> Check if the source complies with a supported code.
No sound	<ul style="list-style-type: none"> Increase the VOLUME. Check that the TV is not muted, press the MUTE button on the remote control. When no signal is detected, the TV automatically switches off the sound. This is proper operation and does not indicate a malfunction.
Good sound but poor color or no picture	<ul style="list-style-type: none"> Adjust the contrast, color, tint and brightness setting. Try another auto picture setting.
Snowish picture and noise	<ul style="list-style-type: none"> Check the antenna connection.
Television not responding to remote control	<ul style="list-style-type: none"> Check whether the batteries are working. Replace if necessary. Clean the remote control sensor lens on the set. Operating range between TV and the remote control should not be more than approximately twenty feet. You can still use the buttons on the top of your TV. Check if the remote control is in the correct mode.
Control of accessory devices	<ul style="list-style-type: none"> The infrared signals of the screen may influence the reception of other peripherals. Replace the batteries of the remote control of other devices. E.g. keep away a wireless headphone from within a radius of approximately four feet.
The software will not install	<p>Possibly the operating system is wrong. Go to www.magnavox.com/usasupport to see which operating systems are supported.</p>
PC modes do not work	<ul style="list-style-type: none"> Check whether connections are correct. Check whether the source is correctly selected. Press SOURCE button to select the correct source. Check whether you have configured the computer on a compatible display resolution.

Standby	Your TV consumes energy less than 1w in the standby mode.
After improper shutdown	If your TV has been shutdown in an improper way (e.g. power drop, power cord plug out), starting up the TV again will take a longer time than usual.
Miscellaneous	See Extras, Specifications on this user’s manual.

Glossary

Aspect Ratio	The ratio between the width and height of the TV picture on the screen. In a normal TV set the aspect ratio is 4 to 3 (4:3). The new aspect ratio in HDTV is 16:9 which resembles the aspect ratio in a movie theatre (Widescreen). New TV systems support both 4:3 and 16:9 aspect ratio and can automatically switch between them.
Audio Video (A/V)	A term often used when discussing a channel on a TV receiver or on video equipment, which has been especially designed to accept VCR audio-video signals. This channel automatically activates special circuitry within the TV set to prevent picture distortion and skewing. It is also used for audio-video processors, which handle both types of signals.
ATSC	ATSC: Advanced Television Systems Committee. Formed to establish technical standards for advanced television systems, including digital high definition television (HDTV).
CVBS	Composite Video Baseband Signal. In broadcast television this refers to the video signal, including the colour information and syncs.
Component Video Input (Y Pb Pr)	Component Video Input is a type of connection that uses a cinch-type connector to allow set top boxes or analog DVD players to connect a signal to the TV. By offering the cinch-type input (YPbPr) the primary colors, red, green and blue are connected from a set top box directly into the TV allowing for the signal to display on the screen.
DTV	Digital television. Generic term that refers to all digital television formats, including high-definition television (HDTV) and standard-definition television (SDTV).
DOLBY Digital	Dolby Digital - Six-channel digital audio standard that is part of the U.S. digital television standard; also called AC-3 or Digital 5.1. The channels consist of front left, front right, front center, surround or rear left, surround or rear right, and a separate subwoofer.
Digital Tuner	A digital tuner serves as the decoder required to receive and display digital broadcasts. It can be included inside TV sets or via a set-top box.
HDTV	The generally agreed upon definition of HDTV is approximately twice the vertical and horizontal picture resolution of today's NTSC TV, which essentially makes the picture twice as sharp. HDTV also has a screen ratio of 16:9 as compared with most of today's TV screens, which have a screen ratio of 4:3. HDTV offers reduced motion artifacts (i.e. ghosting, dot crawl), and offers 5.1 independent channels of CD-quality stereo surround sound, (also referred to as AC-3).
NTSC	National television system committee. The organization that developed the analog television standard currently in use in the U.S., Canada, and Japan. Now generally used to refer to that standard. The NTSC standard combines blue, red, and green signals modulated as an AM signal with an FM signal for audio.
Progressive Scan	In Progressive Scanning all the horizontal scan lines are scanned on to the screen at one time. The Digital TV and HDTV Standards accept both Interlaced Scan and Progressive Scan broadcast and display methods.
Resolution	Resolution: A measurement of the finest (smallest) detail that is visible in a video image. TV Resolutions may be expressed as number of pixels in an image; or more commonly, As Total Number of (horizontally scanned) Lines used to create the image. Standard Digital TV Resolutions: SDTV: 480i - The picture is 704x480 pixels, 480p - The picture is 704x480 pixels. HDTV: 720p - The picture is 1280x720 pixels, 1080i - The picture is 1920x1080 pixels, 1080p - The picture is 1920x1080 pixels.
SPDIF	SPDIF (Sony and Philips Digital Interconnect Format) is highly recommended for high quality digital sound output.

WARNING concerning stationary images on the TV

Screen: Do not leave fixed images on the screen for extended periods of time. This can cause uneven aging of the LCD panel. Normal use of the TV should involve viewing of programs that have constantly moving or changing images. Do not leave moving images on screen for extended periods of time. Do not display the same images too frequently; if you do, subtle "ghost" images can be left on the LCD screen. Sources of stationary images may be Laser discs, video games, Compact Discs Interactive (CD-i), paused Digital Video Discs (DVDs) or video tapes.

Here are some common examples of stationary images:

- DVD menus list DVD content.
- Letter box black bars that appear at the top and bottom of the TV screen when a wide screen (16:9) movie is viewed on a TV with standard (4:3) aspect ratio. This occurs with some DVDs.
- Video game images and scoreboards
- Television station logos cause a problem if they are bright and stationary. Moving or low-contrast graphics are less likely to damage the picture tube.
- Stock market tickers may appear at the bottom of the TV screen if the TV programming covers this news.
- Shopping channel logos, pricing displays may be bright and may appear constantly during the show. These usually appear in the same location on the TV screen.

TV Location

- To avoid cabinet warping, cabinet color changes, and an increased chance of TV failure, do not place the TV where temperatures can become excessively hot -- for example, in direct sunlight or near a heating appliance.
- Allow a free flow of air around the TV.

Cleaning

- To avoid possible shock hazard, remove the TV's power cord from the electrical outlet before cleaning.
- Regularly dust the TV with a dry, non-scratching duster.
- When cleaning the TV, take care not to scratch or damage the screen surface. Avoid wearing jewelry or using anything abrasive. Do not use household cleaners. Wipe the screen with a clean cloth dampened with water. Use even, easy, vertical strokes when cleaning.
- Occasionally vacuum the vents on the rear of the TV.
- Never use thinners, insecticide sprays, or other chemicals on or near the cabinet. They may permanently blemish the cabinet.

FEDERAL COMMUNICATIONS COMMISSION (FCC) NOTICE (U.S. ONLY)



This equipment has been tested and found to comply with the limits for a Class B digital device, pursuant to Part 15 of the FCC Rules. These limits are designed to provide reasonable protection against harmful interference in a residential installation. This equipment generates, uses and can radiate radio frequency energy and, if not installed and used in accordance with the instructions, may cause harmful interference to radio communications. However, there is no guarantee that interference will not occur in a particular installation. If this equipment does cause harmful interference to radio or television reception, which can be determined by turning the equipment off and on, the user is encouraged to try to correct the interference by one or more of the following measures:

- Reorient or relocate the receiving antenna.
- Increase the separation between the equipment and receiver.
- Connect the equipment into an outlet on a circuit different from that to which the receiver is connected.
- Consult the dealer or an experienced radio/TV technician for help.



Changes or modifications not expressly approved by the party responsible for compliance could void the user's authority to operate the equipment.

To prevent damage which may result in fire or shock hazard, do not expose this appliance to rain or excessive moisture.

THIS CLASS B DIGITAL APPARATUS MEETS ALL REQUIREMENTS OF THE CANADIAN INTERFERENCE-CAUSING EQUIPMENT REGULATIONS.

FCC Declaration of Conformity

Trade Name: Magnavox
Responsible Party: Philips Consumer Electronics North America
P.O. Box 671539
Marietta, GA 30006-0026
1-888-PHILIPS (744-5477)

Declaration of Conformity for Products Marked with FCC Logo, United States Only



This device complies with Part 15 of the FCC Rules. Operation is subject to the following two conditions: (1) this device may not cause harmful interference, and (2) this device must accept any interference received, including interference that may cause undesired operation.

Regulatory Notices-Federal Communications Commission Notice

This equipment has been tested and found to comply with the limits for a Class B digital device, pursuant to part 15 of the FCC Rules. These limits are designed to provide reasonable protection against harmful interference in a residential installation. This equipment generates, uses, and can radiate radio frequency energy and, if not installed and used in accordance with the instructions, may cause harmful interference to radio communications. However, there is no guarantee that interference will not occur in a particular installation. If this equipment does cause harmful interference to radio or television reception, which can be determined by turning the equipment off and on, the user is encouraged to try to correct the interference by one or more of the following measures:
Reorient or relocate the receiving antenna. Increase the separation between the equipment and the receiver.

Connect the equipment into an outlet on a circuit different from that to which the receiver is connected.
Consult the dealer or an experienced radio or television technician for help.

Modifications-

The FCC requires the user to be notified that any changes or modifications made to this device that are not expressly approved by Magnavox Consumer Electronics may void the user's authority to operate the equipment.

Cables -

Connections to this device must be made with shielded cables with metallic RFI/EMI connector hoods to maintain compliance with FCC Rules and Regulations.

Canadian notice -

This Class B digital apparatus meets all requirements of the Canadian Interference-Causing Equipment Regulations.

Avis Canadien -

Cet appareil numérique de la classe B respecte toutes les exigences du Règlement sur le matériel brouilleur du Canada.

Specification - TV

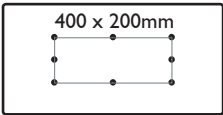
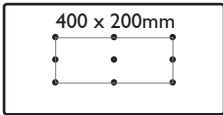
	37MF337B	37MF437B	42MF337B	42MF437B
PICTURE/ DISPLAY Aspect ratio Picture Enhancement	Widescreen Progressive Scan, 3D comb filter, Noise Reduction, Smart Picture (5 modes): Personal, Rich, Natural, Soft, Power saver			
SOUND Output Power (RMS) Sound Enhancement Sound Mode	2x10W Mono, Stereo, Virtual Surround Smart Sound (3 modes): Personal, Speech, Movies			
CONVENIENCE	Auto Program, Closed Captioning Full Text, Sleptimer, Clock			
ON SCREEN DISPLAY LANGUAGE	English, French, Spanish			
CONNECTIVITY Bottom	75Ω / RF AVI-Component Video (YPbPr), Audio L/R input AV2-Component Video (YPbPr), Audio L/R input AV3-Composite Video (Video In), S-Video, Audio L/R input SPDIF output (Digital Only) PC- VGA, Audio HDMI 1, HDMI 2 AC In			
Side	Side AV- Earphone, Composite Video (Video In), S-Video, Audio L/R input			
WEIGHT & DIMENSIONS: Weight (incl. Packaging): Weight (excl. Packaging): Carton Dimension (WxHxD): Product Dimension (WxHxD)	31 kg / 68.2 lbs 25.03 kg / 55.1 lbs 1124 x 682 x 328 mm 44.25" x 26.85" x 12.91"	33 kg / 72.6 lbs 26.62 kg / 58.56 lbs 1124 x 682 x 328 mm 44.25" x 26.85" x 12.91"	33.8 kg / 74.36 lbs 28 kg / 61.6 lbs 1171 x 742 x 347 mm 46.10" x 29.21" x 13.66"	37.8 kg / 83.16 lbs 32 kg / 70.4 lbs 1171 x 742 x 347 mm 46.10" x 29.21" x 13.66"
POWER: Power Consumption: Standby Power Consumption: Mains Power:	175W <1W 100-240V, 60-50Hz	185W <1W 100-240V, 60-50Hz	250W <1W 100-240V, 60-50Hz	260W <1W 100-240V, 60-50Hz
WALL MOUNT:				
	Metric 6 (10mm) screws are needed for wall mounting (not included).		Metric 6 (10mm) screws are needed for wall mounting (not included).	

MAGNAVOX LIMITED WARRANTY

NINETY (90) DAY LABOR / ONE (1) PARTS

WARRANTY COVERAGE:

MAGNAVOX warranty obligation is limited to the terms set forth below.

WHO IS COVERED:

Magnavox warrants the product to the original purchaser or the person receiving the product as a gift against defects in materials and workmanship as based on the date of original purchase ("Warranty Period") from an Authorized Dealer. The original sales receipt showing the product name and the purchase date from an authorized retailer is considered such proof.

WHAT IS COVERED:

The Magnavox warranty covers new products if a defect arises and a valid claim is received by Magnavox within the Warranty Period. At its option, Magnavox will either (1) repair the product at no charge, using new or refurbished replacement parts, or (2) exchange the product with a product that is new or which has been manufactured from new, or serviceable used parts and is at least functionally equivalent or most comparable to the original product in Magnavox current inventory, or (3) refund the original purchase price of the product.

Magnavox warrants replacement products or parts provided under this warranty against defects in materials and workmanship from the date of the replacement or repair for ninety (90) days or for the remaining portion of the original product's warranty, whichever provides longer coverage for you. When a product or part is exchanged, any replacement item becomes your property and the replaced item becomes Magnavox' property. When a refund is given, your product becomes Magnavox' property.

Note: Any product sold and identified as refurbished or renewed carries a ninety (90) day limited warranty.

Replacement product can only be sent if all warranty requirements are met. Failure to follow all requirements can result in delay.

WHAT IS NOT COVERED - EXCLUSIONS AND LIMITATIONS:

This Limited Warranty applies only to the new products manufactured by or for Magnavox that can be identified by the trademark, trade name, or logo affixed to it. This Limited Warranty does not apply to any non-Magnavox hardware product or any software, even if packaged or sold with the product. Non-Magnavox manufacturers, suppliers, or publishers may provide a separate warranty for their own products packaged with the bundled product.

Magnavox is not liable for any damage to or loss of any programs, data, or other information stored on any media contained within the product, or any non-Magnavox product or part not covered by this warranty. Recovery or reinstallation of programs, data or other information is not covered under this Limited Warranty.

This warranty does not apply (a) to damage caused by accident, abuse, misuse, misapplication, or non-Magnavox product, (b) to damage caused by service performed by anyone other than Magnavox or Magnavox Authorized Service Location, (c) to a product or a part that has been modified without the written permission of Magnavox, or (d) if any Magnavox serial number has been removed or defaced, or (e) product, accessories or consumables sold "AS IS" without warranty of any kind by including refurbished Magnavox product sold "AS IS" by some retailers.

This Limited Warranty does not cover:

- Shipping charges to return defective product to Magnavox or repair of products damaged by these modifications.
- Labor charges for installation or setup of the product, adjustment of customer controls on the product, and installation or repair of antenna systems outside of the product.
- Product repair and/or part replacement because of improper installation, connections to improper voltage supply, abuse, neglect, misuse, accident, unauthorized repair or other cause not within the control of Magnavox.
- Damage or claims for products not being available for use, or for lost data or lost software.
- Damage occurring to product during shipping.
- A product that requires modification or adaptation to enable it to operate in any country other than the country for which it was designed, manufactured, approved and/or authorized, or repair of products damaged by these modifications.
- A product used for commercial or institutional purposes (including but not limited to rental purposes).
- Product lost in shipment and no signature verification receipt can be provided.
- Failure to operate per Owner's Manual.

TO OBTAIN WARRANTY SERVICE IN THE U.S.A., PUERTO RICO, OR U.S. VIRGIN ISLANDS...

Contact Magnavox Customer Care Center at:
1-800-705-2000

TO OBTAIN WARRANTY SERVICE IN CANADA...

1-800-661-6162 (French Speaking)
1-800-705-2000 (English or Spanish Speaking)

REPAIR OR REPLACEMENT AS PROVIDED UNDER THIS WARRANTY IS THE EXCLUSIVE REMEDY FOR THE CONSUMER. MAGNAVOX SHALL NOT BE LIABLE FOR ANY INCIDENTAL OR CONSEQUENTIAL DAMAGES FOR BREACH OF ANY EXPRESS OR IMPLIED WARRANTY ON THIS PRODUCT. EXCEPT TO THE EXTENT PROHIBITED BY APPLICABLE LAW, ANY IMPLIED WARRANTY OF MERCHANTABILITY OR FITNESS FOR A PARTICULAR PURPOSE ON THIS PRODUCT IS LIMITED IN DURATION TO THE DURATION OF THIS WARRANTY.

Some states do not allow the exclusions or limitation of incidental or consequential damages, or allow limitations on how long an implied warranty lasts, so the above limitations or exclusions may not apply to you.

This warranty gives you specific legal rights. You may have other rights which vary from state/province to state/province.

Magnavox, P.O. Box 671539, Marietta, Ga. 30006-0026

Download from www.Somanuals.com All Manuals Search And Download.

(Warranty: 3121 233 48931)

Free Manuals Download Website

<http://myh66.com>

<http://usermanuals.us>

<http://www.somanuals.com>

<http://www.4manuals.cc>

<http://www.manual-lib.com>

<http://www.404manual.com>

<http://www.luxmanual.com>

<http://aubethermostatmanual.com>

Golf course search by state

<http://golfingnear.com>

Email search by domain

<http://emailbydomain.com>

Auto manuals search

<http://auto.somanuals.com>

TV manuals search

<http://tv.somanuals.com>