

User guide

MAGNAVOX
SMART. VERY SMART.

MPD8710 Portable DVD Player

STOP!

Thank you for choosing
Magnavox.

Need help fast?

Read your Quick Start Guide and/or
User Manual first for quick tips
that make using your Magnavox product
more enjoyable.

If you have read your instructions
and still need assistance,
you may access our online help at
www.magnavox.com/lusasupport

ARRÊT!

Magnavox vous remercie de
votre confiance.

**Besoin d'une aide
rapide?**

Le Guide rapide de début et
Manuel de l'utilisateur regorgent
d'astuces destinées à simplifier
l'utilisation de votre produit Magnavox.

Toutefois, si vous ne parvenez
pas à résoudre votre problème,
vous pouvez accéder à
notre aide en ligne à l'adresse
www.magnavox.com/lusasupport

ALTO!

Gracias por escoger Magnavox.

**Necesita ayuda
inmediata?**

Lea primero la Guía rápida del
comienzo o el Manual del usuario,
en donde encontrará consejos que
le ayudarán a disfrutar plenamente
de su producto Magnavox.

Si después de leerlo aún necesita ayuda,
consulte nuestro servicio de
asistencia en línea en
www.magnavox.com/lusasupport



EN	User manual	5
ES	Manual del usuario	39
FR	Mode d'emploi	77

Return your Product Registration Card or register online at
www.magnavox.com/usasupport today to get the very most from your purchase.

Registering your model with MAGNAVOX makes you eligible for all of the valuable benefits listed below, so don't miss out. Complete and return your Product Registration Card at once, or register online at www.magnavox.com/usasupport to ensure:

*Proof of Purchase

Returning the enclosed card guarantees that your date of purchase will be on file, so no additional paperwork will be required from you to obtain warranty service.

*Product Safety Notification

By registering your product, you'll receive notification - directly from the manufacturer - in the rare case of a product recall or safety defect.

*Additional Benefits

Registering your product guarantees that you'll receive all of the privileges to which you're entitled, including special money-saving offers.

MAGNAVOX

Congratulations on your purchase, and welcome to the "family!"

Dear MAGNAVOX product owner:

Thank you for your confidence in MAGNAVOX. You've selected one of the best-built, best-backed products available today. We'll do everything in our power to keep you happy with your purchase for many years to come.

As a member of the MAGNAVOX "family," you're entitled to protection by one of the most comprehensive warranties and outstanding service networks in the industry. What's more, your purchase guarantees you'll receive all the information and special offers for which you qualify, plus easy access to accessories from our convenient home shopping network.

Most importantly, you can count on our uncompromising commitment to your total satisfaction.

All of this is our way of saying welcome - and thanks for investing in a MAGNAVOX product.

P.S. To get the most from your MAGNAVOX purchase' be sure to complete and return your Product Registration Card at once, or register online at:
www.magnavox.com/usasupport

Know these safety symbols



⚡ This "bolt of lightning" indicates un-insulated material within your unit may cause an electrical shock. For the safety of everyone in your household, please do not remove product covering.

⚠ The "exclamation point" calls attention to features for which you should read the enclosed literature closely to prevent operating and maintenance problems.

WARNING: To reduce the risk of fire or electric shock, this apparatus should not be exposed to rain or moisture and objects filled with liquids, such as vases, should not be placed on this apparatus.

CAUTION: To prevent electric shock, match wide blade of plug to wide slot, fully insert.

ATTENTION: Pour éviter les choc électriques, introduire la lame la plus large de la fiche dans la borne correspondante de la prise et pousser jusqu'au fond.

For Customer Use

Enter below the Serial No. which is located on the rear of the cabinet. Retain this information for future reference.

Model No. _____

Serial No. _____

MAGNAVOX

Visit our World Wide Web Site at <http://www.magnavox.com/usasupport>

MAGNAVOX LIMITED WARRANTY NINETY (90) DAY

WARRANTY COVERAGE:

MAGNAVOX warranty obligation is limited to the terms set forth below.

WHO IS COVERED:

Magnavox warrants the product to the original purchaser or the person receiving the product as a gift against defects in materials and workmanship as based on the date of original purchase ("Warranty Period") from an Authorized Dealer. The original sales receipt showing the product name and the purchase date from an authorized retailer is considered such proof.

WHAT IS COVERED:

The Magnavox warranty covers new products if a defect in material or workmanship occurs and a valid claim is received by Magnavox within the Warranty Period. At its option, Magnavox will either (1) repair the product at no charge, using new or refurbished replacement parts, or (2) exchange the product with a product that is new or which has been manufactured from new, or serviceable used parts and is at least functionally equivalent or most comparable to the original product in Magnavox current inventory, or (3) refund the original purchase price of the product.

Magnavox warrants replacement products or parts provided under this warranty against defects in materials and workmanship from the date of the replacement or repair for ninety (90) days or for the remaining portion of the original product's warranty, whichever provides longer coverage for you. When a product or part is exchanged, any replacement item becomes your property and the replaced item becomes Magnavox property. When a refund is given, your product becomes Magnavox property.

Note: Any product sold and identified as refurbished or renewed carries a ninety (90) day limited warranty.

Replacement product can only be sent if all warranty requirements are met. Failure to follow all requirements can result in delay.

WHAT IS NOT COVERED - EXCLUSIONS AND LIMITATIONS:

This Limited Warranty applies only to the new products manufactured by or for Magnavox that can be identified by the trademark, trade name, or logo affixed to it. This Limited Warranty does not apply to any non-Magnavox hardware product or any software, even if packaged or sold with the product. Non-Magnavox manufacturers, suppliers, or publishers may provide a separate warranty for their own products packaged with the bundled product.

Magnavox is not liable for any damage to or loss of any programs, data, or other information stored on any media contained within the product, or any non-Magnavox product or part not covered by this warranty. Recovery or reinstallation of programs, data or other information is not covered under this Limited Warranty.

This warranty does not apply (a) to damage caused by accident, abuse, misuse, neglect, misapplication, or non-Magnavox product, (b) to damage caused by service performed by anyone other than

Magnavox or Magnavox Authorized Service Location, (c) to a product or a part that has been modified without the written permission of Magnavox, or (d) if any Magnavox serial number has been removed or defaced, or (e) product, accessories or consumables sold "AS IS" without warranty of any kind by including refurbished Magnavox product sold "AS IS" by some retailers.

This Limited Warranty does not cover:

- Shipping charges to return defective product to Magnavox.
- Labor charges for installation or setup of the product, adjustment of customer controls on the product, and installation or repair of antenna/signal source systems outside of the product.
- Product repair and/or part replacement because of improper installation or maintenance, connections to improper voltage supply, power line surge, lightning damage, retained images or screen markings resulting from viewing fixed stationary content for extended periods, product cosmetic appearance items due to normal wear and tear, unauthorized repair or other cause not within the control of Magnavox.
- Damage or claims for products not being available for use, or for lost data or lost software.
- Damage from mishandled shipments or transit accidents when returning product to Magnavox.
- A product that requires modification or adaptation to enable it to operate in any country other than the country for which it was designed, manufactured, approved and/or authorized, or repair of products damaged by these modifications.
- A product used for commercial or institutional purposes (including but not limited to rental purposes).
- Product lost in shipment and no signature verification receipt can be provided.
- Failure to operate per Owner's Manual.

TO OBTAIN ASSISTANCE IN THE U.S.A., PUERTO RICO, OR U.S. VIRGIN ISLANDS...

Contact Magnavox Customer Care Center at:
1-800-705-2000

TO OBTAIN ASSISTANCE IN CANADA...

1-800-661-6162 (French Speaking)
1-800-705-2000 (English or Spanish Speaking)

REPAIR OR REPLACEMENT AS PROVIDED UNDER THIS WARRANTY IS THE EXCLUSIVE REMEDY FOR THE CONSUMER. MAGNAVOX SHALL NOT BE LIABLE FOR ANY INCIDENTAL OR CONSEQUENTIAL DAMAGES FOR BREACH OF ANY EXPRESS OR IMPLIED WARRANTY ON THIS PRODUCT. EXCEPT TO THE EXTENT PROHIBITED BY APPLICABLE LAW, ANY IMPLIED WARRANTY OF MERCHANTABILITY OR FITNESS FOR A PARTICULAR PURPOSE ON THIS PRODUCT IS LIMITED IN DURATION TO THE DURATION OF THIS WARRANTY.

Some states do not allow the exclusions or limitation of incidental or consequential damages, or allow limitations on how long an implied warranty lasts, so the above limitations or exclusions may not apply to you.

This warranty gives you specific legal rights. You may have other rights which vary from state/province to state/province.

Magnavox, P.O. Box 671539, Marietta, GA. 30006-0026

3121 233 48912

Contents

1 Important	9
Important safety instructions	9
Notice	13

2 Your portable DVD player	15
Introduction	15
What's in the box	16
Overview of the main unit	16
Overview of the remote control	19

3 Get started	22
Charge the battery	22
Install remote control battery	23
Connect headphones	24
Connect additional equipment	24
Select OSD language	25

4 Use your player	26
Turn on	26
Play discs	26
Adjust volume	26
Play options	27

5 Adjust settings	30
Select language options	30
Select video options	30
Select audio options	32

Select play preferences	33
Select JPEG play options	35

6 Troubleshooting	36
--------------------------	----

7 Product information	38
------------------------------	----

1 Important

Important safety instructions

Know these safety symbols



This 'bolt of lightning' indicates uninsulated material within your unit may cause an electrical shock. For the safety of everyone in your household, please do not remove product covering.

The 'exclamation point' calls attention to features for which you should read the enclosed literature closely to prevent operating and maintenance problems.

WARNING: To reduce the risk of fire or electric shock, this apparatus should not be exposed to rain or moisture and objects filled with liquids, such as vases, should not be placed on this apparatus.

CAUTION: To prevent electric shock, match wide blade of plug to wide slot, fully insert.

- ① Read these instructions.
- ② Keep these instructions.
- ③ Heed all warnings.
- ④ Follow all instructions.
- ⑤ Do not use this apparatus near water.

- ⑥ Clean only with dry cloth.
- ⑦ Do not block any ventilation openings. Install in accordance with the manufacturer's instructions.
- ⑧ Do not install near any heat sources such as radiators, heat registers, stoves, or other apparatus (including amplifiers) that produce heat.
- ⑨ Do not defeat the safety purpose of the polarized or grounding-type plug. A polarized plug has two blades with one wider than the other. A grounding type plug has two blades and a third grounding prong. The wide blade or the third prong are provided for your safety. If the provided plug does not fit into your outlet, consult an electrician for replacement of the obsolete outlet.
- ⑩ Protect the power cord from being walked on or pinched, particularly at plugs, convenience receptacles, and the point where they exit from the apparatus.
- ⑪ Only use attachments/accessories specified by the manufacturer.
- ⑫ Use only with the cart, stand, tripod, bracket, or table specified by the manufacturer or sold with the apparatus. When a cart is used, use caution when moving the cart/ apparatus combination to avoid injury from tip-over.



- ⑬ Unplug this apparatus during lightning storms or when unused for long periods of time.

- ⑭ Refer all servicing to qualified service personnel. Servicing is required when the apparatus has been damaged in any way, such as power-supply cord or plug is damaged, liquid has been spilled or objects have fallen into the apparatus, the apparatus has been exposed to rain or moisture, does not operate normally, or has been dropped.
- ⑮ Battery usage **CAUTION** – To prevent battery leakage which may result in bodily injury, property damage, or damage to the unit:
- Install all batteries correctly, + and - as marked on the unit.
 - Do not mix batteries (old and new or carbon and alkaline, etc.).
 - Remove batteries when the unit is not used for a long time.
- ⑯ Apparatus shall not be exposed to dripping or splashing.
- ⑰ Do not place any sources of danger on the apparatus (e.g. liquid filled objects, lighted candles).
- ⑱ This product may contain lead and mercury. Disposal of these materials may be regulated due to environmental considerations. For disposal or recycling information, please contact your local authorities or the Electronic Industries Alliance: www.eiae.org.



Warning

- Never remove the casing of this player.
- Never lubricate any part of this player.
- Never place this player on other electrical equipment.
- Keep this player away from direct sunlight, naked flames or heat.
- Never look into the laser beam inside the player.
- Ensure that you always have easy access to the power cord, plug or adaptor to disconnect the player from the power.

Hearing Safety

Listen at a moderate volume.

- Using headphones at a high volume can impair your hearing. This product can produce sounds in decibel ranges that may cause hearing loss for a normal person, even for exposure less than a minute. The higher decibel ranges are offered for those that may have already experienced some hearing loss.
- Sound can be deceiving. Over time your hearing "comfort level" adapts to higher volumes of sound. So after prolonged listening, what sounds "normal" can actually be loud and harmful to your hearing. To guard against this, set your volume to a safe level before your hearing adapts and leave it there.

To establish a safe volume level:

- Set your volume control at a low setting.
- Slowly increase the sound until you can hear it comfortably and clearly, without distortion.

Listen for reasonable periods of time:

- Prolonged exposure to sound, even at normally "safe" levels, can also cause hearing loss.
- Be sure to use your equipment reasonably and take appropriate breaks.
-

Be sure to observe the following guidelines when using your headphones.

- Listen at reasonable volumes for reasonable periods of time.
- Be careful not to adjust the volume as your hearing adapts.
- Do not turn up the volume so high that you can't hear what's around you.
- You should use caution or temporarily discontinue use in potentially hazardous situations.
- Do not use headphones while operating a motorized vehicle, cycling, skateboarding, etc.; it may create a traffic hazard and is illegal in many areas.

Notice

Notice of compliance

The set complies with the FCC-Rules, Part 15 and with 21 CFR 1040.10. Operation is subject to the following two conditions:

1. This device may not cause harmful interference, and
2. This device must accept any interference received, including interference that may cause undesired operation.

Canada

English:

This digital apparatus does not exceed the Class B limits for radio noise emissions from digital apparatus as set out in the Radio Interference Regulations of the Canadian Department of Communications. This Class B digital apparatus complies with Canadian ICES-003.

Français:

Cet appareil numérique n'émet pas de bruits radioélectriques dépassant les limites applicables aux appareils numériques de Classe

B prescrites dans le Règlement sur le Brouillage Radioélectrique édicté par le Ministère des Communications du Canada. Cet appareil numérique de la classe B est conforme à la norme NMB-003 du Canada.

Environmental information

All unnecessary packaging has been omitted. We have tried to make the packaging easy to separate into three materials: cardboard (box), polystyrene foam (buffer) and polyethylene (bags, protective foam sheet.) Your system consists of materials which can be recycled and reused if disassembled by a specialized company. Please observe the local regulations regarding the disposal of packaging materials, exhausted batteries and old equipment.



The making of unauthorized copies of copy-protected material, including computer programs, files, broadcasts and sound recordings, may be an infringement of copyrights and constitute a criminal offence. This equipment should not be used for such purposes.



Manufactured under license from Dolby Laboratories. 'Dolby' and the double D symbol  are trademarks of Dolby Laboratories.

This player includes this label:



Use of controls or adjustments or performance of procedures other than herein may result in hazardous radiation exposure or other unsafe operation.





2 Your portable DVD player

Introduction

Your portable DVD player plays digital video discs conforming to the universal DVD Video standard. With it, you can play movies with true cinema picture quality, and stereo or multichannel sound (depending on the disc and your playback set-up).

You can also select sound track, subtitle languages, and different angle of view (again depending on DVD disc). Besides, you can set parental control to prevent your children to see certain discs.

You can play the following discs on the DVD player (including CD-R, CD-RW, DVD±R and DVD±RW):

	DVD-Video
	Video CD
	Super video CD
	Audio CD
	MP3 CD
	Discs with JPEG files

What's in the box

Check and identify the contents of your package:

- Portable DVD player
- Remote control
- Battery for remote control
- AC power adaptor; ADS-12G-06 05712GPCU/ADS-12a-bc xyz (Shenzhen Honor Electronic Co., Ltd.)
- AV cables
- User Manual
- Quick Start Guide

Overview of the main unit

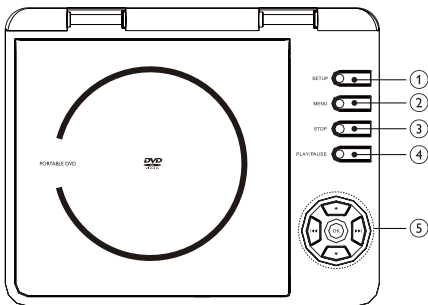

① SETUP

- Access or exit the setup menu.

② MENU

- For DVD, access or exit disc root menu.
- For VCD/SVCD, turn on or off PBC (Playback control) mode.

③ STOP

- Stop disc play.

④ PLAY/PAUSE

- Start or pause disc play.

⑤ ▲, ▼, ◀, ▶

- Move cursor up/down/left/right.

◀◀, ▶▶

- Press to skip to the previous or next title/chapter/track.
- Press and hold for fast backward or forward search.

OK

- Confirm an entry or selection.

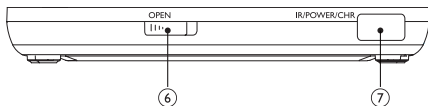

⑥ OPEN

- Open the disc compartment.

⑦ IR/POWER/CHR

- Remote sensor/power and charge indicator.

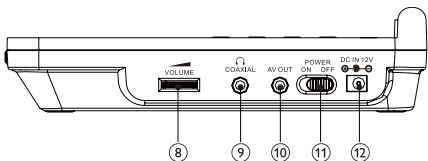

⑧ VOL ▽

- Adjust the volume level.

- ⑨  **COAXIAL**
 - Connect headphones.
 - For coaxial output.

- ⑩ **AV OUT**
 - Audio/Video output.

- ⑪ **POWER ON/OFF**
 - Turn DVD player on/off.

- ⑫ **DC IN 12V**
 - Power supply socket.

Overview of the remote control

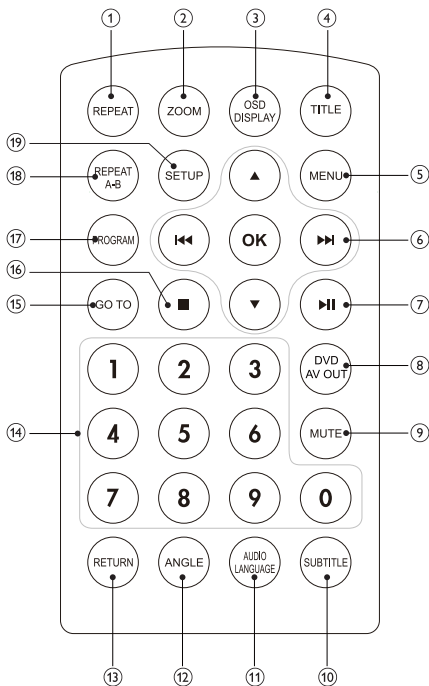

- ① **REPEAT**
- Repeat a chapter/track/title.
- ② **ZOOM**
- Zoom in or out.

③ **OSD DISPLAY**

- Display play information.

④ **TITLE**

- Access or exit disc title menu.

⑤ **MENU**

- For DVD, access or exit disc root menu.
- For VCD/SVCD, turn on or off PBC (Playback control) mode.

⑥ ▲, ▼, ◀, ▶

- Move cursor up/down/left/right.

◀◀, ▶▶

- Press to skip to previous/next chapter, track or title.
- Press and hold for fast backward or forward search.

OK

- Confirm an entry or selection.

⑦ ▶||

- Start or pause disc play.

⑧ **DVD AV OUT**

- Switch between **[TV Mode (PAL)]**, **[Dual Screen (NTSC)]** and **[AV OUT OFF]**.

⑨ **MUTE**

- Mute or restore the volume.

⑩ **SUBTITLE**

- Select DVD subtitle language.

⑪ **AUDIO LANGUAGE**

- Select an audio language when you play a DVD or select an audio mode when playing a VCD.

- ⑫ **ANGLE**
 - Select a different viewing angle of a DVD.
- ⑬ **RETURN**
 - Return to the previous menu.
- ⑭ **Numeric Keypad 0 - 9**
 - Input numbers.
- ⑮ **GOTO**
 - Skip to a chapter/track/title or play time.
- ⑯ **■**
 - Stop disc play.
- ⑰ **PROGRAM**
 - Access or exit the program menu.
- ⑱ **REPEAT A-B**
 - Mark the section for repeat play.
- ⑲ **SETUP**
 - Access or exit the setup menu.

3 Get started

If you contact Magnavox, you will be asked for the model and serial numbers. Find the model number and serial number of this player at the back or the bottom of your player. Write these numbers here:

Model No. _____

Serial No. _____

Charge the battery



Caution

- Risk of product damage! Ensure that the power supply voltage corresponds to the voltage printed on the back or the underside of the player.
- Use only the supplied AC adaptor to charge the battery.

- 1 Slide the **POWER ON/OFF** switch to **OFF** position.
- 2 Connect the supplied AC adaptor to the player and to the AC outlet.

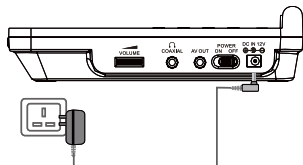

- ↳ The red charge indicator turns on. It takes about 4 hours to fully charge the battery.
- ↳ When the battery is fully charged, the red charge indicator turns off.

**Tip**

- You can only charge the battery when the temperature is between 0°C and 35°C.
- When headphones are connected to the DVD player; the fully charged battery lasts about 2.5 hours.
- To maximize battery life, recharge the battery immediately once the battery is fully discharged.
- When the player is not in use, turn it off.

Install remote control battery

**Caution**

- Risk of explosion! Keep batteries away from heat, sunshine or fire. Never discard batteries in fire.
- Risk of decreased battery life! Never mix different brands or types of batteries.
- Risk of product damage! When the remote control is not used for long periods, remove the batteries.
- Perchlorate Material - special handling may apply. See www.dtsc.ca.gov/hazardouswaste/perchlorate.

- 1 Open the battery compartment.
- 2 Insert 1 CR2025 battery with correct polarity (+/-) as indicated.
- 3 Close the battery compartment.

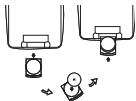

Connect headphones

Plug the headphones into the  jack of the player.

Connect additional equipment

Caution

- Turn off your player before connecting to any additional equipment.

You can connect the player to a TV or an amplifier to enjoy DVDs or Karaoke.

- Connect a TV
Connect AV cable to the TV, white and red ends to “L” and “R” of **AUDIO IN** terminal respectively, and yellow end to **VIDEO IN** terminal.

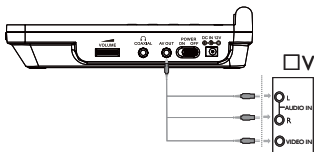

- Connect an amplifier with a Dolby digital stereo system only with the yellow end of AV cable

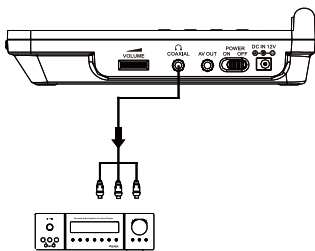

Select OSD language

You can choose a different language for the on-screen display text.

1 Press **SETUP**.

↳ The setup menu is displayed.



2 Select **[Language]** and press **▶▶**.

3 Select **[OSD language]** and press **OK** to select an option.

4 Press **OK** to confirm.

5 Press **SETUP** to exit.

4 Use your player

Turn on

Slide the **POWER ON/OFF** switch to the **ON** position.

↳ The green power indicator turns on.

Play discs

1 Press **OPEN** on the player.

2 Insert the disc with label side facing up.

3 Push down to close the disc compartment.

↳ Play starts automatically. If not, press **OK** or **▶II**.

- If a menu appears, select an item, then press **OK** to start play.
 - To pause, press **PLAY/PAUSE ▶II**. Press again to resume play.
 - To view disc information, press **OSD DISPLAY**.
 - To stop, press **STOP ■** twice.
-

Adjust volume

Adjust the volume control on the right side of the player.



Play options

Skip to a title/track/chapter

- To select the previous/next title, track or chapter, press **⏮** or **⏭**.
- To skip directly to any title/track/chapter, enter the corresponding number with the numerical keys (0-9) or press **GOTO**, then press **OK**.

Search

- To start search within video/audio, press and hold **⏭** or **⏮**. Briefly press **⏮** or **⏭** during search to select a search speed.
- Press **⏸** or **OK** to resume normal play.

Select audio language

For DVDs that contain two or more audio languages.

- During play, press **AUDIO LANGUAGE** repeatedly until the language is selected.

Repeat

- During play, press **REPEAT** repeatedly to select the following repeat options:

For **DVD**

- **[Repeat Chapter]**
- **[Repeat Title]**
- **[Off]**

For **CD/VCD/SVCD**

- **[Repeat Single]**

- [Repeat All] (entire disc)

- [Off]

For JPEG/MP3

- [Repeat Single]
- [Repeat All] (current folder)
- [Off]



Tip

- For VCD/SVCD, if PBC is on, you cannot repeat items.

Repeat a section

You can repeat a specific section of audio/video within a title/ chapter/track (repeat A-B).

1 During play, at the chosen start point, press **REPEAT A-B**.

2 At the chosen end point, press **REPEAT A-B** again.

↳ The selected section plays repeatedly.

3 Press **REPEAT A-B** to cancel.

Zoom

For DVDs, VCDs and JPEG CDs, you can zoom in and out for video images or pictures.

1 Press **ZOOM** repeatedly to zoom in and out.

2 When the video image or picture is enlarged, press ▲, ▼, ►►, ◀◀ to pan through it.

Select audio mode

When you play VCDs, you can select an audio mode.

Press **AUDIO LANGUAGE** repeatedly to select audio channel: **[Left]**, **[Right]**, **[Mix]** or **[Stereo]**.

Rotate pictures

For JPEG CDs only. While the JPEG is displayed:

- Press **▲** to rotate counter-clockwise.
 - Press **▼** to rotate clockwise.
-

Activate PBC

For VCDs (version 2.0 only) and SVCDs.

1 Press **MENU**.

2 Select **PBC ON**.

↳ The disc menu (if available) appears.

- During playback,
 - Press **⏮** after the first 5 seconds, play starts from the beginning of the current track.
 - Press **⏮** within the first 5 seconds, play goes to the previous track.
 - To return to the menu screen, press **RETURN**.



Tip

- If PBC is on, you cannot use numeric keypad (0-9) to select a track.

5 Adjust settings

Select language options

- 1 Press **SETUP**, then select **[Language]**.
- 2 Press **▶▶**, then select an item.
 - **[OSD language]**: Select on-screen display language.
 - **[Subtitle]**: Select disc subtitle language.
 - **[Audio]**: Select disc audio language.
 - **[DVD menu]**: Select DVD menu language.
- 3 Press **OK**, then select an option.
- 4 Press **OK** to confirm.
- 5 Press **SETUP** to exit.

Select video options

Select display ratio

- 1 Press **SETUP**, then select **[Video]**.
- 2 Press **▶▶**, then select **[Aspect Ratio]**.
- 3 Press **OK**, then select an option:
 - **[4:3]**: The picture is reproduced in 4:3 format. A black band is displayed on either side of the picture.
 - **[Movie expand 16:9]**: The picture is enlarged to 16:9 format. A large part of the top and bottom of the picture is trimmed. Select this when playing pictures which have black band at the top and bottom (letterbox format).

- **[Widescreen]**: The picture is displayed in the original proportion of images transmitted in 16:9 format.

4 Press **OK** to confirm.

5 Press **SETUP** to exit.



Tip

- If you play a 4:3 picture in **Widescreen** mode, it stretches horizontally.

Select view mode

1 Press **SETUP**, then select **[Video]**.

2 Press **▶▶**, then select **[View Mode]**.

3 Press **OK**, then select an option:

- **[Original]**: Fit the original screen size (for JPEG only)
- **[Auto Fit]**: Take the minimum value of horizontal and vertical fit scale ratio (like letter box)
- **[Pan Scan]**: Take the maximum value of horizontal and vertical fit scale ratio.

4 Press **OK** to confirm.

5 Press **SETUP** to exit.

Select picture contrast

1 Press **SETUP**, then select **[Video]**.

2 Press **▶▶**, then select **[Smart Picture]**.

3 Press **OK**, then select an option:

- **[Standard]**: Select the preset picture setting.

- **[Vivid]**: Make the picture brighter.
- **[Cool]**: Make the picture softer.
- **[Personal]**: Personalize your picture color by adjusting brightness, contrast and color.

4 Press **OK** to confirm.

5 Press **SETUP** to exit.

Select audio options

1 Press **SETUP**, then select **[Audio]**.

2 Press **▶▶**, then select **[Digital Output]**.

3 Press **OK**, then select an option:

- **[Off]**: Deactivate the digital audio output.
- **[PCM]**: If the connected device cannot decode multichannel audio. The DVD player converts the Dolby digital and DTS multichannel signals to PCM.
- **[All]**: If the connected device has a built-in multichannel decoder that supports Dolby digital or DTS.

4 Press **OK** to confirm.

5 Press **SETUP** to exit.



Tip

- If you select **[ALL]**, all audio settings except MUTE are invalid.
- If you select **[ALL]**, when playing MPEG & MP3, the player outputs PCM signals.

Select play preferences

Restore original settings

- 1 Press **SETUP**, then select **[Preference]**.
- 2 Press **▶▶**, then select **[Use Default Settings]**.
- 3 Press **OK**.
↳ A confirmation message appears.
- 4 Press **◀◀▶▶** to select an option.
- 5 Press **OK** to confirm.
- 6 Press **SETUP** to exit.

Activate screen saver

For VCD/DVD, if you do not press any buttons five minutes after the play is stopped, screen saver starts automatically.

- 1 Press **SETUP**, then select **[Preference]**.
- 2 Press **▶▶**, then select **[Screen saver]**.
- 3 Press **OK**, then select an option:
 - **[Off]**: Deactivate screen saver.
 - **[On]**: Activate screen saver.
- 4 Press **OK** to confirm.
- 5 Press **SETUP** to exit.

Restrict access

Depending on the DVD, you may be asked to change the parental level while playing the disc. The rating levels are from 1 to 8 and are country dependent. You can prohibit the playing of certain discs that

are not suitable for your children, or have certain discs played with alternative scenes.

- 1 Press **SETUP**, then select **[Preference]**.
- 2 Press **▶▶**, then select **[Parental control]**.
- 3 Press **OK**, then enter the 4-digit password.
- 4 Press **OK**, then select an option:
 - **[1. Kid Safe]**: Childsafe; acceptable for viewers of all ages.
 - **[2. G]**: General Audience; recommended as acceptable for viewers of all ages.
 - **[3. PG]**: Parental Guidance suggested.
 - **[4. PG-13]**: Unsuitable for children under age 13.
 - **[5. PG-R]**: Parental Guidance; recommended that parents restrict children under 17 from viewing.
 - **[6. R]**: Restricted; recommended only when supervised by a parent or adult guardian.
 - **[7. NC-17]**: No Children under age 17; not recommended viewing for children under age 17.
 - **[8. Adult]**: Mature Material; should be viewed only by adults.
- 5 Press **OK** to confirm.
- 6 Press **SETUP** to exit.



Tip

- For how to change the password, see "Change password".

Change password

- 1 Press **SETUP**, then select **[Preference]**.
- 2 Press **▶▶**, then select **[Set Password]**.
- 3 Press **OK**.
- 4 Enter the current password.
 - For the first time, enter 0000 as the password.
- 5 Enter a new 4-digit password, then press **OK** to confirm.
- 6 Press **SETUP** to exit.

Select JPEG play options

You can display JPEG files as a slideshow, where they appear one after another automatically.

- 1 Press **SETUP**, then select **[Slideshow]**.
- 2 Press **▶▶**, then select an item.
 - **[Slideshow]**: Activate/deactivate slideshow.
 - **[Frequency]**: Select intervals for JPEG play.
 - **[Transition]**: Select display mode for JPEG play.
- 3 Press **OK**, then select an option.
- 4 Press **OK** to confirm.
- 5 Press **SETUP** to exit.

6 Troubleshooting

No power

- Ensure that both plugs of the mains cord are properly connected.
- Ensure that there is power at the AC outlet.
- Check if the built-in battery is drained.

Distorted picture

- Clean the disc. With a clean, soft, lint-free cloth, wipe the disc outwards from the center.
- Make sure that the video output format of the disc is compatible with the TV.
- Change the video output format with **DVD AV OUT** to match your TV or program.
- The LCD is manufactured using high precision technology. You may, however, see tiny black points and/or bright points (red, blue, green) that continuously appear on the LCD. This is a normal result of the manufacturing process and does not indicate a malfunction.

No sound

- Ensure that the AV cable is connected correctly.

Cannot play disc

- Ensure the disc label is upwards.
- Clean the disc. With a clean, soft, lint-free cloth, wipe the disc outwards from the center.
- Check if the disc is defective by trying another disc.

No response to the remote control

- Ensure that the path between the remote control and the player is clear from obstacles.
- From a close distance, point the remote control directly at the player.

- Replace the remote control batteries.
- The function does not work for this disc. Refer to the disc instructions.

The player feels warm

- When the player is in use for a long period of time, its surface will be heated. This is normal.

7 Product information



Note

- Product information is subject to change without prior notice.

Dimensions	199 x 159 x 40 mm
Weight	0.66 kg
Power supply	DC 12V 1A
Power consumption	15 W
Operating temperature	5 - 35°C
Laser wavelength	650 nm
Video system	NTSC
Frequency response	20Hz - 20KHz \pm 1 dB
Signal/noise ratio	> 85 dB
Audio distortion	< 0.1%
Load impedance	75 Ω
Humidity	15%-75%

MAGNAVOX

PO. Box 671539, Marietta, GA 30006-0026, U.S.A

Meet Magnavox at the Internet
<http://www.magnavox.com/usasupport>

MPD8710

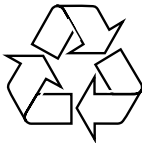

Printed in China PDCC - SY/ZYL - 0830

Download from Www.Somanuals.com. All Manuals Search And Download.

Free Manuals Download Website

<http://myh66.com>

<http://usermanuals.us>

<http://www.somanuals.com>

<http://www.4manuals.cc>

<http://www.manual-lib.com>

<http://www.404manual.com>

<http://www.luxmanual.com>

<http://aubethermostatmanual.com>

Golf course search by state

<http://golfingnear.com>

Email search by domain

<http://emailbydomain.com>

Auto manuals search

<http://auto.somanuals.com>

TV manuals search

<http://tv.somanuals.com>