

8-57-03-633

MAGNAVOX

Smart. Very smart.®

MODEL # TS 2775 CID

MAGNAVOX

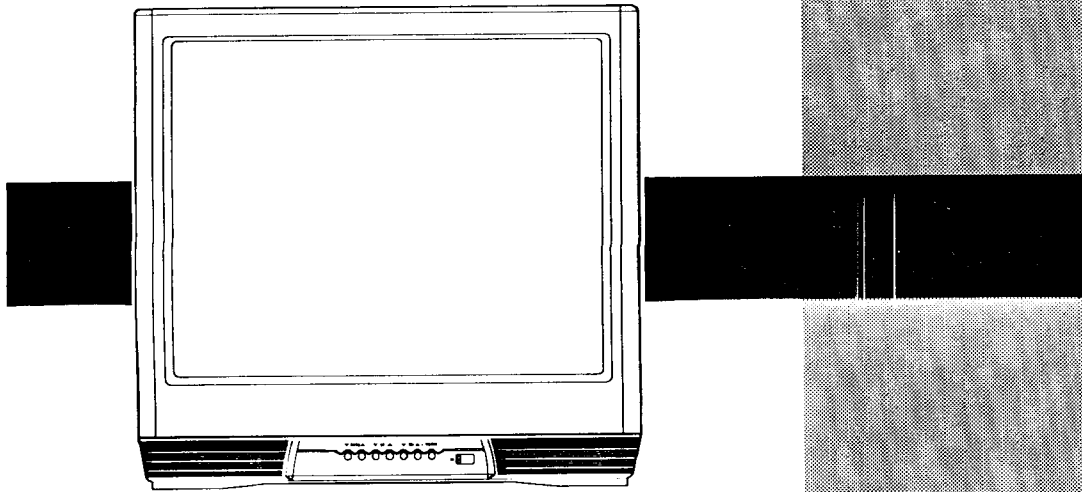

Color Television Owner's Manual

IMPORTANT!
Return Your Warranty Registration Card
Within 10 Days. See Why Inside.

Return your Warranty Registration card today to ensure you receive all the benefits you're entitled to.

Once your MAGNAVOX purchase is registered, you're eligible to receive all the privileges of owning a MAGNAVOX product. So complete and return the Warranty Registration Card enclosed with your purchase at once. And take advantage of these important benefits.

Warranty Verification

Registering your product within 10 days confirms your right to maximum protection under the terms and conditions of your MAGNAVOX warranty.

Owner Confirmation

Your completed Warranty Registration Card serves as verification of ownership in the event of product theft or loss.

Model Registration

Returning your Warranty Registration Card right away guarantees you'll receive all the information and special offers which you qualify for as the owner of your model.

Congratulations on your purchase, and welcome to the "family!"

Dear MAGNAVOX product owner:

Thank you for your confidence in MAGNAVOX. You've selected one of the best-built, best-backed products available today. And we'll do everything in our power to keep you happy with your purchase for many years to come.

As a member of the MAGNAVOX "family," you're entitled to protection by one of the most comprehensive warranties and outstanding service networks in the industry.

What's more, your purchase guarantees you'll receive all the information and special offers for which you qualify, plus easy access to accessories from our convenient home shopping network.

And most importantly you can count on our uncompromising commitment to your total satisfaction.

All of this is our way of saying welcome—and thanks for investing in a MAGNAVOX product.

Sincerely,



Robert Minkhorst
President and Chief Executive Officer

MAGNAVOX
Smart. Very smart.®

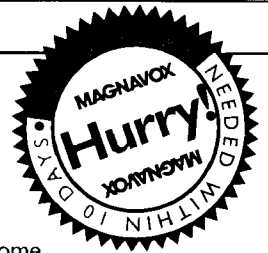

P.S. Remember, to get the most from your MAGNAVOX product, you must return your Warranty Registration Card within 10 days. So please mail it to us right now!

For Customer Use

Enter below the Serial No. which is located on the rear of the cabinet. Retain this information for future reference.

Model No. _____ Serial No. _____

Know these safety symbols

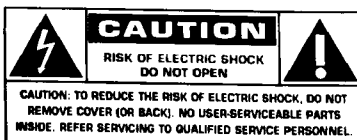

 This "bolt of lightning" indicates uninsulated material within your unit may cause an electrical shock. For the safety of everyone in your household, please do not remove product covering.

 The "exclamation point" calls attention to features for which you should read the enclosed literature closely to prevent operating and maintenance problems.

WARNING: TO PREVENT FIRE OR SHOCK HAZARD, DO NOT EXPOSE THIS EQUIPMENT TO RAIN OR MOISTURE.

CAUTION: To prevent electric shock, match wide blade of plug to wide slot, and fully insert.

ATTENTION: Pour éviter les chocs électriques, introduire la lame la plus large de la fiche dans la borne correspondante de la prise et pousser jusqu'au fond.

Visit our World Wide Web Site at <http://www.magnavox.com>

SAFETY INSTRUCTIONS - Read before operating equipment

This product was designed and manufactured to meet strict quality and safety standards. There are, however, some installation and operation precautions which you should be particularly aware of.

1. **Read Instructions** - All the safety and operating instructions should be read before the appliance is operated.
2. **Retain Instructions** - The safety and operating instructions should be retained for future reference.
3. **Heed Warnings** - All warnings on the appliance and in the operating instructions should be adhered to.
4. **Follow Instructions** - All operating and use instructions should be followed.
5. **Water and Moisture** - The appliance should not be used near water - for example, near a bathtub, washbowl, kitchen sink, laundry tub, in a wet basement or near a swimming pool, etc.
6. **Carts and Stands** - The appliance should be used only with a cart or stand that is recommended by the manufacturer.
- 6A.  An appliance and cart combination should be moved with care. Quick stops, excessive force, and uneven surfaces may cause the appliance and cart combination to overturn.
7. **Wall or Ceiling Mounting** - The appliance should be mounted to a wall or ceiling only as recommended by the manufacturer.
8. **Ventilation** - The appliance should be situated so that its location or position does not interfere with its proper ventilation. For example, the appliance should not be situated on a bed, sofa, rug, or similar surface that may block the ventilation openings; or, placed in a built-in installation, such as a bookcase or cabinet that may impede the flow of air through the ventilation openings.
9. **Heat** - The appliance should be situated away from heat sources such as radiators, heat registers, stoves, or other appliances (including amplifiers) that produce heat.
10. **Power Sources** - The appliance should be connected to a power supply only of the type described in the operating instructions or as marked on the appliance.
11. **Power-Cord Protection** - Power supply cords should be routed so that they are not likely to be walked on or pinched by items placed upon or against them, paying particular attention to cords and plugs, convenience receptacles, and the point where they exit from the appliance.

12. **Cleaning** - The appliance should be cleaned only as recommended by the manufacturer.
13. **Power Lines** - An outdoor antenna should be located away from power lines.
14. **Outdoor Antenna Grounding** - If an outside antenna is connected to the receiver, be sure the antenna system is grounded so as to provide some protection against voltage surges and built up static charges.
Section 810 of the National Electric Code, ANSI/NFPA No. 70-1984, provides information with respect to proper grounding of the mats and supporting structure grounding of the lead-in wire to an antenna discharge unit, size of grounding connectors, location of antenna-discharge unit, connection to grounding electrodes and requirements for the grounding electrode. See Fig. below.
15. **Non-use Periods** - The power cord of the appliance should be unplugged from the outlet when left unused for a long period of time.
16. **Object and Liquid Entry** - Care should be taken so that objects do not fall and liquids are not spilled into the enclosure through openings.
17. **Damage Requiring Service** - The appliance should be serviced by qualified service personnel when:
 - A. The power supply cord or the plug has been damaged; or
 - B. Objects have fallen, or liquid has been spilled into the appliance; or
 - C. The appliance has been exposed to rain; or
 - D. The appliance does not appear to operate normally or exhibits a marked change in performance; or
 - E. The appliance has been dropped, or the enclosure damaged.
18. **Servicing** - The user should not attempt to service the appliance beyond that described in the operating instructions. All other servicing should be referred to qualified service personnel.

Note to the CATV system installer: This reminder is provided to call the CATV system installer's attention to Article 820-40 of the NEC that provides guidelines for proper grounding and, in particular, specifies that the cable ground shall be connected to the grounding system of the building, as close to the point of cable entry as practical.

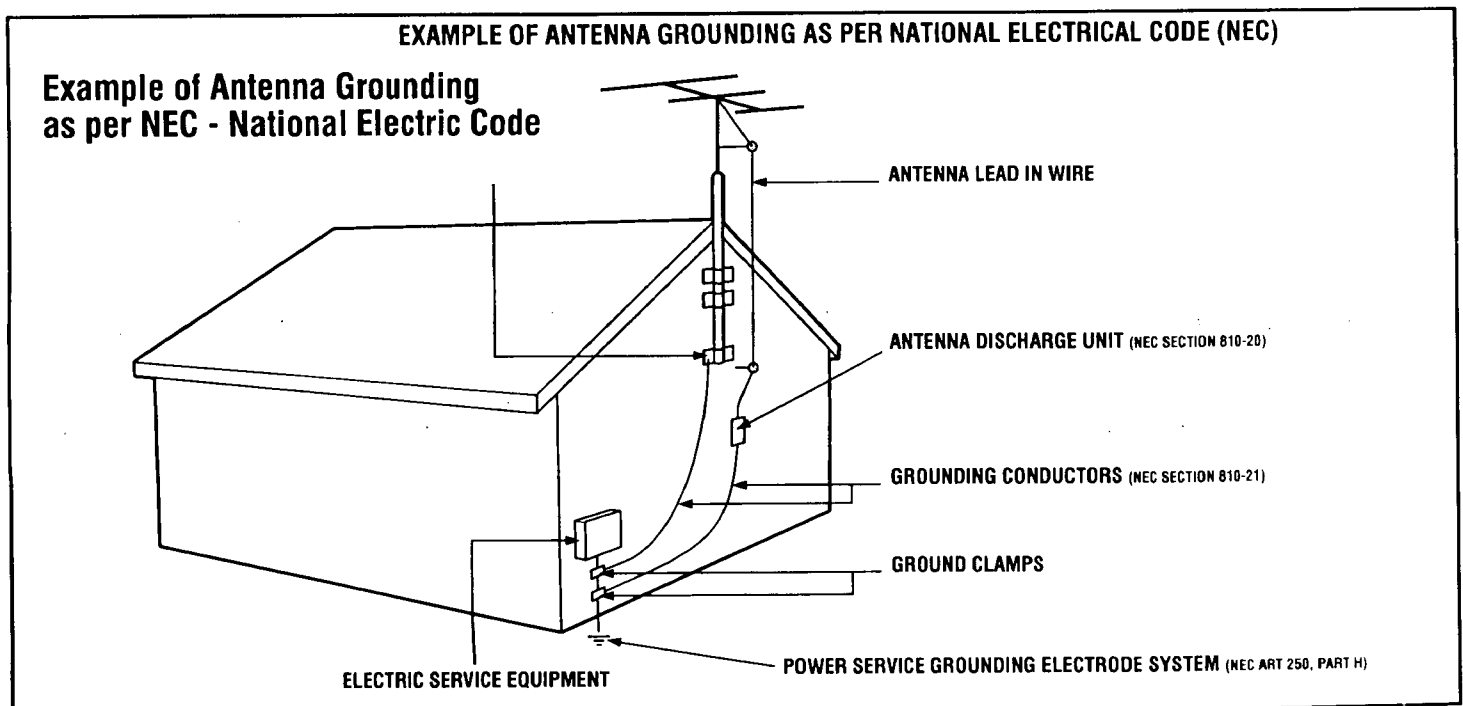

MAC3964

TABLE OF CONTENTS

Introduction

Welcome/Registration of Your TV.....	2
Safety/Precautions	3
Table of Contents.....	4
Features	4
Hooking Up Your TV	5
Basic TV and Remote Control Operation.....	6
How to Use the First Time Set-Up Control	7



On-Screen (MENU) Features

◇ Setting the TV for Cable TV Operation.....	8
◇ Adding Channels in Memory (Automatically) ...	9
◇ Adding Channels in Memory (Manually).....	10
◇ How to Set the TV for Closed Captioning	11
◇ Setting the TV for Stereo Programs.....	12
◇ Using the TV Volume Bar Control.....	13
◇ Using the Sound Image Control	13
◇ Setting the TV Sleep Timer Control	14
◇ Adjusting the TV Picture Controls	15
◇ Using the On-Screen Language Option	15
◇ Using the Audio Out Jacks (with TV Speaker On/Off Control)	16
◇ Using the TV's Audio/Video Input Jacks	17



Remote Control Operation

Using the Remote (TV and VCR).....	18-19
Using Smart Picture Control	20
Using Smart Sound Control.....	20
Using Smart Surf Control and Surf Button.....	21
Setting the TV Remote to Work VCRs	22-23
Setting the TV Remote to Work Cable TV Converters	24-25
Setting the TV Remote to Work VCRs or Cable Converters - Search Method	26



General Information

Tips if Something Isn't Working	27
Glossary of TV Terms	28
Index	28
Factory Service Locations	29-30
Warranty	31
Accessories	32

FEATURES

Infrared Remote Control which works your TV set and a variety of wireless remote control VCRs and Cable Converters.

Standard Broadcast (VHF/UHF) or Cable TV (CATV) channel capability.

Stereo Ready TV with built-in audio amplifier and twin speaker system for receiving TV programs broadcast in stereo sound.

Closed Captioning which allows the viewer to read TV program dialogue or voice conversations as on-screen text.

Automatic Programming of Channels for quick and easy selection of favorite stations available in your area.

On-Screen Features (in either English, French, or Spanish) which show helpful messages for setting of TV controls.

Audio/Video Jackpanel for direct connections with VCRs (or other video accessories) for quality TV picture and sound playback.

Smart Button for the control of TV Sound and Picture levels. Use the Smart Button on the remote to quickly adjust Smart Sound (to keep volume levels consistent during program changes or commercial breaks); Smart Picture (for automatic picture adjustments on a variety of program sources); and Smart Surf (for quick one button channel selection of up to 10 of your favorite channels).

Sleep-Timer which automatically turns the TV OFF at preset times.

Feature Demonstration Mode Preview. Press the Volume ▲ and Channel ▼ buttons on the TV at the same time to begin a series of messages that describe the use and benefit of your TV's features. To cancel the demonstration, press any button on the front of the TV and follow the on-screen instructions.

HOOKING UP YOUR TV

CABLE TV

CABLE INPUT/CONVERTER

Your Cable TV input into your home may be a single (75 ohm) cable, or a Converter Box installation. In either case the connection to the TV is very easy. Just put the threaded end of the cable signal to the TV's antenna plug and screw it down tight.

BEGIN

1 If your Cable TV signal is a single round cable (75 ohm) then you're ready to connect to the TV.
If you have a Cable TV Converter Box: Connect the Cable TV signal to the Cable Signal IN(put) plug on the Converter.

2 Connect Cable TV cable to ANTENNA plug on the TV.
If you have a Converter Box: Connect the OUT(put) plug on the Converter to the ANTENNA plug on the TV.

STOP

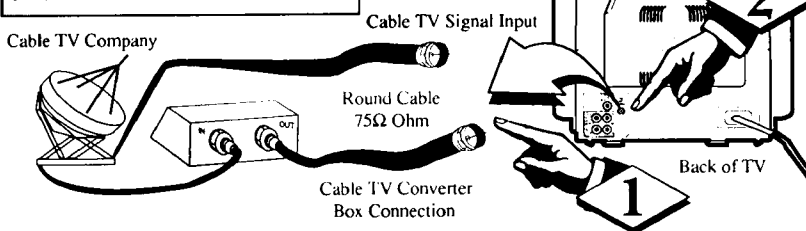

SMART HELP

Remember, set the TV for the type signal you've just connected (see page 7).

To select only the numbers on your Cable System see "Auto Program" (page 9). If you use a Cable Converter box, set the TV to the same channel as the converter's CH 3/4 switch (on the rear of the converter.)

ANTENNA

COMBINATION UHF/VHF

A combination (outdoor or indoor) antenna receives normal broadcast channels 2-13 (VHF) and 14-69 (UHF). Your connection to such an antenna is easy since there is only one antenna plug (75Ω-ohm) on the back of your TV - and that's where the antenna goes.

BEGIN

1 If your antenna has a round cable (75 ohm) on the end, then you're ready to connect it to the TV.
If your antenna has flat twin-lead wire (300 ohm), you first need to attach the antenna wires to the screws on a 300 to 75 ohm adapter.

2 Push the round end of the adapter (or antenna) onto the ANTENNA plug on the rear of the TV. If the round end of the antenna wire is threaded, screw it down tight.

STOP

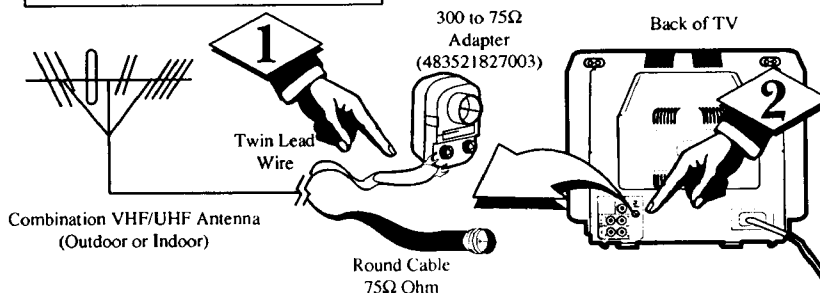

SMART HELP

Remember, be sure to set the TV for the type signal you've connected (see "SETUP" on page 7 of this manual).

To set the TV to select only the channel numbers in your area see how to "Program" or "Add" channels in memory on page 9.

To order any optional accessory contact your dealer or call the toll-free accessory ordering number: (1-800-292-6066).

VCR TO TV

BASIC CONNECTION

The basic Antenna, or Cable TV, to VCR to TV connection is shown to the right. For more information on other hookups (possible when Cable Converter boxes are included) refer to your accessory VCR and Cable Converter Owner's Manual for details.

BEGIN

1 Connect your Antenna or Cable TV signal to the IN FROM ANT(enna) plug on the VCR.

2 Connect the OUT TO TV plug on the VCR to the ANTENNA plug on the TV (connecting cable supplied with the VCR.)

3 Refer to the Owner's Manual included with your VCR for other connections and TV/VCR operating details.

STOP

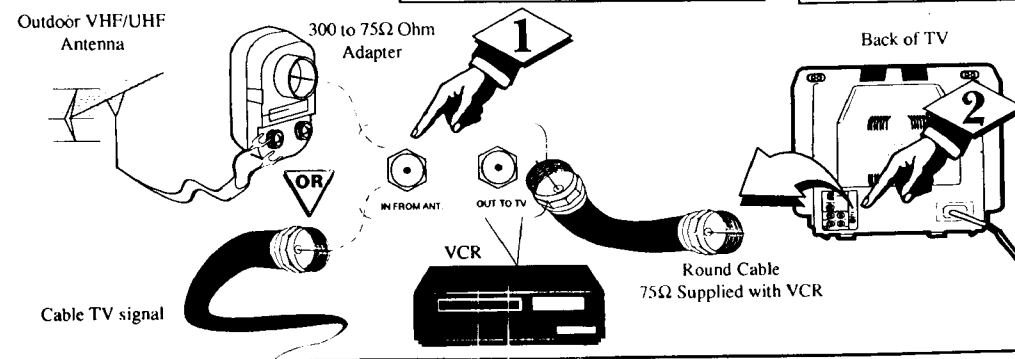

BASIC TV AND REMOTE CONTROL OPERATION

BEGIN

- 1 Press the **POWER** button to turn the TV ON.
- 2 Press the **VOLUME UP (▲)** or **DOWN (▼)** button to adjust the sound level.
- 3 Press the **CHANNEL UP (▲)** or **DOWN (▼)** button to select TV channels.
- 4 Point the remote control toward the remote sensor window on the TV when operating the TV with the remote.

Note: Always press **two number buttons** on the remote when selecting channels.
For example: press "0" then "6" for channel 6.

To load the supplied batteries into the remote:

1. Remove the battery compartment lid on the back of the remote.
2. Place the batteries (2-AA) in the remote. Be sure the (+) and (-) ends of the batteries line up correctly (inside of case is marked.)
3. Reattach the battery lid.

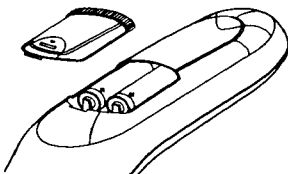

STOP

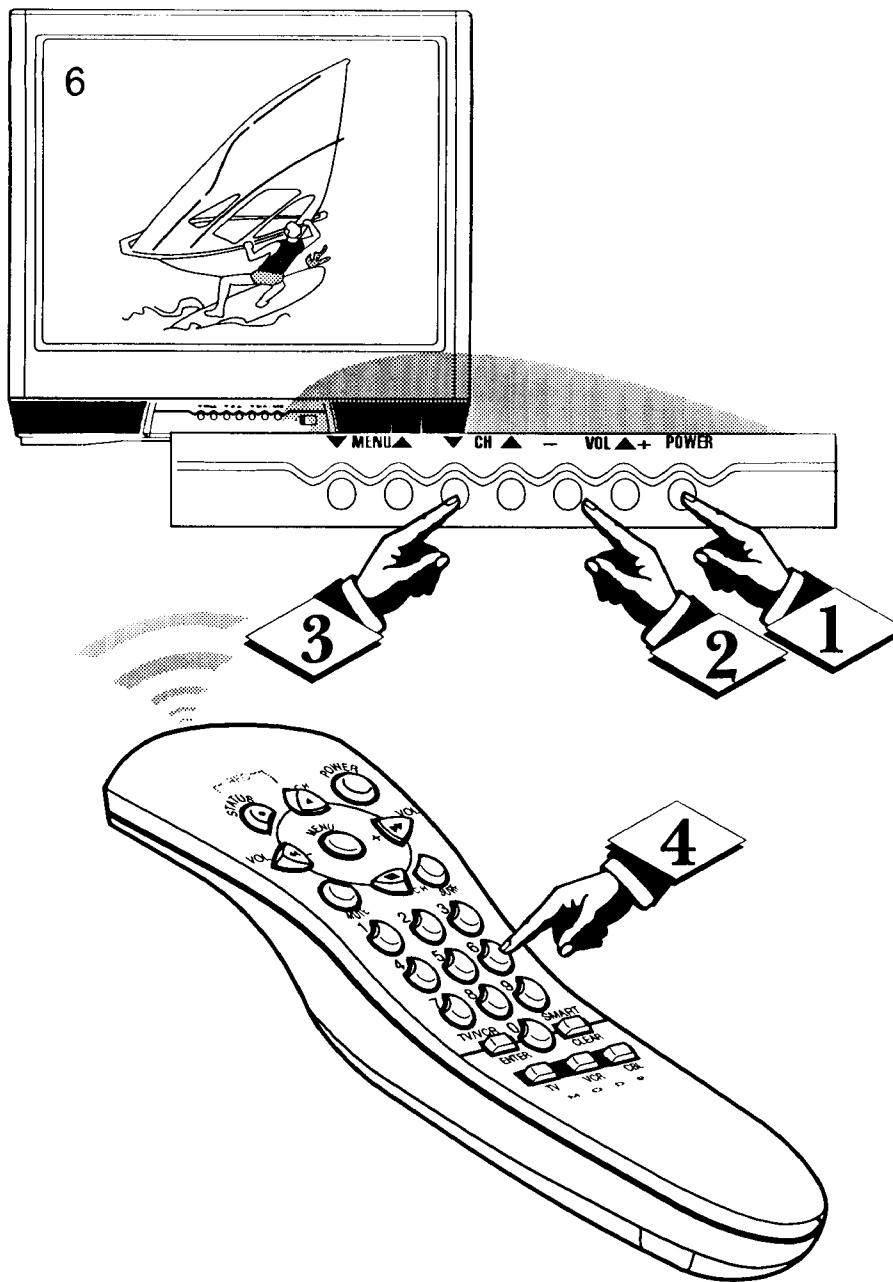

SMART HELP



Remember, you can press any button on the front of the TV to turn the TV ON.

The tuned channel number will always show on screen when the TV is first turned ON (and with channel changes). You can also press the **STATUS** button (on the remote) to see what channel the TV is ON.

HOW TO USE THE FIRST TIME SET-UP CONTROL

First Time Setup automatically takes care of some basic TV control settings for you. Follow the steps in this section to quickly add area channel numbers into the TV's memory, and set the TV for your connected signal (Antenna or Cable.)

BEGIN

- 1 With **SETUP** control selected, press (+) button (on the TV or remote) to show the list of **SETUP** items.
Press the **CHANNEL ▲** or **▼** (on the remote) to pick any of the **SETUP** items listed.
- 2 With **SELECT LANGUAGE** control **ON**, press (+) button to set the language of the TV's Menu controls. (Either English, Espanol/Spanish, or Francais/French).
- 3 With **AUTO CABLE SELECT** control **ON**, press (+) button to automatically set the TV to receive either Cable TV or Antenna signals (connected at the rear of the TV).
- 4 With **AUTO PROGRAM** control **ON**, press (+) button to automatically add Cable system or local area channel numbers into the TV's memory.

STOP

SMART HELP



Remember, **SETUP** is a first-use, one-time operation and will not have to be repeated (even if the TV is unplugged.)

Press the remote's **STATUS** button (or use "EXIT") to back out of the **SETUP** Menu.

If the **SETUP** Menu disappears and you are not finished, just press the **MENU** and (+) buttons to return to the **SETUP** screen.

NOTE: The "SETUP" on-screen control is automatically selected when you first plug-in your TV and press the **MENU** button (on the TV or the remote.)

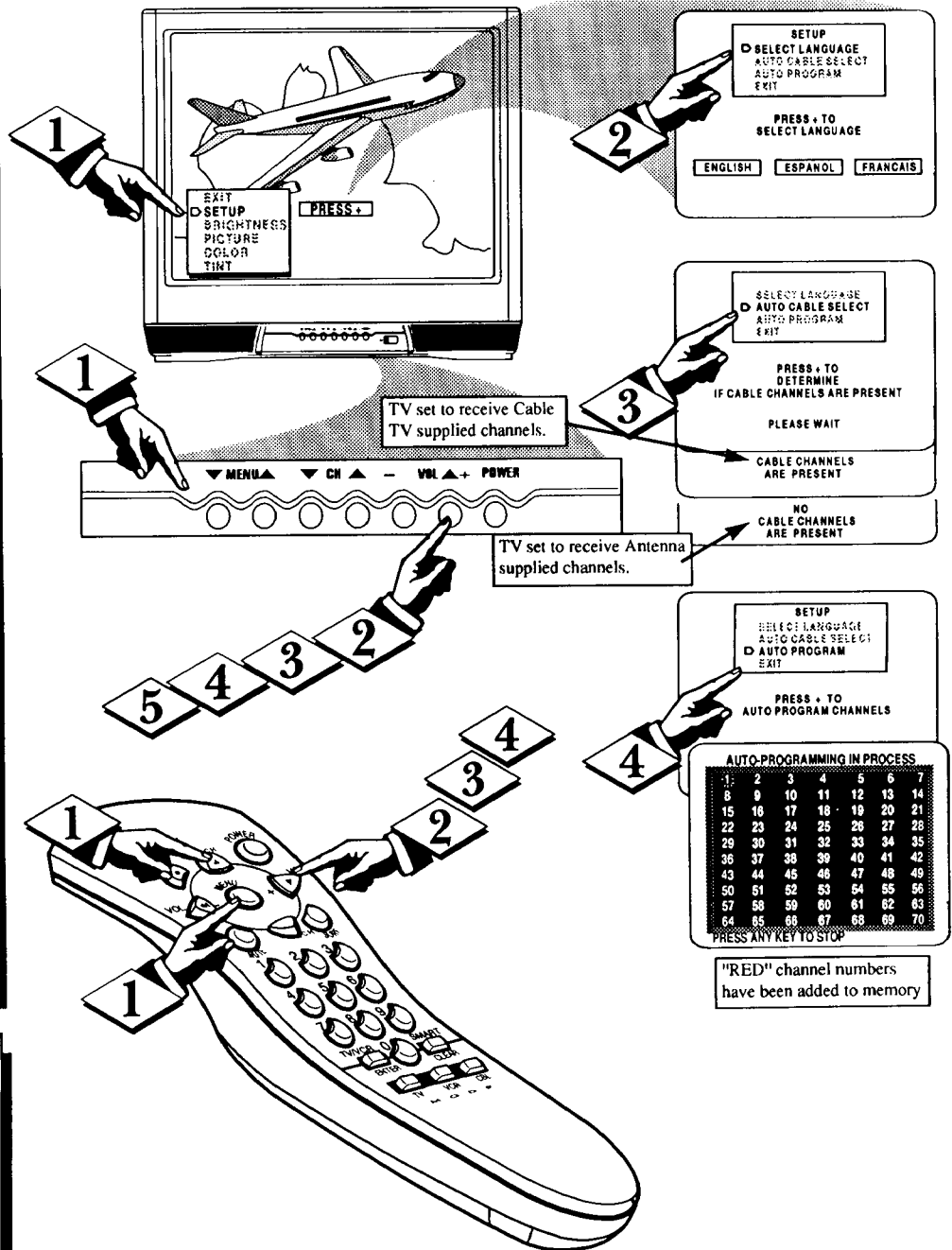

NOTE: If you went through Setup (see page 7), this task has already been completed for you.

You need to make sure that the TV is set to pick up either Cable TV stations or Antenna signals. In other words, the TV needs to know whether you have connected a Cable TV signal or a normal antenna to its ANTENNA plug.

BEGIN

- 1 Press **MENU (M)** button on the remote, then press the **CHANNEL ▲** or **▼** buttons (or the **MENU ▲** or **▼** buttons on the TV) to select the word **CABLE** with the TV's on-screen Arrow.
- 2 Press the **VOLUME (+)** or **(-)** buttons (on the TV or the remote) to select either:
 - YES-** If you DO have Cable TV connected to the TV. Channels 1-125 can be selected.
 - NO-** If you have an Antenna connected to the TV. Channels 2-69 can be selected.
- 3 Press **STATUS** to clear the screen



SMART HELP



Try it out. Press **CHANNEL ▲▼** buttons and scan the channels. **CH▲▼** on the remote works only after **STATUS** button is pressed (or Menu times out.)

Remember, the TV has been set at the factory to select certain channel numbers. See the following page on how to set the TV to select the channels in your area.

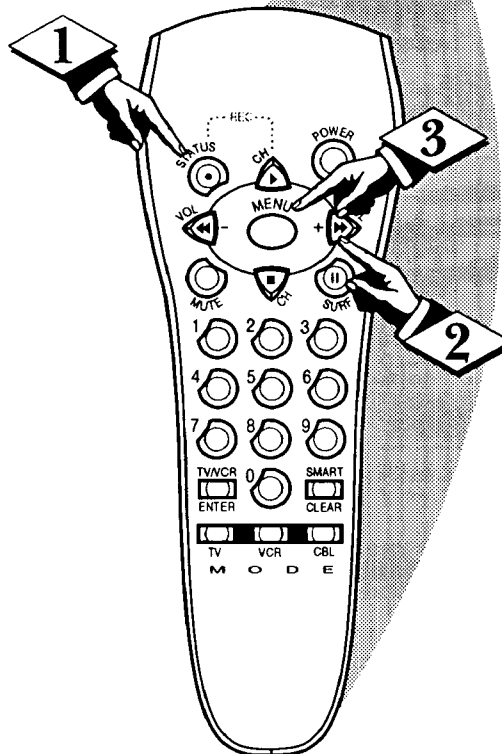
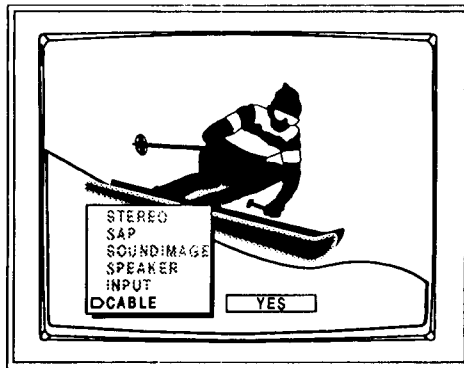

ADDING CHANNELS IN MEMORY (AUTO PROGRAMMING)

NOTE: If you went through Setup (see page 7), this task has already been completed for you.

Your TV can automatically set itself for local area (or Cable TV) channels. This makes it easy for you to select only the TV stations in your area when the CH(annel) ▲▼ buttons are pressed.

BEGIN

- 1 Press the **MENU (M)** button on the remote, then press the **CHANNEL ▲** or **▼** buttons (or the **MENU ▲** or **▼** buttons on the TV) to select the word **PROGRAM** with the TV's on-screen Arrow.
- 2 Press the **VOLUME (+)** button (on the TV or the remote) to **PROGRAM**.
- 3 Press the **(+)** button again to start the TV search for area channels.
Flashing channel numbers will count upward on the screen as the TV looks for channels to "ADD".
Press any button (on the TV or remote) to stop the channel search at any time. When the channel search is completed the TV will return to the last viewed channel.
- 4 Press **STATUS** button to clear the screen

SMART HELP

Try it out. Press **CHANNEL ▲▼** buttons and see which channels have been added.

Remember, if you want to drop any unwanted channels from the TV's memory, see the next page on how to "Manually" add and delete channels.

Note: As the TV searches for channels to "ADD" into memory the on-screen display may move (or jitter slightly). This is normal operation and does not indicate a need for service.

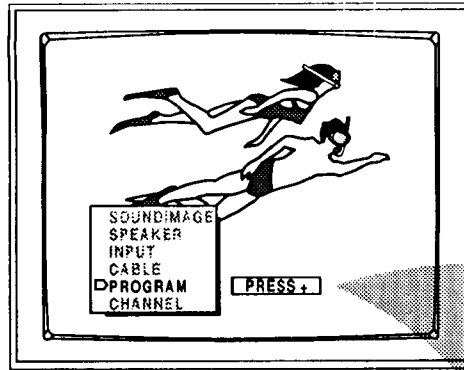

"RED" channel numbers have been added to the TV's memory.
"WHITE" channel numbers are not present in the TV's program memory.

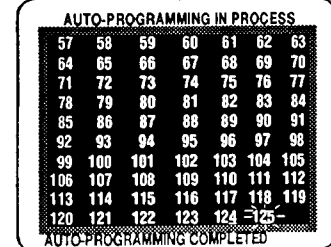
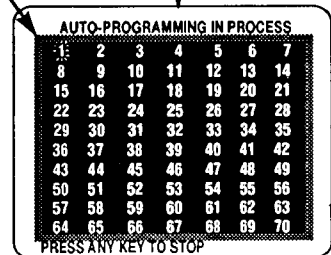
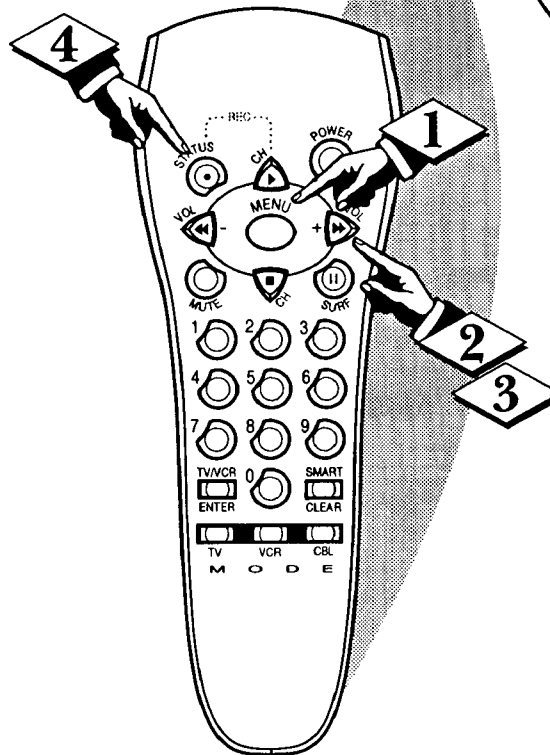
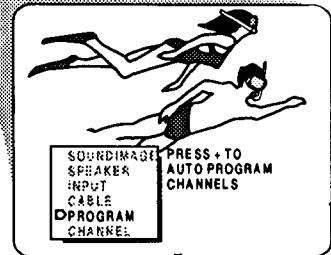

The TV screen will be blocked off until the search for channels is done.

ADDING CHANNELS IN MEMORY (MANUALLY)

Auto Programming (see previous page) adds all the channels it can find (on your Antenna or Cable TV system) into the TV's memory. Add/Delete Channels makes it easy for you to add other channels, or drop unwanted channels, from the list of channels in the TV's memory.

BEGIN

- 1 Press the MENU (M) button on the remote, then press the CHANNEL ▲ or ▼ buttons (or the MENU ▲ or ▼ buttons on the TV) to select the word CHANNEL with the TV's on-screen Arrow.
- 2 Press CHANNEL Number buttons on the remote (or Channel ▲ ▼ on the TV) to select the channel you want to SAVE (or DELETE.)
- 3 Press VOLUME (+) button to SAVE the selected channel number into memory. Press VOLUME (-) button to DELETE a channel from memory.
- 4 Press the STATUS button to clear the screen after adding all the channels you want.



SMART HELP



Try it out. Press the CHANNEL▲▼ buttons.

The channels you SAVED should appear. The channels you DELETED should not appear.

Remember, you can also add the VCR/AUX mode (see page 17) into the TV's channel memory. Then by pressing the CH ▲ ▼ buttons you can quickly select the Audio/Video Input jacks on the rear of the TV. Just "SAVE" the VCR/AUX mode (located between the lowest and highest channel numbers) into the TV's memory.

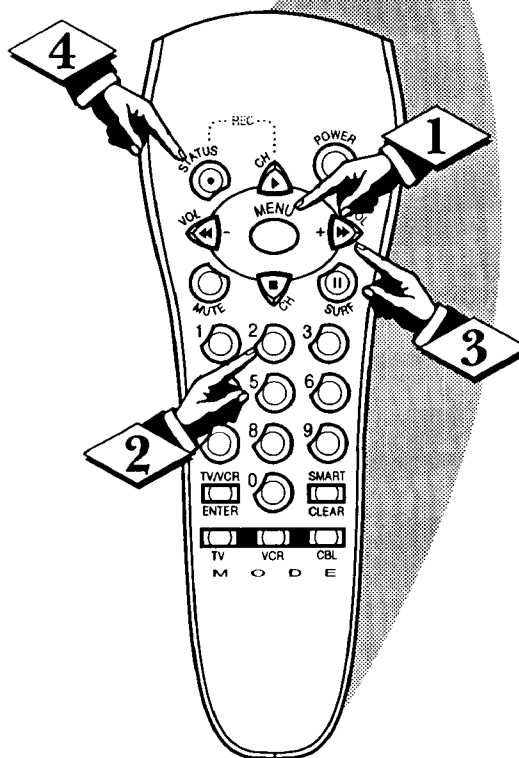
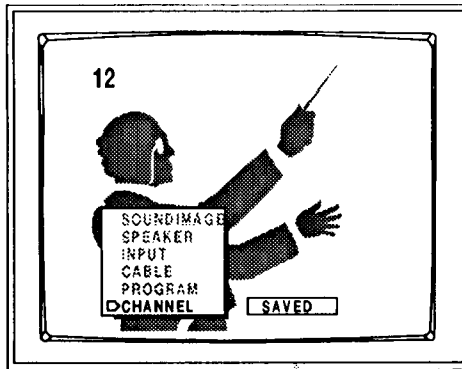

If you need to SAVE (or DELETE) a channel above 100, use the CH▲▼ buttons on the TV. The remote control number buttons can select only up to channel 99.

HOW TO SELECT THE CLOSED CAPTION FEATURE

Closed Captioning allows you to read the voice content of television programs on the TV screen. Designed to help the hearing impaired this feature uses on-screen "text boxes" to show dialogue and conversations while the TV program is in progress.

BEGIN

- 1 Press the **MENU (M)** button on the remote, then press the **CHANNEL ▲** or **▼** buttons (or the **MENU ▲** or **▼** buttons on the TV) to select the word **CAPTION** with the TV's on-screen Arrow.
- 2 Press the **VOLUME (+)** or **(-)** buttons to select the desired Closed Caption (CC) mode - For Example: **CAPTION 1**.
CAPTION 1, 2, 3, or 4 mode:
 dialogue (and descriptions) for the action on the captioned TV program shows on-screen. (See important note on this page.)
TEXT 1, 2, 3, or 4 mode:
 often used for channel guide, schedules, or bulletin board information for CC programs.
 Note: Usually "CAPTION" 1 is the most used mode to view captioned material.

- 3 Press the **STATUS** button after making your Caption mode selection.
 The TV display will clear and Captioning material (if available on the currently selected TV program) will appear on the TV screen.
 To cancel, set the **CAPTION** feature to **OFF** when finished viewing.



SMART HELP



Remember, broadcast stations will often use spelling abbreviations, symbols, dropouts and other grammatical shortcuts in order to keep pace with the on-screen action. These type factors vary upon the source of the captioned text material and do not indicate a need for service on the part of the TV.

NOTE: Not all TV programs and product commercials are made for broadcast with Closed Caption (CC) information included. Neither are all Closed Caption modes (CAPTION 1-4, or TEXT 1-4) necessarily being used by a broadcast station during the transmission of a closed caption program. Refer to your area's TV program listings for the stations and times of Closed Caption shows.

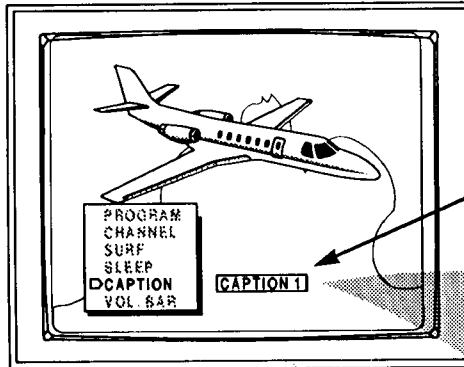

NOTE: The "CC1 W/MUTE" setting automatically switches the TV to the Closed Caption 1 mode whenever the MUTE button (on the remote control) is pressed. The Closed Caption 1 mode will turn OFF when the TV sound is returned or unmuted.

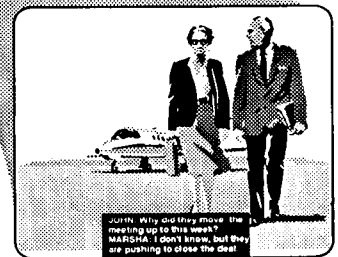

CAPTION mode
Example Display

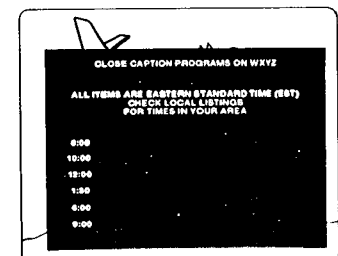
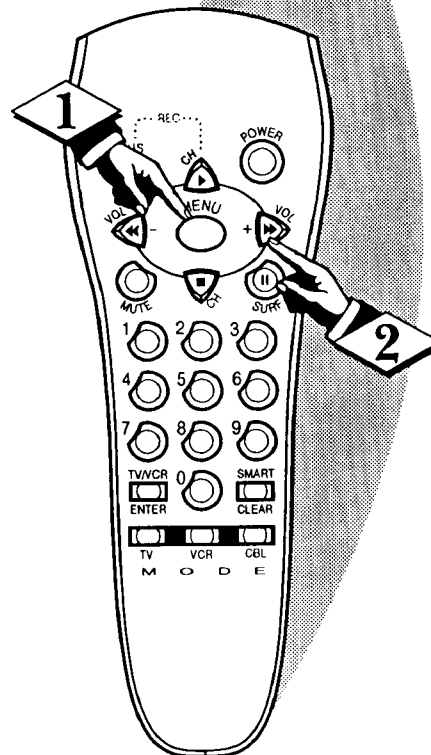

TEXT mode
Example Display
TV screen will be blocked from viewing

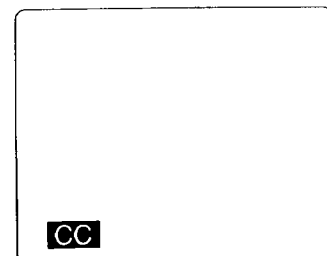

This symbol will appear with channels that contain Closed Captioning material.

HOW TO SET THE TV FOR STEREO PROGRAMS

Your TV can receive broadcast stereo TV programs. The TV has both an amplifier and twin speakers through which the stereo sound can be heard.

BEGIN

- 1 Press the **MENU (M)** button on the remote, then press the **CHANNEL ▲** or **▼** buttons (or the **MENU ▲** or **▼** buttons on the TV) to select the word **STEREO** with the TV's on-screen Arrow.
- 2 Press the **VOLUME (+)** button to turn the **STEREO MODE ON**.
- 3 Press **STATUS** to clear the screen

STOP

SMART HELP

Remember, if stereo is not present on a selected show and the TV is placed in the **STEREO** mode, the sound coming from the set will remain monaural (mono.)

SECOND AUDIO PROGRAM (SAP)

SAP is an additional part of the stereo broadcast system. Sent as a third audio channel SAP can be heard apart from the current TV program sound. TV stations are free to use SAP for any number of purposes, but many experts believe it will be used for foreign language translations of TV shows (or for weather and news bulletins.)

If a SAP signal is not present with a selected program, the SAP option cannot be selected. Also, if SAP is selected on a channel (with SAP) and you select another channel, when you return to the original channel SAP will be OFF (and you will have to reselect the SAP feature.)

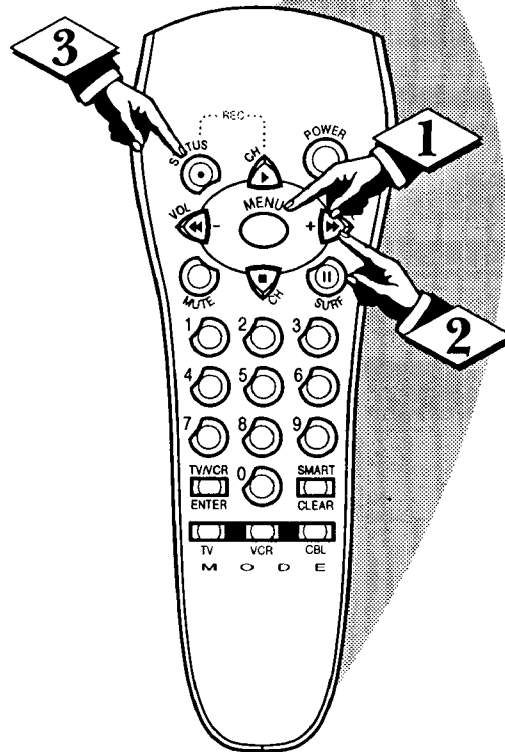

USING THE TV VOLUME BAR CONTROL

SMART HELP



Try it out.
Press the VOL▲▼ buttons.
The VOLUME BAR should appear at the bottom of the screen.

Use the Volume Bar control to see the TV's volume level settings on the TV screen. Once set the Volume Bar will be seen each time the VOLUME buttons (on the TV or remote) are pressed.

BEGIN

- 1 Press the MENU (M) button on the remote, then press the CHANNEL ▲ or ▼ buttons (or the MENU ▲ or ▼ buttons on the TV) to select the words VOL. BAR with the TV's on-screen Arrow.
- 2 Press the VOLUME (+) or (-) buttons to turn the VOL BAR control ON.
- 3 Press STATUS button to clear the screen.

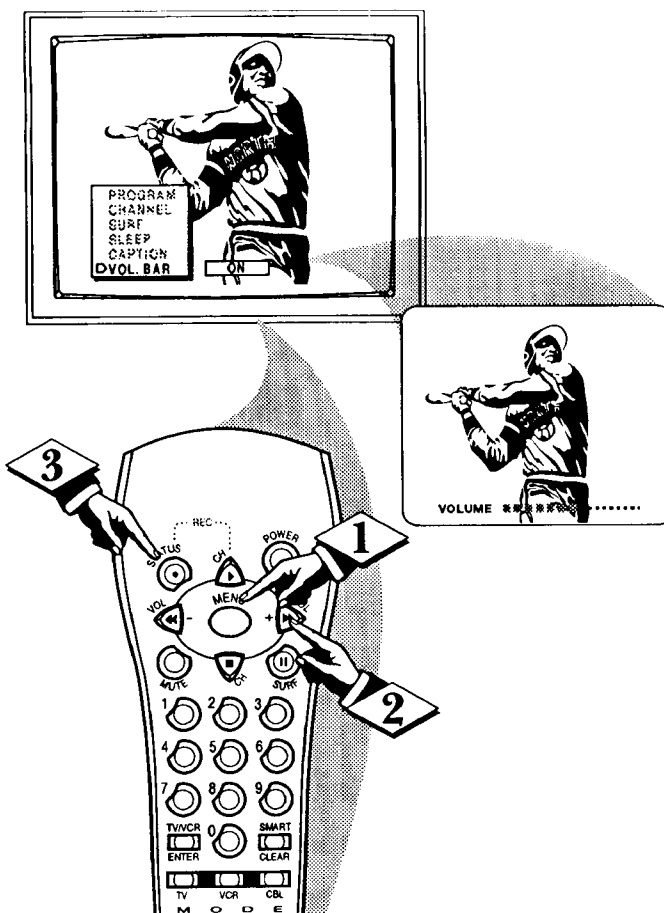

USING THE SOUND IMAGE CONTROL

The Sound Image control can be used to add greater depth and dimension to both MONO and STEREO TV sound. With the Sound Image control ON the TV's sound will appear wider or more expansive than normal.

BEGIN

- 1 Press the MENU (M) button on the remote, then press the CHANNEL ▲ or ▼ (or press MENU ▲ or ▼ buttons on the TV) to select SOUND IMAGE from the on-screen menu.
- 2 Press the VOLUME (+) and (-) to select either ON or OFF.
- 3 Press STATUS button to clear the screen when finished.

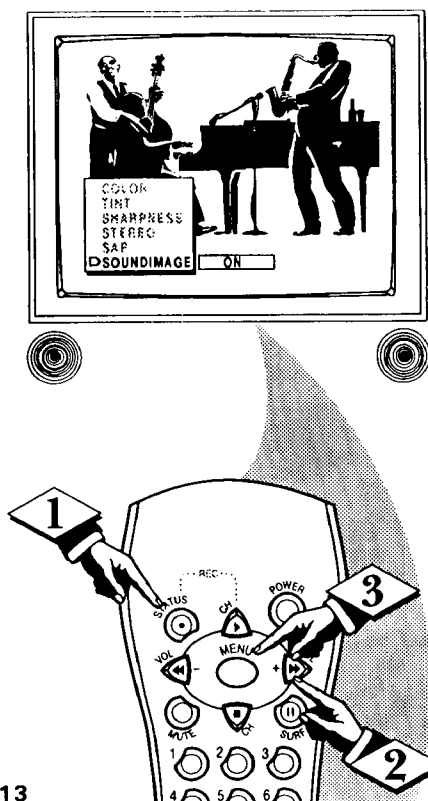

SETTING THE SLEEP TIMER CONTROL

Have you ever fallen asleep in front of the TV only to have it wake you up at two in the morning with a test pattern screeching in your ears? Well, your TV can save you all that trouble by automatically turning itself off.

BEGIN

- 1** Press the **MENU (M)** button on the remote, then press the **CHANNEL ▲** or **▼** (or press the **MENU ▲** or **▼** buttons on the TV) to select the word **SLEEP** with the TV's on-screen Arrow.
- 2** Press the **VOLUME (+)** or **(-)** button repeatedly to pick the amount of time (15 minutes to 2 hours ahead) before the TV will turn itself off.
The **VOLUME (+)** or **(-)** buttons can also be used to set the amount of time.
- 3** Press the **STATUS** button to clear the screen after you have set the time for the TV to turn off.
A few seconds before the TV is to shut off a message will come on the screen telling you **GOOD NIGHT**.

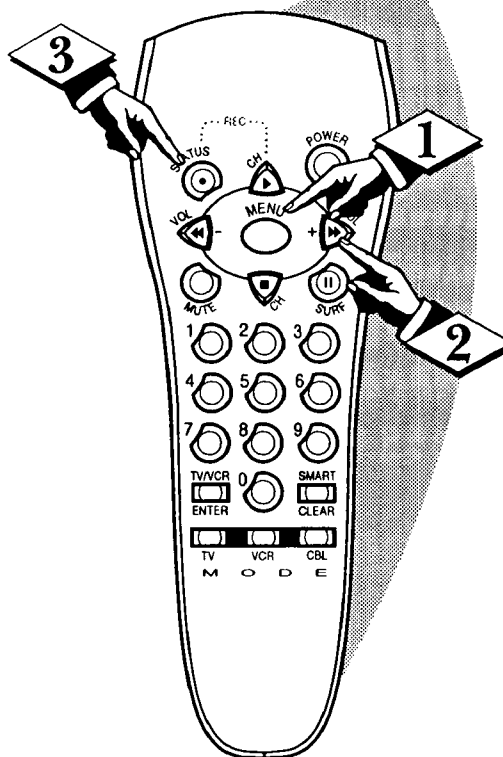
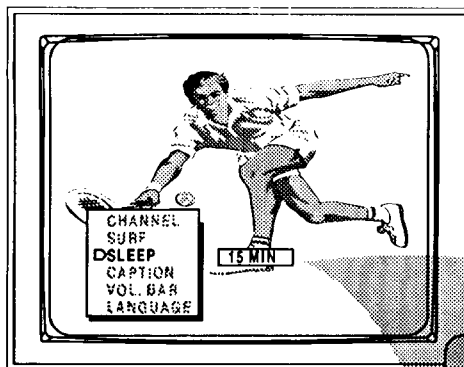

SMART HELP



Remember. If you ever want to see how many minutes are left before the TV shuts itself off, press the **STATUS** button on the remote.

If you want to stop a **SLEEP TIMER** setting, reset the timer back to **OFF**. You could also turn the TV off, and then back on again, to cancel a setting.

Pressing any key on the remote or TV in the last 60 seconds will cancel the **SLEEP TIMER** setting.

HOW TO ADJUST THE TV PICTURE

To adjust your TV picture controls, select a channel and follow the steps shown below:

BEGIN

- 1 Press the **MENU (M)** button on the remote, then press the **CHANNEL ▲** or **▼** buttons (or the **MENU ▲** or **▼** buttons on the TV) until the desired control shows on-screen.
- 2 Press the **VOLUME (+)** and **(-)** to adjust the selected color control.
- 3 Press **STATUS** button (or **EXIT Menu**) to clear the screen when picture adjustments are completed.

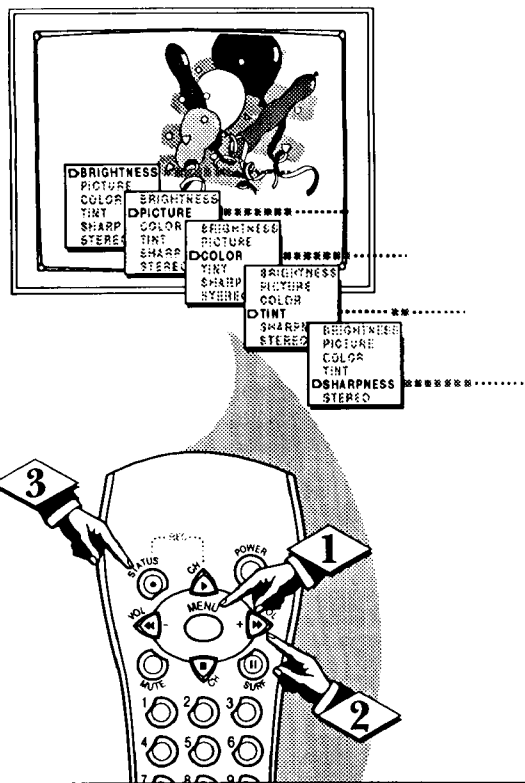

SMART HELP



Remember, when the bar scale is centered, the control settings are at normal mid-range levels.

BRIGHTNESS Press (-) or (+) until darkest parts of the picture are as bright as you prefer.

PICTURE Press (-) or (+) until lightest parts of the picture show good detail.

COLOR Press (-) or (+) to add or eliminate color.

TINT Press (-) or (+) to obtain natural skin tones.

SHARPNESS Press (-) or (+) to improve detail in the picture.

USING THE ON-SCREEN LANGUAGE OPTION

NOTE: If you went through First Time Setup (page 7), this task has already been completed for you.

For our Spanish and French speaking TV owners an on-screen LANGUAGE option is present. With the LANGUAGE control you can set the TV's on-screen features to be shown in either English, Spanish, or French text.

BEGIN

- 1 Press **MENU (M)** button on the remote, then press the **CHANNEL ▲** or **▼** (or press the **MENU ▲** or **▼** buttons on the TV) to select the word **LANGUAGE** with the TV's on-screen Arrow.
- 2 Press the **VOLUME (+)** or **(-)** buttons to select either the English, Spanish (Espanol), or French (Francais) language option. Text for the on-screen Menu will change to the selected language.
- 3 Press **STATUS** button on the remote control to clear the screen.

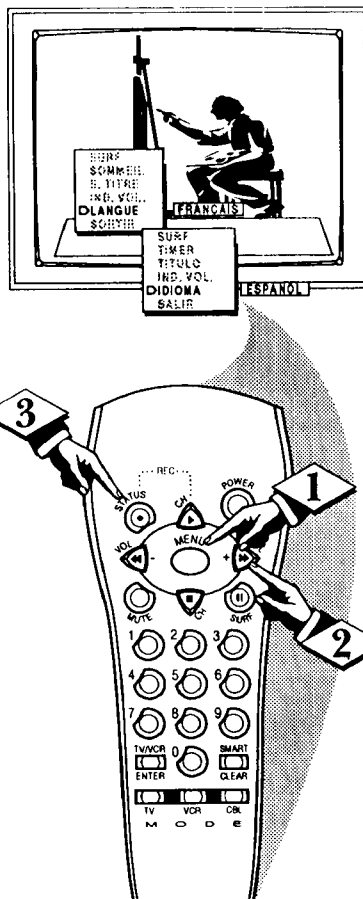

SMART HELP



Remember. The Language control only makes the TV's on-screen (MENU) items appear in English, Spanish, or French text. It does not change the language of other on-screen text features such as Closed Captioned (CC) TV shows.

Would you like to hear TV programs through your audio hi-fi system? The TV's Audio Output jacks and TV Speaker On/Off control work together to offer you this TV sound option.

BEGIN

- 1 Connect the R(ight) and L(eft) **AUDIO OUT** jacks on the TV to the R and L Audio Input jacks on your amplifier or sound system. Set the audio system's volume to normal listening level.

- 2 Turn the TV and audio system **ON**. You can now adjust the sound level coming from the audio system with the Volume ▲▼ buttons on the TV or remote.

- 3 To hear the TV sound from only the audio system speakers, select the TV's **SPEAKER** on-screen control.

Press **MENU (M)** button on the remote, then press the **CHANNEL ▲** or **▼** (or press the **MENU ▲** or **▼** buttons on the TV) to select the word **SPEAKER** with the TV's on-screen Arrow.

- 4 Press the **VOLUME (+)** or **(-)** buttons to turn the TV's internal speakers **OFF**.

You should now only hear TV sound coming from the audio system speakers.

- 5 Press **STATUS** button on the remote control to clear the screen.

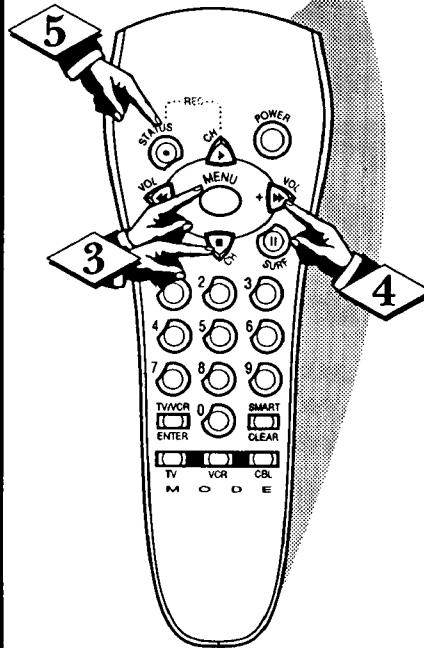
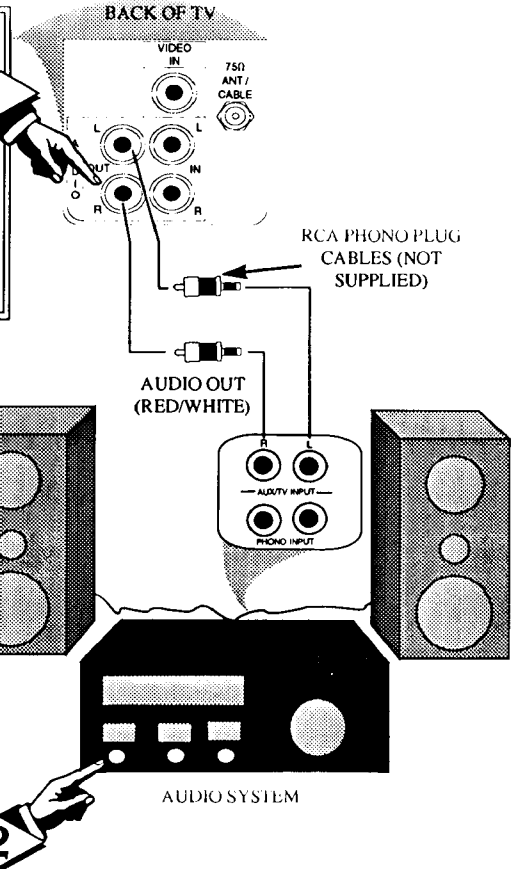
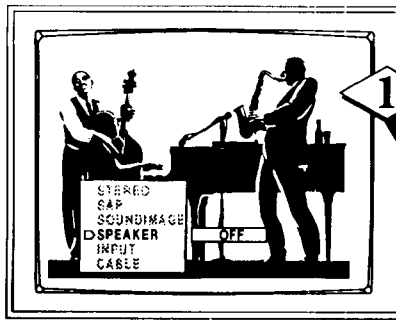

SMART HELP



Remember, the audio system may have to be in **AUX(iliary)** mode to play sound from the TV.

HOW TO USE THE AUDIO/VIDEO INPUT JACKS

You can view the playback of VCR tapes (Video Disc Players, camcorders, etc.) by using the AUDIO and VIDEO INPUT jacks (on the rear of the TV).

For example: to view the playback of a VCR tape:

BEGIN

- 1 Connect the VIDEO and AUDIO IN(put) jacks on the TV to the AUDIO and VIDEO OUT(put) jacks on the VCR.
- 2 Press the MENU (M) button on the remote, then press the CHANNEL ▲ or ▼ buttons (or the MENU ▲ or ▼ buttons on the TV) to select the word INPUT with the TV's on-screen Arrow.
- Note: You can press the CHANNEL▲▼ buttons to select "VCR/AUX" (if it has been added to the TV's channel memory.) See page 10 for details.
- 3 Press the VOLUME (+) or (-) button to select the VCR/AUX(iliary) INPUTS on the rear of the TV.
- 4 Turn the VCR ON and PLAY the VCR tape to be viewed on the TV.



SMART HELP



Remember, when you're through using the A/V INPUT jacks, return the INPUT display screen on the TV to ANTENNA. If you leave the TV in the VCR/AUX INPUT mode and there is no signal source connected to the jacks, you will be seeing only a blank screen on the TV.

NOTE: If you have a mono (single audio OUTPUT) VCR, "Y" Connectors are available (from your dealer or Parts Information Center 1 800 292-6066) to connect to the audio inputs on the TV.

PICTURE AND SOUND FROM
PLAYBACK OF VCR TAPE

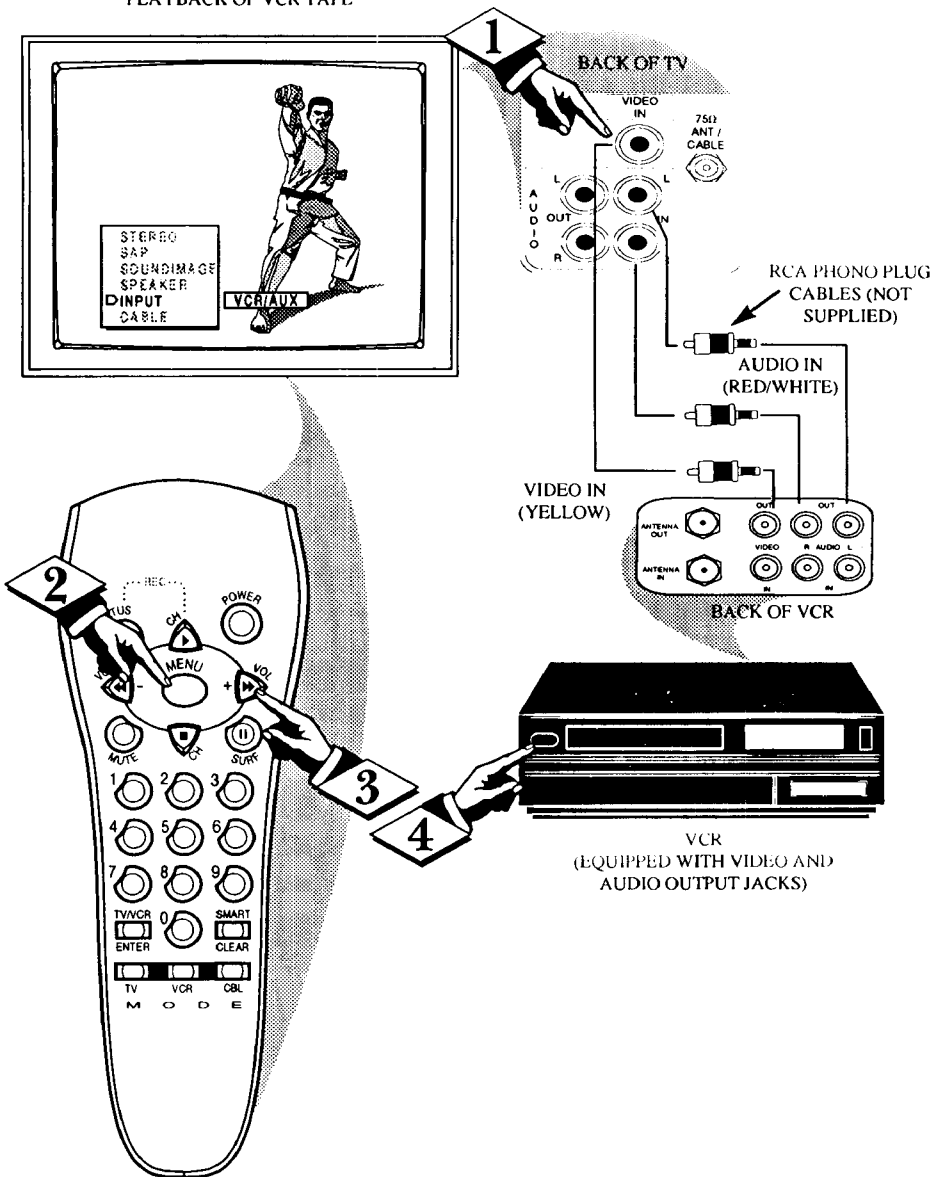

USING THE TV REMOTE CONTROL

After installing the batteries (see page 6) into the remote, press the TV System button to send remote commands to the TV. Point the remote toward the front of the TV (remote sensor window) when pressing buttons.

VCR Buttons

For use of VCR buttons see the "Using the Remote With a VCR" section on page 19.

Status/Exit Button

Press to see the current channel number on the TV screen. Also press this button to clear the TV screen after control adjustments.

Menu Button

Press the M button to show on-screen controls. Press Channel ▲ or ▼ buttons to move through the list of controls. Press the Volume (+, -) buttons to adjust the MENU controls.

Mute Button

Press to turn the sound OFF on the TV. Press again to return the sound to its previous level.

TV-VCR Button

Press to the VCR position ("VCR" indicator on the VCR will light) to view the playback of a tape. Press again to place in the TV position ("VCR" indicator on the VCR will go OFF) to view one program while recording another program.

TV-VCR-CBL System Buttons

Press to send remote control commands to either the TV, VCRs, or accessory Cable Converters. See the "How to operate VCRs and Cable Converters" section for further details.

Channel Scan Button

Press to scan up or down through channel numbers. When used with the MENU button, press to adjust the selected on-screen (MENU) feature controls.

Power Button

Press to turn TV ON and OFF.

Volume (-) and (+) Buttons

Press to adjust the TV sound level. When used with the MENU button, press to adjust the selected on-screen (MENU) feature controls.

Surf Button

Press to select previously viewed channels. For example: You are watching channel 4 and change to channel 10 (using the channel number buttons). Press SURF and your TV will return to channel 4. Press SURF again and your TV will return to channel 10. Turn to page (21) to see how the "SURF" control is used to quickly select a series of channels.

Number Buttons

Press two number buttons to select TV channels. For example: to select channel 6... press "0" first; then "6".

Smart Button

Press to select automatic settings for TV Picture and Sound. Smart Picture for factory preset video levels on a variety of program sources. Smart Sound to control TV sound levels during program changes or commercial breaks. See page (24) for details.

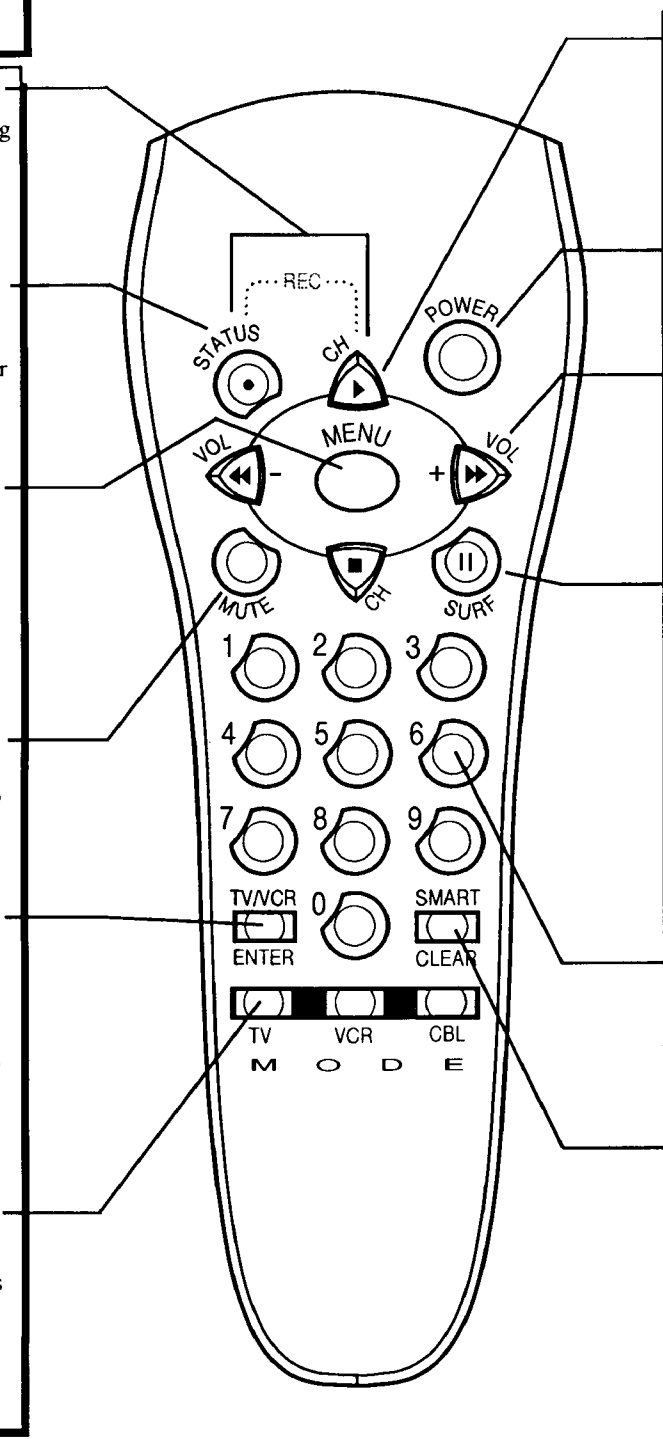

SMART HELP

The remote's TV-CBL-VCR System buttons control how buttons on the remote are used.

With the "TV" system button pressed, the Menu, (M)▲▼, and (+,-) buttons are used to select and adjust on-screen TV features.

With the "CBL" system button pressed: the Power, Channel Number, and CH Up▲/Down▼ buttons on work with Converters.

With the "VCR" system button pressed, the Menu, (M)▲▼, and (+,-) buttons work Stop, Play, and other VCR features.



When using the TV remote with a VCR, first make certain it is set to control your VCR (by the REMOTE CODE or SEARCH method - see earlier section).

BEGIN

- 1 Press the VCR System button on the remote.
- 2 Point the top of the remote toward the front of the VCR (remote sensor window) when pressing buttons.



Record Buttons

Hold the RECORD (STATUS) button down, and then press the PLAY (CHANNEL up) button to begin a VCR recording.

Rewind Button

Press to rewind tapes. For some VCRs you may need to press STOP button first then REWIND. In playback mode, hold button down to view picture moving rapidly in reverse.

Stop Button

Press to stop the tape.

TV-VCR Button

Press to the VCR position ("VCR" indicator on the VCR will light) to view the playback of a tape. Press again to place in the TV position ("VCR" indicator on the VCR will go OFF) to view one program while recording another program.

SMART HELP



Remember, the VCR buttons on the remote will not operate your VCR if those features are not already found on your VCR remote control.

Note: All VCR functions (particularly Search, Rewind, Fast Forward, etc.) will operate the same as with the original VCR remote control provided with the VCR.

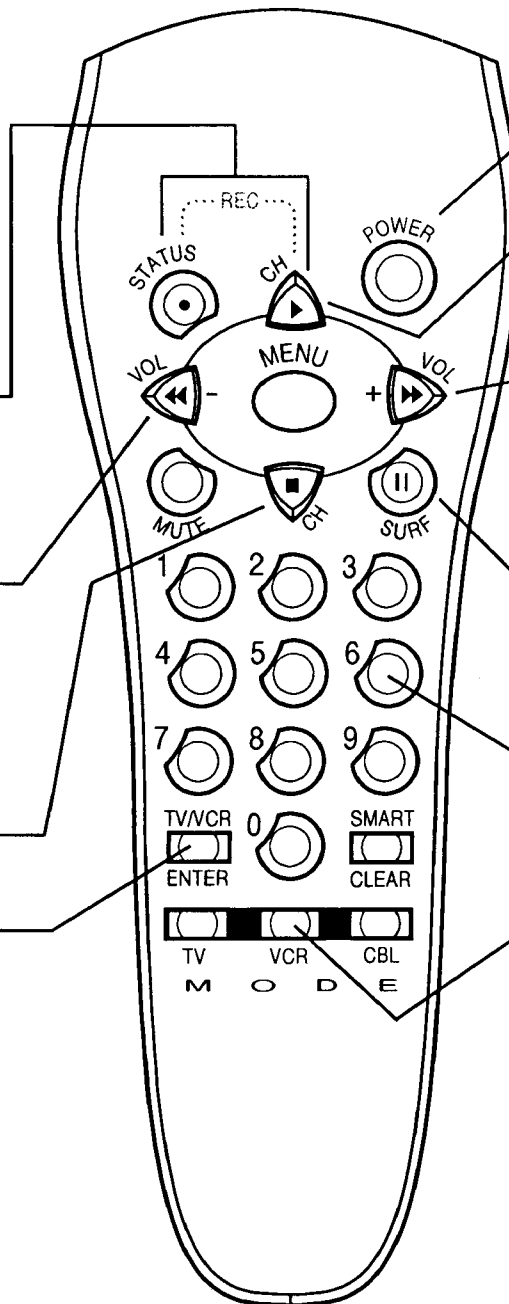

Power Button

Press to turn the VCR ON and OFF.

Play Button

Press to playback a tape. Hold down after pressing the RECORD button to start a recording.

Fast Forward Button

Press to rapidly advance the tape. For some VCRs you may need to press STOP first then FF. In Playback mode hold button down to view the picture moving rapidly in the forward direction.

Pause Button

Press to temporarily stop the tape during a playback or recording. Press again to release Pause.

Number Buttons

Press buttons for direct VCR channel selections.

VCR System Button

Press to send remote commands to the VCR.

NOTE:

The MENU button may not call up on-screen functions in models built prior to 1993.

USING THE SMART PICTURE AND SMART SOUND CONTROLS

SMART HELP



Remember, the Smart Picture settings are stored into the TV at the factory and can only be reset by field and service technicians.

Whether you're watching a movie or a video game your TV has automatic picture settings matched for your current program source or content. The Smart Picture feature quickly resets your TV's picture for a number of different types of programs and viewing conditions you may have in your home.

BEGIN

- 1 Press the Smart button on the remote.

Press the Menu (M) ▲ or ▼ button to select the desired Smart Menu feature (highlighted with arrow).

- 2 With the Smart Picture control selected, press the VOLUME (+) or (-) button repeatedly to select any of the preset viewing categories (Example: Video Games, Movies, etc.).

- 3 Press the STATUS button to clear the screen.

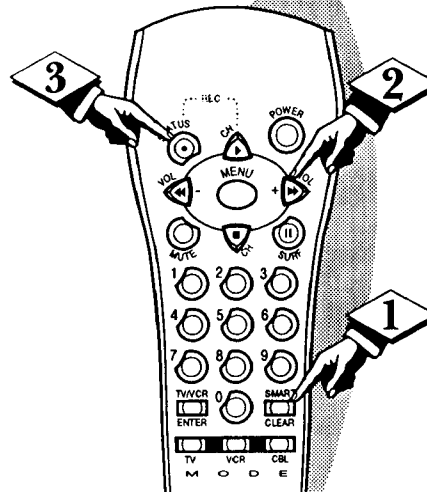
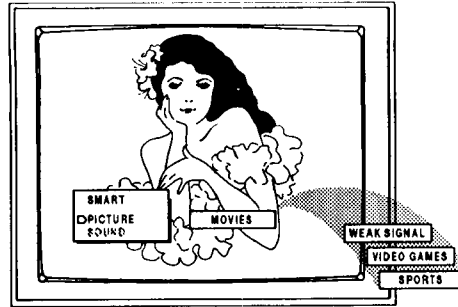

Are you tired of the sound of commercials following you into the next room or all through the house? Smart Sound allows you to keep a desired volume level that the TV sound will not go above. This makes for an even, more consistent sound by reducing the peaks and valleys that can occur during program changes or commercial breaks.

BEGIN

- 1 Press the Smart button on the remote.

Press the Menu (M) ▲ or ▼ button to select the desired Smart Menu feature (highlighted with arrow).

- 2 With the Smart Sound control selected, press the VOLUME (+) or (-) button to turn the volume level control ON or OFF.

- 3 Press the STATUS button to clear the screen when completed.

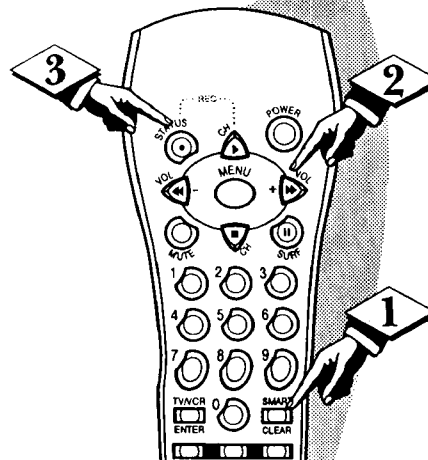
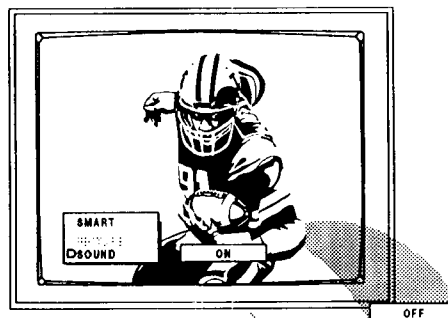

2CH SURF/SMART SURF

A "list" or series of previously viewed channels can be selected with the SURF button on your remote control. With this feature you can easily switch between different TV programs that currently interest you. The Smart Surf control allows you to set up to 10 channels in its quick viewing "list".

BEGIN

- 1 Press MENU (M) button on the remote, then press the CHANNEL ▲ or ▼ (or press the MENU ▲ or ▼ buttons on the TV) to select the word SURF with the TV's on-screen Arrow (or press the SMART button on the remote).
- 2 Press the VOLUME (+) or (-) buttons to select either 2-Channel Surf or Smart Surf. (See the explanation of Surf options with the illustration on this page.)
- 3 Press STATUS button on the remote control to clear the screen.

STOP

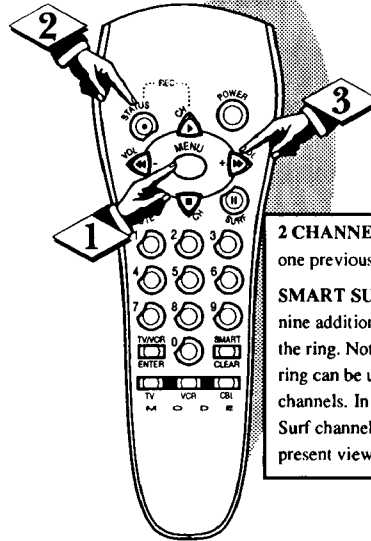
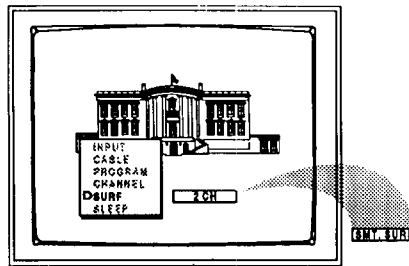

2 CHANNEL SURF- Current and one previous channel in the ring.
SMART SURF - Current and up to nine additional channels available in the ring. Note: The Channel Surf ring can be used with fewer than ten channels. In this way the number of Surf channels can match or fit your present viewing interests.

SMART HELP



To Use 2-Channel Surf:

With the 2-Channel Surf control ON select the two desired channels for viewing with the number buttons on the remote control.

Press the SURF button on the remote to "toggle" between the two selected channels.

When Using Smart Surf:

A "SURF MENU TABLE FULL" message will appear on screen when the maximum number of 10 channels has been added to the Smart Surf list.

HOW TO USE SMART SURF

BEGIN

- 1 With the Smart Surf control ON (see above), select a desired channel for viewing. You can use the number buttons on the remote (or the Channel ▲▼ buttons).
- 2 Press the SURF button on the remote. (Some channel numbers may already appear within the Surf channel list.)
- 3 Press the Menu button to "ADD" the selected channel to the Surf list. Select the next desired channel and repeat steps 2 and 3. Continue until all desired channels are on the Surf list.
- 4 Press the SURF button on the remote to quickly review current action on channels contained within the Surf list.

STOP

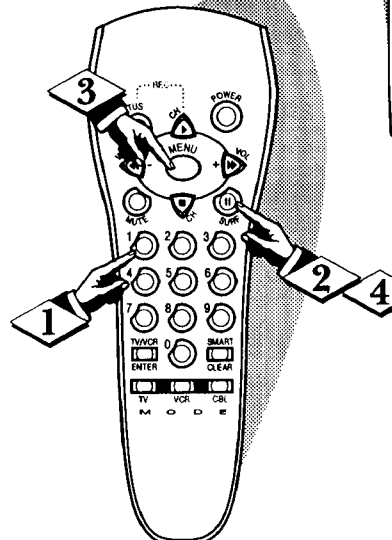
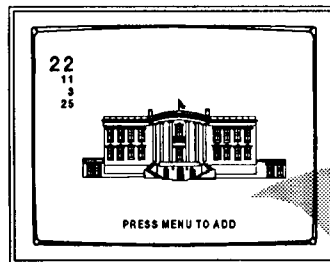

Note: To Delete a channel from the Surf list just press the SURF button to select the desired channel. Then press the Menu button and the channel will be immediately dropped from the on screen Surf list.

SETTING THE REMOTE TO WORK VCRs

Your remote control is set to work your TV and many infrared remote (IR) control VCRs. However, an easy one-time step may be necessary before the remote will work your VCR.

Try this initial check to see if going on to the following section is necessary.

BEGIN

- 1 Press the VCR System button on the remote.
- 2 Point remote toward VCR and press the POWER button.
- 3 Does the remote turn the VCR ON?
IF YES, and try the other VCR buttons on the remote. If they also work the VCR, then the remote is ready and no further steps are needed.
IF NO, continue...

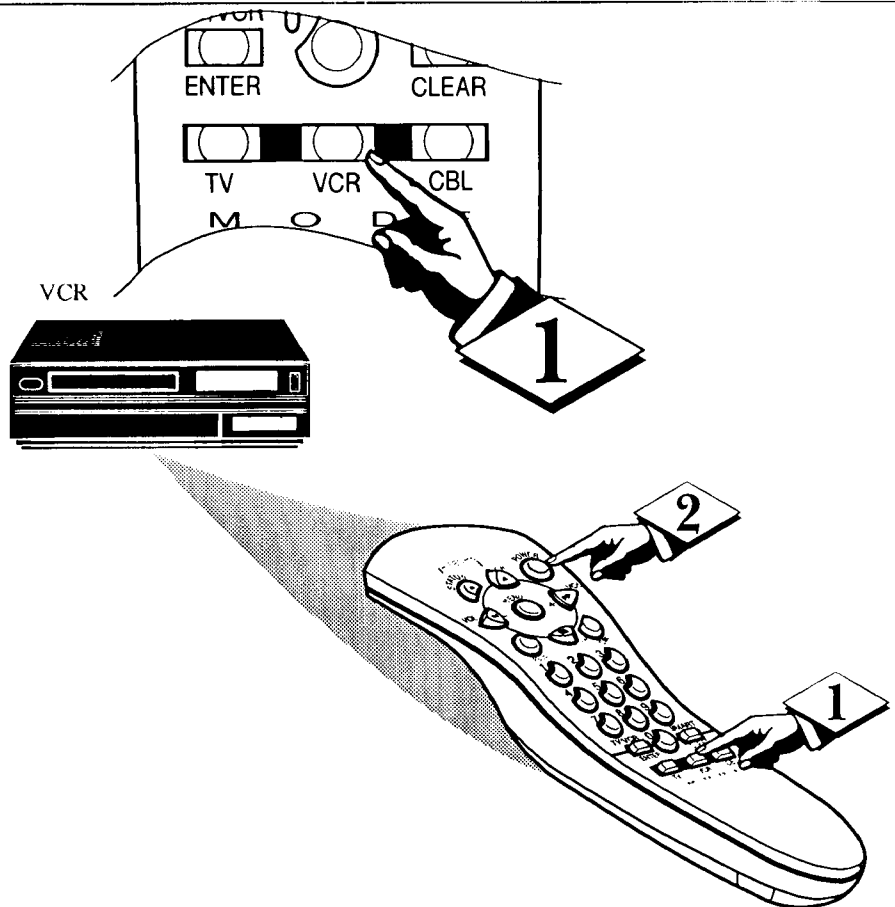

- 1 First look up a **TWO-DIGIT** remote code number for your brand VCR before going through the simple "1,2,3" steps (on the following page).

continue to next page

SMART HELP

Remember, if more than one number is listed, you may have to try more than the first two-digit code given in order to locate your VCR's remote code.

<u>VCR BRAND</u>	<u>REMOTE CODE NO.</u>	<u>VCR BRAND</u>	<u>REMOTE CODE NO.</u>
Akai	24, 25, 36	Panasonic	01, 02, 52
Capehart	33	Philips	00, 05
Conoid	13	Philips Video CD	37
Curtis Mathes	42	RCA	04, 32, 42, 43, 44
Daewoo	33	Samsung	22, 30
Emerson	20, 31, 34, 40	Sansui	49
Fisher	06, 07	Sanyo	13
Goldstar	23	Sears	08
Go Video	45, 46	Sharp	11, 12
Hitachi	03, 51	Shintom	35
JVC	14, 47, 48	Sony	09, 10, 41
Magnavox	00, 05	Teknika	26
Matsushita	01, 02	Toshiba	18, 19
Mitsubishi	16, 17, 38, 39, 50	Video Concepts	29
Multitech	27, 28	Zenith	15
NEC	21		

Now that you have looked up the two-digit Remote Code Number for your brand of VCR (on previous page), you are ready to follow the four simple steps below.

Please read through steps 1-4 before beginning.

BEGIN

- 1 Press and release the STATUS button.
- 2 Within thirty seconds after releasing the REC button, press and release the VCR System button.
- 3 Within thirty seconds after releasing the VCR System button, ENTER THE TWO DIGIT CODE NUMBER for the desired VCR. The remote is now ready to send commands to the VCR.
- 4 Point the remote at the VCR. Press the POWER button on the remote to turn the VCR ON.

STOP

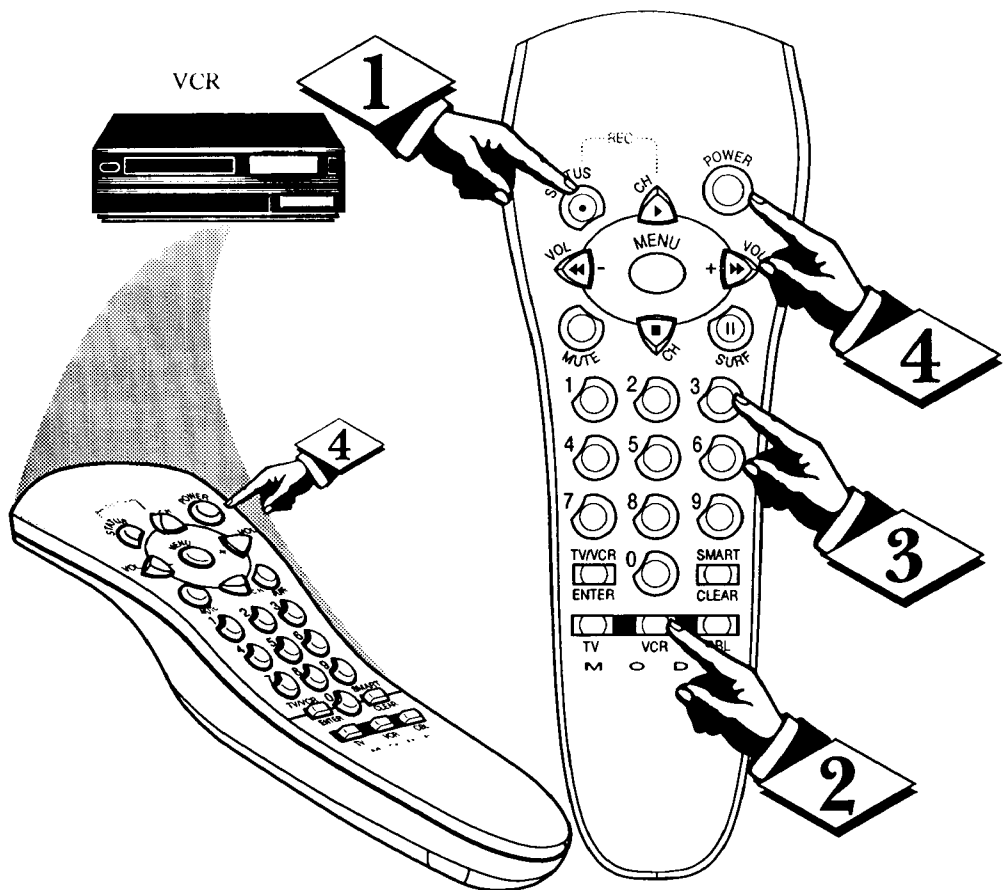

SMART HELP

Try it out. The Channel and VCR buttons on the remote should now operate the VCR.

Remember, if this doesn't work the first time, repeat steps using the same remote code number.

If after a second try the remote does not operate your VCR, and there are more code numbers listed for your brand VCR, use the next listed code number.



If after repeated attempts the code number method does not work your VCR, try the "VCR SEARCH" method on page 26.

SETTING THE REMOTE TO WORK CABLE TV CONVERTERS

Your remote control is set to work your TV and many infrared remote (IR) control Cable Converters. However, an easy one-time step may be necessary before the remote will work your Converter.

Try this initial check to see if going on to the following section is necessary.

BEGIN

- 1 Press the CBL System button on the remote.
- 2 Point remote toward Cable Converter and press the POWER button.
- 3 Does the remote turn the Converter ON?
IF YES,  and try the CH  and CH number buttons on the remote. If they also work the Converter then the remote is ready and no further steps are needed.
IF NO, continue...

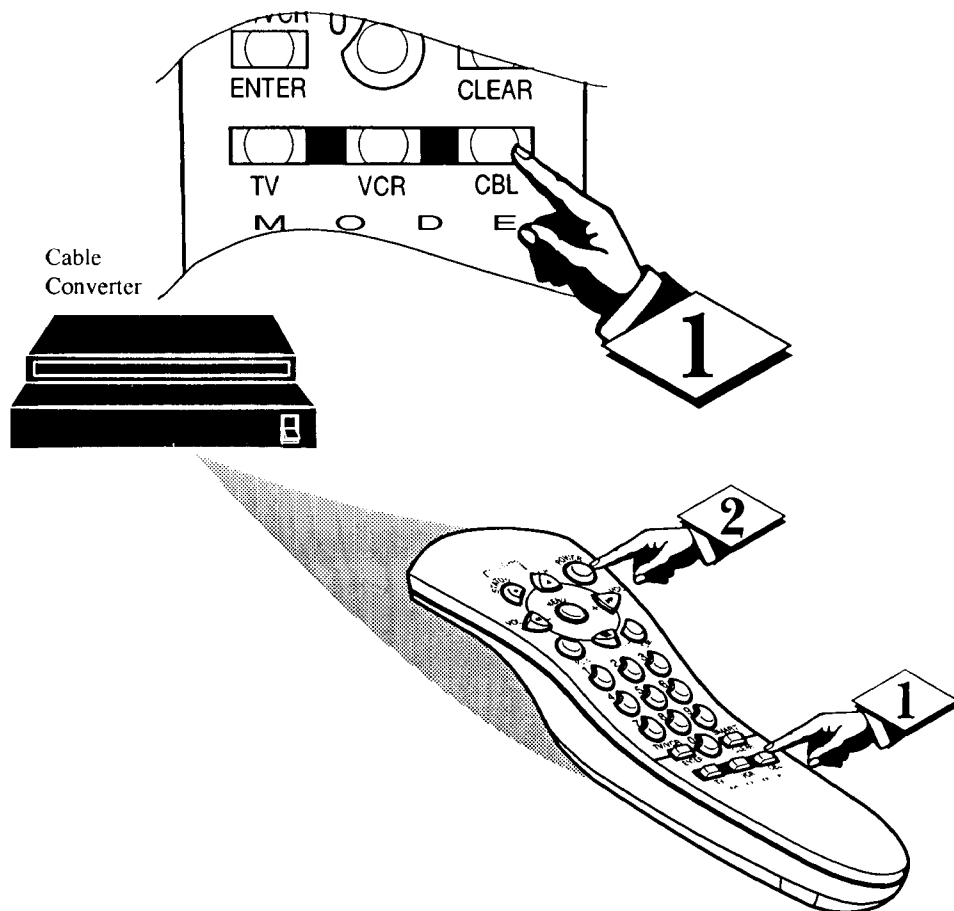

- 1 First look up a **TWO-DIGIT remote code number** for your brand Converter before going through the simple "1,2,3" steps (on the following page).

continue to next page

SMART HELP

 Remember, if more than one number is listed, you may have to try more than the first two-digit code given in order to locate your Converter's remote code.

<u>CONVERTER BRAND</u>	<u>REMOTE CODE NO.</u>	<u>CONVERTER BRAND</u>	<u>REMOTE CODE NO.</u>
Archer	28	Rembrant	33
Diamond	23	Salora	52
Drake	37	Scientific Atlanta	08, 22, 47
Gemini	45	Sheritech	34
Hamlin	14, 15	Starcom	30
Hitachi	25	Sylvania	16
Jerrold	00,01,02,03,04,05,46,55	Texscan	48
Macom	29, 38	Tocom	12,13, 53
Magnavox	17, 31	Toshiba	43
NSC	49	Uniden Satellite	44
Oak	06, 27, 39	Unika	50
Panasonic	18, 35	United Satellite	54
Philips	19, 20, 21, 24, 26	Universal	36
Pioneer	09, 32	Video Tech	40
Regency	10, 11	Video Way	51
		Zenith	07, 41, 42



Now that you have looked up the two-digit Remote Code Number for your brand of Cable Converter (on previous page), you are ready to follow the four simple steps below.

Please read through steps 1-4 before beginning.

BEGIN

- 1 Press and release the STATUS button.
- 2 Within thirty seconds after releasing the REC button, press and release the CBL System button.
- 3 Within thirty seconds after releasing the CBL System button, ENTER THE TWO DIGIT CODE NUMBER for the desired Converter. The remote is now ready to send commands to the Converter.
- 4 Point the remote at the Converter. Press the POWER button on the remote to turn the Converter ON.

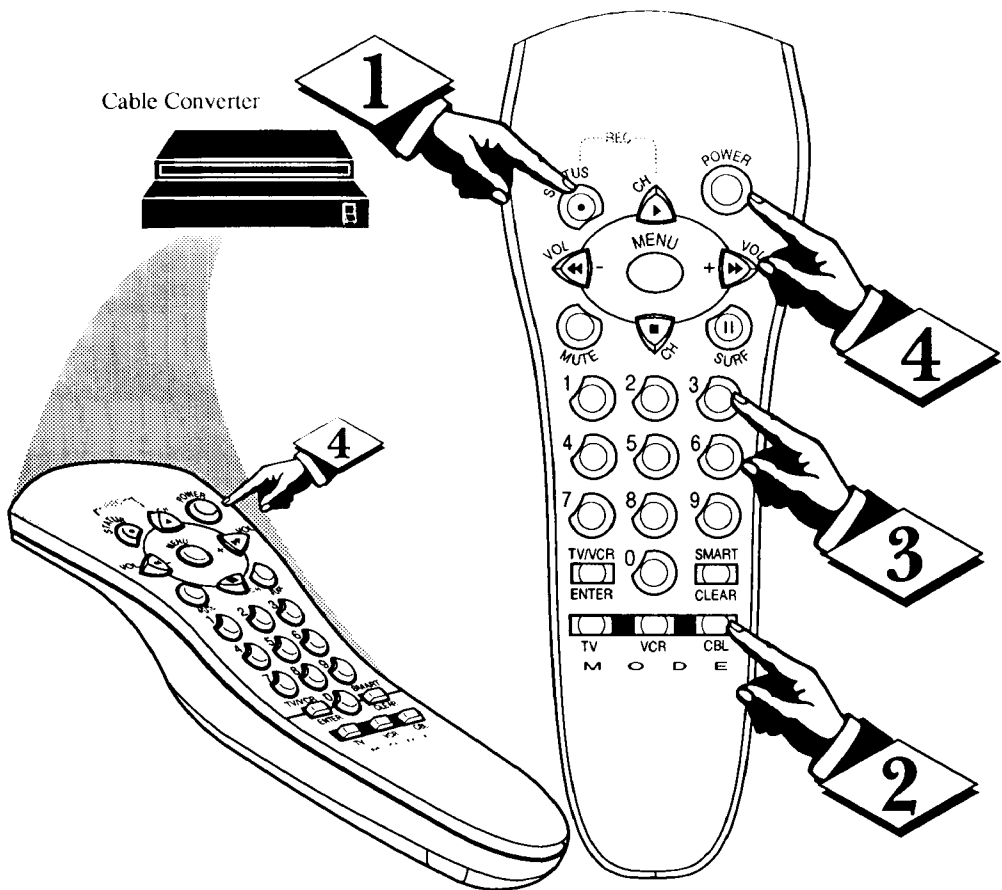

SMART HELP



Try it out. The Channel and POWER buttons on the remote should now operate the Converter.

Remember, if this doesn't work the first time, repeat steps using the same remote code number.

If after a second try the remote does not operate your Converter, and there are more code numbers listed for your brand Converter, use the next listed code number.

If after repeated attempts the code number method does not work your Converter, try the "CONVERTER SEARCH" method on page 26.

Your TV remote can be set to work your VCR or Cable Converter by what is called the **SEARCH** method.

If the "REMOTE CODE" number method shown in the previous section did not set your remote to work your VCR or Converter, then follow the easy steps listed below.

Please read through steps 1-4 before beginning.

BEGIN

- 1 Press the **POWER** button on the VCR or Converter to turn the unit ON.
- 2 Stand at least six feet away from the front of the VCR or Converter. Point the remote toward the unit. **HOLD DOWN** the **SURF** and the desired System (**VCR** or **CBL-Converter**) buttons at the same time. **KEEP HOLDING** **BUTTONS DOWN**.
- 3 Watch the **Channel Indicator** on the unit. Channel Numbers will **SCAN UP** when the unit has been identified. This may take up to two minutes.
- 4 Release the **SURF** and System (**VCR** or **CBL**) buttons as soon as channel numbers start to scan up. The code has been identified and the remote is ready to operate with the VCR or Converter.



SMART HELP



Remember, a minute or two can seem very long, but the code should be located within two minutes.

Don't let the VCR scan up more than five channels. If you do the remote may pass up the right code and another two minute search cycle will have to be repeated.

If no channel change happens within two minutes, repeat steps 1-4. Should a channel change still not occur, the remote will not work with the desired unit.

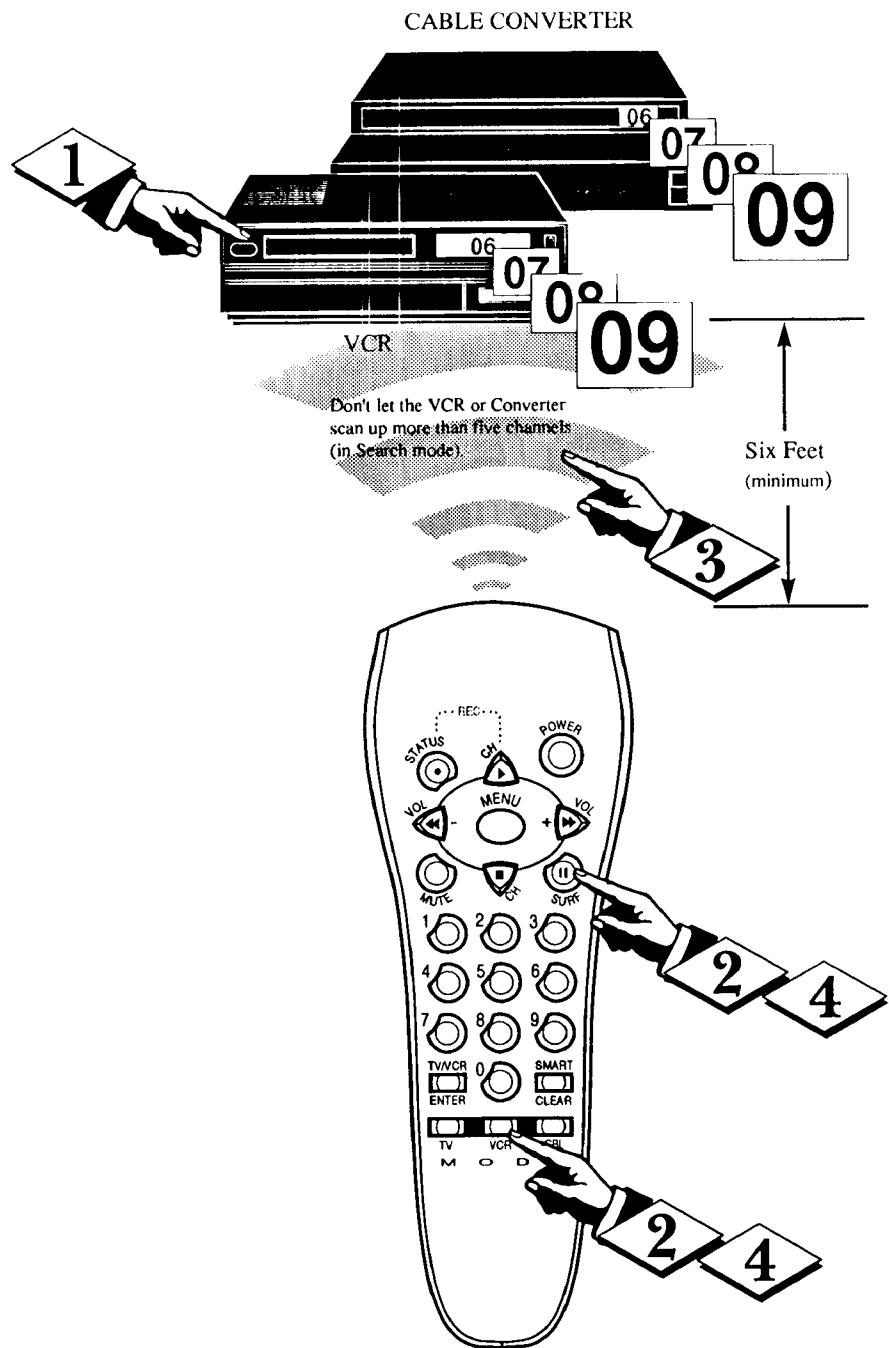



Please make these simple checks before calling for service. These tips can save you time and money since charges for TV installation and adjustment of customer controls are not covered under your warranty.

No Power

CAUTION: A video source (such as a video game, Compact Disc Interactive - CDI, or TV information channel) which shows a constant non-moving pattern on the TV screen, can cause picture tube damage. When your TV is continuously used with such a source the pattern of the non-moving portion of the game (CDI, etc.) could leave an image permanently on the picture tube. When not in use, turn the video source OFF. Regularly alternate the use of such video sources with normal TV viewing.

- Check the TV power cord. Unplug the TV, wait 10 seconds, then reinsert plug into outlet and push POWER button again.
- Check to be sure outlet is not on a wall switch.

No Picture

- Check antenna connections on the rear of the TV. Are they properly secured to the antenna plug on the TV?
- Check the CABLE/ YES NO control for correct position.
- Check INPUT control for correct position. VCR-AUX position without a signal source will result in a blank screen.

No Sound

- Check the VOLUME buttons.
- Check the MUTE button on the remote control.
- Check the TV SPEAKER switch on the rear of the TV. OFF position will eliminate sound at the set.
- If attempting auxiliary equipment hook-ups, check audio jack connections.

Remote Does Not Work

- Check TV-VCR-CBL "System" buttons on the remote. Press the remote's TV System button to send commands to the TV.
- Check batteries. Replace with AA Heavy Duty (Zinc Chloride) or Alkaline batteries if necessary.
- Clean the remote and the remote sensor window on the TV.
- Check the TV power cord. Unplug the TV, wait 10 seconds, then reinsert plug into outlet and push POWER button again.
- Check to be sure TV outlet is not on a wall switch.

TV Displays Wrong Channel or No Channels Above 13

- Repeat channel selection.
- Add desired channel numbers (CHANNEL control) into TV memory.
- Check CABLE/ YES NO control for correct position.

This TV is equipped with protective circuitry that shuts the TV off in case of moderate power surges. Should this occur turn the TV back on by pressing the POWER button once or twice, or unplug (wait 10 seconds) and then replug the power cord at the AC outlet. This feature is NOT designed to prevent damage due to high power surges such as those caused by lightning, which is not covered by your warranty.

Cleaning and Care

- To avoid possible shock hazard be sure the TV is unplugged from the electrical outlet before cleaning.
- When cleaning the TV screen take care not to scratch or damage the screen surface (avoid wearing jewelry or using anything abrasive). Wipe the front screen with a clean cloth dampened with water. Use even, easy, vertical strokes when cleaning.
- Gently wipe the cabinet surfaces with a clean cloth or sponge dampened in a solution of cool clear water. Use a clean dry cloth to dry the wiped surfaces.
- Occasionally vacuum the ventilation holes or slots in the cabinet back.
- Never use thinners, insecticide sprays, or other chemicals on or near the cabinet, as they might cause permanent marring of the cabinet finish.



GLOSSARY TO TELEVISION TERMS

Coaxial Cable * A single solid antenna wire normally matched with a metal plug (F-type) end connector that screws (or pushes) directly onto a 75 Ohm input found on the Television or VCR.

Closed Caption * Broadcast standard which allows you to read the voice content of television programs on the TV screen. Designed to help the hearing impaired this feature uses on-screen "text boxes" to show dialogue and conversations while the TV program is in progress.

Display * An on screen message or graphics that help the user operate and adjust his Television feature controls. See On Screen Displays (OSD).

Direct Audio/Video Inputs * Located on the rear of the TV these connectors (RCA phono type plug) are used for the input of audio and video signals. Designed for use with VCRs (or other accessories) in order to receive higher picture resolution and offer sound connection options.

Multichannel Television Sound (MTS) * The broadcast standard that allows for stereo sound to be transmitted with the TV picture.

On Screen Displays (OSD) * Refers to the wording or messages generated by the television (or VCR) to help the user with specific feature controls (color adjustment, programming, etc.).

Menu * An on-screen listing of feature controls shown on the Television screen that are made available for user adjustments.

Programming * The procedure of adding or deleting channel numbers into the Television's memory circuits. In this way the Television "remembers" only the locally available or desired channel numbers and skips over any unwanted channel numbers.

Remote Sensor Window * A window or opening found on the Television control panel through which infrared remote control command signals are received.

Setup Mode * Automatic feature control settings made by the TV. Designed for first time set-up and use. Settings for signal connections (antenna or cable TV), plus channel program memory are held in the TV's memory (even if the set is unplugged and moved to a new location.)

Second Audio Program (SAP) * Another or additional audio channel provided for in the Multichannel Television Sound (MTS) broadcast standard. The most frequently proposed use for SAP is the simultaneous bilingual broadcast of TV program material.

Status * Allows the user to quickly confirm what channel number is currently being viewed. Status can also be used to clear the Television of on screen displays or information (rather than waiting for the displays to "time out" or automatically disappear from the screen).

Twin Lead Wire * The more commonly used name for the two strand 300 Ohm antenna wire used with many indoor and outdoor antenna systems. In many cases this type of antenna wire requires an additional adapter (or balun) in order to connect to the 75 Ohm Input terminals designed into the more recent Televisions and VCRs.

INDEX

Accessories/Optional.....	5, 16-17
Adapter Connector	5, 16-17
Add/Delete Channels.....	7, 9-10
Surf	21
Audio/Video Input and Output Jacks	16-17
Battery Installation.....	6
Cable TV Connections/Settings.....	7, 8
Channel Display.....	6
Channel Memory	7, 9-10
Closed Captioning	11
Controls/TV	6, 7
Controls/Remote.....	6, 7, 18-26
Factory Service Locations	29-30
Features.....	4
Glossary TV Terms.....	28
Input Control.....	17
Inputs/Audio and Video.....	17
Language Option	17
Memory/Program Channels	7, 9-10
Menu Button.....	6, 7, 18-19
Minus(-)/Plus (+) Buttons	6, 7, 18-19
Output (Audio) Jacks.....	16
Precautions/Safety	2, 3, 27
Programming Channels.....	7, 9-10
Remote Control	6, 7, 18-26
Requesting Service	27, 29-31
RF Coaxial Cable.....	5
Safety/Precautions	2, 3, 27
Second Audio Program.....	12
Sensor Remote	6
Set Up/First Time Use	7
Sleep Timer.....	14
Smart Picture	20
Smart Sound.....	20
Status Button	7, 18-19
Stereo	12
Tips If Something Isn't Working.....	27
VCR/TV Connections.....	5, 17
Volume Bar Control	13
Warranty	31

Philips Consumer Electronics Company Factory Service Center Locations

See Reverse Side for More Details.

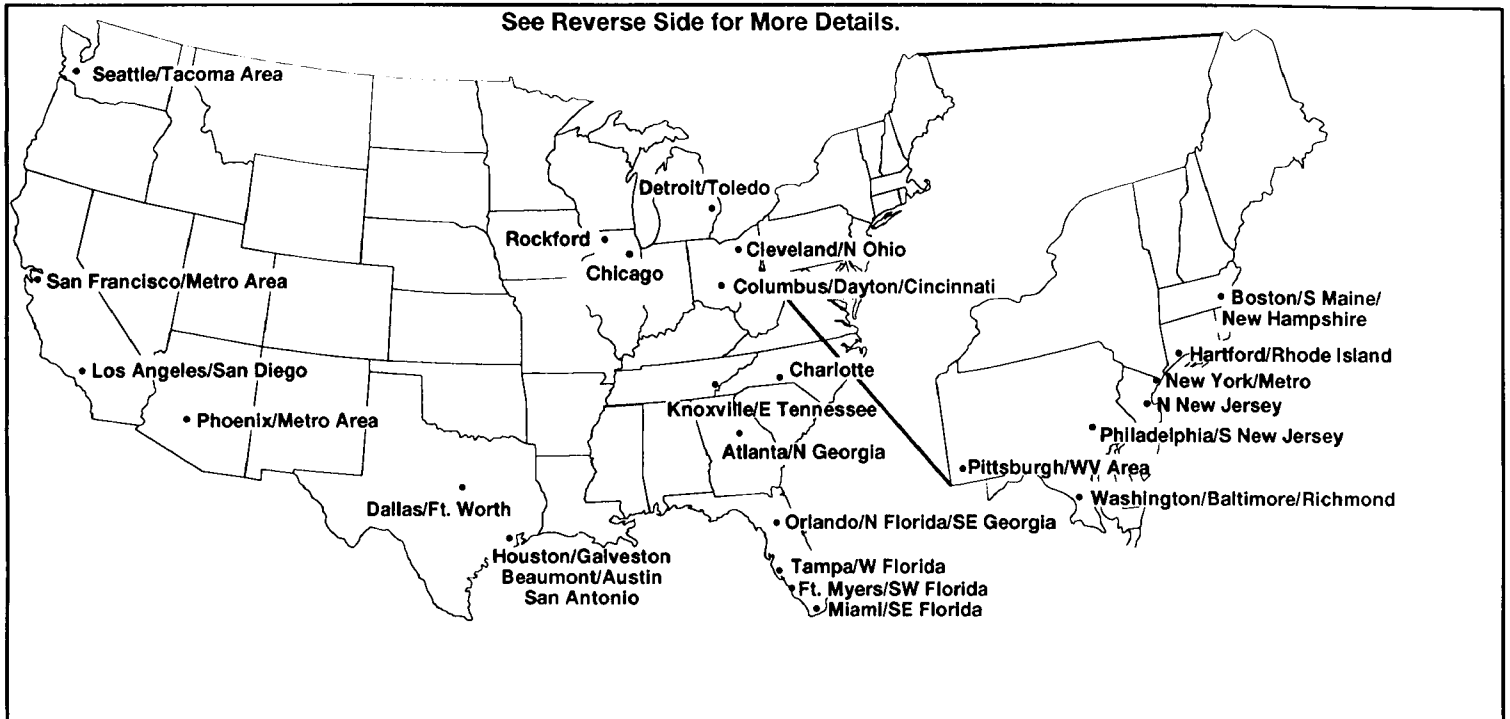

NOTE: If you reside in one of our Philips Factory Service Branch areas (see directory on back), you can contact the nearest Service Branch to obtain efficient and expedient repair for your product. If your product is In-Warranty, you should have proof-of-purchase to ensure No Charge Service. For Out-of-Warranty service, call the location nearest you.

NOTA: Si vous résidez dans une des régions desservies par une succursale de service après vente du fabricant Philips (voir liste ci-dessous), vous pourrez contacter la branche de service après vente la plus près de chez vous pour obtenir un service après vente rapide et efficace. Si le produit est sous garantie, il suffira de présenter une preuve d'achat pour bénéficier d'un service sans frais. Pour les produits non couverts par la garantie, contactez le centre le plus près de chez vous.

NOTA: Si Ud. reside en una de nuestras zonas para sucursales Philips de servicio al de fábrica (ver directorio más abajo), Ud. puede comunicarse con la sucursal de servicio más cercana para obtener una reparación oportuna y eficaz de su producto. Si su producto está todavía bajo garantía, Ud. debe presentar comprobante de compra para no ocasionar ningunos cargos por servicio. Para servicio después del vencimiento de la garantía, llame al lugar más cercano de los abajo indicados.

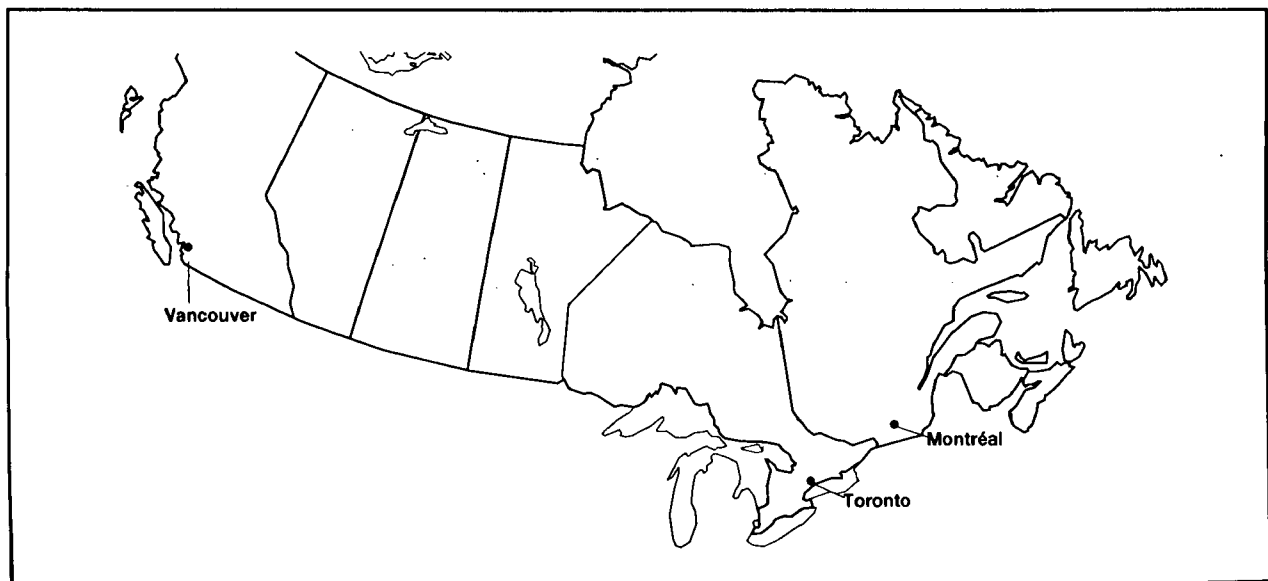

QUALITY SERVICE IS AS CLOSE AS YOUR TELEPHONE! SIMPLY LOOK OVER THE LIST BELOW FOR THE NUMBER OF A FACTORY SERVICE CENTER NEAR YOU. YOUR PRODUCT WILL RECEIVE EFFICIENT AND EXPEDIENT CARRY-IN, MAIL-IN, OR IN-HOME SERVICE, AND YOU WILL RECEIVE PEACE OF MIND, KNOWING YOUR PRODUCT IS BEING GIVEN THE EXPERT ATTENTION OF PHILIPS' FACTORY SERVICE. AND, IF THE PHONE NUMBER LISTED FOR YOUR AREA IS LONG DISTANCE, CALL 1-800-242-9225 FOR FACTORY SERVICE.

COMMENT OBTENIR NOTRE SERVICE APRÈS VENTE RAPIDE ET EFFICACE SOIT PAR COURRIER, À DOMICILE, OU EN SE PRÉSENTANT À UN CENTRE DE SERVICE PHILIPS. PLUS DE 600 CENTRES DE RÉCEPTION DE PRODUITS À RÉPARER À TRAVERS LE PAYS: CONTACTER LE CENTRE DE SERVICE AUX CONSOMMATEURS LE PLUS PROCHE POUR SAVOIR L'EMPLACEMENT DE CES DÉPÔTS DANS UN RAYON DE 50 À 75 MILES (80 KM À 120 KM) DU CENTRE DE SERVICE LOCAL.

CÓMO OBTENER UN SERVICIO OPORTUNO Y EFICIENTE POR CORREO, EN CASA O EN PERSONA PARA SU PRODUCTO A TRAVÉS DE UN CENTRO PHILIPS DE SERVICIO. MAS DE 600 SITIOS POR TODO EL PAIS PARA LA RECEPCION DE PRODUCTOS NECESITADOS DE REPARACIONES: COMUNICARSE CON EL CENTRO DE SERVICIO DE FABRICA MAS CERCANO PARA ESTOS LUGARES DENTRO DE UN RADIO DE 80 A 120 KM (50 A 75 MILLAS) DEL CENTRO DE SERVICIO LOCAL.

<p>Atlanta-Athens-Macon-Chattanooga, TN-North Georgia Area 1898 Leland Drive Marietta, GA 30067 (404) 952-3279</p> <p>Boston-Southern Maine-Southern New Hampshire Area 1 North Avenue Burlington, MA 01803 (617) 272-4825</p> <p>Charlotte-Winston Salem-Greensboro-Chapel Hill-Raleigh-Spartanburg, SC Area 520-G Clanton Road Charlotte, NC 28217 (704) 529-6330</p> <p>Chicago-Gary Area 1360 W. Hamilton Parkway Itasca, IL 60143 (708) 775-0990</p> <p>Cleveland-Akron-Youngstown Area 24090 Detroit Road Westlake, OH 44145 (216) 899-2040</p> <p>Columbus-Dayton-Cincinnati Area 6333 Busch Blvd. Columbus, Ohio 43229 (614) 781-2605</p>	<p>Connecticut-Rhode Island-Springfield, MA Area 1294 Blue Hills Avenue Bloomfield, CT 06002 (860) 726-9612</p> <p>Dallas-Ft. Worth Area 13375 Stemmons Freeway, Suite 200 Dallas, Texas 75234 (214) 243-4775</p> <p>Detroit/Toledo Area 25173 Dequindre Madison Heights, MI 48071 (810) 544-2110</p> <p>Knoxville-Greenville-Tri Cities-East Tennessee Area 6700 D. Papermill Road Papermill Plaza Knoxville, TN 37919 (423) 584-6614</p> <p>Ft. Myers-Naples-Southwest Florida Area 11601 Cleveland Ave., Suite 15 Ft. Myers, FL 33907 (813) 278-4242</p> <p>Houston-Galveston-Beaumont-Austin-San Antonio Area 1110 North Post Oak Road Suite 100 Houston, TX 77055 (713) 682-3990</p>	<p>Los Angeles-San Diego Area 2910 E. LaPalma, Suite E Anaheim, CA 92806 (714) 238-7250</p> <p>Miami-Southeast Florida Area 2099 W. Atlantic Blvd. Pompano Beach, FL 33069 (305) 978-0467</p> <p>North NJ-Staten Island-Rockland County, NY Area 140J Commerce Way Totowa, NJ 07512 (201) 890-7200</p> <p>New York Metro Area 116 Charlotte Avenue Hicksville, NY 11801 (516) 933-1780 Nassau County</p> <p>Orlando-Jacksonville-North Florida-Southeast Georgia Area 2452 Sand Lake Road Orlando, FL 32809 (407) 857-8998</p> <p>Philadelphia/S. New Jersey Area 352 Dunks Ferry Road Bensalem, PA 19020 (215) 638-7500</p> <p>Phoenix-Scottsdale-Mesa-Tempe Area 5032 S. Ash Avenue, Ste. 101 Tempe, AZ 85282 (602) 897-7358</p>	<p>Pittsburgh, PA-Steubenville, OH-Wheeling/Morgantown, WV Area 2891 Banksville Road Pittsburgh, PA 15216 (412) 563-8020</p> <p>Rockford-Kenosha-Beloit-Madison Area 5602 N. Second Loves Park, IL 61111 (815) 654-7343</p> <p>San Francisco-Oakland-San Jose Area 3370 Montgomery Drive Santa Clara, CA 95054 (408) 492-9013</p> <p>Seattle-Tacoma/Olympia Area 1055 Andover Park East Tukwila, WA 98188 (206) 575-6288</p> <p>Tampa-St. Petersburg-Sarasota Area Center Point Business Park, Building B-1, Suite 100 1911 U.S. Hwy. 301 North Tampa, FL 33619 (813) 621-8181</p> <p>Washington, DC-Baltimore-Richmond, VA Area 6671-J Santa Barbara Road Elkridge, MD 21227 (410) 796-0105</p>
---	---	---	--

HOW YOU CAN OBTAIN EFFICIENT AND EXPEDIENT CARRY-IN, MAIL-IN, OR IN-HOME SERVICE IN CANADA FOR YOUR PRODUCT THROUGH A PHILIPS CONSUMER SERVICE CENTER

COMMENT OBTENIR NOTRE SERVICE APRÈS VENTE RAPIDE ET EFFICACE SOIT PAR COURRIER, À DOMICILE, OU EN SE PRÉSENTANT À UN CENTRE DE SERVICE PHILIPS

CÓMO OBTENER UN SERVICIO OPORTUNO Y EFICIENTE POR CORREO, EN CASA O EN PERSONA EN EL CANADA PARA SU PRODUCTO A TRAVÉS DE UN CENTRO PHILIPS DE SERVICIO AL CONSUMIDOR

<p>TORONTO 601 Milner Avenue Scarborough, Ontario M1B 1M8 (416) 754-6064 (Tel.) (416) 292-5161 (Tel.) (416) 754-6290 (Fax)</p>	<p>MONTRÉAL 4977 Levy Street St. Laurent, Québec H4R 2N9 (514) 956-0120 (Tel.) (514) 956-0828 (Fax)</p>	<p>VANCOUVER 1741 Boundary Road Vancouver, B.C. V5M 3Y7 (604) 294-3441 (Tel.) (604) 294-3574 (Fax)</p>
---	--	---

MAC2929 8/95



COLOR TELEVISION

90 Days Free Labor

One Year Free Replacement of Parts (Two Years Free Replacement on Color Picture Tube)

This product can be repaired in-home.

WHO IS COVERED?

You must have proof of purchase to receive warranty service. A sales receipt or other document showing that you purchased the product is considered proof of purchase.

WHAT IS COVERED?

Warranty coverage begins the day you buy your product. *For 90 days thereafter*, all parts will be repaired or replaced free, and labor is free. From 90 days to one year from the day of purchase, all parts will be repaired or replaced free, but you pay for all labor charges. From one to two years from the day of purchase, you pay for the replacement or repair of all parts except the picture tube, and for all labor charges. After two years from the day of purchase, you pay for the replacement or repair of all parts, and for all labor charges.

All parts, including repaired and replaced parts, are covered only for the original warranty period. When the warranty on the product expires, the warranty on all replaced and repaired parts also expires.

WHAT IS EXCLUDED?

Your warranty does not cover:

- labor charges for installation or setup of the product, adjustment of customer controls on the product, and installation or repair of antenna systems outside of the product.
- product repair and/or part replacement because of misuse, accident, unauthorized repair or other cause not within the control of Philips Consumer Electronics Company.
- reception problems caused by signal conditions or cable or antenna systems outside the unit.
- a product that requires modification or adaptation to enable it to operate in any country other than the country for which it was designed, manufactured, approved and/or authorized, or repair of products damaged by these modifications.
- incidental or consequential damages resulting from the product. (Some states do not allow the exclusion of incidental or consequential damages, so the above exclusion may not apply to you. This includes, but is not limited to, prerecorded material, whether copyrighted or not copyrighted.)
- a product used for commercial or institutional purposes.

WHERE IS SERVICE AVAILABLE?

Warranty service is available in all countries where the product is officially distributed by Philips Consumer Electronics Company. In countries where Philips Consumer Electronics Company does not distribute the product, the local Philips service organization will attempt to provide service (although there may be a delay if the appropriate spare parts and technical manual(s) are not readily available).

MAKE SURE YOU KEEP...

Please keep your sales receipt or other document showing proof of purchase. Attach it to this owner's manual and keep both nearby. Also keep the original box and packing material in case you need to return your product.

BEFORE REQUESTING SERVICE...

Please check your owner's manual before requesting service. Adjustments of the controls discussed there may save you a service call.

TO GET WARRANTY SERVICE IN U.S.A., PUERTO RICO OR U.S. VIRGIN ISLANDS...

Contact a Philips factory service center (see enclosed list) or authorized service center to arrange repair.

(In U.S.A., Puerto Rico and U.S. Virgin Islands, all implied warranties, including implied warranties of merchantability and fitness for a particular purpose, are limited in duration to the duration of this express warranty. But, because some states do not allow limitations on how long an implied warranty may last, this limitation may not apply to you.)

TO GET WARRANTY SERVICE IN CANADA...

Contact a Philips consumer service center (listed below), self-servicing dealer or authorized service depot to arrange repair.

Philips Electronics Ltd.

601 Milner Avenue, Scarborough, Ontario, M1B 1M8

(416) 292-5161

4977 Levy Street, St. Laurent, Québec, H4R 2N9

(514) 956-0210

1741 Boundary Road, Vancouver, B.C., V5M 3Y7

(604) 294-3441

(In Canada, this warranty is given in lieu of all other warranties. No other warranties are expressed or implied, including any implied warranties of merchantability or fitness for a particular purpose. Philips is not liable under any circumstances for any direct, indirect, special, incidental or consequential damages, howsoever incurred, even if notified of the possibility of such damages.)

REMEMBER...

Please record the model and serial numbers found on the product below. Also, please fill out and mail your warranty registration card promptly. It will be easier for us to notify you if necessary.

MODEL #

SERIAL #

Philips Service Company, P.O. Box 555, Jefferson City, Tennessee 37760
(423) 475-8869

Optional Accessories

Prices subject to change without notice. Availability subject to change at time of purchase. When ordering accessories outside the U.S.A., please refer to the accessories material, address, and prices for that country.

Maximize your viewing pleasure with state-of-the-art accessories designed specifically for your Color Television. The optional accessories shown in this booklet may be purchased from your local dealer, or may be ordered direct from Philips Consumer Electronics Company.

Call toll-free

1-800-292-6066

Or write

Philips Consumer

Electronics Co.,

Accessories Marketing Dept.,

P.O. Box 967,

Greenville, TN 37744-0967

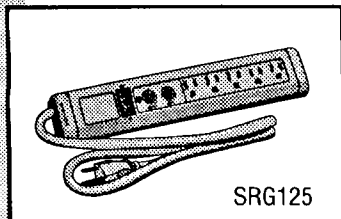

TV/Cable Surge Protector

Your Cost \$19.95

Electrical fluctuations and power surges can damage your valuable electronic entertainment equipment. Protect your antenna, cable, and electrical lines with Magnavox Audio/Video Equipment Surge Protectors.

Features:

- Coaxial cable input/output
- Five grounded outlets
- Built-in LED and reset button

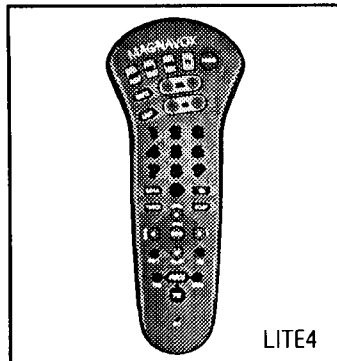

Universal Night Lite™ Audio/Video Remote

Your Cost \$24.95

Replace your lost or broken remote control, or consolidate all your remotes into one. Plus, make remote easier to use in dimly-lit areas, with our Night Lite™ lighted keypad.

Features:

- Preprogrammed
- Autoscan and manual code setup
- On-screen capabilities
- Menu programming
- Spanish instructions included
- Toll-free customer assistance number included

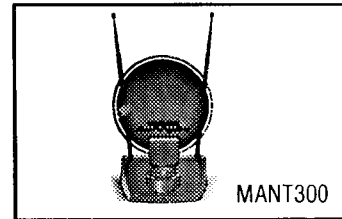

Smart Amplifier Amplified VHF/UHF/FM Indoor Antenna

Your Cost \$34.95

Drastically improves VHF/UHF/FM reception on your TV or stereo. Simply attach antenna to your TV/stereo and enjoy crisper and clearer sound and picture quality. Adjustable UHF loop tilts and rotates for the best possible reception.

Features:

- 39" retractable dipoles
- 6' 75 ohm coax connection cable
- Matching transformer included
- Soft base prevents scratching surfaces
- Active antenna with amplifier with up to 20 dB gain
- LED power indicator on front of antenna: easy to see while watching TV
- Knob on top of antenna serves as gain and power switch
- AC/DC power adapter included
- 90-day warranty

Free Manuals Download Website

<http://myh66.com>

<http://usermanuals.us>

<http://www.somanuals.com>

<http://www.4manuals.cc>

<http://www.manual-lib.com>

<http://www.404manual.com>

<http://www.luxmanual.com>

<http://aubethermostatmanual.com>

Golf course search by state

<http://golfingnear.com>

Email search by domain

<http://emailbydomain.com>

Auto manuals search

<http://auto.somanuals.com>

TV manuals search

<http://tv.somanuals.com>