

51MP6200D
51" Rear Projection TV
51" Téléviseur à Projection
51" Televisión de Proyección

STOP! Thank you for choosing Magnavox.

Need help fast?

Read your Quick Use Guide and/or Owner's Manual first for quick tips that make using your Magnavox product more enjoyable.

If you have read your instructions and still need assistance, you may access our online help at www.magnavox.com/usasupport or call 1-800-705-2000 while with your product (and Model / Serial number)

ARRÊT! Magnavox vous remercie de votre confiance.

Besoin d'une aide rapide?

Les Guide d'utilisation rapide et Manuel de l'utilisateur regorgent d'astuces destinées à simplifier l'utilisation de votre produit Magnavox.

Toutefois, si vous ne parvenez pas à résoudre votre problème, vous pouvez accéder à notre aide en ligne à l'adresse www.magnavox.com/usasupport ou formez le 1-800-705-2000

Veillez à avoir votre produit à portée de main (et model / serial nombre)

ALTO! Gracias por escoger Magnavox.

Necesita ayuda inmediata?

Lea primero la Guía de uso rápido o el Manual del usuario, en donde encontrará consejos que le ayudarán a disfrutar plenamente de su producto Magnavox.

Si después de leerlo aún necesita ayuda, consulte nuestro servicio de asistencia en línea en www.magnavox.com/usasupport o llame al teléfono 1-800-705-2000 y tenga a mano el producto (y número de model / serial)

Quick Use Guide Inside!
Guide d'usage Rapide Incluse!
Guía de Uso Rápido Incluida!

For Customer Use / À l'usage du client /
Para Uso del Cliente

Model/Modle/ModeloNo. : _____

Serial/Srie/Serie No : _____

English

Français

Español

How to make the optimal connection

(only RF cable is provided, for the rest of the cables, please consult your consumer electronics dealer for availability)

Comment réaliser une bonne connexion

(seulement le câble RF est inclus, pour le rest des câbles, de faveur consultez avec son distributeur d'appareils électroniques)

Cómo realizar la mejor conexión

(solo el cable RF está incluido, para el resto de los cables, favor consulte con su distribuidor de aparatos electrónicos)

	Best HDMI High-Definition Multimedia Interface provides an uncompressed, all-digital audio/video connection. HDMI provides the ultimate connection (Please use a certified HDMI cable).	Supérieure HDMI L'interface HDMI (High-Definition Multimedia Interface) propose une connexion décompressée audio/vidéo entièrement numérique. HDMI propose l'ultimate connexion (Veuillez utiliser un câble HDMI certifié).	La mejor HDMI La interfaz multimedia de alta definición (HDMI, por sus siglas en inglés) proporciona una conexión de audio/video completamente digital sin comprimir. La HDMI proporciona la mejor conexión (Sírvese utilizar un cable HDMI certificado).
	Better Component Video input Provides superior picture quality by separating the green, blue and red luminance signals. Typically used with red/white audio cables.	Excellente Entrée vidéo composant Fournit une qualité d'image supérieure en séparant les signaux de luminance vert, bleu et rouge. Utilisée généralement avec les câbles audio rouge/blanc. Remarque: l'entrée vidéo composant apparaît sur le tableau de connexions comme YPbPr.	Mejor Entrada de video componente Proporciona calidad de imagen superior al separar las señales de luminancia verde, azul y roja. Se usa normalmente con cables de audio rojo/blanco. Nota: La entrada de video componente se muestra en el panel de conexión como YPbPr.
	Good S-Video Supplies a better picture than RF and Composite connections. Used with red/white audio cables.	Bonne S-Video Fournit une meilleure image que les connexions RF et composite. Utilisée avec les câbles audio rouge/blanc.	Buena S-Video Brinda una mejor imagen que las conexiones RF y compuestas. Se usa con cables de audio rojo/blanco.
	Basic Composite Audio/Video Separate video (yellow) and audio (red/white) cables that provide a basic connection from the cable box and other devices. Note: The color of audio inputs may differ, e.g. red/white or red/black.	De base Audio/Vidéo Composite Câbles vidéo (jaune) et audio (rouge/blanc) séparés fournissant une connexion de base à partir du boîtier de connexion et autres dispositifs. Remarque: La couleur des entrées audio peut varier, par ex. rouge/blanc ou rouge/noir.	Básica Audio/Video Compuesto Cables de video (amarillo) y audio (rojo/blanco), que proporcionan una conexión básica de la caja de cable y otros dispositivos. Nota: El color de las entradas de audio puede diferir, por ej., rojo/blanco o rojo/negro.
	RF Provides a basic connection for antenna or cable. Provides both audio and video.	RF Fournit une connexion de base pour l'antenne ou le service et la vidéo.	RF Proporciona una conexión de antena o cable básica. Suministra audio y video.

1

AE: **Set-Top Box to TV**
FR: **Boîtier de décodage vers téléviseur**
ES: **De la caja superior o caja de cable al TV**



HDMI

OR/OU/O



RF

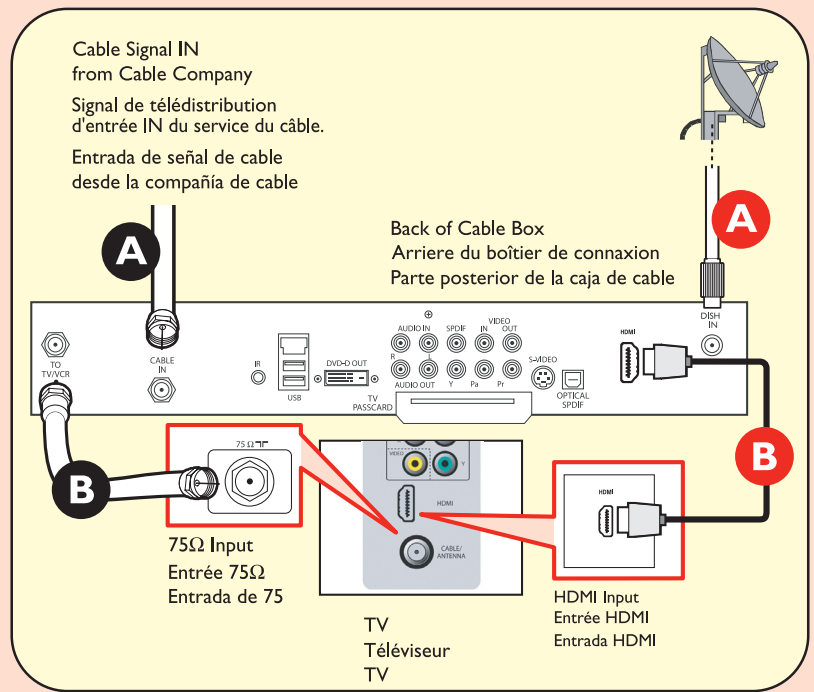

Details refer to page 21.
/Détails, consultez le page 21.
/Para detalles, consulte la pag. 21.

2

AE: **DVD Player/Recorder to TV**
FR: **Lecteur DVD/Enregistreur DVD vers le téléviseur**
ES: **Del reproductor o grabador de DVD**



HDMI

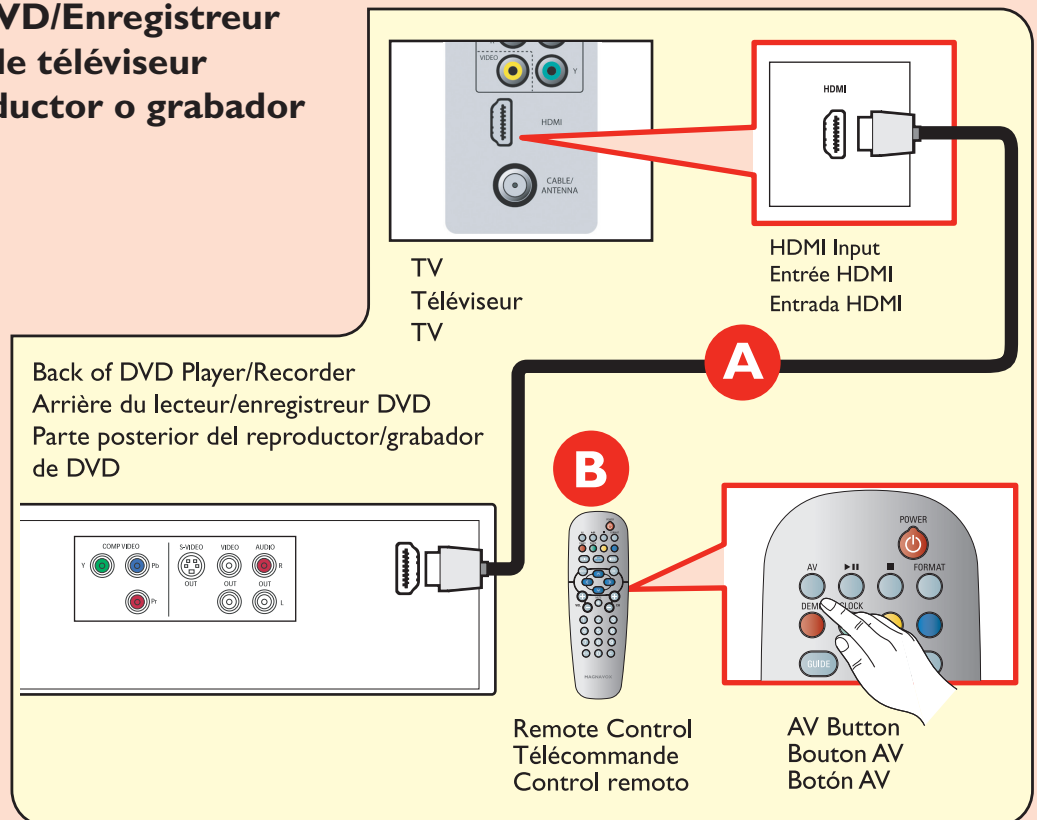

Details refer to page 21.
/Détails, consultez le page 21.
/Para detalles, consulte la pag. 21.

3

AE: **DVD Player or Recorder to TV**
FR: **Lecteur DVD ou Enregistreur vers le téléviseur**
ES: **Del reproductor o grabador de DVD al TV**



Component Video Input
/Entrée vidéo composant
/Entrada de video componente

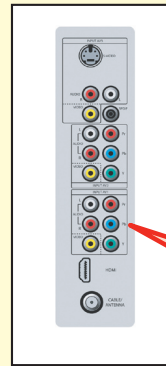

TV
Téléviseur
TV

YPbPr Input
Entrée YPbPr
Entrada YPbPr

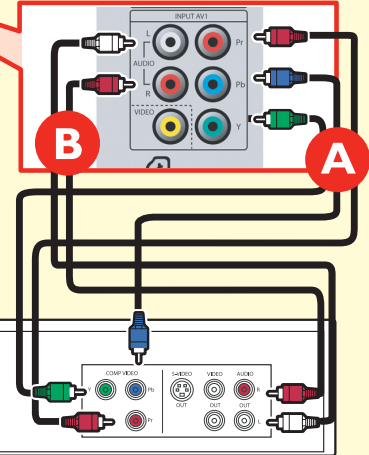

Back of DVD Player/Recorder
Arrière du lecteur/enregistreur DVD
Parte posterior del reproductor/grabador de DVD

C



Remote Control
Télécommande
Control remoto

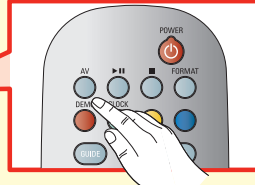

AV Button
Bouton AV
Botón AV

Details refer to page 21.
/Détails, consultez le page 21.
/Para detalles, consulte la pag. 21.

4

AE: **DVD Player/Recorder/VCR to TV**
FR: **Lecteur DVD/Enregistreur DVD/Magnétoscope vers le téléviseur**
ES: **Del reproductor/grabador de DVD/VCR al TV**



S-Video
/S-Vidéo
/S-Video

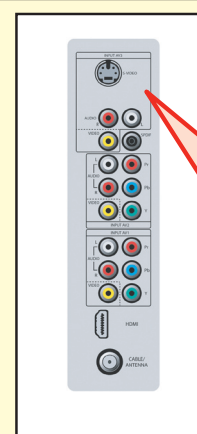

Back of TV
Arrière du Téléviseur
Parte posterior del TV

S-Video Input
Entrée S-Vidéo
Entrada S-Video

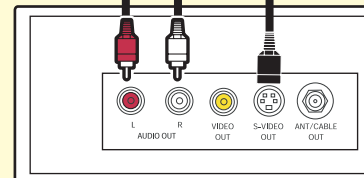
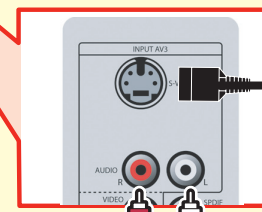

Back of DVD/VCR
Arrière du DVD/Magnétoscope
Parte posterior del DVD/VCR

C



Remote Control
Télécommande
Control remoto

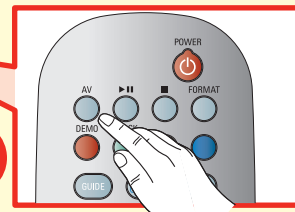

AV Button
Bouton AV
Botón AV

Details refer to page 22.
/Détails, consultez le page 22.
/Para detalles, consulte la pag. 22.

5

AE: **DVD Player/Recorder/VCR to TV**

FR: **Lecteur DVD/Enregistreur DVD/Magnétoscope vers le téléviseur**

ES: **Del reproductor/grabador de DVD/VCR al TV**

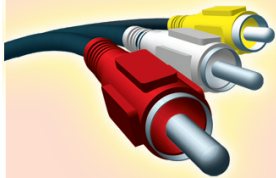

Composite Audio-video
/Audio-Vidéo composite
/Audio-Video compuesto

Details refer to page 22.
/Détails, consultez le page 22.
/Para detalles, consulte la pag. 22.

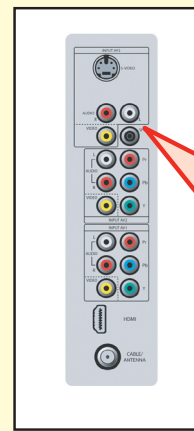

Back of TV
Arrière du Téléviseur
Parte posterior del TV

Composite Audio/video Input
Entrée Audio/Vidéo composite
Entrada Audio/Video compuesto

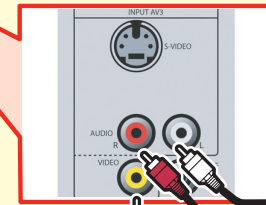

A **B**



Remote Control
Télécommande
Control remoto

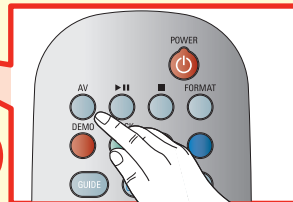

AV Button
Bouton AV
Botón AV

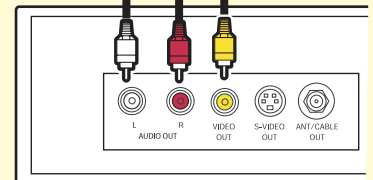

Back of DVD/VCR
Arrière du DVD/Magnétoscope
Parte posterior del DVD/VCR

6

AE: **Video Camera /Games Console to TV**

FR: **Caméra vidéo/Console de jeux vers téléviseur**

ES: **De la cámara de video/ Consola de juegos al TV**

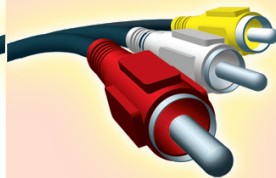

Composite Audio-video
/Audio-Vidéo composite
/Audio-Video compuesto

Details refer to page 22.
/Détails, consultez le page 22.
/Para detalles, consulte la pag. 22.

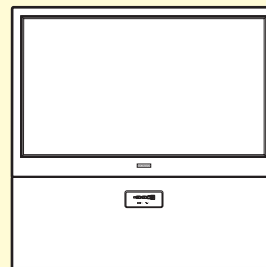

TV Side Jack Panel
/Tableau de connexions du téléviseur
/Panel de enchufes del TV

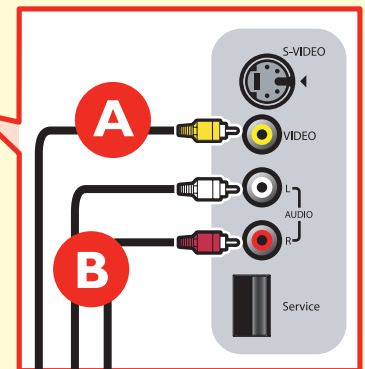

A **B**



Remote Control
/Télécommande
/Control remoto

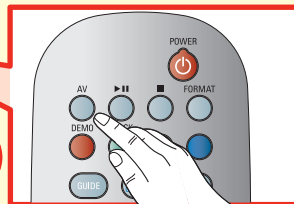

AV Button
/Bouton AV
/Botón AV

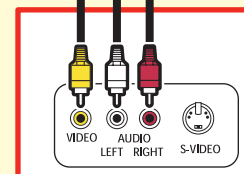

Video Camera Jack Panel
/Panneau de connexions de la caméra vidéo
/Panel de enchufes de la cámara de video

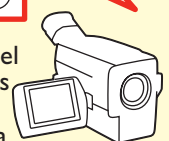

7

AE: **Audio to Hi-fi System (Digital)**

FR: **Audio vers chaîne haute fidélité (Numérique)**

ES: **Audio al sistema Hi-fi (Digital)**



SPDIF

Details refer to page 23.
/Détails, consultez le page 23.
/Para detalles, consulte la pag. 23.

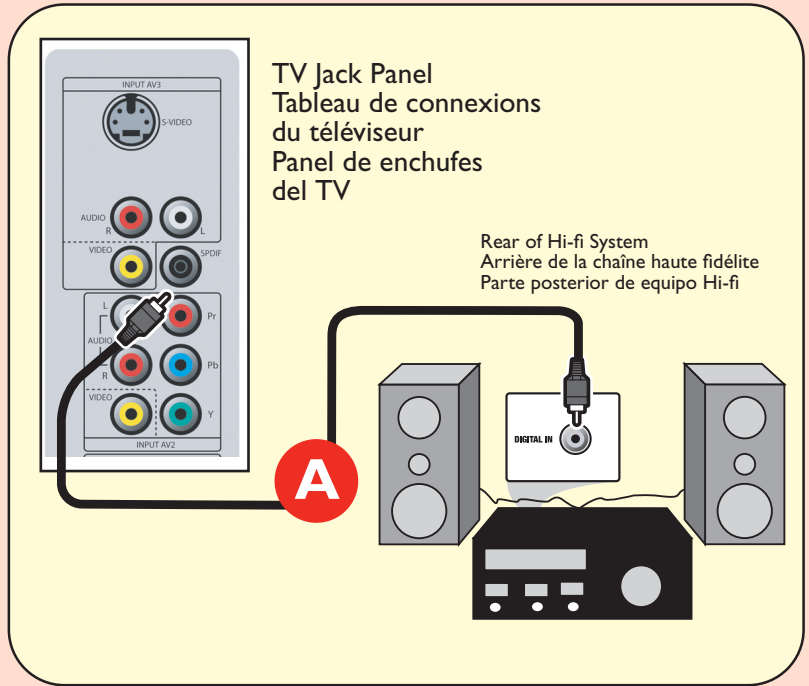

8

AE: **Audio to Hi-fi System**

FR: **Audio vers chaîne haute fidélité**

ES: **Audio al sistema Hi-fi**

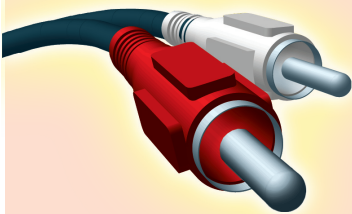

Audio

Details refer to page 23.
/Détails, consultez le page 23.
/Para detalles, consulte la pag. 23.

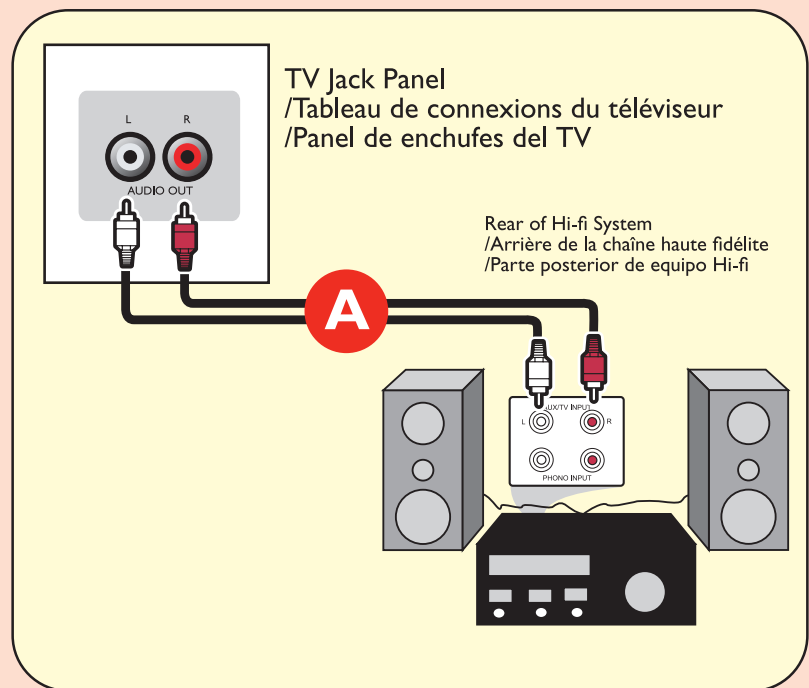

IMPORTANT SAFETY INSTRUCTIONS

Read before operating equipment

1. Read these instructions.
2. Keep these instructions.
3. Heed all warnings.
4. Follow all instructions.
5. Do not use this apparatus near water.
6. Clean only with a dry cloth.
7. Do not block any of the ventilation openings. Install in accordance with the manufacturer's instructions.
8. Do not install near any heat sources such as radiators, heat registers, stoves, or other apparatus (including amplifiers) that produce heat.
9. Do not defeat the safety purpose of the polarized or grounding-type plug. A polarized plug has two blades with one wider than the other. A grounding type plug has two blades and third grounding prong. The wide blade or third prong are provided for your safety. When the provided plug does not fit into your outlet, consult an electrician for replacement of the obsolete outlet.
10. Protect the power cord from being walked on or pinched particularly at plugs, convenience receptacles, and the point where they exit from the apparatus.
11. Only use attachments/accessories specified by the manufacturer.
12.  Use only with a cart, stand, tripod, bracket, or table specified by the manufacturer, or sold with the apparatus. When a cart is used, use caution when moving the cart/apparatus combination to avoid injury from tip-over.
13. Unplug this apparatus during lightning storms or when unused for long periods of time.
14. Refer all servicing to qualified service personnel. Servicing is required when the apparatus has been damaged in any way, such as power-supply cord or plug is damaged, liquid has been spilled or objects have fallen into apparatus, the apparatus has been exposed to rain or moisture, does not operate normally, or has been dropped.
15. This product may contain lead and mercury. Disposal of these materials may be regulated due to environmental considerations. For disposal or recycling information, please contact your local authorities or the Electronic Industries Alliance: www.eiae.org
16. **Damage Requiring Service** - The appliance should be serviced by qualified service personnel when:
 - A. The power supply cord or the plug has been damaged; or
 - B. Objects have fallen, or liquid has been spilled into the appliance; or
 - C. The appliance has been exposed to rain; or
 - D. The appliance does not appear to operate normally or exhibits a marked change in performance; or
 - E. The appliance has been dropped, or the enclosure damaged.
17. **Tilt/Stability**- All televisions must comply with recommended international global safety standards for tilt and stability properties of its cabinet design.
 - Do not compromise these design standards by applying excessive pull force to the front, or top, of the cabinet which could ultimately overturn the product.
 - Also, do not endanger yourself, or children, by placing electronic equipment/toys on the top of the cabinet. Such items could unsuspectingly fall from the top of the set and cause product damage and/or personal injury.
18. **Wall or Ceiling Mounting**- The appliance should be mounted to a wall or ceiling only as recommended by the manufacturer.
19. **Power Lines** - An outdoor antenna should be located away from power lines.
20. **Outdoor Antenna Grounding**- If an outside antenna is connected to the receiver, be sure the antenna system is grounded so as to provide some protection against voltage surges and built up static charges. Section 810 of the National Electric Code, ANSI/NFPA No. 70-1984, provides information with respect to proper grounding of the mast and supporting structure, grounding of the lead-in wire to an antenna discharge unit, size of grounding connectors, location of antenna-discharge unit, connection to grounding electrodes, and requirements for the grounding electrode. See Figure below.
21. **Object and Liquid Entry**
 - Care should be taken so that objects do not fall and liquids are not spilled into the enclosure through openings.
 - a) **Warning:** To reduce the risk of fire or electric shock, this apparatus should not be exposed to rain or moisture and objects filled with liquids, such as vases, should not be placed on this apparatus.
22. **Battery Usage CAUTION** : To prevent battery leakage that may result in bodily injury, property damage, or damage to the unit.
 - Install all batteries correctly, with + and - aligned as marked on the unit.
 - Do not mix batteries (old and new or carbon and alkaline, etc.).
 - Remove batteries when the unit is not used for a long time.

Note to the CATV system installer: This reminder is provided to call the CATV system installer's attention to Article 820-40 of the NEC that provides guidelines for proper grounding and, in particular, specifies that the cable ground shall be connected to the grounding system of the building, as close to the point of cable entry as practical.

Example of Antenna Grounding as per NEC - National Electric Code

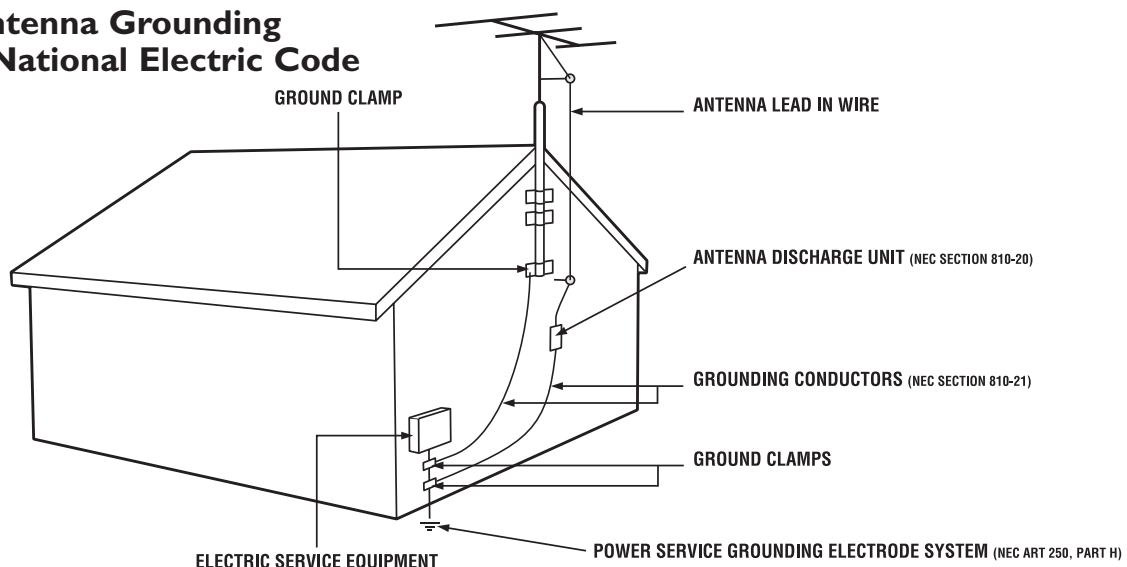

**Return your Product Registration Card or register online at
www.magnavox.com/usasupport today to get the very most from your purchase.**

Registering your model with MAGNAVOX makes you eligible for all of the valuable benefits listed below, so don't miss out. Complete and return your Product Registration Card at once, or register online at www.magnavox.com/usasupport to ensure:

***Proof of Purchase**

Returning the enclosed card guarantees that your date of purchase will be on file, so no additional paperwork will be required from you to obtain warranty service.

***Product Safety Notification**

By registering your product, you'll receive notification - directly from the manufacturer - in the rare case of a product recall or safety defect.

***Additional Benefits**

Registering your product guarantees that you'll receive all of the privileges to which you're entitled, including special money-saving offers.

MAGNAVOX

Congratulations on your purchase, and welcome to the "family!"

Dear MAGNAVOX product owner:

Thank you for your confidence in MAGNAVOX. You've selected one of the best-built, best-backed products available today. We'll do everything in our power to keep you happy with your purchase for many years to come.

As a member of the MAGNAVOX "family," you're entitled to protection by one of the most comprehensive warranties and outstanding service networks in the industry. What's more, your purchase guarantees you'll receive all the information and special offers for which you qualify, plus easy access to accessories from our convenient home shopping network.

Most importantly, you can count on our uncompromising commitment to your total satisfaction.

All of this is our way of saying welcome - and thanks for investing in a MAGNAVOX product.

**P.S. To get the most from your MAGNAVOX purchase, be sure to complete and return your Product Registration Card at once, or register online at:
www.magnavox.com/usasupport**

Know these safety symbols



 This "bolt of lightning" indicates uninsulated material within your unit may cause an electrical shock. For the safety of everyone in your household, please do not remove product covering.

 The "exclamation point" calls attention to features for which you should read the enclosed literature closely to prevent operating and maintenance problems.

WARNING: To reduce the risk of fire or electric shock, this apparatus should not be exposed to rain or moisture and objects filled with liquids, such as vases, should not be placed on this apparatus.

CAUTION: To prevent electric shock, match wide blade of plug to wide slot, fully insert.

ATTENTION: Pour éviter les choc électriques, introduire la lame la plus large de la fiche dans la borne correspondante de la prise et pousser jusqu'au fond.

For Customer Use

Enter below the Serial No. which is located on the rear of the cabinet. Retain this information for future reference.

Model No. _____
Serial No. _____

MAGNAVOX

Visit our World Wide Web Site at <http://www.magnavox.com/usasupport>

Contents

A Guide to Digital TV	2
Preparation	2
Use of the remote control	5
Control Buttons on the TV	6
My Content	6
Installation	7
Select the menu language	7
Store TV channels	7
Weak channel installation	8
Software upgrade	8
To use the menus	9
Introduction	9
How to navigate through the Settings menus	9
Demo	9
Setup menu	10
Preferences	10
Source	13
Clock	13
Convergence	14
TV menu	15
Picture menu	15
Sound menu	16
Features menu	17
Channels menu	18
Connect Accessory Devices	21
Set-Top Box to TV	21
DVD Player/Recorder to TV	21
DVD Player/Recorder/VCR to TV	22
Video Camera/Games Console to TV	22
Audio to Hi-fi System (Digital)	23
Audio to Hi-fi System (Analog)	23
To select connected devices	23
Multimedia Browser	24
Troubleshooting Tips	26
Glossary	28
Care and Cleaning	29
Specifications	30
Annex I - Magnavox TV software upgrade with portable memory	31
Magnavox Limited Warranty	33

Care of the screen

See *Care and Cleaning*, p. 29.

End of life directives

Magnavox is paying a lot of attention to produce environmentally-friendly products in green focal areas. Your new TV contains materials which can be recycled and reused. At the end of its life specialized companies can dismantle the discarded TV to concentrate the reusable materials and to minimize the amount of materials to be disposed off. Please ensure you dispose off your old TV according to local regulations.



Recycling

The materials used in your set are either reusable or can be recycled. To minimise environmental waste, specialist companies collect used appliances and dismantle them after retrieving any materials that can be used again (ask your dealer for further details).

Guide to Digital TV

What is Digital Television (DTV)?

Digital Television (DTV) is a relatively new type of broadcasting that promises to transform television viewing into a whole new experience. Digital technology is used to capture images and sound to deliver a better picture quality. DTV technology is also capable of multicasting and interactive capabilities.

There are many levels of digital television quality. The most common are:

Standard Definition TV (SDTV)

SDTV is the basic level of quality display and resolution for both analog and digital. Transmission of SDTV can be in the traditional (4:3) or widescreen (16:9) format.

Enhanced Definition TV (EDTV)

EDTV is better in picture quality than analog television. The formats for EDTV are 480p widescreen (16:9) or traditional (4:3). EDTV is in the middle range quality between SDTV and HDTV.

High Definition TV (HDTV)

HDTV has the highest quality for digital broadcast formats. Its resolution is widescreen format (16:9). Combined with digitally enhanced sound technology, HDTV sets new standards for sound and picture quality in television.

DTV is by far a more flexible and efficient technology than the analog broadcast system. Analog broadcasts can only provide one program at a time. Digital television can broadcast a high definition program or more than one standard definition program at the same time.

Preparation

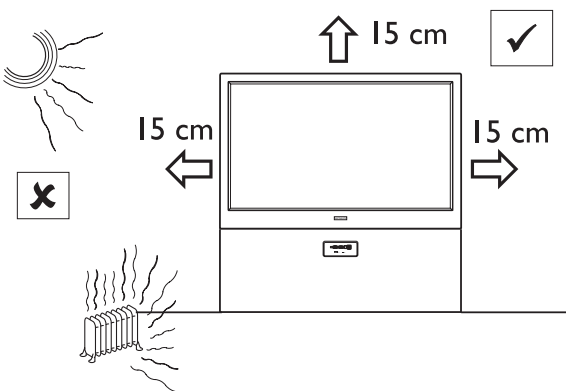

Do not insert the power plug in a wall socket before all connections are made.

The major benefit of this projection television is its large viewing screen. To see the large screen at its best, test various locations in the room to find the optimal spot for viewing.

Be sure to allow a minimum of 15 cm of space around the TV.

To avoid cabinet warping, cabinet colour changes, and increased chance of set failure, do not place the TV where temperatures can become excessively hot – for example, in direct sunlight or near a heating appliance.

Magnetic fields, such as those of external speakers, may cause the picture to distort if the speakers are placed too close to the television. Move the magnetic field source away from the TV until there is no picture distortion.

1 Basic connections to the TV

Your integrated digital TV automatically decodes and displays the four basic DTV picture resolution standards.

- SDTV (Standard Definition TV) are broadcast as 480i (480-line interlaced) or 480p (480-line progressive scan) video.
- HDTV (High-Definition TV) are broadcast either in the 1080i or 720p formats, always with a widescreen picture.

Note: Progressive scan video (p) is more like that you see in a movie theater. Images are much more distinct and free of flicker, and motion is smoother.

Next to analog NTSC broadcast reception, your TV has an integrated High Definition TV tuner which receives, decodes and displays terrestrial ATSC and unscrambled cable (QAM) signals.

HDTV quality is only reproduced when a broadcaster or cable provider broadcasts HDTV signals.

Note: Ask your broadcaster or cable box provider to transmit/enable HD content to your home, and possibly upgrade to a CableCard for the decryption of HD signals.

There are 2 ways to get HDTV content:

- via cable,
- via antenna.

Note: This drawing is used wherever you can connect cable or antenna.

Cable TV

Connect the cable TV signal to the CABLE/ANTENNA 75 Ω jack at the bottom of the TV. See page 8 for details on using "Autoprogram" to store channels in the TV's memory.

Note: this connection will supply stereo sound to the TV if it is being broadcast by the station you are watching.

Cable box with RF IN/OUT

- Connect the incoming cable TV signal to the cable **IN** jack ① on the back of the cable box.
- Connect a coaxial cable (not supplied) from the **TO TV** jack on the back of the cable box to the CABLE/ANTENNA 75 Ω jack ② at the bottom of the TV.
*Note: Your cable box may have a different label for the **TO TV** jack, such as **OUTPUT** or **OUT**.*
- Set the **OUTPUT CH** switch ③ of the cable box to **CH 3** or **4** (whichever is correct for your cable box), then tune the TV to the corresponding channel. Once tuned, change channels at the cable box, not the TV.

*Note: This connection will not supply stereo sound to the TV. The reason is that the RF output on a cable box - labeled **TO TV**, **OUT** or **OUTPUT** for example - will not send a stereo signal to the tuner (VHF/UHF) input on a TV.*

Cable box with A/V outputs

- Connect the incoming cable TV signal ① to a signal splitter (not supplied). The signal splitter enables you to avoid having to use the **TO TV** jack on the back of the cable box. This jack will not supply stereo sound to the TV.
*Note: Your cable box may have a different label for the **TO TV** jack, such as **OUTPUT** or **OUT**.*
- Connect a coaxial cable (not supplied) to a connector on the signal splitter and to the CABLE/ANTENNA 75 Ω jack ② on the TV.
- Connect another coaxial cable (not supplied) to a connector on the signal splitter and to the cable **IN** jack ③ on the back of the cable box.
- Connect A/V cables (not supplied) to the **VIDEO** and **AUDIO L** and **R** outputs on the back of the cable box and to the **AV2** video (labeled **VIDEO**) and **AUDIO** (labeled **L** and **R**) jacks ④ on the back of the TV.
- To view programs from your cable box, first press the **AV** button on the remote control.
- Press the cursor down or up buttons until the **AV2** signal source is selected.
- Press the **OK** button to confirm your selection. The **AV2** input source becomes current for the viewing of cable TV programs through your cable box.

Note: If your cable box Audio/Video outputs will not supply video and stereo audio to the TV, you will need to make the connection shown above in the example "Cable box with RF IN/OUT".

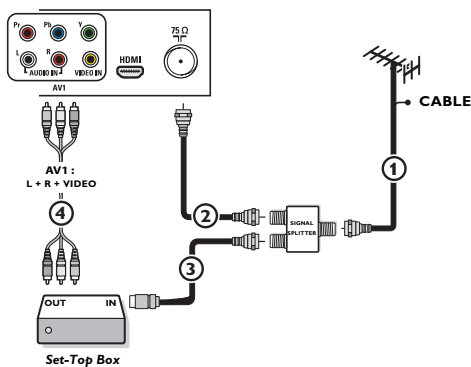
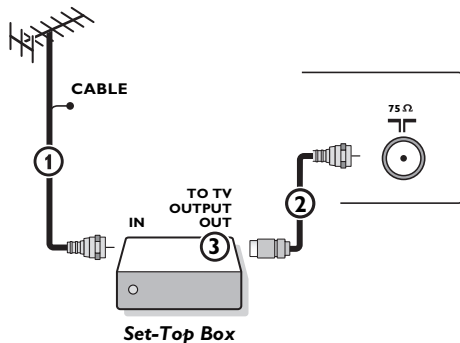
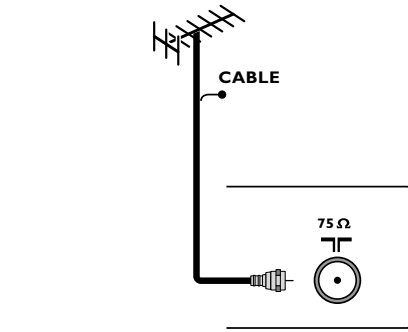

Watching Cable TV programs that don't require the cable box

Since you've connected the cable TV signal directly to the TV's tuner, you can also watch the unscrambled programs by simply tuning to the desired channel. You must first use Autoprogram, however, to store channels in the TV's memory. See page 8.

Note: This connection will supply stereo sound to the TV if it is being broadcast by the station you are watching.

Cable box with S-Video, component video (YPbPr) or HDMI connectors

See Connect Accessory Devices, p. 21-22.

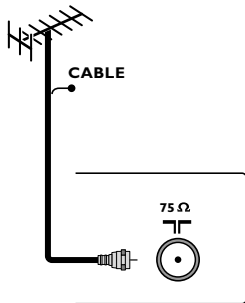

Antenna

Via antenna you can watch whatever DTV programs being broadcast in your area for free.

If you're not sure what HDTV programming is available in your area, contact your local content provider or your local electronics store retailer.

Broadcasters are in the middle of a transition from analog to digital TV. This means that a given broadcaster will have two channels on the air, one analog and one digital.

Connect the incoming antenna signal to the **CABLE/ANTENNA 75 Ω**

Ⓢ jack at the bottom of the TV. See page 8 for details on using Autoprogram to store channels in the TV's memory.

Note: This connection will supply stereo sound to the TV if it is being broadcast by the station you are watching.

Direct Broadcast Satellite (DBS)

Satellite systems offer many of the same premium channels as cable systems, and often at a lower price. To get these channels, you'll need to install a small dish antenna outside.

There are 2 main DBS systems: DirecTV & DishNetwork. These systems require separate, proprietary set top receiver boxes to decode their signals and send them to your digital TV set. These boxes may include a digital TV tuner for off-air DTV broadcasts.

Satellite broadcasters also provide major local channels, depending on the market in which you live.

DBS also provides service in areas not covered by cable because they are in rural areas or other areas not passed by a cable line.

DBS also allows you to watch pay-per-view events.

- 2 Before installing your TV or before hanging it on the wall, connect all your accessory devices. See p. 20.
- 3 Refer to the bottom of the set for the correct operation voltage. Insert the power cord in the wall socket.
Consult your local dealer if your mains supply is different. To prevent damaging the mains (AC) cord which could cause a fire or electric shock, do not place the TV on the cord.
- 4 Remote control:
Insert the 2 batteries supplied (Type R6-1,5V). Be sure the (+) and (-) ends of the batteries line up correctly (inside of case is marked.)
The batteries supplied do not contain the heavy metals mercury and cadmium. Please check on how to dispose of exhausted batteries according to local regulations.
- 5 Turn the TV on:
Press the power switch  at the front of the TV. You may also press **CH+/-** or **POWER** button on the remote control.
An indicator on the front of the TV lights up.

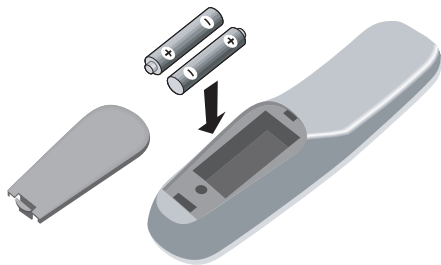

Use of the remote control

Note: For most buttons pressing a button once will activate the function. Pressing a second time will de-activate it. When a button enables multiple options, a small list will be shown. Press repeatedly to select the next item in the list. The list will be removed automatically after 6 seconds or press **OK** to remove immediately.

POWER button

Press to turn on/off the TV from or to standby mode.
The power is never turn off completely unless it is physically unplugged.

AV button

Press this button repeatedly to select **AV1, AV2, AV3, HDMI, SIDE** or **TV** when in TV mode, according to where you connected the accessory devices (p. 21).

▶ and ◀ button

Multimedia browser functional buttons (p.25).

DEMO button

Demo menu on/off. See p. 9.

CLOCK button

On/off and Time display (for max. 10 minutes)

Color buttons

When functions attached to the color buttons, the color buttons are shown on screen.

MY CONTENT button

"My Content" menu on/off, see p. 6.

MENU button

Settings menu on/off, see p. 9.

Cursor buttons

Press the cursor buttons up/down, left/right to navigate through the menus.

VOL +/- button

Press + or - to adjust the volume.

NUMERIC (0-9) buttons

To select TV channels or enter values in the on-screen menu. For single channel entries, press the numbered button for the channel you desire. The TV will pause for a second or two before changing to the chosen channel.

DOT button

To enter values for minor channels e.g. 36.4

A/CH

Press to alternate between the currently viewed channel and the previously viewed channel.

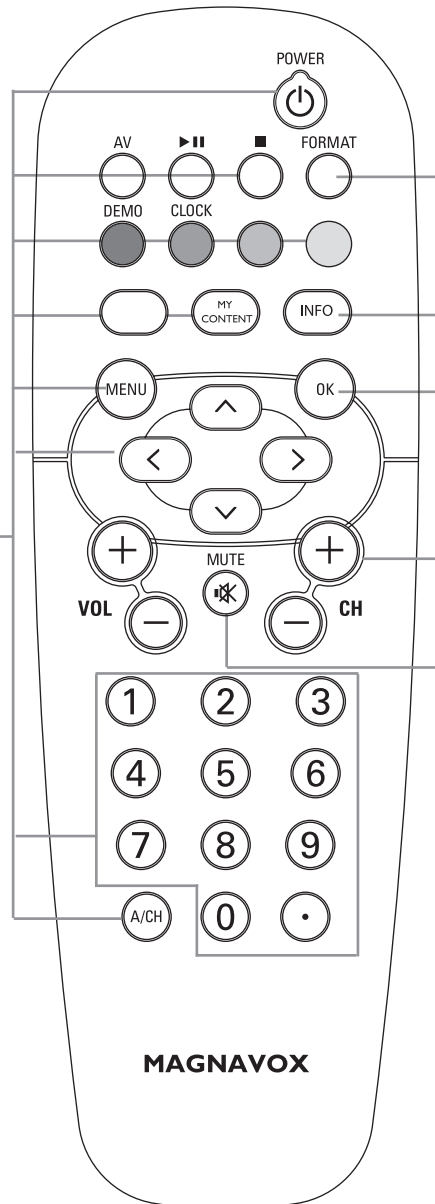

** The quality and accuracy of the information on the information banner are transmitted from broadcasters. You may see a difference in broadcast time if the broadcaster is from a different time zone area.*

FORMAT

Press this button to display a list of available display formats (depending on the receiving signal). This lets you choose the display format of your preference. Press this button repeatedly to select another picture format: Automatic, Super Zoom, 4:3, Movie expand 14:9, Movie expand 16:9, 16:9 subtitle, Wide screen.

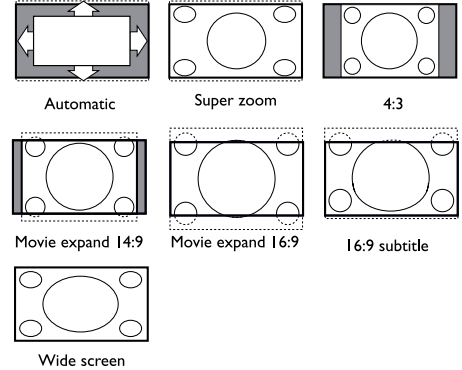

Automatic makes the picture fill the screen as much as possible.

Super zoom removes the black bars on the sides of 4:3 programs with minimal distortion.

When in Movie expand 14:9, Movie expand 16:9 or Super zoom picture format, you can make subtitles visible with the cursor up/down.

Note: With HD sources not all screen formats will be available.

*INFO

Display information: Press to display (when available) information about the selected TV channel and program or accessory device.

OK

- to activate a setting
- to display the list of channels stored (according to the selection made in the Installation mode (Antenna or Cable), p. 7.

CH +/- Channel selection button

- To browse through the TV channels or sources stored in the preferred channel list (see p. 20).
- To select between Antenna or Cable TV channels, first make your selection in the Settings menu, see, p. 7.

Note: You don't have to start the installation again once you have searched for and stored the available TV channels.

MUTE button

Interrupt the sound or restore it.

Control Buttons on the TV

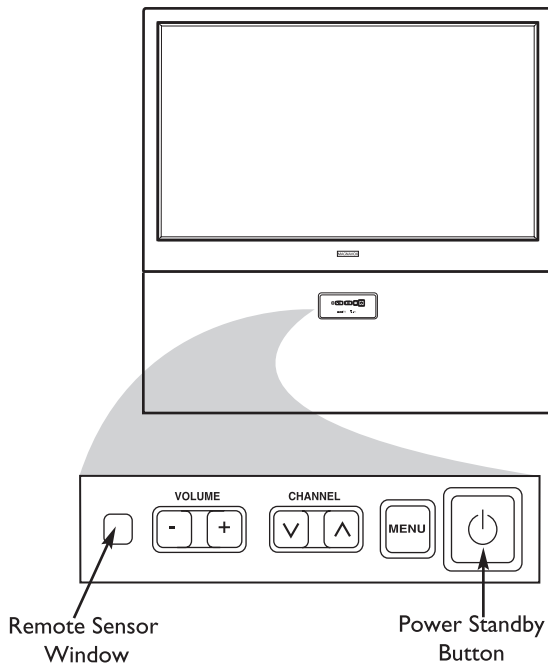

Should your remote be lost or broken you can still change some of the basic settings with the buttons on your TV.
Press the power switch  to switch the TV on.

Press:

- the **+ VOLUME** - button to adjust the volume;
- the **+ CHANNEL** - buttons to select the TV channels or sources.

The **MENU** button can be used to summon the Settings menu without the remote control.

Use:

- the **+ VOLUME** - buttons to select left/right menu items and the **+ CHANNEL** - buttons to select up/down menu items;
- the **MENU** button to confirm your selection.

My Content

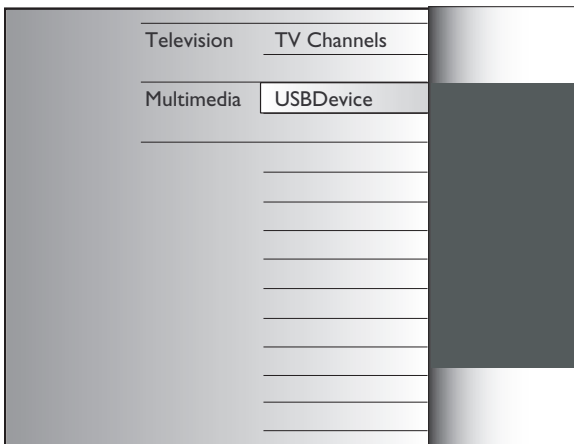

The My Content menu (and the underlying Multimedia browser) is intended to contain all content, services, applications you are interested to consume.

- 1 Press the **MY CONTENT** button to activate.
- 2 Press the cursor up/down to move the highlight up and down in the list of menu items.
- 3 Press the cursor right to go deeper into the structure.

• Television:

TV channels leading to the list of TV channels; the left panel will contain the analog channel numbers, the one-part channel numbers and the major channel numbers in case of two-part digital channels. The right panel will contain the available subchannels associated with the major channel that is currently highlighted on the left panel. If there are no subchannels associated with the currently selected channel in the left panel, the right panel will remain empty.

• Multimedia

Contains the locally connected devices on which content (pictures, audio files) is stored. See Multimedia browser, p. 25.

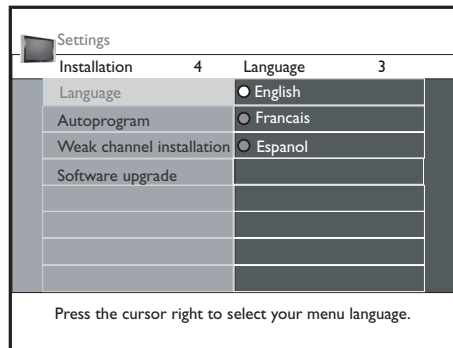

Select the menu language

- ❶ Press the **MENU** button on the remote control.
- ❷ Use the cursor down button to select **Installation** in the Settings menu.
- ❸ Use the cursor right button to enter the Installation menu.
- ❹ Select **Language** and enter the list of available languages with the cursor right button.
- ❺ Select your language with the cursor up/down buttons and press **OK** to confirm your selection.
- ❻ Proceed with the Installation menu.

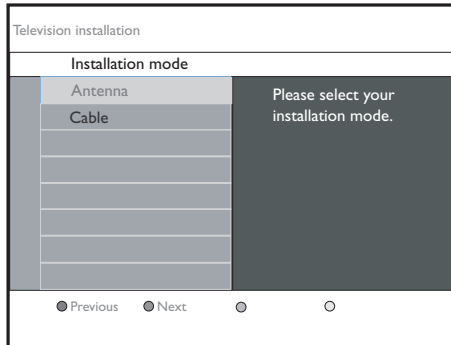

Store the TV channels

- ❶ Select **Autoprogram** in the Installation menu.
- ❷ Use the cursor right button to enter the Autoprogram menu.
- ❸ Press the **OK**.
- ❹ Select **Cable** or **Antenna** in the Installation mode.

When **Antenna** is selected, the TV will detect antenna signals and will search for antenna TV (NTSC and ATSC) channels available in your local area.

When **Cable** is selected, the TV will detect cable company supplied signals and will search for cable TV (NTSC, ATSC, QAM modulated) channels available in your area.

Make sure you complete registration with your cable TV provider and connection of equipment.

- ❺ Press the green button "**Next**" on the remote control.
Note: All channels must be unlocked in order to autoprogram. If requested, enter your PIN code to unlock all channels. See section on Menu preferences under Settings, TV menu.
- ❻ Press the green button "**Start**" to start autoprogramming. The menu screen disappears and the progress of autoprogramming is displayed. The progress bar indicates the number of analog and digital TV channels found.

When Autoprogramming is complete, a message appears confirming the completion. Press the red button "Finish" and the screen returns to the Installation menu.

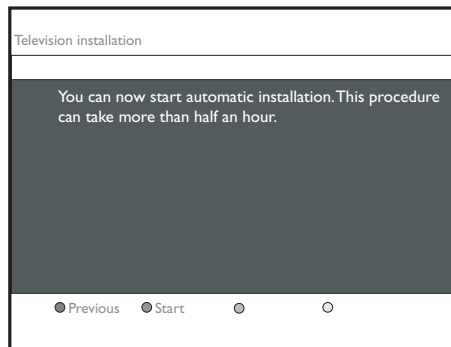

- Tips:**
- When you have locked TV channels while initiating autoprogram, a message appears asking to enter your PIN code in order to complete autoprogramming.
 - When interrupted, the updated channel information is retained as well as the old channel information that were not updated.
 - Background autoprogramming occurs only when the TV is turned on.
 - Channel information of an ATSC channel is updated only for the ATSC channel currently tuned.
 - If an NTSC channel is tuned, then in Background Autoprogramming the TV will scan all the possible ATSC frequencies and update information.
 - Weak channel installation : This allows you to manually tune weak ATSC channels in order to adjust the antenna and thus optimize signal quality for that channel. (See Installation menu, Weak channel installation, p. 9.)
 - Once you have searched for the available Antenna as well as the Cable TV channels, they are stored in the memory.

Digital Channel selection delay

Due to the tuning complexity of subchannel digital programming, the time to select and view a digital channel may take slightly longer than what the viewer is normally accustomed to (as compared to analog channel programs).

Digital channel broadcasts contain program and system data information that must be processed before the channel selection can be displayed.

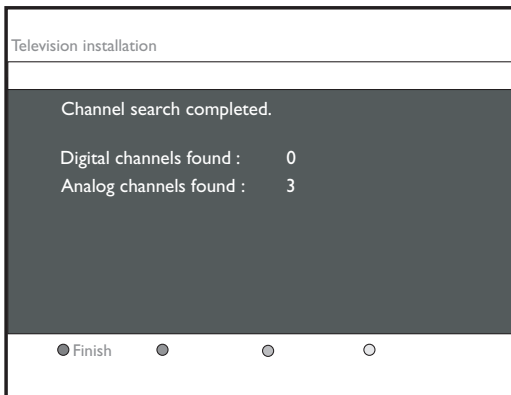

Channel tuning

Available channels:

- Cable (analog NTSC or digital QAM): max. from 1 to 135

- Antenna (analog NTSC or digital ATSC): max. from 2 to 69

If a tuned channel is not yet in the master channel map, the TV will attempt to tune the channel and it will be added to the map.

If the channel is not acquired, a message will appear that the channel is not available.

When you tune an audio-only digital subchannel, a display appears with the message **Audio only**.

Subchannel selections

The new standards employed with digital broadcasting make it possible to receive multiple program channels under a single major channel number which can be selected by pressing the digit remote control direct-access channel number entry.

Tip:

After the installation of the TV channels has been done, always make a selection in the Installation menu between Antenna or Cable whether you want to watch Antenna TV channels or Cable TV channels.

If you make use of a signal splitter do not forget to put the switch in the corresponding position.

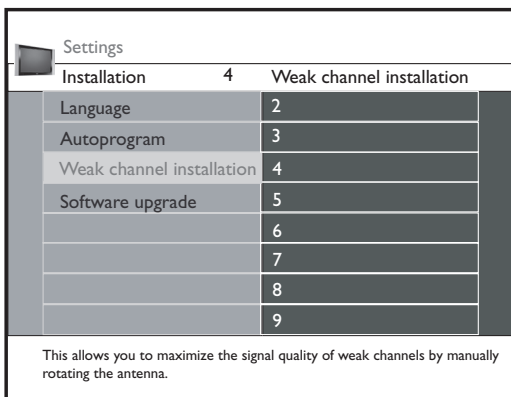

Weak channel installation

This enables you to do a weak ATSC digital channel installation. This is only available for TV channels installed via an antenna connection (see section on Preparation, under Antenna).

- 1 If a certain channel you expect to see is not tuned or is weak, you can install it manually. Call your local broadcasting station to check what channel is being transmitted to.
- 2 Select that channel in the displayed list of TV channels (in the antenna mode).
- 3 The signal strength is displayed and updated continuously as you rotate the antenna.

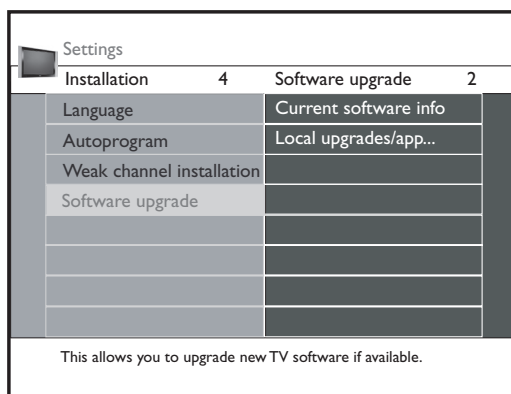

Software upgrade

This menu allows you to upgrade your TV software using a USB device.

USB upgrade

It is possible to initiate an upgrade procedure from a USB portable memory. The memory device must be stored with the appropriate upgrade image (and structure) which can be found on the www.magnavox.com/usasupport website.

How to upload a new software version on your portable memory device, see Annex I, under Magnavox TV software upgrade with portable memory.

To use the menus

Introduction

A lot of guiding instructions, help texts and messages will be displayed on your TV when using the menus or when trying to execute an action. Please, follow the instructions and read the help text which are being displayed on the specific item highlighted.

The color buttons refer to different actions which may be executed depending on the activated device. Press the corresponding color button on the remote control to perform the required action.

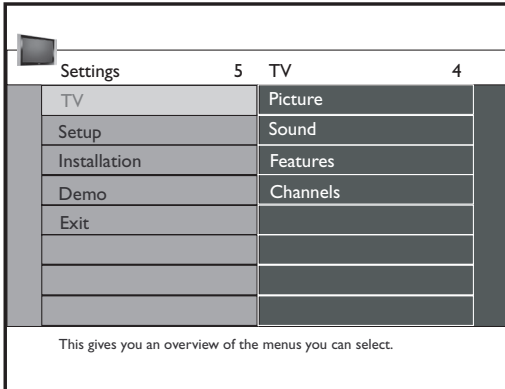

How to navigate through the Settings menus

The Settings menu allows you to access and change settings and preferences.

- 1 Press the **MENU** button on the remote control to call up the Settings menu.
 - On the left panel the highlight can be set on a menu item with the cursor up/down button.
The right panel shows the content of the highlighted menu item in the left panel.
Note: Sometimes not all the menu items are visible on the screen. The numbers at the top of the menus indicate the number of items on the menu. Use the cursor down button to reveal all items.
 - Use the cursor right button to enter the right panel.
The contents of the right panel are displayed on the left panel and the right panel shows the contents of the newly highlighted items in the left panel.
Note: In some cases it is important that the picture can be viewed while adjusting the settings. This means when the highlight bar is on the right panel, the other menu items are hidden. When the cursor left key is pressed again, the hidden menu items re-appear and the highlight bar is displayed on the left panel.
- 2 Press the cursor left button to go one menu level up again.
 - Press the **OK** button on the highlighted item to activate and to exit the menu.
 - Press the **MENU** button again to exit the Settings menu.
Note: You can exit the menu by pressing one of the color buttons (if present) referring to certain actions which may be executed.

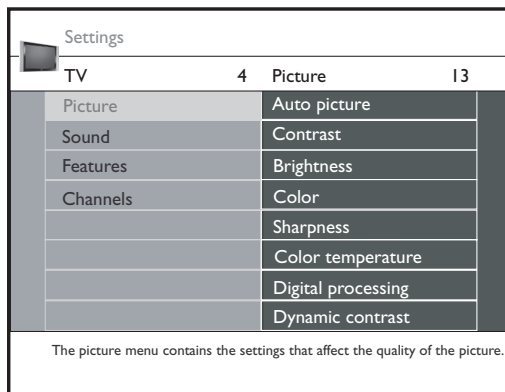

Demo

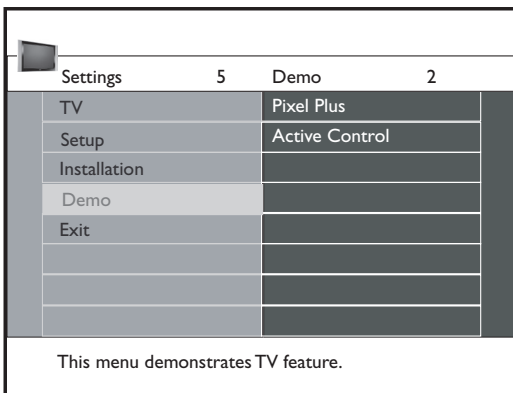

The **Demo** menu gives you an idea of the features that come with the television set.

- 1 Select **Demo** in the Settings menu or press the DEMO button. Press the cursor right button to enter Demo mode.
- 2 Highlight a desired demo with the cursor up/down buttons.
- 3 Press **OK** button to start playing the highlighted demo.
Press the green button to automatically run all demos in sequence.
Press the red button to stop the auto run function.
Press the red button again to exit the demo and to return to TV mode.
Note: The selected demo is played continuously until you press the DEMO button.

Setup menu

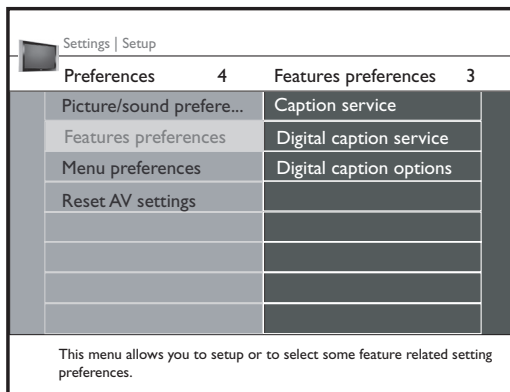
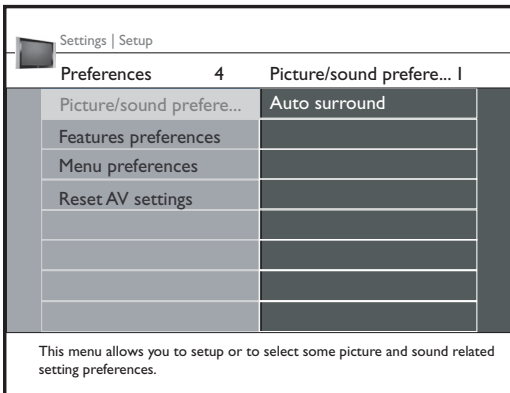
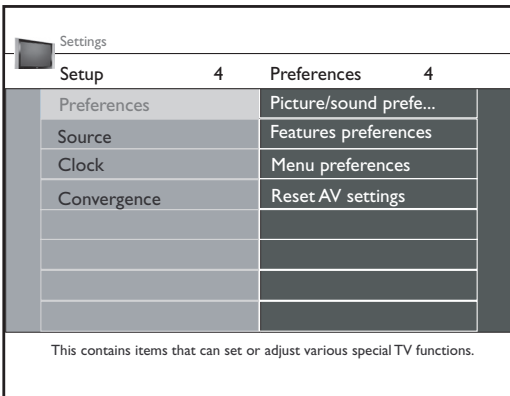
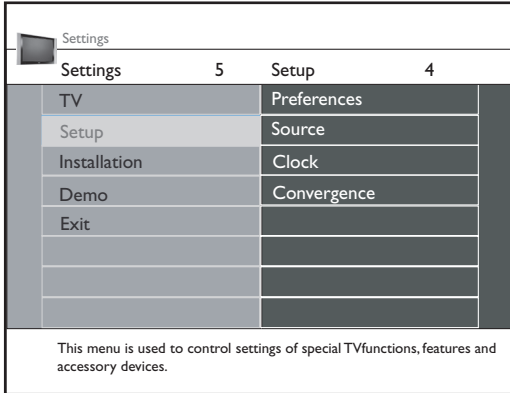

This menu is used to control the settings of special TV functions, features and accessory devices.

The **Preferences** menu allows you to change settings that will be accessed only occasionally.

The **Source** menu allows you to select a source.

The **Clock** menu allows you to use your TV as a clock. This setup is necessary for the correct working of the Lock after feature.

Preferences

- 1 Press the **MENU** button.
- 2 Select **Setup** with the cursor down button and press the cursor right button to select the **Preferences** menu.
- 3 Press the cursor right button again to select **Picture/sound preferences**.
- 4 Press the cursor right button again to enter the Picture/sound preferences menu.

Picture/sound preferences

Auto surround

Sometimes the broadcaster may transmit special signals for Surround sound encoded programs. The TV automatically switches to the best surround sound mode when **Auto surround** is turned **On**.

Features preferences

Caption service

This allows you to select the closed caption service levels of analog broadcasting to be displayed.

Closed captioning allows you to read the voice content of television programs on the TV screen. Designed to help the hearing impaired, this feature uses on-screen 'text boxes' to show dialogue and conversations while the TV program is in progress. Captions will appear on the screen during captioned broadcasts.

The captions are not necessarily always correct in spelling and grammar. Not all TV programs and product commercials are made for broadcast with Closed Caption information included. Refer to your area's TV program listings for the TV channels and schedule of Closed Caption shows. The captioned programs are usually noted in the TV listings with service marks such as 'CC'.

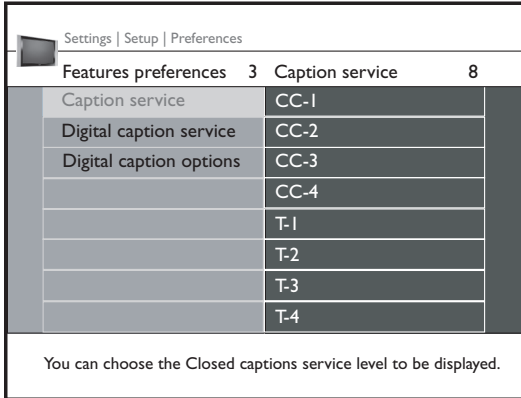

- ❶ Select **Caption service**.
- ❷ Press the cursor right button.
- ❸ Select the desired Caption service:
 - **CC-1, CC-2, CC-3, CC-4**
Dialogue (and descriptions) for the action on the captioned TV program shows on screen. Usually **CC 1** is the most frequently used. **CC 2** may be used for alternate languages if they are being transmitted.
 - **T-1, T-2, T-3 or T-4**
Often used for channel guide, schedules, bulletin board information for Closed captioned programs, news, weather information or stock market reports.
Not all Captioned services are necessarily being used by a TV channel during the transmission of a closed caption program.

Note: This television provides display of television closed captioning conforming with the EIA-608 standard and in accordance with Sections 15.119 of the FCC rules.

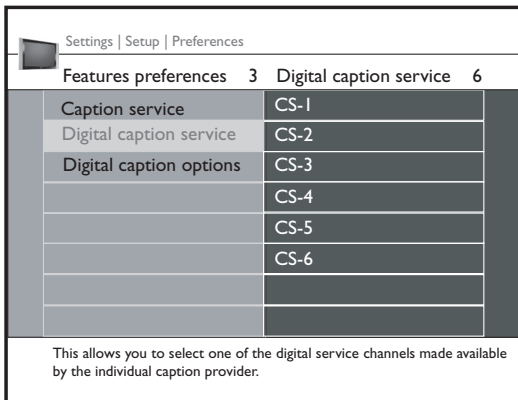

Digital caption service

This allows you to configure the way you choose to view the digital captioning. Select one of the digital service channels made available by the caption provider. There are 6 standard services. Service 1 is designated as the Primary Caption Service. This service contains the verbatim, or near-verbatim captions for the primary language being spoken in the accompanying program audio. Service 2 is designated as the Secondary Language Service. This service contains captions in a secondary language which are translations of the captions in the primary Caption Service. The other service subchannels are not pre-assigned. It is up to the discretion of the individual caption provider to utilize the remaining service channels.

Digital caption options

This allows you to modify how digital captions are displayed on your TV. Select from the following options to change the visual characteristics of your TV's digital captioning.

- **Reset to default**
Select this option to reset the digital caption options back to the captions provider default settings.
Press **OK** to confirm.
- **Size**
Select this option to choose the size of of caption display according to your own preference.
Select **Default (Automatic), Small, Standard or Large** and press **OK** to confirm.
- **Style**
Select this option to select the font style of caption display according to your own preference. Select from **Default, Monospaced serif, Serif, Monospaced sans serif, Sans serif, Casual, Cursive or Small caps...**
- **Text**
Select this option to choose the text color or the opacity of the text box of caption display according to your own preference.
Select a color and one of the opacity options.
- **Background**
Select this option to choose the character background color or one of the background opacity options of caption display according to your own preference.
Select a color and one of the opacity options.

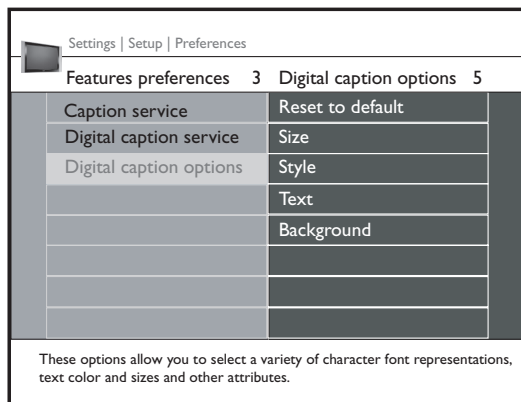

To display the transmitted CC-CS-text on the screen according to your chosen CC or CS service, use the Closed captions option in the Feature menu. This text can either be permanently displayed (assuming that the service is available in the broadcast) or only when mute is active.

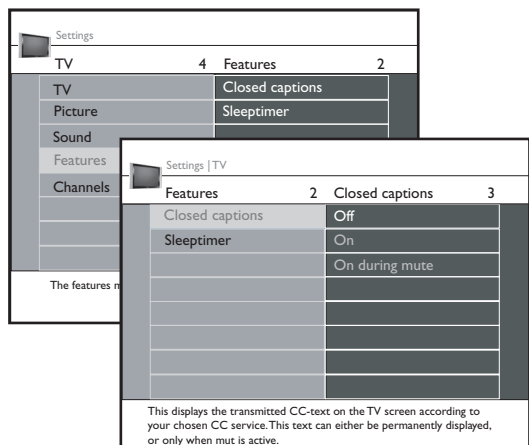

- ❶ Select **Features** in the TV Settings menu.
- ❷ Press the cursor right to enter the features menu.
- ❸ Select the menu items with the cursor up/down and adjust the settings with the cursor left/right.
- ❹ Press the cursor right after having selected Closed captions.
- ❺ Select **On, Off or On during mute**.

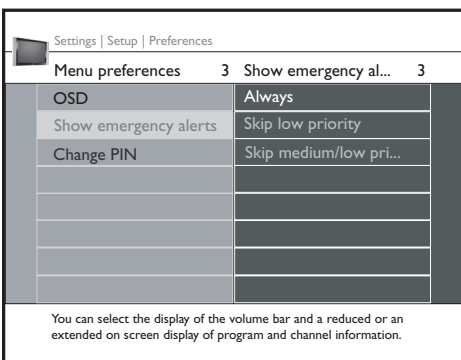
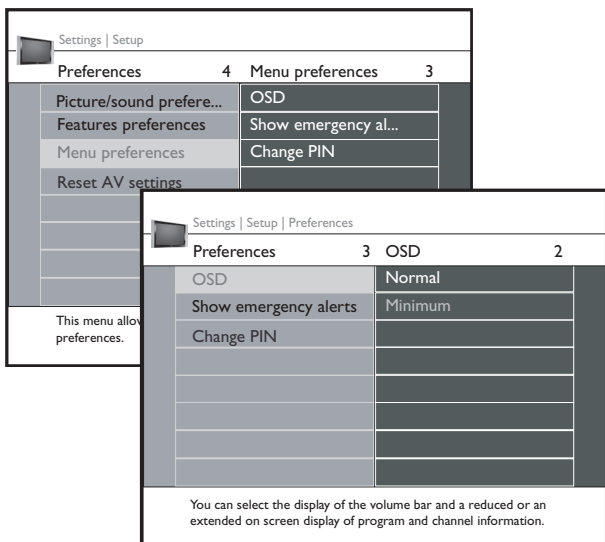

Tips:

Emergency Alert Signalling is not possible:

- when content browsing;
- with analogue video sources.
- You always have the possibility to remove the message from the screen.
- The message display will overlap whatever menu element or other message is on the screen.

Caution! If you have forgotten your PIN!

- 1 Select **Change PIN** in the Menu preferences menu and press the cursor right.
- 2 Press the cursor right to enter the overriding PIN code **0-7-1-1**.
- 3 Press the cursor again and enter a new personal 4-digit PIN code. The previous code is erased and the new PIN-code is stored.

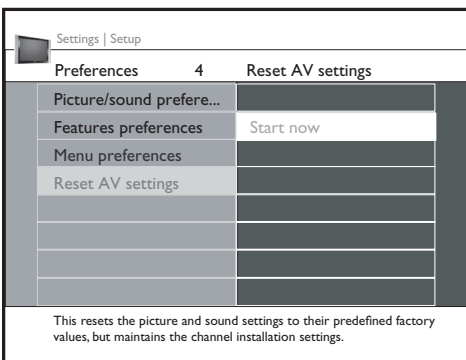

Menu preferences

On Screen display

- 1 Select **OSD**.
- 2 Press the cursor right button to select **Normal** or **Minimum**.
Normal to activate the continuous display of the channel number (for max. 10 minutes) and extended display of TV channel and program information on screen. E.g. information on the main or auxiliary program, input signal quality of connected accessory devices, the display format, sound mode, availability of Closed Caption service, the audio language, the rating, sleep timer setup.
Minimum to activate the display of reduced channel information.
Note: When Closed Captions is turned on, continuous display of the channel number and clock is not possible.

Show emergency alerts (EAS)

This allows you to select the alert priority level of the information disseminated by the cable operator. The standard SCTE18 defines an Emergency Alert signalling method for use by cable TV systems to signal emergencies to digital devices such as digital set-top boxes, digital TVs and digital VCRs.

The Emergency alert signalling scheme defined in the standard allows a cable operator to disseminate emergency alert information related to state and local-level emergencies and warnings in a cost-effective and efficient way, while minimizing disruption of programming.

An Emergency alert message will have one of the following priorities:

Low, Medium, High or **Maximum**.

The Emergency alert message with priority **High** or **Maximum** will always be presented. **Low** or **Medium** will be present or ignored depending on the selected setting.

Caution! When the TV clock is undefined (See section on Clock), the Emergency Alerts will be ignored.

The Emergency Alert message display will contain following information:

- The Emergency Alert text
- The start time + date
- The end time + date.

- 1 Select **Show Emergency Alerts** in the Menu preferences menu.
- 2 Press the cursor right button and select one of the Emergency alerts options:
 - Always, when you always want the Emergency alert messages to be displayed when available;
 - Skip low priority, when you want the messages with low level to be ignored;
 - Skip low/medium priority, when you only want the messages with high priority to be displayed.

Set/Change PIN

- 1 Select **Set** or **Change PIN** with the cursor down button.
- 2 If no PIN-code exists, the menu item is set to **Set PIN**. Follow the instructions on screen.
If a PIN-code has previously been entered, the menu item is set to **Change PIN**. Follow the instructions on screen.
All number combinations from 0000 to 9999 are valid numbers.
- 3 The **Menu preferences** menu reappears with a message confirming that the PIN has been created.

Reset AV settings

This function allows you to reset most of the picture and sound settings to their predefined factory states.

- 1 Select **Reset AV settings** with the cursor down button.
- 2 Press the cursor right button.
- 3 Press **OK** button to erase settings and reset them to their default values.

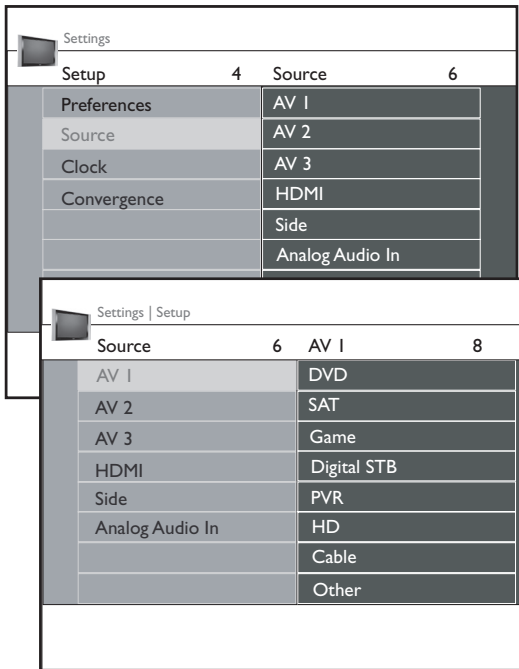

Source

This menu allows you to identify the accessory devices you have connected to the external input/output.

- ❶ Select **Source** in the Setup menu.
- ❷ Press the cursor right button to enter the list of types of devices connected to the selected input.
- ❸ Select the accessory device with the cursor up/down buttons.

When you select **AV1**, **AV2**, **AV3**, **HDMI**, **Side** or **Analog Audio In**, a list appears allowing you to identify which type of accessory device is attached to this input. The TV detects the presence of the connected device and the signal is routed accordingly. Once you have selected the source type, e.g. DVD, this source will automatically be selected when your remote control is in DVD mode, (see section on Use of the remote control), and when you press the **AV** button on the remote control.

The TV can output Digital audio via the **DIGITAL AUDIO OUT (SPDIF OUT)** connector to an external amplifier or receiver.

If your amplifier or receiver has a matching connector for Digital Audio In, you can connect it with a single cable to the TV's **DIGITAL AUDIO OUT (SPDIF OUT)**. See section on Digital Surround Receiver.

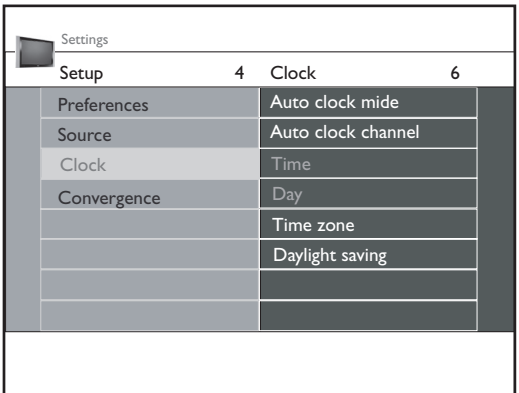

Clock

This allows you to use your TV as a clock.

- Adjusting the clock is necessary for the correct working of Lock after features.

(See section on TV settings, under Channels menu)

- Closed captioning will not be displayed when the clock is being displayed. Press the clock button again to switch off the clock if you want to see closed caption.

Auto clock mode

- ❶ Select **Clock** in the Setup menu.
- ❷ Press the cursor right button to select the **Auto clock mode**.
- ❸ Press the cursor right button to instruct the TV to get the time automatically or manually.

Auto clock channel *(only available when Auto clock mode is set to Automatic)*

With the cursor buttons, select the channel number where time can be found by the TV. Typically time can be found on PBS as well as some other channels.

Note: If Manual has been selected in the Auto clock mode, the Auto clock channel menu item can not be selected.

Time - Day *(only available when Auto clock mode is set to Manual)*

With the cursor buttons, select and enter the correct time and day.

If **Auto clock mode Manual** has been selected, and no clock search has been done, the system will retain the entered time and day.

Time zone *(only available when Auto clock mode is set to Automatic)*

This function allows you to select your local time zone. Broadcast time information will auto correct the clock display for your local time.

- ❶ Select **Time zone** with the cursor down button.
- ❷ Press the cursor right button to select your local time zone.

Daylight saving *(only available when Auto clock mode is set to Automatic)*

Daylight saving time is automatically set by specially broadcast signals. This menu item allows you to disable the automatic setting of daylight saving time. This is useful if you live in an area or state where daylight saving is not applied, but you receive channels from other areas where daylight saving signals are broadcast.

- ❶ Select **Daylight saving** with the cursor down button.
- ❷ Press the cursor right button to select **Automatic** for automatic clock correction for daylight saving time, based on specially broadcast signals.
- ❸ Select **Off** to disable automatic clock correction based on the specially broadcast signals.

Most of the TV channels do not transmit clock information. There are a few cable channels who do but they are at the end of the channel ring. There is no clock transmission in antenna channels. In such cases, either clock extraction takes a long time, or there is no clock.

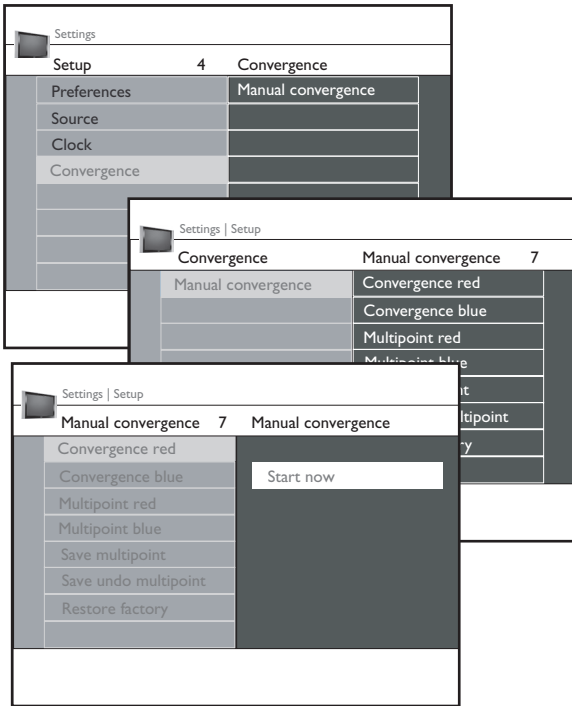

Tip: Allow the TV to warm up for 20 minutes before adjusting convergence. Adjust Converge Red or Converge Blue before using the Multipoint Red/Blue controls.

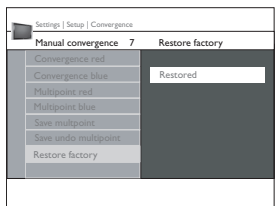
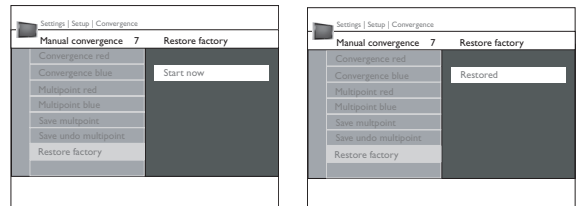
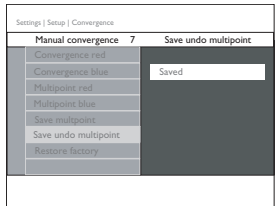
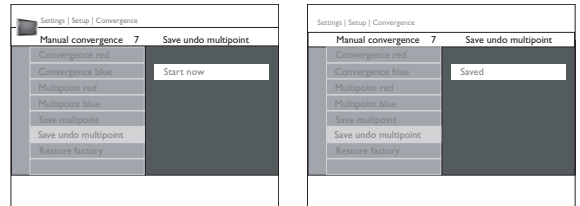
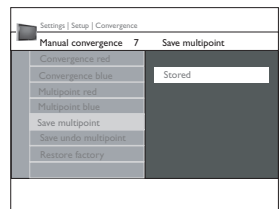
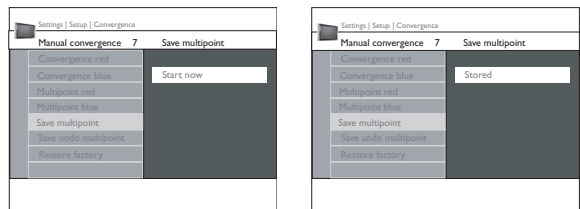
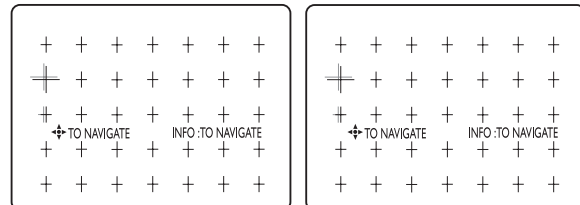
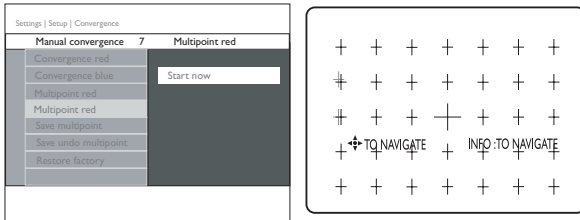

Convergence

Manual Convergence: Converge Red/Blue

You can use the **Manual Converge** controls to make convergence adjustments to suit your personal preferences or to further fine-tune the picture.

- 1 Select **MANUAL CONVERGE** in the **SETUP** menu.
- 2 Press the cursor right button to enter into the manual convergence menu.
- 3 Press the cursor down button and select either **CONVERGE RED** or **CONVERGE BLUE** and press the cursor right button.
- 4 Press **OK** button to start the manual convergence.

*Tip: If various images in the picture have red outlines, select **CONVERGE RED**. If various images in the picture have blue outlines, select **CONVERGE BLUE**.*

- 5 Use the cursor right, left, up or down button to adjust the cross hair until the colour outline is gone. The adjustment is automatically saved in the TV's memory when you exit the adjust mode.
- 6 Press the **MENU** button to return or the **INFO** key to switch the menu off.

Check the TV picture. If any colour outlines remain around the images, use the **MULTIPOINT RED** (for red outlines) or **MULTIPOINT BLUE** (for blue outlines) control. See the next section for instructions for using those controls.

Using Manual Converge: Multipoint Red/Blue

The Multipoint Red/Blue convergence controls allow you to adjust picture convergence at specific points on the TV screen.

- 1 Select **MULTIPOINT RED** or **MULTIPOINT BLUE** in the **MANUAL CONVERGE** menu.
- 2 Press the cursor right to enter navigate mode.
- 3 Use the cursor left, right, up or down button to move to a cross hair that has a colour outline.
- 4 Press the **INFO** button to enter adjust mode.
- 5 Use the cursor left, right, up or down to adjust the cross hair until the colour outline is gone.
- 6 Press the **INFO** button to return to navigate mode.
- 7 Repeat steps 3-6 until all misaligned cross hairs have been adjusted. Then press the **MENU** button.
- 8 For your multipoint adjustments to be stored in the TV's memory, you must activate **SAVE UNDO MULTIPOINT**.

*Note: If you are not satisfied with the adjustments you just made and want to start over, you can use the **UNDO MULTIPOINT** control. This control allows you to undo the adjustments, but only if you use it before saving.*

*To save your multipoint adjustments: Select **SAVE MULTIPOINT** and press the cursor right or **OK** button.*

*To undo your multipoint adjustments: Select **SAVE UNDO MULTIPOINT** and press the cursor right or **OK** button.*

*To restore the TV's picture convergence to factory settings, select **RESTORE FACTORY** and press the cursor right or **OK** button.*

- 9 Press the **MENU** button to return or the **INFO** button to switch the menu off.

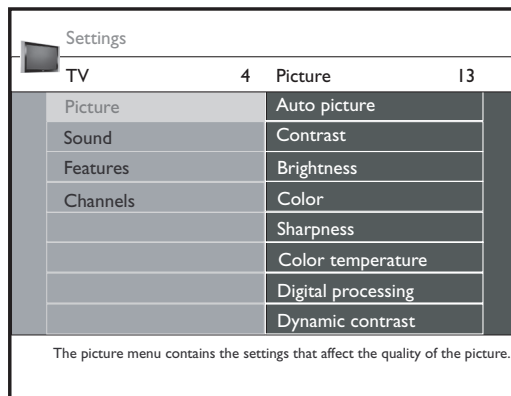
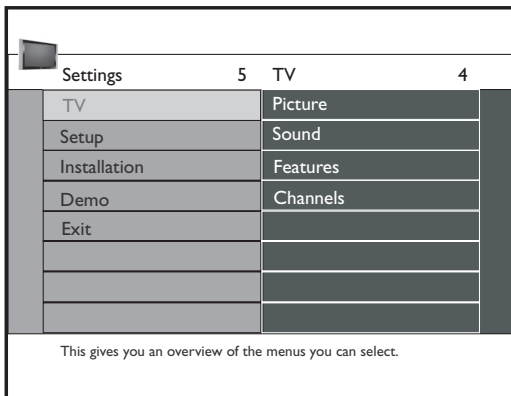

Press the **MENU** button on the remote control to display the Settings menu. The TV menu gives you an overview of the menus you can select.

Note: Depending on the input signal, one or more menu items may not be selectable.

Picture menu

Note: Some menu items are not available in case of HD sources.

- 1 Press the cursor right button to select **Picture**.
- 2 Press the cursor right button again to enter the Picture menu.
- 3 Select the menu items with the cursor up/down buttons.
- 4 Adjust the settings with the cursor left/right buttons or enter the list of submenu items with the cursor right button. Select a submenu item with the cursor up/down buttons.

Auto picture

Select **Auto picture** to display a list of predefined picture settings, each corresponding with specific factory settings.

Personal refers to the personal preference settings of picture in the picture menu.

*Note: This Magnavox TV has been set at the factory to look best in bright store environments which typically use fluorescent lighting. As your home will likely not be as well lit as a store, we recommend that you cycle through the various auto picture modes to find the one that best suits your own viewing conditions. Most consumers will find that **Natural** is the correct choice.*

Contrast

This will adjust the intensity of bright areas of the picture but keep the dark areas unchanged.

Brightness

This will adjust the light output of the complete picture, which will mainly affect the darker areas of the picture.

Color

This will adjust the saturation level of the colors to suit your personal preference.

Sharpness

This will adjust the sharpness of fine details in the picture.

Color temperature

This will increase or decrease **Warm** (red) and **Cool** (blue) colors to suit personal preferences.

Select **Cool** to give the white colors a blue tint, **Normal** to make the white colors neutral, **Warm** to give the white colors a red tint.

Digital processing

- **Standard** = line doubling eliminates the flicker.
 - **Pixel Plus** = for everyday viewing, Pixel Plus is the most ideal setting, as it fully processes the image to enhance every single pixel, improving contrast, sharpness, picture depth, and color reproduction and brilliance from every source, including High Definition.
- Standard** mode is recommended only for very noisy or poorly mastered sources or for those who find the smoothness of Pixel Plus (which eliminates judder in the picture) unsettling.

Dynamic contrast

Automatically makes the contrast in the darker and the brighter picture areas more noticeable as the image on the screen changes.

Normally you would select **Maximum**. Or you may prefer to select **Minimum** or **Off**.

- 1 Press the cursor right button to enter the list.
- 2 Select one of the settings with the cursor up/down buttons.
- 3 Press the cursor left to return to the picture menu.

Settings TV			
Picture	13	DNR	4
Brightness	50	Off	
Color	67	Minimum	
Sharpness	4	Medium	
Color temperature		Maximum	
Digital processing			
Dynamic contrast			
DNR			
Color enhancement			

This sets the level at which noise is measured and reduced in the picture.

DNR (Digital Noise Reduction)

Automatically filters out and reduces the image noise and improves picture quality when receiving weak video signals.

- 1 Press the cursor right button to enter the list.
- 2 Select **Off**, **Minimum**, **Medium** or **Maximum** according to the image noise.
- 3 Press the cursor left button to return to the picture menu.

Color enhancement

When activated, this feature automatically controls green enhancement and blue stretch. It makes the colors more vivid.

- 1 Press the cursor right button.
- 2 Select **On** or **Off** in order to activate/de-activate Color enhancement with the cursor right button.

Tint

Allows you to select the color mix (hue) of the picture.

Picture format

This menu item performs the same as the **FORMAT** button on the remote control. See section on Use of the remote control.

Settings TV			
Picture	13	Active Control	4
Color temperature		Off	
Digital processing		Minimum	
Dynamic contrast		Medium	
DNR		Maximum	
Color enhancement			
Tint	0		
Picture format			
Active control			

With Active Control the TV continuously measures and corrects all incoming signals in order to provide the best picture possible. Select the Active Control level.

Active Control

The TV continuously measures and corrects all incoming signals in order to provide the best picture possible.

- 1 Select **Active Control**.
- 2 Press the cursor right button to enter the list of Active Control values.
- 3 Press the cursor right button repeatedly to select the Active Control values **Off**, **Minimum**, **Medium** or **Maximum**.
The picture settings are being optimized continuously. These menu items cannot be selected.
- 4 Press **OK** button or wait for timeout to exit the Active Control display.

Settings			
TV	4	Sound	8
Picture		Auto sound	
Sound		Volume	
Features		Balance	
Channels		Sound mode	
		Alternate audio	
		Digital audio language	
		Mono/Stereo	
		AVL	

Sound menu

- 1 Select **Sound** in the TV Settings menu.
- 2 Press the cursor right button to enter the sound menu.
- 3 Select the menu items with the cursor up/down buttons and adjust the settings with the cursor left/right buttons.
Control settings are at normal mid-range levels when the bar scale is entered.

Auto sound

Select **Auto sound** to display a list of predefined sound settings, each corresponding to specific factory settings of Treble and Bass.

- 1 Press the cursor right button to enter the list.
- 2 Press the cursor up/down buttons to select a predefined sound setting.
Personal refers to the personal preference settings of sound in the sound menu.

The moment you are in a predefined Auto sound setting and you modify a setting in the Sound menu, all values of the menu will overwrite the previously made personal setting.

Volume

This will adjust the sound output level.

Balance

This will adjust the output of the right and left speakers to obtain the best stereo reproduction for your listening position.

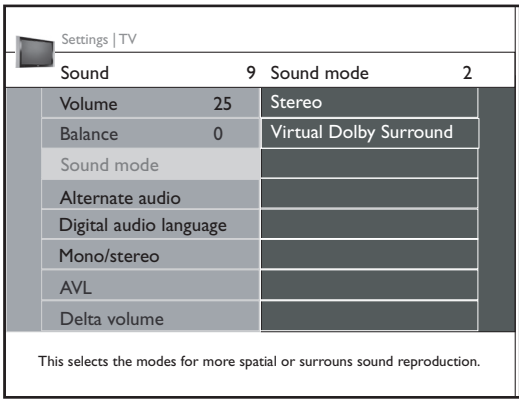

Sound mode

This selects the modes for stereo or surround sound reproduction dependent on the broadcast signals or signals from external inputs received.

Alternate audio (only selectable with analog broadcast signals)

This gives you the possibility to swap between the Main and Second Audio Program (SAP) when it is available.

Digital audio language (only selectable with digital broadcast signals)

This allows you to select your language preference in case of multilingual audio track programs.

Note: The default language for the digital channels is the installed menu language.

Mono/Stereo (only selectable with digital broadcast signals)

This selects, per TV channel, Mono or Stereo sound.

AVL (Automatic Volume Leveler) (only available with analog broadcast and non-Digital signals)

This automatically reduces the volume differences between channels and programs, providing a more constant overall level. This will also reduce the dynamics of sound.

Delta volume

This allows you to correct for any permanent volume differences between TV channels or external sources.

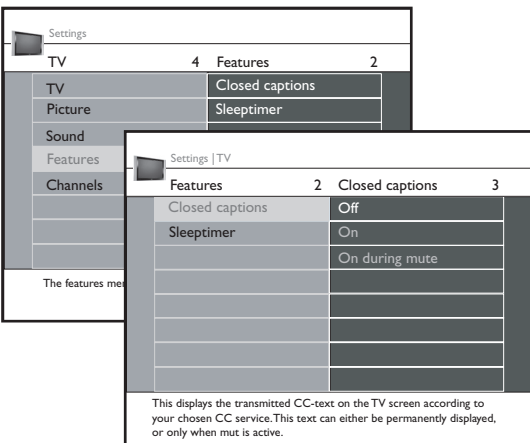
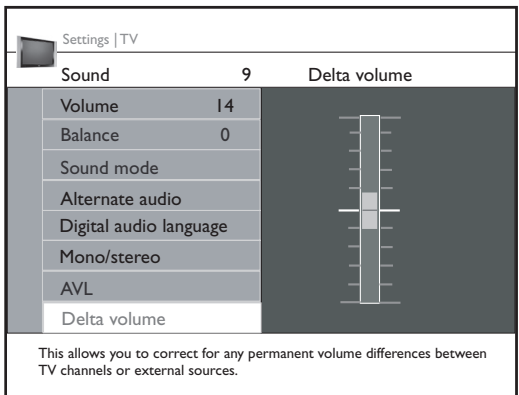

Features menu

- 1 Select **Features** in the TV Settings menu.
- 2 Press the cursor right to enter the features menu.
- 3 Select the menu items with the cursor up/down and adjust the settings with the cursor left/right.

Closed captions

This displays the transmitted CC- or CS-text on the screen according to your chosen CC or CS service in the Setup, Features preferences menu, p. 10. This text can either be permanently displayed (assuming that the service is available in the broadcast) or only when mute is active.

- 1 Press the cursor right after having selected Closed captions.
- 2 Select **On**, **Off** or **On during mute**.

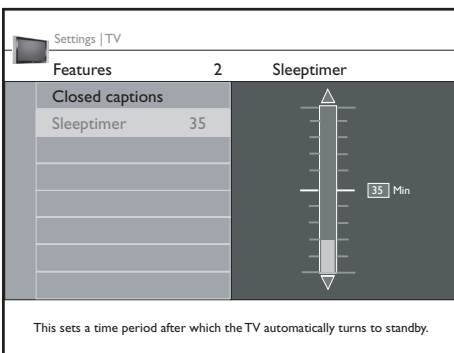

Sleeptimer

This sets a time period after which the TV automatically turns to standby.

- 1 Select **Sleeptimer**.
- 2 Press the cursor right.
- 3 Select a value with the cursor up/down. The list will have values from **0** to **180 minutes**.

When **0** is selected, the sleeptimer is turned off.

You can always turn off your TV earlier or select another time set.



Manufactured under license from Dolby Laboratories. 'Dolby' and the double-D symbol are trademarks of Dolby Laboratories.

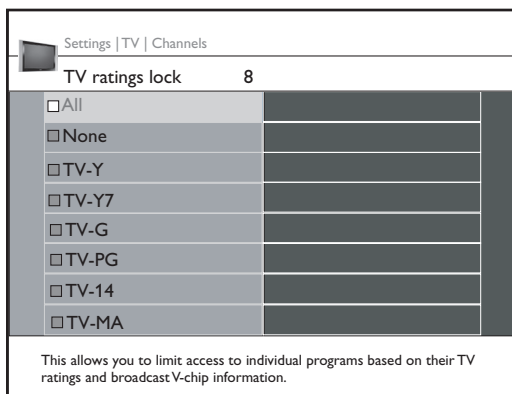
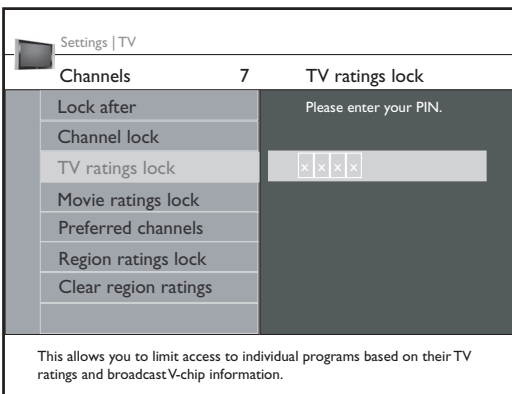
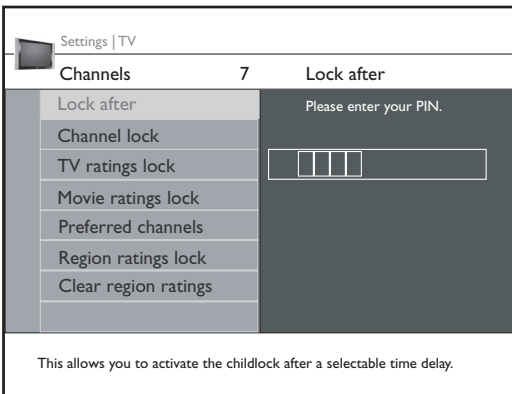
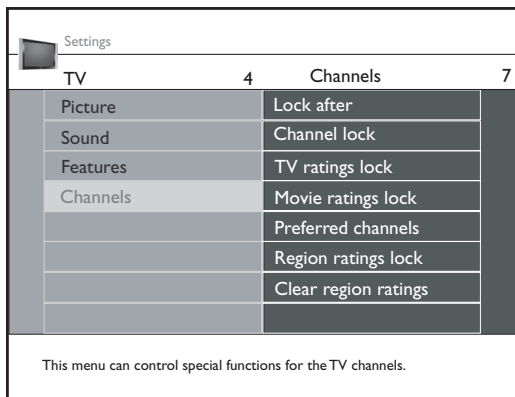

Channels menu

This menu can control special functions for the TV channels.

- 1 Select **Channels** in the TV settings menu with the cursor up/down.
- 2 Press the cursor right to enter the channels menu.
- 3 Press the cursor up/down to select a channels menu item.

Lock after

Note: Lock after is only selectable if time is known. See Setup, Clock menu, p. 13.

This allows you to prevent the viewing of the channels after a selectable time delay. Locked channels can still be tuned, but the picture is blanked and the audio is muted.

- 1 Press the cursor right and you will be prompted to enter your PIN.
- 2 Enter your 4-digit PIN code and select **Timer On** or **Off**. When set to **On** this allows you to set the clock.
- 3 Select **Time** and press the cursor right. This allows you to set the time after which the lock is set.
- 4 Select **AM** or **PM** to select the correct period of the day.
- 5 Enter the time with the digit or the cursor buttons and press **OK** to confirm.

Caution! If you have forgotten your PIN!

- 1 Select **Change PIN** in the Menu preferences menu on p. 12 (Set/Change PIN) and press the cursor right.
- 2 Press the cursor right to enter the overriding PIN code **0-7-1-1**.
- 3 Press the cursor again and enter a new personal 4-digit PIN code. The previous code is erased and the new PIN-code is stored.

Channel lock

This allows you to completely lock a certain TV channel or external source. Select the channels or subchannels you want to lock and press **OK** to confirm.

TV ratings lock

Your TV is equipped with a V-chip. This allows you to control access to individual programs based on their movie and TV ratings. All settings apply to all AV inputs, except HDMI. The program content advisory data are sent by the broadcaster or program provider.

- 1 Select **TV ratings lock** with the cursor down.
- 2 Press the cursor right to enter the list. You are asked to enter your code. (See Set/Change PIN, p. 12.) If the code is correct, a list appears, showing the age-based TV ratings and a corresponding content-based ratings list.
- 3 Select an age-based TV rating with the cursor up/down, and enter, if present, the list with content-based ratings with the cursor right, and select one content-based rating.
- 4 Press **OK** to activate/de-activate the selected rating.
- 5 Select another content-based rating if you like and press **OK** again.

You need only enter your PIN-code once while the menu is active. You can lock/unlock any number of ratings on the list without re-entering your code.

Each ratings item has a box-graphic in front of it to indicate whether or not programs carrying that rating are currently locked:

- box with a 'X': all items in the contents-based list are locked as well;
- empty box: the item is unselected;
- box with a '/': some content-based ratings are selected/unselected.

Age-based Rating	Content-based Rating
All	none
None	none
TV-Y	none
TV-Y7	(FV) Fantasy Violence
TV-G	none
TV-PG	(D) Dialog (L) Language (S) Sex (V) Violence
TV-14	(D) Dialog (L) Language (S) Sex (V) Violence
TV-MA	(L) Language (S) Sex (V) Violence

When **All** has been selected, all items in the age-based and in the contents-based lists are locked.

If, while **All** is selected, any other item, either an age-based or content-based item, is unselected, then All is automatically unselected.

None is the selection for items that either have no rating information or have a rating of None. Both will be locked.

When an item on the age-based list is selected, all items below that item of the same group are locked as well.

When you select a content-based rating, all identical content-based ratings in the younger age-based categories are also selected.

TV-Y appropriate for children of all ages with themes and elements suitable for children aged 2-6

TV-Y7 programs designed for children age 7 and older

TV-Y7-FV programs include fantasy violence more intense than other programs in the TV-Y7 category

TV-G programs suitable for all ages. These programs contain little or no violence, no strong language and little or no sexual dialogue or situations

TV-PG programs contain elements that some parents may find unsuitable for younger children and which may need parental guidance. The program may contain moderate violence, sexual dialogue and/or situations and some strong language.

TV-14 programs contain elements that may not be suitable for children under 14 years of age. These programs include one or more of the following: intense violence, intense sexual situations, suggestive dialogue and strong language.

TV-MA programs are designed to be viewed by adults and may be unsuitable for children under the age of 17. These programs may contain graphic violence, explicit sexual activity and/or crude or indecent language.

Movie Ratings Lock

This function allows you to control access to individual movies based on their MPAA ratings (Motion Picture Association of America).

- 1 Select **Movie ratings lock** with the cursor down.
- 2 Press the cursor right to enter the list. You are asked to enter your code. (See Set/Change PIN, p. 12.) If the code is correct, a list appears, showing all valid MPAA content ratings.
- 3 Select a movie rating with the cursor up/down.
- 4 Press **OK** to activate/de-activate the selected rating.

Each rating item has a box-graphic in front of it to indicate whether or not programs carrying that rating are currently locked:

- box with a 'X': movies with this rating are locked;
- empty box: movies with this rating are unlocked.

When **All** has been selected, all items on the movie ratings list become selected. (All movies are locked.)

If, while **All** is selected, any other item is unselected, then **All** is automatically unselected.

When **NR** has been selected, no other item is selected.

When any other item has been selected, all ratings below are selected as well, thus all movies with those ratings will be locked.

NR not rated

G movies with a mild content, suitable for all ages

PG movies for which parental guidance is recommended. They may contain a few racy or violent scenes or maybe some bad language

PG-13 movies for which parental guidance may be recommended if under age 13

R restricted. The movies usually contain offensive sex or bad language and may be unsuitable for children under the age of 17. Parental guidance or permission needed.

NC-17 even with parental permission, forbidden under age 17. More offensive sex, violence or bad language.

X movies which generally focus on sex, violence and/or bad language. Also known as pornography.

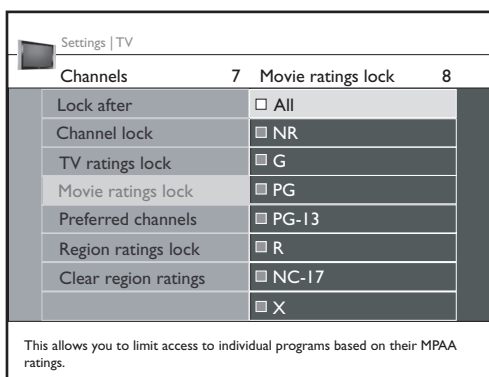
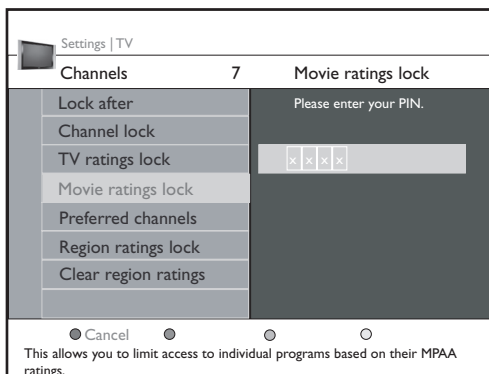

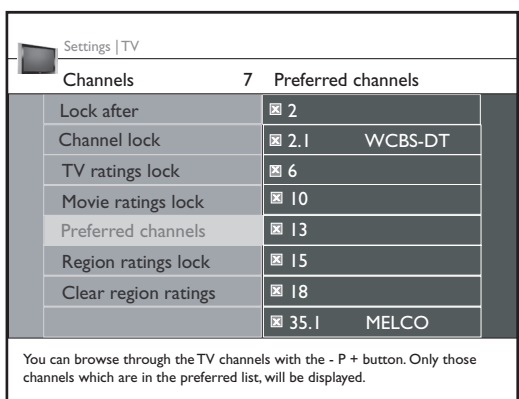

Preferred channels

A channel, when installed, is marked as preferred by default and added to the channel list. This feature provides the ability to remove a channel number from the channel list.

- ❶ Select **Preferred channels** with the cursor down.
- ❷ Press the cursor right to enter a list with all stored channel numbers.
- ❸ Select the channel you want to remove with the cursor down.
- ❹ Press **OK**.
- ❺ Repeat to remove other channels.

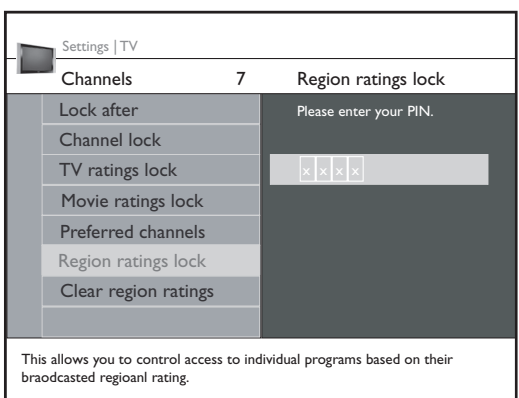

Region ratings lock

This function allows you to control access to digital programs based on downloaded Region Ratings.

- ❶ Select **Region ratings lock** with the cursor down.
- ❷ Press the cursor right to enter the list. You are asked to enter your code. (See Set/Change PIN, p. 12.) if the code is correct, a list appears, showing the Region ratings and a corresponding content-based ratings list.
- ❸ Select a Region rating with the cursor up/down, and enter; if present, the list with content-based ratings with the cursor right, and select one content-based rating.
- ❹ Press **OK** to activate/de-activate the selected rating.
- ❺ Select another content-based rating if you like and press **OK** again.

You need only enter your PIN-code once while the menu is active. You can lock/unlock any number of ratings on the list without re-entering your code.

Each ratings item has a box-graphic in front of it to indicate whether or not programs carrying that rating are currently locked:

- box with a 'X': all items in the contents-based list are locked as well;
- empty box: the item is unselected;
- box with a '/': some content-based ratings are selected/unselected.

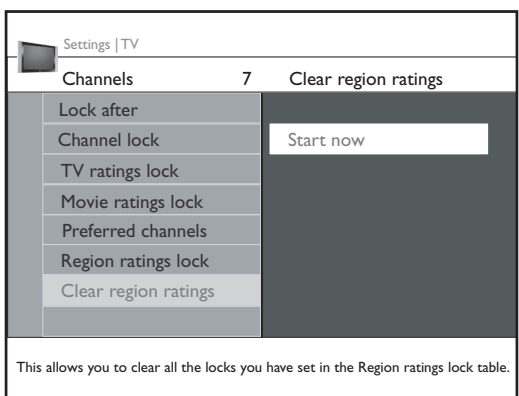

Clear region ratings

This function allows you to clear all the Region Ratings settings.

- ❶ Select **Clear region ratings** with the cursor down.
- ❷ Press the cursor right to enter the list. You are asked to enter your code. (See Set/Change PIN, p. 12.)
- ❸ Select **Start now**.
- ❹ Press **OK** to activate.

Connect Accessory Devices

1 Set Top Box to TV

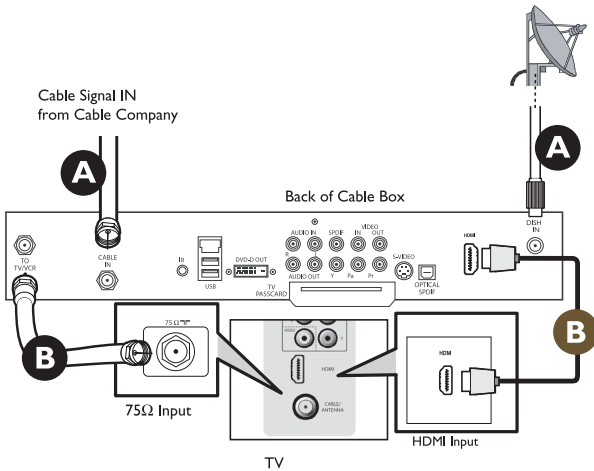

Using HDMI

- A** Connect RF cable from wall to input at back of the cable box.

Set output switch on set-top box to CH 3 or 4 and tune TV to same channel.

In some cases, cable box will automatically tune to channel 3 or 4. Just change channels until picture appears.

- B** Connect cable box to TV using HDMI cable.

*Note: If the accessory device has DVI output only, use a DVI to HDMI adapter cable to connect to the HDMI connector. You need to also connect the audio cable to **L** and **R AUDIO** jacks. Next, go to **Menu=>Setup=>Source=>Analog Audio In=>** and select **HDMI**.*

Using RF Cable

- A** Connect RF cable from wall to input at the back of the cable box.

- B** Use second RF cable to connect the cable box to the TV's antenna input. *This connection gives mono sound. For stereo sound use also composite audio/video connection (Refer to panel 3).*

2 DVD Player or DVD Recorder to TV

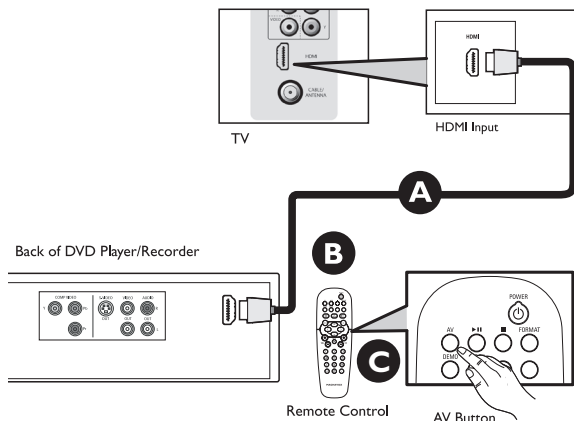

Using HDMI

- A** Connect DVD player/DVD recorder to the TV using HDMI cable.
- B** Turn on TV and DVD Player/DVD recorder. Press CH+ or CH- on remote control to tune to the video supplied by HDMI.

Insert a prerecorded DVD into DVD player/DVD recorder and press PLAY to verify correct connection.

3 DVD Player or DVD Recorder to TV

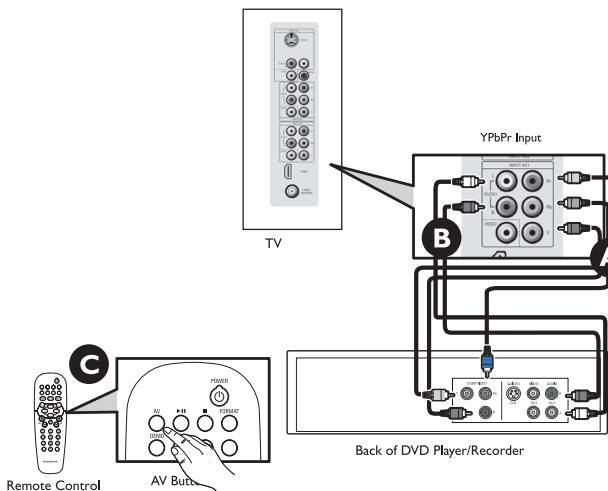

Using Composite Video Input (YPbPr)

- A** Insert Component Video connectors into their corresponding jacks on both DVD player/DVD recorder and TV (Y, Pb and Pr).
- B** Connect red/white audio cables into the audio output jacks on DVD player/DVD recorder and audio AV inputs on TV.
- C** Turn on TV and DVD player/DVD recorder. Press AV on remote control until the connected source appears on TV screen.

Insert a pre-recorded DVD into DVD player/DVD recorder and press PLAY to verify correct connection.

4 DVD Player/DVD Recorder/VCR to TV

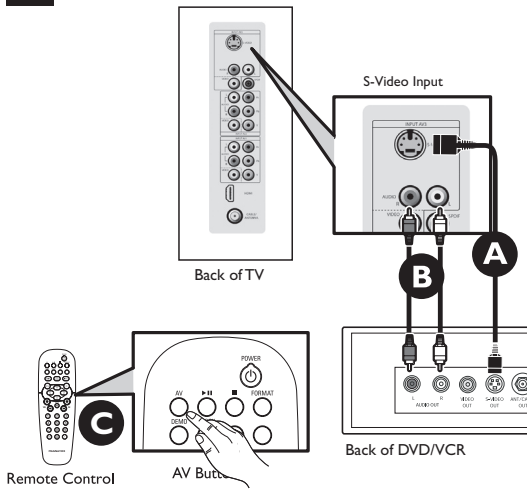

Using S-Video

- A** Connect S-Video cable to S-Video input on back of TV and S-Video output on the back of DVD/VCR player or recorder.
- B** Connect audio cables (red/white) to audio AV inputs on back of TV and Audio outputs on back of DVD/VCR player or recorder.
- C** Turn on TV and DVD/VCR player or recorder. Press AV button on the remote control until AV1 or AV2 appears on TV screen.

Insert pre-recorded videotape/DVD into DVD/VCR player or recorder and press PLAY to verify correct connection.

When you connect S-Video and AV2 at the same time, you can only hear sound coming from AV2.

5 DVD Player/DVD Recorder/VCR to TV

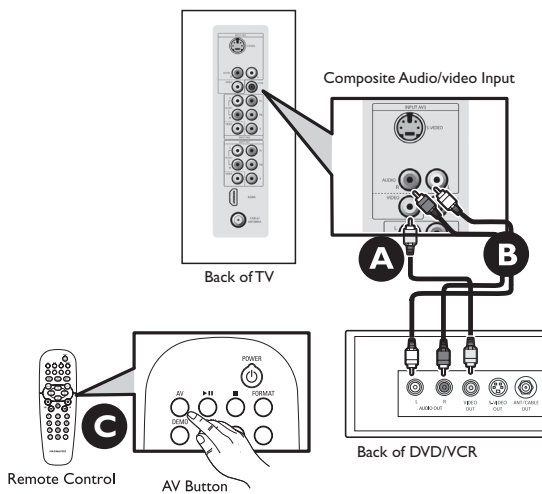

Using Composite Audio/Video Input

- A** Connect the video cable (yellow) to the VIDEO AV input on back of TV and the corresponding video output on back.
- B** Connect audio cables (red/white) to audio AV inputs on back of TV and the corresponding audio outputs (L & R) on back of DVD/VCR player or recorder.
- C** Turn on the TV and VCR. Press AV button on the remote control until AV1 or AV2 appears on TV screen.

Insert pre-recorded videotape/DVD into DVD/VCR player or recorder and press PLAY to verify correct connection.

6 Video Camera/Games Console to TV

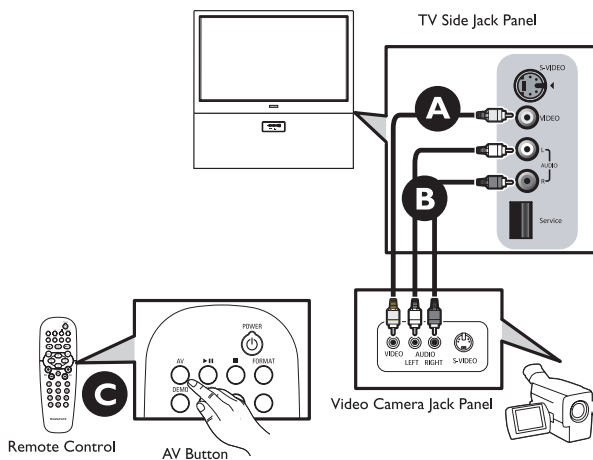

Using Composite Audio/Video Input

- A** Connect the video cable (yellow) from the video output on camera (or other device) to the video input (yellow) located on the side of TV.
- B** Connect audio cables (red/white) from audio outputs on device to audio inputs (red/white) on the side of TV.
- C** *Tip: For mono devices, connect only white audio cable from device's audio output to white audio input on the side of TV.*

Turn on TV and the device. Press the AV button on the remote control until FRONT/SIDE appears on TV screen.

Press PLAY on the device to verify connection.

7 Audio to Hi-Fi System (Digital)

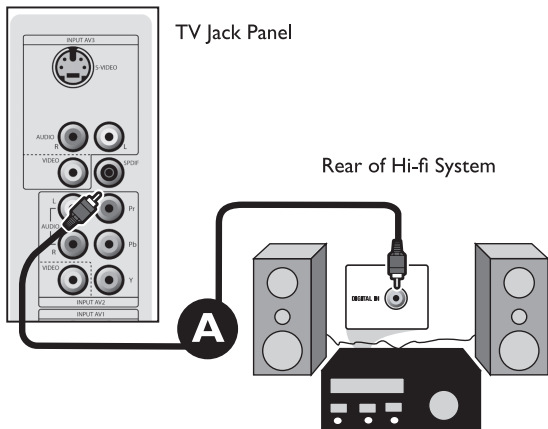

Using SPDIF

- Ⓐ Connect audio cable from the SPDIF jack on the rear of the TV to the DIGITAL IN jack on the rear of the hi-fi system.

Tip: SPDIF (Sony and Philips Digital Interconnect Format) is highly recommended for high quality digital sound output.

8 Audio to Hi-Fi System (Analog)

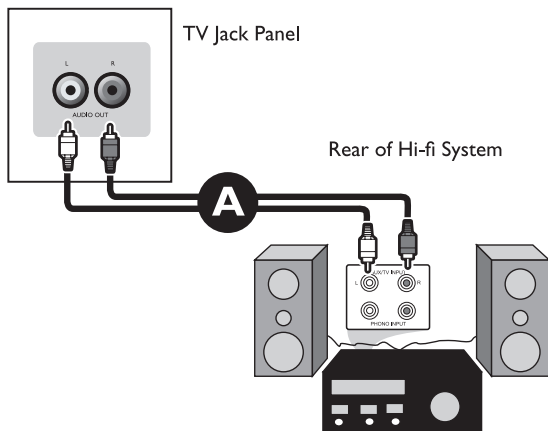

Using AUDIO OUT

- Ⓐ Connect audio cable from the AUDIO OUT on the rear of the TV to the AUX/TV IN jack on the rear of the hi-fi system.

To select connected devices

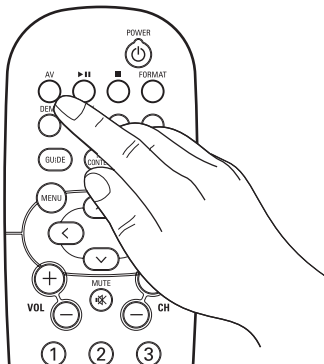

- 1 Press the **AV** button repeatedly or select **Source** in the Settings menu (see p. 13) to select **AV1**, **AV2**, **AV3**, **HDMI**, **Side** or **TV**, according to where you connected your devices.
- 2 Press the cursor up/down button.
- 3 Press **OK** button.

Multimedia browser

Note: This is primarily for service only! It may work with certain memory devices but not with most camera devices.



Multimedia browser lets you display pictures or play audio files stored on a USB device.

The Multimedia browser application is invoked from the My Content menu (press the **MY CONTENT** button) by selecting the USB device and pressing the cursor right.

Notes:

- Following file formats can be reproduced:
 - For pictures: JPEG
 - For audio: MP3, MP3 Pro
- Only FAT/DOS-formatted memory devices are supported.
- If your digital camera is not supported, make sure your camera is switched on and verify if its configuration settings are correct (see the manual of your camera).
- Magnavox cannot be responsible if your USB device is not supported.

Viewing content from a USB device

Inserting a USB device

Note: USB devices are not supplied with this TV.

Insert a USB device in the **USB** connector at the side of the TV. When a USB device is inserted, the Multimedia browser menu is displayed automatically, see further.

Removing the USB device

- & First switch off the My Content menu. To do so, navigate to the Multimedia browser menu and press the **MY CONTENT** button to exit the menu.
- & Remove the USB device.

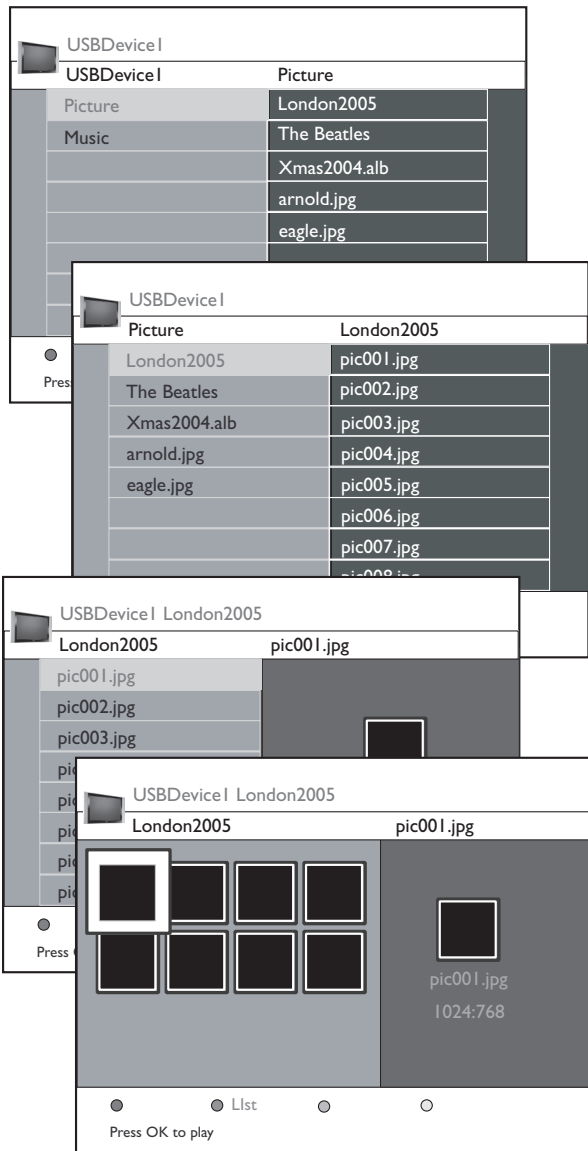





Multimedia Browser menu

- 1 Insert a USB device.
- 2 Select the USB device under Multimedia with the cursor up/down. The Multimedia browser will allow the user to browse content stored on the inserted USB device.
- 3 Press the cursor right.
 - & The 2-panel browser will be shown with the left panel containing the content types (Music, Picture). The right panel will display the content that is available of the selected content type.
- 4 Press the cursor up/down to select a content type and press the cursor right to enter the content.
- 5 Press the cursor up/down to select a file or a directory.
 - Note: Press the green color button to display all the image files in the current directory as thumbnails when browsing pictures. Press the green button again to display the image files in a list.
- & In case a **file** is selected, press the **OK** button to display a picture file or to play an audio file.
 - In case a directory, album or playlist is selected, press the cursor right to enter the content or press the **OK** button to start a slide show or a playback of the files present in the directory, album or playlist.
- 5 Press the cursor left to keep music playing and switch back to the Multimedia menu.
- 6 Press one of the color buttons on the remote control to perform the corresponding function mentioned at the bottom of the screen. The blue color button can be used to let the color re-appear.
- & To stop playing content, press the **■** button on the remote control.

Notes:

- **Your TV supports slide shows with background music.**
- The playback will continue to play even if temporarily switched to browser screens. The audio will be stopped when another song starts playing, or when the end has been reached.
- Progressive JPEG files are not supported.
- The length of the files should not exceed 128 characters.
- Do not use a dot "." in folder naming.

Following icons may appear:

-  folder
-  pictures
-  music
-  self made playlist/album

Function buttons at the bottom of the screen

- | | |
|-----------------------|---------------------------------------------------------------------|
| Details | to display a description of the selected file or directory; |
| Transitions | to select if a transition during a slide show should be applied; |
| Slide time | to select the duration a picture will be displayed in a slide show; |
| Rotate | to rotate a picture; |
| Repeat one/all | to repeat the playback of a music file; |
| Shuffle | to shuffle music collections in a random way; |

Other function buttons on the remote control

- to stop displaying content;
- ▶▶** to pause displaying content;
- ▶▶▶** to play a single file, start a slide show, playback of a folder or other collection.

Troubleshooting Tips

Check this List of **Symptoms** and **Suggested Steps To Take** before requesting Service. You may be able to solve the problem yourself. If you face problems connecting the TV to external devices, please refer to the User Guide of the external device or call their service centers for help. Charges for TV installation and adjustments of customer controls are not covered under your warranty.

SYMPTOMS		SUGGESTED STEPS TO TAKE
Hookup	Can't get external audio equipment to work with TV.	<ol style="list-style-type: none"> 1. SPDIF output audio only in digital mode and the audio equipment used must have the decoder. 2. Monitor Out Audio LR output audio for both analog and digital programs
Installation	Can't get the AV channels on the TV screen.	Press the AV button on the remote control repeatedly to select the desired AV channels. Note: SVHS can only be selected if a S-VHS device is connected and powered on.
Installation	TV Displays Wrong Channel or No Channels Above 13	Go to TUNER MODE in the television menu and select the correct signal source, then perform the automatic installation again. (Refer to page 8).
Installation	Channel numbers do not follow the channel number of the programs.	Go to TUNER MODE in the television menu and select the correct signal source, then perform the automatic installation again. (Refer to page 8).
Installation	Auto programing is taking too long.	Auto programing may take 20 to 40 minutes depending on the number of channels that are available.
Settings	<p>Error messages appear on the screen of TV:</p> <p>No Signal</p> <p>No Program</p> <p>Audio Only</p>	<p>Check that the antenna / cable is connected properly and that you have selected the correct tuner mode (refer to page 8).</p> <p>There could be temporarily no transmission on the selected channel. You may like to add these channels to the Weak Dig Sig. list. (refer to page 9). When transmission is resumed or when available, your TV will receive it.</p> <p>The current channel has only audio transmission.</p>
Sound	Disturbing sound (such as buzzing, clicking, cracking, humming, whistling, etc).	<p>It is normal to hear a disturbing sound (such as buzzing, clicking, cracking, humming, whistling, etc) from a distance less than 2 meters (6 feet) with the television sound muted.</p> <p>If problem occurs on one channel, you may have a signal problem. Please contact the cable provider or local broadcaster regarding the specific channel.</p>
Sound	Sound is not in Stereo.	<p>This could be due to any of the following reasons:</p> <ol style="list-style-type: none"> 1. Not all transmitted broadcasts by the cable or broadcast stations are in STEREO. Try checking with several major network stations to be sure that the station you selected is in STEREO. 2. When SAP is turned ON, the sound mode is automatically set to MONO. 3. Sound mode is set to MONO. Set the sound mode to STEREO. (Refer to page 17). 4. When using an AV input, the television will not display STEREO even though it is producing stereo sound.
General	No power to the TV	<p>Check the TV power cord. Unplug the power cord from the TV, wait 10 seconds, then reinsert the plug into your wall outlet. Power On the TV again.</p> <p>Plug the power cord directly to the wall socket and not via an extension cord.</p> <p>If you need to use an extension cord, check that the fuse on the AC power strip is not blown.</p>

SYMPTOMS		SUGGESTED STEPS TO TAKE
General	TV is not responding to Remote Control	Ensure the batteries are inserted into the remote control according to the illustration in the battery compartment. Refer to page 4. Reset the television by disconnecting the power plug from the wall outlet for 10 seconds and then reconnecting it again.
General	Remote control is not working	Clean the remote control and the remote control sensor window on the TV. Check the TV power cord. Unplug the TV, wait 10 seconds, then reinsert the plug into the wall.
General	No Picture on the TV screen	Check antenna connections. Are they properly secured to the TV ANT 75 ohm plug? Check the TUNER MODE control for the correct tuner setting. Try running the Autoprogram feature to find all available channels (refer to page 9). Press the AV button on the remote control to make sure the correct signal source is selected (FRONT, AV1, AV2, Current Channel, etc.). <i>Note: SVHS can only be selected if a S-VHS device is connected and powered on.</i>
General	TV Displays white lines in letterbox when viewing a DVD disc	Some DVD Discs are encoded with as much as 30% more video information to give the best possible picture quality. With the DVD Player in the 16:9 picture format, the playback of this type of disc with extra video information can produce a number of small white lines in the upper portion of the black letterbox area. With some of these discs, this problem is inherent and does not require a service call.

If your problem is not solved

Turn your TV off and then on again once.

Never attempt to repair a defective TV yourself.

Check with your dealer or call a TV technician.

Telephone number Magnavox Customer

Care Center: 1-800-705-2000

Online help: www.magnavox.com/usasupport

Please, have the Model and Product number which you can find at the back of your television set ready, before calling.

Glossary

Aspect Ratio	The ratio between the width and height of the TV picture on the screen. In a normal TV set the aspect ratio is 4 to 3 (4:3). The new aspect ratio in HDTV is 16:9 which resembles the aspect ratio in a movie theatre (Widescreen). New TV systems support both 4:3 and 16:9 aspect ratio and can automatically switch between them.
Audio Video (A/V)	A term often used when discussing a channel on a TV receiver or on video equipment, which has been especially designed to accept VCR audio-video signals. This channel automatically activates special circuitry within the TV set to prevent picture distortion and skewing. It is also used for audio-video processors, which handle both types of signals.
ATSC	ATSC: Advanced Television Systems Committee. Formed to establish technical standards for advanced television systems, including digital high definition television (HDTV).
CVBS	Composite Video Baseband Signal. In broadcast television this refers to the video signal, including the colour information and syncs
DTV	Digital television. Generic term that refers to all digital television formats, including high-definition television (HDTV) and standard-definition television (SDTV).
DOLBY Digital	Dolby Digital - Six-channel digital audio standard that is part of the U.S. digital television standard; also called AC-3 or Digital 5.1. The channels consist of front left, front right, front center, surround or rear left, surround or rear right, and a separate subwoofer
Digital Tuner	A digital tuner serves as the decoder required to receive and display digital broadcasts. It can be included inside TV sets or via a set-top box.
HDTV	The generally agreed upon definition of HDTV is approximately twice the vertical and horizontal picture resolution of today's NTSC TV, which essentially makes the picture twice as sharp. HDTV also has a screen ratio of 16:9 as compared with most of today's TV screens, which have a screen ratio of 4:3. HDTV offers reduced motion artifacts (i.e. ghosting, dot crawl), and offers 5.1 independent channels of CD-quality stereo surround sound, (also referred to as AC-3).
NTSC	National television system committee. The organization that developed the analog television standard currently in use in the U.S., Canada, and Japan. Now generally used to refer to that standard. The NTSC standard combines blue, red, and green signals modulated as an AM signal with an FM signal for audio.
Progressive Scan	In Progressive Scanning all the horizontal scan lines are scanned on to the screen at one time. The Digital TV and HDTV Standards accept both Interlaced Scan and Progressive Scan broadcast and display methods.
Resolution	Resolution: A measurement of the finest (smallest) detail that is visible in a video image. TV Resolutions may be expressed as number of pixels in an image; or more commonly, "As Total Number of (horizontally scanned) Lines used to create the image. Standard Digital TV Resolutions: SDTV: 480i - The picture is 704x480 pixels, 480p - The picture is 704x480 pixels. HDTV: 720p - The picture is 1280x720 pixels, 1080i - The picture is 1920x1080 pixels, 1080p - The picture is 1920x1080 pixels.

WARNING Concerning Stationary Images on the TV Screen:

Do not leave picture border bars or stationary images on screen for extended periods of time. This can cause uneven picture-tube aging.

Normal use of the TV should involve the showing of pictures that contain constantly moving and changing images that fill the screen. Be careful not to leave nonmoving images on screen for extended periods of time, or to display the same images on screen too frequently, because subtle ghost images can be left on the picture tubes. Avoid showing pictures with border bars or the same stationary images more than 15 percent of your total viewing in any one week. Sources of stationary images may be broadcast channels, cable channels, satellite channels, digital television boxes, DVD discs, laser discs, video games, CD-i discs, videotapes, and others. **Here are some examples of stationary images (this is not an all-inclusive list; you may encounter others in your viewing):**

- **Border bars**— solid bars shown when viewing a standard (4:3) picture and some widescreen movies on your widescreen (16:9) TV
- **DVD menus**— listings of DVD disc content
- **Video-game images and scoreboards**
- **Television station logos**— present a problem if they are bright and stationary; moving or low-contrast graphics are less likely to cause uneven aging of the picture tube
- **Stock-market tickers**— presented at the bottom of the TV screen
- **Shopping channel logos and pricing displays**—bright and shown constantly or repeatedly in the same location on the TV screen.

All picture tubes age with use, with their light output diminishing over time. But by maintaining normal use—mixing television picture types—you will create conditions in the tubes age at an even rate. The result will be a TV picture that is evenly bright over the entire screen.

Placement of the TV

- To avoid cabinet warping, cabinet color changes, and increased chance of set failure, do not place the TV where temperatures can become excessively hot; for example, in direct sunlight or near a heating appliance.
- Be sure to allow a free flow of air to and from the perforated back cover of the set.

Cleaning

- To avoid possible shock hazard, be sure the TV is unplugged from the electrical outlet before cleaning.
- Regularly dust the TV with a dry, non-scratching duster to keep the TV clean.
- When cleaning the TV, take care not to scratch or damage the screen surface. Avoid wearing jewelry or using anything abrasive. Do not use household cleaners. Wipe the front screen with a clean cloth dampened with water. Use even, easy, vertical strokes when cleaning.
Specially designed screen-cleaning kits are also available. These kits contain anti-static cleaners and cloths designed to get into the ridges of the TV screen. Purchase the kits at stores that sell electronics. Or call our Customer Care Center at 1-800-705-2000.
- Gently wipe the cabinet surfaces with a clean cloth or sponge dampened in a solution of cool, clear water and a mild soap or detergent. Use a clean, dry cloth to dry the wiped surfaces.
- Occasionally vacuum the ventilation holes or slots in the back cover of the set.
- Never use thinners, insecticide sprays, or other chemicals on or near the cabinet, as they might cause permanent marring of the cabinet finish.

Specifications

	51MP6200D
PICTURE / DISPLAY Aspect ratio Display screen type Picture Enhancement	16 : 9 CRT Rear Projection TV Pixel Plus, Progressive Scan, 3D combfilter, Black stretch, Active Control, Auto Picture (5 modes), Transient improver, Digital Noise Reduction (DNR)
SOUND Output Power (RMS) Sound Enhancement Sound System	2 x 10W Auto Volume leveller, AutoSound (4 modes)
CONVENIENCE Ease of installation Ease of use Remote control type Remote control Teletext	Auto Program Channel list RCLU024 TV Closed captioning
ON SCREEN DISPLAY LANGUAGES	English, French, Spanish
CONNECTIVITY Back of TV Side	AV1/AV2 : Audio L/R input, Composite Video input (CVBS), Composite Video input (YPbPr) AV3: Audio L/R input, Composite Video input (CVBS), SPDIF output (Digital Only), S-Video input, HDMI Audio L/R input, Composite Video input (CVBS), S-Video input.
WEIGHT & DIMENSIONS : Weight (incl. Packaging) : Weight (excl. Packaging) : Carton Dimension Product Dimension Screen size :	181.5 lbs 165 lbs 52.44 " x 26.73 " x 52.56 " 49.02 " x 23.03 " x 50.31 " 51 "
POWER CONSUMPTION STANDBY POWER CONSUMPTION	255 W < 1 W

Introduction

Magnavox offers software upgrade capability for your TV using USB portable memory.

After you have completed a software upgrade, your TV will typically perform better.

What improvements are made depends on the upgrade software you are using as well as the software your TV contained before the upgrade.

You can execute the software upgrade procedure yourself.

Be aware that the content of this document is addressing technical or software skilled users.

Preparing a portable memory for software upgrade

For the procedure you will require:

- A personal computer with web browsing capability.
- An archive utility that supports the ZIP-format (e.g. WinZip for Windows or StuffIt for Mac OS).
- A preferably empty USB memory stick.

Note: Only FAT/DOS-formatted portable memory is supported.

New software can be obtained from your dealer or can be downloaded from the www.usasupport.magnavox.com website:

- 1 Go to **www.usasupport.magnavox.com** using the web browser on your PC.
- 2 Follow the procedure to find the information and the software related to your TV.
- 3 Select the latest software upgrade file and download it to your PC.
- 4 Decompress the ZIP-file and copy the file "autorun.upg" to the root directory of the USB portable memory.

Note: Only use software upgrades that can be found on the www.usasupport.magnavox.com web site.

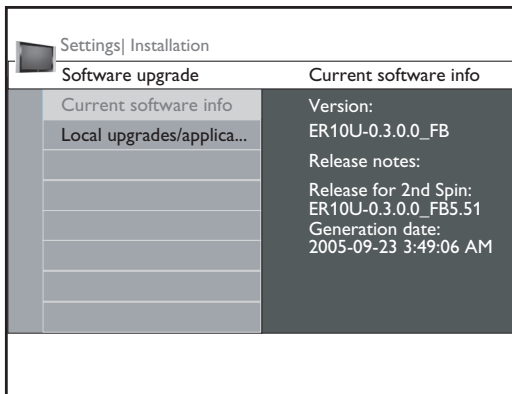

Verifying the version of the TV software

Before starting the software upgrade procedure, it is advised to check what the current TV software is.

- 1 Select **Software Upgrade** in the Installation menu.
- 2 Press the cursor right.
The Software Upgrade menu moves to the left panel.
- 3 Select **Current Software Info** to observe the version and the description of the current software.

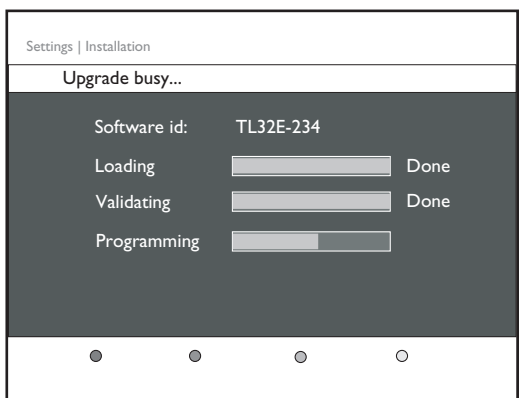

Automatic software upgrade procedure

For automatic software upgrade, the “autorun.upg” file should be copy to the root of the USB portable memory

- ❶ Power off your TV and remove all memory devices.
- ❷ Insert the USB portable memory that contains the downloaded software upgrade.
- ❸ Switch on your TV with the power switch  at the right side of the TV.
- ❹ At startup the TV will scan the USB portable memory until it finds the update content. The TV will automatically go to the upgrade mode. After a few seconds it will display the status of the upgrade procedure.

Warning:

- You are not allowed to remove the USB portable memory during the software upgrade procedure!
- In case of a power drop during the upgrade procedure, don't remove the USB portable memory from the TV. The TV will continue the upgrade as soon as the power comes back.
- If you try to upgrade to a software version lower than the current version, a confirmation will be asked. Downgrading to older software should only be done in case of real necessity.
- If an error occurs during the upgrade you should retry the procedure or contact your dealer.

- ❺ When the software upgrade was successful, remove the USB portable memory and restart your TV with the power switch  at the right side of the TV.

Your TV will start up with the new software.

Note: Once the upgrade is finished use your PC to remove the TV software from your USB portable memory.

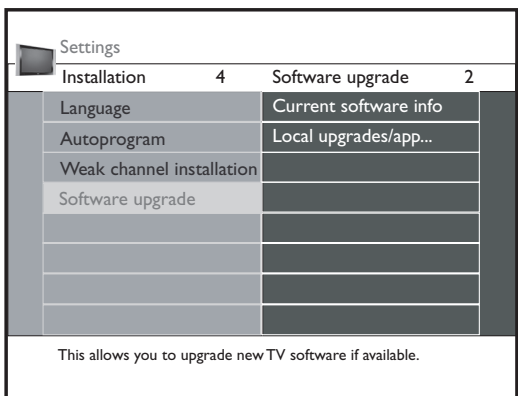

Manual software upgrade procedure

For a manual software upgrade copy the “autorun.upg” file in a directory called “Upgrades” located in the root of the USB portable memory.

- ❶ Insert the portable memory that contains the downloaded software upgrade.
- ❷ The TV will automatically start the content browser menu. Exit the menu by pressing the **MY CONTENT** key.
- ❸ Select **Software Upgrade** in the Installation menu. Go to **Local upgrades/applications**.
The TV will list all compatible images available on the USB portable memory and display the data for each selected upgrade image.
- ❹ Select the correct upgrade image and press the red color button to start the upgrade.
Your TV will restart and will automatically go to the upgrade mode. After a few seconds it will display the status of the upgrade procedure.

Warning:

If you try to upgrade to a software version equal or lower than the current version, a confirmation will be asked. Downgrading to older software should only be done in case of real necessity.

- ❺ When the software upgrade was successful, remove the USB portable memory and restart your TV with the power switch  at the right side of the TV.
Your TV will start up with the new software.

MAGNAVOX LIMITED WARRANTY

One (1) Year Labor & One (1) Year Parts & One (1) Year Display Repair

MAGNAVOX warrants this product against defect in material or workmanship, subject to any conditions set forth as follows:

PROOF OF PURCHASE:

You must have proof of the date of purchase to receive repair on the product. A sales receipt or other document showing the product and the date that you purchased the product as well as the authorized retailer included, is considered such proof.

COVERAGE:

(If this product is determined to be defective)

LABOR: For a period of one (1) year from the date of purchase, Magnavox will repair or replace the product, at its option, at no charge, or pay the labor charges to any Magnavox authorized service center. After the period of one (1) year, Magnavox will no longer be responsible for charges incurred.

PARTS: For a period of one (1) year from the date of purchase, Magnavox will supply, at no charge, new or rebuilt replacement parts in exchange for defective parts. Magnavox authorized service centers will provide removal and installation of the parts for one (1) year.

DISPLAY: For a period of one (1) year from the date of purchase, Magnavox will supply, at no charge, a new or rebuilt active display device in exchange for the defective display. Magnavox authorized service centers will provide removal and installation of the parts under the specified labor warranty. (PTV screens carry a thirty (30) day replacement warranty.)

EXCLUDED FROM WARRANTY COVERAGE

Your warranty does not cover:

- Labor charges for installation or setup of the product, adjustment of customer controls on the product, and installation or repair of antenna systems outside of the product.
- Product repair and/or part replacement because of improper installation, connections to improper voltage supply, abuse, neglect, misuse, accident, unauthorized repair or other cause not within the control of Magnavox.
- A product that requires modification or adaptation to enable it to operate in any country other than the country for which it was designed, manufactured, approved and/or authorized, or repair of products damaged by these modifications.
- Damage occurring to product during shipping when improperly packaged or costs associated with packaging
- Product lost in shipment and no signature verification of receipt can be provided.
- A product used for commercial or institutional purposes (including but not limited to rental purposes).
- Products sold AS IS or RENEWED.

TO OBTAIN WARRANTY SERVICE IN THE U.S.A., PUERTO RICO, OR U.S. VIRGIN ISLANDS...

Contact Magnavox Customer Care Center at:
1-800-705-2000

TO OBTAIN WARRANTY SERVICE IN CANADA...

1-800-661-6162 (French Speaking)
1-800-705-2000 (English or Spanish Speaking)

REPAIR OR REPLACEMENT AS PROVIDED UNDER THIS WARRANTY IS THE EXCLUSIVE REMEDY FOR THE CONSUMER. MAGNAVOX SHALL NOT BE LIABLE FOR ANY INCIDENTAL OR CONSEQUENTIAL DAMAGES FOR BREACH OF ANY EXPRESS OR IMPLIED WARRANTY ON THIS PRODUCT. EXCEPT TO THE EXTENT PROHIBITED BY APPLICABLE LAW, ANY IMPLIED WARRANTY OF MERCHANTABILITY OR FITNESS FOR A PARTICULAR PURPOSE ON THIS PRODUCT IS LIMITED IN DURATION TO THE DURATION OF THIS WARRANTY.

Some states do not allow the exclusions or limitation of incidental or consequential damages, or allow limitations on how long an implied warranty lasts, so the above limitations or exclusions may not apply to you. In addition, if you enter into a service contract agreement with the MAGNAVOX partnership within ninety (90) days of the date of sale, the limitation on how long an implied warranty lasts does not apply.

This warranty gives you specific legal rights. You may have other rights which vary from state/province to state/province.

Magnavox, P.O. Box 671539, Marietta, GA. 30006-0026

(Warranty: 4835 710 28275)

Free Manuals Download Website

<http://myh66.com>

<http://usermanuals.us>

<http://www.somanuals.com>

<http://www.4manuals.cc>

<http://www.manual-lib.com>

<http://www.404manual.com>

<http://www.luxmanual.com>

<http://aubethermostatmanual.com>

Golf course search by state

<http://golfingnear.com>

Email search by domain

<http://emailbydomain.com>

Auto manuals search

<http://auto.somanuals.com>

TV manuals search

<http://tv.somanuals.com>