

USER MANUAL

MAGNAVOX
SMART. VERY SMART.

Color Television
32MT3305/17

Thank you for choosing Magnavox.

Need help fast?



Read your Quick Use Guide and/or User Manual first for quick tips that make your using your Magnavox product more enjoyable. If you have read your instructions and still need assistance you may access our online help at
www.magnavox.com
or
call 1-800-705-2000
while with your product.

3121 235 22421-English

Return your Warranty Registration card today to ensure you receive all the benefits you're entitled to.

Once your MAGNAVOX purchase is registered, you're eligible to receive all the privileges of owning a MAGNAVOX product. So complete and return the Warranty Registration Card enclosed with your purchase at once. And take advantage of these important benefits.

Warranty Verification

Registering your product within 10 days confirms your right to maximum protection under the terms and conditions of your MAGNAVOX warranty.

Owner Confirmation

Your completed Warranty Registration Card serves as verification of ownership in the event of product theft or loss.

Model Registration

Returning your Warranty Registration Card right away guarantees you'll receive all the information and special offers which you qualify for as the owner of your model.

Congratulations on your purchase, and welcome to the "family!"

Dear MAGNAVOX product owner:

Thank you for your confidence in MAGNAVOX. You've selected one of the best-built, best-backed products available today. We'll do everything in our power to keep you happy with your purchase for many years to come.

As a member of the MAGNAVOX "family," you're entitled to protection by one of the most comprehensive warranties and outstanding service networks in the industry. What's more, your purchase guarantees you'll receive all the information and special offers for which you qualify, plus easy access to accessories from our convenient home shopping network.

Most importantly, you can count on our uncompromising commitment to your total satisfaction.

All of this is our way of saying welcome and thanks for investing in a MAGNAVOX product.

P.S. Remember, to get the most from your MAGNAVOX product, you must return your Warranty Registration Card within 10 days. So please mail it to us right now!

Know these **safety** symbols



⚡ This "bolt of lightning" indicates un-insulated material within your unit may cause an electrical shock. For the safety of everyone in your household, please do not remove product covering.

⚠ The "exclamation point" calls attention to features for which you should read the enclosed literature closely to prevent operating and maintenance problems.

WARNING: To reduce the risk of fire or electric shock, this apparatus should not be exposed to rain or moisture and objects filled with liquids, such as vases, should not be placed on this apparatus.

CAUTION: To prevent electric shock, match wide blade of plug to wide slot, fully insert.

ATTENTION: Pour éviter les choc électriques, introduire la lame la plus large de la fiche dans la borne correspondante de la prise et pousser jusqu'au fond.

For Customer Use

Enter below the Serial No. which is located on the rear of the cabinet. Retain this information for future reference.

Model No. _____
Serial No. _____

Visit our World Wide Web Site at <http://www.magnavox.com>

IMPORTANT SAFETY INSTRUCTIONS

Read before operating equipment

1. Read these instructions.
2. Keep these instructions.
3. Heed all warnings.
4. Follow all instructions.
5. Do not use this apparatus near water.
6. Clean only with a dry cloth.
7. Do not block any of the ventilation openings. Install in accordance with the manufacturer's instructions.
8. Do not install near any heat sources such as radiators, heat registers, stoves, or other apparatus (including amplifiers) that produce heat.
9. Do not defeat the safety purpose of the polarized or grounding-type plug. A polarized plug has two blades with one wider than the other. A grounding type plug has two blades and third grounding prong. The wide blade or third prong are provided for your safety. When the provided plug does not fit into your outlet, consult an electrician for replacement of the obsolete outlet.
10. Protect the power cord from being walked on or pinched particularly at plugs, convenience receptacles, and the point where they exit from the apparatus.
11. Only use attachments/accessories specified by the manufacturer.
12.  Use only with a cart, stand, tripod, bracket, or table specified by the manufacturer, or sold with the apparatus. When a cart is used, use caution when moving the cart/apparatus combination to avoid injury from tip-over.
13. Unplug this apparatus during lightning storms or when unused for long periods of time.
14. Refer all servicing to qualified service personnel. Servicing is required when the apparatus has been damaged in any way, such as power-supply cord or plug is damaged, liquid has been spilled or objects have fallen into apparatus, the apparatus has been exposed to rain or moisture, does not operate normally, or has been dropped.
15. This product may contain lead and mercury. Disposal of these materials may be regulated due to environmental considerations. For disposal or recycling information, please contact your local authorities or the Electronic Industries Alliance: www.eiae.org
16. **Damage Requiring Service** - The appliance should be serviced by qualified service personnel when:
 - A. The power supply cord or the plug has been damaged; or
 - B. Objects have fallen, or liquid has been spilled into the appliance; or
 - C. The appliance has been exposed to rain; or
 - D. The appliance does not appear to operate normally or exhibits a marked change in performance; or
 - E. The appliance has been dropped, or the enclosure damaged.
17. **Tilt/Stability** - All televisions must comply with recommended international global safety standards for tilt and stability properties of its cabinet design.
 - Do not compromise these design standards by applying excessive pull force to the front, or top, of the cabinet which could ultimately overturn the product.
 - Also, do not endanger yourself, or children, by placing electronic equipment/toys on the top of the cabinet. Such items could unexpectedly fall from the top of the set and cause product damage and/or personal injury.
18. **Wall or Ceiling Mounting** - The appliance should be mounted to a wall or ceiling only as recommended by the manufacturer.
19. **Power Lines** - An outdoor antenna should be located away from power lines.
20. **Outdoor Antenna Grounding** - If an outside antenna is connected to the receiver, be sure the antenna system is grounded so as to provide some protection against voltage surges and built up static charges.
Section 810 of the National Electric Code, ANSI/NFPA No. 70-1984, provides information with respect to proper grounding of the mast and supporting structure, grounding of the lead-in wire to an antenna-discharge unit, size of grounding connectors, location of antenna-discharge unit, connection to grounding electrodes, and requirements for the grounding electrode. See Figure below.
21. **Object and Liquid Entry** - Care should be taken so that objects do not fall and liquids are not spilled into the enclosure through openings, comply with recommended international global safety standards for tilt and stability properties of its cabinet design.
22. **Battery Usage CAUTION** - To prevent battery leakage that may result in bodily injury, property damage, or damage to the unit:
 - Install all batteries correctly, with + and - aligned as marked on the unit.
 - Do not mix batteries (old and new or carbon and alkaline, etc.).
 - Remove batteries when the unit is not used for a long time.

Note to the CATV system installer: This reminder is provided to call the CATV system installer's attention to Article 820-40 of the NEC that provides guidelines for proper grounding and, in particular, specifies that the cable ground shall be connected to the grounding system of the building, as close to the point of cable entry as practical.

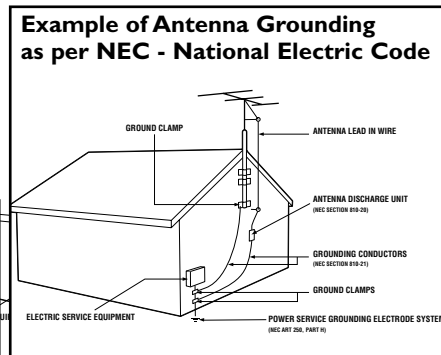

PANEL LAYOUT

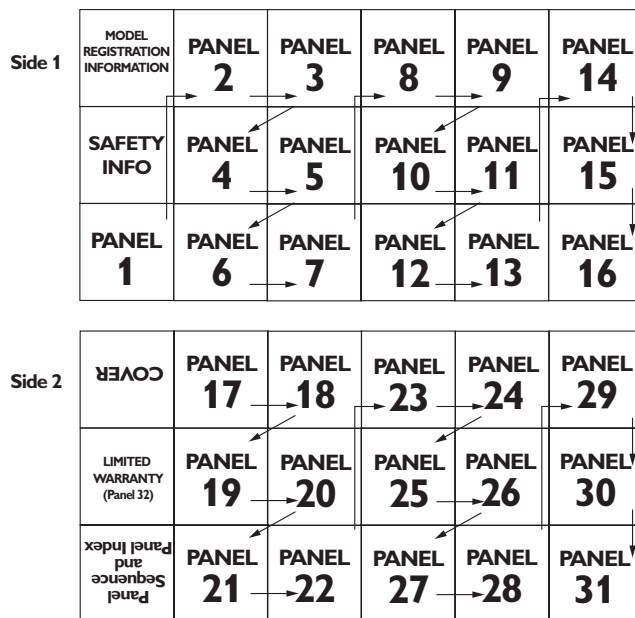

PANEL INDEX

Subject	Panel No.	Subject	Panel No.
Alternate Channel	17	Remote Batteries Installation	3
Audio/Video Connections		Smartlock™ Controls	
Rear Audio/Video Input Jacks	4	Access Code	19
Headphone Jack	8	Block All Channels	21
Automatically Program TV	13	Block Channels	20
Basic Antenna Connection	1	Clear All Blocked Channels	21
Basic Remote Operation	3	Movie Ratings	22
Basic Television Operation	3	Other Blocking Options	24
Cable/Cable Box Basic Connection	1-2	TV Ratings	23
Care and Cleaning	29	Understanding Smartlock™	18
Channel Edit	14	SmartPicture™ Control	26
Closed Caption Control	25	SmartSound™ Control	26
Format Control	17	SmartSurf™ Control	27
Language Control	11	Sound Menu Controls	16
Limited Warranty	30	Troubleshooting	28
Picture Menu Controls	15	Tuner Mode	12
Remote Control Button Descriptions	9-10		
Sleeptimer	25		

I BASIC ANTENNA CONNECTIONS

A combination antenna receives normal broadcast channels (VHF 2–13 and UHF 14–69). Your connection is easy because there is only one 75Ω (ohm) antenna plug on the back of your TV, and that's where the antenna goes.

1 If your antenna has a round cable (75 ohm) on the end, then you're ready to connect it to the TV.

If your antenna has a flat, twin-lead wire (300 ohm), you first need to attach the antenna wires to the screws on a 300- to 75-ohm adapter.

2 Push the round end of the adapter (or antenna) onto the 75Ω (ohm) plug on the back of the TV. If the round end of the antenna wire is threaded, screw it down finger tight.

Antenna Connection

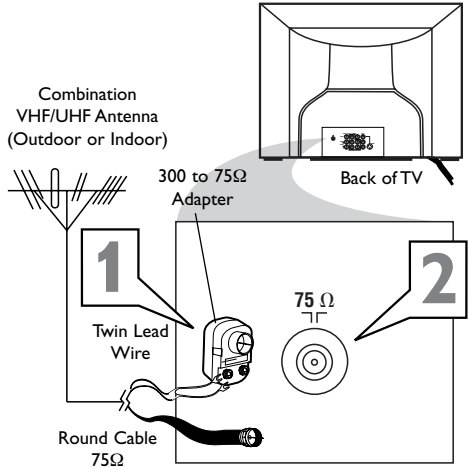

BASIC CABLE TV CONNECTIONS

The Cable TV input into your home may be a single (75 ohm) cable. If so, this connection is very simple. Follow the steps below to connect your cable signal to your new television.

1 Connect the open end of the round Cable Company supplied cable to the 75Ω input on the TV. Screw it down finger tight.

Direct Cable Connection

Cable signal coming from Cable Company

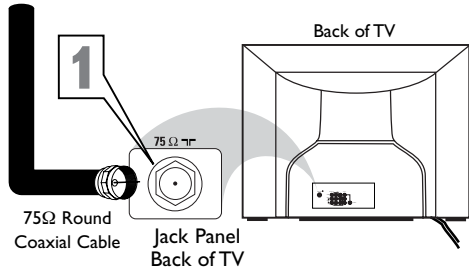

2

CABLE BOX CONNECTIONS

If your cable signal uses a cable box or decoder, follow the easy steps below to complete the connection.

Cable Box (w/RF In/Outputs):

This connection will be mono.

- 1** Connect the Cable Company supplied cable to the signal IN(put) plug on the back of the Cable Box.
- 2** Using a separate round coaxial cable, connect one end to the OUT(put) plug on the back of the Cable Box.
- 3** Connect the other end of the round coaxial cable to the 75Ω input on the back of the television. Screw it down finger tight.

NOTE: Set the OUTPUT CHANNEL SWITCH on the back of the cable box to CH 3 or 4. Tune the TV to the same channel and change channels at the cable box.

Cable Box (w/Audio/Video Outputs):

This connection will supply Stereo sound.

- 4** Connect the Cable Company supplied cable to the cable signal IN(put) plug on the back of the Cable Box.
- 5** Using an RCA type Video Cable, connect one end of the cable to the Video (or ANT, your cable box may be labeled differently) Out jack on the cable box and the other end to the AVI Video Input on the TV.
- 6** Connect one end of the Audio Left and Right Cable to the left and right Audio Out L & R jacks on the cable box. Connect the other end to the AVI Audio L & R Input jacks on the TV.

NOTE: Use the Channel + or – buttons on the TV remote control to tune to the AVI channel for the cable box signal. Once tuned, change channels at the cable box, not the television.

Cable Box (w/RF In/Outputs):

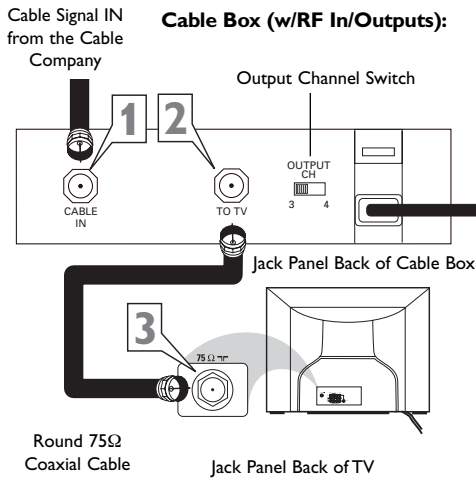

Cable Box (w/Audio/Video Outputs):

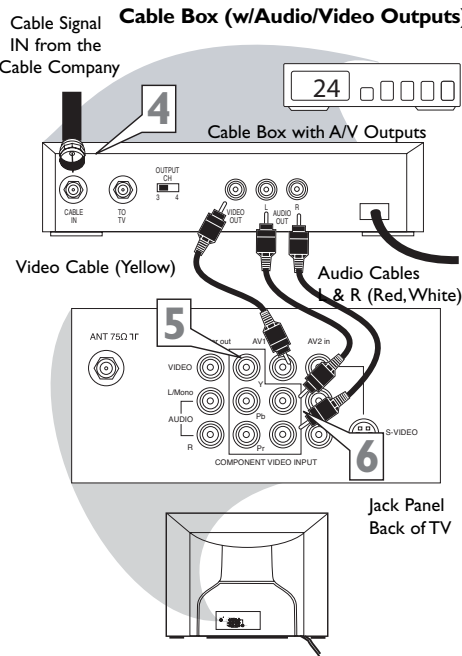

3

BASIC TV AND REMOTE CONTROL OPERATION

TELEVISION

- 1 Press the POWER button** to turn the TV ON.
Note: You can also press any button on the top of the TV to turn the TV ON.
- 2 Press the VOLUME + button** to increase the sound level, or the **VOLUME - button** to lower the sound level.
- 3 Press the CHANNEL UP + or DOWN - button** to select TV channels.

Remote Sensor - Sensor for activating remote control commands when the remote is used to control the TV.

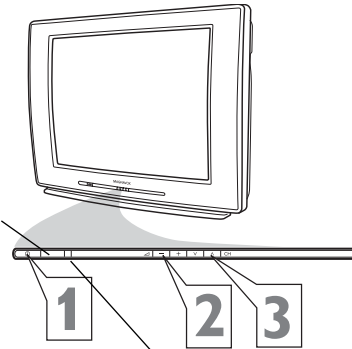

Power Light Indicator - Light will show while TV is powered on.

REMOTE CONTROL

- 4 Point the remote control** toward the remote sensor window on the TV when operating the TV with the remote.

BATTERY INSTALLATION

- 5 Remove the battery compartment lid** on the back of the remote.
- 6 Place the batteries (2-AA) in the remote.** Be sure the (+) and (-) ends of the batteries line up correctly (inside of case is marked.)
- 7 Reattach the battery lid.**

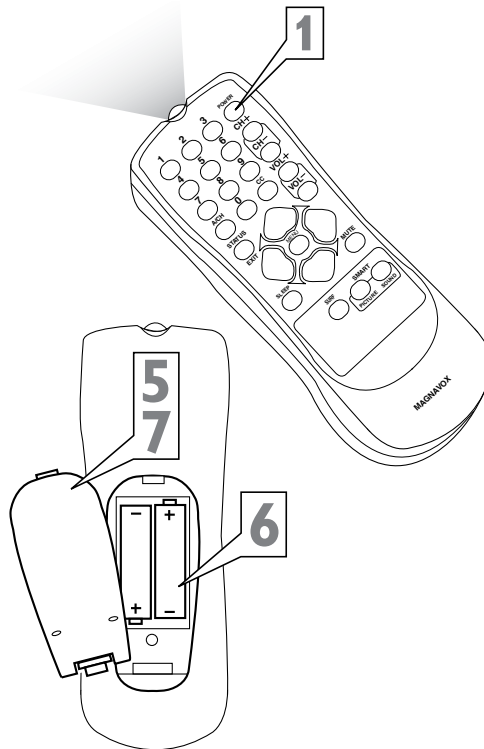

HELPFUL HINT

Remember, the tuned channel number will always briefly appear when the TV is first turned ON (and with channel changes.)

You can also press the STATUS/EXIT button (on the remote) to see what channel the TV is ON.

4

USING THE AV1 IN OR AV2 IN (INPUT) JACKS

The TV's audio/video input jacks are for direct picture and sound connections between the TV and a VCR (or similar device) that has audio/video output jacks. Both the AV1 and AV2 Input Jack connections are shown on this page, but either one can be connected alone. Follow the easy steps below to connect your accessory device to the AV1 and AV2 IN Jacks located on the back of the TV.

- 1** Connect the **VIDEO (yellow)** cable to the VIDEO **AV1 IN** (or AV2 IN) jack on the back of the TV.
- 2** Connect the **AUDIO (red and white)** cables to the AUDIO (left and right) **AV1 IN** (or AV2 in) jacks on the rear of the TV.
- 3** Connect the **VIDEO (yellow)** cable to the VIDEO OUT jack on the back of the VCR (either one or two) or accessory device being used.
- 4** Connect the **AUDIO (red and white)** cables to the AUDIO (left and right) OUT jacks on the rear of the VCR (either one or two) or accessory device being used.
- 5** Turn the **VCR (either one or two) or accessory device and the TV ON.**
- 6** Press the **CH +** or **CH -** buttons to set the TV to its **AV1 or AV2 channel**. (Go to your lowest channel, for example channel 1, then change channels down to find the correct input.)
- 7** With either of the VCRs (or accessory devices) **ON** and a prerecorded tape (CD, DVD, etc.) inserted, **press the PLAY button** to view the tape on the television.

HELPFUL HINT

Audio and video cables are not supplied with the TV, but are available from Magnavox or electronics retailers.

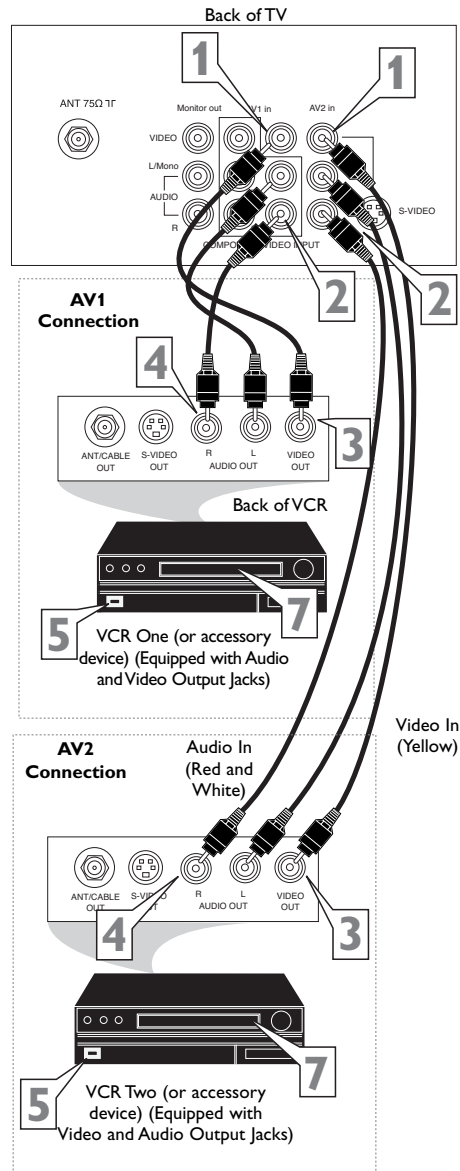

5

USING THE S-VIDEO INPUT JACKS

The S(uper)-Video connection on the rear of the TV can provide you with better picture detail and clarity for the playback of accessory sources such as DBS (digital broadcast satellite), DVD (digital video discs), video games, and S-VHS VCR (video cassette recorder) tapes than the normal antenna picture connections.

NOTE: The accessory device must have an S-VIDEO OUT(put) jack in order for you to complete the connection on this page.

- 1** Connect one end of the S-VIDEO CABLE to the S-VIDEO jack on the back of the TV. Then connect one end the AUDIO (red and white) CABLES to the AV2 in AUDIO L and R (left and right) jacks on the rear of the TV.
- 2** Connect other end of the S-VIDEO CABLE to the S-VIDEO OUT jack on the back of the VCR. Then connect the other ends of the AUDIO (red and white) CABLES to the AUDIO (left and right) OUT jacks on the rear of the VCR.
- 3** Turn the VCR and the TV ON.
- 4** Press the CH + or CH- buttons to set the TV to its SVHS2 channel. (Go to your lowest channel, for example channel 1, then change channels down to find the correct source channel.)
- 5** Now your ready to place a prerecorded video tape in the VCR and press the PLAY ► button.

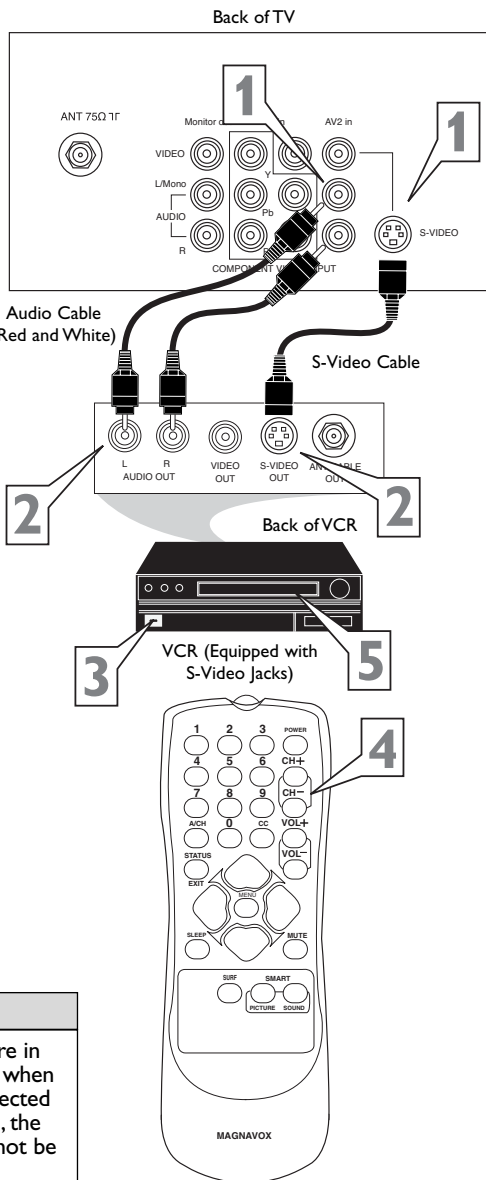

HELPFUL HINT

The S-VIDEO and VIDEO AV2 in(puts) are in parallel. The S-VIDEO input is dominant when in use. If separate video signals are connected to the S-VIDEO and VIDEO AV2 in(puts), the signal from the VIDEO AV2 in(puts) will not be usable.

6

USING THE CVI (COMPONENT VIDEO INPUT) JACKS

Component Video inputs provide for the highest possible color and picture resolution in the playback of digital signal source material, such as with DVD players. The color difference signals (Pb, Pr) and the luminance signal (Y) connected and received separately, which allows for improved color bandwidth information (not possible when using composite video or S-Video connections).

- 1 **Connect the Component (Y, Pb, Pr) Video OUT** jacks from the DVD player (or similar device) to the (Y, Pb, Pr) in(put) jacks on the TV. When using the Component Video Inputs, it is best not to connect a signal to the AV1 IN Video Jack.
- 2 **Connect the red and white AUDIO CABLES** to the Audio (left and right) output jacks on the rear of the accessory device to the Audio (L and R) AV1 IN Input Jacks on the TV.
- 3 **Turn the TV and the DVD (or digital accessory device) ON.**
- 4 **Press the CH + or CH- buttons to set the TV to its CVI channel.** (Go to your lowest channel, for example channel 1, then change channels down to find the correct source channel.)
- 5 Insert a DVD disc into the DVD player and **press the PLAY ► button on the DVD Player.**

The CVI connection will dominate over the AV1 in Video Input. When a Component Video Device is connected as described, it is best not to have a video signal connected to the AV1 in Video Input jack.

Back of TV

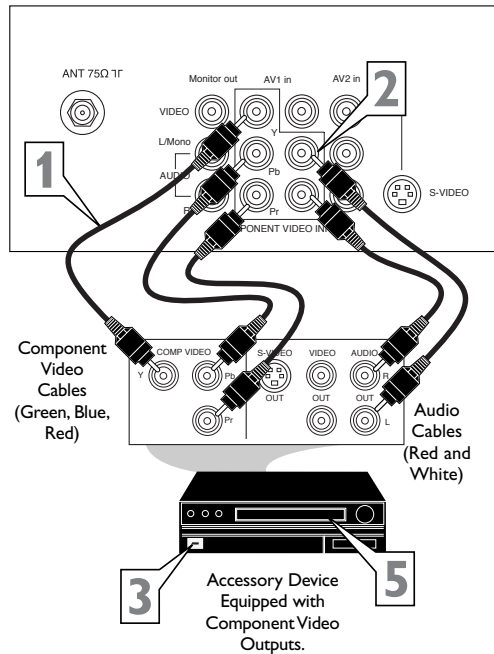

HELPFUL HINT

The description for the component video connectors may differ depending on the DVD player or accessory digital source equipment used (for example, Y, Pb, Pr; Y, B-Y, R-Y; Y, Cr, Cb). Although abbreviations and terms may vary, the letters *b* and *r* stand for the blue and red color component signal connectors, and *Y* indicates the luminance signal. Refer to your DVD or digital accessory owner's manual for definitions and connection details.

Note: Cables are not supplied with the TV, but are available from Magnavox or electronics retailers.

7

USING THE MONITOR OUT(PUT) JACKS

The Monitor (Audio/Video) out jacks are great for recording with a VCR or used to connect an external audio system for better sound reproduction.

For Audio System Connection:

- 1 Connect one end of the R(ight) and L(ef) AUDIO (Monitor Out) jacks on the TV to the R and L audio input jacks on your amplifier or sound system. Set the audio system's volume to a normal listening level.
- 2 Turn the TV and audio system ON. You can now adjust the sound level coming from the audio system with the VOLUME (+) or (-) button on the TV or remote control.

For Second VCR Connection/Recorder:

NOTE: Refer to panel 4 for the proper hookup of the first VCR. Follow the instructions on how to tune to the AV1 channel to view a pre-recorded tape.

The following steps allow you to connect a second VCR to record the program while you're watching it.

- 3 Connect one end of the yellow Video Cable to the Monitor out VIDEO plug. Connect the other end to the VIDEO IN plug on the second VCR.
- 4 Connect one end of the red and white Audio cable from the Monitor out AUDIO L and R plugs on the TV to the AUDIO IN plugs on the VCR.
- 5 Turn the Second VCR ON, insert a VHS tape and it's ready to record what's being viewed on the TV screen.

HELPFUL HINT

Audio and video cables are not supplied with the TV, but are available from Magnavox or electronics retailers.

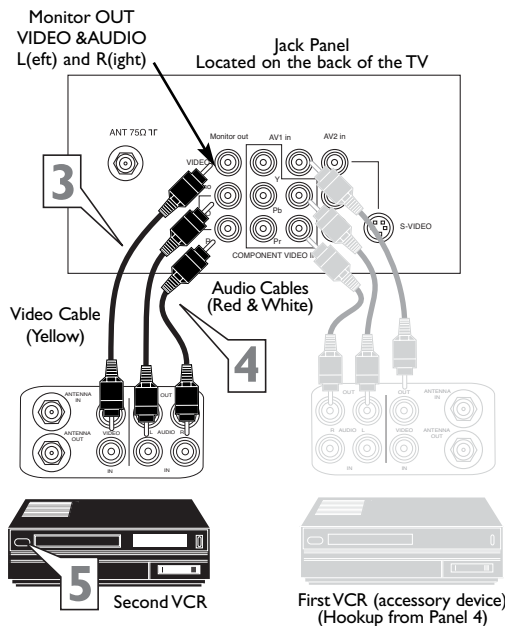
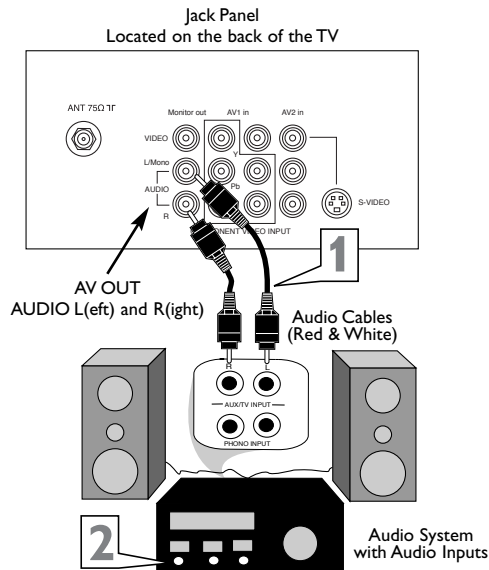

8

USING THE SIDE AUDIO / VIDEO INPUTS

Audio and Video Side Inputs are available for a quick connection of a VCR, to playback video from a camera or attach a gaming device. Use the AV button on the remote control to tune these inputs.

Side A/V Input Connection:

1 Connect the video (yellow) cable from the Video output on the Camera (or accessory device) to the Video (yellow) Input located on the SIDE of the TV.

For S-Video Devices: Connect one end of the S-VIDEO CABLE to the S-VIDEO jack on the SIDE of the TV and the other end to the S-VIDEO out jack on the Camera.

2 **For Stereo Devices:** Connect the audio cable (red and white) from the Audio Left and Right Outputs on the Camera to the Audio L and R (white and red) jack on the SIDE of the television.

For Mono Devices: Connect one end of the audio cable from the Audio Out jack on the device to the Audio L (white) jack on the SIDE of the television.

3 Turn the TV and the accessory device ON.

4 Press the CH + or CH- buttons to set the TV to its SIDE channel. (Go to your lowest channel, for example channel 1, then change channels down to find the correct source channel.)

5 Press the PLAY ► button on the accessory device to view playback, or to access the accessory device (camera, gaming unit, etc.).

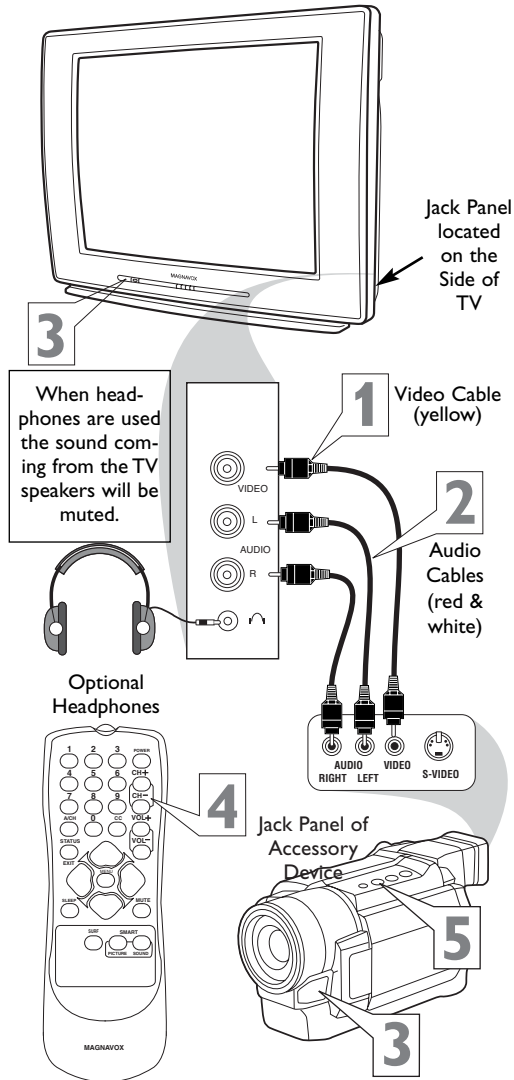

9

DESCRIPTION OF REMOTE CONTROL BUTTONS

NUMBER Buttons

Press the Number buttons to select TV channels or to enter values in the menu. For single-digit channels, press the Number button for the channel you want. The TV will pause briefly before going to the chosen channel.

A/CH Button (Alternate Channel)

Press to switch between the last channel and the present channel.
Details are on panel 27.

STATUS/EXIT Button

Press to see the current channel number.
Press to remove a menu.

CC Button

Press to activate Closed Captioning.
Details are on panel 25.

SLEEP Button

Press to set the TV to turn itself off within a certain time. *Details are on panel 25.*

SmartSurf

If your TV model has SmartSurf, press this button to move through the channels you have set. *Details are on panel 27.*

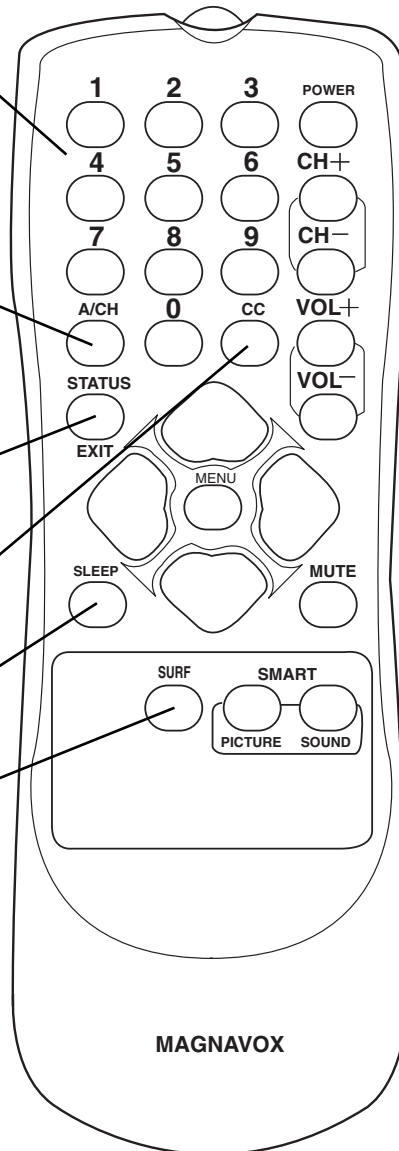

Continued on Next Panel

10 DESCRIPTION OF REMOTE CONTROL BUTTONS (CONT'D)

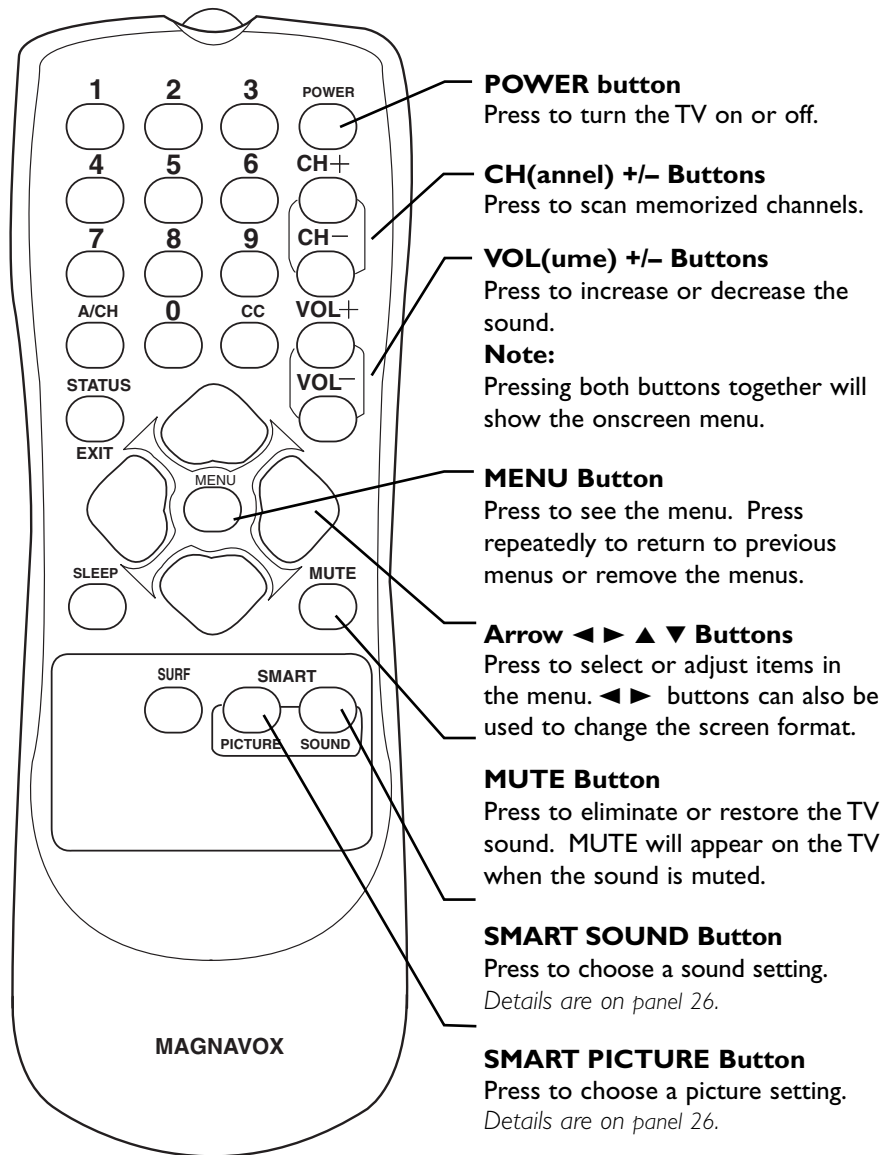



HOW TO USE THE LANGUAGE CONTROL

For our Spanish speaking TV owners an on-screen LANGUAGE option is present. With the LANGUAGE control you can set the TV's on-screen menu to be shown in either English or Spanish.

- 1** Press the **MENU** button on the remote to show the on-screen menu.
- 2** Press the **CURSOR UP ▲** or **DOWN ▼** buttons to scroll through the on-screen menu until the word **INSTALL** is highlighted.
- 3** Press the **CURSOR RIGHT ►** button to display the **INSTALL** menu features.
- 4** Press **CURSOR UP ▲** or **DOWN ▼** buttons to scroll the Install features until the word **LANGUAGE** is highlighted.
- 5** Press the **CURSOR RIGHT ►** button repeatedly to select **ENGLISH** or **ESPAÑOL** (Spanish).
- 6** When finished, press the **STATUS /EXIT** button to remove the menu from the TV's screen.

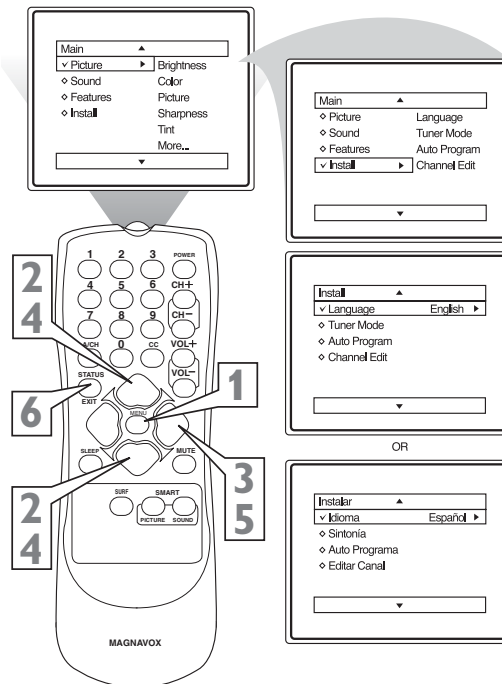

HELPFUL HINT

The Language control only makes the TV's on-screen MENU items appear in English or Spanish text. It does not change the other on-screen text features such as Closed Caption (CC) TV shows.

12

HOW TO USE THE TUNER MODE CONTROL

The **TUNER MODE** control allows you to change the TV's signal input to either **ANTENNA**, **CABLE**, or **AUTO** mode. It's important for the TV to know what type of signal that is connected. (From a Cable TV signal or a normal Antenna signal.) In the **AUTO** mode, when the **AUTO PROGRAM** feature is activated, the TV will automatically choose the correct mode.

- 1** Press the **MENU** button on the remote to show the on-screen menu.
- 2** Press the **CURSOR UP ▲** or **DOWN ▼** buttons to scroll through the on-screen menu until the word **INSTALL** is highlighted.
- 3** Press the **CURSOR RIGHT ►** button to display the **INSTALL** menu features.
- 4** Press **CURSOR UP ▲** or **DOWN ▼** buttons to scroll the Install features until the words **TUNER MODE** is highlighted.
- 5** Press the **CURSOR RIGHT ►** button to select either **ANTENNA**, **CABLE**, or **AUTO** mode.
- 6** When finished, press the **STATUS /EXIT** button to remove the on-screen menu from the TV's screen.

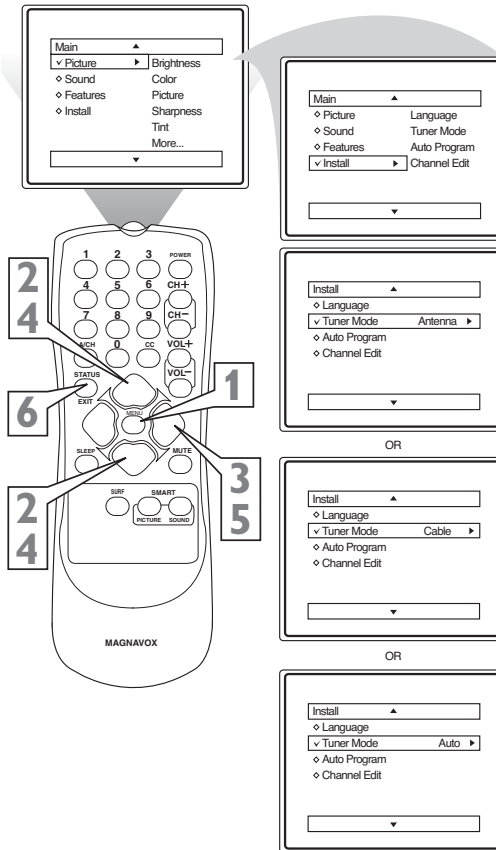

13

HOW TO AUTOMATICALLY PROGRAM TV

Your TV can automatically set itself for local area (or Cable TV) channels. This makes it easy for you to select only the TV stations in your area when the CHANNEL (+) or (-) buttons are pressed.

Note: Make sure the antenna or cable signal connection has been completed before AUTO PROGRAM is activated.

- 1** Press the **MENU** button on the remote to show the on-screen menu.
- 2** Press the **CURSOR UP ▲** or **DOWN ▼** buttons to scroll through the on-screen menu until the word **INSTALL** is highlighted.
- 3** Press the **CURSOR RIGHT ►** button to display the **INSTALL** menu features.
- 4** Press **CURSOR UP ▲** or **DOWN ▼** buttons to scroll the Install features until the words **AUTO PROGRAM** are highlighted.
- 5** Press the **CURSOR RIGHT ►** button to start the Auto Program scanning of channels. Auto Programming will store all available channels in the TV's memory then tune to the lowest available channel when done.
- 6** When finished, press the **STATUS/EXIT** button to remove the menu from the TV's screen.

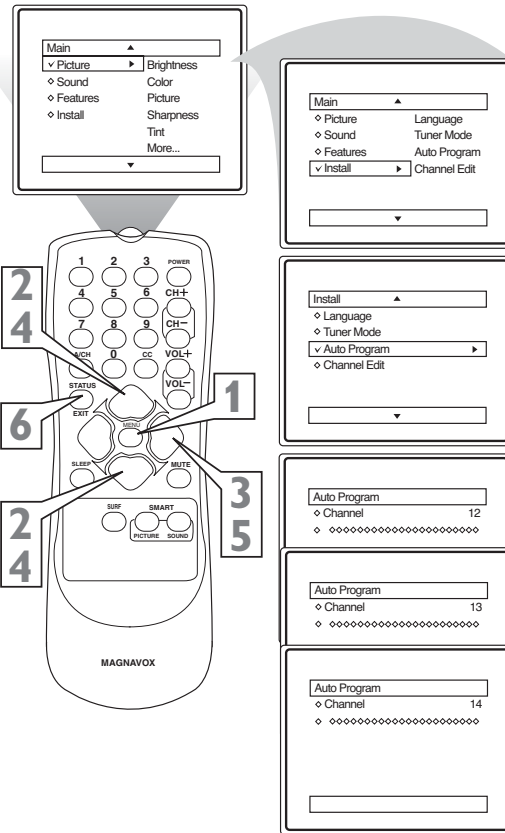

HELPFUL HINT

When CABLE is selected, channels 1-125 are available.
 When ANTENNA is selected, channels 2-69 are available.
 When AUTO is selected, the TV will automatically set itself to the correct mode based on the type of signal it detects when the AUTO PROGRAM feature is activated.

14

HOW TO ADD OR DELETE CHANNELS

Channel Edit makes it easy for you to ADD or DELETE channels from the list of channels stored in the TV's memory.

- 1 Press the **MENU** button on the remote to show the on-screen menu.
- 2 Press the **CURSOR UP ▲** or **DOWN ▼** buttons to scroll through the on-screen menu until the word **INSTALL** is highlighted.
- 3 Press the **CURSOR RIGHT ►** button to display the **INSTALL** menu features.
- 4 Press the **CURSOR UP ▲** or **DOWN ▼** buttons to scroll the Install features until the words **CHANNEL EDIT** are highlighted.
- 5 Press the **CURSOR RIGHT ►** button to display the **CHANNEL EDIT** options.
- 6 With the **CHANNEL EDIT** options displayed, and **CHANNEL NO.** highlighted; you can use the cursor buttons to scroll through all available channels that you wish to add (Skipped OFF), or delete (Skipped ON) from the TV's memory. You can also use the **NUMBERED** buttons to go directly to a specific numbered channel that you wish to add or skip. Or, you can also use the **CH +** or **CH -** to quickly scan the channels that have not been skipped.
- 7 Using the **CURSOR DOWN ▼** button, scroll the menu to highlight the word **SKIPPED**.
- 8 Now use the **CURSOR RIGHT ►** button to toggle between **ON** or **OFF**.
 If **ON** is selected the channel is skipped when scrolling channels with the **CH +** or **-** buttons. If **OFF** is selected the channel is not skipped when scrolling channels with the **CH +** or **-** buttons.
- 9 When finished, press the **STATUS /EXIT** button to remove the menu from the TV's screen.

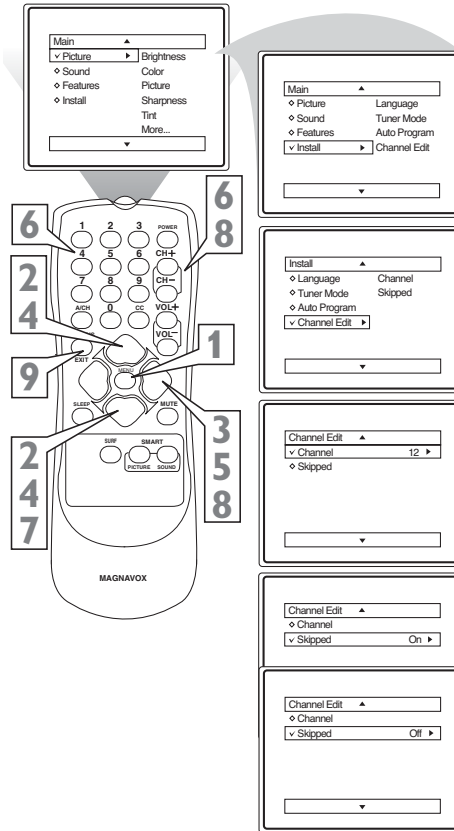

HELPFUL HINT

An "X" appearing in front of any channel will indicate that channel has skip on. When the **CH +** or **CH -** buttons are used, those channels will be skipped.

In order to get to the external input channels, such as **CVI, SVHS, AV, etc.**, you must use the **CURSOR Right ►** or **CURSOR LEFT ◀** buttons.

15 HOW TO USE THE PICTURE ADJUSTMENT CONTROLS

To adjust your TV picture controls, select a channel and use the Picture Menu Controls listed below:

- 1 Brightness:** Press the **CURSOR RIGHT ►** or **LEFT ◀** buttons until the darkest parts of the picture are as bright as you prefer.
- 2 Color:** Press the **CURSOR RIGHT ►** or **LEFT ◀** buttons to add or eliminate color.
- 3 Picture:** Press the **CURSOR RIGHT ►** or **LEFT ◀** buttons until lightest parts of the picture show good detail.
- 4 Sharpness:** Press the **CURSOR RIGHT ►** or **LEFT ◀** buttons to improve detail in the picture.
- 5 Tint:** Press the **CURSOR RIGHT ►** or **LEFT ◀** buttons to obtain natural skin tones.
- 6 Color Temp:** Press the **CURSOR RIGHT ►** or **LEFT ◀** buttons to select NORMAL, COOL, or WARM picture preferences. (NORMAL will keep the whites, white; COOL will make the whites, bluish; and WARM will make the whites, reddish.)
- 7 NR:** Press the **CURSOR RIGHT ►** or **LEFT ◀** buttons to turn ON or OFF. Noise Reduction helps to eliminate "noise" from the picture.

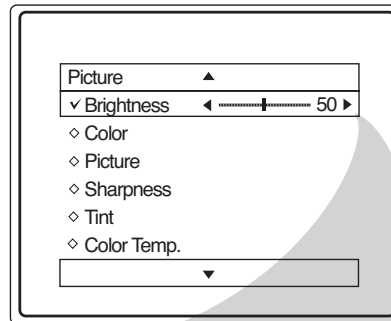

✓ Brightness ◀—————|————▶ 65 ▶

✓ Color ◀—————|————▶ 50 ▶

✓ Picture ◀—————|————▶ 50 ▶

✓ Sharpness ◀—————|————▶ 7 ▶

✓ Tint ◀—————|————▶ 0 ▶

✓ Color Temp. Normal
Warm
or
Cool

✓ NR On
Off

16 HOW TO USE THE SOUND ADJUSTMENT CONTROLS

To adjust your TV sound, select and use the Sound Menu Controls listed below:

- 1 **Treble Boost:** Press the ► or ◀ buttons to turn the control On or Off. When On, the control will enhance the high frequency sounds.
- 2 **Bass Boost:** Press the ► or ◀ buttons to turn the control On or Off. When On, the control will enhance the low frequency sounds.
- 3 **Balance:** Press the ► or ◀ buttons to adjust the level of sound coming from the left and right speakers.
- 4 **AVL:** (Auto Volume Leveler) Press the ► or ◀ buttons to turn the control On or Off. When On, AVL will level out the sound being heard when sudden changes in volume occur during commercial breaks or channel changes.
- 5 **Sound:** Press the ► or ◀ buttons to select between Stereo or Mono settings. Note: If Stereo is not present on a selected show and the TV is placed in the Stereo mode, the sound coming from the TV will remain in the Mono mode.

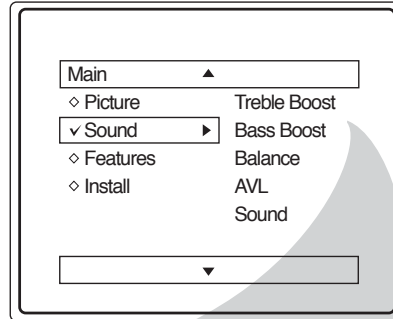

✓ Treble Boost ◀ ———|———— 50 ▶

✓ Bass Boost ◀ ———|———— 50 ▶

✓ Balance ◀ L ———|———— R ▶

✓ AVL On
or Off

✓ Sound Mono
or Stereo

17

HOW TO USE THE FORMAT CONTROL

Many times while watching movies from a DVD player the image is shown in "letter box" format. This is the format that is shown in movie theaters. When shown on a TV screen, the image will have areas of black on top and bottom of the screen.

1 Press the **CURSOR UP ▲** or **CURSOR DOWN ▼** buttons to select one of the two options 4:3 or Expand 4:3.

4:3 - Standard format for the TV.
Expand 4:3 - Enlarges the picture to fill out the entire screen area, eliminating the "letter box" effect.

2 When finished, press the **STATUS/EXIT** button to remove the menu from the TV's screen.

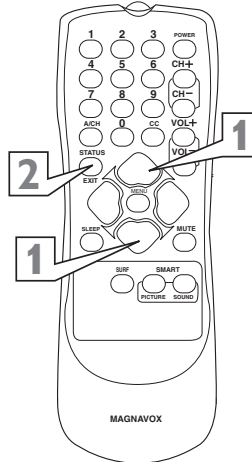

4:3



Expand 4:3



ALTERNATE CHANNEL

Your remote control has an Alternate Channel button that allows you to toggle between the current and previous button. For instance, if you are watching two games on TV, you can enter the channel numbers once and flip between the two channels with the touch of only one button.

After entering the two channels numbers, so that one is the last viewed channel and the other is the current channel, follow the step below.

1 Press the **A/CH** button on the remote control. The channels will toggle between the current channel and the last viewed channel.

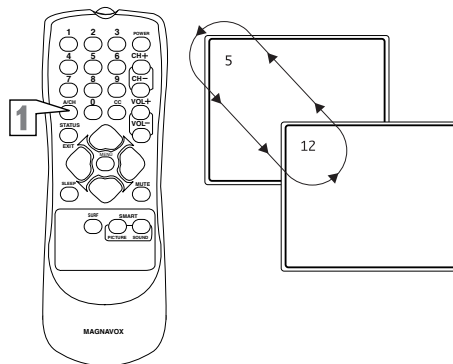

The Smartlock™ feature is an integrated circuit that receives and processes data sent by broadcasters, or other program providers, that contain program content advisories. When programmed by the viewer, a TV with Smartlock™ can respond to the content advisories and block program content that may be found objectionable (such as offensive language, violence, sexual situations, etc.). This is a great feature to censor the type of viewing children may watch.

Smartlock™ offers various BLOCKING controls from which to choose:

Access Code - An Access Code must be set to prevent children from unblocking questionable or censored programming set by their parents.

Channel Block - After an access code has been programmed, you can block individual channels including the A/V inputs.

Clear All - Allows you clear all channels being blocked from your viewing set with the Channel Block Control.

Block All - Allows you to block ALL channels and A/V inputs at one time.

Movie Ratings - Certain blocking options exist which will block programming based on ratings patterned by the Motion Pictures Association of America.

TV Ratings - Just like the Movie Ratings, programs can be blocked from viewing using standard TV ratings set by TV broadcasters.

MOVIE RATINGS

G: General Audience - All ages admitted. Most parents would find this program suitable for all ages.

PG: Parental Guidance Suggested - This programming contains material that parents may find unsuitable for younger children.

PG-13: Parents Strongly Cautioned - This programming contains material that parents may find unsuitable for children under the age of 13.

MOVIE RATINGS Continued

R: Restricted - This is programming is specifically designed for adults. Anyone under the age of 17 should only view this programming with an accompanying parent or adult guardian.

NC-17: No one under the age of 17 will be admitted. - This type of programming should be viewed by adults only.

X: Adults Only - This type of programming contains one or more of the following: very graphic violence, very graphic and explicit or indecent sexual acts, very coarse and intensely suggestive language.

TV RATINGS

TV-Y -- Designed for a very young audience, including children ages 2-6.

TV-Y7 -- It may be appropriate for children age 7 and above who have acquired the development skills needed to distinguish between make-believe and reality.

TV-G -- Suitable for most audiences, this type of programming contains little or no violence, no strong language, and little or no sexual dialogue or situations.

TV-PG -- This program contains material that parents may find unsuitable for younger children. Could contain Moderate violence (V), some sexual situations (S), infrequent coarse language (L), or some suggestive dialogue (D).

TV-14 -- This program contains some material that many parents would find unsuitable for children under 14 years of age. This type of programming contains one or more of the following: intense violence (V), intense sexual situations (S), strong coarse language (L), or intensely suggestive dialogue (D).

TV-MA -- This program is specifically designed to be viewed by adults and therefore may be unsuitable for children under 17. This type of programming contains one or more of the following: graphic violence (V), explicit sexual situations (S), or crude indecent language (L).

19

SETTING UP A SMARTLOCK™ ACCESS CODE

Over the next few panels you'll learn how to block channels and get a better understanding of the rating terms for certain programming.

First, let's start by learning how to set a personal access code:

- 1** Press the **MENU** button on the remote to show the on-screen menu.
- 2** Press the **CURSOR UP ▲** or **DOWN ▼** buttons until the word **FEATURES** is highlighted.
- 3** Press the **CURSOR RIGHT ►** button to display the **FEATURES** menu options.
- 4** Press the **CURSOR UP ▲** or **DOWN ▼** buttons until the words **Smartlock™** are highlighted.
- 5** Press the **CURSOR RIGHT ►** button. The screen will read, "ACCESS CODE - - - -"
- 6** Using the **NUMBERED** buttons, enter **0, 7, 1, 1**. "XXXX" appears on the Access Code screen as you press the numbered buttons. "INCORRECT CODE" will appear on the screen, and you will need to enter **0, 7, 1, 1** again.
- 7** The screen will ask you to enter a "New Code." Enter a "new" **4** digit code using the **NUMBERED** buttons. The screen will then ask you to **CONFIRM** the code you just entered. Enter your new code again. "XXXX" will appear when you enter your new code and then display the Smartlock™ menu options.

Proceed to the next panel to learn more...

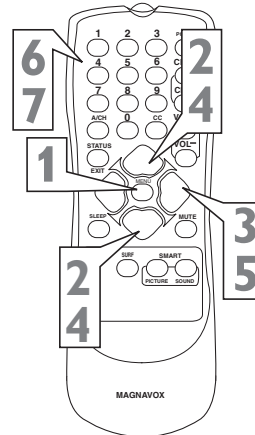
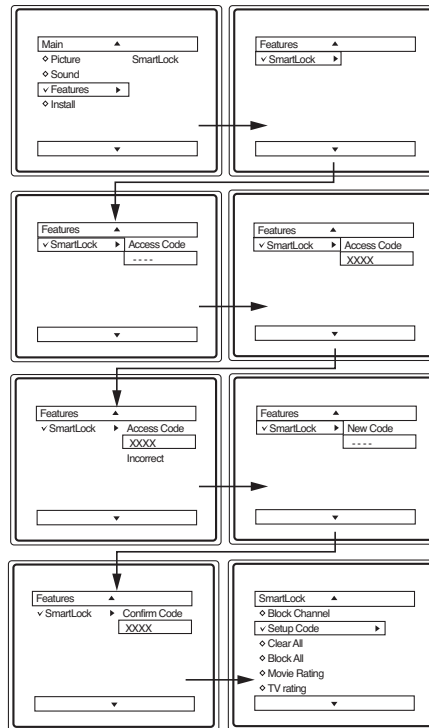

20

HOW TO BLOCK CHANNELS

After your personal access code has been set (see previous page), you are now ready to select the channels or the A/V Inputs you want to block out or censor. Once you've entered your access code and the Smartlock™ features are displayed on the screen:

- 1 Press the CURSOR UP ▲ or DOWN ▼ buttons** until the words **BLOCK CHANNELS** are highlighted.
- 2 Press the CURSOR RIGHT ► button** to turn blocking ON or OFF for that channel. When ON is selected the channel will be blocked.
- 3 Press the CH + or CH - button** to select other channels you wish to block. Repeat step 2 to block the new channel.
- 4 When finished, press the STATUS/EXIT button** to remove the menu from the screen.

NOTE: If you ever forget your code, the 0, 7, 1, 1 code is the factory default and can be used to enter and create a new access code.

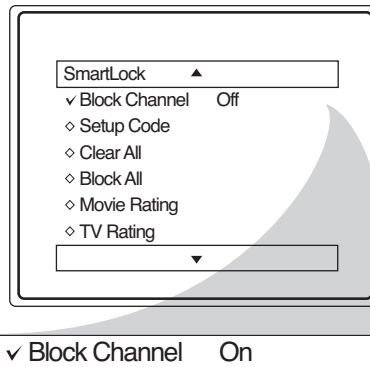

Block Channel On

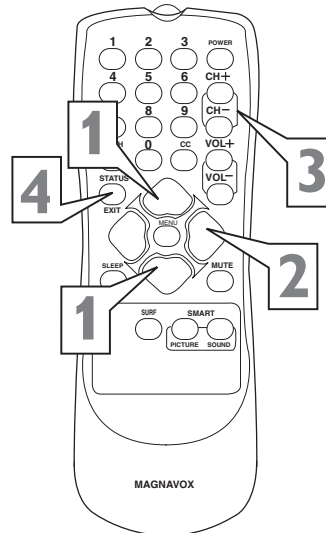
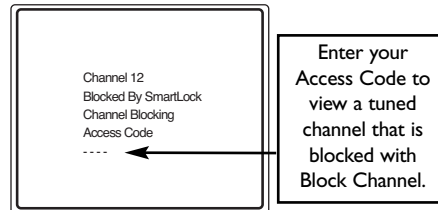

21 BLOCKING OR CLEARING ALL CHANNELS AT THE SAME TIME

After blocking specific channels there may come a time when you want to block or clear all the channels at the same time.

Once you've entered your access code and the Smartlock™ features are displayed on the screen:

1 Press the **CURSOR UP ▲** or **DOWN ▼** buttons to select either **CLEAR ALL** or **BLOCK ALL**.

2 If **CLEAR ALL** is selected, press the **CURSOR RIGHT ►** button to clear all blocked channels. All channels will be viewable.

If **BLOCK ALL** is selected, press the **CURSOR RIGHT ►** button to turn the control **ON** or **OFF**. When **ON** is selected, ALL available channels will be blocked from viewing.

3 When finished, press the **STATUS/EXIT** button to remove the menu from the screen.

NOTE: If you ever forget your code, the 0, 7, 1, 1 code is the factory default and can be used to enter and create a new access code.

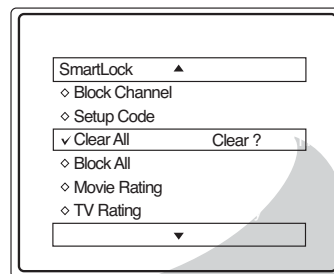

✓ Clear All Cleared

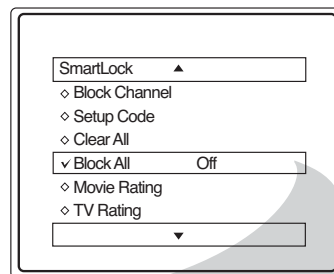

✓ Block All On

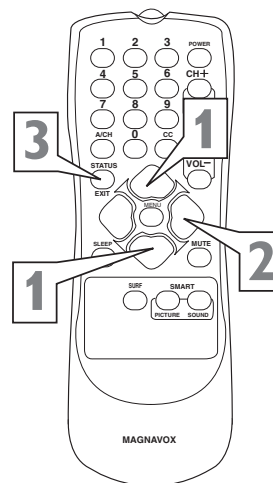

22 BLOCKING PROGRAMS BASED ON MOVIE RATINGS

The Smartlock™ feature can block programming based on the Movie Industry ratings.

Once you've entered your access code and the Smartlock™ features are displayed on the screen:

- 1 Press the **CURSOR UP ▲** or **DOWN ▼** buttons to highlight the words **MOVIE RATING**.
- 2 Press the **CURSOR RIGHT ►** button to display the **MOVIE RATING** options (G, PG, PG-13, R, NC-17, or X).
- 3 Press the **CURSOR UP ▲** or **DOWN ▼** buttons to highlight any of the Movie Rating options. When highlighted, all these options can be turned **ON** (which will allow blocking) or **OFF** (which will allow viewing).
- 4 Use the **CURSOR RIGHT ►** button on the remote to turn the rating option ON or OFF.

When a rating level is chosen to be blocked, any higher level rating will also be blocked from viewing. (i.e.: If "R" is selected to be blocked, NC-17 and X will automatically be blocked.)

NOTE: If you ever forget your code, the 0, 7, 1, 1 code is the factory default and can be used to enter and create a new access code.

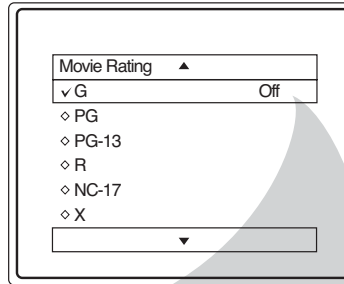
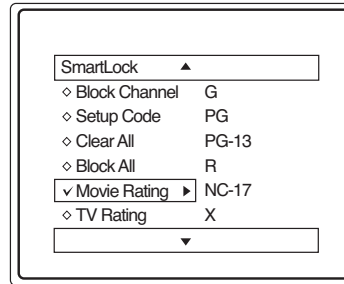

✓ G On

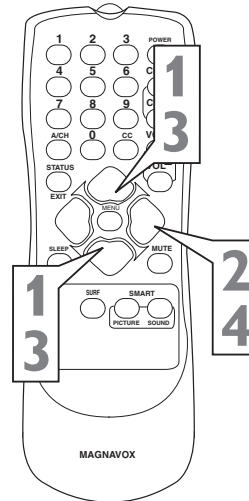

23

BLOCKING PROGRAMS BASED ON TV RATINGS

The Smartlock™ feature can block programming based on the TV Industry ratings.

Once you've entered your access code and the Smartlock™ features are displayed on the screen:

- 1 Press the **CURSOR UP ▲** or **DOWN ▼** buttons to highlight the words TV RATING.
- 2 Press the **CURSOR RIGHT ►** button to display the TV RATING options (TV-Y, TV-Y7, TV-G, TV-PG, TV-14, or TV-MA).
- 3 Press the **CURSOR UP ▲** or **DOWN ▼** buttons to highlight any of the TV Rating options. When highlighted, all these options can be turned **ON** (which will allow blocking) or **OFF** (which will allow viewing).

NOTE: Some TV RATING options also have sub-ratings. The ratings of TV-Y7, TV-PG, TV-14, TV-MA can be customized to block V (violence), FV (fantasy violence), S (sexual situations), L (coarse language), or D (suggestive dialogue).

- 4 Press the **CURSOR RIGHT ►** button on the remote to turn the TV-Y or TV-G rating ON or OFF. **Or,** press the **CURSOR RIGHT ►** button to enter the sub-menus for the TV-Y7, TV-PG, TV-14 or TV-MA ratings.
- 5 If the TV-Y7, TV-PG, TV-14 or TV-MA sub-menu is accessed, press the **CURSOR UP ▲** or **DOWN ▼** buttons to select one of the options (Block All, V, S, L, D, or FV).
- 6 Press the **CURSOR RIGHT ►** button on the remote to turn the option ON or OFF.

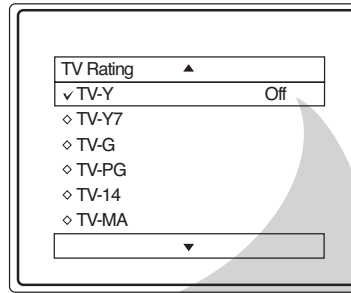

✓ TV-Y	On
✓ TV-Y7	► Block All, FV
✓ TV-G	Off
✓ TV-PG	► Block All, V, S, L, D
✓ TV-14	► Block All, V, S, L, D
✓ TV-MA	► Block All, V, S, L

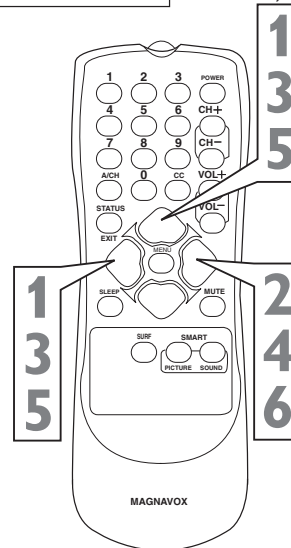

24

OTHER SMARTLOCK™ BLOCKING OPTIONS

Smartlock™ offers the viewer other blocking features as well. With these Blocking Options, the censoring can be turned ON or OFF.

Once Smartlock™ features are displayed on the screen:

1 Press the **CURSOR UP ▲** or **DOWN ▼** buttons until the words **BLOCKING OPTIONS** are highlighted.

2 Press the **CURSOR RIGHT ►** button to display the **Blocking Options (BLOCKING, UNRATED, or NO RATING)** menu.

BLOCKING: Might be called the “master switch” for Smartlock™. When ON, ALL blocking/censoring will take place. When OFF, ALL blocking is disabled.

UNRATED: ALL unrated programs based on the Movie Ratings or Parental (TV) Guidelines can be blocked if this feature is set to ON and the **BLOCKING** feature is set to OFF.

NO RATING: ALL programming with NO content advisory data can be blocked if set to ON and the **BLOCKING** feature is set to OFF.

3 Press the **CURSOR UP ▲** or **DOWN ▼** buttons to highlight the desired feature.

4 When highlighted, each feature can be turned **ON** or **OFF** using the **CURSOR RIGHT ►** or **LEFT ◀** buttons on the remote.

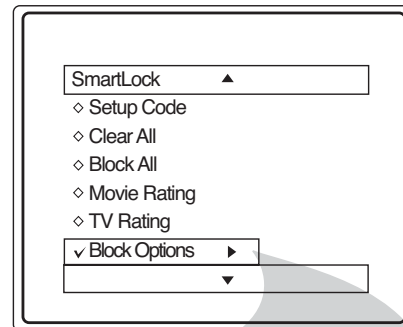

✓ Blocking On

✓ Unrated On

✓ No Rating On

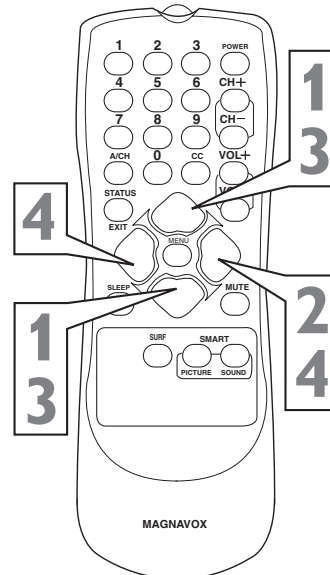

25 HOW TO USE THE CLOSED CAPTION CONTROLS

Closed Captioning (CC) allows you to read the voice content of television programs on the TV screen. Designed to help the hearing impaired, this feature uses on-screen "text boxes" to show dialogue and conversations while the TV program is in progress.

- 1 Press the CC button** on the remote to display the current Closed Caption setting.
- 2 Press the CC button repeatedly** to choose from the four Closed Caption options (CC Off, CC1, CC2, or CC Mute). CC Mute will activate Closed Captioning when the MUTE button is pressed.
- 3 When finished, press the STATUS /EXIT button** to remove the menu from the TV's screen.

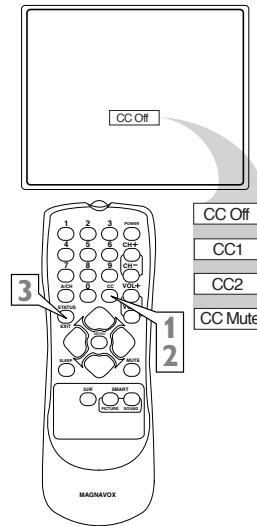

SETTING THE SLEPTIMER CONTROL

Your TV can be set to automatically turn itself off at a given amount of time.

- 1 Press the SLEEP button** on the remote control and the SLEEP OFF timer display will appear on the screen.
- 2 Press the SLEEP button repeatedly** to pick the amount of time (15, 30, 45, 60, 90, 120, 180, or 240 minutes) before the TV will turn itself off.

NOTE: An on-screen count down will appear during the last minute before the TV shuts itself off. If any button is pressed during the last minute of the countdown, the Sleptimer setting will be cancelled.

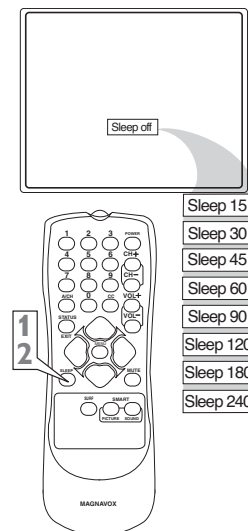

26

USING THE SMARTPICTURE™ CONTROL

Whether you're watching a movie or a sporting event, your TV has automatic video control settings matched for your current program source or content.

- 1 Press the SMART PICTURE button** on the remote control. The current Smart Picture setting will be displayed on the screen.
- 2 Press the SMART PICTURE button repeatedly** to select either PERSONAL, MOVIES, SPORTS, WEAK SIGNAL, or MULTIMEDIA picture settings.

NOTE: The way you choose to set the Picture Menu Controls will become your PERSONAL setting.

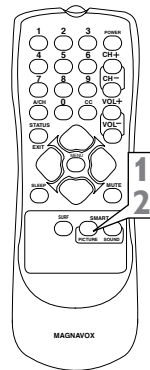
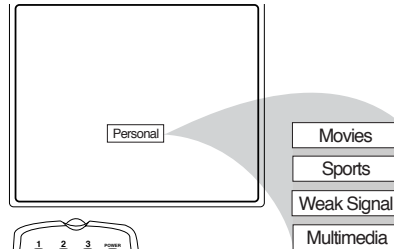

MOVIES - Preset picture options for watching Video Tapes, or DVDs.

SPORTS - Preset picture options for watching sporting events.

WEAK SIGNAL - Preset picture options for watching programs where the reception is not at its best.

MULTIMEDIA - Preset picture options for use with video gaming.

USING THE SMARTSOUND™ CONTROL

The Smart Sound feature allows the listener to select between four different factory set sound options.

- 1 Press the SMART SOUND button** on the remote control. The current Smart Sound setting will appear in the middle of the screen.
- 2 Press the SMART SOUND button repeatedly** to toggle between the four settings. (PERSONAL, VOICE, MUSIC, or THEATRE)

NOTE: The way you choose to set the Sound Menu Controls will become your PERSONAL setting.

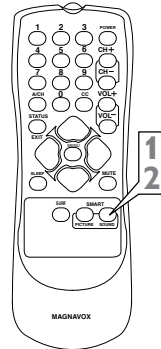
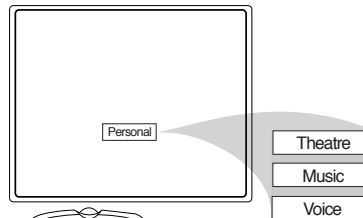

THEATRE - Preset sound options for watching movies.

MUSIC - Preset sound options for musical programming where there is little or no dialogue.

VOICE - Preset sound options for programming where heavy dialogue is present.

SmartSurf lets you set up to eight channels in a quick viewing list. Then, you can use the SURF button on the remote control to switch between different TV programs that currently interest you.

- 1** Press **CH +/-** or the Number buttons to select a channel to add to the SURF list.
- 2** Press **SURF** while the channel number appears.
- 3** Press **3** or **2** to add the channel to the SURF list or delete it from the list. An on-screen message will indicate whether you are adding or deleting the channel. Repeat steps 1 through 3 to add additional channels (up to eight) to the SURF list.

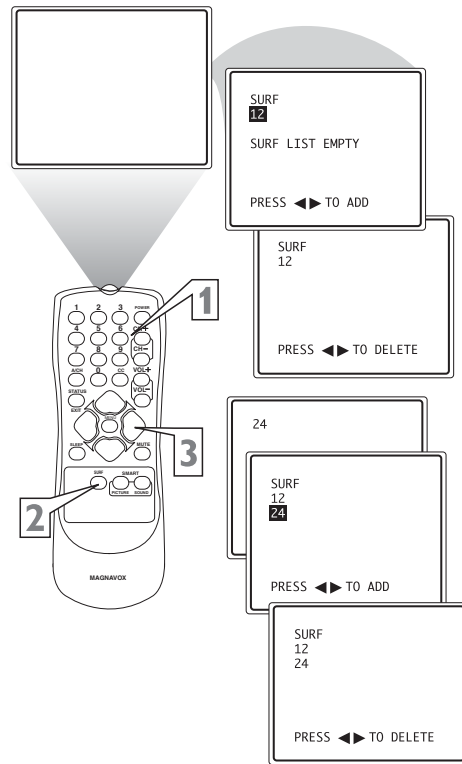

No Power

- Check the TV power cord. Unplug the TV, wait 10 seconds, then reinsert the plug into the outlet and push the POWER button again.
- Check that the outlet is not on a wall switch.
- Be sure the fuse is not blown on the AC power strip, if one is being used.

No Picture

- Check antenna connections. Are they properly secured to the TV's ANT 75Ω plug?
- Check the TUNER MODE control for the correct tuner setting.
- Try running the Auto Program feature to find all available channels.
- Press the CH+ or CH- buttons on the remote to make sure the correct signal source is selected (FRONT or Current Channel).

No Sound

- Check the VOLUME buttons.
- Check the MUTE button on the remote control.
- If you're attempting to hook up auxiliary equipment, check the audio jack connections located on the front of the TV.

Remote Does Not Work

- Check the batteries. If necessary, replace them with 2 AA Heavy Duty (Zinc Chloride) or Alkaline batteries.
- Clean the remote control and the remote control sensor window on the TV.
- Check the TV power cord. Unplug the TV, wait 10 seconds, then reinsert the plug into the outlet and push the POWER button again.
- Be sure the fuse is not blown on the AC power strip, if one is being used.
- Check to be sure the TV outlet is not on a wall switch.

TV Displays Wrong Channel or No Channels Above 13

- Repeat channel selection.
- Add the desired channel numbers (using the CHANNEL EDIT control) into the TV's memory.
- Check to be sure the TUNER MODES are set to the CABLE option and run the Auto Program feature to find all available channels.

WARNING Concerning Stationary Images on the TV Screen:

Do not leave stationary or letterbox images on screen for extended periods of time. This can cause uneven picture-tube aging.

Normal use of the TV should involve the showing of pictures that contain constantly moving and changing images that fill the screen. Be careful not to leave nonmoving images on screen for extended periods of time, or to display the same images on screen too frequently, because subtle ghost images can be left on the picture tubes. Sources of stationary images may be DVD disks, laser disks, video games, CD-i disks, videotapes, digital television boxes, broadcast channels, cable channels, satellite channels, and others. **Here are some examples of stationary images (this is not an all-inclusive list; you may encounter others in your viewing):**

- **DVD menus**—listings of DVD disk content
- **Letterbox black bars**—shown at the top and bottom of the TV screen when a wide screen (16:9) movie is viewed on a TV with standard (4:3) aspect ratio.
- **Video-game images and scoreboards**
- **Television station logos**—present a problem if they are bright and stationary; moving or low-contrast graphics are less likely to cause uneven aging of the picture tube
- **Stock-market tickers**—presented at the bottom of the TV screen
- **Shopping channel logos and pricing displays**—bright and shown constantly or repeatedly in the same location on the TV screen.

PLACEMENT OF THE TV

- To avoid cabinet warping, cabinet color changes, and increased chance of set failure, do not place the TV where temperatures can become excessively hot; for example, in direct sunlight or near a heating appliance.
- Be sure to allow a free flow of air to and from the perforated back cover of the set.

CLEANING

- To avoid possible shock hazard, be sure the TV is unplugged from the electrical outlet before cleaning.
- Regularly dust the TV with a dry, non-scratching duster to keep the TV clean.
- When cleaning the TV, take care not to scratch or damage the screen surface. Avoid wearing jewelry or using anything abrasive. Do not use household cleaners. Wipe the front screen with a clean cloth dampened with water. Use even, easy, vertical strokes when cleaning.
- Gently wipe the cabinet surfaces with a clean cloth or sponge dampened in a solution of cool, clear water and a mild soap or detergent. Use a clean, dry cloth to dry the wiped surfaces.
- Occasionally vacuum the ventilation holes or slots in the back cover of the set.
- Never use thinners, insecticide sprays, or other chemicals on or near the cabinet, as they might cause permanent marring of the cabinet finish.

Ninety (90) Days Labor & One (1) Year Parts & One (1) Year Display

MAGNAVOX warrants this product against defect in material or workmanship, subject to any conditions set forth as follows:

PROOF OF PURCHASE:

You must have proof of the date of purchase to receive warranted repair on the product. A sales receipt or other document showing the product and the date that you purchased the product as well as the authorized retailer included, is considered such proof.

COVERAGE:

(If this product is determined to be defective)

LABOR: For a period of ninety (90) days from the date of purchase, Magnavox will repair or replace the product, at its option, at no charge, or pay the labor charges to any Magnavox authorized service center. After the period of ninety (90) days, Magnavox will no longer be responsible for charges incurred.

PARTS: For a period of one (1) year, Magnavox will supply, at no charge, new or rebuilt replacement parts in exchange for defective parts. Magnavox authorized service centers will provide removal and installation of the parts under the specified labor warranty.

DISPLAY: For a period of one (1) year from the date of purchase, Magnavox will supply, at no charge, a new or rebuilt active display device in exchange for the defective display. Magnavox authorized service centers will provide removal and installation of the parts under the specified labor warranty. (PTV screens carry a thirty (30) day replacement warranty.)

EXCLUDED FROM WARRANTY COVERAGE

Your warranty does not cover:

- Labor charges for installation or setup of the product, adjustment of customer controls on the product, and installation or repair of antenna systems outside of the product.
- Product repair and/or part replacement because of improper installation, connections to improper voltage supply, abuse, neglect, misuse, accident, unauthorized repair or other cause not within the control of Magnavox.
- A product that requires modification or

adaptation to enable it to operate in any country other than the country for which it was designed, manufactured, approved and/or authorized, or repair of products damaged by these modifications.

- Damage occurring to product during shipping when improperly packaged or cost of associated packaging.
- Product lost in shipment and no signature verification of receipt can be provided.
- A product used for commercial or institutional purposes (including but not limited to rental purposes).
- Products sold AS IS or RENEWED.

TO OBTAIN WARRANTY SERVICE IN THE U.S.A., PUERTO RICO, OR U.S. VIRGIN ISLANDS...

Contact Magnavox Customer Care Center at:
1-800-705-2000

TO OBTAIN WARRANTY SERVICE IN CANADA...

1-800-661-6162 (French Speaking)
1-800-705-2000 (English or Spanish Speaking)

REPAIR OR REPLACEMENT AS PROVIDED UNDER THIS WARRANTY IS THE EXCLUSIVE REMEDY FOR THE CONSUMER. MAGNAVOX SHALL NOT BE LIABLE FOR ANY INCIDENTAL OR CONSEQUENTIAL DAMAGES FOR BREACH OF ANY EXPRESS OR IMPLIED WARRANTY ON THIS PRODUCT. EXCEPT TO THE EXTENT PROHIBITED BY APPLICABLE LAW, ANY IMPLIED WARRANTY OF MERCHANTABILITY OR FITNESS FOR A PARTICULAR PURPOSE ON THIS PRODUCT IS LIMITED IN DURATION TO THE DURATION OF THIS WARRANTY.

Some states do not allow the exclusions or limitation of incidental or consequential damages, or allow limitations on how long an implied warranty lasts, so the above limitations or exclusions may not apply to you. In addition, if you enter into a service contract agreement with the MAGNAVOX partnership within ninety (90) days of the date of sale, the limitation on how long an implied warranty lasts does not apply.

This warranty gives you specific legal rights. You may have other rights which vary from state/province to state/province.

Magnavox, P.O. Box 520890, Miami, FL 33152 (402) 536-4171

Free Manuals Download Website

<http://myh66.com>

<http://usermanuals.us>

<http://www.somanuals.com>

<http://www.4manuals.cc>

<http://www.manual-lib.com>

<http://www.404manual.com>

<http://www.luxmanual.com>

<http://aubethermostatmanual.com>

Golf course search by state

<http://golfingnear.com>

Email search by domain

<http://emailbydomain.com>

Auto manuals search

<http://auto.somanuals.com>

TV manuals search

<http://tv.somanuals.com>