

OWNER'S MANUAL

MAGNAVOX

Smart. Very smart.®

27MDTR10S

COLOR TV WITH BUILT-IN VCR/DVD PLAYER



NEED HELP? CALL US!

MAGNAVOX REPRESENTATIVES ARE READY TO HELP YOU WITH ANY QUESTIONS ABOUT YOUR NEW PRODUCT. WE CAN GUIDE YOU THROUGH CONNECTIONS, FIRST-TIME SETUP, AND ANY OF THE FEATURES. WE WANT YOU TO START ENJOYING YOUR NEW PRODUCT RIGHT AWAY.

**CALL US BEFORE YOU CONSIDER RETURNING THE PRODUCT.
1-800-705-2000**

OR VISIT US ON THE WEB AT WWW.MAGNAVOX.COM



IMPORTANT!
RETURN YOUR WARRANTY REGISTRATION CARD WITHIN 10 DAYS.
SEE WHY INSIDE.

Return your Warranty Registration card today to ensure you receive all the benefits you're entitled to.

Once your MAGNAVOX purchase is registered, you're eligible to receive all the privileges of owning a MAGNAVOX product. So complete and return the Warranty Registration Card enclosed with your purchase at once. And take advantage of these important benefits.

Warranty Verification	Owner Confirmation	Model Registration
Registering your product within 10 days confirms your right to maximum protection under the terms and conditions of your MAGNAVOX warranty.	Your completed Warranty Registration Card serves as verification of ownership in the event of product theft or loss.	Returning your Warranty Registration Card right away guarantees you'll receive all the information and special offers which you qualify for as the owner of your model.

Congratulations on your purchase, and welcome to the "family!"



Dear MAGNAVOX product owner:

Thank you for your confidence in MAGNAVOX. You've selected one of the best-built, best-backed products available today. And we'll do everything in our power to keep you happy with your purchase for many years to come.

As a member of the MAGNAVOX "family," you're entitled to protection by one of the most comprehensive warranties and outstanding service networks in the industry.

What's more, your purchase guarantees you'll receive all the information and special offers for which you qualify, plus easy access to accessories from our convenient home shopping network.

And most importantly you can count on our uncompromising commitment to your total satisfaction.

All of this is our way of saying welcome-and thanks for investing in a MAGNAVOX product.

P.S. Remember, to get the most from your MAGNAVOX product, you must return your Warranty Registration Card within 10 days. So please mail it to us right now!

Know these **safety** symbols



⚡ This "bolt of lightning" indicates uninsulated material within your unit may cause an electrical shock. For the safety of everyone in your household, please do not remove product covering.

! The "exclamation point" calls attention to features for which you should read the enclosed literature closely to prevent operating and maintenance problems.

WARNING: TO PREVENT FIRE OR SHOCK HAZARD, DO NOT EXPOSE THIS EQUIPMENT TO RAIN OR MOISTURE.

CAUTION: To prevent electric shock, match wide blade of plug to wide slot, fully insert.

ATTENTION: Pour éviter les choc électriques, introduire la lame la plus large de la fiche dans la borne correspondante de la prise et pousser jusqu'au fond.

For Customer Use

Enter below the Serial No. which is located on the rear of the cabinet. Retain this information for future reference.

Model No. _____
Serial No. _____

Visit our World Wide Web Site at <http://www.magnavox.com>

Safety and General Information 3

Safety Precautions

Warning: To prevent fire or shock hazard, do not expose this equipment to rain or moisture.

Federal Communications Commission (FCC) Warning: Any unauthorized changes or modifications to this equipment void the user's authority to operate it.

Laser Safety: This unit employs a laser. Only a qualified service person should remove the cover or attempt to service this device, due to possible eye injury.

CAUTION: USE OF CONTROLS OR ADJUSTMENTS OR PERFORMANCE OF PROCEDURES OTHER THAN THOSE SPECIFIED HEREIN MAY RESULT IN HAZARDOUS RADIATION EXPOSURE.

CAUTION: VISIBLE AND INVISIBLE LASER RADIATION WHEN OPEN AND INTERLOCK DEFEATED. DO NOT STARE INTO BEAM. THE BEAM IS LOCATED INSIDE, NEAR THE DECK MECHANISM.

Special Information for Canadian Users: This Class B digital apparatus complies with Canadian ICES-003. Cet appareil numérique de la classe B est conforme à la norme NMB-003 du Canada.

Radio/TV Interference: This equipment has been tested and found to comply with the limits for a Class B digital device, pursuant to Part 15 of the FCC Rules. These limits are designed to provide reasonable protection against harmful interference in a residential installation. This equipment generates, uses, and can radiate radio frequency energy and, if not installed and used in accordance with the instructions, may cause harmful interference to radio communications. However, there is no guarantee that interference will not occur in a particular installation. If this equipment does cause harmful interference to radio or television reception, which can be determined by turning the equipment off and on, the user is encouraged to try to correct the interference by one or more of the following measures:

- 1) Reorient or relocate the receiving antenna.
- 2) Increase the separation between the equipment and the receiver.
- 3) Connect the equipment into an outlet on a circuit different from that to which the receiver is connected.
- 4) Consult the dealer or an experienced radio/TV technician for help.

Copyright Protection: Unauthorized copying, broadcasting, public performance and lending of Discs are prohibited. This product incorporates copyright protection technology that is protected by method claims of certain U.S. patents and other intellectual property rights owned by Macrovision Corporation and other rights owners. Use of this copyright protection technology must be authorized by Macrovision Corporation and is intended for home and other limited viewing uses only unless otherwise authorized by Macrovision Corporation. Reverse engineering or disassembly is prohibited.

Note to the Cable TV System Installer: This reminder calls the Cable TV system installer's attention to Article 820-40 of the National Electrical Code, which provides guidelines for proper grounding – in particular, specifying that the cable ground shall be connected to the grounding system of the building, as close to the point of cable entry as possible.

Declaration of Conformity

Model Number: 27MDTR10S
Trade Name: Magnavox
Responsible Party: Philips Consumer Electronics
P.O. Box 14810
Knoxville, TN 37914-1810
(865) 521-4316



As an ENERGY STAR® Partner, Magnavox has determined that this product meets the ENERGY STAR® guidelines for energy efficiency. ENERGY STAR® is a U.S. registered mark. Using products with the ENERGY STAR® label can save energy. Saving energy reduces air pollution and lowers utility bills.

Manufactured under license from Dolby Laboratories. "Dolby" and the double-D symbol are trademarks of Dolby Laboratories. Copyright 2002 Magnavox. All rights reserved.

4 Table of Contents

General Information

Safety and General Information	3
Table of Contents	4
Introduction	5
Playable Discs and Videotapes	6

First-Time Setup and Use

Before Using the TV/VCR/DVD	7
Hooking Up the TV/VCR/DVD	8-9
Optional Connections	10
First-Time Setup, Watching TV	11
Playing a Videotape	12
Playing a Disc	13

Description of Controls

Remote Control Buttons	14-15
Front Panel	16
Rear Panel	17

TV Settings

Menu Language, Resetting TV Channels	18
Adding/Deleting Channels	19
Setting the Clock	20-22
Daylight-Savings Time	23
Status Displays, Picture Controls	24

Recording

Recording (Videotapes)	25
One-Touch Recording (Videotapes)	26
Rerecording (Tape Duplication)	27
Timer Recording (Videotapes)	28-30
Timer Recording Auto Return	31

Videotape Features

Repeat Play (Videotapes)	32
Rental Playback (Videotapes)	33
Zero Return (Videotapes)	34
Time Search (Videotapes)	35
Index Search (Videotapes)	36
Videotape Playback Features	37
Automatic Operation Features (Videotapes)	38

Additional TV Features

Closed Caption (TV/VCR)	39
Sleep Timer	40
Setting V-Chip (TV)	41-44
Multi-Channel Television Sound	45-47

Disc Features

Disc Menus, Title Menus (DVDs)	48
Fast Forward/Reverse Search (Discs)	49
Specific Title/Chapter Playback (DVDs)	50
Specific Time Playback (Discs)	51
Specific Track Playback (Audio CDs)	52
Paused/Step-by-Step Playback, Resume (Discs)	53
Repeat, A-B Repeat (Discs)	54
Markers (Discs)	55
Subtitles, Camera Angles (DVDs)	56
Slow Motion, Zoom (DVDs)	57
Parental Controls Password (DVDs)	58
Parental Controls Levels (DVDs)	59
Audio Language, Stereo Sound Mode (Discs)	60
Random Playback, Programs (Audio CDs)	61
MP3 Playback	62
MP3 Display Information, Track Selection	63
Random MP3 Playback, MP3 Programs	64

DVD Player Setup Features

Audio Settings (DVD mode)	65
Language Settings (DVDs)	66-67
Display Settings	68
On-Screen Displays (Discs)	69
Black Level Settings, TruSurround Setting (Discs)	70

Information You May Need

Glossary	71
Helpful Hints	72-73
Specifications	74
Limited Warranty	75
Index	76

Welcome to your TV/VCR/DVD owner's manual.

This manual describes the 27MDTR10S and explains how to use all its features.

Features - TV/VCR

- Automatic Channel Setup
- Automatic Head Cleaner
- Automatic Tracking Adjustment
- Closed Caption
- Daylight-Savings Time
- English, Spanish, or French displays
- Forward/Reverse Searching; Still
- High Quality (HQ) System
- Index Search
- One-Touch Recording
- Real-Time Tape Counter
- Rental Playback
- Repeat Play
- Sleep Timer
- Timer Recording
- Time Search
- Zero Return

Features - Discs

- Audio Language choices*
 - Bit Rate display
 - Camera Angle*
 - Dolby Digital Sound*
 - Dynamic Range Control
 - Fast/Paused/Slow/Step-by-Step Playback
 - Markers
 - Parental Controls*
 - Program Playback (Audio CD, MP3)
 - Random Playback (Audio CD, MP3)
 - Repeat (A-B, Chapter, Title, Track, Disc)
 - Screen Saver
 - Search (Title/Chapter, Time, Track)
 - SRS TruSurround
 - Subtitles*
 - Zoom Playback
- * If available on the Disc

DVD Disc Menus...

Some explanations in this manual describe DVD Disc menus. DVD manufacturers set the menus, which vary among DVDs. All DVDs do not have menus. If the DVD has a menu, access it by pressing the DISC MENU button on the remote control.

Details are on page 48.

Setup Menus...

Some instructions explain how to use the setup menus of the TV/VCR/DVD. There are two setup menus: one for the TV/VCR features while the unit is in TV/VCR mode, and one for the Disc features while the unit is in DVD mode. Access the setup menus by pressing SETUP on the remote control.

While in TV/VCR mode, you can select only the TV/VCR SETUP menu.

In DVD mode, you can select both the TV/VCR SETUP menu and the SETUP menu for the unit's DVD Player. Press the SETUP button once to select the TV/VCR SETUP menu. Press SETUP twice to get to the DVD Player's SETUP menu.

Even if you set a DVD feature in the unit's SETUP menu, it will not be available if the current Disc does not include that feature.

Available Disc Features...



All features described in this manual are not available on every Disc. If the feature is not available on the Disc, you cannot use the TV/VCR/DVD to make it available.

A stop hand with a cross-X (as shown here) will appear in the top right corner of the screen if you try to access a feature that is not currently available.

6 Playable Discs and Videotapes

Playable Discs

The DVD Player of this TV/VCR/DVD will play many types of Discs, including Digital Video Discs (DVDs) and Audio Compact Discs (CDs). It will play MP3 files as well. To play a DVD, make sure it meets the requirements for Region Codes and Color Systems as described below. Discs that have the following logos will play on the DVD Player of this TV/VCR/DVD.



DVD: Prerecorded Digital Video Discs



CD-R: Compact Disc Recordable. CD-Rs can be recorded on only once.



Audio CDs



DVD-R: DVD Recordable. DVD-Rs can be recorded on only once.



MP3: Digital audio files recorded on a CD-R or CD-RW



DVD+RW: DVD Rewritable. DVD+RWs can be recorded on multiple times.



CD-RW: Compact Disc Rewritable. CD-RWs can be recorded on multiple times.

Region Codes

This TV/VCR/DVD has a Region One (1) DVD Player. DVDs must be labeled for ALL regions or for Region 1 in order to play on the unit. You cannot play DVDs that are labeled for other regions. Look for the symbols below on your DVDs. If these region symbols do not appear on your DVD, you cannot play the DVD in this TV/VCR/DVD.



The number inside the globe refers to a region of the world. Region 1 represents the United States, Canada, upper regions of North America, Bermuda, the U.S. Virgin Islands, and small regions near Australia.

A DVD labelled for a specific region can only play on DVD Players with the same region code.

Color Systems

DVDs are recorded in different color systems throughout the world. The most common color systems are NTSC (which is used primarily in the United States and North America), PAL, and SECAM.

The DVD Player of this unit uses NTSC, so DVDs you play must be recorded in the NTSC system. You cannot play DVDs recorded in other formats. The color system of the DVD may be listed on the DVD or on the Disc case.

Playable Videotapes

Magnavox recommends you use only videotapes that have the **VHS** mark. Other videotapes may have poor picture quality and cause excessive deposits on the video heads. The warranty may not cover such damage.

The VCR of this TV/VCR/DVD has a High Quality (HQ) system and is compatible with existing Video Home System (VHS) equipment.

Before Using the TV/VCR/DVD 7

Remote Control Battery Installation

- 1** Remove the battery compartment lid on the bottom of the remote control. Slide the lid down and off. Follow the direction of the arrow on the lid.
- 2** Place two AA batteries inside the battery compartment. Align the + and - ends as indicated.
- 3** Replace the battery compartment lid.

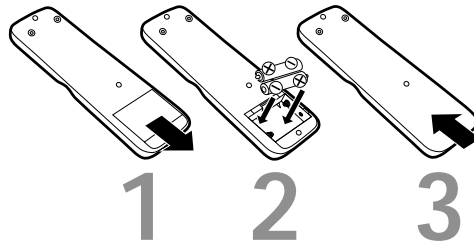

Battery Safety

Battery Usage CAUTION - To prevent battery leakage that may result in bodily injury, property damage, or damage to the unit:

- Install ALL batteries correctly, with the + and - markings on the battery aligned as indicated on the unit;
- Do not mix batteries, for example, old with new or carbon with alkaline; and
- Remove batteries when the unit will not be used for a long time.

Recording Prevention

Videotapes have record tabs to ensure you do not erase recordings accidentally.

- 1** To prevent accidental recording, break off the tab with a screwdriver.
- 2** To record again, cover the hole with cellophane tape.

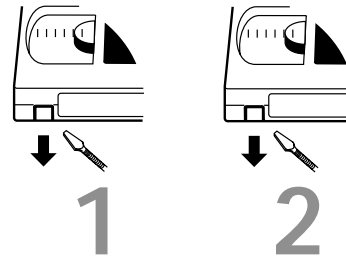

Using the Remote Control

- Point the remote control at the TV/VCR/DVD's remote sensor. *Details are on page 16.*
- Do not put objects between the remote control and the TV/VCR/DVD.

TV/VCR/DVD Maintenance

- Remove any light adhesive stick-on notes from the video cassette before putting the cassette in the TV/VCR/DVD. Removable labels can jam the TV/VCR/DVD.
- The TV/VCR/DVD requires periodic maintenance to maintain its excellent performance. This TV/VCR/DVD has an automatic head cleaning system. However, the video heads will eventually require cleaning or replacement. Only an authorized service center should perform this service.

Helpful Hint

- Your new product, its packaging, and this manual contain materials that can be recycled and reused. Specialized companies can recycle your product to increase the amount of reusable materials and to minimize the amount that needs to be properly disposed. Your product uses batteries that should not be thrown away when depleted but should be disposed of as small chemical waste. Please find out about the local regulations on disposal of your old product, batteries, manual, and packaging when you replace existing equipment.

8 Hooking Up the TV/VCR/DVD

1 Hook up your TV/VCR/DVD using one of the connections shown.

A Hooking Up Your TV/VCR/DVD with a Cable TV Signal or Outdoor Antenna

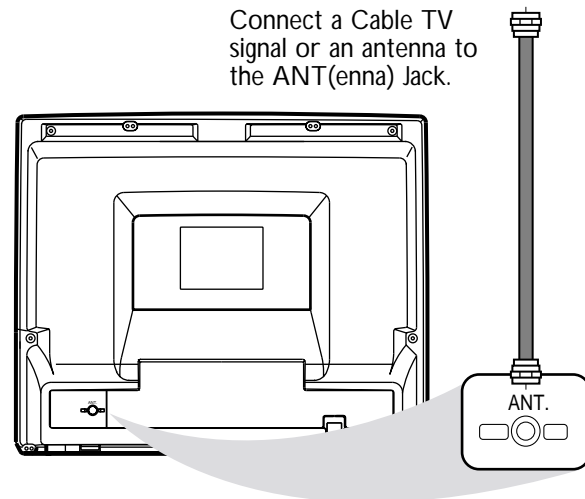

B Hooking Up Your TV/VCR/DVD with a Cable Box/Satellite Receiver

To view any channel, set the TV/VCR/DVD to the output channel (channel 03 or 04) of the Cable Box/Satellite Receiver. Then, select channels at the Cable Box/Satellite Receiver.

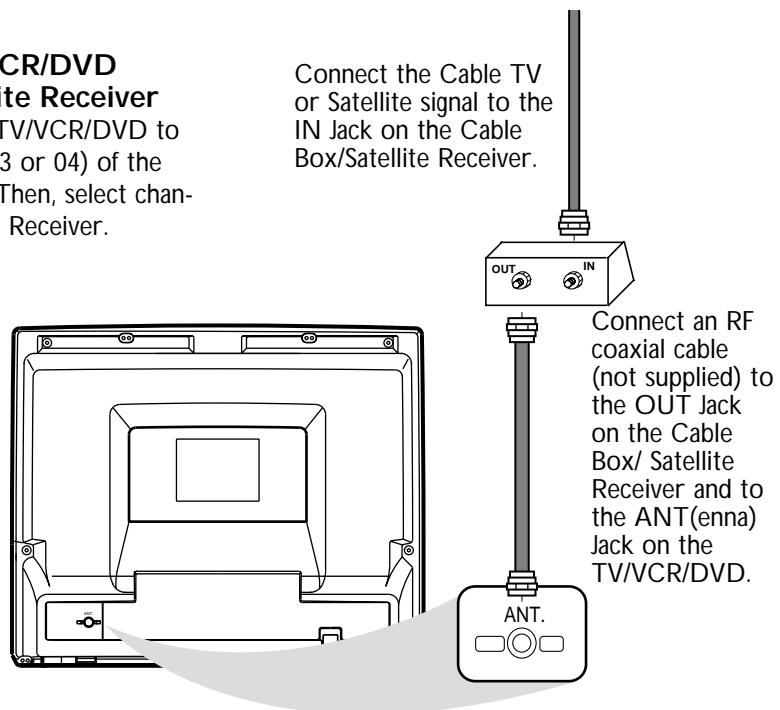

Your Cable Box/Satellite Receiver may have Audio and Video Out jacks instead of the single Antenna Out jack (RF coaxial or 75 ohm) shown here. If so, connect Audio and Video cables to the Audio/Video Out jacks of the Cable Box/Satellite Receiver and to the AUDIO/VIDEO In jacks on the front of the TV/VCR/DVD. Set the TV/VCR/DVD to AUX (channel 00), not channel 3 or 4. Select channels you want to watch or record at the Cable Box/Satellite Receiver as usual, leaving the TV/VCR/DVD on AUX.

Hooking Up the TV/VCR/DVD (cont'd) 9

C Hooking Up Your TV/VCR/DVD with an Indoor Antenna

To install an indoor antenna or "rabbit ears" (not supplied), connect the antenna wire to the ANT(enna) Jack on the back of the TV/VCR/DVD as shown. Extend the antenna and adjust its length, direction, and angle for the clearest picture.

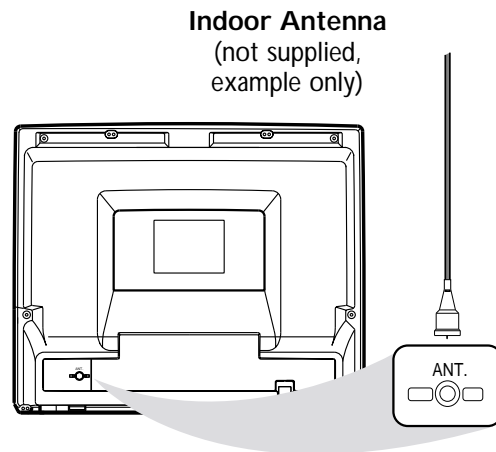

D Hooking Up Your TV/VCR/DVD to Another Video Source (VCR, DVD Player, Camcorder, etc.)

You may need this connection if you want to play Discs or tapes on other equipment but watch them on the TV/VCR/DVD. Select channel 00 (AUX) at the TV/VCR/DVD when viewing materials playing on other equipment. *More details are on page 27.*

Audio and video cables are not supplied.

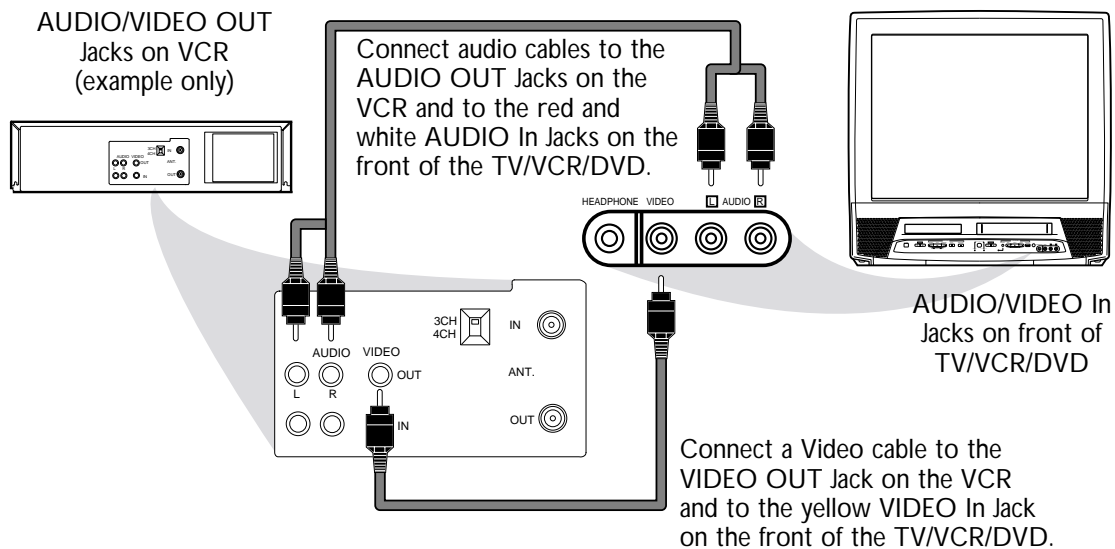

2 When all other connections are complete, plug in the TV/VCR/DVD's power cord.

3 Before you turn on the TV/VCR/DVD, go to page 11.

10 Optional Connections

Analog Stereo Hookups

If you want to hear the TV/VCR/DVD sound through a stereo instead, make this connection.

- 1 **Complete the antenna/Cable TV connections.** Details are on pages eight-nine.
- 2 **Connect red and white audio cables to the red and white AUDIO OUT jacks on the back of the TV/VCR/DVD and to the AUDIO IN jacks on the stereo.** Match the cable colors to the jack colors. Audio cables are not supplied. Use RCA-style cables.
- 3 **Set your stereo to Auxiliary In.** See your stereo owner's manual for details.

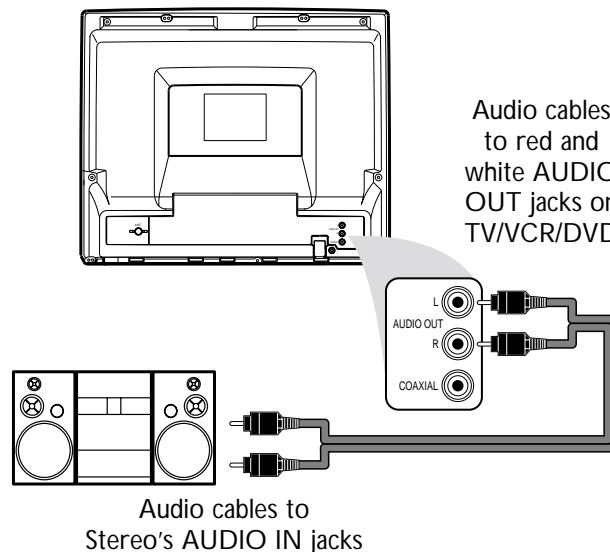

Digital Stereo Hookups

You can connect the TV/VCR/DVD to a Stereo that has a Digital Coaxial In jack. Use this hookup if you want to hear the TV/VCR/DVD sound through the Stereo instead. Use these connections for a Dolby Digital-compatible Stereo or for a Receiver that has a Mini-Disc or Digital Audio Tape deck.

- 1 **Connect the antenna/Cable TV signal.** Details are on pages eight-nine.
- 2 **Connect a digital audio coaxial cable (not supplied) to the orange COAXIAL jack on the TV/VCR/DVD.** Also connect the cable to the Stereo's COAXIAL DIGITAL AUDIO IN jack.
- 3 **If the Stereo is Dolby Digital-compatible, set DOLBY DIGITAL to ON.** If the Stereo is not Dolby Digital-compatible or if you connected to a Mini-Disc or Digital Audio Tape Deck, set DOLBY DIGITAL to OFF. Details are on page 65.
An incorrect setting causes noise distortion and damages speakers.
To see if your Stereo has Dolby Digital, look for a Dolby Digital logo on your Stereo. Or, refer to the Stereo owner's manual.

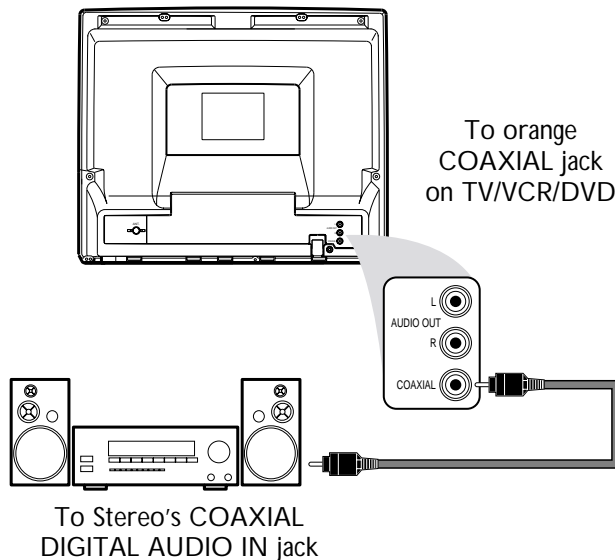

Helpful Hints

- You cannot use a Mini-Disc or Digital Audio Tape deck to copy 5.1 channel Dolby Digital surround sound Discs.
- Discs recorded in Dolby Digital should show this on the Disc or case. If the Disc is not recorded in 5.1 channel Dolby Digital surround sound, you will not hear multi-channel sound even if you use the Digital Stereo hookup.

12 Playing a Videotape

Follow these steps to simply play a videotape. *Videotape playback options are on pages 32-38.*

- 1** Insert a videotape in the cassette compartment of the TV/VCR/DVD. The power will come on. If the tape's record tab is missing, playback should start automatically.
- 2** If playback does not start automatically, press **PLAY ►** to start playback.
- 3** Press **STOP ■** to stop playback.
- 4** Press **◀◀ / ◀** to rewind the tape.
- 5** When the tape finishes rewinding, press **STOP/EJECT** on the front of the TV/VCR/DVD to remove the tape.

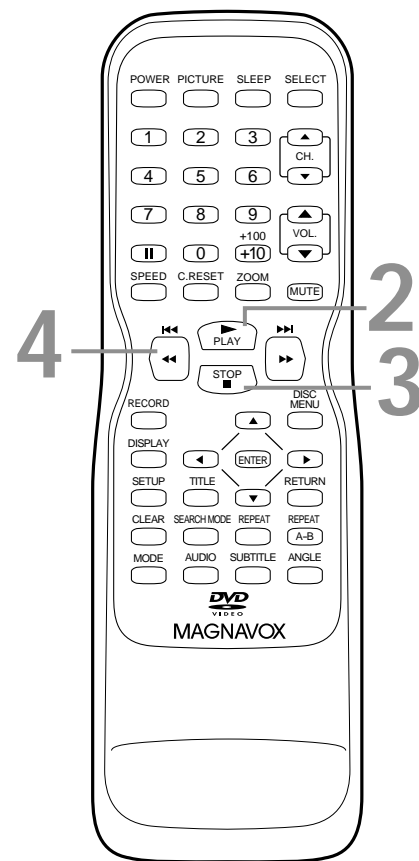

Helpful Hints

- If the tape you want to play is already in the TV/VCR/DVD, turn on the TV/VCR/DVD power. Press **SELECT** to make sure it is in TV/VCR mode, then press **PLAY ►**.
- When you play an S-VHS format tape, you cannot get the high resolution that would be available on an S-VHS VCR. Noise lines (black and white streaks) may appear in the picture.

Playing a Disc 13

Before you begin, turn on the power of other equipment connected to the TV/VCR/DVD. Set a stereo (if applicable) to the correct sound source or channel. *Details are on page 10.*

- 1 Press POWER to turn on the TV/VCR/DVD.**
The unit will be in TV/VCR mode. The red VCR/TV light will be on.
- 2 Press SELECT so the green DVD light appears on the front of the TV/VCR/DVD.** This puts the TV/VCR/DVD in DVD mode.
- 3 Press OPEN/CLOSE ▲ on the front of the TV/VCR/DVD to open the Disc tray.**
- 4 Place a Disc into the tray.**
Some DVDs are recorded on both sides. Make sure the label of the side you want to play is facing up. Or, if the DVD is recorded on only one side, place the Disc in the tray with the label facing up.
- 5 Press PLAY ►.** The tray will close automatically. Playback will begin at the first Chapter or Track of the Disc.
Or, press OPEN/CLOSE ▲ or press the tray toward the TV/VCR/DVD to close the tray. Playback will start automatically.
If a DVD Disc menu appears instead, see page 48.
With some Audio CDs, playback will not begin unless you press PLAY ►.
- 6 Press STOP ■ to stop playback.** If Disc playback remains stopped for five minutes, a screen saver will appear on the screen.

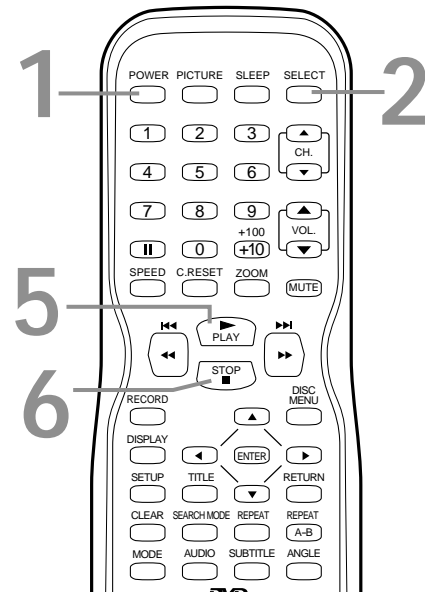

- 3 Press OPEN/CLOSE ▲ on front of the TV/VCR/DVD.**
- 4 Insert a Disc.**

**Remember, only certain Discs will play.
See page 6 for details.**

Helpful Hints

- A stop hand with a cross-X may appear on the screen when you try to access a feature that is not currently available. This is not a problem with the TV/VCR/DVD.
- If a Disc is dirty or scratched, the picture may be distorted or playback may stop. Remove the Disc and try a different one.
- Press OPEN/CLOSE ▲ or PLAY (DVD) on the front of the TV/VCR/DVD when the power is off. This turns on the unit in DVD mode (instead of the usual TV/VCR mode).

14 Remote Control Buttons

PICTURE Button

Press to access the picture controls. *Details are on page 24.*

POWER Button

Press to turn on or off the TV/VCR/DVD.

Number Buttons

TV Mode: Press two digits to access a specific channel. Press 0 before the number of a single digit channel.

Details are on page 11.

+100/+10 button: To select channels 100 or higher, press +100/+10, then the Number buttons of the last two digits of the channel number.

DVD Mode: Use the Number buttons to enter a Track or Chapter number.

+100/+10 button: Press before entering double-digit numbers. For example, to select Chapter 16, press +100/+10, then 1, 6.

|| (pause) Button

Press to pause videotape recording. Press again to resume recording. *Details are on page 25.* Press to pause videotape or DVD playback. Press repeatedly to advance the picture one frame at a time. *Details are on pages 37 and 53.*

RECORD Button

Press once to start a recording. *Details are on page 25.*

DISPLAY Button

TV/VCR Mode: Press to see the tape counter, channel, or time on the screen. *Details are on page 24.*

DVD Mode: Press to see the Disc status on the screen. *Details are on page 69.*

TITLE Button

Press to access a DVD's Title menu if available. *Details are on page 48.*

SLEEP Button

Press to set the Sleep Timer. *Details are on page 40.*

SELECT Button

Press to choose TV/VCR or DVD mode. The corresponding light will appear on the front of the TV/VCR/DVD to indicate which mode is active. *Details are on page 16.*

PLAY ► Button

Press to start playing a Disc or video cassette. *Details are on pages 12-13.*

►► / ►►► Button

During Disc playback, press briefly to skip to the next Track or Chapter. *Details are on pages 50 and 52.*

Or, press and hold for two seconds to search forward during Disc playback. *Details are on page 49.*

During videotape playback, press to search forward. *Details are on page 37.* Or, press when playback is stopped to fast forward a videotape.

STOP ■ Button

Press to stop Disc or videotape playback.

Arrow Buttons

Use the Arrow buttons to select or adjust menu items.

RETURN Button

Press to go to the previous Setup menu in DVD mode. Press to remove some menus or displays.

REPEAT Button

Press to play a Disc, Title, Chapter, or Track repeatedly. *Details are on page 54.*

ENTER Button

Press to accept or confirm a menu setting.

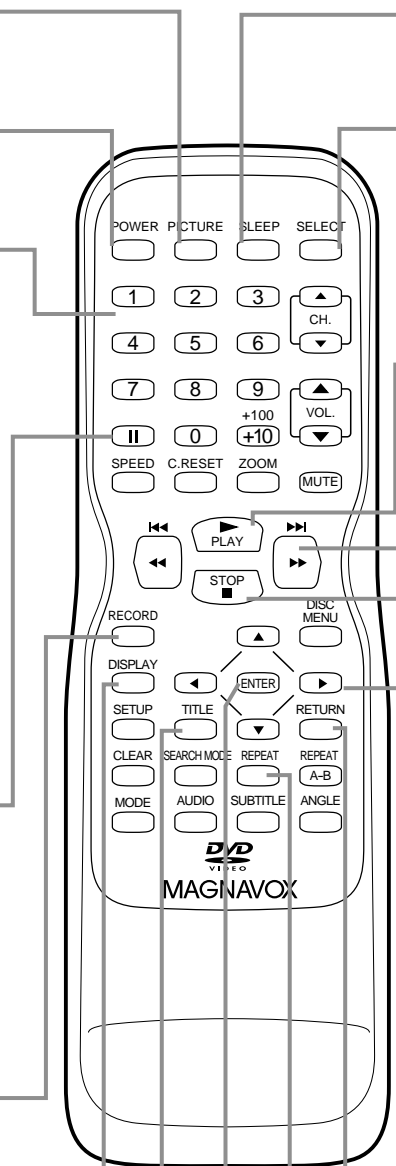

Remote Control Buttons (cont'd) 15

ZOOM Button

Press to enlarge the picture during DVD playback. *Details are on page 57.*

C.RESET (counter reset) Button

Press to reset the tape counter to 0:00:00. *Details are on page 34.*
Press to cancel a timer recording. *Details are on page 30.*

SPEED Button

Press to choose a tape recording speed (SP or SLP). *Details are on page 25.*

⏮ / ⏪ Button

During Disc playback, press briefly to skip to the beginning of the current Track/Chapter. Press repeatedly to skip to previous Tracks/Chapters. *Details are on pages 50 and 52.*

Or, press and hold for two seconds to search backward during Disc playback. *Details are on page 49.*

During videotape playback, press to search backward. *Details are on page 37.* Or, press when playback is stopped to quickly rewind the tape.

SETUP Button

Press to access or remove a menu.

CLEAR Button

Press to reset or erase a setting or wrong information.

MODE Button

Press to play a Program or to start Random playback. *Details are on page 61.*

SEARCH MODE Button

Press to find a specific time, Chapter, Track, or Title on a Disc. *Details are on pages 50-52.*
Press to set up Markers. *Details are on page 55.*

CH. (channel) ▲/▼ Buttons

Press to select memorized TV channels. *Details are on pages 18-19.*

VOL. (volume) ▲/▼ Buttons

Press to adjust the volume.

MUTE Button

Press to mute or restore the sound.

DISC MENU Button

Press to access DVD Disc menus. *Details are on page 48.*

REPEAT A-B Button

Press to set a section of a Disc to play repeatedly. *Details are on page 54.*

ANGLE Button

Press to change the camera angle and watch a sequence from a different perspective. *Details are on page 56.*

SUBTITLE Button

Press to select a subtitle language. *Details are on page 56.*

AUDIO Button

Press to select an audio language or sound mode. *Details are on page 60.*

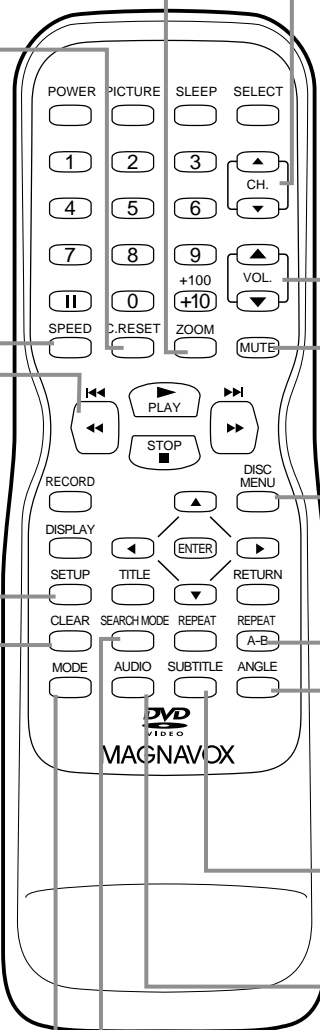

16 Front Panel

Cassette Compartment

Insert a videotape here.

Disc tray

Insert a Disc here.

CHANNEL ▲/▼ Buttons

Press to select TV channels.

Details are on page 11.

OPEN/CLOSE ▲ Button (DVD)

Press to open or close the disc tray.

Details are on page 13.

STOP ■ Button (DVD)

Press to stop Disc playback.

Details are on page 13.

VOLUME ▲/▼ Buttons

Press to adjust the volume.

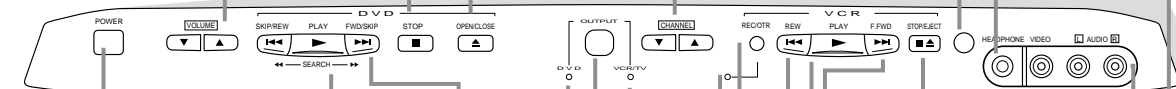

POWER Button

Press to turn the TV/VCR/DVD on or off. Turn off the TV/VCR/DVD for a timer recording.

PLAY ► Button (DVD)

Press to start Disc playback.

Details are on page 13.

SKIP/REW ◀◀, FWD/SKIP ▶▶ Buttons (DVD)

Press to go to a different Chapter or Track. *Details are on page 50.*

DVD light (green)

Appears if the TV/VCR/DVD is in DVD mode.

OUTPUT Button

Press to select TV/VCR or DVD mode. If you switch to TV/VCR mode, wait about 4 seconds before switching back to DVD mode.

VCR/TV light (red)

Appears if the TV/VCR/DVD is in TV/VCR mode.

REC/OTR light (red)

This light flashes during recording. It lights when the TV/VCR/DVD is in Standby mode (power off) for a timer recording.

REC/OTR Button (VCR)

Press to start a videotape recording. *Details are on pages 25-26.*

REW ◀◀ Button (VCR)

Press to rewind the tape or to search backward quickly during playback. *Details are on page 37.*

STOP/EJECT ■▲ Button (VCR)

Press to stop tape playback. Press while play is stopped to remove the tape.

F.FWD ▶▶▶ Button (VCR)

Press to fast forward the tape or to search forward quickly during playback. *Details are on page 37.*

PLAY ► Button (VCR)

Press to start tape playback. *Details are on page 12.*

VIDEO and AUDIO L/R

(left/right) In jacks Use audio and video cables to connect these jacks to the Audio and Video Out jacks of a Camcorder, DVD Player, or VCR. This lets you watch materials playing on the other equipment when you choose AUX (channel 00) at the TV/VCR/DVD. *Details are on page nine and 27.*

HEADPHONE jack

Connect headphones (not supplied) here for personal listening.

Remote Sensor

Receives a signal from your remote control so you can operate the TV/VCR/DVD from a distance.

Rear Panel 17

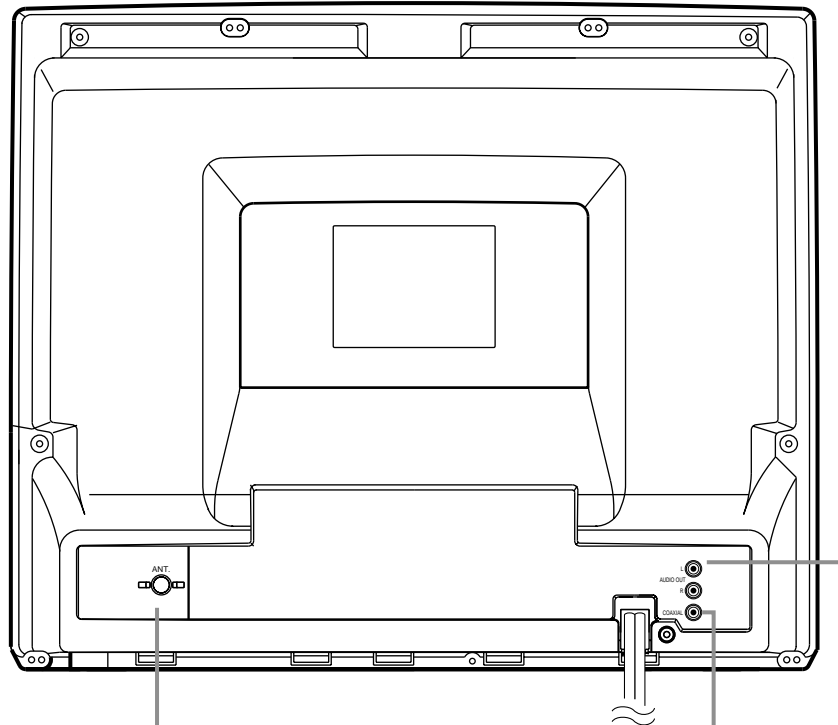

ANT. Jack (Antenna In)

Connect an antenna or Cable TV signal here. This brings TV channels to the TV/VCR/DVD. If you do not connect an antenna or Cable TV signal to the TV/VCR/DVD (or connect to a Cable Box/Satellite Receiver through this jack), you will not receive any TV channels. *Details are on page 8.*

Power Cord

Connect to a standard AC outlet (120V/60Hz).

COAXIAL Jack (Digital Audio Out) (orange)

Connect this jack to a Digital Stereo using a digital audio coaxial cable (not supplied). Use this connection if the Stereo has Dolby Digital compatibility and has a Digital Coaxial Audio In jack. You may also use this connection when connecting the TV/VCR/DVD to a Mini-Disc or Digital Audio Tape deck. *Details are on page 10.*

AUDIO OUT L/R jacks (Audio Out, left and right, white and red)

Connect these jacks to an analog Stereo. The Stereo will have right and left Audio In jacks. This means it receives and sends sound through two channels, the right and the left. These jacks are usually red and white on the Stereo. *Details are on page 10.*

18 Menu Language, Resetting TV Channels

Menu Language

This affects the language of the TV/VCR/DVD's setup menus and on-screen display terms. It does not alter the language of TV programming, videotapes, Discs, or closed captioning.

- Before you begin, put the TV/VCR/DVD in TV/VCR mode. Press SELECT so the red VCR/TV light appears on the front of the TV/VCR/DVD.

- 1 Press **SETUP**.
- 2 Press **▲** or **▼** to select **LANGUAGE**.

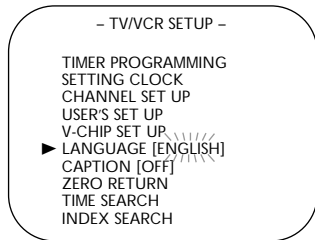

- 3 Press **◀** or **▶** to select **ENGLISH (ENG)**, **ESPAÑOL (ESP)**, or **FRANÇAIS (FRA)**. The selected language will appear inside the []. This will be the language of the TV/VCR/DVD setup menus.

- 4 Press **SETUP** to remove the menu.

Resetting TV Channels

The TV/VCR/DVD may memorize channels when you turn it on the first time. You may reset channels with these steps.

- Before you begin, put the TV/VCR/DVD in TV/VCR mode. Press SELECT so the red VCR/TV light appears on the front of the TV/VCR/DVD.

- 1 Press **SETUP**. Press **▲** or **▼** to select **CHANNEL SET UP**. Then, press **▶**.

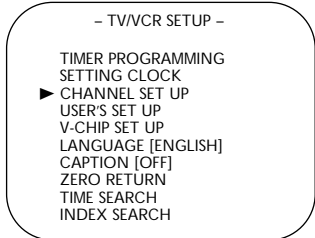

- 2 Press **▲** or **▼** to select **AUTO PRESET**. Press **▶**. The TV/VCR/DVD memorizes available channels. When scanning is complete, the TV/VCR/DVD will go to the lowest available channel automatically.

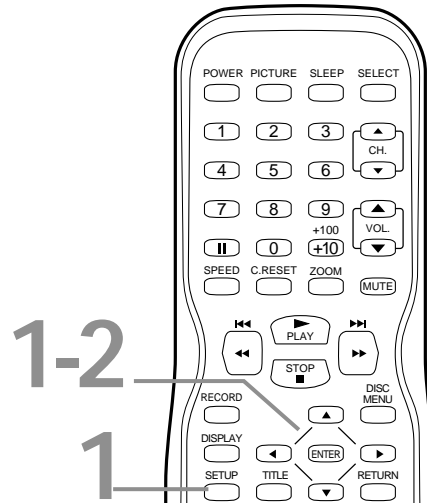
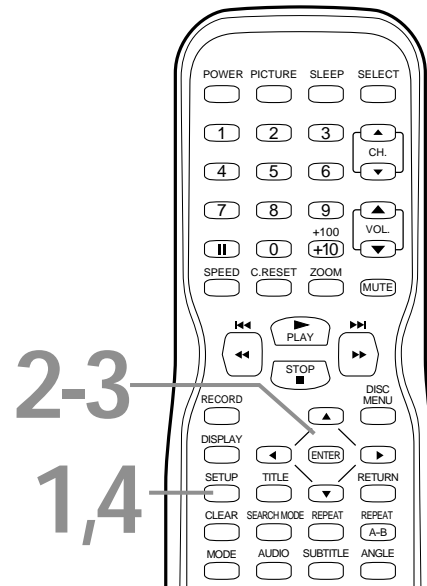
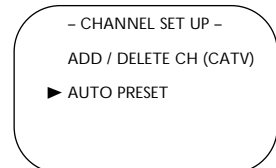

Helpful Hints

- If you accidentally select Spanish or French, press **SETUP**. Press **▲** or **▼** to select **IDIOMA** or **LANGUAGE**. Press **◀** or **▶** to select **ENGLISH**. Then, press **SETUP**.
- The TV/VCR/DVD cannot change channels at the Cable Box or Satellite Receiver. Set the TV/VCR/DVD to channel 3 or 4 or AUX. Change channels at the Cable Box/Satellite Receiver. Details are on page eight.
- If the power fails, you may have to reset the TV channels.

Adding/Deleting Channels 19

You can delete TV channels you no longer receive or seldom watch. Or, you can add more channels if the TV/VCR/DVD did not memorize all your favorite channels.

- Before you begin, press **SELECT** to put the TV/VCR/DVD in TV/VCR mode. The red VCR/TV light will appear.

1 Press **SETUP**.

2 Press **▲** or **▼** to select **CHANNEL SET UP**. Then, press **▶**.

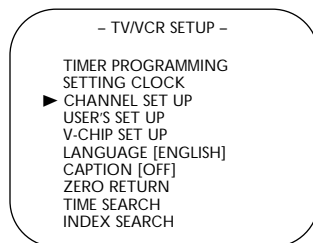

3 Press **▲** or **▼** to select **ADD/DELETE CH.** (TV or (CATV) will appear beside ADD/DELETE CH. This indicates whether you connected an Antenna (TV) or a Cable TV signal (CATV) to the TV/VCR/DVD. Then, press **▶**. The menu will disappear and a TV channel will appear. The channel number will appear, along with ADD/DELETE.

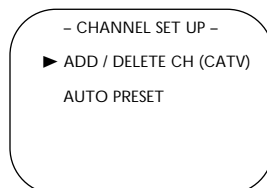

4 Press **▲** or **▼** until the channel you wish to add or delete appears. You also can use the Number buttons or the CH. **▲/▼** buttons to choose a channel.

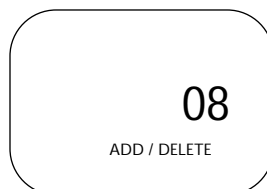

5 Press **◀** or **▶** to add or delete the channel. To add a channel, press **◀** or **▶** so ADD and the channel number appear in light blue (teal). To delete a channel, press **◀** or **▶** so DELETE and the channel number appear in light red (purple). To delete another channel, repeat steps 4-5.

6 Press **SETUP** when you are finished.

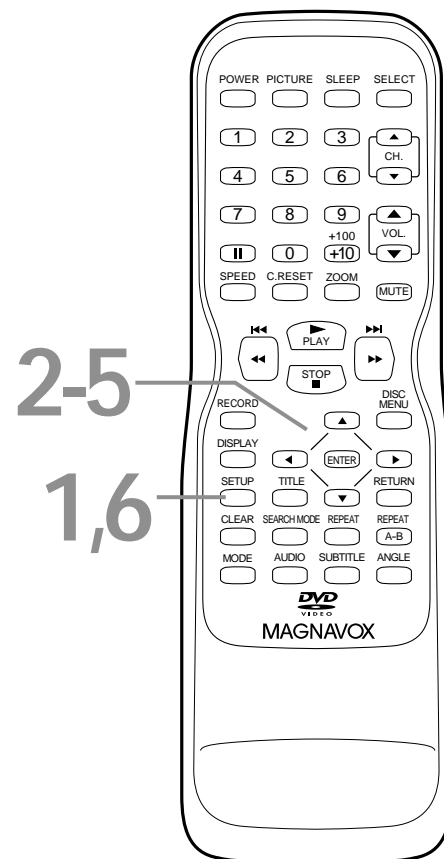

Helpful Hints

- To confirm that a channel has been added or deleted, press the CH. **▲/▼** buttons to see if you can or cannot select the channel. Only memorized/added channels can be selected with CH. **▲/▼**. Use the Number buttons to select deleted channels.
- If you connected an Antenna to the TV/VCR/DVD, channels 2-69 will be available to add or delete. If you connected to Cable TV, channels 1-125 will be available.

20 Setting the Clock

Manual Clock Setting

You must set the TV/VCR/DVD clock before you can do a timer recording. Set the clock manually when first setting up the TV/VCR/DVD. Afterward, Auto Clock will correct the time automatically if necessary.

If you do not receive a PBS station that carries time signals, you cannot use Auto Clock. Use manual clock setting. Set AUTO CLOCK to OFF. The TV/VCR/DVD will not update the time. The time will remain as you set it.

Before you begin ...

- Turn on the TV/VCR/DVD power.
- Connect the Antenna/Cable TV signal correctly. *Details are on pages eight-nine.*
- Turn on the Cable Box/Satellite Receiver (if applicable).
- Set the TV channels. *Details are on pages 18-19.*
- Press **SELECT** to put the TV/VCR/DVD in TV/VCR mode. The red VCR/TV light will appear.

1 Press **SETUP**.

2 Press **▲** or **▼** to select **SETTING CLOCK**. Then, press **▶**.

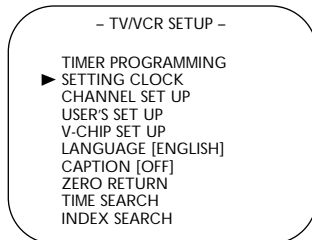

3 Press **▲** or **▼** to select **MANUAL CLOCK SET**. Then, press **▶**.

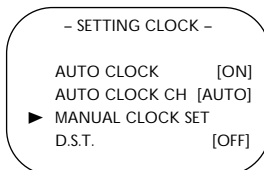

4 While the **MONTH** space is flashing, press **▲** or **▼** until your desired month appears. (Example: May → 05) Then, press **▶**.

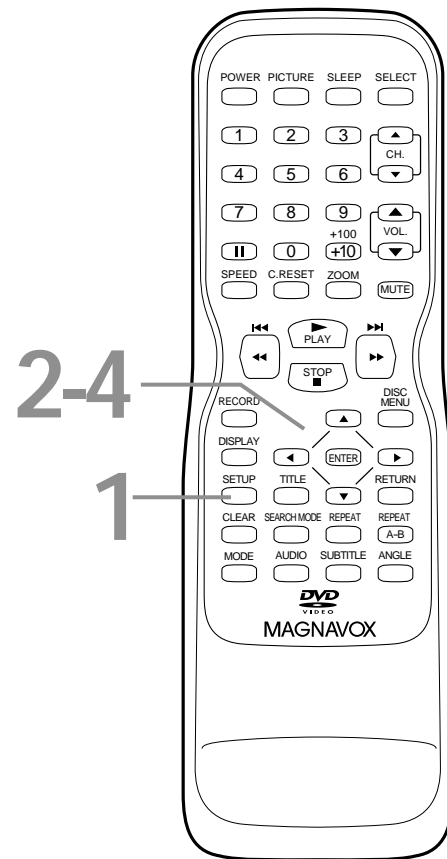
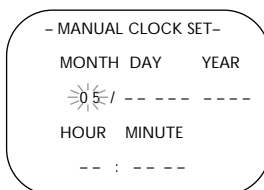

Helpful Hint

- If the power fails, you may have to reset the clock.

Setting the Clock (cont'd) 21

- 5** While the **DAY** space is flashing, press **▲** or **▼** until your desired day appears. (Example: 7th → 07) Then, press **▶**. An abbreviation for the selected day of the week will appear automatically.

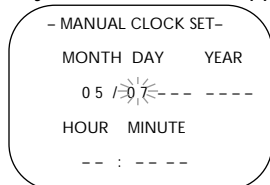

- 6** While the **YEAR** space is flashing, press **▲** or **▼** until your desired year appears. (Example: 2002) Then, press **▶**.

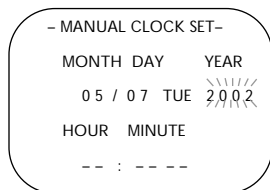

- 7** While the **HOUR** space and **AM** or **PM** are flashing, press **▲** or **▼** until your desired hour appears. (Example: 05 PM) Then, press **▶**.

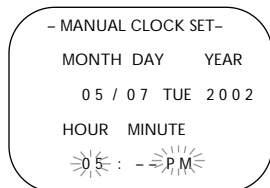

- 8** While the **MINUTE** space is flashing, press **▲** or **▼** until the desired minute appears. (Example: 40)

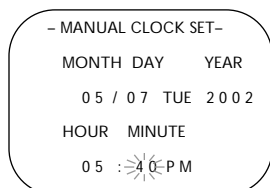

- 9** Press **SETUP**. Although seconds are not displayed, they begin counting from 00 when you press **SETUP**. Use this action to synchronize the clock with the correct time if desired.

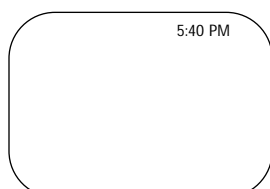

Press **DISPLAY** repeatedly in TV/VCR mode to see the current time on the screen. Details are on page 24.

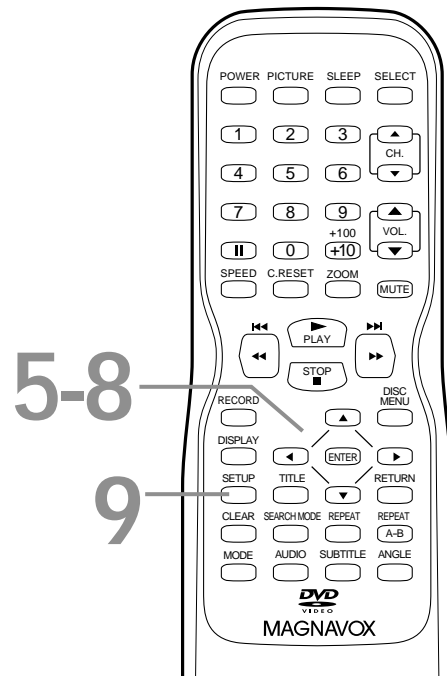

Helpful Hint

- To adjust the clock later, follow steps 1-3 on page 20. Then, press **◀** or **▶** to select the item you want to change. Enter the correct information by pressing **▲** or **▼**. Press **SETUP** when you are finished.

22 Setting the Clock (cont'd)

Auto Clock Setting

You can have the TV/VCR/DVD set the clock automatically using your PBS channel. Once you set the clock, the TV/VCR/DVD will automatically monitor the correct time and date broadcast by the PBS station.

Before you begin ...

- Turn on the TV/VCR/DVD power.
- Connect the antenna/Cable TV signal.
Details are on pages eight-nine.
- Turn on the Cable Box/Satellite Receiver (if applicable).
- Set up the TV channels. *Details are on pages 18-19.*
- Press **SELECT** to put the TV/VCR/DVD in TV/VCR mode. The red VCR/TV light will appear.

1 Press **SETUP**.

2 Press **▲** or **▼** to select **SETTING CLOCK**. Press **▶**.

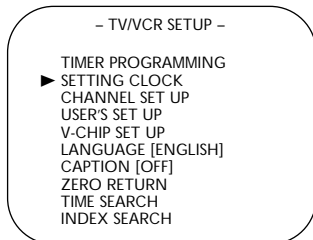

3 With **AUTO CLOCK** selected, press **▶** repeatedly so **[ON]** appears beside **AUTO CLOCK**.

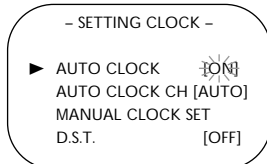

4 Press **▼** to select **AUTO CLOCK CH**. Then press **◀** or **▶** until your PBS channel number appears beside **AUTO CLOCK CH**. Choose **AUTO** if you want the TV/VCR/DVD to choose a PBS station for you.

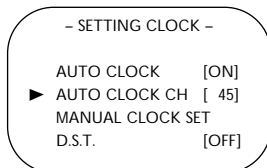

5 Press **SETUP** to remove the menus.

6 Press **POWER** to turn off the TV/VCR/DVD and let the PBS channel update the clock. This may take from 10 minutes to an hour. When you turn on the unit again, the clock will be set.

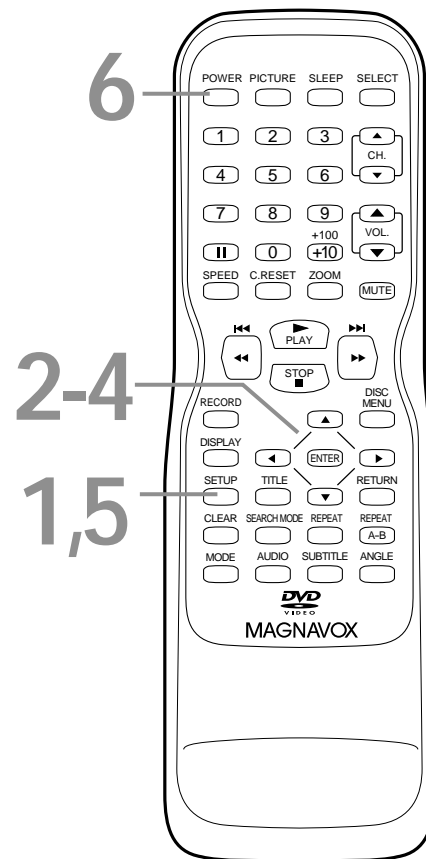

Helpful Hints

- You must use the TV/VCR/DVD remote control to set the clock.
- If there are no stations in your area with the Auto Clock signal, Auto Clock setting is not possible. Use Manual Clock Setting. *Details are on pages 20-21.*

Daylight-Savings Time 23

When Daylight-Savings Time (D.S.T.) is ON, the TV/VCR/DVD clock will automatically move forward one hour on the first Sunday in April and move back one hour on the last Sunday in October.

To turn Daylight-Savings Time ON or OFF, follow the steps below.

- Before you begin, press **SELECT** to put the TV/VCR/DVD in TV/VCR mode. The red VCR/TV light will appear.

1 Press **SETUP**.

2 Press **▲** or **▼** to select **SETTING CLOCK**. Then, press **▶**.

- TV/VCR SETUP -

TIMER PROGRAMMING
▶ SETTING CLOCK
CHANNEL SET UP
USER'S SET UP
V-CHIP SET UP
LANGUAGE [ENGLISH]
CAPTION [OFF]
ZERO RETURN
TIME SEARCH
INDEX SEARCH

3 Press **▲** or **▼** to select **D.S.T.** Then press **▶** until **[ON]** or **[OFF]** appears.

- SETTING CLOCK -

AUTO CLOCK [ON]
AUTO CLOCK CH [AUTO]
MANUAL CLOCK SET
▶ D.S.T. ☀

4 Press **SETUP** to remove the menu.

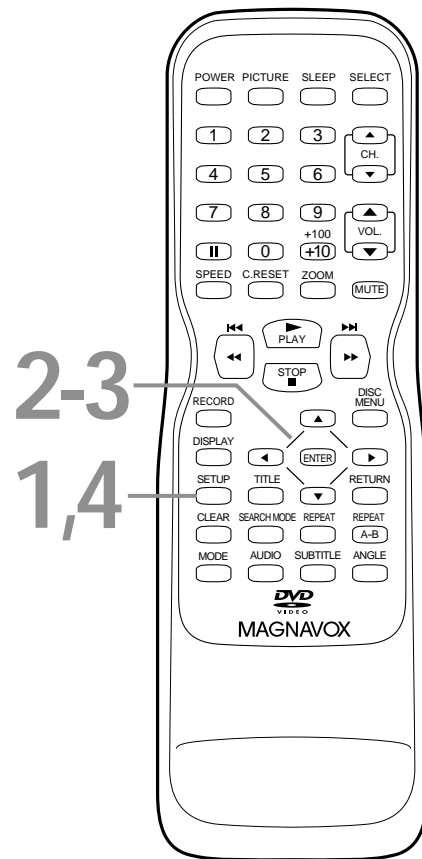

24 Status Displays, Picture Controls

Status Displays

To see the Tape Counter, Clock, or Channel number on the screen in TV/VCR mode, press DISPLAY repeatedly. The following will occur when Closed Captions are OFF.

- 1 Press **DISPLAY** once to see the real-time tape counter. After five seconds, only the counter will remain on the screen. To clear it, press DISPLAY twice.

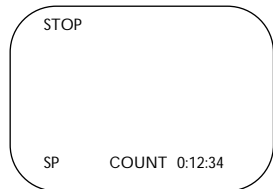

- 2 Or, press **DISPLAY** twice to see the current time and TV channel. After five seconds, only the clock and channel number will remain on the screen. To clear them, press DISPLAY once again.

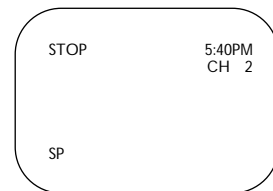

- When Closed Captions are ON, the status displays will appear for only five seconds. Then all the information will clear from the screen automatically. *Closed Caption details are on page 39.*

Picture Controls

Follow these steps to adjust the TV/VCR/DVD's brightness, contrast, color, tint, and sharpness. (You cannot adjust the Picture Controls during Audio CD playback.)

- 1 Press **PICTURE**.
- 2 Within five seconds, press **▲** or **▼** to select the picture control you want to adjust. You can select BRIGHT, CONTRAST, COLOR, TINT, or SHARPNESS.

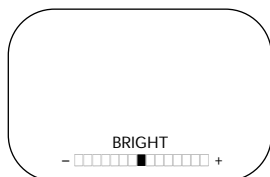

- 3 Within five seconds, press **◀** or **▶** to adjust the picture control.

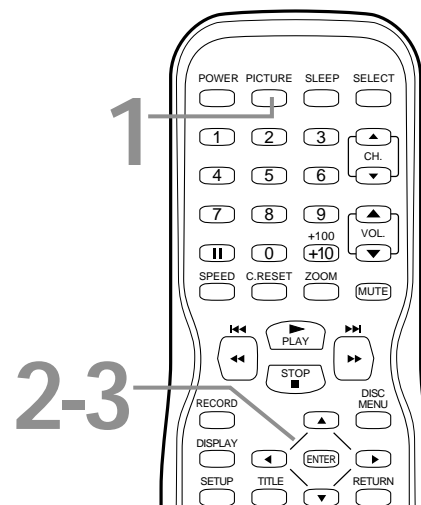
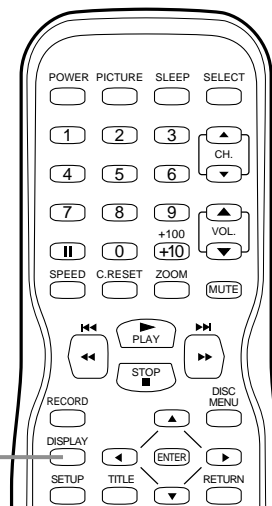

Recording (Videotapes) 25

- 1 Place a tape with its record tab intact in the cassette compartment of the TV/VCR/DVD. The TV/VCR/DVD power will come on. If the power is already on and a videotape is in the unit, make sure the unit is in TV/VCR mode. Press SELECT so the red VCR/TV light appears on the front of the unit.
- 2 Press SPEED until the desired tape speed (SP or SLP) appears in the bottom left corner of the screen. See tape speed details below.
- 3 Press CH. ▲/▼ or the Number buttons to select the channel you want to record. You cannot change channels during recording. You can only record and view one TV channel at a time.
- 4 Press RECORD once to start recording. The REC/OTR light will flash on the front of the TV/VCR/DVD. (If the tape does not have a record tab, the tape will eject. Insert another tape.)
- 5 To pause the recording, press ■■. To resume recording, press ■■ again or press RECORD.
- 6 To stop recording, press STOP ■.

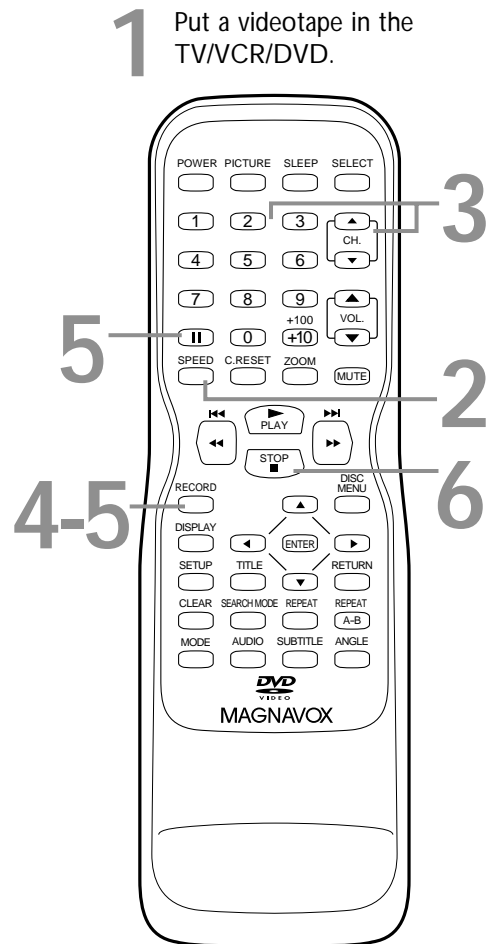

Tape Speeds

This chart shows the recording/playback time for three types of video cassettes (T160, T120, and T60). There are three playback speeds: SP, LP, and SLP. A tape will play only in the speed in which it was recorded. When recording, you can change the tape speed using the SPEED button. You cannot record in LP speed on this TV/VCR/DVD.

The slower the speed, the more programming you can fit on the tape. SLP is the slowest speed.

Tape Speed	Cassette type / Playback Time		
	T160	T120	T60
SP(Standard Play)	2 hrs. 40 mins.	2 hrs.	1 hr.
LP(Long Play) (playback only)	5 hrs. 20 mins.	4 hrs.	2 hrs.
SLP(Super Long Play)	8 hrs.	6 hrs.	3 hrs.

Helpful Hints

- You cannot record DVD contents onto a videotape using this unit.
- Recording options are on pages 26-31.
- If you pause a recording for five minutes, the unit will start Recording again automatically.
- You can change the tape speed by pressing the SPEED button while a recording is in progress. Some distortion may appear on the tape.

26 One-Touch Recording (Videotapes)

A One-Touch Recording (OTR) is an immediate timed recording from 30 minutes to eight hours long.

Before you begin ...

- Turn on the TV/VCR/DVD.
- Press SELECT to put the unit in TV/VCR mode. The red VCR/TV light will appear on the front of the unit.
- Insert a videotape with its erase prevention tab in place. *Details are on page seven.* Rewind or fast forward the tape to the point at which you want to begin recording.

1 Press the Number buttons or CH. ▲/▼ to select the channel you want to record. Remember, if the TV/VCR/DVD is connected to a Cable Box/Satellite Receiver, the TV/VCR/DVD must be on channel 3 or 4 or AUX (channel 00). Select the channel you want to record at the Cable Box/Satellite Receiver.

2 Press SPEED to select a tape recording speed (SP or SLP). *Details are on page 25.*

3 Press REC/OTR on the front of the TV/VCR/DVD repeatedly to select a recording length. Recording will start immediately. Each press of REC/OTR will increase the recording time by 30 minutes. The maximum recording length is eight hours.

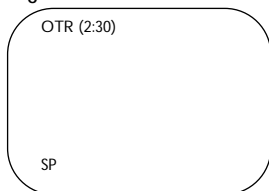

4 Press STOP ■ to stop a one-touch recording before its designated end time. Otherwise, recording will stop automatically at the time you designated. The TV/VCR/DVD will turn itself off automatically at the end of the OTR.

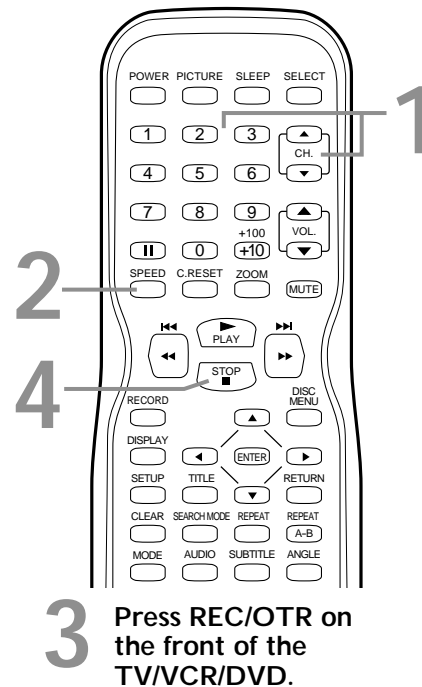

Helpful Hints

- You cannot do an OTR with the remote control.
- To show the remaining recording time, press DISPLAY. OTR and the remaining recording time will appear briefly in the top left corner of the screen.
- If the tape ends before the recording's end time, the TV/VCR/DVD will stop recording, eject the tape, and turn itself off.

Rerecording (Tape Duplication) 27

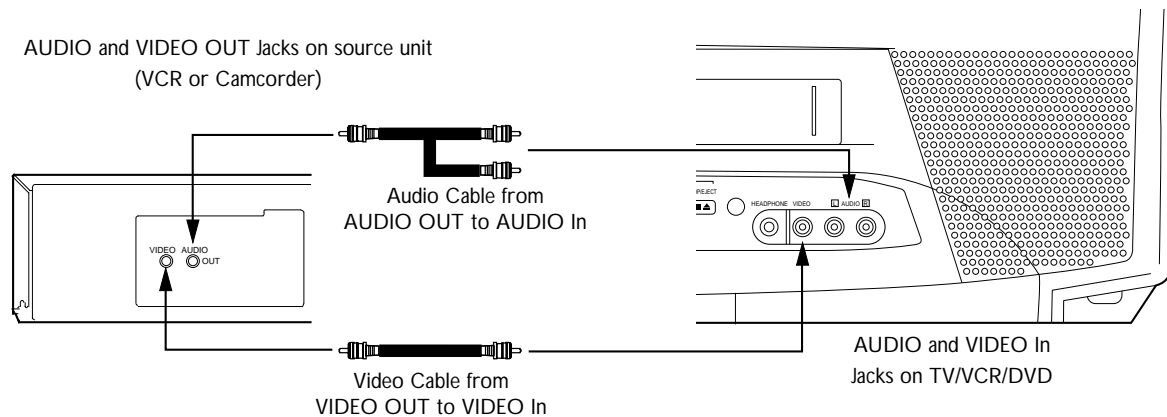

- 1** Make the connections shown above. Use audio and video cables (not supplied). Connect the source unit (VCR or Camcorder) to a power source after connections are made.
- 2** The VCR or Camcorder will play your tape. Insert a prerecorded tape in the source unit. If playback begins, press STOP on the VCR or Camcorder.
- 3** The TV/VCR/DVD will record your tape. Insert a blank videotape in the cassette compartment of the TV/VCR/DVD. Make sure the tape's record tab is intact. The TV/VCR/DVD power will turn on automatically.
If the power is already on and a videotape is in the unit, make sure the unit is in TV/VCR mode. Press SELECT so the red VCR/TV light appears on the front of the unit.
- 4** Point the TV/VCR/DVD remote control at the TV/VCR/DVD. Press 0, 0 on the remote. AUX will appear on the screen. The TV/VCR/DVD is now in Line Input or Auxiliary mode.
- 5** Press SPEED until the desired tape speed (SP or SLP) appears in the lower left corner of the screen.
- 6** Press PLAY on the VCR or Camcorder and REC(ord)/OTR on your TV/VCR/DVD at the same time. Copying will begin.
- 7** To stop copying, press STOP/EJECT on the TV/VCR/DVD, then stop the tape on the VCR or Camcorder.

Helpful Hints

- Unauthorized recording of copyrighted television programs, videotapes, or other materials may infringe on the rights of copyright owners and violate copyright laws.
- Different brands of equipment may operate differently.
- Make sure all connections are secure. Otherwise, you may not record both picture and sound.
- Programs that are copyright protected may not record clearly.
- You cannot record a DVD onto a videotape using this TV/VCR/DVD.

28 Timer Recording (Videotapes)

Follow the steps below to program the TV/VCR/DVD to record TV programs while you're away from home. The TV/VCR/DVD will turn itself on, record, and turn itself off automatically. You can set a maximum of eight timer recordings.

Before you begin, make sure ...

- The clock is set. If the clock is not set, the MANUAL CLOCK SET menu will appear. See pages 20-21 to set the clock.
- Channels are set. *Details are on pages 18-19.*
- A tape is in the TV/VCR/DVD. Make sure the record tab is intact. *Details are on page seven.*

1 Press **SETUP**. Press **▲** or **▼** to select **TIMER PROGRAMMING**, then press **▶**.

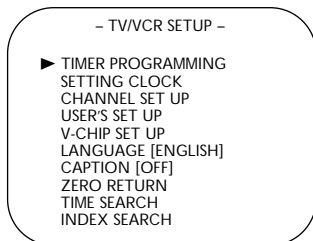

2 Press **▲** or **▼** to select a program position. Then, press **▶**.

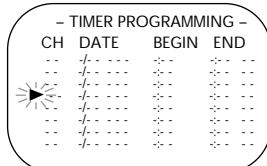

3 While **CH** is selected, press **▲** or **▼** to select the channel you want to record. Then press **▶**. If the TV/VCR/DVD is connected to a Cable Box/Satellite Receiver, the TV/VCR/DVD must be on channel 3, 4, or AUX. Set CH as 03, 04, or AUX in the Timer Programming menu. Choose the channel you want to record at the Cable Box/Satellite Receiver. Leave the Cable Box/Satellite Receiver on for the timer recording. Leave the TV/VCR/DVD set to AUX (channel 0,0).

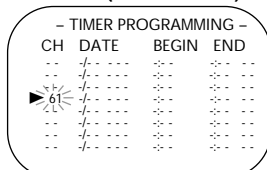

4 While **DATE** is selected, press **▲** until the desired date appears. Recording will happen once. Or, to record a program at the same time on the same channel every day, press **▼** until **EVERY DAY** appears. Or, to record a program at the same time on the same channel every week, (for example every Monday), press **▼** until **EVERY** and your desired day of the week appear together. Finally, press **▶**.

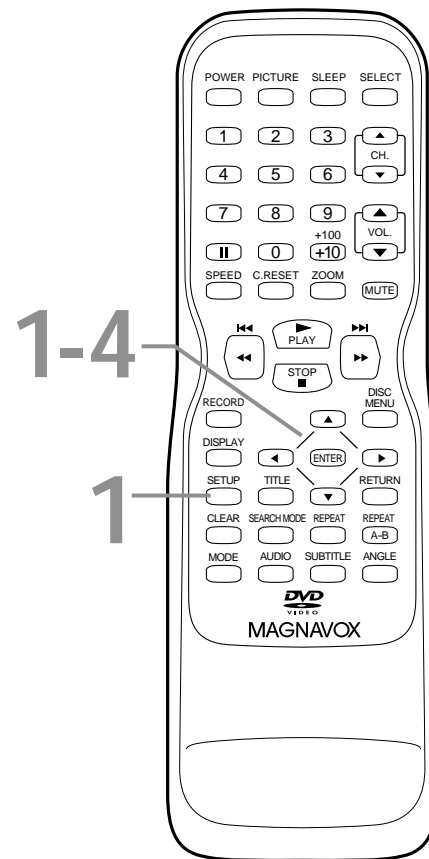

Helpful Hint

- If the tape ends before the recording is complete, the TV/VCR/DVD will stop recording immediately and eject the tape.

Timer Recording (Videotapes) (cont'd) 29

- 5** While **BEGIN** is selected, press **▲** or **▼** to select the hour you want recording to begin. AM or PM will appear with the hour. Choose the AM or PM hour as you need. Then, press **▶** and press **▲** or **▼** to select the minute you want recording to start. (Example: 7:30 PM) Press **▶**.

- TIMER PROGRAMMING -			
CH	DATE	BEGIN	END
▶ 61	7.05 FRI	7:30 ^{PM}	
..
..
..
..

- 6** While **END** is selected, press **▲** or **▼** to select the hour at which you want recording to stop. AM or PM will appear with the hour. Choose the AM or PM hour as you need. Then, press **▶** and press **▲** or **▼** to select the minute at which you want recording to end. (Example: 8:50PM) Press **▶**.

- TIMER PROGRAMMING -			
CH	DATE	BEGIN	END
▶ 61	7.05 FRI	7:30 ^{PM}	8:50 ^{PM}
..
..
..
..

- 7** Press **▲** or **▼** until the desired tape speed (**SP** or **SLP**) appears at the right end of the line.

- TIMER PROGRAMMING -			
CH	DATE	BEGIN	END
▶ 61	7.05 FRI	7:30 ^{PM}	8:50 ^{PM} SP
..
..
..
..

- 8** Press **SETUP** to remove the menu.

- 9** Press **POWER** to turn off the **TV/VCR/DVD** and set the timer recording. The red **REC/OTR** light will appear. You must turn off the **TV/VCR/DVD** to activate timer recording. If the power is not off and you continue watching TV, **TIMER REC STANDBY** starts flashing on the screen two minutes before the programmed start time. Turn off the unit to do the recording.

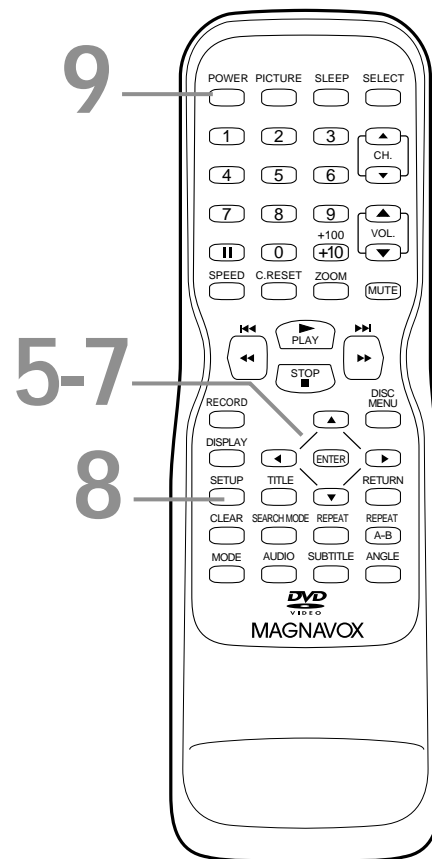

Helpful Hints

- To correct information while setting the Timer Recording, press **◀** to go back one step and select the incorrect information. Press **▲** or **▼** to enter the correct information.
- While a timer recording is in progress, the red **REC/OTR** light will flash.
- If a timer recording is set for hours or days later, you can use the **TV/VCR/DVD** until then. Just be sure to turn off the **TV/VCR/DVD** about five minutes before the recording. Set the **Cable Box/Satellite Receiver** if appropriate.
- If the record tab is missing, the videotape will eject when you press **POWER** to turn off the **TV/VCR/DVD**. Insert a recordable tape for the timer recording.

30 Timer Recording (Videotapes) (cont'd)

Extending a Timer Recording

To make a Timer Recording start and end later than originally scheduled, follow these steps.

- 1 Press POWER to turn on the TV/VCR/DVD if necessary.
- 2 Press SETUP. Press ▲ or ▼ to select TIMER PROGRAMMING. Press ►.
- 3 Press RECORD, then press ▲ or ▼ to select the desired program.
- 4 Press RECORD again. Each press of RECORD will shift forward the beginning/end time by 10 minutes. If the recording is in progress, each press will shift forward the end time only.
If you adjust the times during recording, the recording speed automatically changes to SLP.
To restore the original recording times, press ■■.
- 5 Press SETUP to remove the menu.
- 6 If the timer recording is scheduled to start later, press POWER to turn off the TV/VCR/DVD for the recording.

Correcting a Timer Recording

- 1 To correct information in a Timer Recording after you have finished setting it, press POWER to turn on the TV/VCR/DVD if necessary.
- 2 Press SETUP. Press ▲ or ▼ to select TIMER PROGRAMMING. Press ►.
- 3 Press ▲ or ▼ to select a timer recording, then press ►.
- 4 Press ► repeatedly to select the information you want to change. Press ◀ to go back a step if necessary. Press ▲ or ▼ to enter the correct information.
- 5 Press SETUP to remove the menu.
- 6 Press POWER to turn off the TV/VCR/DVD again to set the recording.

Cancelling Timer Recordings

To cancel a timer recording that is in progress:

- 1 Press POWER to turn on the TV/VCR/DVD, then press STOP/EJECT on the front of the TV/VCR/DVD.

To cancel a timer recording that has not started:

- 1 Press POWER to turn on the TV/VCR/DVD.
- 2 Press SETUP. Press ▲ or ▼ to select TIMER PROGRAMMING. Press ►.
- 3 Press ▲ or ▼ to select a timer recording.
- 4 Press C.RESET. All the information for the selected recording will disappear.
- 5 Press SETUP to remove the menu.

Checking Scheduled Timer Recordings

- 1 Press POWER to turn on the TV/VCR/DVD if necessary. The red REC/OTR light will turn off.
- 2 Press SETUP. Press ▲ or ▼ to select TIMER PROGRAMMING if necessary.
- 3 Press ►. The program details will appear on the screen.
- 4 Press SETUP to remove the menu.

Timer Recording Auto Return 31

Use this feature to find the beginning of a completed timer recording.

1 Press **SETUP**.

2 Press **▲** or **▼** to select **USER'S SET UP**. Then, press **▶**.

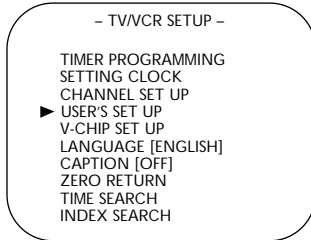

3 Press **▲** or **▼** to select **AUTO RETURN**.

4 Press **◀** or **▶** until **ON** appears beside **AUTO RETURN**. To turn off **AUTO RETURN**, press **◀** or **▶** to choose **OFF** instead.

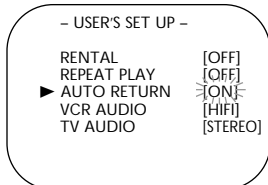

5 Press **SETUP**. When **AUTO RETURN** is **ON**, when all the timer recordings are completed, the **TV/VCR/DVD** will rewind to the beginning of the recorded program(s). Press **PLAY ▶** to play the tape from the beginning of the timer recordings.

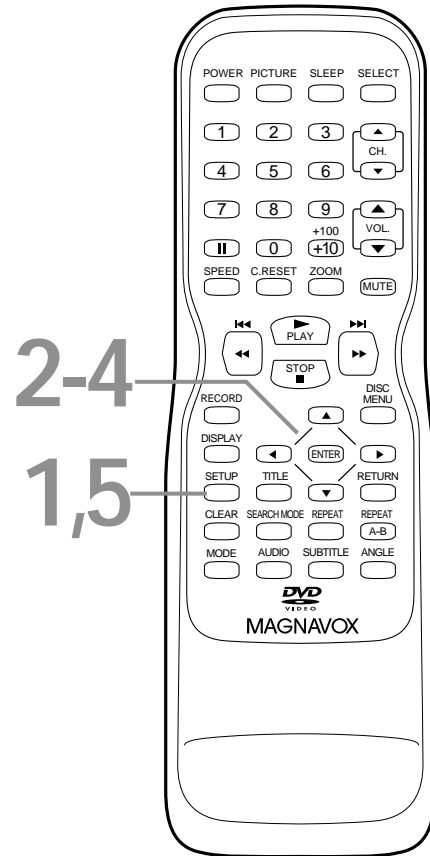

Helpful Hints

- If you press **POWER** while the tape is rewinding, **Auto Return** will stop.
- If there is a power failure, the **TV/VCR/DVD** will retain its memory for this feature.

32 Repeat Play (Videotapes)

Repeat Play allows you to play a tape continuously. ALL REPEAT will repeatedly play the tape from the beginning to the end. BLANK REPEAT will repeatedly play the tape from its beginning to the first part that is blank for more than 10 seconds.

- 1 Press **SETUP**.
- 2 Press **▲** or **▼** to select **USER'S SET UP**. Then, press **▶**.

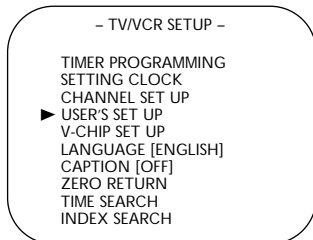

- 3 Press **▲** or **▼** to select **REPEAT PLAY**.
- 4 Press **◀** or **▶** repeatedly until **ALL** or **BLANK** appears beside **REPEAT PLAY**. Or, to cancel **REPEAT PLAY**, press **◀** or **▶** to select **OFF**.

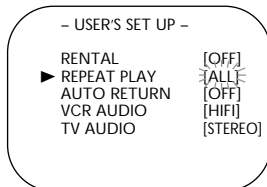

- 5 Press **SETUP** to remove the menu.
- 6 Press **PLAY ▶** to start repeat playback. **REPEAT PLAY ▶** will appear on the screen briefly.

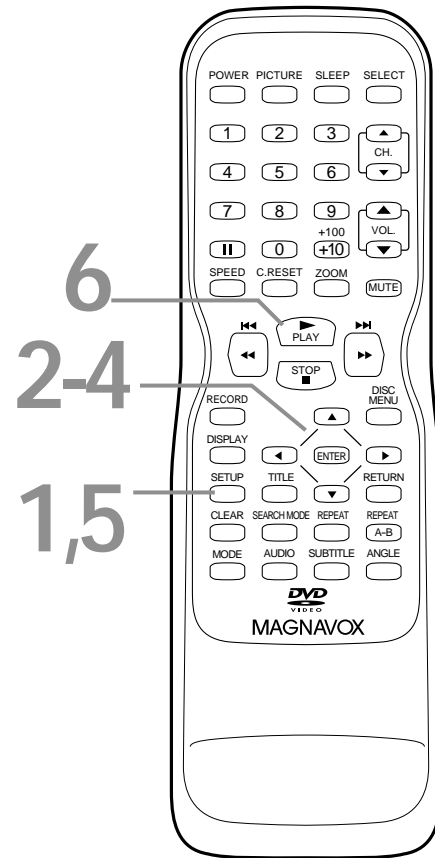

Helpful Hints

- Repeat Play stays in effect after you turn off the TV/VCR/DVD. The TV/VCR/DVD keeps the Repeat Play setting even if the power fails.
- If **RENTAL** is ON, **RENTAL PLAY ▶** will appear on the screen instead of **REPEAT PLAY ▶**. Details are on page 33.

Rental Playback (Videotapes) 33

This function enables you to improve picture quality when playing worn cassettes such as rented videotapes.

- 1 Press **SETUP**. Press **▲** or **▼** to select **USER'S SET UP**. Then, press **▶**.

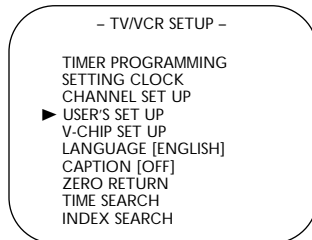

- 2 Press **▲** or **▼** to select **RENTAL**. Press **◀** or **▶** until **ON** appears beside **RENTAL**. To turn off RENTAL, press **◀** or **▶** to choose **OFF**.

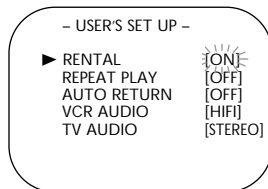

- 3 Press **SETUP** to remove the menu.

- 4 Press **PLAY ▶** to start playback. **RENTAL PLAY ▶** will appear briefly on the screen.

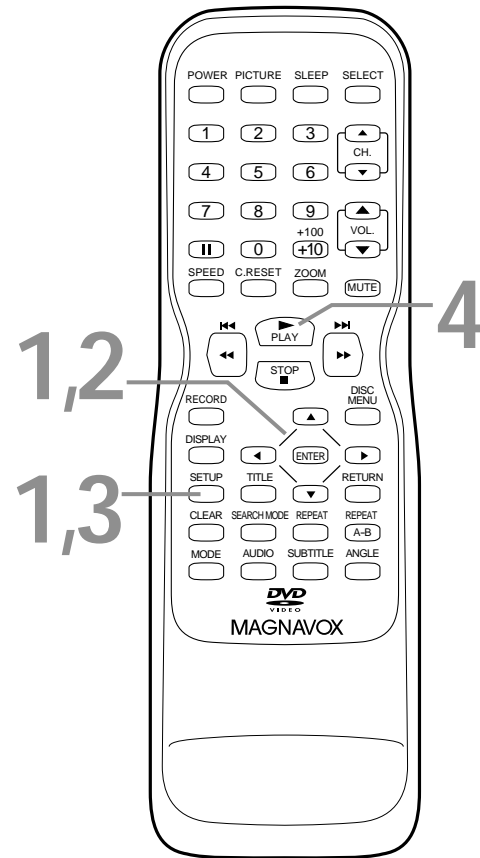

Helpful Hints

- Once you select Rental Playback, it stays in effect even after you turn off the TV/VCR/DVD.
- The TV/VCR/DVD will retain the Rental setting even if the power fails.

34 Zero Return (Videotapes)

The tape counter shows the elapsed recording or playback time in hours, minutes, and seconds from the point at which the counter was set to zero. The counter time will not change on a blank tape or blank portions on a tape. The "--" before the tape counter indicates the amount of remaining recording/playing time before the counter reaches zero. Follow the steps below to reset the tape counter to zero at a tape location you want to refer to later.

- 1** Play, rewind, or fast forward the tape to the location you would like to refer to later. Press **STOP** ■ to stop the tape.
- 2** Press **C.RESET** to set the counter to 0:00:00.
- 3** To return to this same point later, press **SETUP**. Press **▲** or **▼** to select **ZERO RETURN**. Then, press **▶**.
The tape counter will appear on the screen. When the tape reaches the point at which you set the counter to zero, the tape will stop. Press **PLAY** ▶ to watch the tape from the designated point.

- TV/VCR SETUP -

TIMER PROGRAMMING
SETTING CLOCK
CHANNEL SET UP
USER'S SET UP
V-CHIP SET UP
LANGUAGE [ENGLISH]
CAPTION [OFF]
▶ ZERO RETURN
TIME SEARCH
INDEX SEARCH

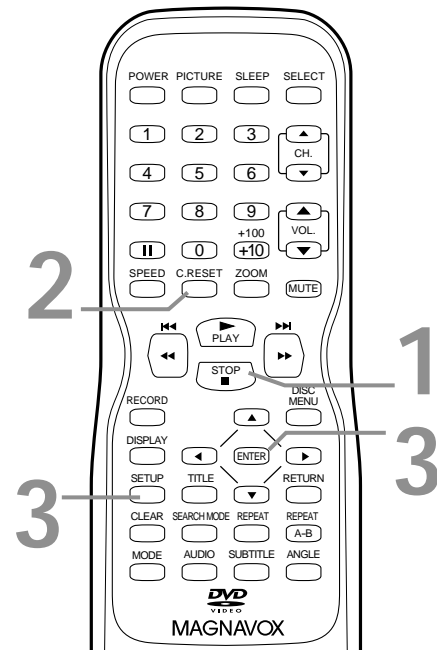

Time Search (Videotapes) 35

Time Search lets you quickly advance the videotape to a position simply by entering the amount of playback time you want to skip.

In the example below, Time Search is set to 2 hours, 50 minutes from the present position.

1 Insert a videotape.

2 Press **SETUP**. Press **▲** or **▼** to select **TIME SEARCH**. Then, press **▶**.

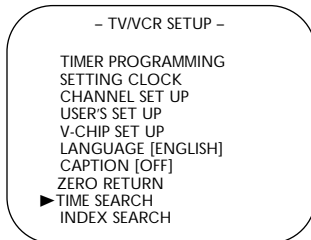

3 Press **▲** or **▼** until your desired time appears beneath **TIME SEARCH** at the top of the screen (for example, 2:50 for 2 hours, 50 minutes). Each press of **▲** or **▼** increases or decreases the length of time by 10 minutes. To cancel the Time Search at this point, press **SETUP**.

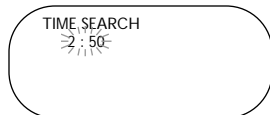

4 Press **◀** or **▶** to rewind or fast forward the tape the length of time you chose. The TV/VCR/DVD will rewind or fast forward the tape the specified amount of time. The time counts down on the screen as the search progresses. When 0:00 is reached, the tape will start playing automatically. Or, to cancel the time search before it finishes, press **STOP**.

1 Insert a videotape.

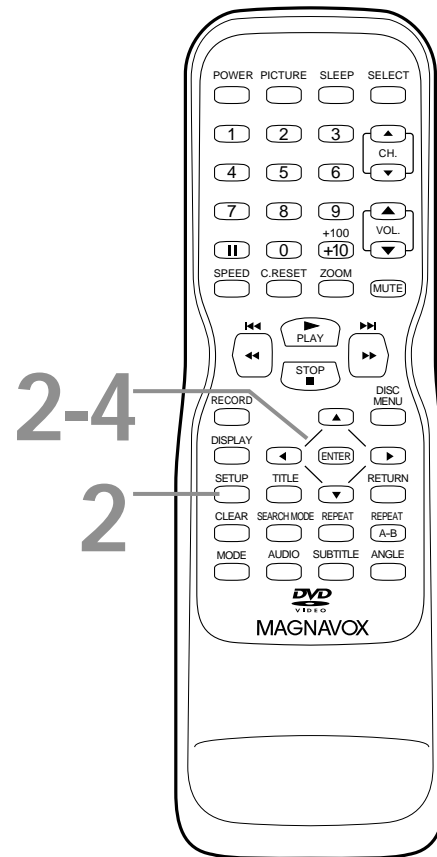

Helpful Hints

- A Time Search can be set up to a maximum of 9 hours 50 minutes in 10-minute increments.
- Time Search will not operate during recording.

36 Index Search (Videotapes)

This feature marks the starting point of a recording. It can be returned to easily by fast forwarding or rewinding.

- An Index Mark will be made automatically when you press RECORD. Marks also are made at the starting point of timer recordings and One-Touch Recordings.
- Index Marks are not made if you press ■■ during recording.
- The time gap between Index Marks should be greater than one minute for SP recording and three minutes for SLP recording.
- In some cases, Index Marks at the beginning of a videotape cannot be detected.

Example:

You are watching Program 4 and want to fast forward to Program 7. You must skip three programs (programs 4, 5, and 6).

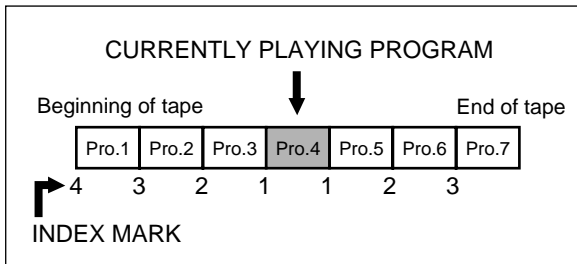

- 1 Press **SETUP**. Press **▲** or **▼** to select **INDEX SEARCH**. Then, press **▶**.

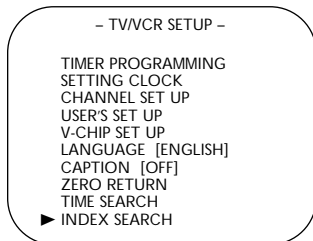

- 2 Press **▲** or **▼** until the number of programs you want to skip appears beneath **INDEX SEARCH**. (Example: "03" for 3 programs) To cancel an Index Search at this point, press **SETUP**.



- 3 Press **◀** or **▶**. The TV/VCR/DVD begins rewinding or fast forwarding the videotape to the beginning of the desired program.
- 4 When the program is reached, playback will start automatically.

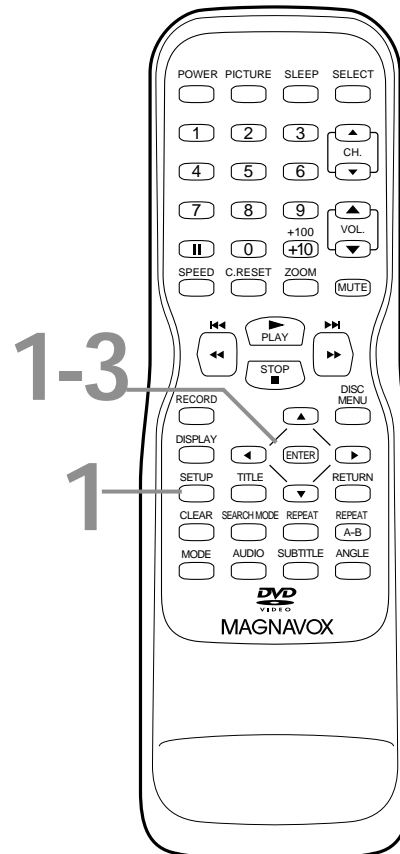

Helpful Hints

- Every time an Index Mark is passed, the number beneath **INDEX SEARCH** on the screen decreases by one.
- A videotape must be in the TV/VCR/DVD for this function to work.
- You may search up to 20 Index Marks.
- This function will not operate during recording.
- To cancel an Index Search, press **STOP ■■**.

Videotape Playback Features 37

Slow Motion

- 1 Press **II** during playback to pause the videotape. Then press **▶▶I / ▶▶** to start slow motion playback. Sound will be mute during slow motion playback. Slow motion playback will stop automatically after five minutes to prevent damage to the tape.
- 2 Press **PLAY ▶** to return to normal playback.

Forward and Reverse Searching (SP/LP/SLP)

- 1 During videotape playback, press and release **▶▶I / ▶▶** or **I◀◀ / ◀◀**. A fast forward or reverse picture search will begin.
- 2 To return to normal playback, press **PLAY ▶**.

Super High Speed Searching (LP/SLP)

- 1 During tape playback, press **▶▶I / ▶▶** or **I◀◀ / ◀◀**, then press again. The TV/VCR/DVD will now search in super high speed. Press **▶▶I / ▶▶** or **I◀◀ / ◀◀** repeatedly to switch between regular and super high speed searching.
- 2 To return to normal playback, press **PLAY ▶**.

Viewing a Still Picture

- 1 During tape playback, press **II**. A still picture will appear on the screen. The picture advances each time you press **II**. After a tape is paused for five minutes, playback will stop automatically. This prevents damage to the tape and TV/VCR/DVD.
- 2 If the still picture vibrates vertically, stabilize the picture by pressing **CH. ▲/▼**.
- 3 To release the still picture and return to normal playback, press **PLAY ▶**.

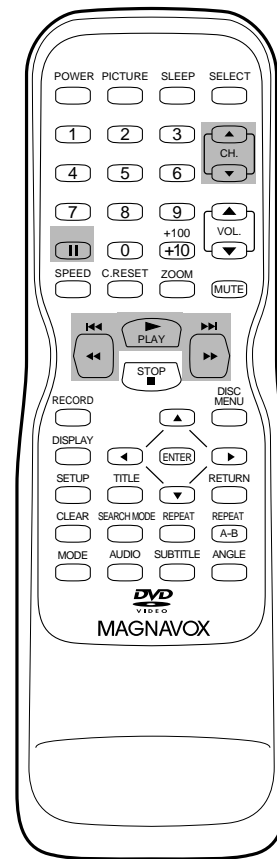

Helpful Hints

- *SP/LP/SLP means this feature will work with tapes recorded in Standard Play, Long Play, or Super Long Play. LP/SLP means this feature will work with tapes recorded in Long Play and Super Long Play. Tape speed details are on page 25.*
- *During forward and reverse searching, horizontal noise bars will appear on the screen.*

38 Automatic Operation Features (Videotapes)

The following videotape features are available.

Automatic Rewind, Eject, Off

When you play, fast forward, or record a videotape to its end, the TV/VCR/DVD will rewind the tape, stop, turn itself off, and eject the tape.

If REPEAT PLAY is ON, playback will start again instead.

Details are on page 32.

The tape will not rewind automatically during timer recording or One-Touch Recording. To rewind a tape automatically after timer recordings, see Auto Return details on page 31.

Automatic Tracking Adjustment

The TV/VCR/DVD automatically adjusts the videotape tracking to give you the best possible picture quality. With some recordings, however, you may get a better picture using the manual tracking controls (see below).

Manual Tracking

To adjust the tracking manually, press the CHANNEL ▲/▼ buttons on the front of the TV/VCR/DVD or the CH. ▲/▼ buttons on the remote control during playback.

Tracking returns to Automatic Tracking Adjustment when you insert a tape or press STOP ■.

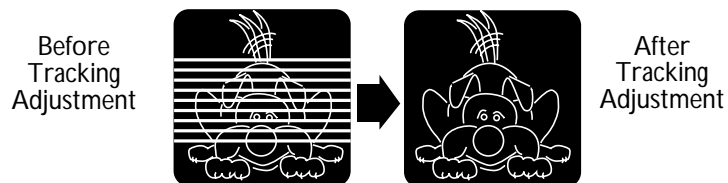

Closed Caption (TV/VCR) 39

Follow the steps below to select closed captions for TV programming. Not all TV programs and commercials have closed captions or all types of closed captions (second language, half-screen text, etc.). If closed captioning is not broadcast, you cannot receive it. This does not indicate a problem with the TV/VCR/DVD. Check your TV program listings for shows with closed captions.

If the TV/VCR/DVD receives poor quality television signals, the captions may contain errors, or there might be no captions at all. Some possible causes of poor quality signals are:

- Automobile ignition noise
- Electric motor noise
- Weak signal reception
- Multiplex signal reception (ghosts or screen flutter)
- Playback of poorly recorded or worn videotapes.

- 1 Press SETUP.**
Press ▲ or ▼ to select **CAPTION**.

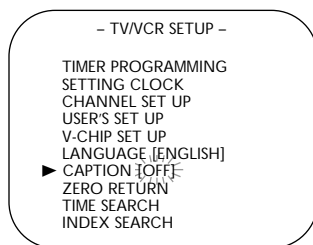

- 2 Press ◀ or ▶ to select CAPTION1, CAPTION2, TEXT1, TEXT2, or OFF.**
CAPTION1 displays standard closed captions (what a character is saying). CAPTION2 displays foreign language closed captions (foreign language words showing what a character is saying).
TEXT1 and TEXT2 display half-screen text (such as a channel guide, schedule, or announcement).
OFF turns off closed captions. Captions will not appear on the screen.

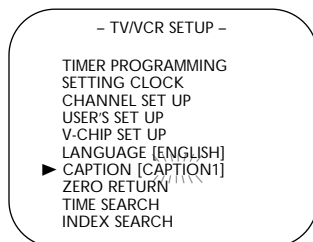

- 3 Press SETUP to remove the menu.**

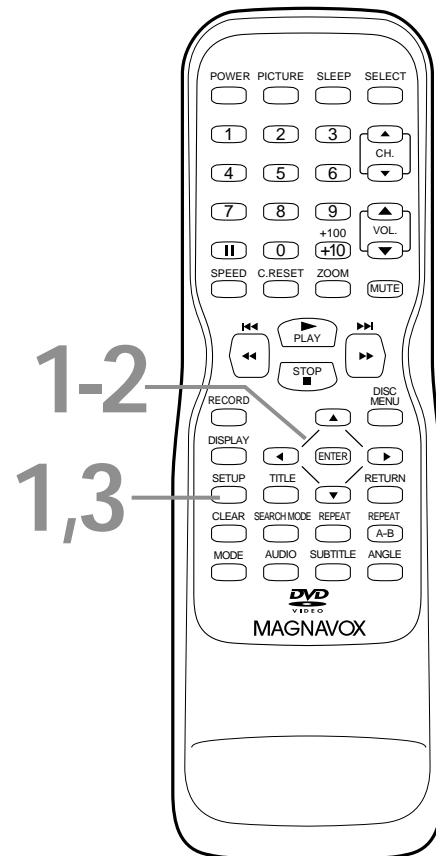

Helpful Hints

- If a black box appears on the screen, a TEXT mode is selected. Select CAPTION1, CAPTION2, or OFF.
- The TV/VCR/DVD retains the Closed Caption setting if the power fails.
- Abbreviations, symbols, and other grammatical shortcuts may be used in order to keep pace with the on-screen action. This is not a problem with the TV/VCR/DVD.
- Changing channels may delay closed captions for a few seconds.
- Adjusting or muting the volume may delay closed captions for a few seconds.

40 Sleep Timer

Use the Sleep Timer to program the TV/VCR/DVD to shut off in a certain amount of time.

1 Press SLEEP repeatedly until your desired amount of time appears on the screen with SLEEP.

Each press of SLEEP will increase the time by 30 minutes. You may set a Sleep Timer of 30, 60, 90, or 120 minutes.

After five seconds, the Sleep Timer information will disappear from the screen.



The TV/VCR/DVD will turn itself off after the selected amount of time has passed.

To Cancel the Sleep Timer

Press SLEEP repeatedly until "SLEEP 0 MINUTE" appears.

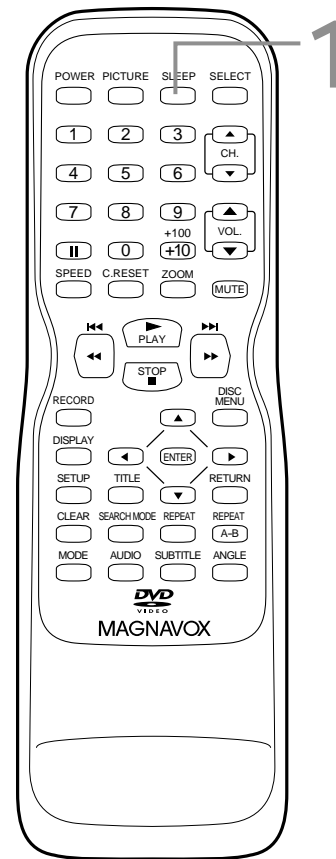

Helpful Hint

- To see how much time remains before the TV/VCR/DVD turns itself off, press SLEEP once. The information will disappear automatically in five seconds.

Setting V-Chip (TV) 41

V-Chip Settings

You can set the TV/VCR/DVD to block TV channels that you do not want children to access.

- Before you begin, press SELECT to put the TV/VCR/DVD in TV/VCR mode. The red VCR/TV light will appear on the front of the TV/VCR/DVD.

- 1 Press **SETUP**. Press **▲** or **▼** to select **V-CHIP SET UP**. Then, press **▶**.

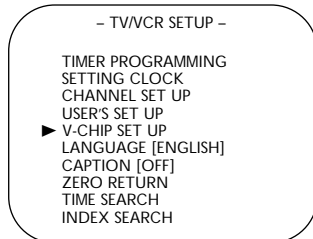

- 2 Press the **Number** buttons to enter the access code. When entering the access code for the first time or if there has been a power failure, enter default code 0000.

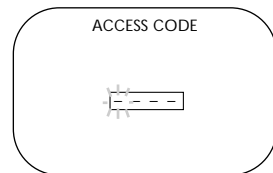

- 3 Press **▲** or **▼** to select **TV RATING**. Then, press **▶**.

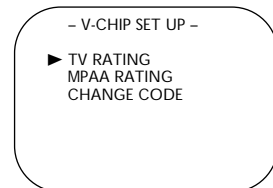

- 4 Press **▲** or **▼** to select the TV Rating level at which you want to block viewing, then press **▶** once. If you press **▶** more than once, the subratings for that category will appear. *Details are on page 42.* When you select the rating category and set it to **BLOCK**, the higher ratings will turn to **BLOCK** automatically. Also, lower ratings will turn to **VIEW** automatically.

When you turn "TV-Y" to **VIEW** (or **BLOCK**), all ratings will turn to **VIEW** (or **BLOCK**) automatically.

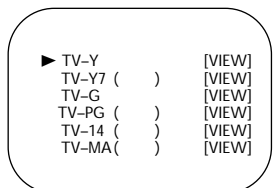

- 5 Press **SETUP** to save your settings.

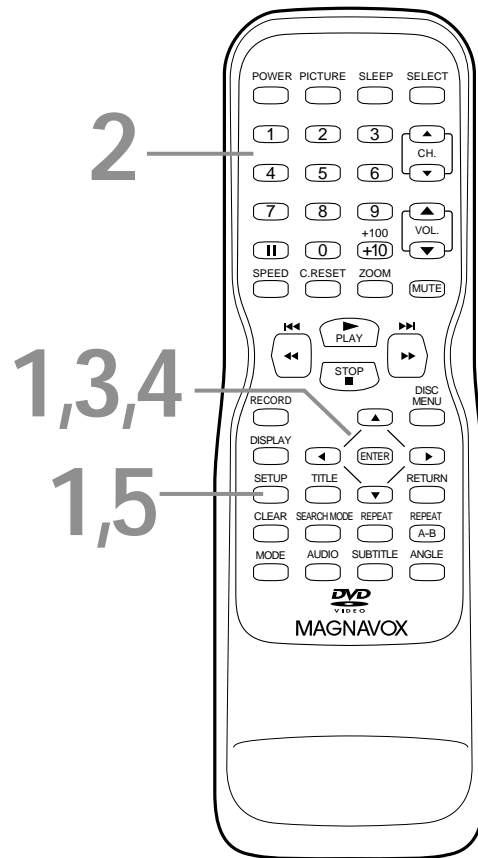

TV Rating Explanations

- TV-Y - Appropriate for all children
- TV-Y7 - Appropriate for children seven and older
- TV-G - General Audience
- TV-PG - Parental Guidance suggested.
- TV-14 - Unsuitable for children under 14
- TV-MA - Mature audience only

42 Setting V-Chip (TV) (cont'd)

V-Chip Subratings

You can select subratings for TV-Y7, TV-PG, TV-14, or TV-MA.

- Before you begin, press SELECT to put the TV/VCR/DVD in TV/VCR mode. The red VCR/TV light will appear on the front of the TV/VCR/DVD.

1 Press **SETUP**.

2 Press **▲** or **▼** to select **V-CHIP SET UP**. Press **▶**.

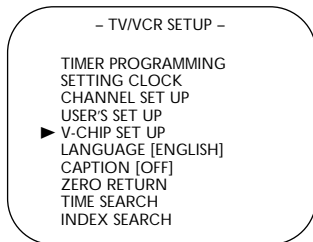

3 Press the **Number** buttons to enter the access code. The default code is 0000 (if you have not set up your own code yet).

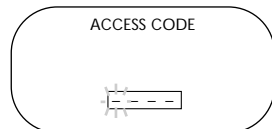

4 Press **▲** or **▼** to select **TV RATING**. Press **▶**.

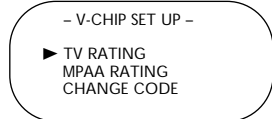

5 Press **▼** to select the rating you wish to adjust. Then, press **▶** twice to go to its subratings.

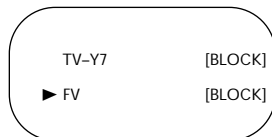

Example: TV-Y7 subratings

- **When you select TV-Y7:** Press **▲** or **▼** to select FV (Fantasy Violence, violence that seems realistic to young children). Then, press **▶** to select BLOCK or VIEW.
- **When you select TV-PG, TV-14, or TV-MA:** Press **▲** or **▼** to select "D" (Suggestive Dialog), "L" (Coarse Language), "S" (Sexual Situation), or "V" (Violence). Then, press **▶** repeatedly to select BLOCK or VIEW.

6 Press **SETUP** to save your settings.

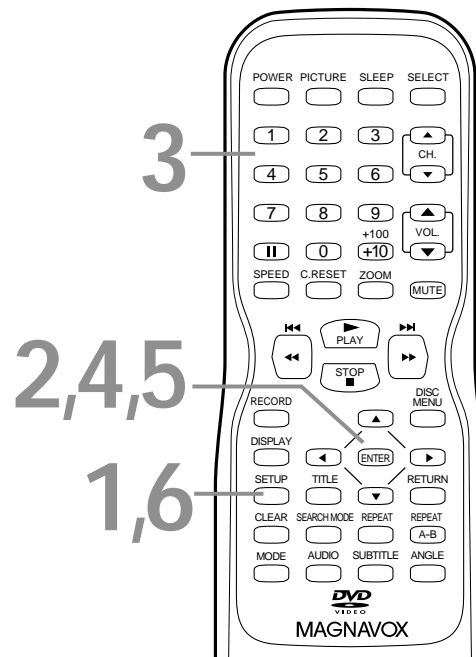

Helpful Hints

- When you select TV-MA, "D" for dialog is not an available subrating.
- Blocked subratings will appear beside the rating category in the TV ratings menu.
- To change the rating, you must select a TV channel that is not protected. If PROTECTED appears on the screen, change to a channel that is not protected (blocked).
- You cannot BLOCK a subrating (D, L, S, or V) if the main category is set to VIEW. However, you can set a subrating to VIEW even when the main category is set to BLOCK.
- Changing the category to BLOCK or VIEW automatically changes all its subratings to the same (BLOCK or VIEW).

Setting V-Chip (TV) (cont'd) 43

MPAA Rating Settings

You can block TV channel viewing according to the Motion Picture Association ratings. To do so, follow these steps.

- Before you begin, press SELECT to put the TV/VCR/DVD in TV/VCR mode. The red VCR/TV light will appear on the front of the TV/VCR/DVD.

1 Press **SETUP**.

2 Press **▲** or **▼** to select **V-CHIP SET UP**. Then, press **▶**.

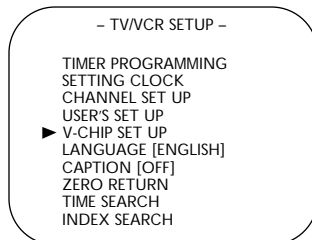

3 Press the **Number** buttons to enter the access code. (The default code is 0000 if you have not set up your own code yet.)

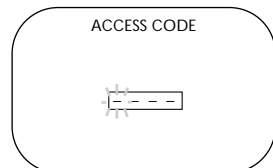

4 Press **▲** or **▼** to select **MPAA RATING**. Then, press **▶**.

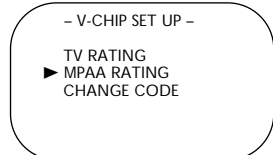

5 Press **▲** or **▼** to select the level at which you want to block viewing. Then, press **▶** to select **BLOCK** or **VIEW**.

When you Block a category, higher ratings turn to BLOCK automatically. Lower ratings turn to VIEW automatically.

When you set G to VIEW or BLOCK, all ratings turn to VIEW or BLOCK automatically.

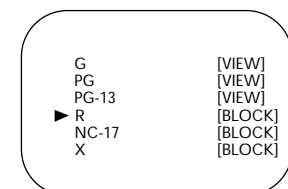

6 Press **SETUP** to save your settings.

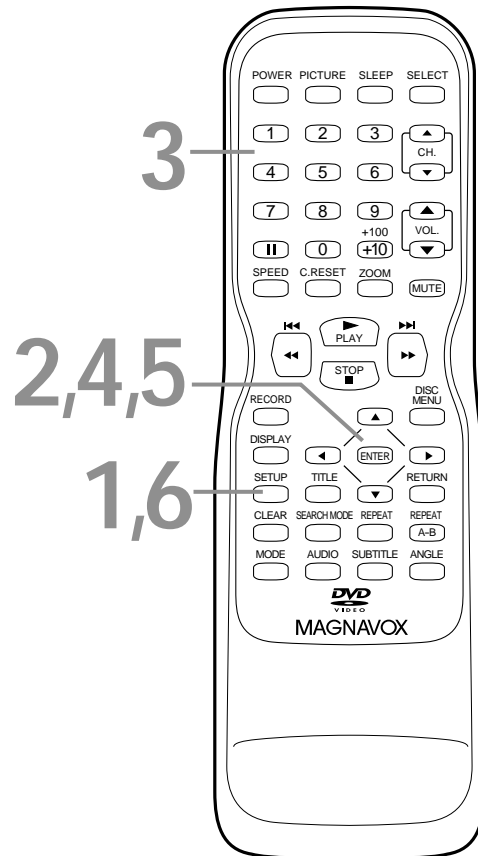

MPAA Rating Explanations

- G - General Audience
- PG - Parental Guidance suggested.
- PG-13 - Unsuitable for children under 13
- R - Restricted; under 17 requires accompanying parent or adult guardian
- NC-17 - No one under 17 admitted
- X - Mature audience only

44 Setting V-Chip (TV) (cont'd)

Changing the Access Code

Although the default code 0000 is supplied with the TV/VCR/DVD, you can set your own access code.

- Before you begin, press SELECT to put the TV/VCR/DVD in TV/VCR mode. The red VCR/TV light will appear on the front of the TV/VCR/DVD.

- 1 Press **SETUP**.
- 2 Press **▲** or **▼** to select **V-CHIP SET UP**. Then, press **▶**.
- 3 Press the **Number** buttons to enter the old access code. When doing this for the first time, use 0000.

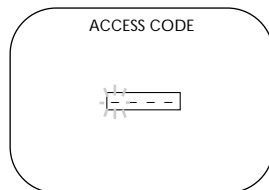

- 4 Press **▲** or **▼** to select **CHANGE CODE**. Then, press **▶**.

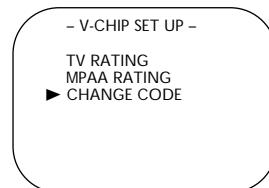

- 5 Press the **Number** buttons to enter your desired access code in the **NEW CODE** space. Then, enter the same code in the **CONFIRM CODE** space.

The V-CHIP SET UP screen will reappear.

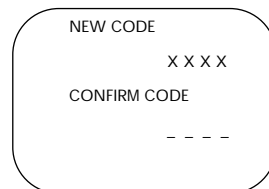

- 6 Press **SETUP** to save your settings.

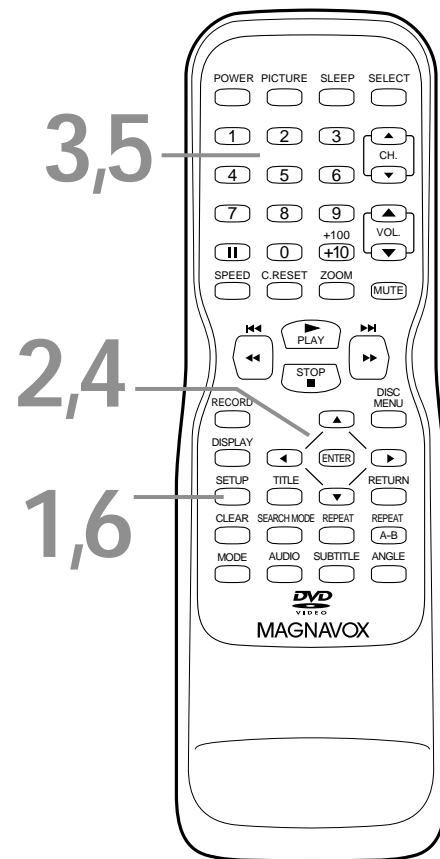

Helpful Hints

- If you enter the wrong code in the **CONFIRM CODE** space, repeat step 5. Enter the same new code exactly in the **CONFIRM CODE** space.
- If you unplug the power cord or if the power fails, the default code will be active again (0000). Change your access code again as necessary.

Multi-Channel Television Sound 45

- 1** While watching a TV channel, press **DISPLAY** twice to see the sound status in the top right corner of the screen.

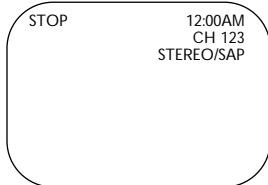

- When a program is broadcast in stereo, STEREO appears on the right side of the screen.
- When a program is broadcast in second audio, SAP appears on the right side of the screen.
- When a program is broadcast both in stereo and second audio, STEREO and SAP both appear on the screen.
- Although a program may be broadcast in both stereo and second audio, you cannot record in both stereo and second audio at the same time.
- During tape playback, HiFi will appear in the top left corner of the screen if VCR AUDIO is set to HiFi. *Details are on page 46.*
- If you play non-HiFi tapes while VCR AUDIO is set to HiFi, HiFi will disappear from the screen. The TV/VCR/DVD will play the videotape in monaural sound automatically.
- You must set the TV/VCR/DVD to record in either STEREO or SAP. Do this by changing the TV AUDIO setting as described on page 47.

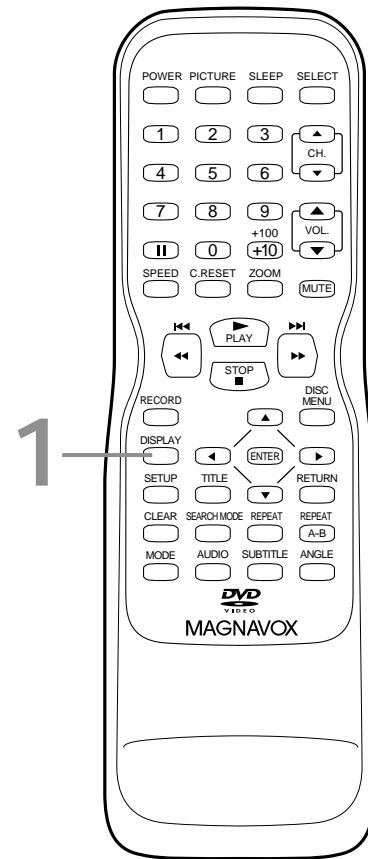

SAP	Second Audio Program: Your program can be received in a second language or as a radio station.
HiFi	High Fidelity: Produces better sound than standard stereo.

46 Multi-Channel Television Sound (cont'd)

Selecting HiFi or Monaural Sound

You can set the TV/VCR/DVD to play videotapes in either High Fidelity (HIFI) or Monaural (MONO or single-channel) sound. To do so, follow these steps.

- 1 Press **SETUP**.
- 2 Press **▲** or **▼** to select **USER'S SET UP**. Then, press **▶**.

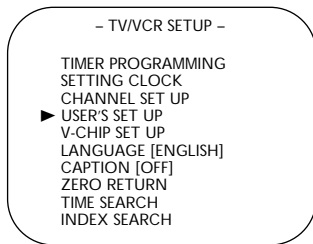

- 3 Press **▲** or **▼** to select **VCR AUDIO**.

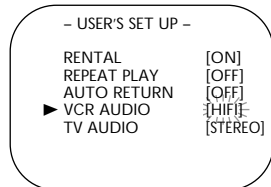

- 4 Press **◀** or **▶** to select **MONO** or **HIFI**.

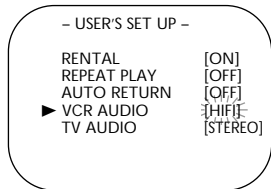

- 5 Press **SETUP** to remove the menus.

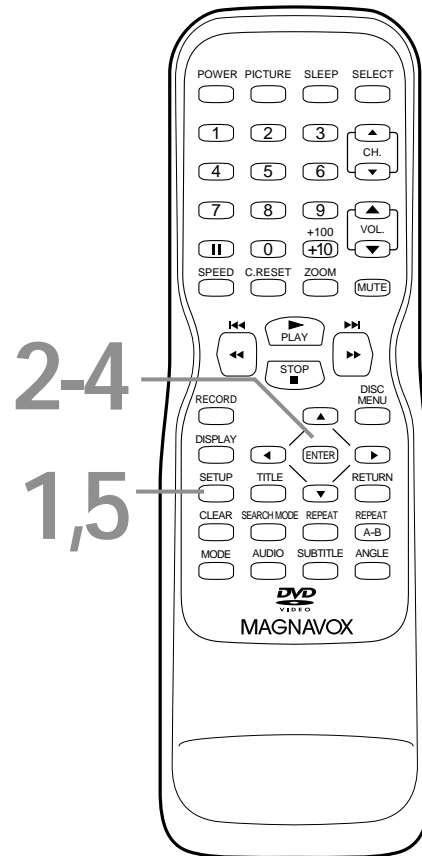

Helpful Hints

- Normally, select HIFI for playback with HiFi sound.
- Non-HiFi tapes will play in monaural sound automatically.
- MTS broadcasts automatically record in HiFi unless you select SAP before recording.

Multi-Channel Television Sound (cont'd) 47

Setting the TV/VCR/DVD to receive or record in Stereo, Second Audio, or Monaural Sound

Because TV channels can broadcast in Stereo or Second Audio, set the TV/VCR/DVD to receive and record the channels in the sound mode you prefer.

- 1 Press **SETUP**. Press **▲** or **▼** to select **USER'S SET UP**. Then, press **▶**.

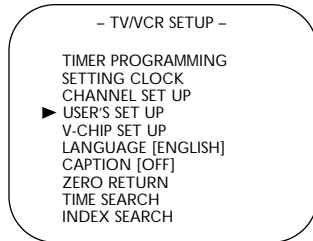

- 2 Press **▲** or **▼** to select **TV AUDIO**.

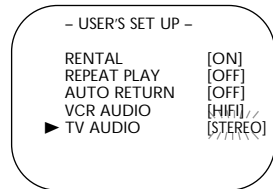

- 3 Press **◀** or **▶** until **STEREO**, **SAP**, or **MONO** appears.

- 4 Press **SETUP** to remove the menus.

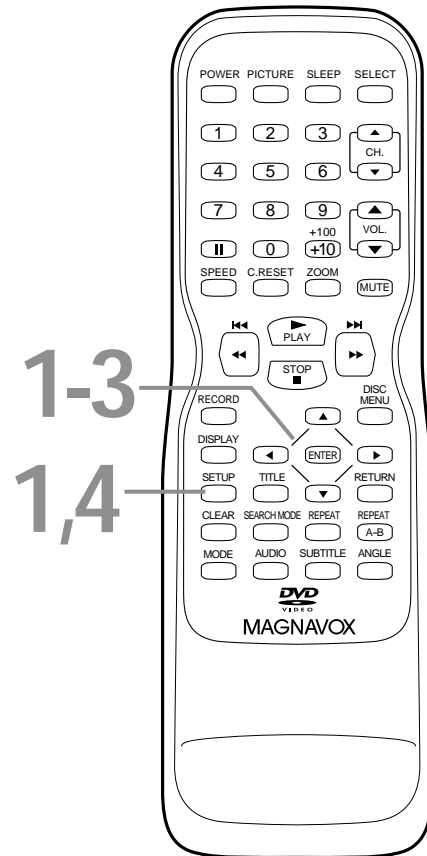

Helpful Hint

- If you select second audio when second audio is not available, the TV/VCR/DVD will record normal audio.

48 Disc Menus, Title Menus (DVDs)

Disc Menus

Some DVDs contain menus that describe the contents of the DVD or allow you to customize DVD playback. For example, the menu may offer choices for subtitle languages, special features, or scene selection. To use the DVD Disc Menu and select playback features, follow these steps.

- Before you begin, press **SELECT** to put the TV/VCR/DVD in DVD mode. The green DVD light will appear on the front of the TV/VCR/DVD.

- 1 Press **DISC MENU**. The DVD's Disc menu will appear.
- 2 Press **▲▼◀▶** to select an item, then press **ENTER**. Continue this process to set up all the features you want or to start Disc playback.

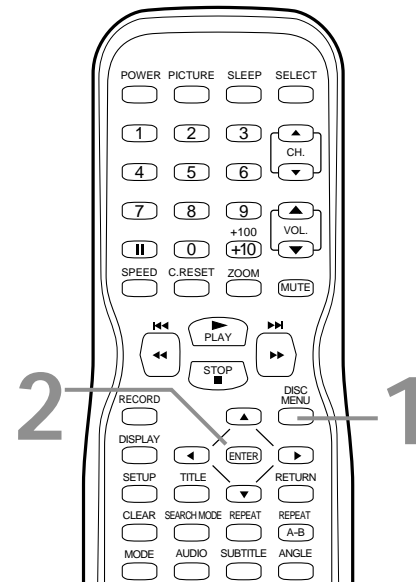

Title Menus

Some DVDs have a Title Menu, which lists the Titles available on the DVD. Use the Title Menu to start playback at a specific Title.

- Before you begin, press **SELECT** to put the TV/VCR/DVD in DVD mode. The green DVD light will appear on the front of the TV/VCR/DVD.

- 1 Press **TITLE**. The Title Menu will appear. If a Title menu is not available, the symbol may appear on the screen. Or, if the DVD only has a main Disc menu as described above, it may appear when you press TITLE.
- 2 Press **▲▼◀▶** to select the desired Title, then press **ENTER**. Playback will begin at the Title you selected.

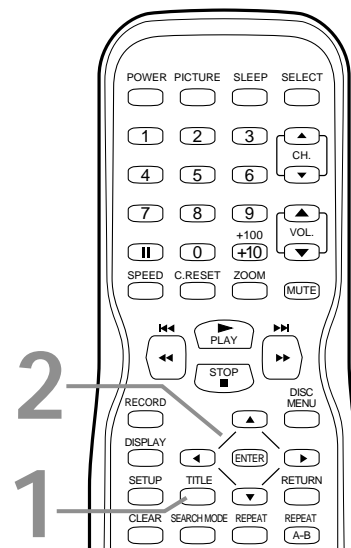

Helpful Hints

- Menus vary among DVDs. Follow the information with the DVD.
- Not all DVDs have Title menus.
- Some DVDs may refer to Chapters as "scenes." Some DVDs may refer to the Title Menu as the "scene index."

Fast Forward/Reverse Search (Discs) 49

- Before you begin, press SELECT to put the TV/VCR/DVD in DVD mode. The green DVD light will appear on the front of the TV/VCR/DVD.

1 During playback, press and hold **▶▶▶** / **▶▶▶** or **◀◀◀** / **◀◀◀** on the remote for two seconds.

- During DVD playback, pressing and holding **▶▶▶** / **▶▶▶** or **◀◀◀** / **◀◀◀** repeatedly will forward or reverse the picture at twice, eight times, 30 times, or 60 times the normal playback speed.

An **◀◀◀** x2, **◀◀◀** x8, **◀◀◀** x30, or **◀◀◀** x60 will appear briefly on the screen to indicate reverse searching. Or, **▶▶▶** x2, **▶▶▶** x8, **▶▶▶** x30, or **▶▶▶** x60 will appear briefly on the screen to indicate fast forward searching.

Sound will be muted during searching.

- During Audio CD playback, you may search forward or backward only at 16 times the normal playback speed. An **◀◀◀**x16 or **▶▶▶**x16 will appear briefly on the screen. Pressing and holding **▶▶▶** / **▶▶▶** or **◀◀◀** / **◀◀◀** repeatedly will not affect the speed of the search. Sound will be intermittent during searching on an Audio CD.
- Press and hold **▶▶▶** / **▶▶▶** for a forward search. Press and hold **◀◀◀** / **◀◀◀** for a reverse search.

Example: Playing a DVD in reverse at twice the normal playing speed.



Example: Fast forwarding a DVD at twice the regular playback speed.



Example: Fast forwarding an Audio CD at 16 times the regular playback speed.



2 Press **▶** to return to normal playback.

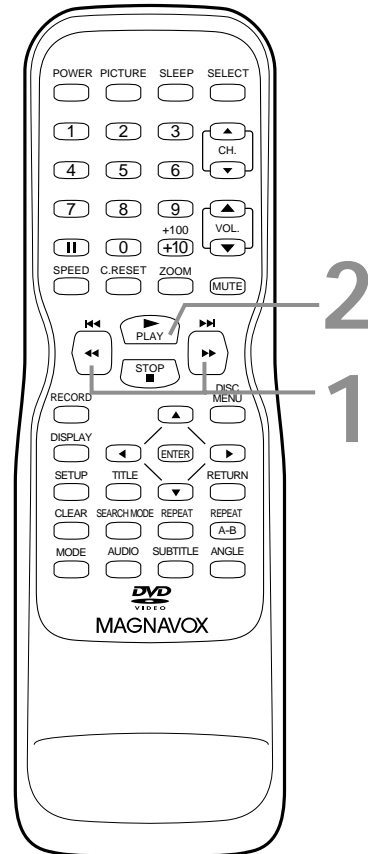

50 Specific Title/Chapter Playback (DVDs)

- Before you begin, press SELECT to put the TV/VCR/DVD in DVD mode. The green DVD light will appear on the front of the TV/VCR/DVD.

- 1 With a DVD in the TV/VCR/DVD, press **SEARCH MODE** once. The Title/Chapter Search display will appear on the screen.

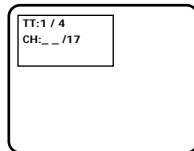

- 2 To select Title, press **▲** to select the Title space (beside TT), then press the **Number** buttons to enter the Title number. Complete this within 30 seconds. The Chapter space (beside CH) will be selected automatically.

- 3 Within 30 seconds, press the **Number** buttons to enter the Chapter number. In a few seconds, the selected Chapter will start playing.

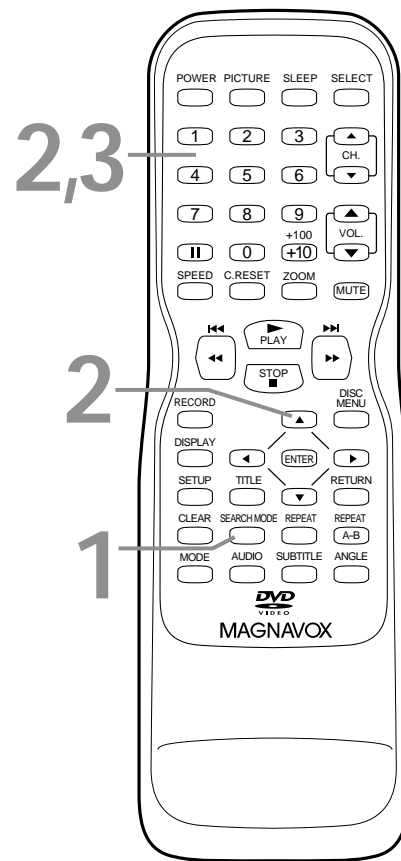
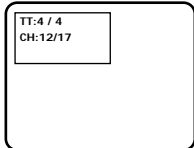

Helpful Hints

- Specific Title/Chapter playback is not available with some DVDs.
- Press **▶▶ / ▶▶** during playback to skip to the next Chapter quickly.
- Press **◀◀ / ◀◀** briefly to return to the beginning of the current Chapter during playback. Press **◀◀ / ◀◀** repeatedly to go to previous Chapters during playback.
- Enter a zero before a single-digit Chapter or Title number.

Specific Time Playback (Discs) 51

- Before you begin, press SELECT to put the TV/VCR/DVD in DVD mode. The green DVD light will appear on the front of the TV/VCR/DVD.

- 1** During playback, press SEARCH MODE repeatedly so the Time Search display appears on the screen.

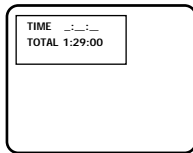

- 2** Within 30 seconds, use the Number buttons to enter the elapsed playing time at which you want playback to begin. Enter the time in hours, minutes, and seconds. Within a few seconds, playback will start at the specified time.

- Example: 1 hour, 23 minutes, and 30 seconds
1 → 2 → 3 → 3 → 0
- Make sure the time you enter is within the total time of the current Title or Track. If it is not, the TIME space will clear and playback will continue at its current point.
- If you make a mistake, press CLEAR to erase all the information in the TIME space. Enter the correct information.

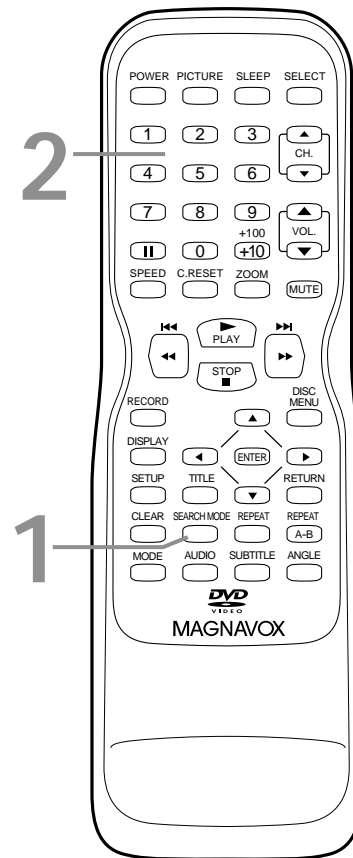

52 Specific Track Playback (Audio CDs)

There are three ways to begin playback on an Audio CD at a specific Track: Use the Number buttons, the SEARCH MODE button, or **⏮ / ⏪** or **⏩ / ⏭**.

- Before you begin, press **SELECT** to put the TV/VCR/DVD in DVD mode. The green DVD light will appear on the front of the TV/VCR/DVD.

1

Using the Number Buttons to Select a Track

During playback or when playback is stopped, press the Number buttons to enter the desired Track number.

Playback will start at the selected Track.

For single-digit Tracks (1-9), press a single Number button.

For Tracks 10 and above, press the +100/+10 button so the Search display (TR: _ _) appears on the screen. Within 30 seconds, press the Number button of the first digit, then press the Number button of the second digit. For example, to play Track 26, press +100/+10, then Number 2, then Number 6.

If you enter a Track number that is not available on the Disc, playback will not begin (or the current Track will continue to play). The Search display (TR: _ _) will disappear automatically.

2

Using SEARCH MODE to Select a Track

Press **SEARCH MODE** once so the Track Search display appears. Within 30 seconds, press the Number buttons to select the Track number you desire. Playback will begin at the selected Track. For a single-digit Track (1-9), enter a zero first. For example, to play Track 5, press 0, 5. (You do not have to use the +100/+10 button for Tracks 10 and above in this situation.) If you enter a Track number that is not available, playback will not begin (or the current Track will continue to play). The space beside TR will clear automatically in the Search display.

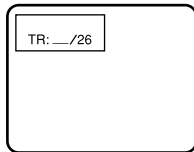

3

Using **⏮ / ⏪** or **⏩ / ⏭** to Select a Track

During playback, press **⏩ / ⏭** to skip the current Track and move to the next Track. The Track number will appear briefly on the screen.

During playback, press **⏮ / ⏪** to return to the beginning of the current Track. Press **⏮ / ⏪** repeatedly to go to previous Tracks. The Track number will appear briefly on the screen.

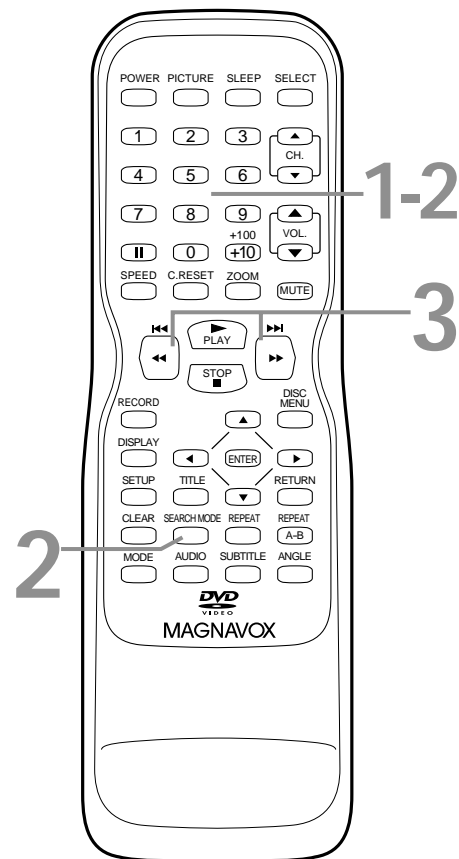

Helpful Hints

- You cannot use **⏩ / ⏭** to go from the last Track on the Disc to the first Track.
- If you press **⏩ / ⏭** or **⏮ / ⏪** when playback is paused, the selected Track will begin playing automatically.

Paused/Step-by-Step Playback, Resume (Discs) 53

Paused/Step-by-Step Playback

- Before you begin, press SELECT to put the TV/VCR/DVD in DVD mode. The green DVD light will appear on the front of the TV/VCR/DVD.

- 1** During playback, press **||**. Play will pause and the sound will be muted.
- 2** When playing a DVD, press **||** repeatedly to see the picture advance one frame (or step) at a time. The sound will remain mute. Pressing **||** repeatedly during Audio CD playback will have no effect.
- 3** Press **▶** to resume playback.

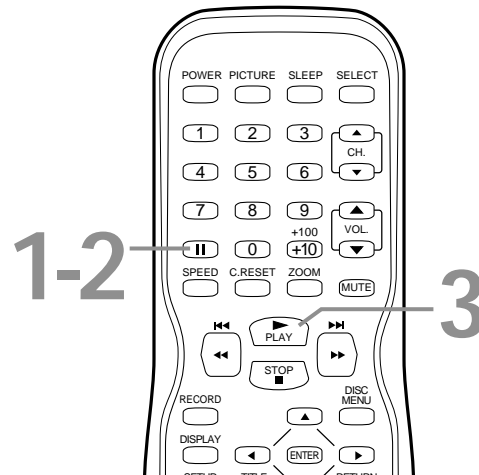

Resume

- Before you begin, press SELECT to put the TV/VCR/DVD in DVD mode. The green DVD light will appear on the front of the TV/VCR/DVD.

- 1** Press **■** during Disc playback. In a few seconds, the following Resume message will appear on the screen.

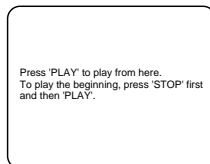

- 2** Press **▶**. In a few seconds, playback will resume from the point at which playback stopped last. You can resume play at the same point even if you turn off the TV/VCR/DVD, then turn it on again later. However, opening the disc tray will cancel the Resume feature.

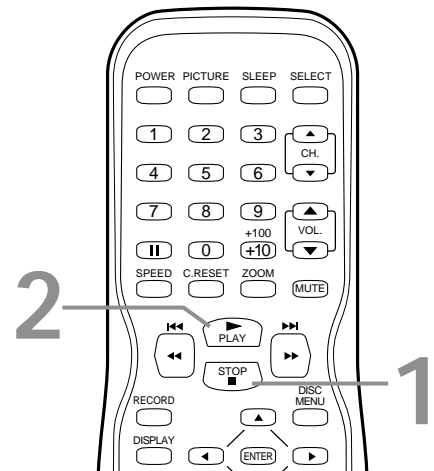

Helpful Hint

- To cancel resume playback and start playing the Disc from the beginning, press STOP **■** a second time while playback is stopped. The Stop symbol (■) will appear in the top right corner of the screen. Press PLAY **▶** to start playing the Disc from the beginning.

54 Repeat, A-B Repeat (Discs)

Repeat

- Before you begin, press **SELECT** to put the TV/VCR/DVD in DVD mode. The green DVD light will appear on the front of the TV/VCR/DVD.

- 1 During Disc playback, repeatedly press **REPEAT** until the repeat mode you want appears on the screen as shown in the examples below.
On a DVD, press **REPEAT** repeatedly to select **REPEAT [CHAPTER]**, **REPEAT [TITLE]**, or **REPEAT [OFF]**.
On an Audio CD, press **REPEAT** repeatedly to select **REPEAT [TRACK]**, **REPEAT [ALL]**, or **REPEAT [OFF]**.
Selecting a new Chapter, Title, or Track will cancel repeat playback.



Example: Repeat a DVD Chapter

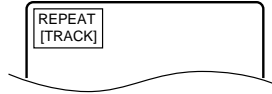

Example: Repeat an Audio CD Track

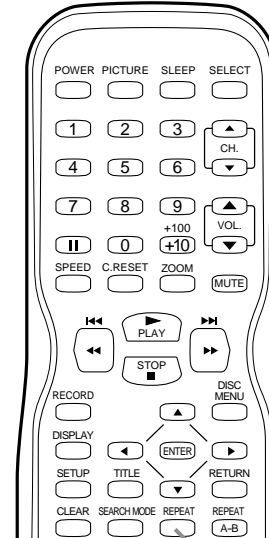

A-B Repeat

Follow these steps to play a section of a Disc repeatedly.

- Before you begin, press **SELECT** to put the TV/VCR/DVD in DVD mode. The green DVD light will appear on the front of the TV/VCR/DVD.

- 1 Press **PLAY** ► to play the Disc to the point at which you want repeated playback to begin.
- 2 Press **REPEAT A-B** to set the starting point (A). **REPEAT [A -]** will appear on the screen briefly.

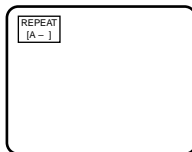

- 3 Play or fast forward the Disc to the point at which you want repeated playback to end, then press **REPEAT A-B** again. **REPEAT [A-B]** will appear on the screen. The section will begin to play repeatedly.

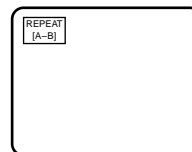

- 4 To cancel A-B Repeat, press **REPEAT A-B** so **REPEAT [OFF]** appears on the screen. Regular playback will resume.

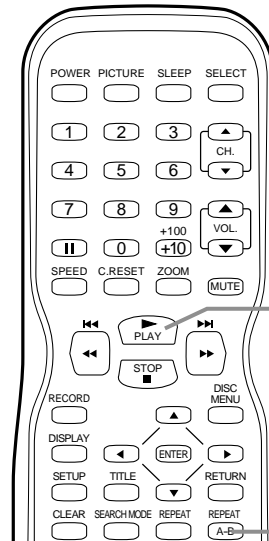

Helpful Hints

- Repeat playback and A-B Repeat are not available with all Discs.
- The entire A-B Repeat section must be within a single Title or Track. If you do not enter Point B before the end of the Track or Title is reached, the end of the Track or Title will become Point B automatically.
- Point B must be later on the Disc than Point A.
- Pressing **STOP** ■ will cancel A-B Repeat.

Markers (Discs) 55

Use Markers to remember your favorite places on a Disc. To set the Markers, follow these steps.

- Before you begin, press **SELECT** to put the TV/VCR/DVD in DVD mode. The green DVD light will appear on the front of the TV/VCR/DVD.

- 1 Play the Disc to within 30 seconds prior to the point at which you want to set the Marker. **During playback, press SEARCH MODE three times.** The Markers will appear at the top of the screen for 30 seconds.

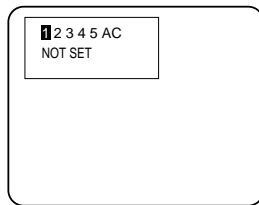

- 2 Within 30 seconds, press **◀** or **▶** to select 1, 2, 3, 4, or 5. Make sure "NOT SET" appears beneath the number when selected.

- 3 Let the Disc continue to play to the point at which you want to set the Marker (up to 30 seconds).

When the Disc reaches the point you want to remember, press **ENTER**. The Title and elapsed playing time (DVD) or Track and its elapsed playing time (Audio CD) will appear in the display.

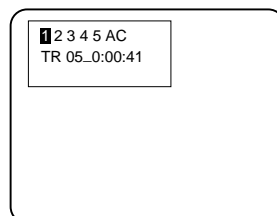
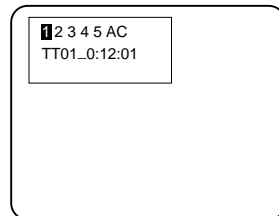

- 4 To return to the Marker later, press **SEARCH MODE** three times during playback. Press **◀** or **▶** to choose the Marker you want, then press **ENTER**. Disc play will continue from the marked point.

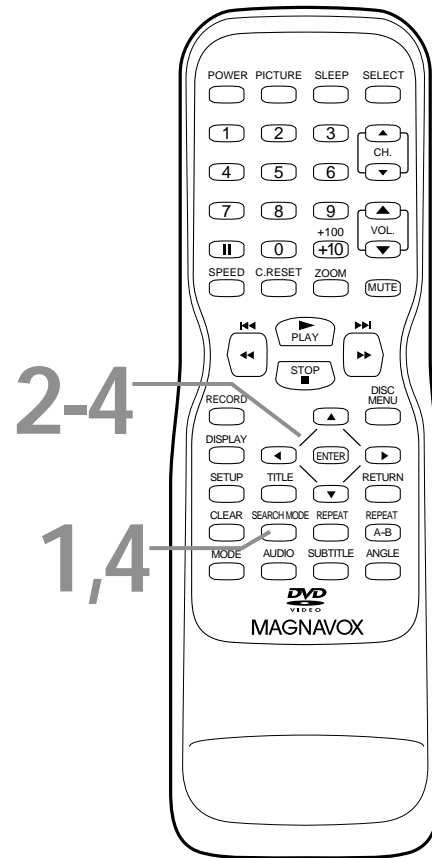

Helpful Hints

- Opening the disc tray or turning off the TV/VCR/DVD will erase all the Markers.
- To erase a single Marker, press **SEARCH MODE** three times, then press **◀** or **▶** to select the Marker number. Press **CLEAR**. **NOT SET** will appear on the display. Press **RETURN** or **SEARCH MODE** to remove the display.
- To erase all the Markers, press **SEARCH MODE** three times, then press **▶** repeatedly to select **AC** (all clear). Press **ENTER**. Press **SEARCH MODE** to remove the display.

56 Subtitles, Camera Angles (DVDs)

Subtitles

You can select a language for DVD subtitles during playback. You can select only languages that are available on the DVD.

- Before you begin, press **SELECT** to put the TV/VCR/DVD in DVD mode. The green DVD light will appear on the front of the TV/VCR/DVD.

- 1 Press **SUBTITLE** during playback so the subtitle display appears on the screen.
- 2 Within five seconds, press **SUBTITLE** repeatedly to select a subtitle language. After a few seconds, the subtitles will appear. The number of available languages appears at the right of the subtitle display. In the example below, eight languages are available (/ 8). The language may be abbreviated, such as ENG for English.

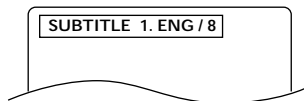

- 3 To turn off Subtitles, press **SUBTITLE** repeatedly until **SUBTITLE OFF** appears.

Camera Angles

Some DVDs contain scenes recorded from different angles. You may select a camera angle during playback.

- Before you begin, press **SELECT** to put the TV/VCR/DVD in DVD mode. The green DVD light will appear on the front of the TV/VCR/DVD.

- 1 Press **ANGLE** during playback so the Angle display appears on the screen.
- 2 Within five seconds, press **ANGLE** repeatedly to select a different angle. The number of available angles appears at the right of the Angle display. In this example, eight angles are available (/ 8).

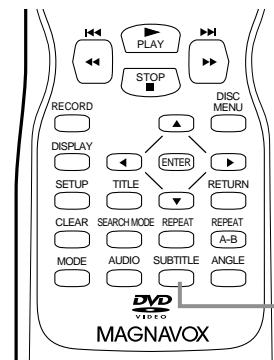

1-3

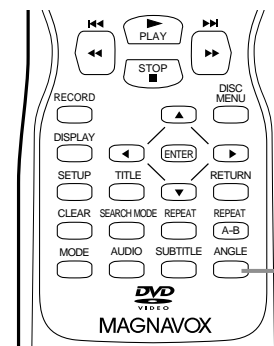

1-2

Helpful Hints

- On some DVDs, you must select subtitles in the Disc menu.
- If the desired language does not appear after pressing **SUBTITLE** several times, the Disc does not have subtitles in that language.
- Opening the disc tray will cancel your subtitle setting.
- If the current segment of the Disc has multiple camera angles,  will appear on the screen. **ANGLE ICON** must be ON. Details are on page 68.
- The camera angle will not change if the DVD does not contain sequences recorded from different camera angles.

Slow Motion, Zoom (DVDs) 57

Slow Motion

- Before you begin, press **SELECT** to put the TV/VCR/DVD in DVD mode. The green DVD light will appear on the front of the TV/VCR/DVD.

- 1 During playback, press **||**.
- 2 Press and hold **▶▶▶ / ▶▶▶** for two seconds. Slow motion playback will begin. Press and hold **▶▶▶ / ▶▶▶** repeatedly to vary the speed of slow motion playback. You may play the DVD at 1/16, 1/8, or 1/2 the normal playback speed; **▶x1/16**, **▶x1/8**, or **▶x1/2** will appear on the screen.



- 3 Press **▶** to return to normal playback.

Zoom

You can enlarge the DVD picture to twice or four times the regular size.

- Before you begin, press **SELECT** to put the TV/VCR/DVD in DVD mode. The green DVD light will appear on the front of the TV/VCR/DVD.

- 1 Press **ZOOM** during playback. **ZOOM [x2]** will appear on the screen. The picture will be twice as large as normal. Press **ZOOM** again to increase the picture to four times the regular size. **ZOOM [x4]** will appear on the screen.

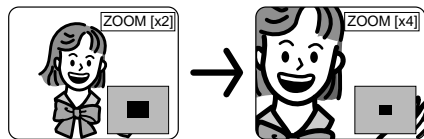

- 2 Press **▲▼◀▶** to move the zoomed image up, down, left, or right.

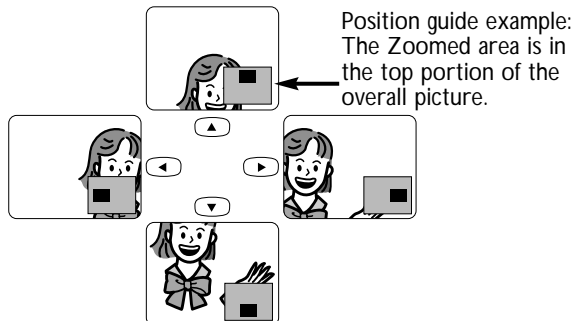

- 3 To return the picture to its normal size, press **ZOOM** so **ZOOM [OFF]** appears on the screen.

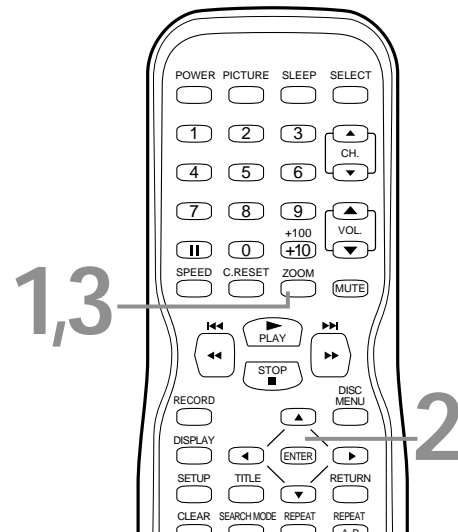
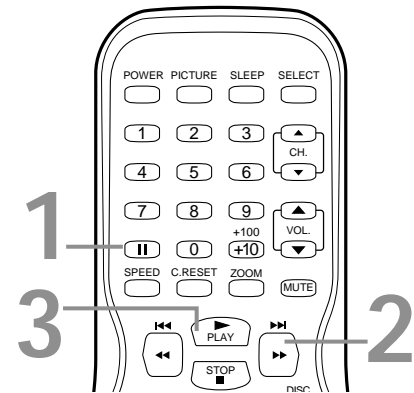

Helpful Hints

- The sound will be mute during slow motion playback.
- You cannot play a DVD in reverse slow motion.
- The gray box with an inner blue box that shows during Zoomed playback is the position guide. To remove it or show it, press **ENTER**. The position of the blue box inside the gray box indicates the position of the zoomed image within the overall picture.

58 Parental Controls Password (DVDs)

Parental Controls blocks viewing of DVDs that exceed the limits you set. This feature will not limit viewing if the DVD maker did not code the DVD. So, make sure your DVDs play according to your settings before you allow children access to the TV/VCR/DVD. Follow the steps below to change your Parental Controls password.

- Before you begin, press **SELECT** to put the TV/VCR/DVD in DVD mode. The green DVD light will appear on the front of the TV/VCR/DVD.

1 While playback is stopped, press **SETUP** twice.

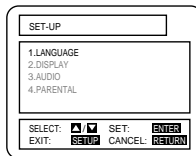

2 Press the Number 4 button to select **PARENTAL**. The SET-UP PARENTAL CONTROLS PASSWORD menu will appear.

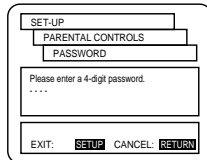

Example: First-time setting password

or

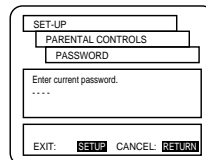

Example: Entering existing password

3 Press the Number buttons to enter your four-digit password. When doing this for the first time, enter any four digits, then press **ENTER**. That number will be used as the password from that point forward.

4 Press the Number 2 button to select **CHANGE**.

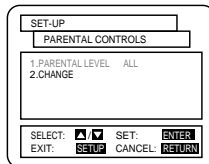

5 Press the Number buttons to enter your new four-digit password (which will appear on the screen), then press **ENTER**.

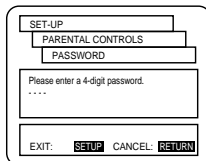

6 Press **SETUP** to remove the menu.

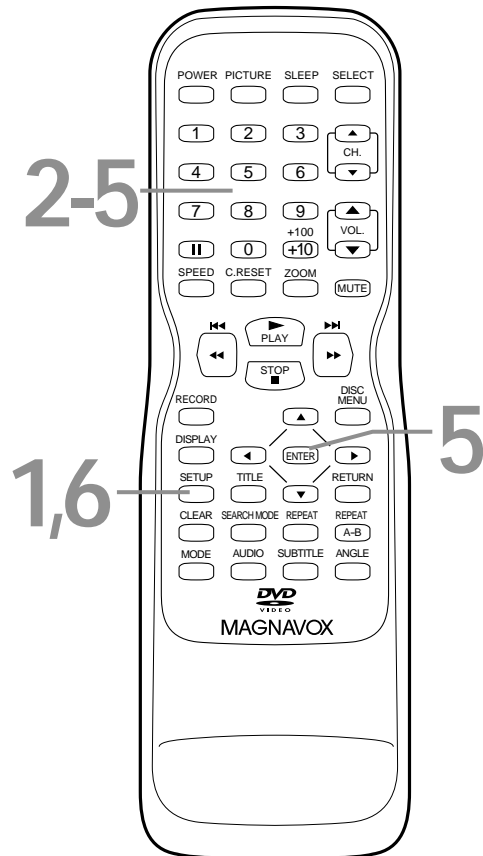

Helpful Hints

- If you forget the password, you can reset all of the Player's settings to the factory presets. Remove the Disc from the Player. When in DVD mode, press the Number buttons 1,2,3,4, then press the **DISPLAY** button. Then, press the Number button 3. "EEPROM CLEAR:OK" will appear and the original settings of the Player will be restored. Press the **SELECT** button to put the unit in TV/VCR mode, or turn off the unit.
- Write down your password in case you forget it.
- Asterisks (*) will appear instead of your password to protect the privacy of the password.
- The unit will retain the password after a power failure.

Parental Controls Levels (DVDs) 59

Follow these steps to set the rating level for your DVDs. DVDs whose ratings exceed the level you set will not play.

- Before you begin, press **SELECT** to put the TV/VCR/DVD in DVD mode. The green DVD light will appear on the front of the TV/VCR/DVD.

1 While playback is stopped, press **SETUP** twice.

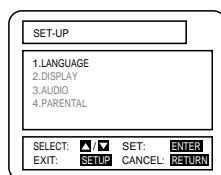

2 Press the Number 4 button to select **PARENTAL**. The SET-UP PARENTAL CONTROLS PASSWORD screen will appear.

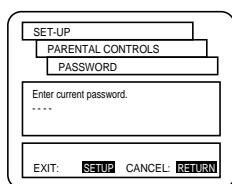

3 Press the Number buttons to enter your four-digit password. If your entry is incorrect, press **ENTER**, then enter the correct password as prompted by the on-screen message.

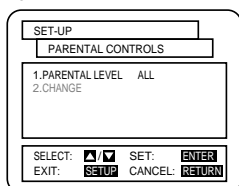

4 Press the Number 1 button to select **PARENTAL LEVEL**.

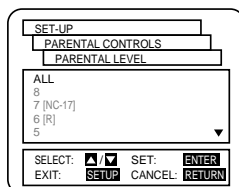

5 Press a Number button to select the level you desire. For example, if you want to play Discs rated PG-13, press the Number 4 button (press ▲ or ▼ to see all the rating levels). The level you select will appear on the screen beside PARENTAL LEVEL in the SET-UP PARENTAL CONTROLS screen. To play all ratings, select ALL. Press ▲ repeatedly to select ALL, then press **ENTER**.

6 Press **SETUP** to remove the menu.

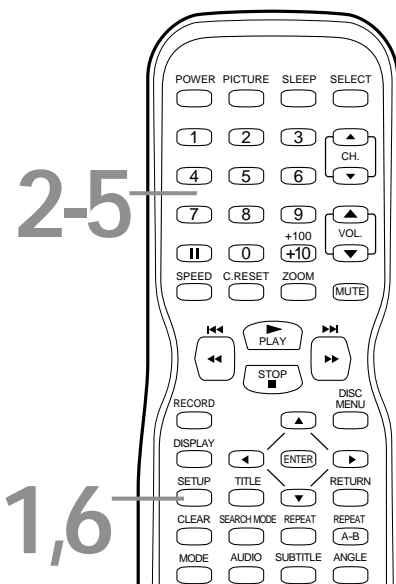

RATING EXPLANATIONS	required for viewers under 18.
• ALL - Parental Controls is inactive; all Discs can play.	• 4 - PG-13 - Unsuitable for children under 13
• 8 - Adult material	• 3 - PG - Parental Guidance suggested.
• 7 - NC-17 Not appropriate for children under 17	• 1 - G - General Audience; recommended for all ages.
• 6 - R - Restricted; parental approval	

Helpful Hints

- When you play a DVD whose rating exceeds the level you set, an on-screen message will indicate the DVD cannot play. Remove the DVD, then select a level that allows playback or select ALL to turn off Parental Controls. Reload the DVD and begin playback. Some DVDs may let you enter your four-digit password to begin playback. Refer to the DVD messages.
- Some DVDs are not compatible with Parental Controls. Make sure the DVD plays according to the Parental Controls settings you have made before you allow children access to the TV/VCR/DVD.
- You cannot change Parental Level settings until you enter the correct password.

60 Audio Language, Stereo Sound Mode (Discs)

Audio Language

You can select a language for DVDs during playback if multiple languages are available on the DVD.

- Before you begin, press **SELECT** to put the TV/VCR/DVD in DVD mode. The green DVD light will appear on the front of the TV/VCR/DVD.

- 1 During DVD playback, press **AUDIO** so the audio display appears on the screen.
- 2 Within five seconds, press **AUDIO** repeatedly to choose one of the available languages. The number of available languages appears at the right of the audio display. In this example, eight languages are available (/8).
The language may be abbreviated (such as ENG for English in this example). Other details about the available audio also may appear.

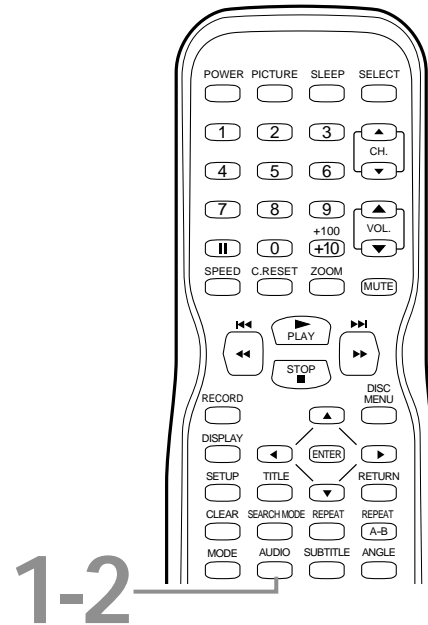
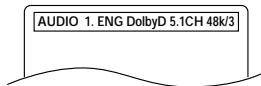

Stereo Sound Mode

When playing Audio CDs that are recorded in stereo (on the right and left channels), you can choose to hear the right, left, or both channels (stereo).

- Before you begin, press **SELECT** to put the TV/VCR/DVD in DVD mode. The green DVD light will appear on the front of the TV/VCR/DVD.

- 1 Press **AUDIO** repeatedly during playback to choose **AUDIO STEREO**, **AUDIO L-CH**, or **AUDIO R-CH**.

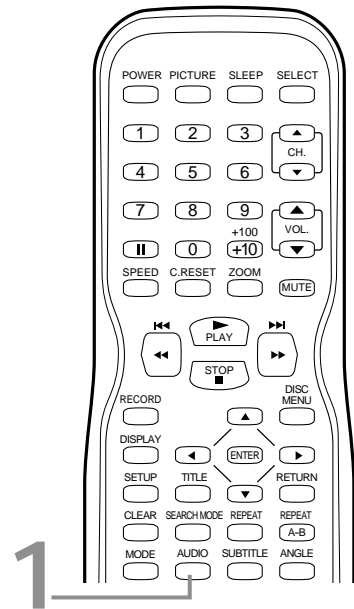
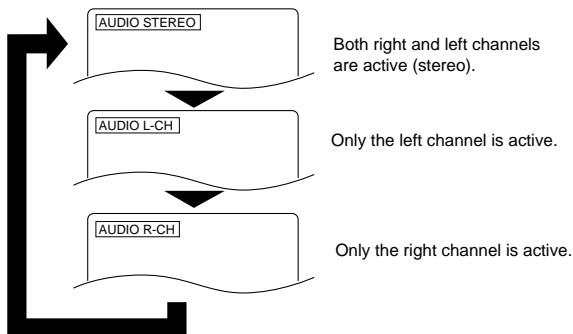

Helpful Hints

- If a desired audio language is not available after pressing **AUDIO** several times, the DVD does not have that language.
- Some DVDs only allow you to change the language in the Disc menu. Details are on page 48.

Random Playback, Programs (Audio CDs) 61

Random Playback

You may play the Tracks of an Audio CD in Random order instead of the order in which they are recorded (1,2,3...).

- Before you begin, press **SELECT** to put the TV/VCR/DVD in DVD mode. The green DVD light will appear on the front of the TV/VCR/DVD.

- 1 With play stopped, press **MODE** twice so the **RANDOM** screen appears.

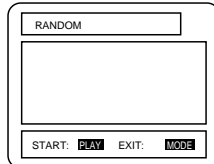

- 2 While the **RANDOM** screen appears, press **PLAY** ►. The Tracks will play in random order. Each Track will play once, then play will stop.

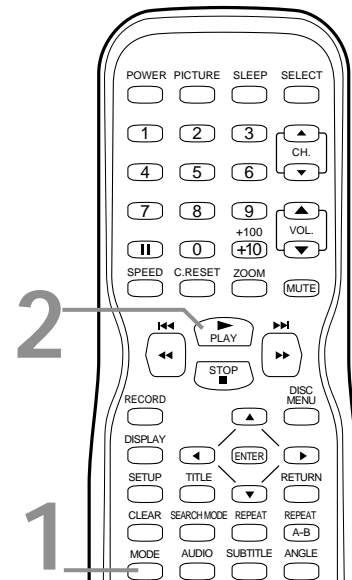

Programs

You may determine the order in which Tracks will play. The order you set is called the Program.

- Before you begin, press **SELECT** to put the TV/VCR/DVD in DVD mode. The green DVD light will appear on the front of the TV/VCR/DVD.

- 1 While play is stopped, press **MODE**. The **PROGRAM** screen will appear.

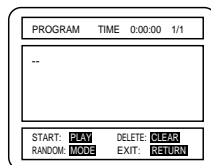

- 2 Press the **Number** buttons to enter the number of the first Track that you want to play.

- Press **CLEAR** to remove the last Track in a Program.
- Enter single-digit Tracks with one Number button. (For Track three, press the Number 3 button.)
- For Tracks 10 and above, press the **+100/+10** button, then the Number button for the first digit, then the Number button for the second digit. (To play Track 26, press **+100/+10**, then 2, then 6.)

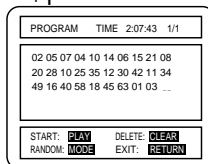

- 3 Repeat step 2 to enter all the Tracks you want in the Program. The total playing time of the Program appears beside **TIME** at the top of the screen.

- 4 Press **PLAY** ►. Each Track in the Program will play once, then play will stop.

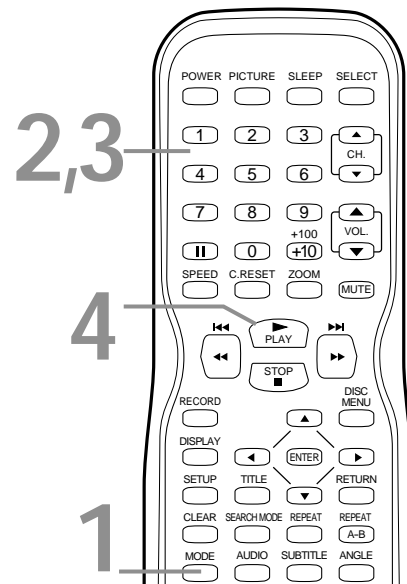

Helpful Hints

- You cannot select a specific Track to play or start random play during programmed play.
- During programmed playback, press **REPEAT** so **REPEAT [TRACK]** or **REPEAT [ALL]** appears. The current Track or the Program will play repeatedly.
- To see Tracks in the Program, press **MODE** during playback.
- Invalid Track numbers will be rejected and erased from the Program. Enter an available Track.
- Turning off the unit or opening the disc tray will erase the Program.

62 MP3 Playback

The TV/VCR/DVD will play MP3 files recorded on a CD-RW (Compact Disc-Rewritable) or CD-R (CD-Recordable).

- Before you begin, press **SELECT** to put the TV/VCR/DVD in DVD mode. The green DVD light will appear on the front of the TV/VCR/DVD.

- 1** Put a CD-RW or CD-R with MP3 files in the TV/VCR/DVD. Playback may start automatically. Press **STOP** ■ to stop play if necessary.
- 2** The MP3 menu will appear on the screen, listing the Tracks and Albums on the Disc. Press **▲** or **▼** to select the **Album** or **Track** you want to play. Or, choose **FIRST PLAY** to start playing all the Tracks, starting with the first Track listed. Or, press **TITLE** to return to the first item on the first MP3 screen.
- 3** If you chose a **Track** at step 2, press **PLAY** ► or **ENTER**. Tracks will play in the order they were recorded (1, 2, 3), starting with the Track you just selected.
If you chose an **Album**, press **ENTER**. (Albums have a "+" before the Album name.) The Tracks in the Album will list on the screen. Press **▲** or **▼** to select the **Track** you want to play, then press **PLAY** ► or **ENTER**.
- 4** To stop playback, press **STOP** ■.

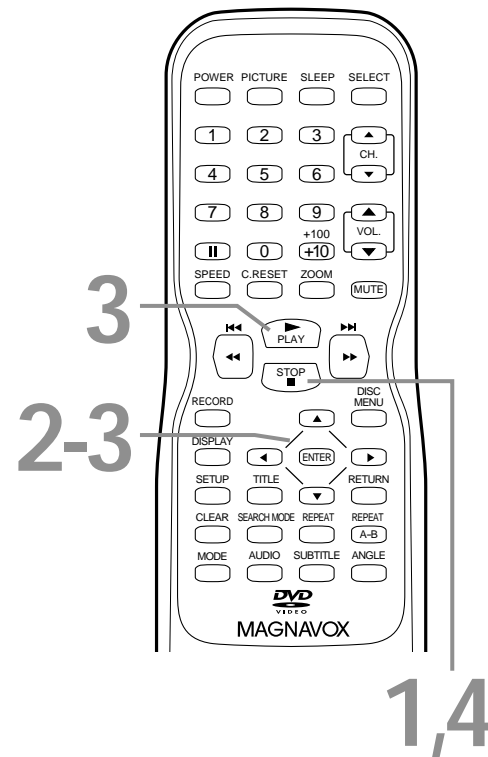

Helpful Hints

- Folders are known as *Albums*. Files are known as *Tracks*.
- If all the *Tracks* cannot appear on the screen at the same time, ▼ indicates more *Tracks* on the next screen; ▲ indicates previous screens. The current screen number and the total number of screens will appear in the lower right corner of the *Track/Album* list.
- A total of 255 *Albums* and *Tracks* can be recognized.
- Discs recorded in multi-session recordings will not play on this TV/VCR/DVD.
- Only *Tracks* having file names ending in *.mp3* will play.
- You can play MP3 files recorded at a minimum of 112 kbps.

MP3 Display Information, Track Selection 63

MP3 Display Information

You can review MP3 file information during playback.

- Before you begin, press **SELECT** to put the TV/VCR/DVD in DVD mode. The green DVD light will appear on the front of the TV/VCR/DVD.

1 Press **DISPLAY** during playback. The Album/Track list will appear. The current Track will show in yellow.

2 Press **DISPLAY** again. The elapsed playing time of the current Track will appear at the top of the screen.

 T indicates Track repeat

 A indicates Album repeat

 D indicates Disc repeat

3 Press **DISPLAY** again to remove the display.

MP3 Track Selection

- Before you begin, press **SELECT** to put the TV/VCR/DVD in DVD mode. The green DVD light will appear on the front of the TV/VCR/DVD.

1 Press **SEARCH MODE** during MP3 playback. The Album/Track list will appear. The current Track will be in yellow.



2 Press **▲** or **▼** to select a Track you want to play. Press **PLAY ▶** to start playing the Track. Or, press **▲** or **▼** to select an Album. Press **ENTER**, then press **▲** or **▼** to select a Track, then press **PLAY ▶**. The Album/Track list will disappear automatically.

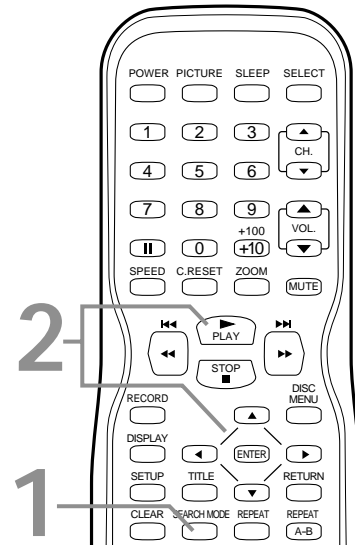
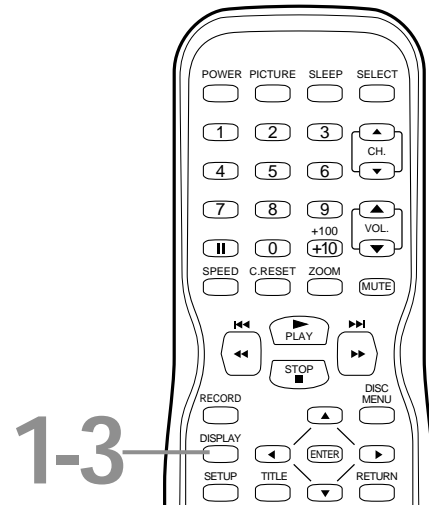

Helpful Hints

- During playback, press the Number buttons to play another Track immediately. Or, press **◀◀ / ◀◀** or **▶▶ / ▶▶** to move to previous or subsequent Tracks.
- If the Track you chose is not available or cannot be accessed,  will appear on the screen. Play may resume or continue at a different Track.
- Specific Time playback is not possible with MP3 files.

64 Random MP3 Playback, MP3 Programs

Random MP3 Playback

- Before you begin, press **SELECT** to put the TV/VCR/DVD in DVD mode. The green DVD light will appear on the front of the TV/VCR/DVD.

- While playback is stopped, press **MODE** twice. The **RANDOM** screen will appear.

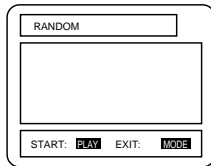

- Press **PLAY** ► to play the tracks in random order.

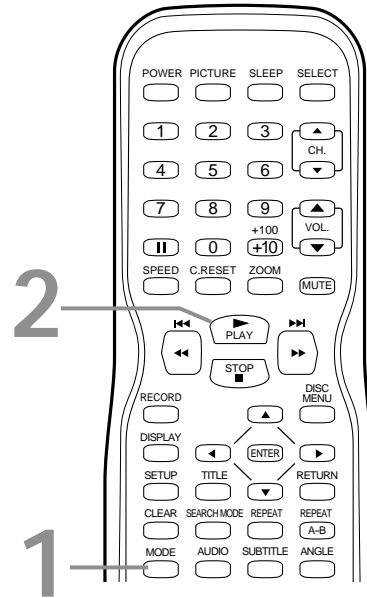

MP3 Programs

- Before you begin, press **SELECT** to put the TV/VCR/DVD in DVD mode. The green DVD light will appear on the front of the TV/VCR/DVD.

- While playback is stopped, press **MODE**. The **PROGRAM** screen will appear.

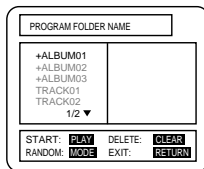

- Press **▲** or **▼** to select a Track, then press **ENTER** to save it in the Program. The programmed Track will appear on the right side of the screen. Press **▲** or **▼** to see additional Tracks. Repeat step 2 to enter all the Tracks you want. If the Track is within an Album, press **▲** or **▼** to select the Album, then press **ENTER**. Press **▲** or **▼** to choose the Track, then press **ENTER**.

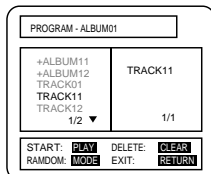

- Press **PLAY** ► to play the Program.

- Press **STOP** ■ to stop playing the Program.

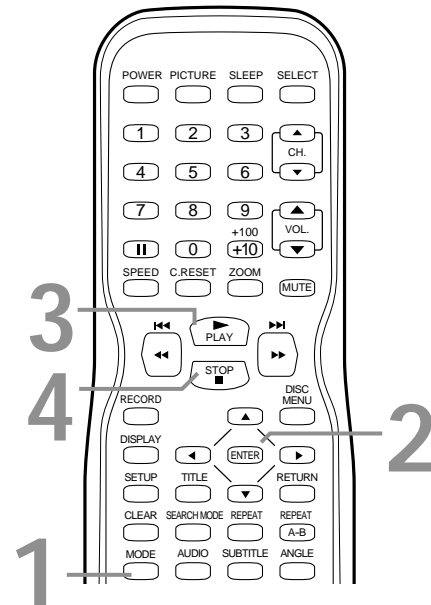

Helpful Hints

- Press **CLEAR** to delete the last item in the Program.
- Turning off the TV/VCR/DVD or opening the Disc tray will erase the Program.

Audio Settings (DVD mode) 65

Choose the appropriate Audio Settings for your equipment and Discs. These settings only affect playback of Discs in the TV/VCR/DVD.

- Before you begin, press **SELECT** to put the TV/VCR/DVD in DVD mode. The green DVD light will appear on the front of the TV/VCR/DVD.

- 1 While playback is stopped, press **SETUP** twice. The SET-UP screen will appear.

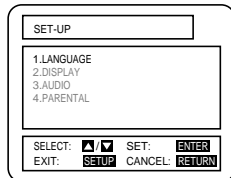

- 2 Press the Number 3 button to select **AUDIO**.

- 3 Press **▲** or **▼** to select an item, then follow step 4 accordingly.

- 4
 - If you selected **DRC**, press **ENTER** repeatedly to turn Dynamic Range Control (DRC) ON or OFF. This levels the sound volume by suppressing loud sound and raising the volume of low sound.
 - If you selected **DOLBY DIGITAL**, press **ENTER** repeatedly to turn DOLBY DIGITAL ON or OFF. Select ON if you connected the TV/VCR/DVD to a stereo that is Dolby Digital compatible. *Details are on page 10.*
 - If you selected **DOWN SAMPLING**, press **ENTER**. Then, press **▲** or **▼** to select **AUTO**, **48 kHz**, or **96 kHz**, then press **ENTER**. The AUDIO CONTROLS menu will reappear. Select 96 kHz if the DVD was recorded in PCM (Pulse Code Modulation) 96 kHz. Otherwise, select 48 kHz.

DRC

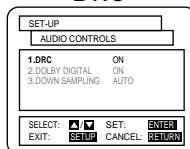

DOLBY DIGITAL



DOWN SAMPLING

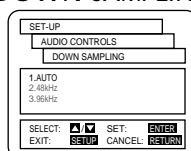

- 5 Press **SETUP** to remove the menu.

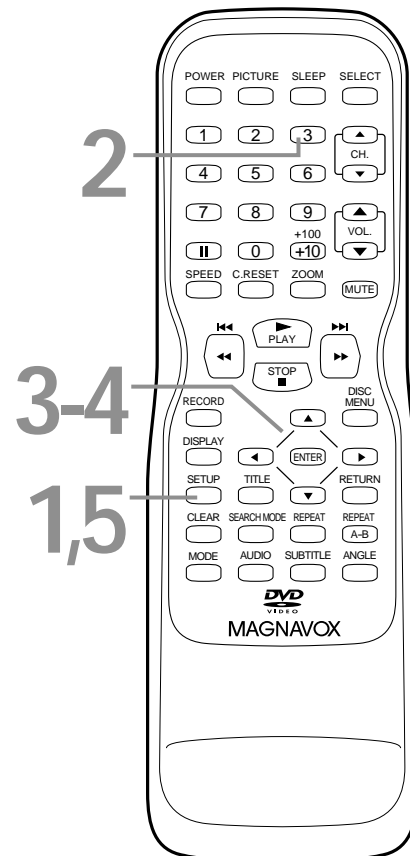

Helpful Hints

- Setting **DOWN SAMPLING** to 96kHz activates copyright protection and mutes the sound. Selecting **AUTO** sets downsampling to 48kHz.
- Dolby Digital must be available on the Disc before you will hear it.

66 Language Settings (DVDs)

You can use the LANGUAGE settings to select different languages for the Audio or Subtitles of DVDs, as well as languages for DVD Disc menus.

- Before you begin, press **SELECT** to put the TV/VCR/DVD in DVD mode. The green DVD light will appear on the front of the TV/VCR/DVD.

- 1 While playback is stopped, press **SETUP** twice. The SET-UP screen appears.

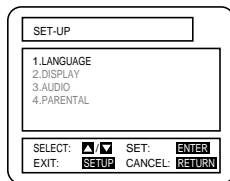

- 2 Press the Number 1 button to select **LANGUAGE**.

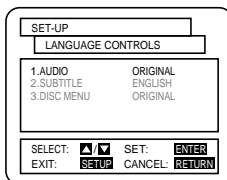

- 3 Press **▲** or **▼** to select **AUDIO**, **SUBTITLE**, or **DISC MENU**. Then, press **ENTER**. The menu for the selected item will appear.



AUDIO: The DVD's audio plays in the selected language, if available on the DVD.

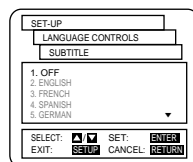

SUBTITLE: DVD subtitles appear in the chosen language, if available on the DVD.

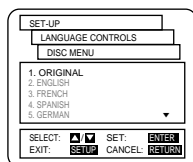

DISC MENU: A DVD's Disc menu appears in the chosen language, if available on the DVD.

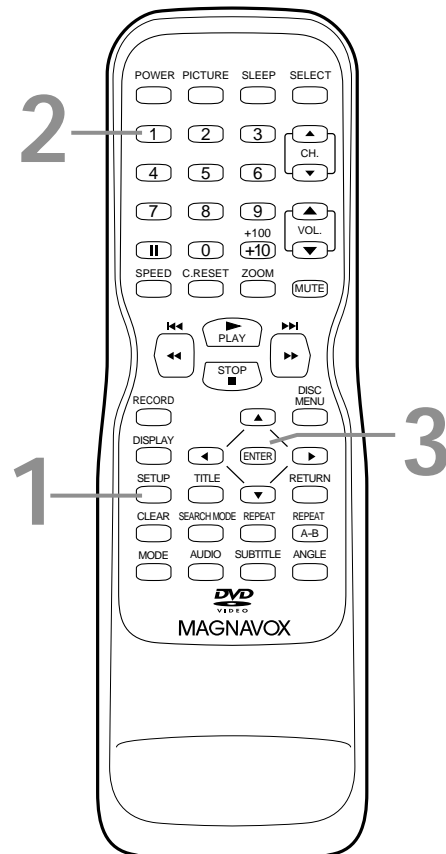

Helpful Hints

- Some DVDs only allow you to change audio, subtitle, or menu languages in the DVD Disc menu. Details are on page 48.
- Language options for **AUDIO**, **SUBTITLE**, and **DISC MENU** are not available with some DVDs. Use the **AUDIO** and **SUBTITLE** buttons instead to select different languages. Details are on pages 56 (subtitles) and 60 (audio).

Language Settings (DVDs) (cont'd) 67

- 4** Press **▲** or **▼** to select a setting. Press **ENTER**.
- If you select **OTHER** at the **AUDIO**, **SUBTITLE**, or **DISC MENU** screen, press four Number buttons to enter the code for the language you desire. Refer to the list below for the correct language code. You can only select other languages for **AUDIO**, **SUBTITLE**, and **DISC MENU** if the language is available on the Disc.
 - Each screen can show a maximum of five languages. To see additional languages, press **▲** or **▼**.

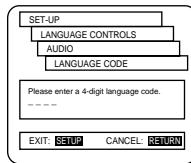

- 5** Press **SETUP** to remove the menu.

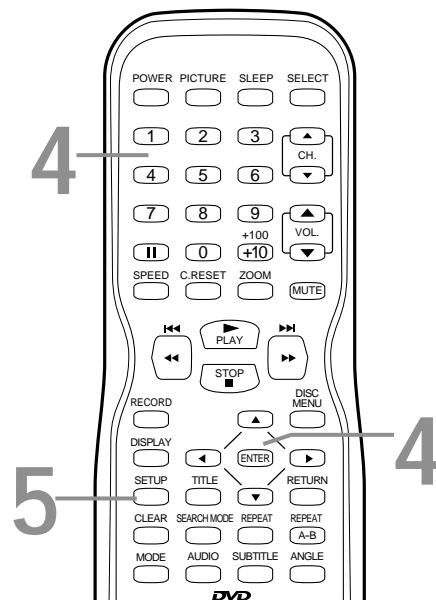

Language	Code	Language	Code	Language	Code	Language	Code	Language	Code
A-B		English[ENG]	5160	Javanese	5669	Oriya	6164	Somali	6561
Abkhazian	4748	Esperanto	5161	Kannada	5760	Oromo (Afan)	6159	Spanish[SPA]	5165
Afar	4747	Estonian	5166	Kashmiri	5765	Panjabi	6247	Sundanese	6567
Afrikaans	4752	F-H		Kazakh	5757	Pashto	6265	Swahili	6569
Albanian	6563	Faroese	5261	Kinyarwanda	6469	Persian	5247	Swedish[SWE]	6568
Amharic	4759	Fiji	5256	Kirghiz	5771	Polish	6258	T	
Arabic	4764	Finnish[FIN]	5255	Kirundi	6460	Portugese[POR]		Tagalog	6658
Armenian	5471	French[FRE]	5264	Korean[KOR]	5761		6266	Tajik	6653
Assamese	4765	Frisian	5271	Kurdish	5767	Pushto	6265	Tamil	6647
Aymara	4771	Gaelic (Scots)	5350	L-N		Quechua	6367	Tatar	6666
Azerbaijani	4772	Galician	5358	Laothian	5861	Rhaeto-Romance	6459	Telugu	6651
Bangla	4860	Georgian	5747	Latin	5847	Romanian[RUM]	6461	Thai	6654
Bashkir	4847	German[GER]	5051	Latvian	5868		6461	Tibetan	4861
Basque	5167	Greek[GRE]	5158	Lettish	5868	Russian[RUS]	6467	Tigrinya	6655
Bengali	4860	Greenlandic	5758	Lingala	5860	S		Tonga	6661
Bhutani	5072	Guarani	5360	Lithuanian	5866	Samoan	6559	Tsonga	6665
Bihari	4854	Gujarati	5367	Macedonian	5957	Sangho	6553	Turkish[TUR]	6664
Bislama	4855	Hausa	5447	Malagasy	5953	Sanskrit	6547	Turkmen	6657
Breton	4864	Hebrew	5569	Malay	5965	Serbian	6564	Twi	6669
Bulgarian	4853	Hindi	5455	Malayalam	5958	Serbo-Croatian	6554	U-Z	
Burmese	5971	Hungarian[HUN]		Maltese	5966		6554	Ukrainian	6757
Byelorussian	4851		5467	Maori	5955	Sesotho	6566	Urdu	6764
C-E		I-K		Marathi	5964	Shona	6560	Uzbek	6772
Cambodian	5759	Icelandic[ICE]	5565	Moldavian	5961	Sindhi	6550	Vietnamese	6855
Catalan	4947	Indonesian	5560	Mongolian	5960	Singhalese	6555	Volapuk	6861
Chinese[CHI]	7254	Interlingua	5547	Nauru	6047	Siswat	6565	Welsh	4971
Corsican	4961	Interlingue	5551	Nepali	6051	Slovak	6557	Wolof	6961
Croatian	5464	Inupiak	5557	Norwegian[NOR]	6061	Slovenian	6558	Xhosa	7054
Czech	4965	Irish[IRI]	5347	O-R				Yiddish	5655
Danish[DAN]	5047	Italian[ITA]	5566	Occitan	6149			Yoruba	7161
Dutch[DUT]	6058	Japanese[JPN]	5647					Zulu	7267

68 Display Settings

You can alter the display screens and on-screen messages or adjust the Aspect Ratio. To do so, follow the steps below.

- Before you begin, press **SELECT** to put the TV/VCR/DVD in DVD mode. The green DVD light will appear on the front of the TV/VCR/DVD.

- 1** When playback is stopped, press **SETUP** twice. The SET-UP screen will appear.

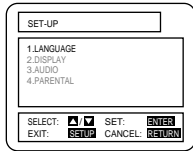

- 2** Press the Number 2 button to select **DISPLAY**.

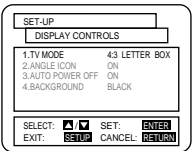

- 3** Press **▲** or **▼** to select an item. Press **ENTER**.

- If you selected **TV MODE**: Press **▲** or **▼** to choose 4:3 LETTER BOX if you want black bars to appear at the top and bottom of the picture. Or, choose 4:3 PAN & SCAN for a full height picture, with both sides trimmed to fit the screen. Press **ENTER** to save the setting and return to the previous menu.
- If you selected **ANGLE ICON**, press **ENTER** repeatedly to turn **ANGLE ICON ON** or **OFF**. Choose **ON** to see the Angle icon if multiple camera angles are available during DVD playback. Choose **OFF** to disable the Angle icon. *Details are on page 56.*
- If you selected **AUTO POWER OFF**, press **ENTER** repeatedly to turn **AUTO POWER OFF ON** or **OFF**. Choose **ON** if you want the TV/VCR/DVD to exit screen saver automatically after 35 minutes of no use in DVD mode.
- If you selected **BACKGROUND**, press **ENTER** repeatedly to select **BLACK** or **BLUE** as the background color for the on-screen menus.

TV MODE

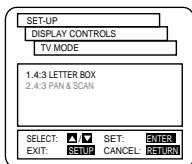

BACKGROUND

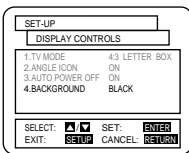

ANGLE ICON

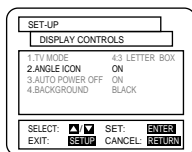

AUTO POWER OFF

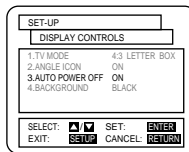

- 4** Press **SETUP** to remove the menus.

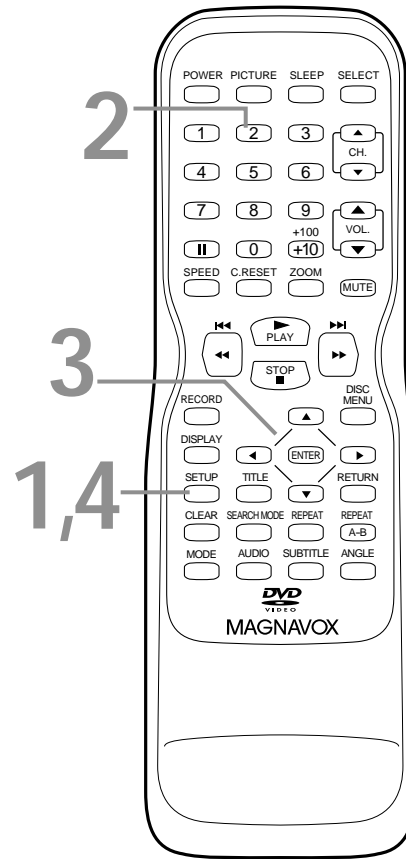

Helpful Hints

- Selecting a different TV MODE setting is only effective if it is available on the DVD.
- DVDs may refer to the Letterbox format as the widescreen version. Letterbox stretches the picture horizontally so the picture resembles movies seen at a theater.
- DVDs may refer to Pan and Scan as "reformatting the picture to fit your TV screen."

On-Screen Displays (Discs) 69

Check current DVD information by pressing DISPLAY.

- Before you begin, press SELECT to put the TV/VCR/DVD in DVD mode. The green DVD light will appear on the front of the TV/VCR/DVD.

1 Press DISPLAY during DVD playback.

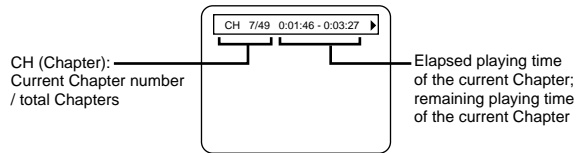

2 Press DISPLAY again. If you want, you can press a Number button now to start playing a specific Chapter.

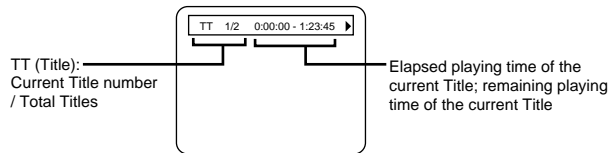

3 Press DISPLAY again.

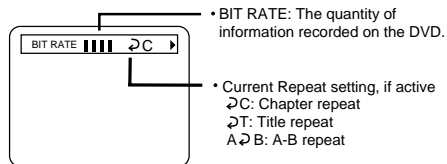

4 Press DISPLAY or RETURN to remove the display.

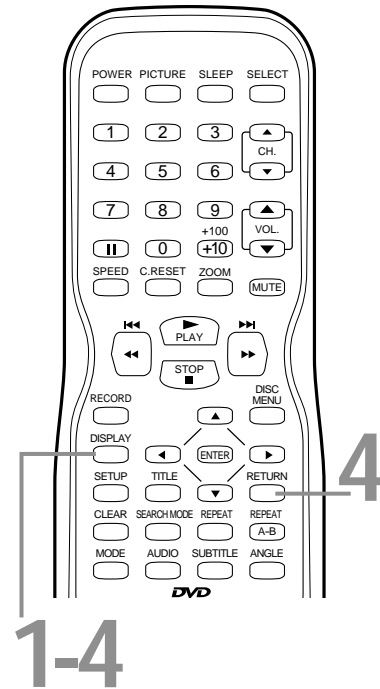

Or, check information about Audio CDs using DISPLAY.

1 Press DISPLAY during Audio CD playback.

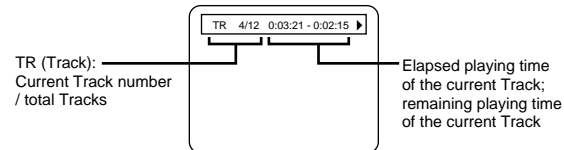

2 Press DISPLAY again. If you want, you can use the Number buttons now to start playing a specific Track.



3 Press DISPLAY or RETURN to remove the display.

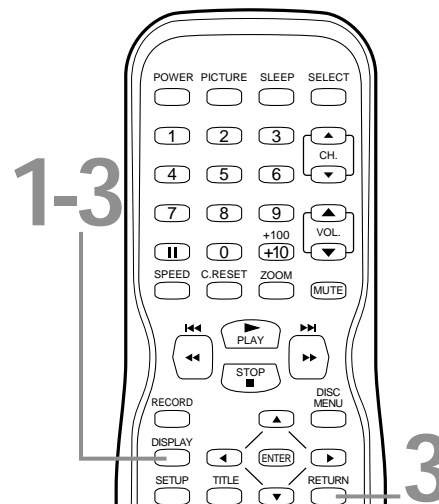

Helpful Hint

- The displays may appear differently if special playback features are active (Repeat, Program, etc.).

70 Black Level Settings, TruSurround Setting (Discs)

Black Level Settings

Use Black Level to brighten the black parts of the DVD picture.

- Before you begin, press **SELECT** to put the TV/VCR/DVD in DVD mode. The green DVD light will appear on the front of the TV/VCR/DVD.

- 1 Press **MODE** once during DVD playback so **BLACK LEVEL** shows in the top left corner of the screen.
- 2 Within 10 seconds, press **ENTER** repeatedly to choose **ON** or **OFF**. **ON** brightens the dark parts of the picture. **OFF** shows the original picture as recorded.

BLACK LEVEL : ON

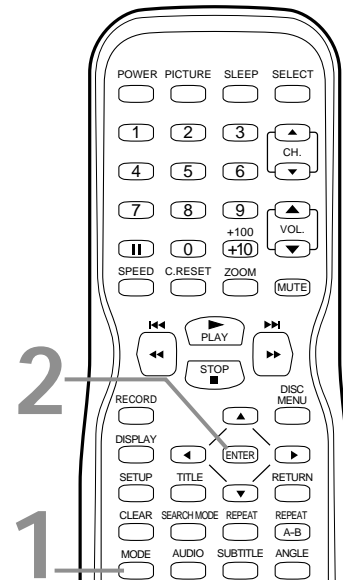

TruSurround Setting

You can enjoy improved stereo sound when you play DVDs or Audio CDs recorded in Dolby Digital or PCM 48 kHz. Check the Disc case for details on availability.

- Before you begin, press **SELECT** to put the TV/VCR/DVD in DVD mode. The green DVD light will appear on the front of the TV/VCR/DVD.

- 1 Press **MODE** twice during Disc playback so **SRS TruSurround** shows in the top left corner of the screen.
- 2 Within 10 seconds, press **ENTER** repeatedly to choose **ON** or **OFF**. The default setting is **OFF**. Choose **ON** if you connected the TV/VCR/DVD to a stereo that has a Dolby Digital decoder. Make sure the current Disc is recorded in Dolby Digital or PCM 48 kHz.

SRS TruSurround ON

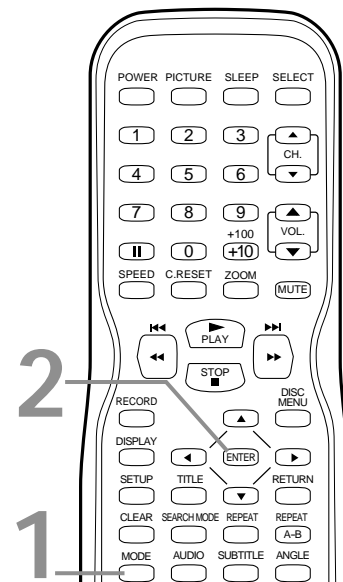

Helpful Hints

- SRS TruSurround is available when the TV/VCR/DVD is connected to a Stereo using the red and white **AUDIO OUT** jacks on the back of the TV/VCR/DVD.
- If you connected the TV/VCR/DVD to a stereo using the **COAXIAL Digital Audio Out** jack as described on page 10, turn off SRS TruSurround. Otherwise, there will be no sound.

This unit employs TruSurround system

TruSurround
by **SRS** of SRS Labs, Inc. as virtual technology.

TruSurround and the **(●)** symbol are trademarks of SRS Labs, Inc. TruSurround technology is incorporated under license from SRS Labs, Inc.

AUDIO In Jack: jack on the front of the TV/VCR/DVD which is used to receive or record audio from another source (VCR, Camcorder, etc.).

Automatic Channel Setup: process in which the TV/VCR/DVD memorizes all available TV channels. Then, when you push the CH. ▲/▼ buttons, you only scan through channels you receive.

Auxiliary (AUX): The channel to which you set your TV/VCR/DVD during dubbing or when viewing material that is playing on another device that is connected to the TV/VCR/DVD (for example, a Camcorder or VCR or TV channels from a Cable Box/Satellite Receiver). The auxiliary (or line input) channel of the TV/VCR/DVD is always channel 00 (AUX).

Bands: settings that allow you to tune channels.

- **Antenna** – VHF (very high frequency; channels 2-13) and UHF (ultra high frequency; channels 14-69).
- **Cable** – standard channels can be received without a Cable Box.

Brightness: adjusting increases or decreases the brightness of the color on the screen.

COAXIAL Digital Audio Out jack: Sends digital audio to a stereo, allowing you to adjust the volume at the stereo.

Color: adjusting pales or brightens the TV/VCR/DVD picture color.

Dolby Digital: A surround sound system that provides 5.1 channel sound as used in movie theaters. Sound is heard through multiple channels, not just the right and left as with standard stereo.

Dubbing: copying a videotape from a separate VCR.

HQ: high quality; a feature in the TV/VCR/DVD circuitry which provides enhanced videotape picture detail through the TV/VCR/DVD.

OTR: One-Touch Recording; a timed recording that starts immediately and records for 30 minutes to eight hours, whichever you specify.

Picture: adjusting increases or decreases the contrast of the picture on the screen.

Sharpness: adjusting softens or clarifies the picture on the screen.

Tape Speeds: how fast the videotape travels during playback or recording. The faster the tape speed, the better the recording quality will be. Faster speeds (SP) also use more space on the tape. So, you can put more recording on a tape if you use a slower tape speed (SLP).

- **SP** (standard play) – fastest tape speed (recording time for a T120 tape is approximately two hours); best picture quality.
- **LP** (long play) – average tape speed; playback only on this TV/VCR/DVD.
- **SLP** (super long play) – slowest tape speed (recording time for a T120 tape is approximately six hours).

Tint: adjusting changes the tints of the picture from purple to green.

VIDEO In Jack: jack on the front of the TV/VCR/DVD which is used to receive or record video from another source (VCR, Camcorder, etc.).

72 Helpful Hints

If you are having problems with your product, check this list of problems and possible solutions before requesting service. You may be able to solve the problem yourself.

Location

For safe operation and satisfactory performance of your TV/VCR/DVD, remember the following:

- Shield it from direct sunlight and keep it away from sources of intense heat.
- Avoid dusty or humid places.
- Avoid places with insufficient ventilation. Do not block the ventilation openings at the top and bottom of the TV/VCR/DVD. Do not place the TV/VCR/DVD on a carpet, as this will block the ventilation openings.
- Avoid locations subject to strong vibrations.
- Do not place the TV/VCR/DVD near strong magnetic fields.
- Do not move the TV/VCR/DVD from a cold place to a hot place, or vice versa.

Electrical Shock and Fire Hazards

- Do not handle the power cord with wet hands.
- Do not pull the power cord when disconnecting the TV/VCR/DVD from the AC (alternating current) wall outlet. Grasp it by the plug.
- If you spill water on the TV/VCR/DVD, unplug the power cord immediately and take the TV/VCR/DVD to an authorized service center.
- Do not put your fingers or objects into the cassette compartment or disc tray.
- Do not place anything on top of the TV/VCR/DVD.

Dew Warning (Moisture Condensation)

- Moisture may condense inside the unit when you move it from a cold place to a warm place, after heating a cold room, or when the humidity is high. There is no warning that moisture is in your TV/VCR/DVD. Playing a tape in a TV/VCR/DVD in which moisture has accumulated could damage the tape and the TV/VCR/DVD. If you suspect moisture inside the TV/VCR/DVD, keep the TV/VCR/DVD power on (but do not play a tape) for at least two hours. This will allow the TV/VCR/DVD to dry.

TV/VCR/DVD will not perform a timer recording.

- Set the recording start and stop times correctly. *Details are on pages 28-30.* Midnight is 12 a.m. Noon is 12 p.m.
- Make sure the TV/VCR/DVD power is off for the timer recording.
- Set the clock. *Details are on pages 20-22.*
- Put a videotape in the cassette compartment of the TV/VCR/DVD. The tape must have a record tab. *Details are on page seven.*
- If the power fails, timer recordings will be restored when the clock resets. (The clock resets itself automatically if you are using AUTO CLOCK. *Details are on page 22.* If you are not using AUTO CLOCK, reset the clock manually. *Details are on pages 20-21.*) Timer recordings do not occur if set to take place during the power failure.

TV/VCR/DVD will not record.

- Make sure the videotape has a record tab. *Details are on page seven.*
- Plug the power cord into an active AC outlet. *Details are on page nine.*
- Check your hookups. *Details are on pages eight-nine.*
- Set up the TV channels. *Details are on pages 18-19.*
- You cannot record DVDs onto a videotape using the TV/VCR/DVD.

Channel reception is poor.

- Check connections, then set up the channels again. *Details are on pages 18-19.*

TV/VCR/DVD has no power.

- Connect the power plug to an AC (alternating current) outlet completely.

A screen saver appears on the screen during DVD mode.

- The DVD screen saver will appear if there is no activity in DVD mode for five minutes.

Helpful Hints (cont'd) 73

Disc cannot play.

- Insert a playable Disc. Make sure the Disc is labelled for Region 1 or ALL regions and is NTSC compatible. *Details are on page six.*
- Place the Disc correctly in the Disc tray. If the Disc is one-sided, place the Disc in the tray with the label facing up. If the Disc is two-sided, make sure the label of the side you want to play is facing up.
- Clean the Disc. Make sure the Disc is not scratched or warped.
- Cancel the Parental Controls, enter the password, or change the control level. *Details are on pages 58-59.*

TV/VCR/DVD does not have a picture.

- Adjust the antenna or check the Cable TV or satellite signal connection. If using a Cable Box/Satellite Receiver, set the TV/VCR/DVD to channel 3 or 4 or AUX (channel 00). *Details are on pages eight-nine.*
- Adjust the TV/VCR/DVD picture controls. *Details are on page 24.*
- Select an active channel. *Details are on pages 18-19*
- Make sure the Disc is compatible with the DVD Player of the TV/VCR/DVD. *Details are on page six.*

TV/VCR/DVD has poor sound or no sound.

- Press VOL. ▲/▼ to adjust the volume. Press MUTE to restore the volume.
- Check the audio settings for DVD mode. *Details are on page 65.*
- Check the audio settings of the Disc. For example, you may have selected "soundtrack" playback or an unavailable sound setting (such as Dolby Digital). *Details are on pages 60 and 65.* Try other sound options provided in the DVD Disc menu.

You cannot choose a DVD feature, such as camera angle or audio or subtitle language.

- The feature must be recorded on the DVD. Not all DVDs contain multiple angles, subtitles, etc. Refer to the Disc case to see what features are available. If the feature is not available, the  may appear.

Videotape playback is poor or the tape is destroyed.

- Adjust the tracking. *Details are on page 38.*
- Use the Rental feature. *Details are on page 33.*
- If moisture has accumulated in the unit, keep the power on for at least two hours but do not play a tape.

TV/VCR/DVD does not display closed captions for TV programs.

- Make sure closed captioning is available for the program. Refer to the TV listings in your local newspaper.

Remote control does not operate the TV/VCR/DVD.

- Aim the remote control directly at the remote sensor on the front of the TV/VCR/DVD. *Details are on pages seven and 16.*
- Remove all obstacles between the remote control and the TV/VCR/DVD.
- Inspect and replace the batteries in the remote control. *Details are on page seven.*

Number buttons will not select channels above 69.

- Enter channel numbers as a two-digit number. If you want to select channels 100 and above, press the +100/+10 button, then the Number buttons for the last two digits. *Details are on page 11.*
- If you are using an antenna and do not have Cable TV/Satellite, only channels 2-69 will be available.

You cannot insert a tape into the cassette compartment of the TV/VCR/DVD.

- Insert the tape with the window facing up and the record tab facing you.
- Make sure a tape isn't already inside by pressing STOP/EJECT  on the front of the TV/VCR/DVD.
- Gently push on the center of the tape. Never force a tape into the TV/VCR/DVD.
- If you have set a timer recording and the TV/VCR/DVD power is off, the TV/VCR/DVD will eject the tape if the record tab is missing.

You cannot remove the tape from the TV/VCR/DVD.

- Make sure the power plug is completely connected to an AC (alternating current) outlet.
- If a timer recording is programmed, turn on the TV/VCR/DVD power, then eject the tape. Be sure to insert a tape and turn off the TV/VCR/DVD power for the timer recording.
- Unplug the TV/VCR/DVD power cord for five minutes. Then, plug in the power cord again, then press POWER on the TV/VCR/DVD. If the tape does not eject, press STOP/EJECT  on the TV/VCR/DVD three to five times. If the tape still does not eject, an authorized servicer may need to remove the tape.

TV/VCR/DVD ejects the tape when you try to start a recording.

- Make sure the tape has a record tab. *Details are on page seven.*

74 Specifications

General TV/VCR

CRT :	27 inch in-line gun, 110° deflection tube
Television system :	NTSC-M
Closed Caption system :	§15.119/FCC
Video Heads :	Rotary four-head
Tape width :	1/2 inch
Tape speeds	
SP :	33.40 mm/sec.
LP :	16.67 mm/sec.
SLP :	11.12 mm/sec.
Tuner channels	
VHF Low :	2-6
VHF High :	7-13
UHF :	14-69
Cable TV	
VHF :	5A
MID band :	A5-A1, A-I
SUPER band :	J-W
HYPER band :	W+1-W+84

General DVD

Output signal format:	NTSC Color System
Frequency response output jack	
DVD (linear sound):	20 Hz to 22 kHz (sample rate: 48 kHz)
	20 Hz to 44 kHz (sample rate: 96 kHz)
Audio CD:	20 Hz to 20 kHz
Signal-to-noise ratio output jack	
Audio CD:	100 dB (EIAJ)
Dynamic range output jack	
DVD (linear sound):	85 dB
Audio CD:	84 dB (EIAJ)
Total distortion factor	
Audio CD:	0.07% (EIAJ)
Wow and flutter:	Below the measurement limitation (+/-0.001% W PEAK) (EIAJ)

Electrical Specifications

Sound output:	Two speakers, 1W, 8 ohm
---------------	-------------------------

Other Specifications

Terminals	
Antenna In:	VHF/UHF/Cable TV 75 ohm unbalanced (F-type)
Video In:	one RCA connector
Audio L/R In:	two RCA connectors
Headphone:	1/8" stereo (3.5 mm)
Coaxial Digital	
Audio Out:	One pin jack, 500m Vpp (75 ohm)
Audio L/R Out :	two RCA connectors
Operating temperature:	5°C to 40°C (41°F-104°F)
Power requirements:	AC 120V, 60Hz
Power consumption (Maximum):	125W
Dimensions:	Height: 25-1/2" (648 mm) Width: 26-9/16" (675 mm) Depth: 19-11/16" (500 mm)
Weight:	86 lbs (39 kg)
Accessories:	Remote Control with two AA batteries Owner's Manual

Designs and specifications are subject to change without notice and without our legal obligation.

Limited Warranty 75

TV/VCR/DVD COMBINATION

90 Days Free Labor/One Year Parts Exchange

This product can be repaired in-home.

WHO IS COVERED?

You must have proof of purchase to receive warranty service. A sales receipt or other document showing that you purchased the product is considered proof of purchase.

WHAT IS COVERED?

Warranty coverage begins the day you buy your product. For 90 days thereafter, all parts will be repaired or replaced free, and labor is free. From 90 days to one year from the day of purchase, all parts will be repaired or replaced free, but you pay for all labor charges. After one year from the day of purchase, you pay for the replacement or repair of all parts, and for all labor charges.

All parts, including repaired and replaced parts, are covered only for the original warranty period. When the warranty on the product expires, the warranty on all replaced and repaired parts also expires.

WHAT IS EXCLUDED?

Your warranty does not cover:

- labor charges for installation or setup of the product, adjustment of customer controls on the product, and installation or repair of antenna systems outside of the product.
- product repair and/or part replacement because of misuse, accident, unauthorized repair or other cause not within the control of Magnavox.
- reception problems caused by signal conditions or cable or antenna systems outside the unit.
- a product that requires modification or adaptation to enable it to operate in any country other than the country for which it was designed, manufactured, approved and/or authorized, or repair of products damaged by these modifications.
- incidental or consequential damages resulting from the product. (Some states do not allow the exclusion of incidental or consequential damages, so the above exclusion may not apply to you. This includes, but is not limited to, prerecorded material, whether copyrighted or not copyrighted.)
- damage caused by the use of non-VHS tapes or tapes that have not been tested and labeled for use in two, four, six, and eight hour VHS recorders.
- a product that is used for commercial or institutional purposes.

WHERE IS SERVICE AVAILABLE?

Warranty service is available in all countries where the product is officially distributed by Magnavox. In countries where Magnavox does not distribute the product, the local Magnavox service organization will

attempt to provide service (although there may be a delay if the appropriate spare parts and technical manual(s) are not readily available).

MAKE SURE YOU KEEP...

Please keep your sales receipt or other document showing proof of purchase. Attach it to this owner's manual and keep both nearby. Also keep the original box and packing material in case you need to return your product.

BEFORE REQUESTING SERVICE...

Please check your owner's manual before requesting service. Adjustments of the controls discussed there may save you a service call.

TO GET WARRANTY SERVICE IN U.S.A., PUERTO RICO, OR U.S. VIRGIN ISLANDS...

Take the product to a Magnavox factory service center (see enclosed list) or authorized service center for repair. When the product has been repaired, you must pick up the unit at the center. Centers may keep defective parts.

(In U.S.A., Puerto Rico, and U.S. Virgin Islands, all implied warranties, including implied warranties of merchantability and fitness for a particular purpose, are limited in duration to the duration of this express warranty. But, because some states do not allow limitations on how long an implied warranty may last, this limitation may not apply to you.)

TO GET WARRANTY SERVICE IN CANADA...

Please contact Magnavox at:

1-800-705-2000.

(In Canada, this warranty is given in lieu of all other warranties. No other warranties are expressed or implied, including any implied warranties of merchantability or fitness for a particular purpose. Magnavox is not liable under any circumstances for any direct, indirect, special, incidental or consequential damages, howsoever incurred, even if notified of the possibility of such damages.)

REMEMBER...

Please record below the model and serial numbers found on the product. Also, please fill out and mail your warranty registration card promptly. It will be easier for us to notify you if necessary.

MODEL # _____
SERIAL # _____

This warranty gives you specific legal rights. You may have other rights which vary from state to state.

Magnavox, P.O. Box 520890, Miami, FL 33152 (402) 536-4171

EL6543E001 / 01-03

76 Index

- a-b repeat 54
- angle button 15, 56
- ant(enna) jack 8-9, 17
- arrow buttons 14
- audio button 15, 60
- audio cd 6
- audio in/out jacks 9-10, 16-17, 27
- audio settings (dvd) 65
- auto return 31
- automatic rewind, eject 38
- auxiliary mode (aux) 8-9, 11, 27-28

- batteries 7
- black level 70
- brightness 24

- c.reset button 15, 30, 34
- camera angle 56
- cassette compartment 16
- channel
 - above 100 14
 - adding/deleting 19
 - setup 18
 - ▲/▼ buttons 15-16, 38
- chapters 50
- clear button 15, 51, 61
- clock setting 20-22
- closed captions 39
- coaxial digital audio out jack 10, 17
- color 24
- connections 8-10, 27
- contents, table of 4
- contrast 24
- controls
 - remote 14-15
 - tv/vcr/dvd 16
- copyright protection 3, 27
- counter 24, 34

- daylight-savings time 23
- disc tray 13, 16
- disc menu button 15, 48
- display button 14, 24, 69
- display settings 68
- duplication 27
- dvd light 16
- dvd video 6

- ejecting a tape 73
- enter button 14, 65-68, 70

- fast forward search 37, 49
- forward buttons 14, 16, 37, 49
- front panel 16

- glossary 71

- headphone jack 16
- helpful hints 72-73
- hookups 8-10, 27

- language (dvd) 66-67
- language (setup menus) 18
- language settings 66-67
- line input mode (auxiliary) 8-9, 11, 27-28
- lp (long play) 25, 37, 71

- menus 5, 18, 48
- mode button 15, 61, 64, 70
- mp3 display information 63
- mp3 playback 62
- mp3 track selection 63
- mts system 45-47
- mute button 15

- number buttons 14

- on-screen status displays 24, 69
- one-touch recording 26
- open/close button ▲ 16
- output button 16

- parental controls 58-59
- password 58
- (pause) ■■ button 14, 25, 37, 53, 57
- picture controls 24
- picture button 14, 24
- play ► button 12-14, 16
- playing discs 13
- playing videotapes 12
- power button 11, 13, 14, 16, 29
- power cord 9, 17
- programs 61, 64

- random playback 61, 64
- ratings
 - mpaa 43
 - tv 41-42
- real-time tape counter 24, 34
- rear panel 17
- record button 14, 25
- recording
 - basic 25
 - one-touch 26
 - timer 28-30
- rec/otr button 16, 26
- rec/otr light 16
- remote control
 - buttons 14-15
 - using 7
- remote sensor 16
- repeat button 14, 54

- repeat a-b button 15, 54
- repeat play 32, 54
- rerecording 27
- resuming play 53
- return button 14
- reverse searching 37, 49
- rewind/reverse buttons 15-16, 37, 49
- rf coaxial cable 8
- safety precautions 3
- search mode button 15, 50-52, 55, 63
- searching 37, 49
- second audio program 45, 47
- select button 13-14
- setup button 5, 15
- sharpness 24
- sleep button 14, 40
- sleep timer 40
- slow motion 37, 57
- slp (super long play) 25, 37, 71
- sp (standard play) 25, 37, 71
- specifications 74
- speed button 15, 25-27
- status display 24, 69
- stereo broadcast recording 45-47
- still picture 37, 53
- stop ■ button 14
- stop/eject ■▲ button 12, 16
- subtitle button 15, 56
- super high speed searching 37

- table of contents 4
- tape duplication 27
- tape eject 16, 38, 73
- tape speed 25, 71
- time search 35
- time setting 20-22
- timer recording
 - cancelling 30
 - checking 30
 - setting 28-30
- tint 24
- title button 14, 48
- titles 48, 50
- tracking 38
- tracks 52
- trusurround 70

- vcr/tv light 16
- v-chip setup 41-44
- video in/out jacks 9, 27, 71
- volume ▲/▼ buttons 15-16

- warranty 75

- zero return 34
- zoom button 15, 57



This owner's manual is made of recycled paper.

IB8392E002
Printed In Malaysia
OEMN02052 / TD603UD * * * *

Free Manuals Download Website

<http://myh66.com>

<http://usermanuals.us>

<http://www.somanuals.com>

<http://www.4manuals.cc>

<http://www.manual-lib.com>

<http://www.404manual.com>

<http://www.luxmanual.com>

<http://aubethermostatmanual.com>

Golf course search by state

<http://golfingnear.com>

Email search by domain

<http://emailbydomain.com>

Auto manuals search

<http://auto.somanuals.com>

TV manuals search

<http://tv.somanuals.com>