

20MT4405



Thank you for choosing Magnavox.

Need help fast?

*Read your Quick Use Guide and/or
Owner's Manual first for quick tips
that make using your Magnavox product
more enjoyable.*

*If you have read your instructions
and still need assistance,
you may access our online help at
www.usasupport.magnavox.com
or call
1-800-705-2000
while with your product
(and Model / Serial number)*

Model No : _____

Serial No : _____

INTRODUCTION

Welcome/Registration of Your TV	3
Important Safety Instructions.....	4

CONNECTION GUIDE

Basic Antenna and Cable Connections	5
Basic TV and Remote Control Operation	6
Cable Box Connections	7
AV(Audio/Video) Input Connection	8
Side AV Connections	9
S-Video (S-VHS) Input Connections	10
Component Video (CVI) Input Connections	11
AV Output Jacks.....	12

INSTALLATION MENU

Remote Control Button Descriptions	13
How to use the Language Controls.....	14
How to use the Tuner Mode Control	15
Auto Program	16
Channel Edit	17
Picture Menu Controls.....	18
Sound Menu Controls	19
The 4:3 Expand Format Control	20

FEATURES MENU

Understanding Smartlock Controls.....	21
Setting Up An Access Code	22
Block Channels	23
Block / Clear All Channels At The Same Time.....	24
Movie Ratings	25
TV Ratings.....	26
Block Options	27
Close Captioning	28
Sleeptimer.....	28

OTHER FEATURES

Alternating Channels with A/CH button	29
Smart Picture	18
Smart Sound	19

IMPORTANT INFORMATION

Glossary	29
Troubleshooting Tips	30
Cleaning and Care	31
Specifications	32
Limited Warranty.....	33
Index	34

Smart Picture lets you select from five pre-set picture settings; Personal, Movies, Sports, Multimedia or Weak signals with the push of one button (Pg. 18).

Smart Sound lets you select from four pre-set controls according to your own preference. The four pre-set controls (Personal, Voice, Music, and Theatre) lets you custom set the TV sound to enhance the sound of the program you are watching (Pg. 19).

Channel Edit lets you add or skip channels from the list stored in the TV memory. Channel Edit makes it easy to limit or expand the number of channels that are available to you when you press the Channel (+) or (-) buttons on your remote control (Pg. 17).

Closed Captioning allows the viewer to read TV program dialogue or voice conversations as onscreen text. (Pg. 28).

Sleeptimer allows the viewer to set a timer to automatically turn the TV off after a period of time (Page. 28).

SmartLock lets you block channels or programs that are not suitable for children or with restricted TV ratings (Pg. 21).



As an Energy Star® Partner, Magnavox has determined this product meets the Energy Star® guidelines for energy efficiency. Energy Star® is a U.S. registered mark. Using products with the Energy Star® label can save energy. Saving energy reduces air pollution and lowers utility bills.

Return your Product Registration Card today to get the very most from your purchase.

Registering your model with MAGNAVOX makes you eligible for all of the valuable benefits listed below, so don't miss out. Complete and return your Product Registration Card at once to ensure:

*Proof of Purchase

Returning the enclosed card guarantees that your date of purchase will be on file, so no additional paperwork will be required from you to obtain warranty service.

*Product Safety Notification

By registering your product, you'll receive notification - directly from the manufacturer - in the rare case of a product recall or safety defect.

*Additional Benefits of Product Ownership

Registering your product guarantees that you'll receive all of the privileges to which you're entitled, including special money-saving offers.

MAGNAVOX

Congratulations on your purchase, and welcome to the "family!"

Dear MAGNAVOX product owner:

Thank you for your confidence in MAGNAVOX. You've selected one of the best-built, best-backed products available today. We'll do everything in our power to keep you happy with your purchase for many years to come.

As a member of the MAGNAVOX "family," you're entitled to protection by one of the most comprehensive warranties and outstanding service networks in the industry. What's more, your purchase guarantees you'll receive all the information and special offers for which you qualify, plus easy access to accessories from our convenient home shopping network.

Most importantly, you can count on our uncompromising commitment to your total satisfaction.

All of this is our way of saying welcome - and thanks for investing in a MAGNAVOX product.

P.S. To get the most from your MAGNAVOX purchase, be sure to complete and return your Product Registration Card at once.

Know these **safety** symbols



 This "bolt of lightning" indicates uninsulated material within your unit may cause an electrical shock. For the safety of everyone in your household, please do not remove product covering.

 The "exclamation point" calls attention to features for which you should read the enclosed literature closely to prevent operating and maintenance problems.

WARNING: To reduce the risk of fire or electric shock, this apparatus should not be exposed to rain or moisture and objects filled with liquids, such as vases, should not be placed on this apparatus.

CAUTION: To prevent electric shock, match wide blade of plug to wide slot, fully insert.

ATTENTION: Pour éviter les choc électriques, introduire la lame la plus large de la fiche dans la borne correspondante de la prise et pousser jusqu'au fond.

MAGNAVOX

Visit our World Wide Web Site at <http://www.usasupport.magnavox.com>

IMPORTANT SAFETY INSTRUCTIONS

Read before operating equipment

1. Read these instructions.
2. Keep these instructions.
3. Heed all warnings.
4. Follow all instructions.
5. Do not use this TV near water.
6. Clean only with a dry cloth.
7. Do not block any of the ventilation openings. Install in accordance with the manufacturers instructions.
8. Do not install near any heat sources such as radiators, heat registers, stoves, or other apparatus (including amplifiers) that produce heat.
9. Do not defeat the safety purpose of the polarized or grounding-type plug. A polarized plug has two blades with one wider than the other. A grounding type plug has two blades and third grounding prong. The wide blade or third prong are provided for your safety. When the provided plug does not fit into your outlet, consult an electrician for replacement of the obsolete outlet.
10. Protect the power cord from being walked on or pinched particularly at plugs, convenience receptacles, and the point where they exit from the apparatus.
11. Only use attachments/accessories specified by the manufacturer.
12.  Use only with a cart, stand, tripod, bracket, or table specified by the manufacturer, or sold with the TV. When a cart is used, use caution when moving the cart/TV combination to avoid injury from tip-over.
13. Unplug this TV during lightning storms or when unused for long periods of time.
14. Refer all servicing to qualified service personnel. Servicing is required when the TV has been damaged in any way, such as power-supply cord or plug is damaged, liquid has been spilled or objects have fallen into apparatus, the TV has been exposed to rain or moisture, does not operate normally, or has been dropped.
15. This product may contain lead and mercury. Disposal of these materials may be regulated due to environmental considerations. For disposal or recycling information, please contact your local authorities or the Electronic Industries Alliance: www.eiae.org
16. Damage Requiring Service - The TV should be serviced by qualified service personnel when:
 - A. The power supply cord or the plug has been damaged; or
 - B. Objects have fallen, or liquid has been spilled into the TV; or
 - C. The TV has been exposed to rain; or

- D. The TV does not appear to operate normally or exhibits a marked change in performance; or
- E. The TV has been dropped, or the enclosure damaged.

17. **Tilt/Stability** - All televisions must comply with recommended international global safety standards for tilt and stability properties of its cabinet design.
 - Do not compromise these design standards by applying excessive pull force to the front, or top, of the cabinet which could ultimately overturn the product.
 - Also, do not endanger yourself, or children, by placing electronic equipment/toys on the top of the cabinet. Such items could unsuspectingly fall from the top of the set and cause product damage and/or personal injury.
18. **Wall or Ceiling Mounting** - The TV should be mounted to a wall or ceiling only as recommended by the manufacturer.
19. **Power Lines** - An outdoor antenna should be located away from power lines.
20. **Outdoor Antenna Grounding** - If an outside antenna is connected to the receiver, be sure the antenna system is grounded so as to provide some protection against voltage surges and built up static charges. Section 810 of the National Electric Code, ANSI/NFPA No. 70-1984, provides information with respect to proper grounding of the mast and supporting structure, grounding of the lead-in wire to an antenna discharge unit, size of grounding connectors, location of antenna-discharge unit, connection to grounding electrodes, and requirements for the grounding electrode. See Figure below.
21. **Object and Liquid Entry** - Care should be taken so that objects do not fall and liquids are not spilled into the enclosure through openings.
 - a) Warning: To reduce the risk of fire or electric shock, this apparatus should not be exposed to rain or moisture and objects filled with liquids, such as vases, should not be placed on this apparatus.
22. **Battery Usage CAUTION** - To prevent battery leakage that may result in bodily injury, property damage, or damage to the unit:
 - Install all batteries correctly, with + and - aligned as marked on the unit.
 - Do not mix batteries (old and new or carbon and alkaline, etc.).
 - Remove batteries when the unit is not used for a long time.

Note to the CATV system installer: This reminder is provided to call the CATV system installer's attention to Article 820-40 of the NEC that provides guidelines for proper grounding and, in particular, specifies that the cable ground shall be connected to the grounding system of the building, as close to the point of cable entry as practical.

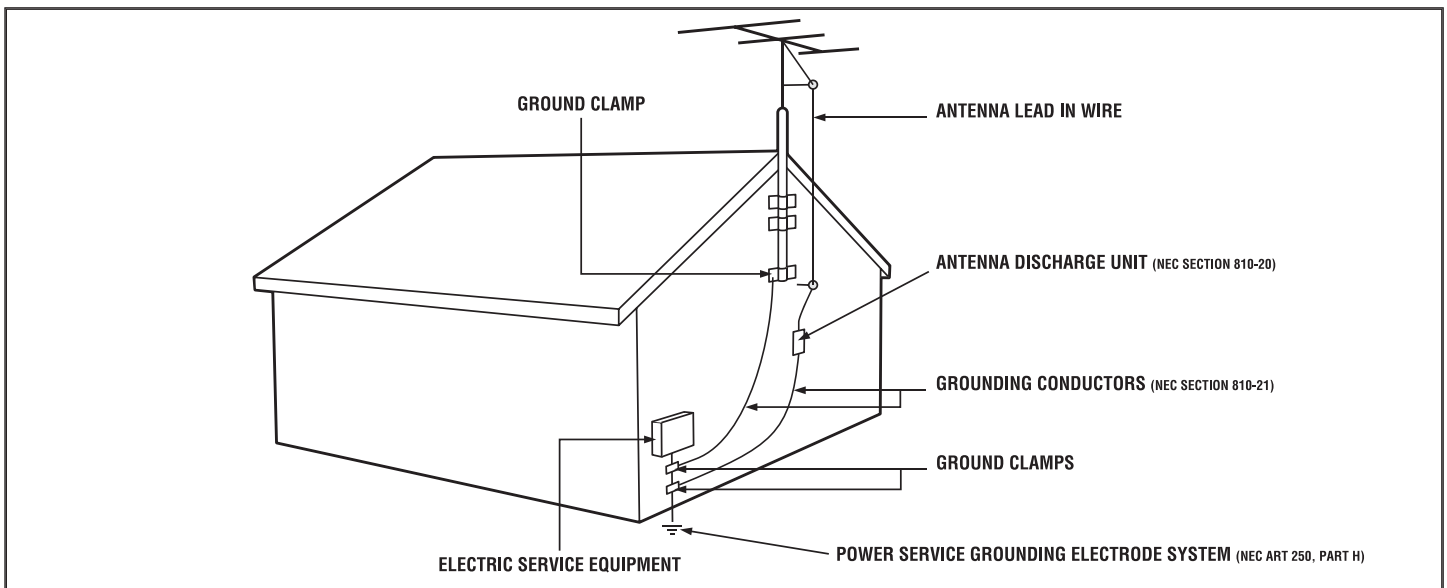

BASIC ANTENNA AND CABLE CONNECTIONS

Your home's signal input might come from a single (75 ohm) round cable, a converter box or from an antenna. In either case the connection to the TV is very easy.

1 If your Cable TV signal or Antenna signal is a round cable (75 ohm) then you are ready to connect to the TV.

If your antenna has flat twin lead wire (300 ohm), you first need to switch the antenna wires to the screws of a 75 ohm adapter.

If you have a Cable Converter Box : Connect the Cable TV signal to the Cable Signal IN(put) plug on the Converter.

2 Connect the Cable TV cable or Antenna cable (or 300 to 75 ohm adapter) to the 75Ω plug on the TV.

If you have a Cable Converter Box : Connect the OUT (put) plug from the Converter to the 75Ω plug on the TV.

Antenna Connection

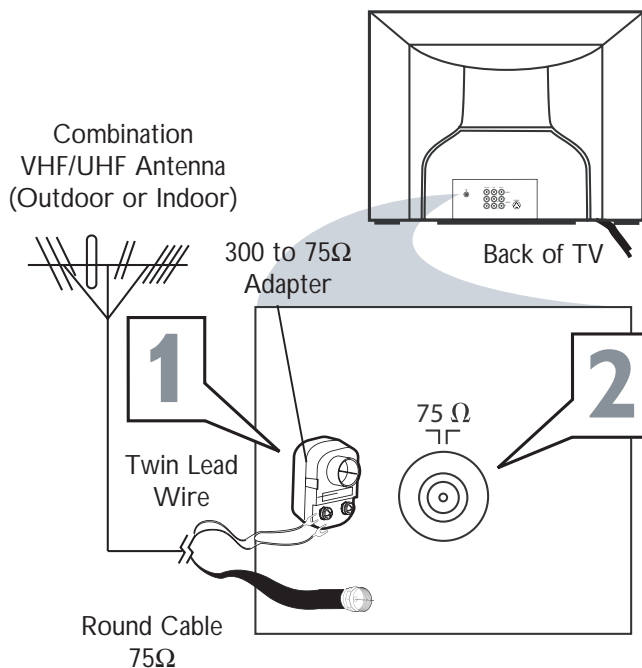

Direct Cable Connection

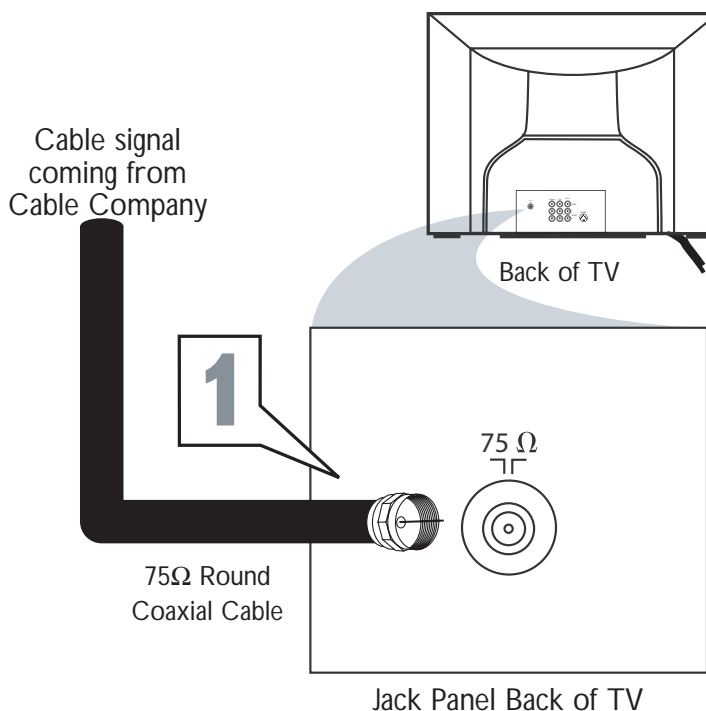

HELPFUL HINTS

After using the Auto Program Control, press the **CH+** and **CH-** buttons to scroll through all the channels stored in the television's memory.

BASIC TV AND REMOTE CONTROL OPERATION

- 1** Press the **POWER** button to turn the TV ON.
- 2** Press the **VOLUME +** button to increase the sound level, or the **VOLUME -** button to lower the sound level.

Pressing both buttons at the same time will display the on-screen menu. Once in the menu, use these buttons to make adjustments or selections.
- 3** Press the **CHANNEL UP +** or **DOWN -** button to select TV channels.
- 4** Point the remote control toward the remote sensor window on the TV when operating the TV with the remote.

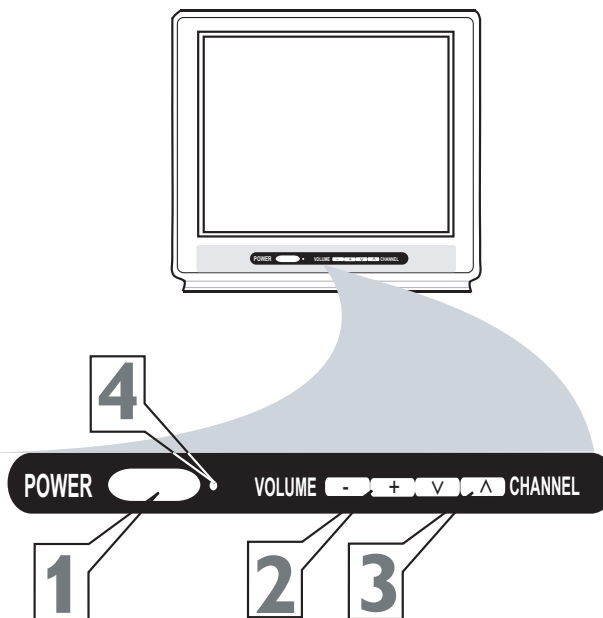

REMOTE CONTROL

To load the supplied batteries into the remote :

- 1** Remove the battery compartment lid at the back of the remote.
- 2** Place the batteries (2-AA) in the remote. Be sure the (+) and (-) ends of the batteries line up correctly as marked on the inside of the case.
- 3** Reattach the battery lid.

Back of Remote Control

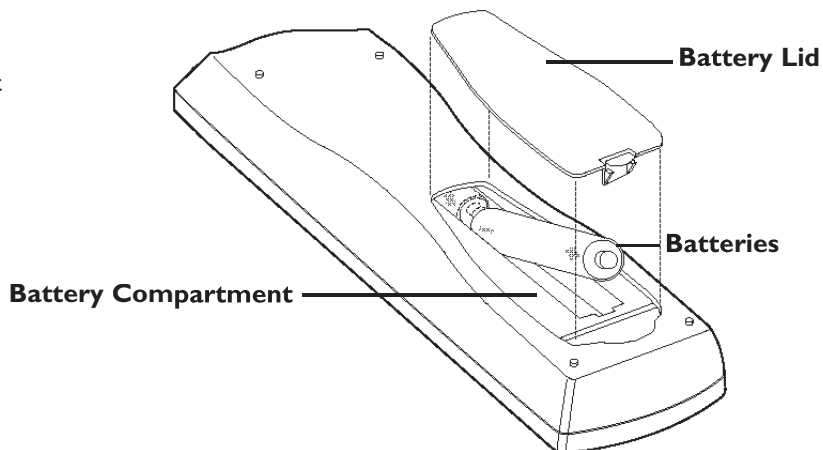

CABLE BOX CONNECTIONS

If your cable signal uses a cable box or decoder, follow the steps below to complete the connection.

Cable Box (w/Audio/Video Outputs) :

- 1** Connect the **Cable Company** supplied cable to the signal IN(put) plug at the back of the Cable Box.
- 2** Using a RCA type Video Cable, **connect one end of the cable to the Video** (or ANT, your cable box may be labeled differently) **Out jack** on the cable box and the other end to the AVI Video Input on the TV.
- 6** **Connect one end** of the Audio Left and Right Cable **to the left and right Audio Out L & R jacks on the cable box**. Connect the other end to the AV In Audio L & R Input jacks on the TV.

NOTE : Use the AV button on the TV remote control to tune to the AV channel or the cable box signal. Once tuned, change channels at the cable box, not the television.

Cable Box (w/Audio/Video Outputs):

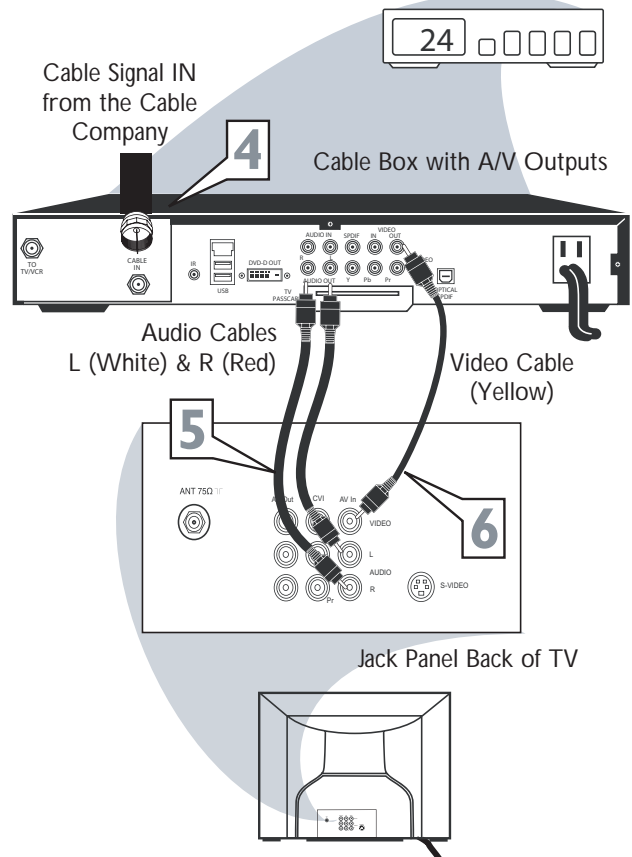

AV (AUDIO/VIDEO) INPUT CONNECTION

The TV's audio/video input jacks are for direct picture and sound connections between TV and a VCR (or similar device) that has audio/video output jacks. Follow steps below to connect an accessory device to the AV In Input Jacks located at the back of the TV.

- 1 **Connect the VIDEO (yellow) cable** to the VIDEO AV In jack on the back of the TV.
- 2 **Connect the AUDIO (red and white) cables** to the AUDIO (left and right) AV In jacks on the rear of the TV.
- 3 **Connect the VIDEO (yellow) cable** to the VIDEO OUT jack at the back of the VCR.
- 4 **Connect the AUDIO (red and white) cables** to the AUDIO (left and right) OUT jacks at the rear of the VCR.
- 5 **Turn the VCR (accessory device) and the TV on.**
- 6 **Press the CH+ / CH- button** on the remote control to select the AV Channel. AV will appear on the upper left corner of the TV screen.
- 7 **With the VCR (or accessory device) ON and a prerecorded tape (CD, DVD, etc.) inserted, press the PLAY ► button** to view the tape on the television.

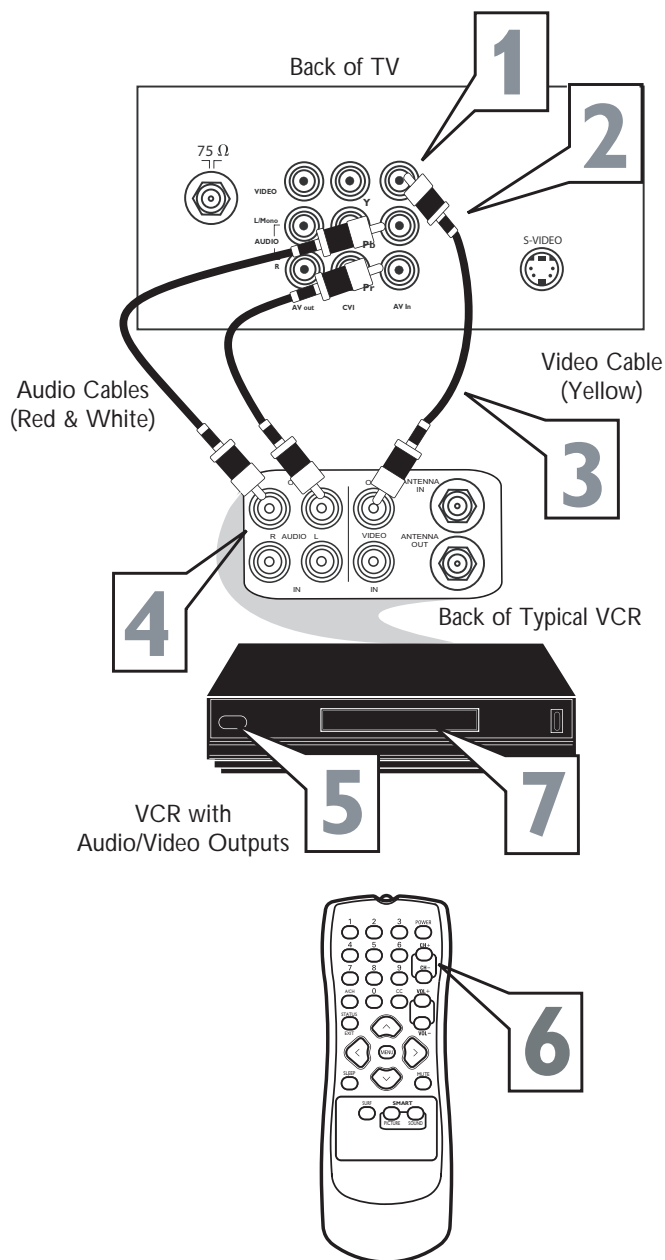

SIDE AV CONNECTIONS

Audio and Video side inputs are available for a quick connection of a VCR, Video camera, gaming device. Use the **CH+** or **CH-** button on the remote control to tune these inputs.

1 **Connect the VIDEO (yellow) cable** from the Video output on the Camera (or accessory device) to the Video (yellow) Input located on the SIDE (or FRONT) of the TV.

2 **For Stereo Devices:** Connect the audio cable (red and white) from the Audio Left and Right Outputs on the Camera to the Audio In (white) jack on the SIDE (or FRONT) of the television.

For Mono Devices: Connect one end of the audio cable from the Audio Out jack on the device to the Audio In (white) jack on the SIDE of the television.

3 Turn the TV and the accessory device **ON** .

4 **Press the CH+ or CH- button** on the remote control to tune the TV to the side input jacks. "**AV**" will appear on the TV screen.

5 **Press the PLAY ► button** on the accessory device to view playback, or to access the accessory device (camera, gaming unit etc.).

Side AV Inputs:

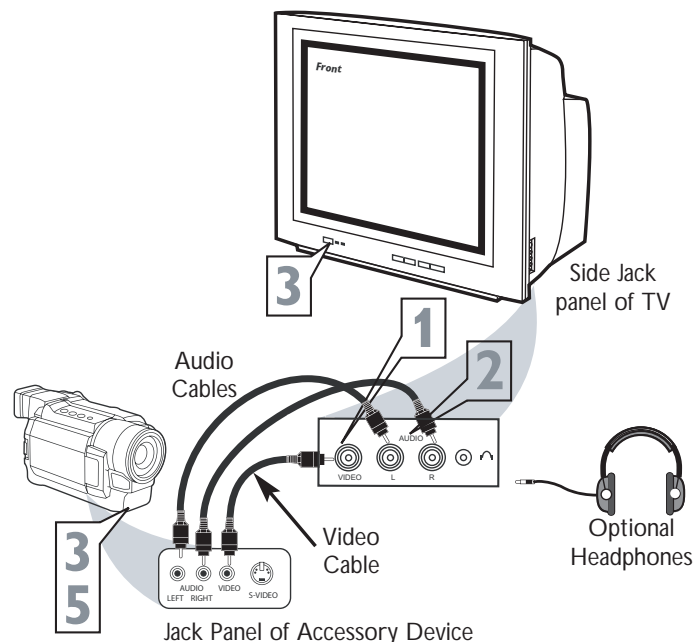

S-VIDEO (S-VHS) INPUT CONNECTIONS

The S(uper)-Video connection on the rear of the TV can provide you with better picture detail and clarity for the playback of accessory sources such as DBS (Digital Broadcast Satellite), DVD (Digital Video Disc), video games and S-VHS VCR (video cassette recorder) tapes than the normal antenna picture connections.

NOTE : The accessory device must have an - VIDEO OUT(put) jack in order for you to complete the connection on this page.

1 Connect one end of the **S-VIDEO CABLE** to the S-VIDEO jack to the back of the TV. Connect one end of the Audio (red and white) CABLES to the AV In AUDIO L and R (left and right) jacks on the rear of the TV.

2 Connect the other end of the **S-VIDEO CABLE** to the S-VHS (S-Video) OUT jack on the back of the VCR. Connect the other end of the AUDIO (red and white) CABLES to the AUDIO (red and white) CABLES to the AUDIO (left and right) OUT jacks on the rear of the VCR.

3 Turn the VCR and TV on.

4 Press the **CH+ or CH-** buttons on the remote control to scroll the channels until SVHS appears in the upper left corner of the TV screen.

5 Now you are ready to place a pre-recorded video tape in the VCR and **press the PLAY ► button**

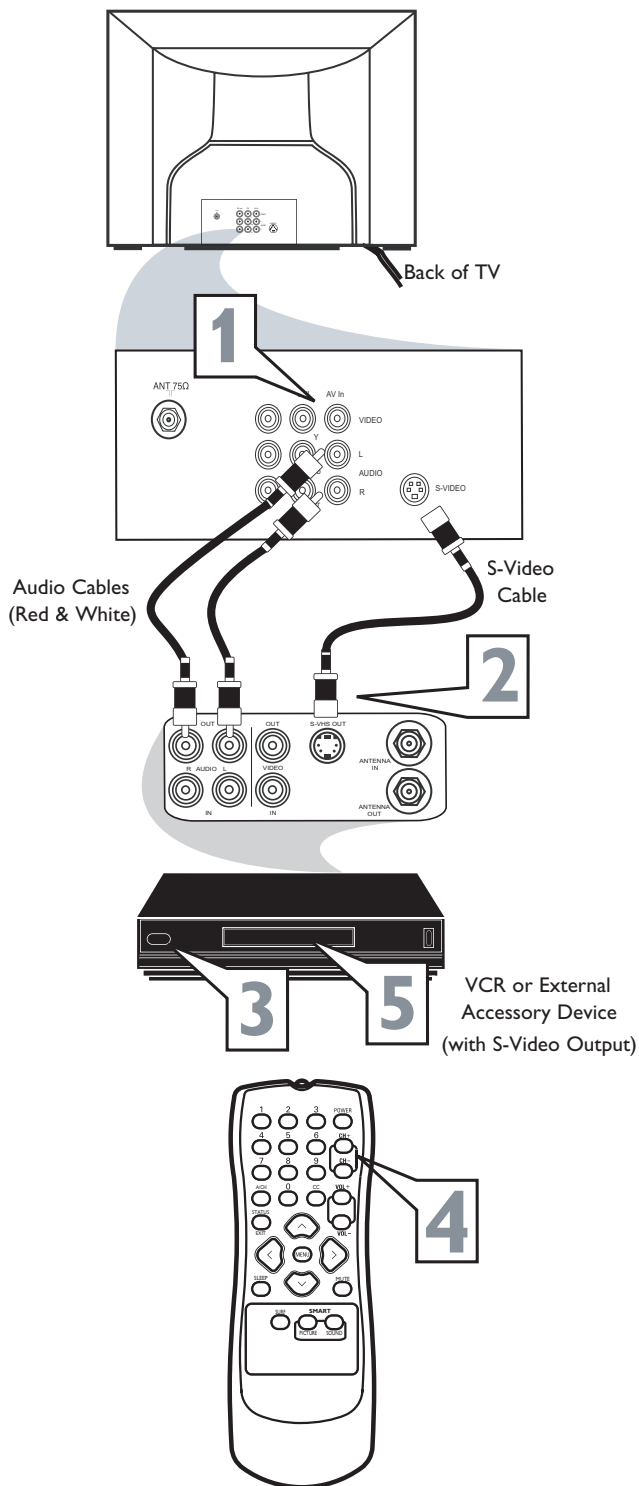

COMPONENT VIDEO (CVI) INPUT CONNECTIONS

Component Video inputs provide for the highest possible color and picture resolution on the playback of digital signal source material, such as with DVD players. The colour difference signals (Pb, Pr) and the luminance(Y) signal are connected and received separately, which allows for improved color bandwidth information (not possible when using composite video or S-Video connections).

- 1** Connect the Component (Y, Pb, Pr) Video **OUT** jacks from the DVD player (or similar device) to the (Y, Pb, Pr) in(put) jack on the TV. When using the Component Video Inputs, it is best not to connect a signal to the AV in Video Jack.
- 2** Connect the red and white **AUDIO CABLES** to the Audio (left and right) output jacks on the rear of the accessory device to the Audio (L and R) AV Input Jacks on the TV.
- 3** Turn the **TV and the DVD (or digital accessory device) ON.**
- 4** Press the **AV button or the CH+ or CH- buttons** on the remote control to scroll the channels until CVI appears in the upper left corner of the TV screen.
- 5** Insert a DVD disc into the DVD player and press the **PLAY ►** button on the DVD Player.

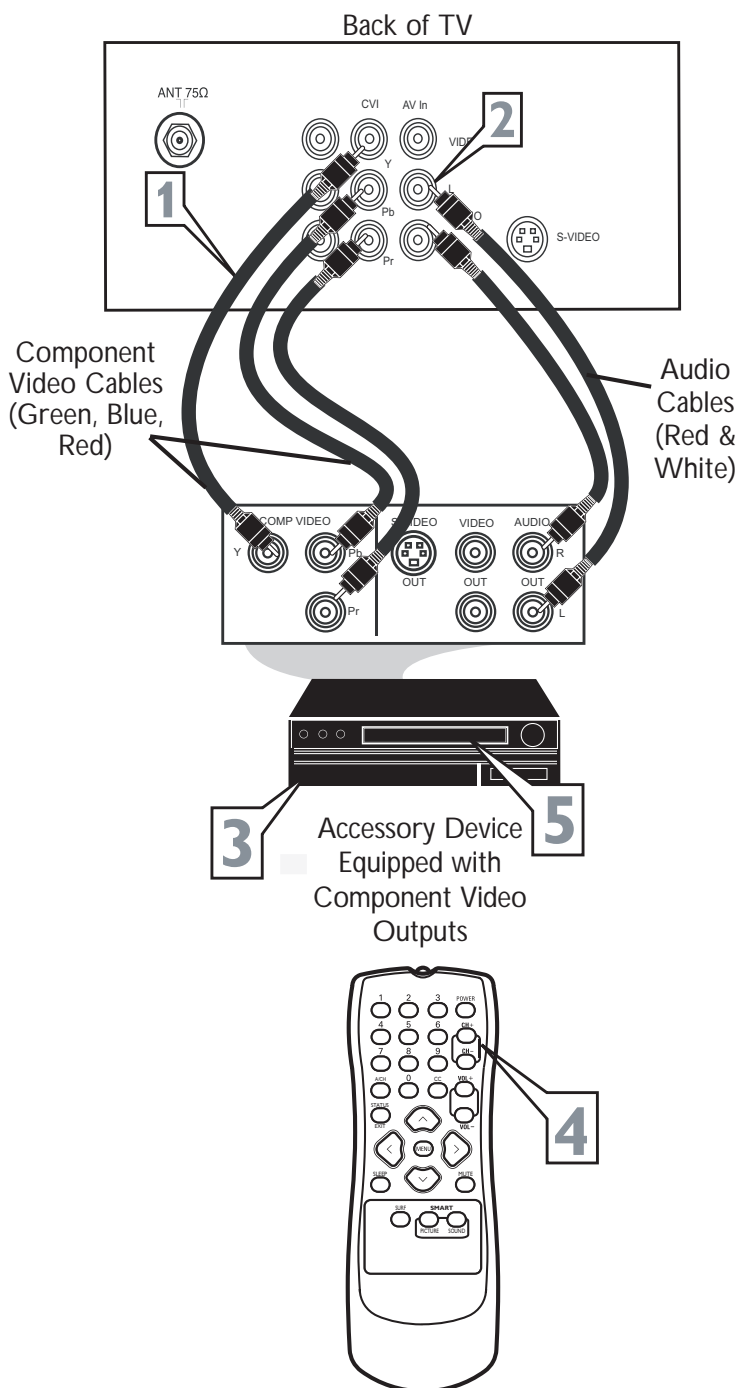

HELPFUL HINTS

The description for the component video connectors may differ depending on the DVD player or accessory digital source equipment used (for example, Y, Pb, Pr; Y, B-Y, R-Y; Y, Cr, Cb). Although abbreviations and terms may vary, the letters b and r stand for blue and red color component signal. Refer to your DVD or digital accessory owner's manual for definitions and connection details.

AV OUTPUT CONNECTIONS

The Audio/Video Output jacks are great for recording with a VCR or used to connect to external audio system for better sound reproduction.

AUDIO SYSTEM CONNECTION :

- 1 **Connect one end of the R(ight) and L(eft) AUDIO jacks** on the TV to the R and L audio input jacks on your amplifier or sound system. Set the audio system's volume to a normal listening level.
- 2 **Turn the TV and audio system on.** To adjust the volume of the audio system, you will need to change the volume at the external audio system, **not the television.**

AUDIO SYSTEM CONNECTION :

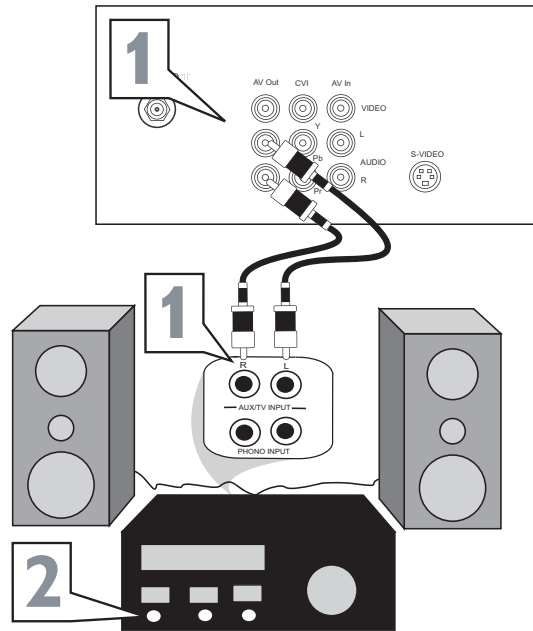

SECOND VCR CONNECTION :

NOTE : Refer to page 7 for the proper hookup of the first VCR. Follow the instructions on how to tune to the AV1 channel to view a pre-recorded tape.

The following steps allow you to connect a second VCR to record the program while watching it.

- 1 **Connect one end of the yellow Video Cable to the AV Out Video plug.** Connect the other end to the VIDEO IN plug on the second VCR.
- 2 **Connect one end of the red and white Audio cable from the AV Out AUDIO L and R plugs on the TV to the AUDIO IN plugs on the VCR.**
- 3 **Turn the Second VCR ON,** insert a VHS tape and its ready to record what's being viewed on the TV screen.

SECOND VCR CONNECTION :

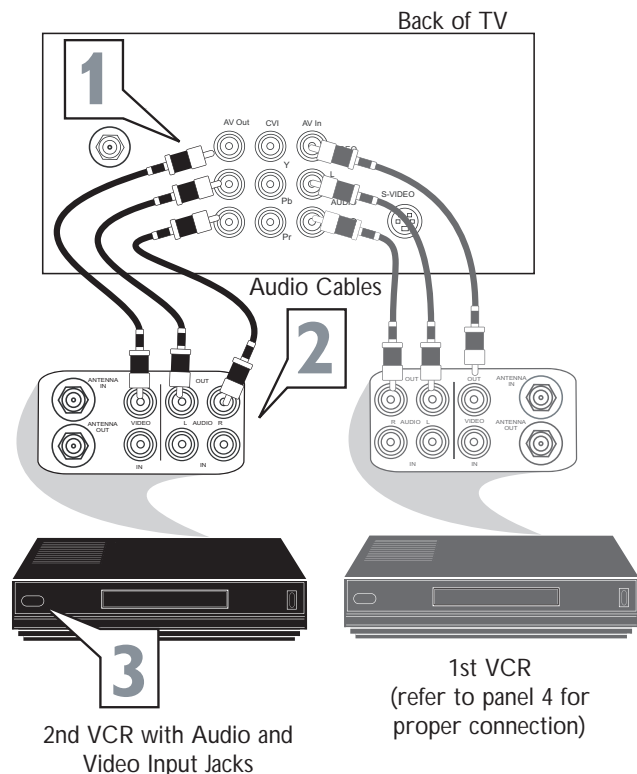

REMOTE CONTROL BUTTON DESCRIPTIONS

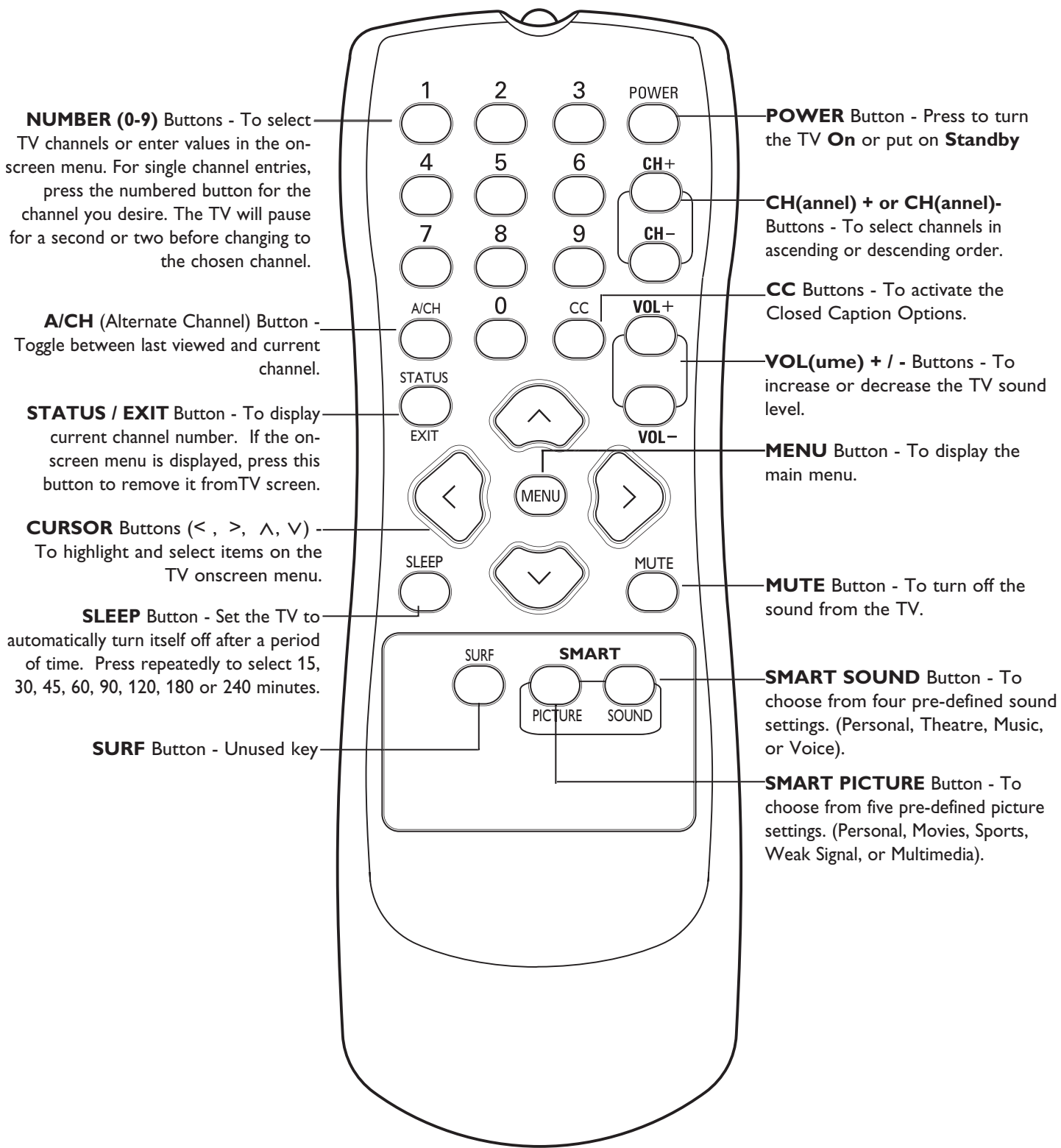

HOW TO USE THE LANGUAGE CONTROL

For French and Spanish speaking TV owners an on-screen LANGUAGE option present. With the LANGUAGE control you can set the TV's on-screen menu to be show in English, French or Spanish.

- 1** Press the **MENU** button on the remote control to show the on-screen menu.
- 2** Press the **CURSOR** \wedge or \vee to scroll through the on-screen menu until the word **INSTALL** is highlighted.
- 3** Press the **CURSOR** $\>$ to display the **INSTALL** menu features.
- 4** Press the **CURSOR** \wedge or \vee to scroll through the Install features until the word **LANGUAGE** is highlighted.
- 5** Press the **CURSOR** $\>$ repeatedly to select English, or Espanol (Spanish).
- 6** When finished, press the **STATUS / EXIT** button on the remote control to remove the menu from the TV's screen.

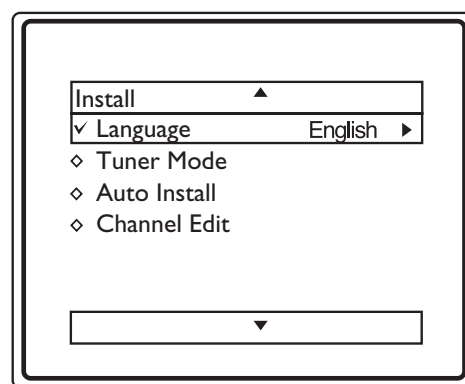
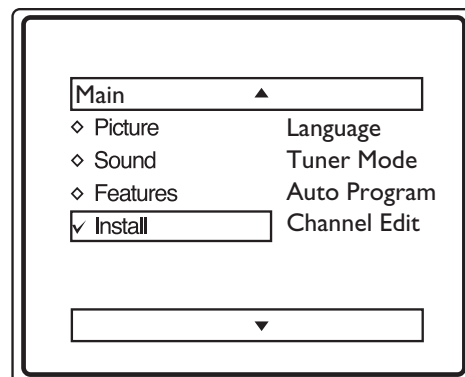

OR

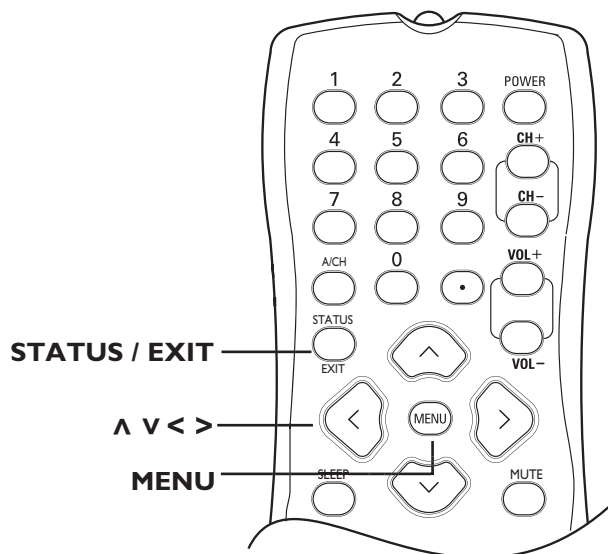
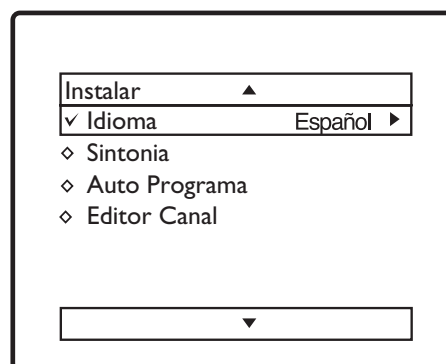

HOW TO USE THE TUNER MODE CONTROL

The TUNER MODE control allows you to change the TV's input signal to either ANTENNA, CABLE or AUTO mode. It is important for the TV to know which type of signal to look for (Antenna or Cable). In the AUTO mode, when the AUTO PROGRAM feature is activated, the TV will automatically choose the correct mode.

- 1 Press the **MENU** button on the remote control to show the on-screen menu.
- 2 Press the **CURSOR** \wedge or \vee to scroll through the on-screen menu until the word **INSTALL** is highlighted.
- 3 Press the **CURSOR** $\>$ to display the **INSTALL** menu features.
- 4 Press the **CURSOR** \wedge or \vee to scroll through the Install features until the word **TUNER MODE** is highlighted.
- 5 Press the **CURSOR** $\>$ to select **ANTENNA**, **CABLE** or **AUTO** mode.
- 6 When finished, press the **STATUS / EXIT** button on the remote control to remove the menu from the TV's screen.

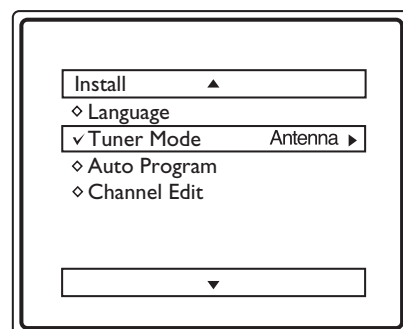
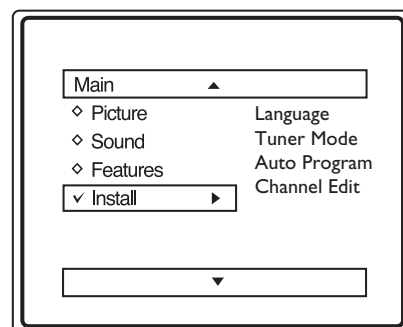

OR

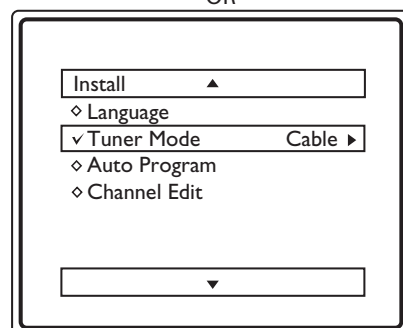

OR

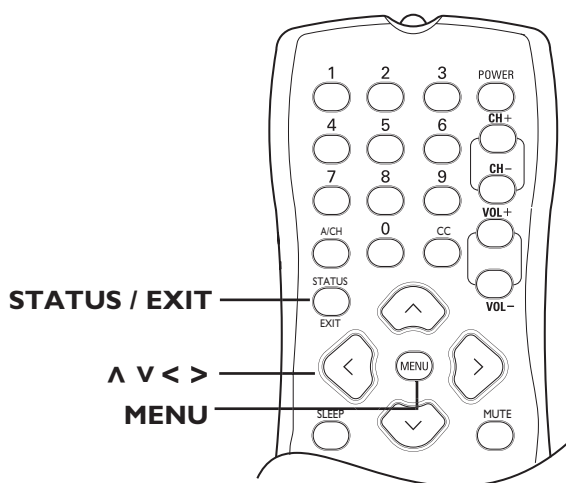
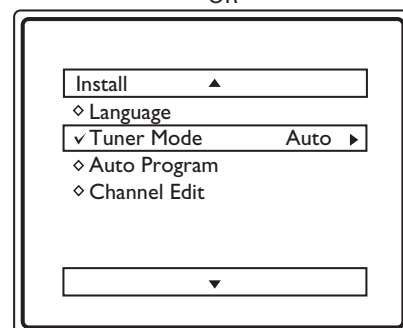

HELPFUL HINTS

When CABLE is selected, channels 1 - 125 are available.

When ANTENNA is selected, channels 2 - 69 are available.

When AUTO is selected, the TV will automatically set itself to the correct mode based on the type of signal it detects when the AUTO PROGRAM feature is activated.

AUTO PROGRAM

You can auto install programs on your TV. This makes it easy for you to select only the TV stations in your area when the **CH+** or **CH-** buttons are pressed.

NOTE : Ensure that the Antenna or Cable signal connection has been completed before AUTO PROGRAM is activated.

- 1 Press the **MENU** button on the remote control to show the on-screen menu.
- 2 Press the **CURSOR** \wedge or \vee to scroll through the on-screen menu until the word **INSTALL** is highlighted.
- 3 Press the **CURSOR** $\>$ to display the **INSTALL** menu features.
- 4 Press the **CURSOR** \wedge or \vee to scroll through the Install features until the word **Auto Program** is highlighted.
- 5 Press **CURSOR** $\>$ to start the Auto Program scanning of channels. Auto Programing will store all available channels in the TV's memory then tune to the lowest available channel when done.
- 6 When finished, press the **STATUS / EXIT** button on the remote control to remove the menu from the TV's screen.

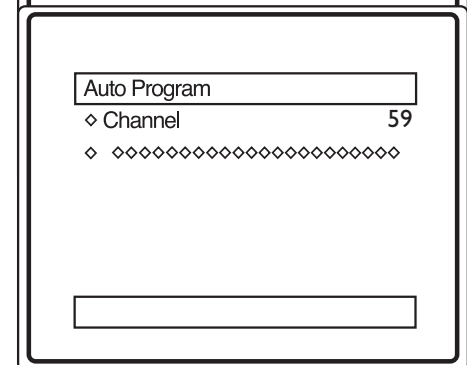
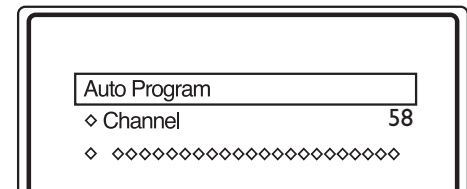
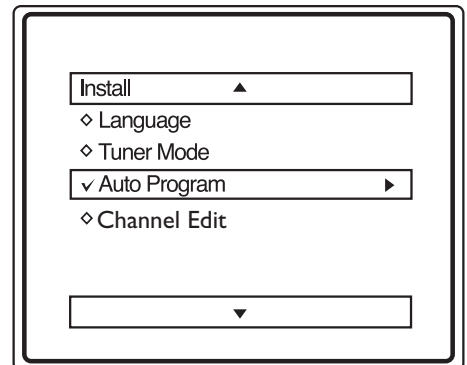
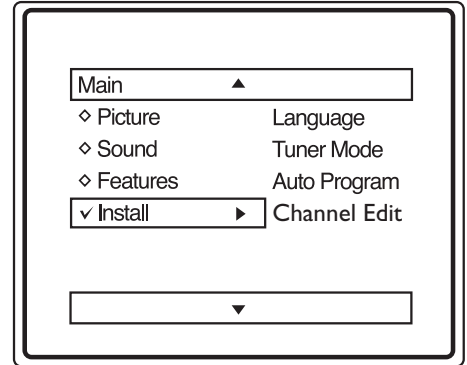
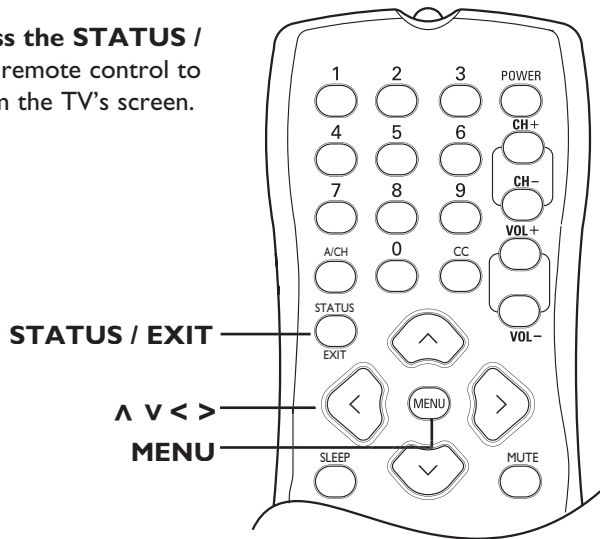

HELPFUL HINTS

- When CABLE is selected, channels 1 - 125 are available.
- When ANTENNA is selected, channels 2 - 69 are available.
- When AUTO is selected, the TV will automatically set itself to the correct mode based on the type of signal it detects when the AUTO PROGRAM feature is activated.

CHANNEL EDIT

Channel Edit makes it easy for you to **ADD** or **SKIP** channels from the list of channels stored in the TV's memory.

- 1** Press the **MENU** button on the remote control to show the on-screen menu.
- 2** Press **CURSOR** \wedge or \vee to scroll through the on-screen menu until the word **INSTALL** is highlighted.
- 3** Press **CURSOR** $\>$ to display the **INSTALL** menu features.
- 4** Press **CURSOR** \wedge or \vee to scroll through the Install features until the word **CHANNEL EDIT** is highlighted.
- 5** Press **CURSOR** $\>$ to select **CHANNEL EDIT** options.
- 6** With the **CHANNEL EDIT** options displayed, and **CHANNEL NO.** highlighted; you can use the **CURSOR** $\>$ OR $\<$ to scroll through all available channel that you wish to **ADD** (skipped OFF) or **SKIP** (skipped ON) from the TV's memory. You can also use the **NUMERIC** buttons to go directly to a specific channel that you want to add or skip. Or, you can use the **CH+** or **CH-** to scan through the channels that have not been skipped.
- 7** Using **CURSOR** \vee , scroll the menu to highlight the word **SKIPPED**.
- 8** Use **CURSOR** $\>$ to toggle between **ON** or **OFF**. If **ON** is selected the channel is skipped when scrolling channels with **CH+** or **CH-**. If **OFF** is selected the channel is not skipped when scrolling with **CH+** or **CH-**.
- 9** When finished, press **STATUS / EXIT** button on the remote control to remove the menu from the screen.

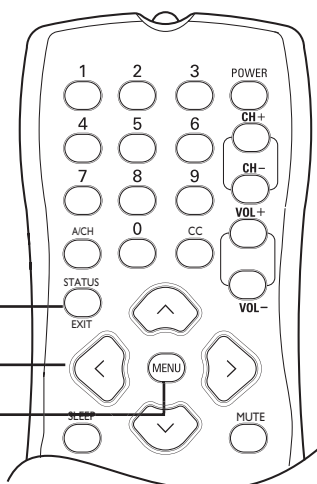
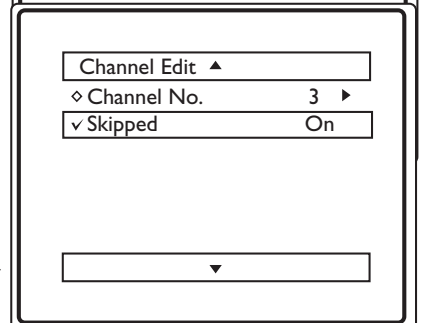
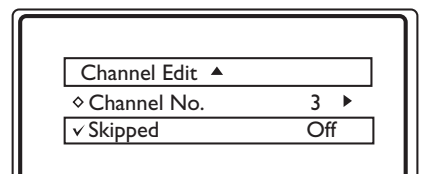
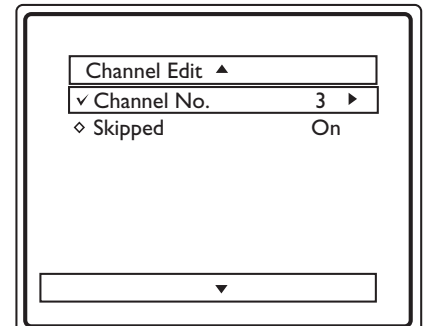
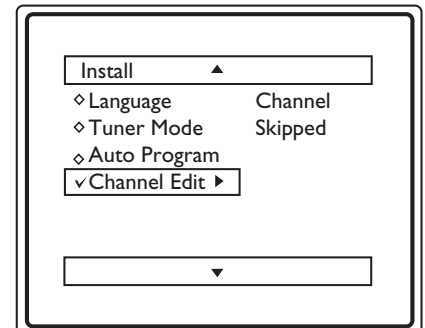
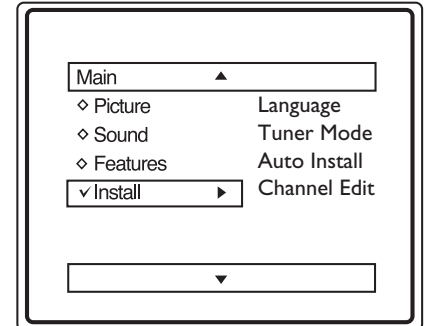

HELPFUL HINTS

An "X" appearing in front of any channel will indicate that channel has skipped ON. When the CH+ or CH- buttons are used, those channels will be skipped.

PICTURE MENU CONTROLS

To adjust your TV picture controls, select a channel and use the Picture Menu Controls listed below. Your selection is stored as **Personal**.

1 Press the **MENU** button on the remote control to display the onscreen menu.

2 Press **CURSOR** \wedge or \vee until the **Picture menu** feature is highlighted.

3 Press **CURSOR** $>$ or $<$ to adjust **Brightness Control** - until the darkest parts of the picture are as bright as you want.

Color - to add or remove color.

Picture - adjust until the lightest parts of the picture show good detail.

Sharpness - to improve sharpness in the picture.

Tint Control - adjust natural skin tones in the picture quality.

Color Temp - to select Normal, Cool, or Warm picture preferences. For Normal, whites will maintain their whiteness; Cool will make the whites bluish; and Warm will make the whites reddish.

Contrast + - when set to **On**, the Contrast + control helps to “sharpen” the picture quality. The black portions of the picture become richer in darkness and the whites become brighter.

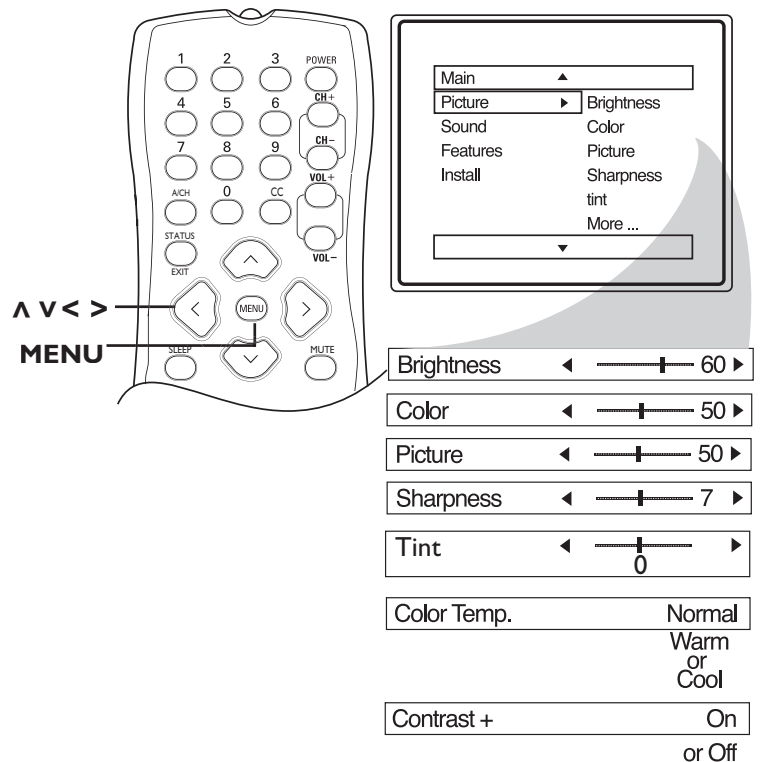

SMART PICTURE

Whether you're watching a movie or a sporting event, your TV has automatic video control settings to enhance your current program source or content.

1 Press **SMART PICTURE** button on the remote control. The current Smart Picture setting will display on the screen.

2 Press **SMART PICTURE** repeatedly to select either **Personal**, **Movies**, **Sports**, **Weak Signal** or **Multimedia** picture settings.

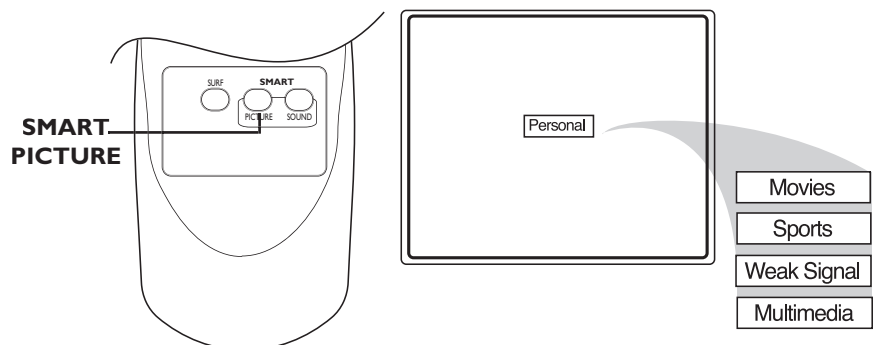

NOTE: The way you choose to set the Picture Menu Controls will become your Personal setting.

SOUND MENU CONTROLS

To adjust your TV sound controls, select a channel and use the Sound Menu Controls listed below. Your selection is stored as **Personal**.

1 Press the **MENU** button on the remote control to display the onscreen menu.

2 Press **CURSOR** \wedge or \vee until the **Sound** menu feature is highlighted.

3 Press **CURSOR** $>$ or $<$ to adjust **Treble** - The control will enhance the high frequency sounds.

Bass - The control will enhance the low frequency sounds.

Balance - Level of sound coming from the left and right speakers.

AVL (Auto Volume Leveler) - When On, AVL will level out the sound being heard when sudden changes in volume occur during commercial breaks or channel changes.

INCR. SURROUND - Select **Incr. Surround** or **Stereo** settings if you're in **Stereo mode**. Select **Mono** or **Spatial** if you're in Mono mode.

Ultra Bass - Toggles Ultra Bass On or Off. When On, low frequency sound will be enhanced.

Sound - Toggles between **Stereo** or **Mono** settings.

Note: If **Stereo** is not present on a selected show and the TV is in **Stereo mode**, the sound coming from the TV will remain in the **Mono mode**.

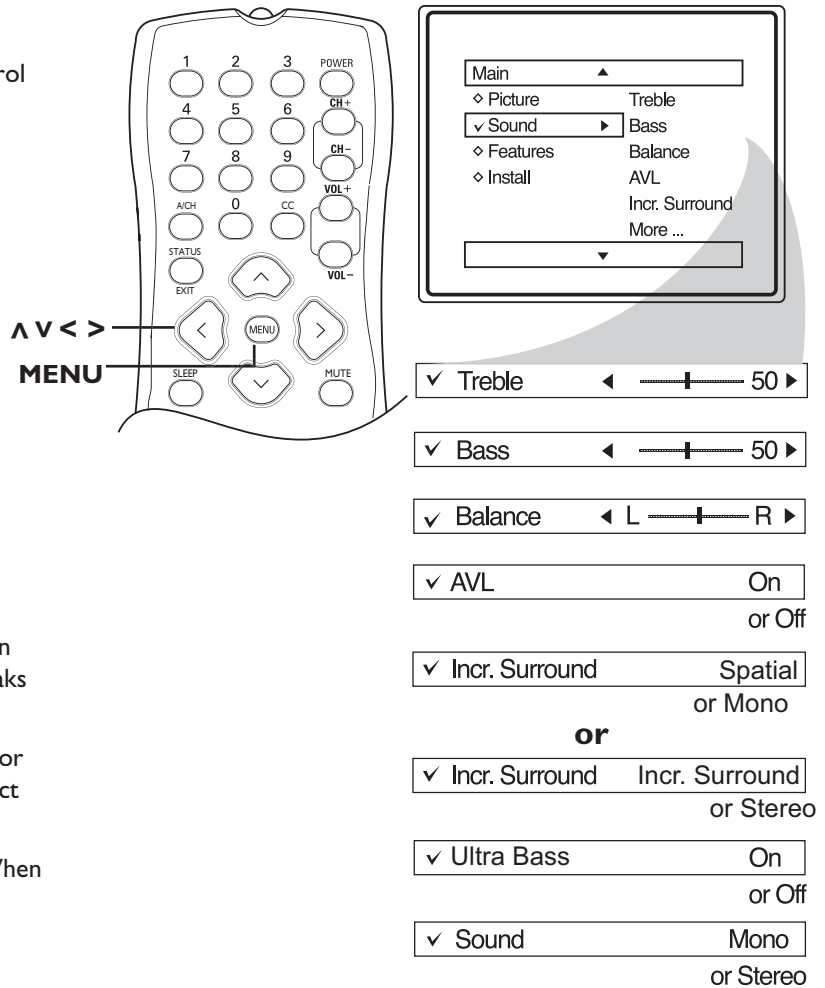

SMART SOUND

The Auto Sound feature allows the listener to select between four different pre-set sound options.

1 Press **SMART SOUND** button on the remote control. The current **Smart Sound** setting will be displayed in the middle of the TV screen.

2 Press **SMART SOUND** repeatedly to toggle between the four settings. (**Personal**, **Theatre**, **Music**, or **Voice**).

NOTE: The way you choose to set the Sound Menu Controls will become your **Personal** setting.

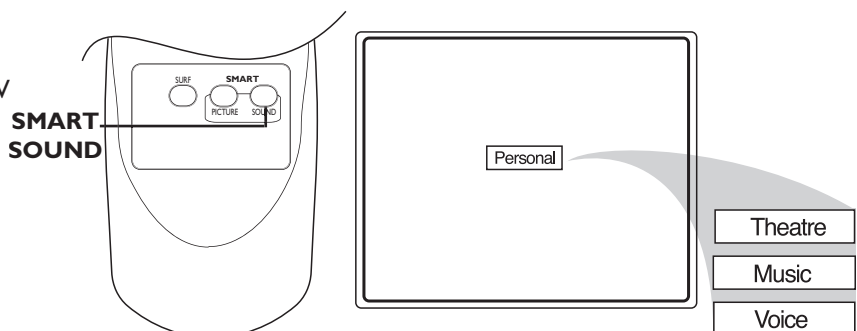

THE 4:3 EXPAND FORMAT CONTROL

Many times while watching movies from a DVD player, the image is shown in “letterbox” format. This is the format shown in movie theaters. When shown on TV screen, the image will have areas of black on top and bottom of the screen.

- 1 Press **MENU** button on the remote control to display the onscreen menu.
- 2 Press **CURSOR** ∇ until **Features** is highlighted.
- 3 Press **CURSOR** \triangleright to display the **Features menu** options (SmartLock or Format).
- 4 Press **CURSOR** ∇ to highlight **Format**.
- 5 Press **CURSOR** \triangleright or \triangleleft to select one of the two options **4:3** or **Expand 4:3**.
4:3 - Standard format for the TV.
Expand 4:3 - Enlarges the picture to fill out the entire screen area, eliminating the “letterbox” effect.
- 6 When finished, press **STATUS / EXIT** button on the remote control to remove the menu from the TV’s screen.

NOTE : The Expand 4:3 and can also be activated using the **CURSOR** \wedge or \vee when the onscreen menu is not being displayed. Pressing these buttons will toggle between **Standard 4:3** and **Expand 4:3**.

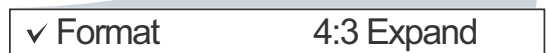
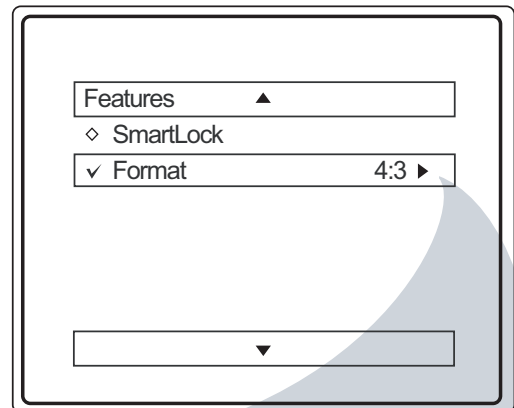

4:3



Expand 4:3

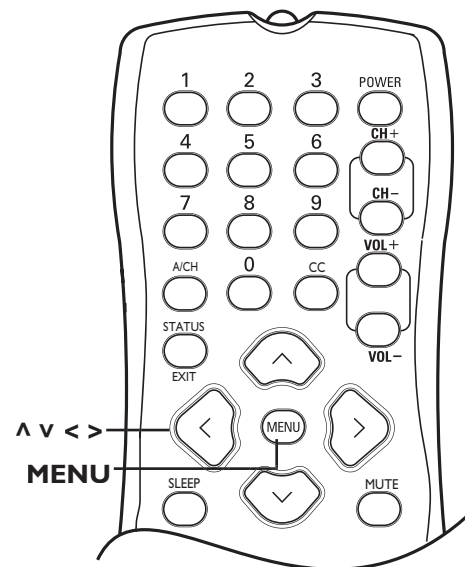

UNDERSTANDING SMARTLOCK CONTROLS

SmartLock is a feature that lets the TV receive and process data sent by broadcasters or other program providers with program content advisory. When programmed by the viewer, a TV with SmartLock can respond to the content advisory and block program content that may be found objectionable (such as offensive language, violence, sexual situations, etc.). This feature is useful for adults to prevent certain types of programs from being viewed by children.

SmartLock offers various BLOCKING controls to choose from:

Access Code - An Access Code must be set to prevent children from unblocking questionable or censored programming set by their parents.

Channel Block - After an access code has been programmed, you can block individual channels including the A/V inputs.

Clear All - Lets you clear all channels being blocked from your viewing set with the Channel Block Control.

Block All - Lets you block ALL channels including A/V inputs.

No Rating - ALL programing with no content advisory data can be blocked if **NO RATING** is set to ON.

Movie Ratings - Certain blocking options exist which will block programming based on ratings patterned by the Motion Pictures Association of America (MPAA).

TV Ratings - Like the Movie Ratings, programs can be blocked from viewing using standard TV ratings set by TV broadcasters.

Unrated - ALL unrated programs based on the Movie Ratings or Parental TV Guidelines can be blocked if **UNRATED** is set to ON.

MOVIE RATINGS

G: General Audience - All ages admitted. Suitable for all ages.

PG: Parental Guidance Suggested - Contains material unsuitable for younger children.

PG-13: Parents Strongly Cautioned - Contains material unsuitable for children under the age of 13.

R: Restricted - Suitable for adults above 17 years of age only.

NC-17: No one under the age of 17 will be admitted.

X: Adults Only - Contains one or more of the following: very graphic violence, very graphic and explicit or indecent sexual acts, very coarse and intensely suggestive language.

TV RATINGS

TV-Y : Designed for a very young audience, including children ages 2-6

TV-Y7: Appropriate for children age 7 and above who have acquired the development skills needed to distinguish between make-believe and reality.

acquired the development skills needed to distinguish between make-believe and reality.

TV-G : Suitable for most audiences. Contains little or no violence, no strong language, and little or no sexual dialogue or situations.

TV-PG: Contains material unsuitable for younger children. Could contain Moderate violence (V), some sexual situations (S), infrequent coarse language (L), or some suggestive dialogue (D).

TV-14: Contains some material unsuitable for children under 14 years of age. Contains one or more of the following: intense violence (V), intense sexual situations (S), strong coarse language (L), or intensely suggestive dialogue (D).

TV-MA - Viewed by adults and therefore may be unsuitable for children under 17. Contains one or more of the following: graphic violence (V), explicit sexual situations (S), or crude indecent language (L).

SETTING UP AN ACCESS CODE

Over the next few pages you'll learn how to block channels . To get a better understanding of the rating terms for certain programs refer to previous page.

Let's start by learning how to set a personal access code :

- 1 Press **MENU** button on the remote control to display the onscreen menu.
- 2 Press **CURSOR** \wedge or \vee until **Features** is highlighted.
- 3 Press **CURSOR** $\>$ to display the **Features menu** options (SmartLock or Format).
- 4 Press **CURSOR** \wedge or \vee until the word **SMARTLOCK** is highlighted.
- 5 Press **CURSOR** $\>$ and the screen will read, **"ACCESS CODE - - - - ."**
- 6 Using the **NUMBERED** buttons enter **0 7 1 1**. **"XXXX"** appears on the Access Code screen as you press the numbered buttons. **"INCORRECT CODE"** will appear on the screen and you will need to enter 0 7 1 1 again.
- 7 The screen will ask you to enter a "New Code". Enter a **"new"** 4 digit code using the **NUMBERED** buttons on the remote control. You will be asked to CONFIRM the code. Enter the new code again **"XXXX"** will appear when you enter your new code and then display the SmartLock menu options.

Proceed to the next page to learn more....

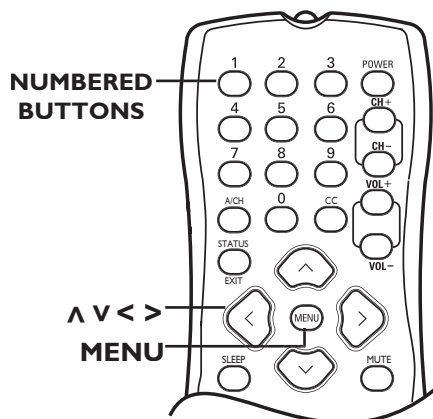
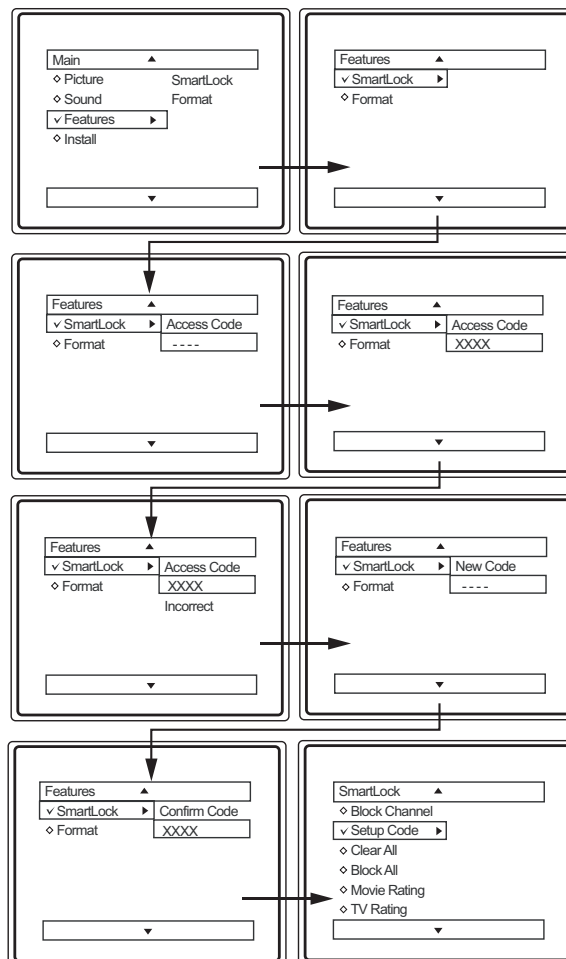

BLOCK CHANNELS

After your personal access code has been sent (see previous page), you are now ready to select the channels or the A/V inputs you want to block out or censor. Once you've entered your access code and the SmartLock features are displayed on the screen :

- 1 Press the **CURSOR** \wedge or \vee until the words **BLOCK CHANNELS** are highlighted.
- 2 Press **CURSOR** $>$ to turn blocking **ON** or **OFF** for that channel. When **ON** is selected the channel will be blocked.
- 3 Press **CH+** or **CH-** to select other channels you wish to block. Repeat step 2 to block the new channel.
- 4 To Unblock a channel, use the **CH+** or **CH-** to scroll to the channel you wish to unblock. The screen will show a message telling you that the channel has been blocked by SmartLock and you have to Enter your Access Code to unblock the channel.
- 5 Use the **NUMBER** Buttons, key in your Access Code. The Blocked channel will be UnBlocked.
- 6 When finished, press the **STATUS / EXIT** button on the remote control to remove the menu from the screen.

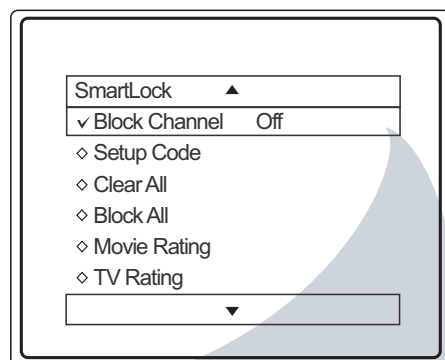

✓ Block Channel On

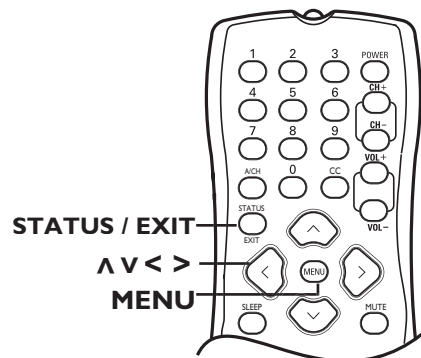
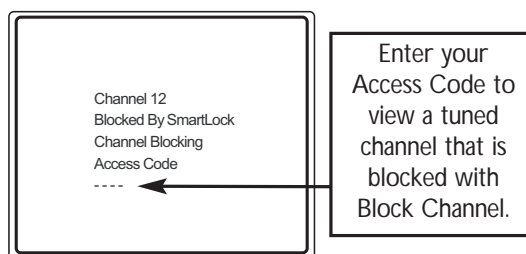

NOTE : If you forget your code, key 0 7 1 1. This is the factory default. Enter this code to create a new access code.

BLOCK / CLEAR ALL CHANNELS AT THE SAME TIME

This is a continuation of the previous page. After blocking specific channels there may come a time when you want to block or clear all the channels at the same time.

Once you've entered your access code and the SmartLock features displayed on the screen;

- 1 Press the **CURSOR** \wedge or \vee to select either **CLEAR ALL** or **BLOCK ALL**.
- 2 If **CLEAR ALL** is selected, press **CURSOR** $\>$ to clear all blocked channels. All channels will be viewable. Now all blocked channels can be viewed.
If **BLOCK ALL** is selected, press **CURSOR** $\>$ to turn the control **ON** or **OFF**. When **ON** is selected, ALL available channels will be blocked from viewing.

- 3 When finished, press the **STATUS/EXIT** button on the remote control to remove the menu from the screen.

NOTE : If you forget your code, key **0 7 1 1**. This is the factory default. Enter this code to create a new access code.

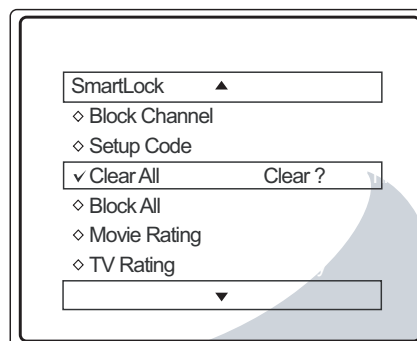

✓ Clear All Cleared

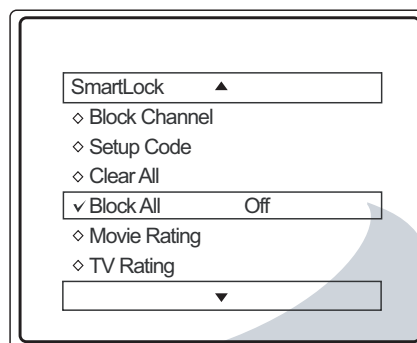

Block All On

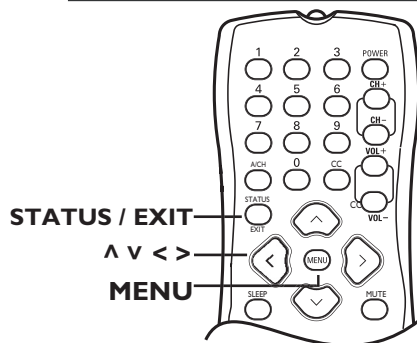

MOVIE RATINGS

The SmartLock feature can block programs based on the Move Industry ratings.

Once you've entered your access code and the SmartLock features displayed on the screen;

- 1 Press **CURSOR** \wedge or \vee to highlight the words **MOVIE RATING**.
- 2 Press **CURSOR** $>$ button to display the **MOVIE RATING** options (G, PG, PG-13, R, NC-17, or X)
- 3 Press **CURSOR** \wedge or \vee to highlight any of the Movie Rating options. When highlighted, all these options can be turned **ON** (which will allow blocking) or **OFF** (which will allow viewing).
- 4 Use **CURSOR** $>$ to turn the rating option **ON** or **OFF**.

NOTE : If you forget your code, key 0 7 1 1. This is the factory default. Enter this code to create a new access code.

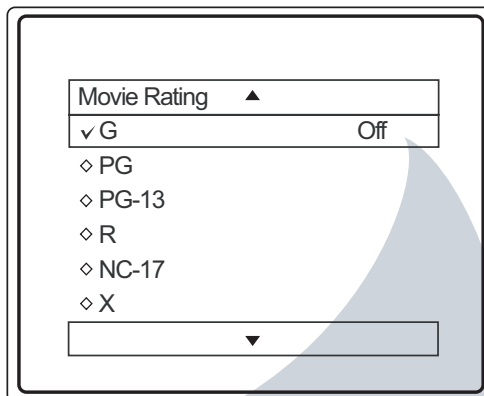
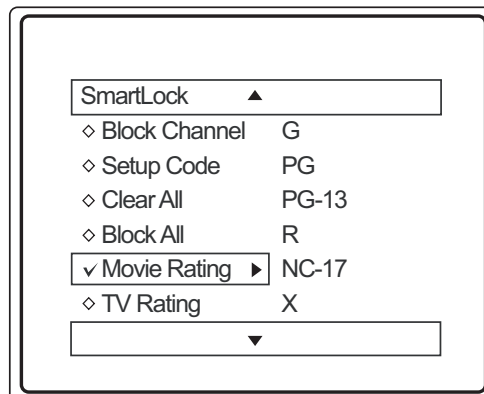

▽ G On

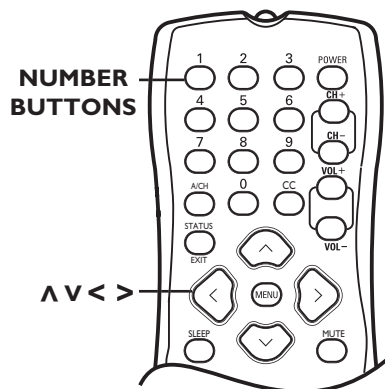

TV RATINGS

The SmartLock feature can block programs based on the TV Industry ratings.

Once you've entered your access code and the SmartLock features displayed on the screen;

- 1 Press **CURSOR** \wedge or \vee to highlight the words **TV RATING**.
 - 2 Press **CURSOR** $>$ button to display the **TV RATING** options (TV-Y, TV-Y7, TV-G, TV-PG, TV-14 or TV-MA)
 - 3 Press **CURSOR** \wedge or \vee to highlight any of the TV Rating options. When highlighted, all these options can be turned **ON** (which will allow blocking) or **OFF** (which will allow viewing).
- NOTE** : Some TV Rating options also have sub-ratings. The ratings of TV-Y7, TV-G, TV-14, TV-MA can be customized to block V (violence), FV (fantasy violence), S (sex scenes), L (coarse language), or D (Suggestive dialogue).
- 4 Press **CURSOR** $>$ to turn the TV-Y or TV-G rating **ON** or **OFF**. Or, press **CURSOR** $>$ to enter the sub-menu for the TV-Y7, TV-PG, TV-14 or TV-MA ratings.
 - 5 If the TV-Y7, TV-PG, TV-14 or TV-MA sub-menu is accessed, press **CURSOR** \wedge or \vee to select one of the options (Block All, V, S, L, D or FV).
 - 6 Press **CURSOR** $>$ to turn the option **ON** or **OFF**.

NOTE : If you forget your code, key 0 7 1 1. This is the factory default. Enter this code to create a new access code.

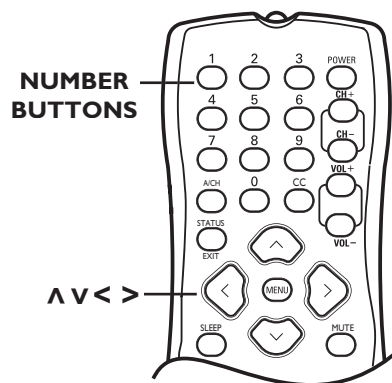
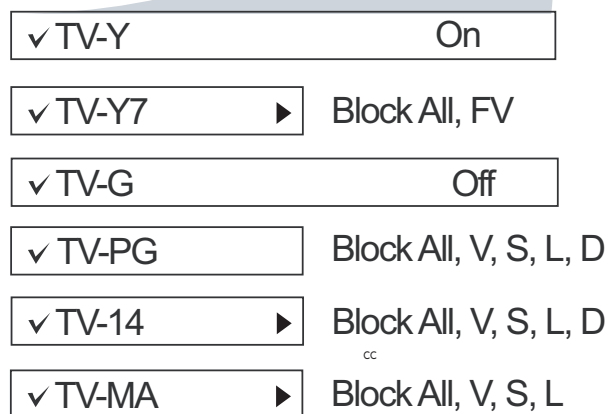
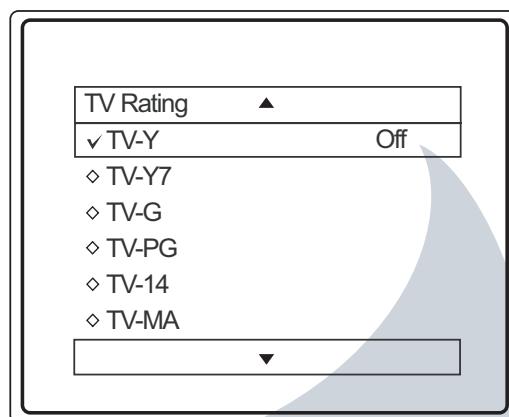

BLOCKING OPTIONS

SmartLock offers the viewer other blocking options as well. With these Blocking options, the censoring can be turned ON or OFF.

Once you've entered your access code and the SmartLock features displayed on the screen;

- 1 Press **CURSOR** \wedge or \vee until the words **BLOCKING OPTIONS** are highlighted.
- 2 Press **CURSOR** $>$ button to display the **Blocking Options (BLOCKING, UNRATED or NO RATING)** menu.

BLOCKING : Might be called the "master switch" for SmartLock. When ON, all blocking / censoring will take place. When OFF, all blocking is disabled.

UNRATED : All unrated programs based on the Movie Ratings or Parental TV Guidelines can be blocked if this feature is set to ON and the **BLOCKING** feature is set to ON.

NO RATING : All programs with NO content advisory data can be locked if it is set to ON and the **BLOCKING** feature is set to ON.

- 3 Press **CURSOR** \wedge or \vee to highlight the desired feature.
- 4 When highlighted, each feature can be turned **ON** or **OFF** using **CURSOR** $>$ or $<$.

NOTE : If you forget your code, key **0 7 1 1**. This is the factory default. Enter this code to create a new access code.

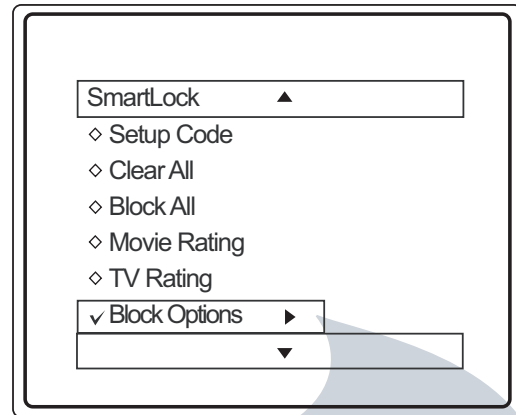

✓ Unrated	On
✓ No Rating	On
✓ Blocking	On

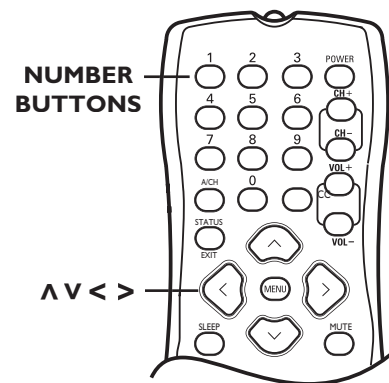

CLOSE CAPTIONING

Close Captioning (CC) allows you to read the voice content of television programs on the TV screen. Designed to help the hearing impaired, this feature uses onscreen "text boxes" to show dialogue and conversations while the TV program is in progress.

- 1 Press the **CC** button to display the current Closed Caption settings.
- 2 Press the **CC** button repeatedly to choose from the four Closed Caption options (CC Off, CC1, CC Mute).
- 3 When finished, press the **STATUS/EXIT** button on the remote control to remove the menu from the TV screen.

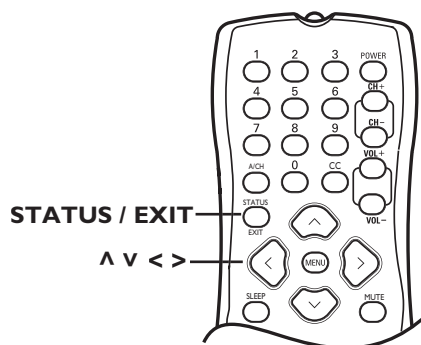
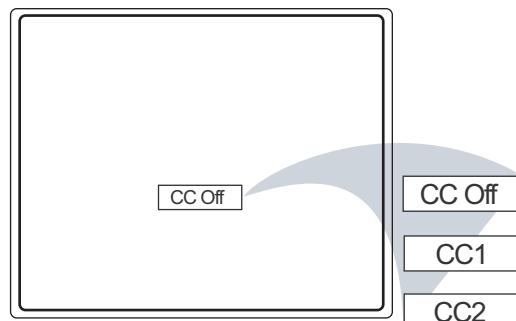

HELPFUL HINTS

You will not be able to see Close Captions if the broadcaster does not provide Close Captioning text with the program that is transmitted.

SLEEPTIMER

The SleepTimer feature allows you to set a timer to automatically turn the TV off after a period of time you choose - 15, 30, 45, 60, 90, 120, 180 or 240 minutes.

- 1 Press **SLEEP** button on the remote control to display the sleeptimer menu.
- 2 Press **SLEEP** button on the remote control to select the amount of time (15, 30, 45, 60, 90, 120, 180 or 240 minutes) before the TV automatically switches Off.

NOTE: An onscreen countdown will appear during the last minute before the TV switches Off. If any button is pressed during the last minute of the countdown, the Sleep Timer setting will be cancelled.

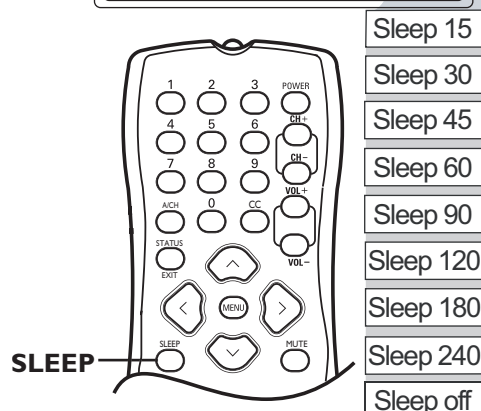
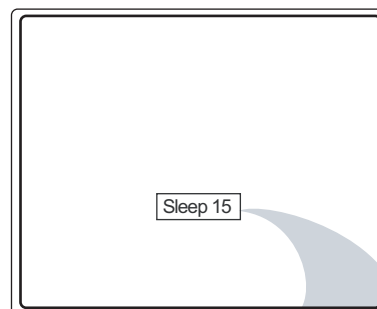

(ALTERNATING CHANNELS)

Your remote control has an **A/CH** (Alternate Channel) button which allows you to toggle between the current channel you are watching and the previous channel.

- 1 Press **A/CH** on the remote control to toggle between the current and previous channel.

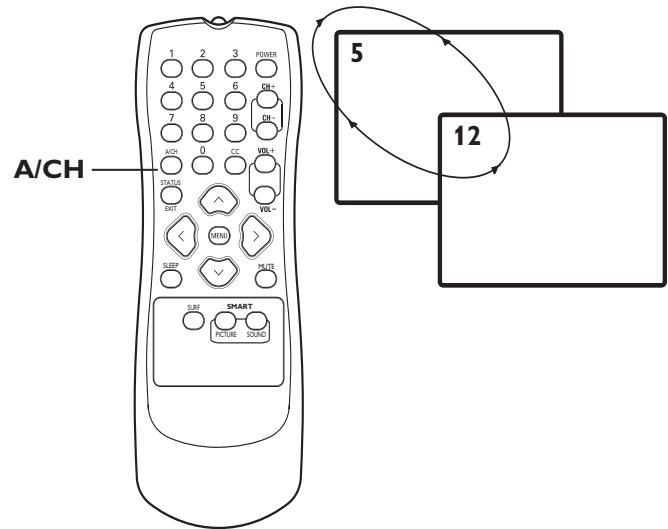

GLOSSARY

4:3	4:3 is an aspect ratio of traditional squarish National Television Systems Committee (NTSC) TV screens; it stands for four units of width for every three units of height.
Audio Video (A/V)	A term often used when discussing a channel on a TV receiver or on video equipment, which has been especially designed to accept VCR audio-video signals. This channel automatically activates special circuitry within the TV set to prevent picture distortion and skewing. It is also used for audio-video processors, which handle both types of signals.
Cable Converter Box	A device that allows your television to receive the expanded number of channels provided by broadcasters. Some of these programs provided by the broadcast may not be free, you'll have to pay to view them.
Coaxial Cable	Coaxial cable is a copper cable used to connect cable signal coming from Cable TV Company to the TV.
Composit Video Input Connection	An analog encoded video signal that includes vertical and horizontal synchronizing information. Since both luminance (brightness) and chrominance (color) signals are encoded together, only a signal connection wire is needed. A composite video jack is usually a single RCA-type.
Component Video Input Connection	Provides the highest possible color and picture resolution on the playback of digital signal source material like DVD players. The color difference signals (Pb, Pr) and the luminance(Y) signals are connected separately which allows for improved color bandwidth information (not possible when using composite video or S-Video connections).
Letterbox	Letterbox refers to the image of a wide-screen picture on a standard 4:3 aspect ratio television screen, typically with black bars on the top and bottom.
Luminance	The brightness or black-and-white component of a color video signal. Determines the level of picture detail.
NTSC	National television system committee. The organization that developed the analog television standard currently in use in the U.S., Canada, and Japan. Now generally used to refer to that standard. The NTSC standard combines blue, red, and green signals modulated as an AM signal with an FM signal for audio.
S-Video	Separated video. An encoded video signal which separates the brightness from color data. S-Video can greatly improve the picture when connecting TVs to any high quality video source such as digital broadcast satellite (DBS) and DVDs.

TROUBLESHOOTING TIPS

Check this List of **Symptoms** and **Suggested Steps To Take** before requesting Service. You may be able to solve the problem yourself. If you face problems connecting the TV to external devices, please refer to the User Guide of the external device or call their service centers for help. Charges for TV installation and adjustments of customer controls are not covered under your warranty.

SYMPTOMS		SUGGESTED STEPS TO TAKE
Installation	Can't get the AV channels on the TV screen.	Press the CH+ / CH- button on the remote control repeatedly to select the desired AV channels. Note: SVHS can only be selected if a S-VHS device is connected and powered on.
Installation	TV Displays Wrong Channel or No Channels Above 13	Go to TUNER MODE in the television menu and select the correct signal source, then perform the automatic installation again. (Refer to page 15).
Installation	Channel numbers do not follow the channel number of the programs.	Go to TUNER MODE in the television menu and select the correct signal source, then perform the automatic installation again. (Refer to page 15).
Sound	Disturbing sound (such as buzzing, clicking, cracking, humming, whistling, etc).	It is normal to hear a disturbing sound (such as buzzing, clicking, cracking, humming, whistling, etc) from a distance less than 2 meters (6 feet) with the television sound muted. If problem occurs on one channel, you may have a signal problem. Please contact the cable provider or local broadcaster regarding the specific channel.
Sound	Sound is not in Stereo.	This could be due to any of the following reasons: 1. Not all transmitted broadcasts by the cable or broadcast stations are in STEREO. Try checking with several major network stations to be sure that the station you selected is in STEREO. 2. When SAP is turned ON, the sound mode is automatically set to MONO. 3. Sound mode is set to MONO. Set the sound mode to STEREO. (Refer to page 19). 4. When using an AV input, the television will not display STEREO even though it is producing stereo sound.
General	No power to the TV	Check the TV power cord. Unplug the power cord from the TV, wait 10 seconds, then reinsert the plug into your wall outlet. Power On the TV again. Plug the power cord directly to the wall socket and not via an extension cord. If you need to use an extension cord, check that the fuse on the AC power strip is not blown.
General	TV is not responding to Remote Control	Ensure the batteries are inserted into the remote control according to the illustration in the battery compartment. Refer to page 6. Reset the television by disconnecting the power plug from the wall outlet for 10 seconds and then reconnecting it again.
General	Remote control is not working	Ensure the batteries are inserted into the remote control according to the illustration in the battery compartment. Refer to page 6. Reset the television by disconnecting the power plug from the wall outlet for 10 seconds and then reconnecting it again.
General	TV Displays white lines in letterbox when viewing a DVD disc	Some DVD Discs are encoded with as much as 30% more video information to give the best possible picture quality. With the DVD Player in the "letterbox" picture format, the playback of this type of disc with extra video information can produce a number of small white lines in the upper portion of the black letterbox area. With some of these discs, this problem is inherent and does not require a service call.

CLEANING AND CARE

WARNING Concerning Stationary Images on the TV Screen:

Do not leave stationary or letterbox images on screen for extended periods of time. This can cause uneven picture-tube aging.

Normal use of the TV should involve the showing of pictures that contain constantly moving and changing images that fill the screen. Be careful not to leave nonmoving images on screen for extended periods of time, or to display the same images on screen too frequently, because subtle ghost images can be left on the picture tubes. Sources of stationary images may be DVD disks, laser disks, video games, CD-i disks, videotapes, digital television boxes, broadcast channels, cable channels, satellite channels, and others. Here are some examples of stationary images (this is not an all-inclusive list; you may encounter others in your viewing):

- DVD menus—listings of DVD disk content
- Letterbox black bars—shown at the top and bottom of the TV screen when a wide screen (16:9) movie is viewed on a TV with standard (4:3) aspect ratio.
- Video-game images and scoreboards
- Television station logos—present a problem if they are bright and stationary; moving or low-contrast graphics are less likely to cause uneven aging of the picture tube
- Stock-market tickers—presented at the bottom of the TV screen
- Shopping channel logos and pricing displays—bright and shown constantly or repeatedly in the same location on the TV screen.

Placement of the TV

- To avoid cabinet warping, cabinet color changes, and increased chance of set failure, do not place the TV where temperatures can become excessively hot; for example, in direct sunlight or near a heating appliance.
- Be sure to allow a free flow of air to and from the perforated back cover of the set.

Cleaning

- To avoid possible shock hazard, be sure the TV is unplugged from the electrical outlet before cleaning.
- Regularly dust the TV with a dry, nonscratching duster to keep the TV clean.
- When cleaning the TV, take care not to scratch or damage the screen surface. Avoid wearing jewelry or using anything abrasive. Do not use household cleaners. Wipe the front screen with a clean cloth dampened with water. Use even, easy, vertical strokes when cleaning.
- Gently wipe the cabinet surfaces with a clean cloth or sponge dampened in a solution of cool, clear water and a mild soap or detergent. Use a clean, dry cloth to dry the wiped surfaces.
- Occasionally vacuum the ventilation holes or slots in the back cover of the set.
- Never use thinners, insecticide sprays, or other chemicals on or near the cabinet, as they might cause permanent damage of the cabinet finish.

SPECIFICATIONS

	20MT4405
PICTURE / DISPLAY	
Aspect ratio :	4:3
Picture Display Picture Enhancement	20" Real Flat Picture, Smart Picture (5 modes) Color, Contrast, Sharpness Control
SOUND	
Sound Power (Output RMS) Sound Enhancement	2 x 3W Incredible Surround
CONVENIENCE	
	Auto Program Closed Captioning Full text Parental Lock
ON SCREEN DISPLAY LANGUAGES	English, Spanish
CONNECTIVITY	
Rear	AV1: CVBS in, CVI
	AV2: CVBS in, S-Video
Side	AV3: Monitor Out
	CVBS in, Headphone Out
WEIGHT & DIMENSIONS :	
Weight (incl. Packaging) :	26.7 kg / 58.57 lbs
Weight (excl. Packaging) :	23.1 kg / 50.83 lbs
Visible diagonal / screen size :	20 inch / 50.8 cm

Specifications and information are subject to change without notice.

MAGNAVOX LIMITED WARRANTY

Ninety (90) Days Labor & One (1) Year Parts & One (1) Year Display

MAGNAVOX warrants this product against defect in material or workmanship, subject to any conditions set forth as follows:

PROOF OF PURCHASE:

You must have proof of the date of purchase to receive warranted repair on the product. A sales receipt or other document showing the product and the date that you purchased the product as well as the authorized retailer included, is considered such proof.

COVERAGE:

(If this product is determined to be defective)

LABOR: For a period of ninety (90) days from the date of purchase, Magnavox will repair or replace the product, at its option, at no charge, or pay the labor charges to any Magnavox authorized service center. After the period of ninety (90) days, Magnavox will no longer be responsible for charges incurred.

PARTS: For a period of one (1) year, Magnavox will supply, at no charge, new or rebuilt replacement parts in exchange for defective parts. Magnavox authorized service centers will provide removal and installation of the parts under the specified labor warranty.

DISPLAY: For a period of one (1) year from the date of purchase, Magnavox will supply, at no charge, a new or rebuilt active display device in exchange for the defective display. Magnavox authorized service centers will provide removal and installation of the parts under the specified labor warranty. (PTV screens carry a thirty (30) day replacement warranty.)

EXCLUDED FROM WARRANTY COVERAGE

Your warranty does not cover:

- Labor charges for installation or setup of the product, adjustment of customer controls on the product, and installation or repair of antenna systems outside of the product.
- Product repair and/or part replacement because of improper installation, connections to improper voltage supply, abuse, neglect, misuse, accident, unauthorized repair or other cause not within the control of Magnavox.
- A product that requires modification or adaptation to enable it to operate in any country other than the country for which it was designed, manufactured, approved and/or authorized, or repair of products damaged by these modifications.
- Damage occurring to product during shipping when improperly packaged or cost of associated packaging.
- Product lost in shipment and no signature verification of receipt can be provided.
- A product used for commercial or institutional purposes (including but not limited to rental purposes).
- Products sold AS IS or RENEWED.

TO OBTAIN WARRANTY SERVICE IN THE U.S.A., PUERTO RICO, OR U.S. VIRGIN ISLANDS...

Contact Magnavox Customer Care Center at:
1-800-705-2000

TO OBTAIN WARRANTY SERVICE IN CANADA...

1-800-661-6162 (French Speaking)
1-800-705-2000 (English or Spanish Speaking)

REPAIR OR REPLACEMENT AS PROVIDED UNDER THIS WARRANTY IS THE EXCLUSIVE REMEDY FOR THE CONSUMER. MAGNAVOX SHALL NOT BE LIABLE FOR ANY INCIDENTAL OR CONSEQUENTIAL DAMAGES FOR BREACH OF ANY EXPRESS OR IMPLIED WARRANTY ON THIS PRODUCT. EXCEPT TO THE EXTENT PROHIBITED BY APPLICABLE LAW, ANY IMPLIED WARRANTY OF MERCHANTABILITY OR FITNESS FOR A PARTICULAR PURPOSE ON THIS PRODUCT IS LIMITED IN DURATION TO THE DURATION OF THIS WARRANTY.

Some states do not allow the exclusions or limitation of incidental or consequential damages, or allow limitations on how long an implied warranty lasts, so the above limitations or exclusions may not apply to you. In addition, if you enter into a service contract agreement with the MAGNAVOX partnership within ninety (90) days of the date of sale, the limitation on how long an implied warranty lasts does not apply.

This warranty gives you specific legal rights. You may have other rights which vary from state/province to state/province.

Magnavox, P.O. Box 671539, Marietta, GA. 30006-0026

(Warranty: 4835 710 28125)

INDEX

Alternating Channels	29	Safety / Precautions	4
Auto Program	16	S-Video (S-VHS) Input Connections	10
AV (Audio/Video) Input Connection	8	Side AV Connections	9
AV (Audio/Video) Output Connection	12	SleepTimer	28
Basic TV and Remote Control Operation	6	SmartLock Controls	
Cable Box Connections	7	Access Code	22
Channel Edit (Add or Skip Channels)	17	Block Channels	23
Cleaning and Care	31	Block/Clear All Channels	24
Close Captioning	28	Movie Ratings	25
Contents	2	TV Ratings	26
Component Video (CVI) Input Connections	11	Blocking Options.	27
Feature	2	Smart Picture	18
Format Control	20	Smart Sound	19
Glossary	29	Specifications.	32
Index	34	Sound Menu Control	19
Language Control	14	AVL (Automatic Volume Leveler)	19
Picture Menu Control	18	Balance	19
Brightness	18	Bass	19
Color	18	Incr. Surround.	19
Color Temperature (Color Temp)	18	Sound.	19
Constrast.	18	Ultra Bass	19
Color Temperature (Color Temp) Control	18	Troubleshooting Tips	30
Picture	18	Tuner Mode Control	15
Sharpness.	18	Understanding SmartLock Controls	21
Registration of TV Information	3	Warranty (Limited).	33
Remote Control button descriptions	13		

Free Manuals Download Website

<http://myh66.com>

<http://usermanuals.us>

<http://www.somanuals.com>

<http://www.4manuals.cc>

<http://www.manual-lib.com>

<http://www.404manual.com>

<http://www.luxmanual.com>

<http://aubethermostatmanual.com>

Golf course search by state

<http://golfingnear.com>

Email search by domain

<http://emailbydomain.com>

Auto manuals search

<http://auto.somanuals.com>

TV manuals search

<http://tv.somanuals.com>