

OWNER'S MANUAL

Color Television
20MS334R

MAGNAVOX
Smart. Very smart.®



NEED HELP? CALL US!

MAGNAVOX REPRESENTATIVES ARE READY TO HELP YOU WITH ANY QUESTIONS ABOUT YOUR NEW PRODUCT. WE CAN GUIDE YOU THROUGH CONNECTIONS, FIRST-TIME SETUP, AND ANY OF THE FEATURES. WE WANT YOU TO START ENJOYING YOUR NEW PRODUCT RIGHT AWAY.

**CALL US BEFORE YOU CONSIDER RETURNING THE PRODUCT.
1-800-705-2000**

OR VISIT US ON THE WEB AT WWW.MAGNAVOX.COM

IMPORTANT!
RETURN YOUR WARRANTY REGISTRATION CARD WITHIN 10 DAYS.
SEE WHY INSIDE.

Return your Warranty Registration card today to ensure you receive all the benefits you're entitled to.

Once your MAGNAVOX purchase is registered, you're eligible to receive all the privileges of owning a MAGNAVOX product. So complete and return the Warranty Registration Card enclosed with your purchase at once. And take advantage of these important benefits.

Warranty Verification

Registering your product within 10 days confirms your right to maximum protection under the terms and conditions of your MAGNAVOX warranty.

Owner Confirmation

Your completed Warranty Registration Card serves as verification of ownership in the event of product theft or loss.

Model Registration

Returning your Warranty Registration Card right away guarantees you'll receive all the information and special offers which you qualify for as the owner of your model.

Congratulations on your purchase, and welcome to the "family!"



Dear MAGNAVOX product owner:

Thank you for your confidence in MAGNAVOX. You've selected one of the best-built, best-backed products available today. We'll do everything in our power to keep you happy with your purchase for many years to come.

As a member of the MAGNAVOX "family," you're entitled to protection by one of the most comprehensive warranties and outstanding service networks in the industry.

What's more, your purchase guarantees you'll receive all the information and special offers for which you qualify, plus easy access to accessories from our convenient home shopping network. Most importantly, you can count on our uncompromising commitment to your total satisfaction.

All of this is our way of saying welcome-and thanks for investing in a MAGNAVOX product.

P.S. Remember, to get the most from your MAGNAVOX product, you must return your Warranty Registration Card within 10 days. So please mail it to us right now!

Know these safety symbols



⚡ This "bolt of lightning" indicates uninsulated material within your unit may cause an electrical shock. For the safety of everyone in your household, please do not remove product covering.

⚠ The "exclamation point" calls attention to features for which you should read the enclosed literature closely to prevent operating and maintenance problems.

WARNING: TO PREVENT FIRE OR SHOCK HAZARD, DO NOT EXPOSE THIS EQUIPMENT TO RAIN OR MOISTURE.

CAUTION: To prevent electric shock, match wide blade of plug to wide slot, fully insert.

ATTENTION: Pour éviter les choc électriques, introduire la lame la plus large de la fiche dans la borne correspondante de la prise et pousser jusqu'au fond.

For Customer Use

Enter below the Serial No. which is located on the rear of the cabinet. Retain this information for future reference.

Model No. _____
Serial No. _____

Visit our World Wide Web Site at <http://www.magnavox.com>

IMPORTANT SAFETY INSTRUCTIONS

Read before operating equipment

1. Read these instructions.
2. Keep these instructions.
3. Heed all warnings.
4. Follow all instructions.
5. Do not use this apparatus near water.
6. Clean only with a dry cloth.
7. Do not block any of the ventilation openings. Install in accordance with the manufacturer's instructions.
8. Do not install near any heat sources such as radiators, heat registers, stoves, or other apparatus (including amplifiers) that produce heat.
9. Do not defeat the safety purpose of the polarized or grounding-type plug. A polarized plug has two blades with one wider than the other. A grounding type plug has two blades and a third grounding prong. The wide blade or third prong are provided for your safety. When the provided plug does not fit into your outlet, consult an electrician for replacement of the obsolete outlet.
10. Protect the power cord from being walked on or pinched, particularly at plugs, convenience receptacles, and the point where they exit from the apparatus.
11. Only use attachments/accessories specified by the manufacturer.
12. Use only with a cart, stand, tripod, bracket, or table specified by the manufacturer or sold with the apparatus. When a cart is used, use caution when moving the cart/apparatus combination to avoid injury from tip-over.
13. Unplug this apparatus during lightning storms or when unused for long periods of time.
14. Refer all servicing to qualified service personnel. Servicing is required when the apparatus has been damaged in any way, such as if the power-supply cord or plug is damaged, liquid has been spilled or objects have fallen into the apparatus, or if the apparatus has been exposed to rain or moisture, does not operate normally, or has been dropped.
15. This product may contain lead and mercury. Disposal of these materials may be regulated due to environmental considerations. For disposal or recycling information, please contact your local authorities or the Electronic Industries Alliance (www.eiae.org).
16. **Damage Requiring Service** - The appliance should be serviced by qualified service personnel when:
 - A. The power supply cord or the plug has been damaged;



- B. Objects have fallen or liquid has been spilled into the appliance;
 - C. The appliance has been exposed to rain;
 - D. The appliance does not appear to operate normally or exhibits a marked change in performance;
 - E. The appliance has been dropped or the enclosure damaged.
17. **Tilt/Stability** - All televisions must comply with recommended international global safety standards for tilt and stability properties of its cabinet design.
 - Do not compromise these design standards by applying excessive pull force to the front, or top, of the cabinet, which could ultimately overturn the product.
 - Also, do not endanger yourself, or children, by placing electronic equipment/toys on the top of the cabinet. Such items could unsuspectingly fall from the top of the set and cause product damage and/or personal injury.
 18. **Wall or Ceiling Mounting** - The appliance should be mounted to a wall or ceiling only as recommended by the manufacturer.
 19. **Power Lines** - An outdoor antenna should be located away from power lines.
 20. **Outdoor Antenna Grounding** - If an outside antenna is connected to the receiver, be sure the antenna system is grounded so as to provide some protection against voltage surges and built up static charges. Section 810 of the National Electrical Code, ANSI/NFPA No. 70-1984, provides information with respect to proper grounding of the mast and supporting structure, grounding of the lead-in wire to an antenna discharge unit, size of grounding connectors, location of antenna-discharge unit, connection to grounding electrodes, and requirements for the grounding electrode. See Figure below.
 21. **Object and Liquid Entry** - Care should be taken so that objects do not fall and liquids are not spilled into the enclosure through openings.
 22. **Battery usage CAUTION** - To prevent battery leakage that may result in bodily injury, property damage, or damage to the unit:
 - Install all batteries correctly, with + and - aligned as marked on the unit.
 - Do not mix batteries (old and new or carbon and alkaline, etc.).
 - Remove batteries when the unit is not used for a long time.

Note to the Cable TV system installer: This reminder is provided to call the Cable TV system installer's attention to Article 820-40 of the NEC that provides guidelines for proper grounding and, in particular, specifies that the cable ground shall be connected to the grounding system of the building, as close to the point of cable entry as practical.

Example of Antenna Grounding as per NEC - National Electrical Code

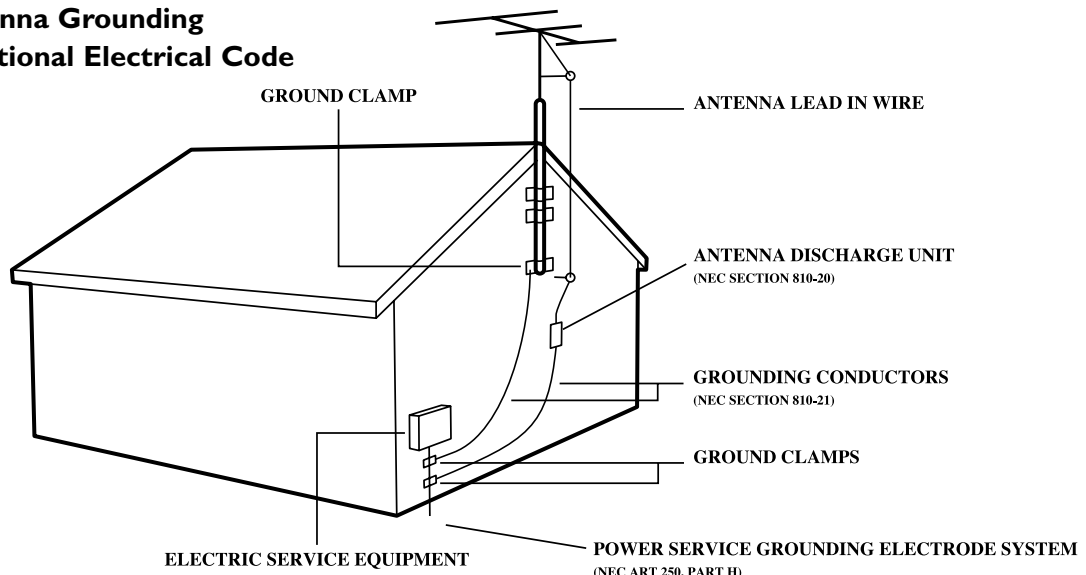

CONTENTS

Introduction

Welcome/TV Registration	2
Safety/Precautions	3
Table of Contents	4
Features	4



Getting Started

Basic TV and Remote Control Operations	5
Remote Control	6
Basic Antenna Connection	7
Basic Cable TV Connection	7
Cable Box Connections	8
Audio/Video In Jacks	9



Installation

Menu Language	10
Tuner Mode	11
Auto Program (Setting Up Channels)	12
Channel Edit	13



Picture

Picture Adjustments	14
---------------------	----



Sound

Sound Adjustments	15
-------------------	----



Features

SmartLock	16
SmartLock - Access Code	17
SmartLock - Block Channels	18
SmartLock - Clear All	19
SmartLock - Block All	20
SmartLock - Movie Ratings	21
SmartLock - TV Ratings	22
SmartLock - Blocking Options	23
Timer (Clock)	24



Remote Control Operations

Sleep Timer	25
Closed Captions	26
SmartPicture	27
SmartSound	28
SmartSurf	29



General Information

Troubleshooting	30
Care and Cleaning	30
Glossary	31
Factory Service Locations	32-33
Index	34
Limited Warranty	36

SmartPicture™, SmartSound™, and SmartLock™ are registered trademarks of Philips Consumer Electronics North America.
Copyright © 2003 Magnavox. All rights reserved.

Here are a few of the special features of your new Color Television.

Audio/Video In Jacks: Use to quickly connect other equipment to the front of your TV.

Automatic Channel Programming (Auto Program): Quick and easy setup of available channels.

Closed Captioning: Allows the viewer to read TV program dialog or voice conversations as on-screen text.

On-screen Menus: Helpful messages (in English or Spanish) for setting TV controls.

Remote Control: Works your TV features.

Sleep Timer: Turns off the TV within an amount of time you specify (10-240 minutes from the current time).

SmartLock™: Lets you block viewing of certain TV channels if you do not want your children viewing inappropriate material. This is referred to as AutoLock on some models.

SmartPicture™: Lets you set the picture's color, tint, contrast, etc., for various types of programming. Settings include Sports, Movies, Weak Signal, Multi Media, and Personal.

SmartSound™: Lets you set the TV's sound settings for the current programming. Choices include Personal, Theatre, Music, or Voice.

Standard broadcast (VHF/UHF) or Cable TV channel capability

Stereo capability: Includes a built-in amplifier and twin-speaker system, allowing reception of TV programs broadcast in stereo.

Treble Boost, Bass Boost, and Balance: Enhance the TV's sound.

NOTE: This manual covers different versions and models. Not all features described in this manual will match those of your TV. This is normal and does not require you contacting your dealer or requesting service.

END-OF-LIFE DISPOSAL

Your new television and its packaging contain materials that can be recycled and reused. Specialized companies can recycle your product to increase the amount of reusable materials and minimize the amounts that need to be properly disposed.

Your product also uses batteries that should not be thrown away when depleted, but should be handed in and disposed of as small chemical waste.

When you replace your existing equipment, please find out about the local regulations regarding disposal of your old television, batteries, and packing materials.



TELEVISION

- 1** Press **POWER**  to turn on the TV. Or, you can press any button on the front of the TV to turn on the TV.
- 2** Press **VOLUME +** to increase the sound level. Or, press **VOLUME -** to lower the sound level.
- 3** Press **CHANNEL ▲** or **▼** to select TV channels.

HEADPHONES

- 4** You can **connect headphones (not supplied)** to the  jack on the front of the TV for personal listening.

REMOTE CONTROL

- 5** **Point the remote** control toward the remote sensor on the front of the TV when operating the TV with the remote.

BATTERY INSTALLATION

- 6** **Remove the battery compartment lid** on the back of the remote.
- 7** **Place two AA batteries in the remote.** Be sure the (+) and (-) ends of the batteries line up as marked inside the battery compartment.
- 8** **Reattach the battery compartment lid.**

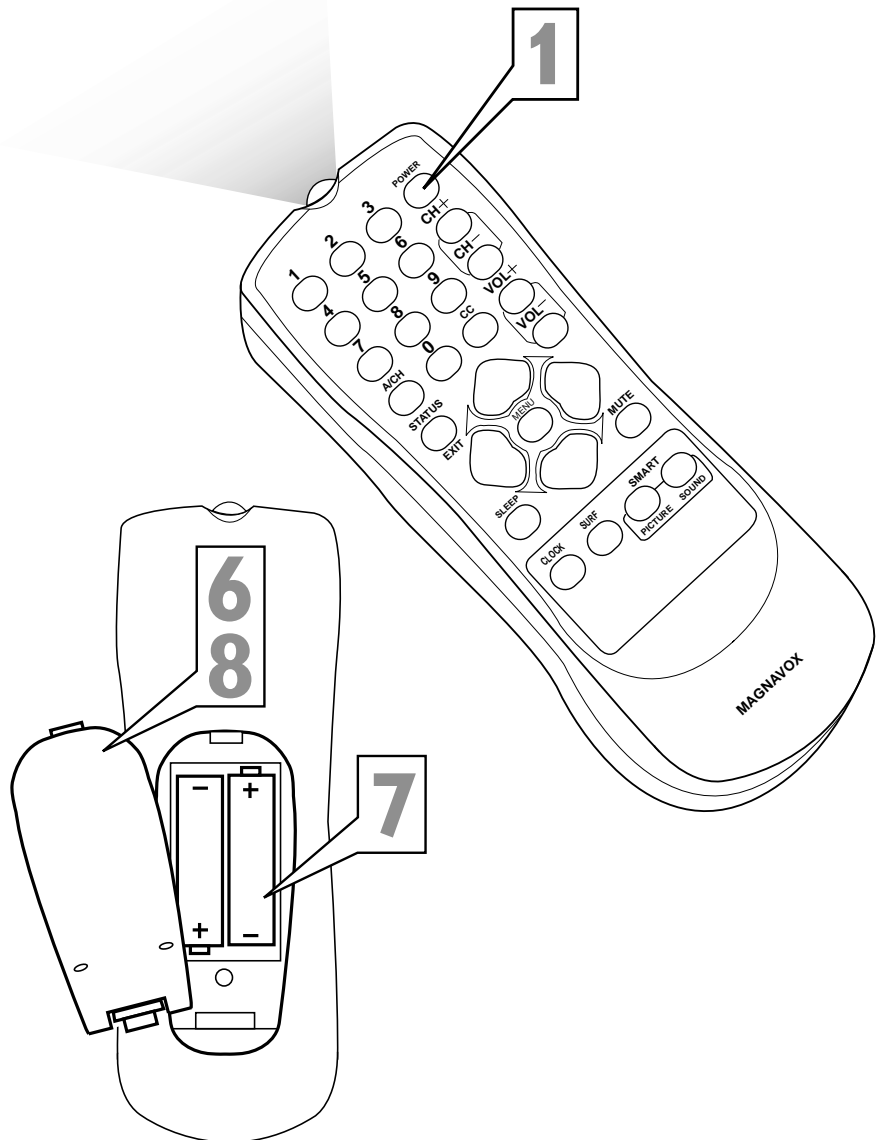
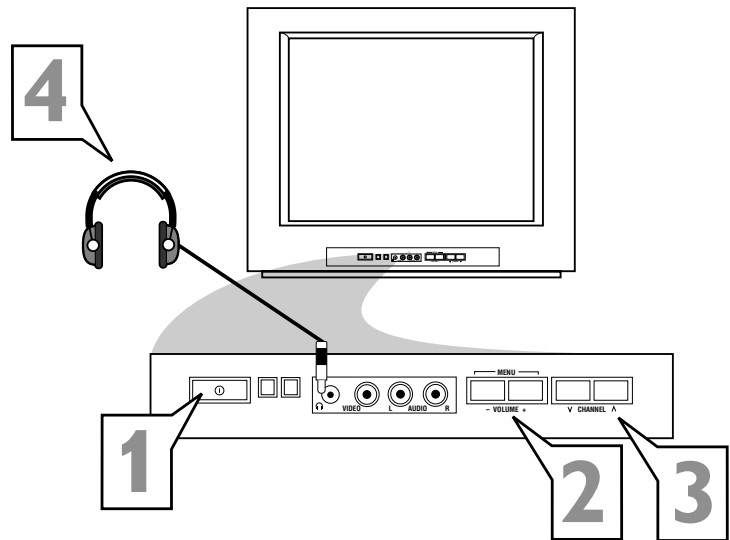

HELPFUL HINTS

The current channel number will appear briefly when you turn on the TV and when you change channels.

Press STATUS/EXIT on the remote to see the current TV channel number.



REMOTE CONTROL

NUMBER Buttons

Press the Number buttons to select TV channels or to enter values in the menu. For single-digit channels, press the Number button for the channel you want. The TV will pause briefly before going to the chosen channel.

A/CH Button (Alternate Channel)

Press to switch between the last channel and the present channel. Details are on page 29.

STATUS/EXIT Button

Press to see the current channel number. Press to remove a menu.

CC Button

Press to activate Closed Captioning. Details are on page 26.

SLEEP Button

Press to set the TV to turn itself off within a certain time. Details are on page 25.

CLOCK Button

Press for quick access to the Time menu. Details are on page 24.

SURF Button

If your TV model has SmartSurf, press this button to move through the channels you have set. Details are on page 29.

This feature is not available on all models. The button will have no use if SmartSurf is not included on your model.

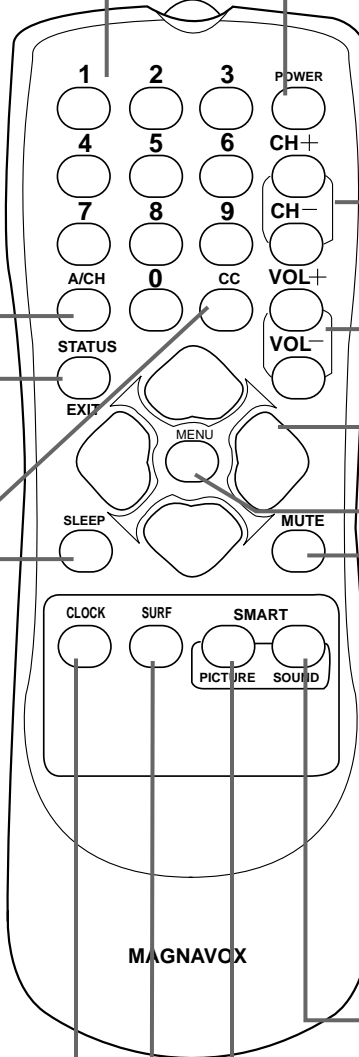

POWER button

Press to turn the TV on or off.

CH(annel) +/- Buttons

Press to scan memorized channels.

VOL(ume) +/- Buttons

Press to increase or decrease the sound.

Arrow ◀ ▶ ▲ ▼ Buttons

Press to select or adjust items in the menu.

MENU Button

Press to see the menu. Press repeatedly to return to previous menus or remove the menus.

MUTE Button

Press to eliminate or restore the TV sound. MUTE will appear on the TV when the sound is muted.

SMART SOUND Button

Press to choose a sound setting. Details are on page 28.

SMART PICTURE Button

Press to choose a picture setting. Details are on page 27.

BASIC ANTENNA CONNECTION



A combination antenna receives normal broadcast channels (VHF 2–13 and UHF 14–69). Your connection is easy because there is only one 75Ω (ohm) antenna jack on the back of your TV, and that's where the antenna goes.

- 1** If your antenna has a round cable (75 ohm) on the end, then you're ready to connect it to the TV. If your antenna has flat, twin-lead wire (300 ohm), you first need to attach the antenna wires to the screws on a 300- to 75-ohm adapter.
- 2** Connect the antenna (or adapter) to the 75Ω (ohm) jack on the back of the TV. If the end of the antenna wire is threaded, screw it down finger tight.

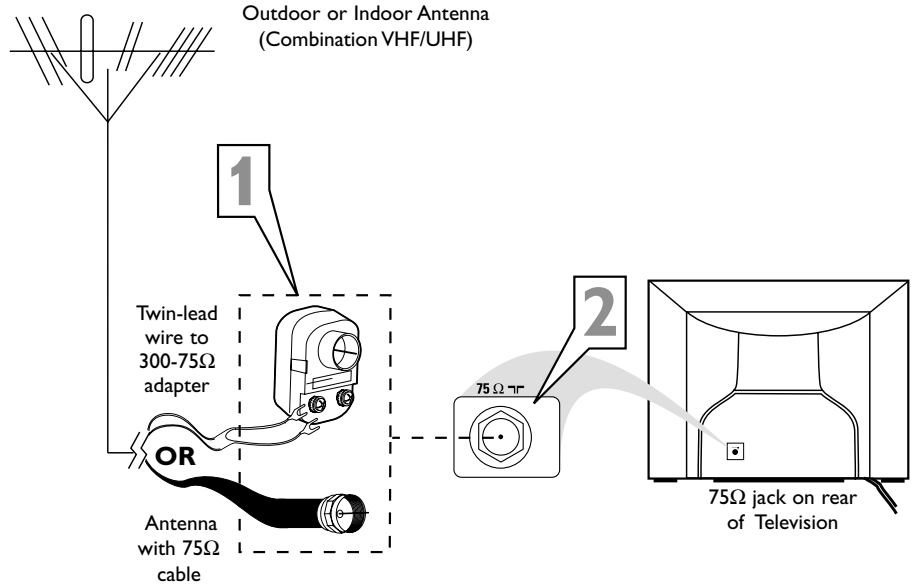

BASIC CABLE TV CONNECTION



Your Cable TV signal into your home may be a single, 75Ω (ohm) cable. If so, this connection is very simple. Follow the step below to connect your Cable TV signal to your new television.

- 1** Connect the Cable TV signal to the 75Ω jack on the TV. Screw it down finger tight.

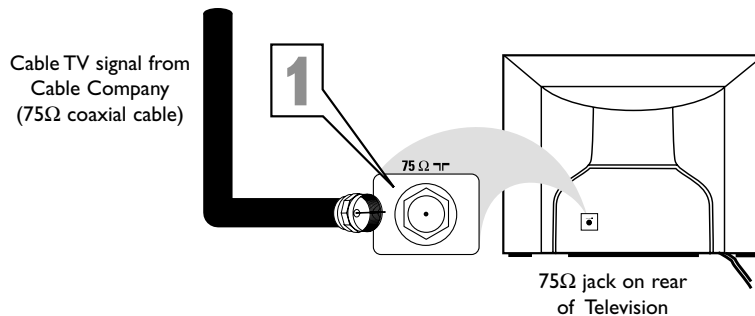

HELPFUL HINT

Use Auto Program as described on page 12 to set up channels that are available in your area. Use the CH +/- buttons to scan available channels.



CABLE BOX CONNECTIONS

If you have a Cable Box, follow either set of these steps to complete your connections.

Cable Box with RF In/Out Jacks

This connection will not supply Stereo sound to the TV. The sound from the Cable Box will be monaural (single-channel, not left and right).

- 1** Connect the Cable TV signal to the **IN** jack (or RF IN or CABLE IN) on the Cable Box.
- 2** Connect an RF coaxial cable (not supplied) to the **OUT** jack (or TO TV or RF OUT) of the Cable Box.
- 3** Connect the other end of the coaxial cable to the TV's 75Ω jack. Screw it down finger tight.
- 4** Set the **Channel 3/4** (or Output channel) switch of the Cable Box to **3** or **4**. Set the **TV** to the same channel. When watching TV programming, change channels at the Cable Box, not the TV.

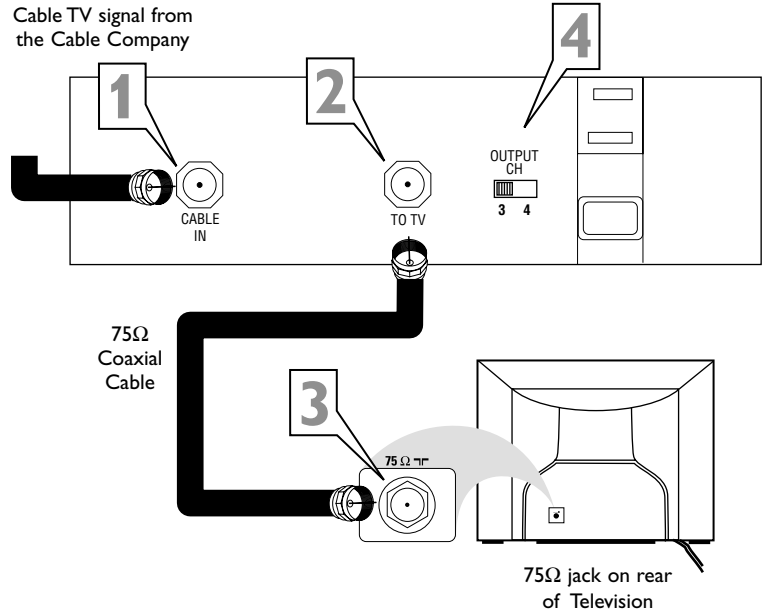

Cable Box with Audio/Video Out Jacks

This connection will supply Stereo sound to the TV.

- 1** Connect the Cable TV signal to the **IN** jack (or RF IN or CABLE IN) on the Cable Box.
- 2** Using an RCA-type video cable, connect one end of the video cable to the **Video Out** jack of the Cable Box. Connect the other end of the cable to the **yellow VIDEO In** jack on the front of the TV. Video cables are usually marked with yellow and are available from Magnavox or electronics retailers. Video jacks on most equipment are yellow.
- 3** Using RCA-type, stereo audio cables, connect one end of the cables to the **left and right AUDIO Out** jacks of the Cable Box. Connect the other end of the cables to the **red and white AUDIO L/R (left/right) In** jacks on the front of the TV. Audio cables are usually marked with red and white and are available from Magnavox or electronics retailers. The right audio jack is red and the left audio jack is white. Match the cable colors to the jack colors.
- 4** Press the **CH +/-** buttons to set the TV to the **FRONT** channel. (Go to your lowest channel, for example channel 1, then change channels down to find FRONT.) When watching TV programming, change channels at the Cable Box, not the TV.

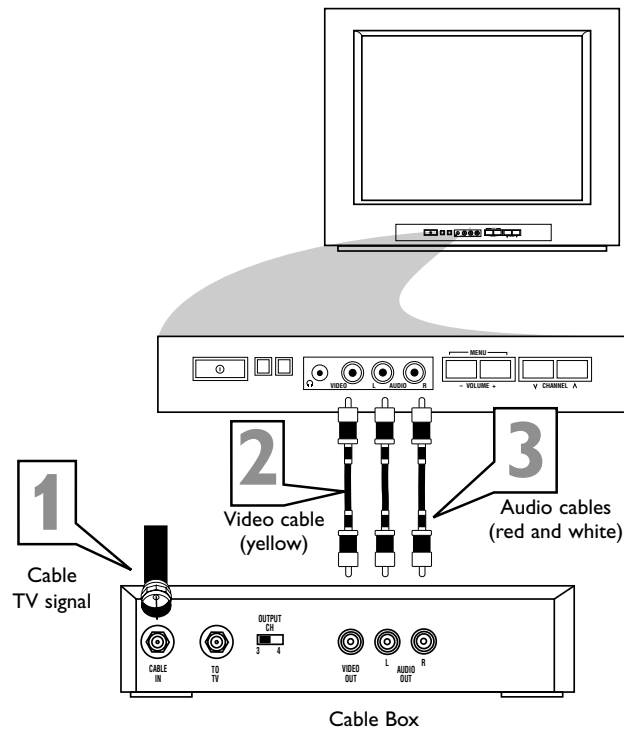



The **AUDIO** and **VIDEO** In jacks on the front of the TV enable quick connections of other equipment. Connect a VCR, DVD Player, Video Game, Camcorder, etc., to these jacks. To view the material playing on the other equipment, set the TV to its **FRONT** channel.

1 Connect an **RCA-style video cable (usually yellow)** to the **VIDEO OUT** jacks of the other equipment (DVD Player, Camcorder, etc.) and to the yellow **VIDEO In** jack on the front of the TV.

2 If the other equipment has **red and white, left and right, stereo audio out jacks**: Connect RCA-style audio cables (usually red and white) to the **AUDIO OUT** (left and right) jacks on the other equipment. Connect the other end of the cables to the red and white **AUDIO In** (L/R left/right) jacks on the front of the TV. Match the cable colors to the jack colors. The TV will receive sound from the other equipment in stereo (from the left and right sound channels).

If the other equipment has **only one AUDIO OUT (white) jack**: Connect an audio cable to the **AUDIO OUT** jack on the other equipment. Connect the other end of the cable to the white **AUDIO In** (L-left) jack on the front of the TV. The TV will receive sound from the other equipment through a single audio channel.

3 Turn on the TV and other equipment.

4 Press the **CH +/-** buttons to set the **TV to its FRONT** channel. (Go to your lowest channel, for example channel 1, then change channels down to find **FRONT**.)

5 Press **PLAY** on the other equipment to view its material on the TV.

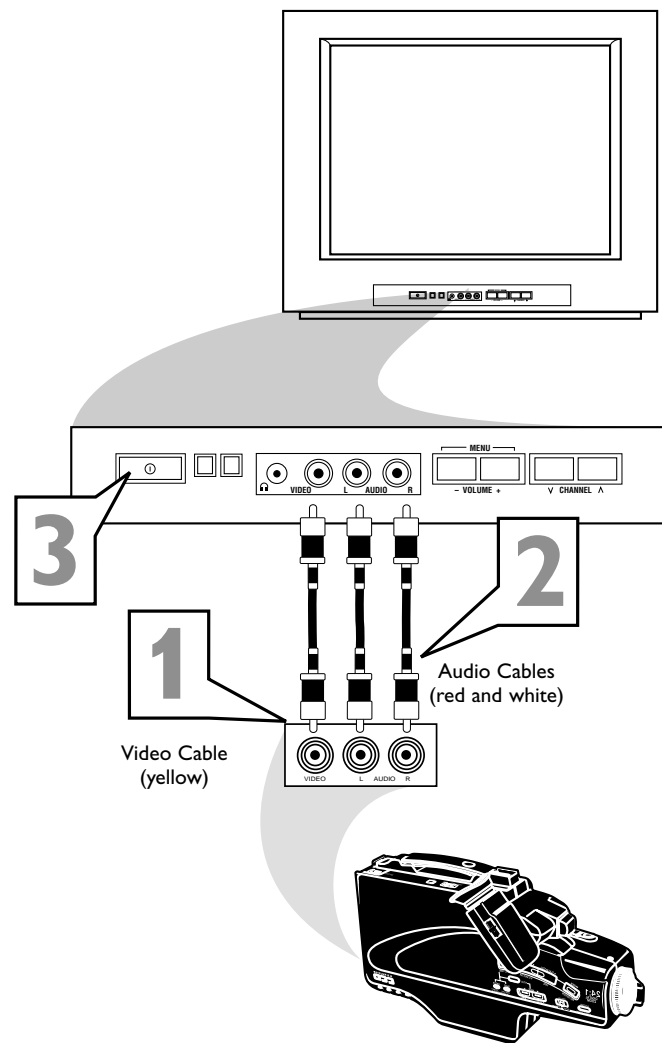

HELPFUL HINT

Audio and video cables are not supplied with the TV, but are available from Magnavox or electronics retailers.



MENU LANGUAGE

The TV menus are available in English and Spanish. To change the language, follow these steps.

- 1** Press **MENU** to see the menu.
- 2** Press **▲** or **▼** to highlight **INSTALL**.
- 3** Press **▶** to see the **INSTALL** menu.
- 4** Press **▲** or **▼** to select **LAN- GUAGE**.
- 5** Press **▶** to select **ENGLISH** or **ESPAÑOL** (Spanish).
- 6** Press **STATUS/EXIT** to remove the menu.

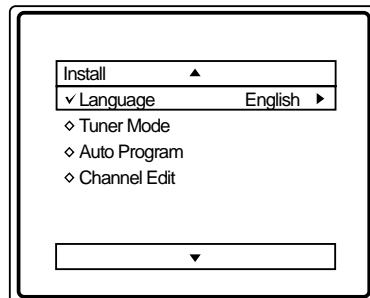
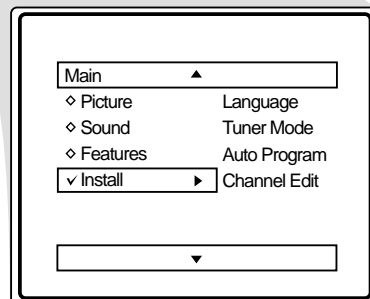
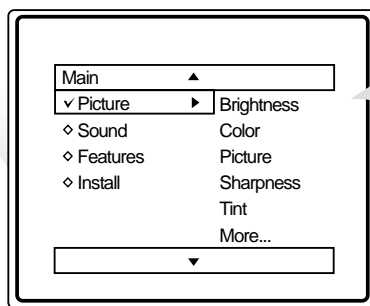

OR

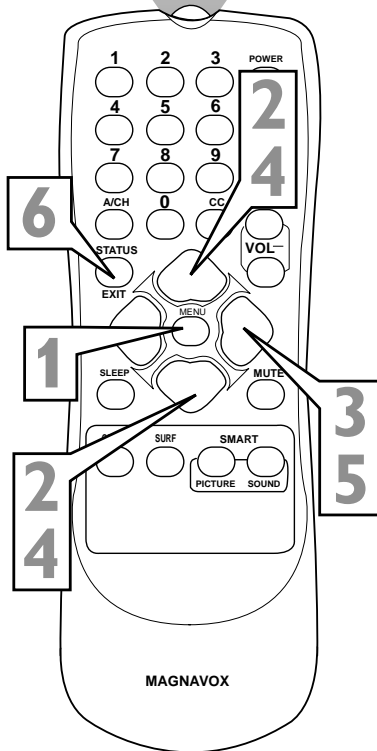
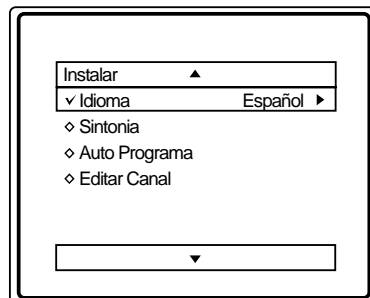

HELPFUL HINT

The Language control only makes the TV's on-screen menu appear in English or Spanish text. It does not change other on-screen text, such as Closed Captions.



Tuner Mode lets you tell the TV whether you connected a regular antenna or a Cable TV signal to it. This information is necessary when you set up channels at the TV, so set Tuner Mode correctly for your type of connection. You can set Tuner Mode to Auto if you want the TV to choose the type of signal (antenna or Cable TV) on its own.

- 1** Press **MENU** to see the menu.
- 2** Press **▲** or **▼** to highlight **INSTALL**.
- 3** Press **▶** to see the **INSTALL** menu.
- 4** Press **▲** or **▼** to select **TUNER MODE**.
- 5** Press **▶** to select **ANTENNA**, **CABLE**, or **AUTO**.
- 6** Press **STATUS/EXIT** to remove the menu.

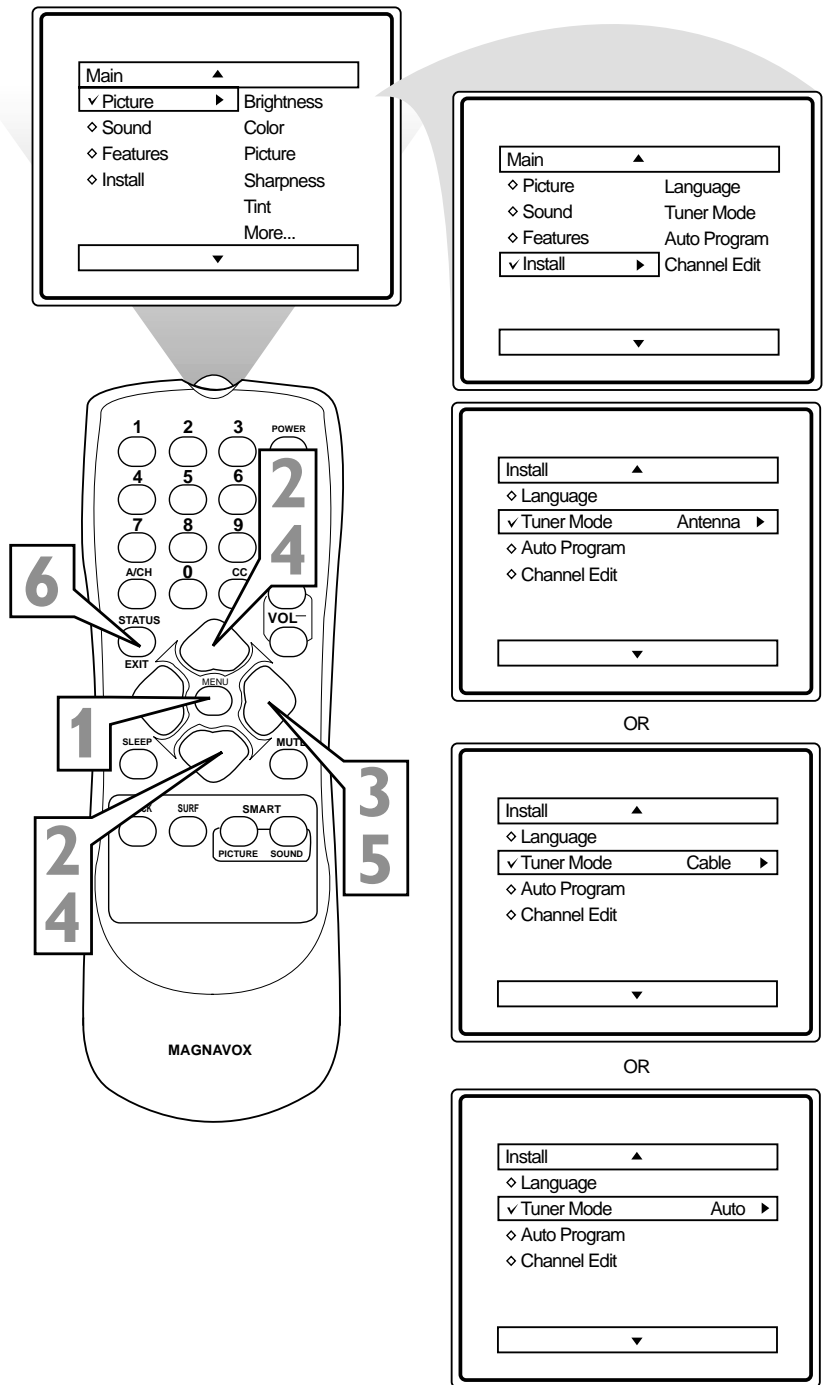

HELPFUL HINTS

- When **CABLE** is selected, channels 1-125 are possible.
- When **ANTENNA** is selected, channels 2-69 are possible.
- When **AUTO** is selected, the TV will detect whether to receive Antenna or Cable TV channels.



AUTO PROGRAM (SETTING UP CHANNELS)

Your TV can receive Antenna (local) or Cable TV channels. This makes it easy for you to scan through only available channels when you use the CH +/- buttons.

Before you start Auto Program, connect the Antenna or Cable TV signal to the TV as described on page seven. Also make sure Tuner Mode is set correctly as described on page 11.

- 1 Press **MENU** to see the menu.
- 2 Press **▲** or **▼** to select **INSTALL**.
- 3 Press **▶** to see the **INSTALL** menu.
- 4 Press **▲** or **▼** to highlight **AUTO PROGRAM**.
- 5 Press **▶** to start scanning channels. Auto Programming will store all available channels in the TV's memory, then tune to the lowest available channel when done.
- 6 Press **STATUS/EXIT** to remove the menu.

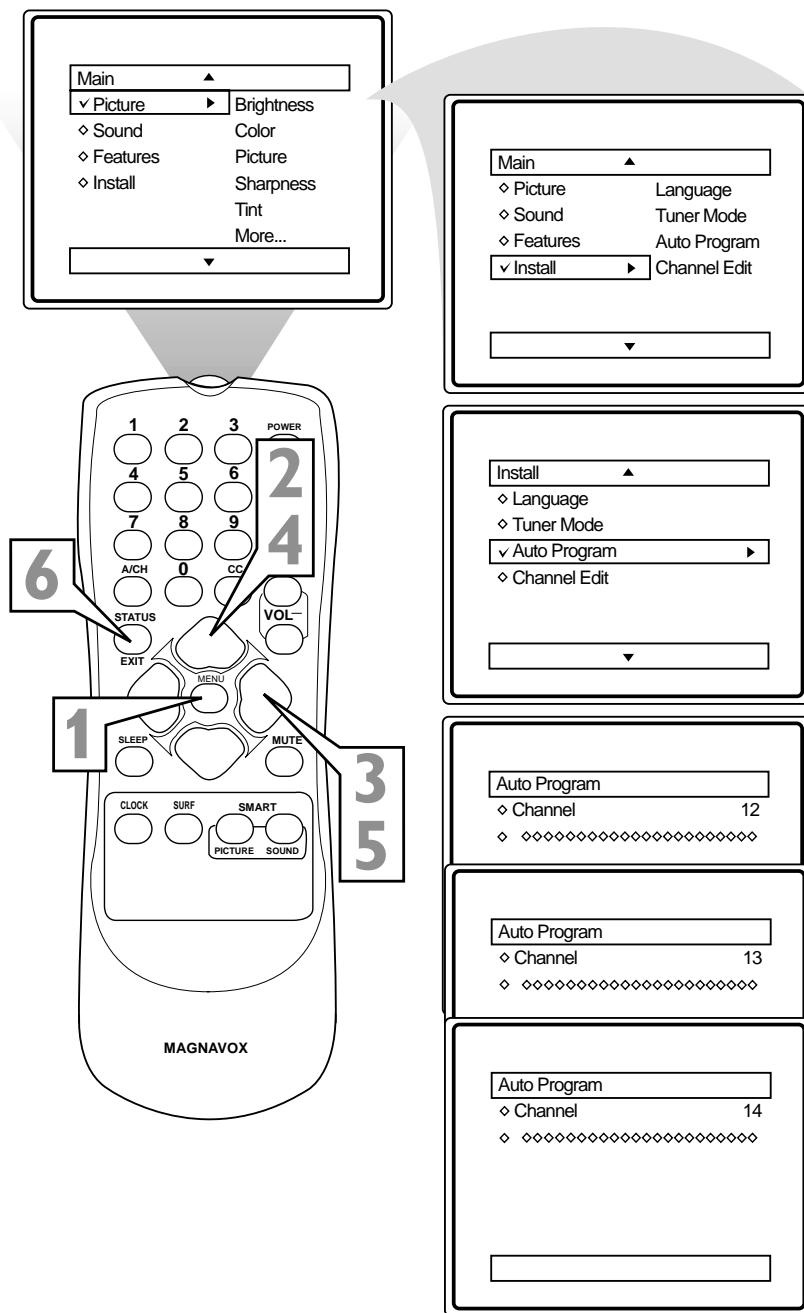

HELPFUL HINT

If you have Cable TV, channels 1-125 are possible. If you connect a regular antenna to the TV, channels 2-69 are possible.



Channel Edit makes it easy for you to add or delete channels from the TV's memory. This enables you to scan only through the channels you want when using the CH +/- buttons.

- 1** Press **MENU** to see the menu.
- 2** Press **▲** or **▼** to select **INSTALL**.
- 3** Press **▶** to see the **INSTALL** menu.
- 4** Press **▲** or **▼** to choose **CHANNEL EDIT**.
- 5** Press **▶** to see the **CHANNEL EDIT** options.
- 6** With **CHANNEL NO.** selected, press the **Number** buttons or the **CH +/-** buttons to enter the channel you want to add (Skipped OFF) or delete (Skipped ON).
- 7** Press **▼** to select **SKIPPED**.
- 8** Press **▶** to set **SKIPPED** to **ON** or **OFF**.
If **SKIPPED** is **ON**, the channel will be ignored (skipped) when you scan channels using the CH +/- buttons.
If **SKIPPED** is **OFF**, the channel will be available (not skipped) when you scan channels using the CH +/- buttons.
- 9** Press **STATUS/EXIT** to remove the menu.

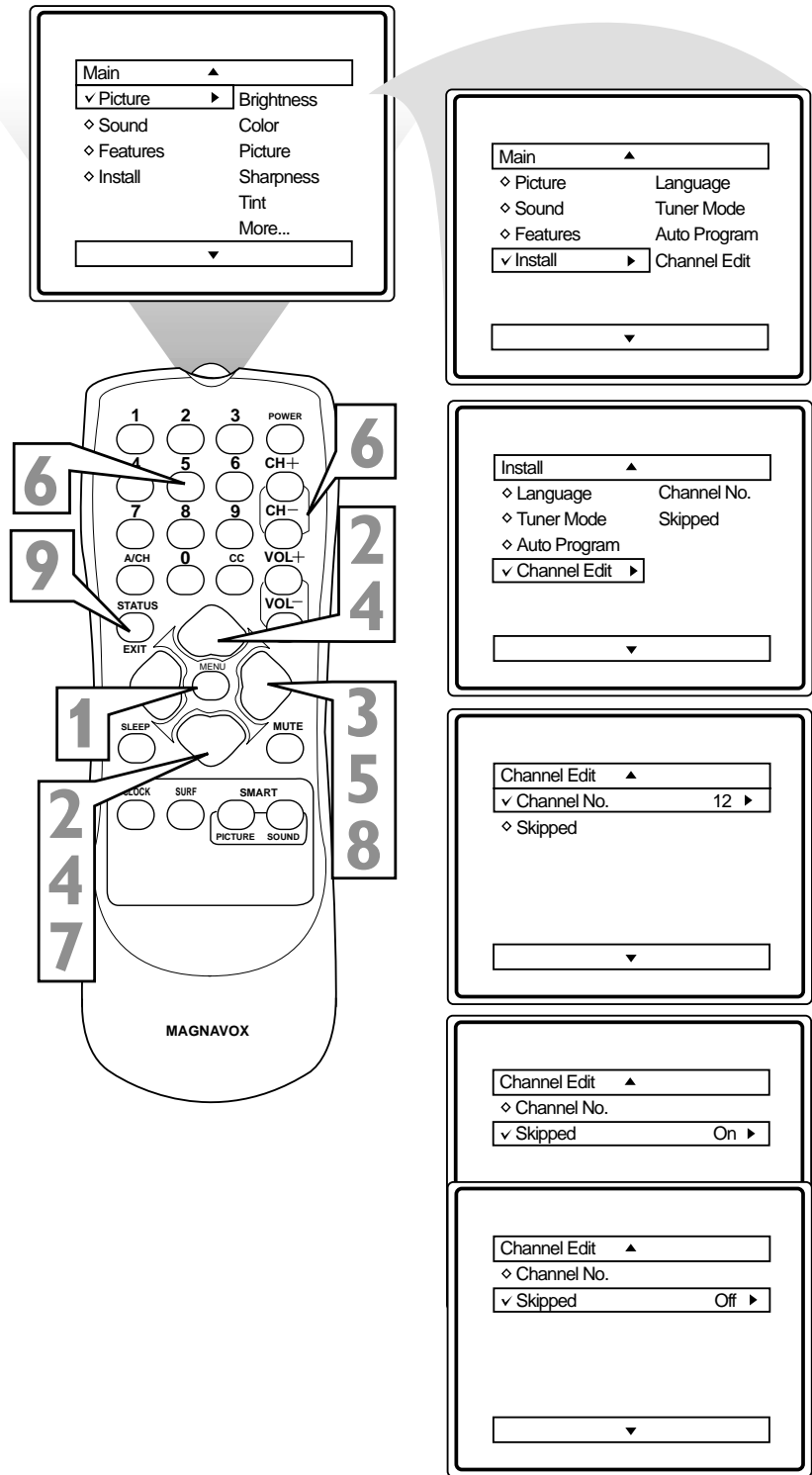

PICTURE ADJUSTMENTS

To adjust your TV picture, select a channel and follow these steps.

- 1** Press **MENU** to see the menu.
- 2** Press **▲** or **▼** to select **PICTURE**.
- 3** Press **▶** to see the **PICTURE** menu.
- 4** Press **▲** or **▼** to choose the item you want to adjust: Brightness, Color, Picture, Sharpness, Tint, Color Temp., DNR, or Contrast +.
- 5** Press **▶** or **◀** to adjust the item.
- 6** Press **▲** or **▼** to select and adjust other picture controls.
- 7** Press **STATUS/EXIT** to remove the menu.

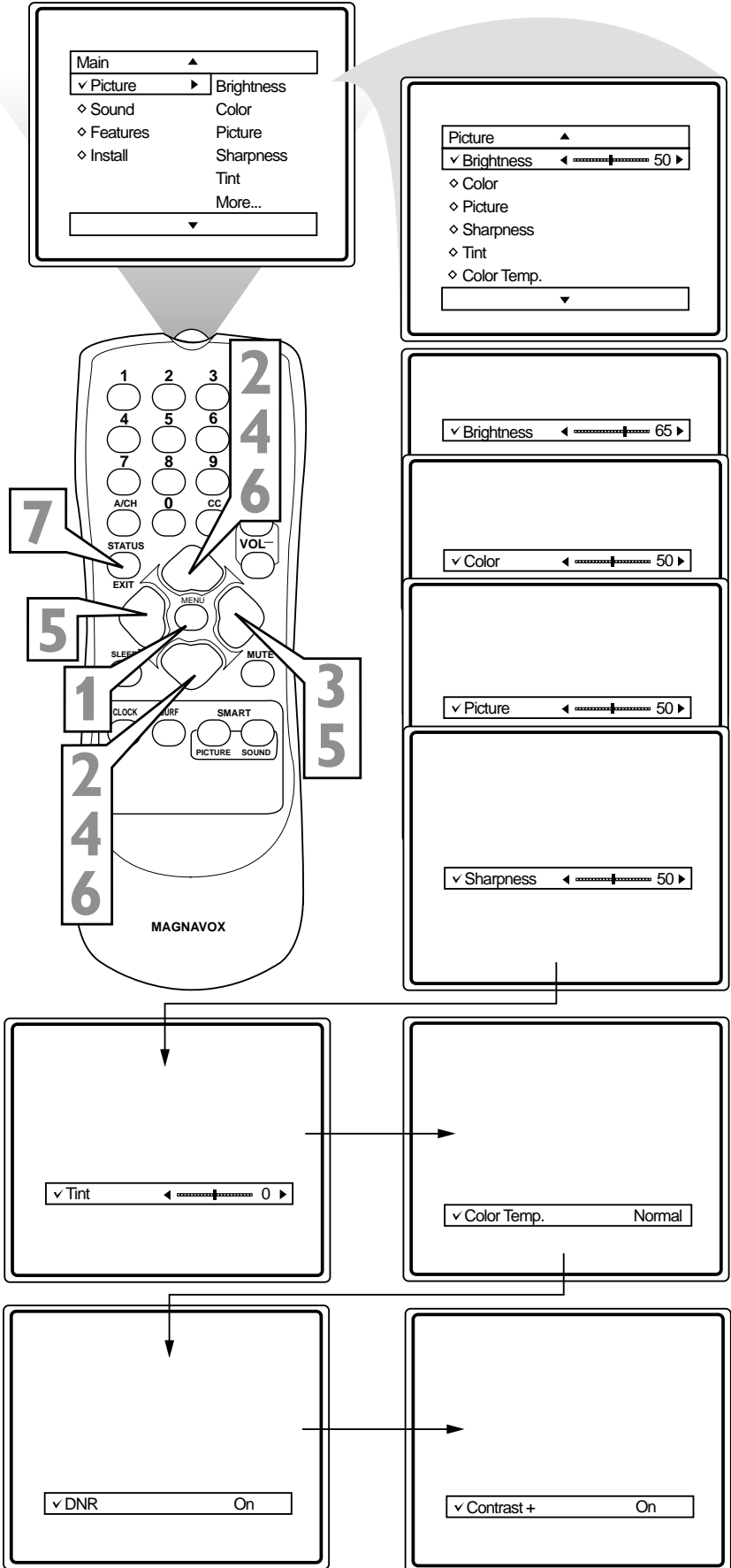

HELPFUL HINTS

Brightness: Adjust to brighten the dark parts of the picture. This appears to add white to the color.

Color: Adjust to add or reduce color.

Picture: Adjust until the lightest parts of the picture show good detail.

Sharpness: Adjust to improve detail.

Tint: Adjust to obtain natural skin tones.

Color Temp.: Select NORMAL, COOL, or WARM. NORMAL keeps white as white. COOL creates blue-whites. WARM makes red-whites.

DNR (Dynamic Noise Reduction): Set DNR to ON to eliminate "noise" from the picture.

Contrast +: Select ON to improve the picture contrast and clarity.

SOUND ADJUSTMENTS



Besides the normal volume control, your TV has Treble Boost, Bass Boost, Balance, AVL (Automatic Volume Leveler), and Sound (Stereo/Mono) controls.

- 1 Press **MENU** to see the menu.
- 2 Press **▲** or **▼** to highlight **SOUND**.
- 3 Press **▶** to see the **SOUND** menu.
- 4 Press **▲** or **▼** to choose: **Treble Boost, Bass Boost, Balance, AVL, or Sound**.
- 5 Press **▶** or **◀** to turn the item On or Off or to adjust the item.
- 6 Press **STATUS/EXIT** to remove the menu.

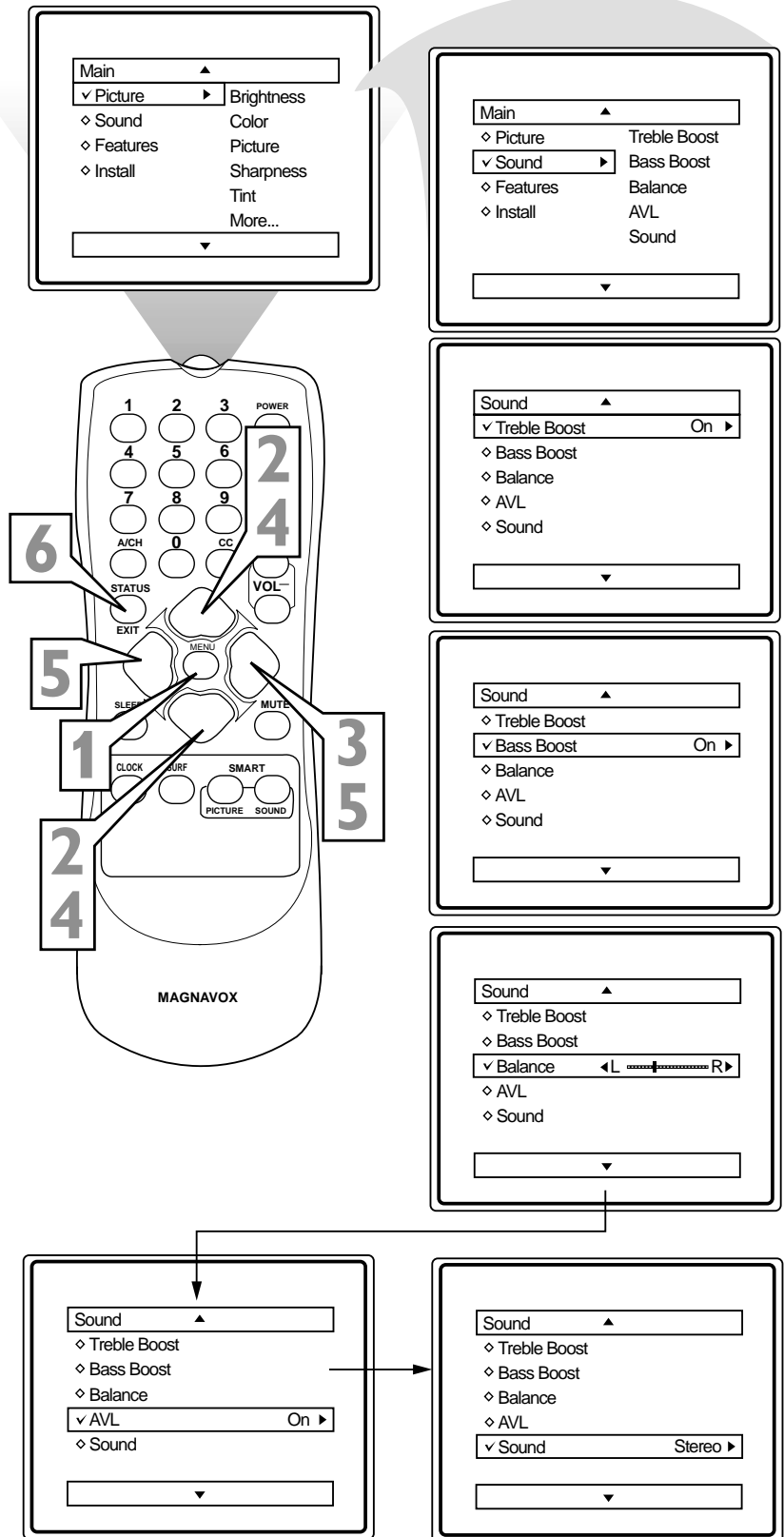

HELPFUL HINTS

Treble Boost: Choose On to enhance high frequency sounds.

Bass Boost: Choose On to enhance low frequency sounds.

Balance: Distribute the sound between the left and right speakers of the TV.

AVL (Automatic Volume Leveler): Choose On to even out the sound during sudden volume changes, for example during commercials or channel changes.

Sound: Choose Stereo or Mono. If Stereo is not present on the current program and the TV is in Stereo mode, the sound from the TV will remain monaural (single-channel sound or Mono). Stereo sound comes from two channels, the right and the left.



SMARTLOCK

SmartLock (AutoLock) processes program content advisories from broadcasters. SmartLock can respond to the content advisories and block objectionable content (offensive language, violence, sexual situations, etc.). This is a great feature to censor the type of programming children watch.

SmartLock offers various blocking options from which to choose:

Block Channel: Block individual channels, including the FRONT (Audio/Video In) channel.

Clear All: Allows you to clear and view all previously blocked channels.

Block All: Blocks all channels from viewing, including the FRONT channel.

Movie Rating: Blocks programming based on ratings of the Motion Pictures Association of America.

TV Rating: Blocks programming based on TV broadcast ratings.

Press STATUS/EXIT twice to see the SmartLock review screen, which shows the current SmartLock settings.

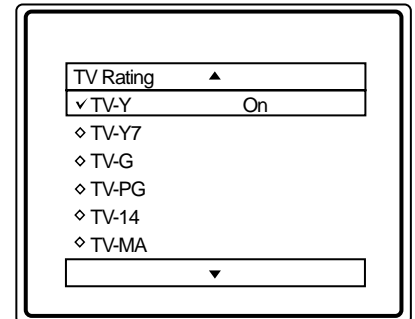
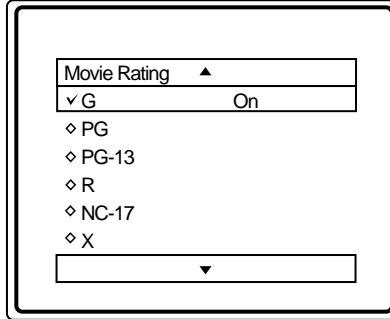

MOVIE RATINGS

G: General Audience - All ages admitted. Most parents would find this program suitable for all ages. This type of programming contains little or no violence, no strong language, and little or no sexual dialog or situations.

PG: Parental Guidance Suggested - This programming contains material that parents may find unsuitable for younger children. It may contain one or more of the following: moderate violence, some sexual situations, infrequent coarse language, or some suggestive dialog.

PG-13: Parents Strongly Cautioned - This programming contains material that parents may find unsuitable for children under the age of 13. It contains one or more of the following: violence, sexual situations, coarse language, or suggestive dialog.

R: Restricted - This programming is specifically designed for adults. Anyone under the age of 17 should only view this programming with an accompanying parent or adult guardian. It contains one or more of the following: intense violence, intense sexual situations, strong coarse language, or intensely suggestive dialog.

NC-17: No children under the age of 17 will be admitted. - This type of programming should be viewed by adults only. It contains graphic violence, explicit sex, or crude, indecent language.

X: Adults Only - This type of programming contains one or more of the following: very graphic violence, very graphic and explicit or indecent sexual acts, and very coarse and intensely suggestive language.

TV RATINGS

TV Y **TV-Y All children** - Appropriate for all children. Designed for a very young audience, including children ages 2-6. This type of programming is not expected to frighten younger children.

TV Y7 **TV-Y7 Directed to Older Children** - Designed for children age 7 and above. It may be more appropriate for children who can distinguish between make-believe and reality. This programming may include mild fantasy and comic violence (FV or fantasy violence).

TV G **TV-G General Audience** - Most parents would find this programming suitable for all ages. This type of programming contains little or no violence, no strong language, and little or no sexual dialog or situations.

TV PG **TV-PG Parental Guidance Suggested** - Contains material that parents may find unsuitable for younger children. This type of programming contains one or more of the following: Moderate violence (V), some sexual situations (S), infrequent coarse language (L), or some suggestive dialog (D).

TV 14 **TV-14 Parents Strongly Cautioned** - Contains some material that many parents would find unsuitable for children under age 14. This type of programming contains one or more of the following: intense violence (V), intense sexual situations (S), strong coarse language (L), or intensely suggestive dialog (D).

TV MA **TV-MA Mature Audience Only** - Specifically designed to be viewed by adults and may be unsuitable for children under 17. This type of programming contains one or more of the following: graphic violence (V), explicit sexual situations (S), or crude, indecent language (L).

Some models refer to SmartLock as AutoLock. These features are the same.



Over the next few pages you'll learn how to block programs and understand the rating terms for certain broadcasts. First, set an access code.

- 1** Press **MENU** to see the menu.
- 2** Press **▲** or **▼** to select **FEATURES**.
- 3** Press **▶** to see the FEATURES menu.
- 4** Press **▲** or **▼** to select SmartLock (AutoLock).
- 5** Press **▶**. ACCESS CODE - - - - will appear on the screen.
- 6** Use the Number buttons to enter **0, 7, 1, 1**. This is the TV's default code. "XXXX" will appear on the screen as you enter the code. This protects its identity. If INCORRECT appears, enter 0711 again.
- 7** The screen will prompt you to enter a new code. Enter a new four-digit code using the Number buttons. The screen will prompt you to confirm the code you just entered. Enter your same new code again. "XXXX" will appear when you enter your new code, then the SmartLock (AutoLock) menu will appear.

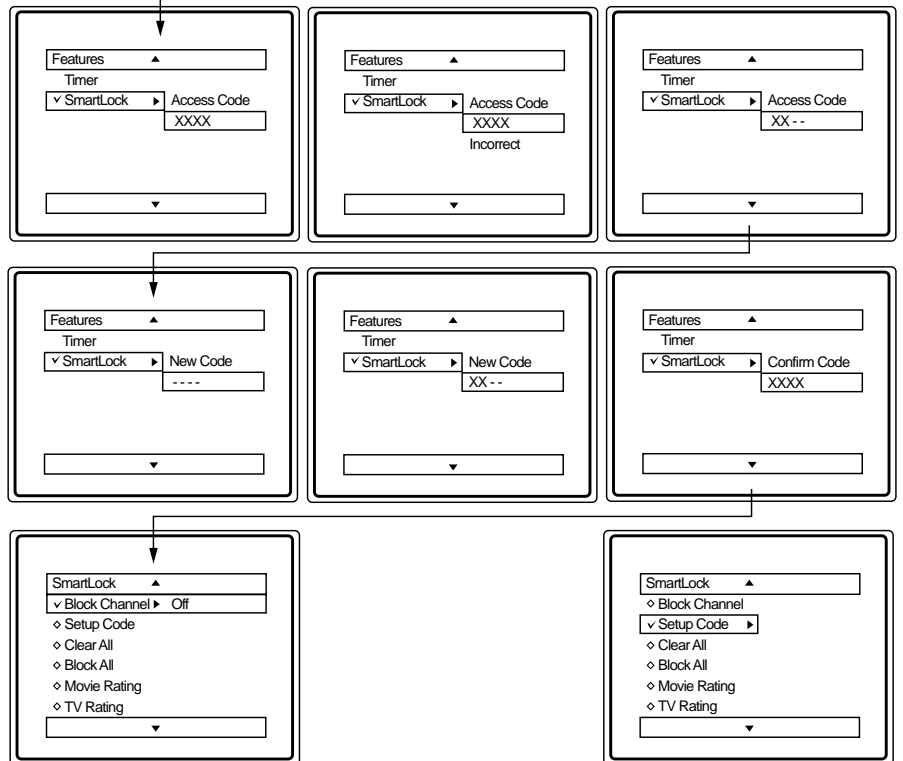
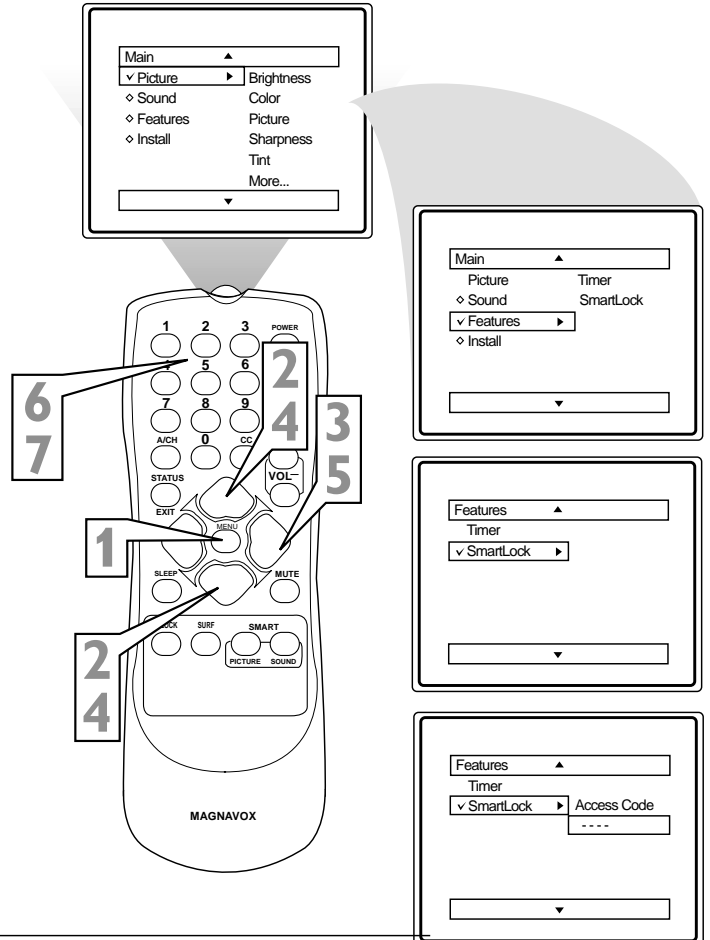

To change the Access Code later, follow steps 1-6 so the SmartLock menu appears. Press **▲** or **▼** to select Setup Code, then press **▶**. Use the Number buttons to enter a new code and confirm it. CONFIRMED appears when the new code is set.

Some models refer to SmartLock as AutoLock. These features are the same.

HELPFUL HINTS

You cannot unblock a channel without knowing your code or changing it. If your code changes, someone has altered it and possibly viewed blocked channels.

You can use 0711 if you do not know your personal access code.



SMARTLOCK - BLOCK CHANNELS

After setting your personal access code, you are ready to select channels you want to block or censor.

- 1** Press the **Number** buttons or the **CH +/-** buttons to select the channel you want to block.
- 2** Press **MENU** to see the menu.
- 3** Press **▲** or **▼** to select **FEATURES**.
- 4** Press **▶** to see the **FEATURES** menu.
- 5** Press **▲** or **▼** to choose **SmartLock (AutoLock)**.
- 6** Press **▶**.
- 7** Press the **Number** buttons to enter your **four-digit access code**. The **SmartLock** menu will appear.
- 8** Press **▲** or **▼** to choose **BLOCK CHANNEL**.
- 9** Press **▶** to turn blocking **ON** or **OFF** for the current channel.
- 10** Press **CH +/-** to select other channels. Repeat step 9 to turn blocking **ON** or **OFF** for the new channel.

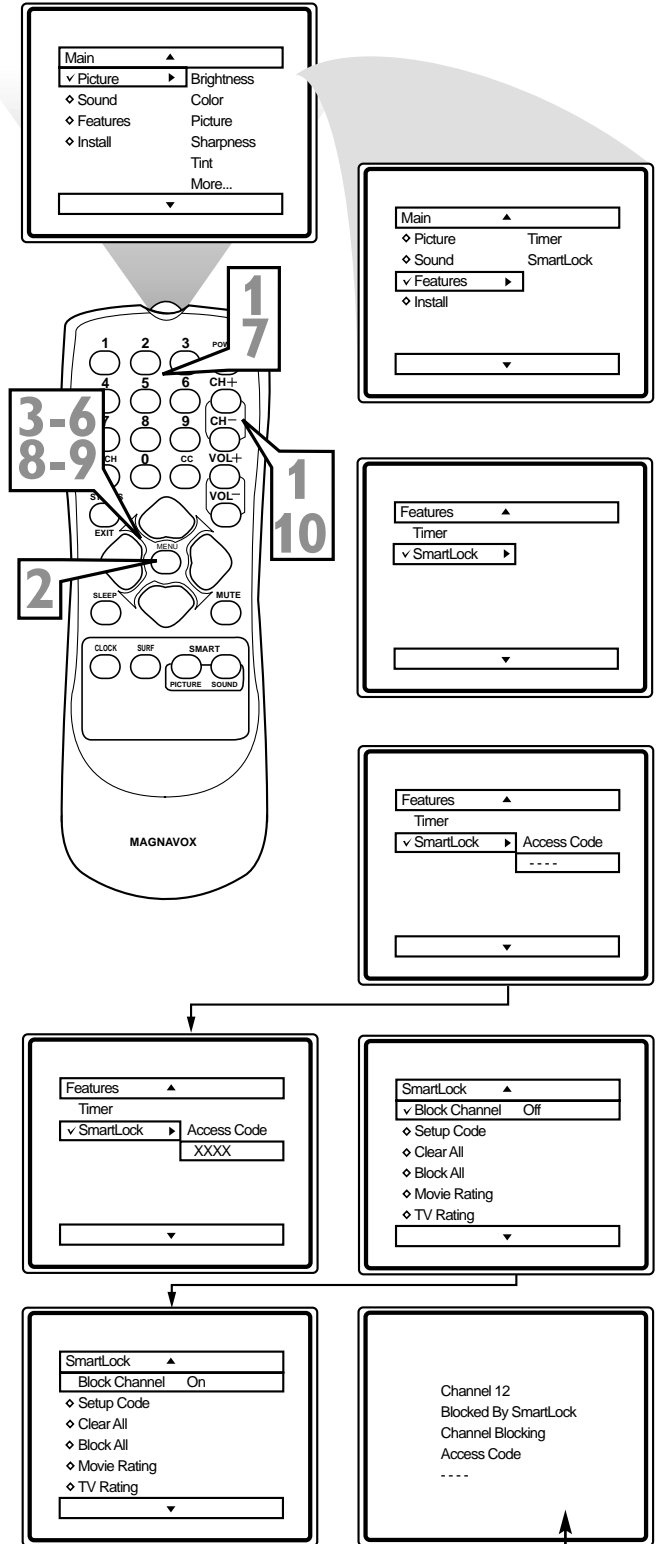

Some models refer to SmartLock as AutoLock. These features are the same.

HELPFUL HINT
If you enter your Access Code to view a blocked channel, ALL blocked channels will be viewable until you turn off the TV. Channels will be blocked as before when you turn on the TV again.

Enter your Access Code to view a blocked channel.



After blocking specific channels, you might want to clear all the channels so you can view them. To do so, follow these steps.

- 1** Press **MENU** to see the menu.
- 2** Press **▲** or **▼** to select **FEATURES**.
- 3** Press **▶** to see the FEATURES menu.
- 4** Press **▲** or **▼** to select SmartLock (AutoLock).
- 5** Press **▶**.
- 6** Press the **Number** buttons to enter your four-digit personal access code. The SmartLock menu will appear.
- 7** Press **▲** or **▼** to select **CLEAR ALL**.
- 8** Press **▶** to clear all blocked channels. The Clear All option will show as Cleared.
- 9** Press **STATUS/EXIT** to remove the menu.

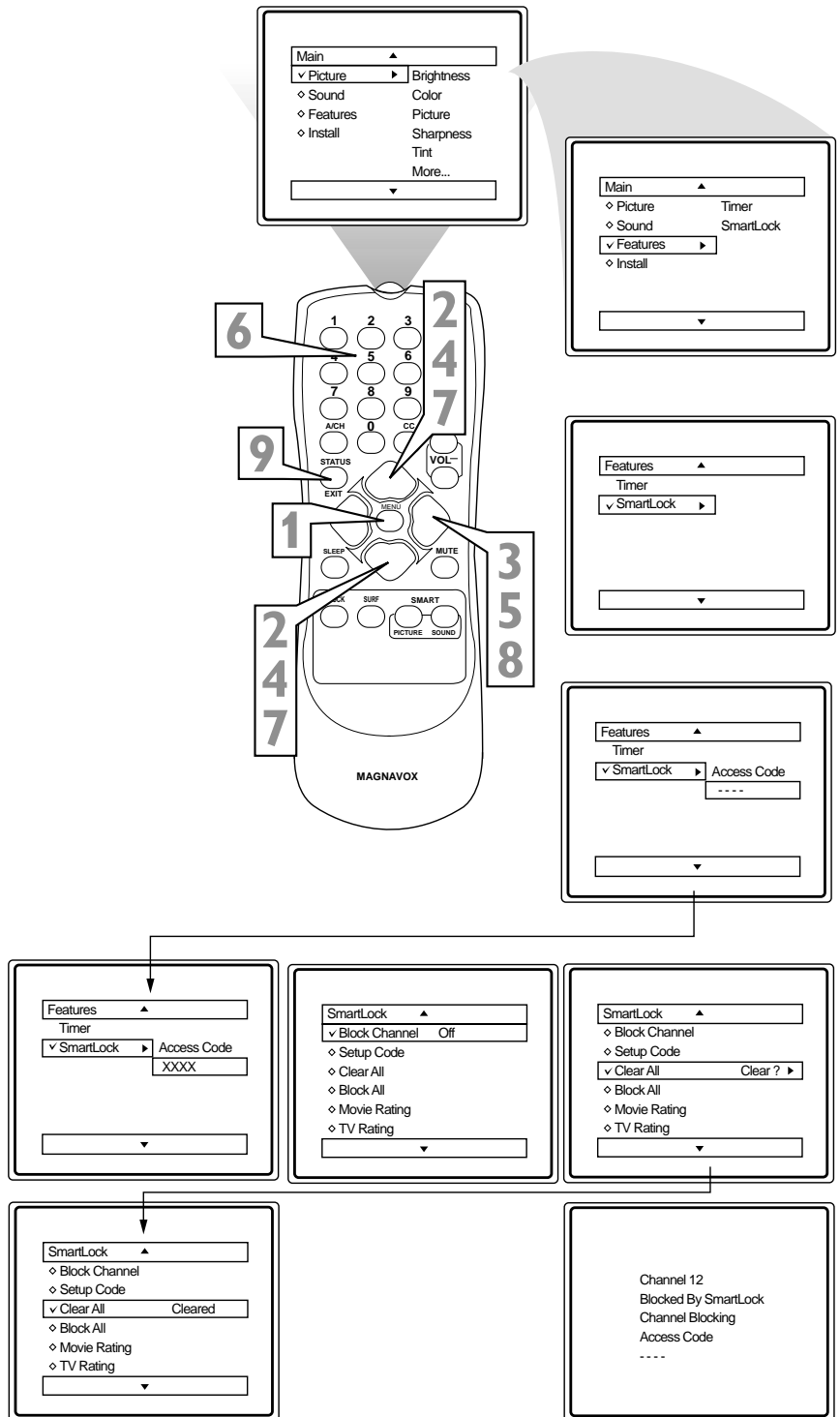

Some models refer to SmartLock as AutoLock. These features are the same.

HELPFUL HINT

If you enter your Access Code to view a blocked channel, ALL blocked channels will be viewable until you turn off the TV. Channels will be blocked as before when you turn on the TV again.

CLEAR ALL does not affect the Movie and TV Ratings.



SMARTLOCK - BLOCK ALL

You may want to block all the television's channels. Maybe you don't want your children to watch TV for a given time. With Block All, all available channels (including the FRONT Audio/Video In channel) can be blocked at the same time.

- 1 Press **MENU** to see the menu.
- 2 Press **▲** or **▼** to select **FEATURES**.
- 3 Press **▶** to see the FEATURES menu.
- 4 Press **▲** or **▼** to select SmartLock (AutoLock).
- 5 Press **▶**.
- 6 Press the **Number** buttons to enter your four-digit personal access code. The SmartLock menu will appear.
- 7 Press **▲** or **▼** to select **BLOCK ALL**.
- 8 Press **▶** to set BLOCK ALL to ON or OFF. Choose ON to block all channels.
- 9 Press **STATUS/EXIT** to remove the menu.

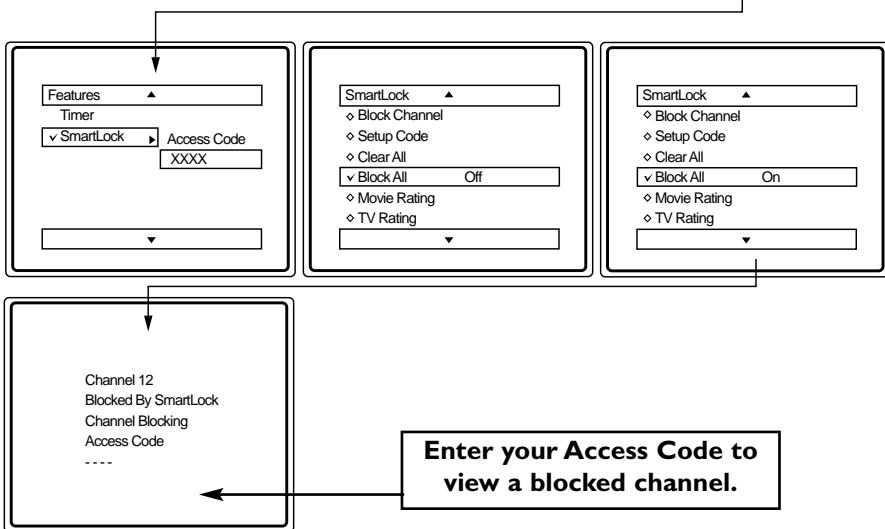
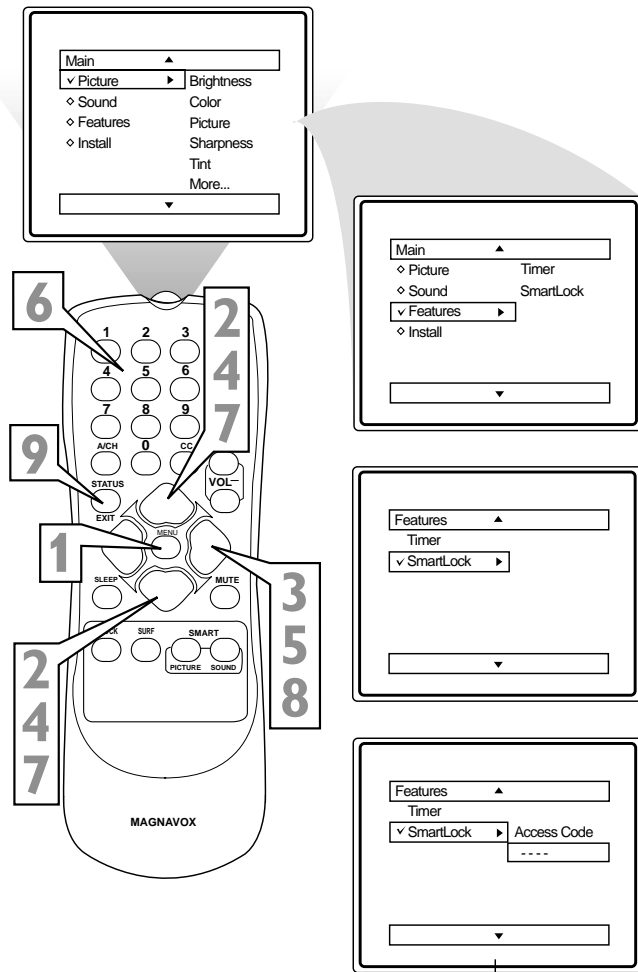

Some models refer to SmartLock as AutoLock. These features are the same.

HELPFUL HINT
If you enter your Access Code to view a blocked channel, all blocked channels will be viewable until you turn off the TV. Channels will be blocked as before when you turn on the TV again.



There are two types of ratings for SmartLock (AutoLock). One is based on movie industry ratings. The other is based on TV industry ratings. Let's first look at the Movie Ratings.

- 1 Press **MENU** to see the menu.
- 2 Press **▲** or **▼** to select **FEATURES**.
- 3 Press **▶** to see the FEATURES menu.
- 4 Press **▲** or **▼** to select SmartLock (AutoLock).
- 5 Press **▶**.
- 6 Press the **Number** buttons to enter your four-digit access code. The SmartLock menu will appear.
- 7 Press **▲** or **▼** to select **MOVIE RATINGS**.
- 8 Press **▶** to see the **MOVIE RATINGS**: G, PG, PG-13, R, NC-17, or X.
- 9 Press **▲** or **▼** to choose a Movie Rating.
- 10 Press **▶** to turn the rating **ON** (to block viewing) or **OFF** (to allow viewing).
All higher ratings will be blocked automatically. For example, if you block PG-13, then R, NC-17, and X will be blocked, too.

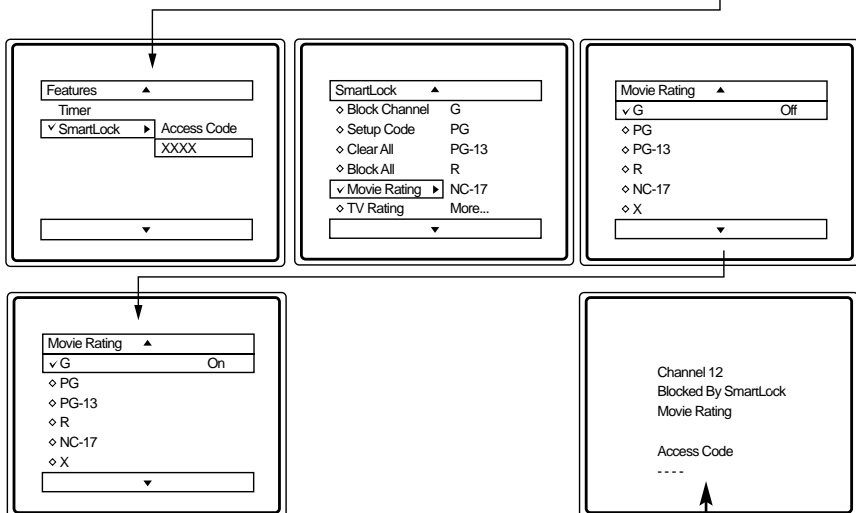
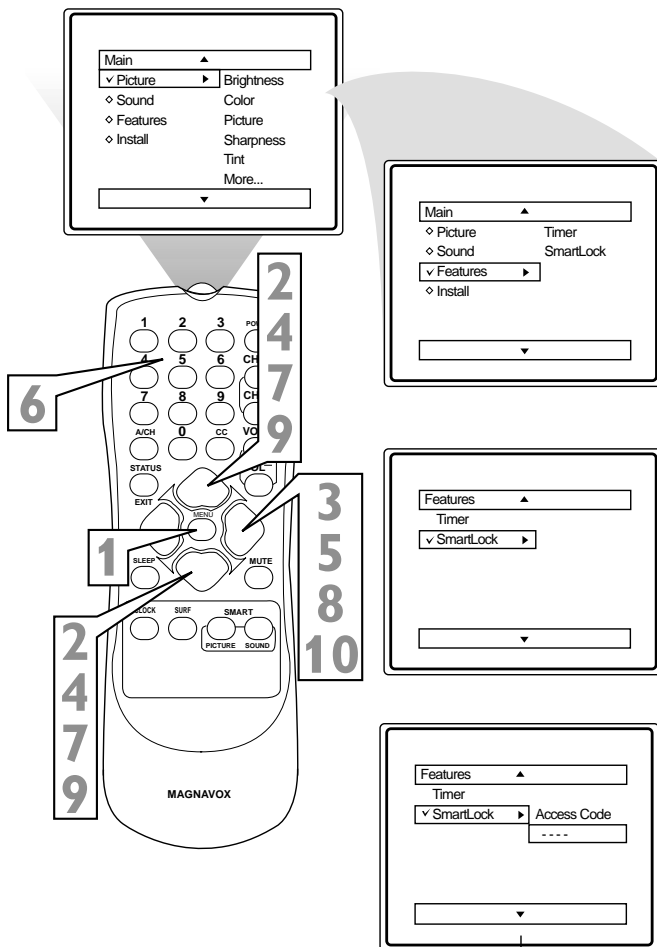

Enter your Access Code to view a channel blocked by Movie Ratings. All channels blocked by Movie Ratings will be viewable until you turn off the TV. Channels will be blocked as before when you turn on the TV again.

Some models refer to SmartLock as AutoLock. These features are the same.



SMARTLOCK - TV RATINGS

You can block programs that are rated by TV broadcasters as described below.

- 1** Press **MENU** to see the menu.
- 2** Press **▲** or **▼** to select **FEATURES**.
- 3** Press **▶** to see the FEATURES menu.
- 4** Press **▲** or **▼** to select SmartLock (AutoLock).
- 5** Press **▶**.
- 6** Press the **Number** buttons to enter your four-digit access code. The SmartLock menu will appear.
- 7** Press **▲** or **▼** to select TV RATING.
- 8** Press **▶** to see the TV RATINGS.
- 9** Press **▲** or **▼** to choose: TV-Y, TV-Y7, TV-G, TV-PG, TV-14, or TV-MA.
- 10** Press **▶** to turn the rating ON (to block viewing) or OFF (to allow viewing).
- 11** You can customize TV-Y7, TV-PG, TV-14, or TV-MA to block V (violence), FV (fantasy violence), S (sexual situations), L (coarse language), or D (suggestive dialog). Press **▶** to enter these sub-menus. Press **▲** or **▼** to select: Block All, V, S, L, D, or FV (as available).
- 12** Press **▶** to turn the sub-rating ON or OFF.
- 13** Press **STATUS/EXIT** to remove the menu.

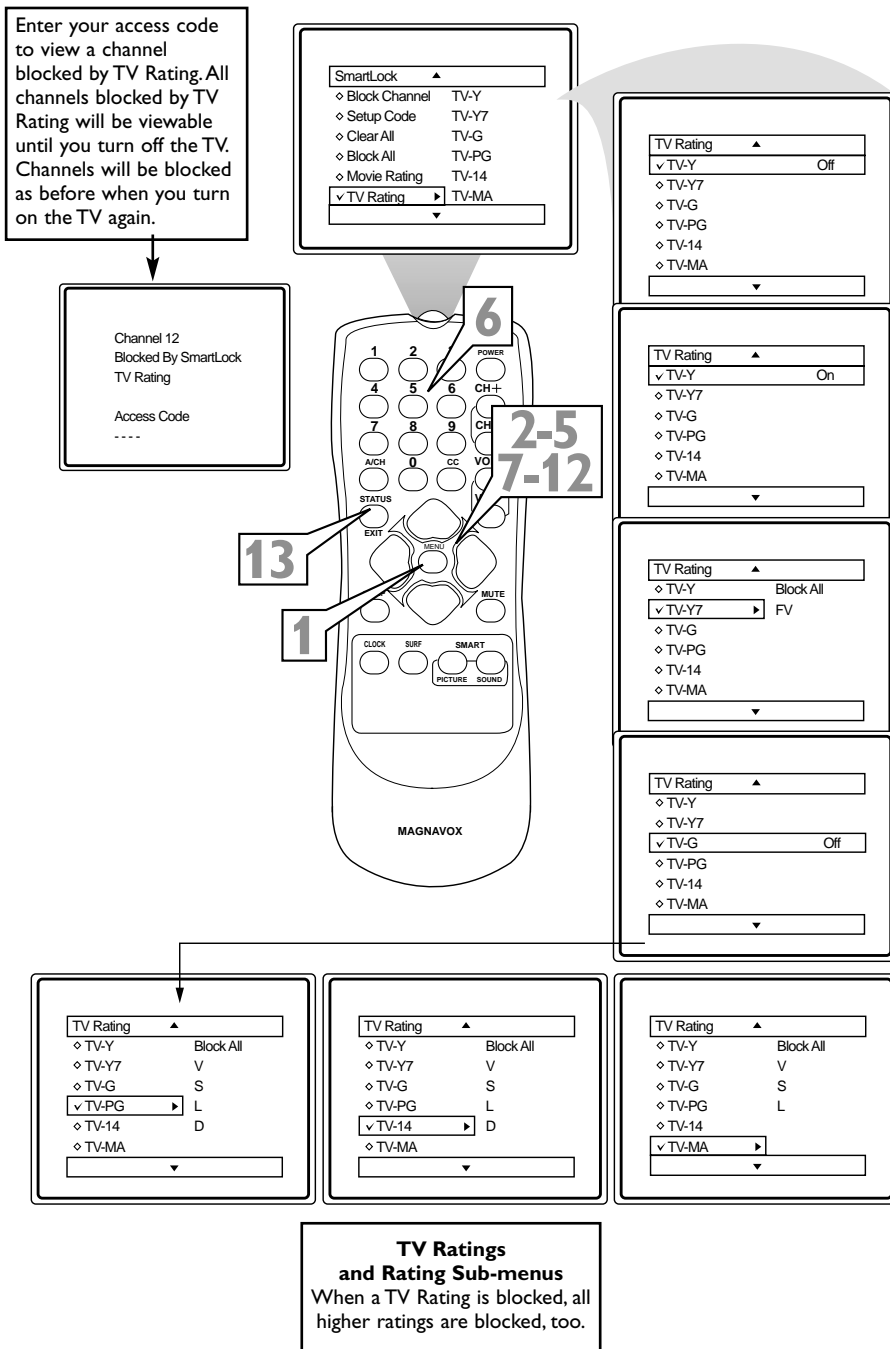

Some models refer to SmartLock as AutoLock. These features are the same.

SMARTLOCK - BLOCKING OPTIONS



SmartLock (AutoLock) also offers these special blocking options.

- 1** Press **MENU** to see the menu.
- 2** Press **▲** or **▼** to select **FEATURES**.
- 3** Press **▶** to enter the **FEATURES** menu.
- 4** Press **▲** or **▼** to select **SmartLock (AutoLock)**.
- 5** Press **▶**.
- 6** Use the **Number** buttons to enter your **four-digit access code**. The SmartLock menu will appear.
- 7** Press **▲** or **▼** to select **BLOCKING OPTIONS**, then press **▶**.
- 8** Press **▲** or **▼** to choose **BLOCKING, UNRATED, or NO RATING**.
- 9** Press **▶** or **◀** to turn the blocking option **ON** or **OFF**.
BLOCKING: Choose **ON** to enable all the blocking you have set. Choose **OFF** to disable your SmartLock settings.
UNRATED: Choose **ON** to block programs that are not rated by Movie Rating or TV Rating. Also set **BLOCKING** to **OFF**.
NO RATING: Choose **ON** to block programming that does not have content advisory data. Also set **BLOCKING** to **OFF**.
- 10** Press **STATUS/EXIT** to remove the menu.

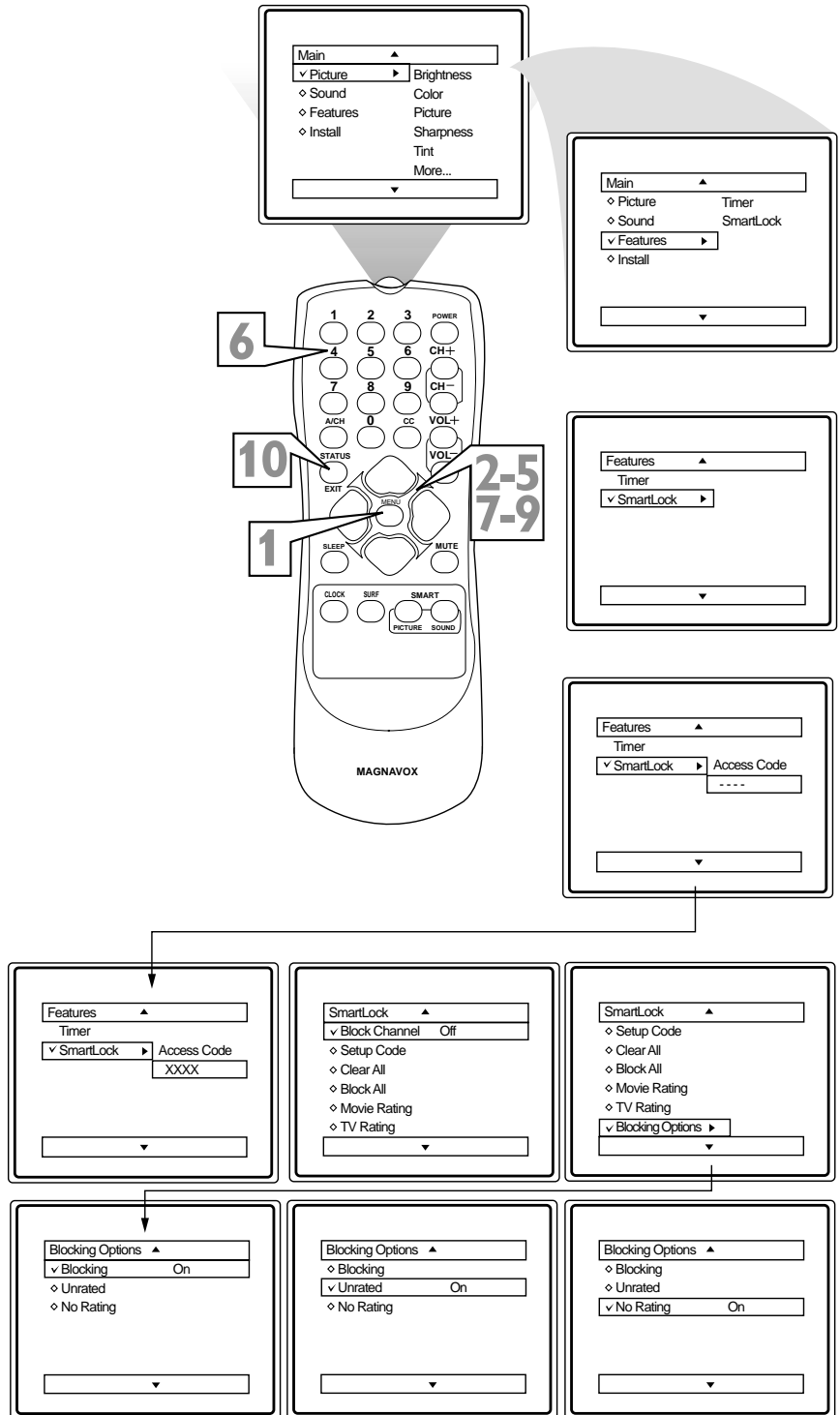

Some models refer to SmartLock as AutoLock. These features are the same.



TIMER (CLOCK)

The Time controls let you set the TV's clock. You also can set the TV to turn on or off at a specific time, or to turn on at a specific channel.

- 1** Press **MENU** to see the menu.
- 2** Press **▲** or **▼** to select **FEATURES**.
- 3** Press **▶** to see the **FEATURES** menu.
- 4** Press **▲** or **▼** to choose **TIMER**, then press **▶**.
- 5** Press **▲** or **▼** to choose **TIME**, **START TIME**, **STOP TIME**, **CHANNEL**, **ACTIVATE**, or **DISPLAY**.
- 6** Press **▶** to enter the menu you selected at step 5. Adjust these items accordingly.
TIME: Use the Number buttons to enter the current time. Press **▶** to choose the AM/PM area, then press **▲** or **▼** to choose AM or PM.
START TIME: Use the Number buttons to enter a specific time at which the TV will turn on to a specific channel.
STOP TIME: Use the Number buttons to enter a specific time at which the TV will turn itself off.
CHANNEL: Use the Number buttons to select the channel at which you want the TV to turn on (at the **START TIME**).
ACTIVATE: Set the Timer to occur **ONCE** or **DAILY**.
DISPLAY: Set to **ON** if you want the time to appear when you change channels or press **STATUS/EXIT** on the remote control. Otherwise, set **DISPLAY** to **OFF**.
- 7** Press **STATUS/EXIT** to remove the menu.

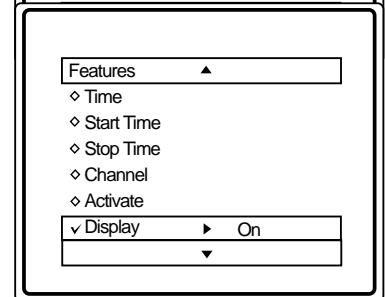
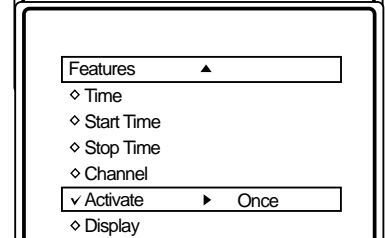
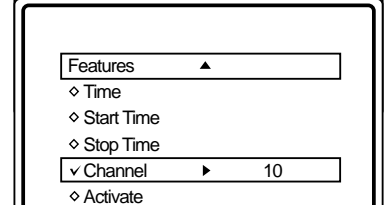
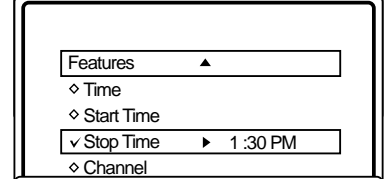
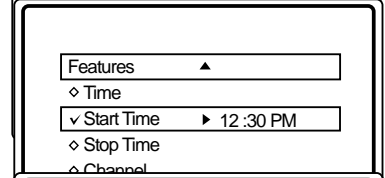
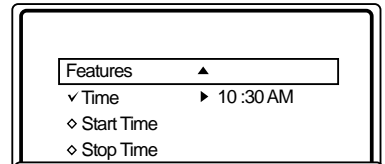
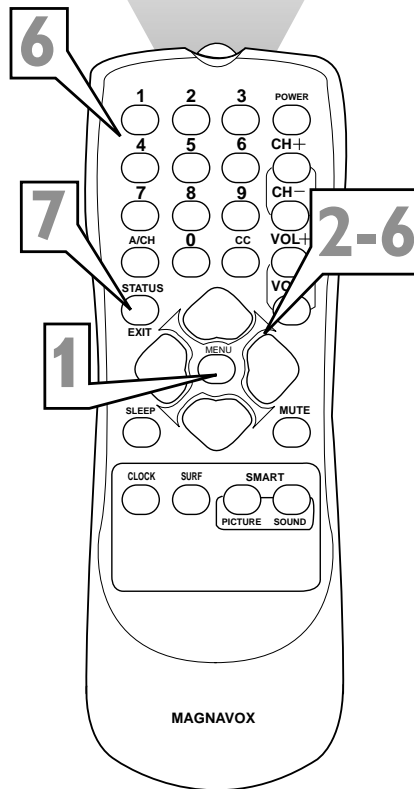
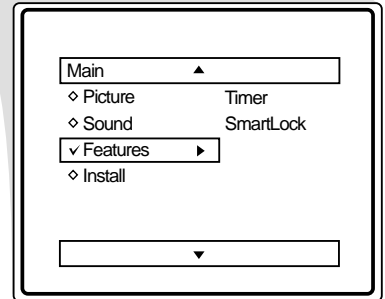
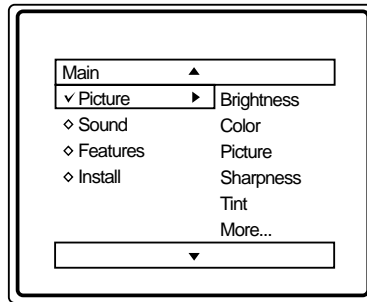

HELPFUL HINT

Press the **CLOCK** button on the remote control for quick access to the **TIME** menu.

SLEEP TIMER



Have you ever fallen asleep in front of the TV only to have it wake you up at two in the morning with a test pattern screeching in your ears? Well, your TV can save you all that trouble by turning itself off.

- 1 Press SLEEP.** The Sleep Timer menu will appear on the screen.
- 2 Press SLEEP repeatedly** to pick the amount of time (15, 30, 45, 60, 90, 120, 180, or 240 minutes) before the TV will turn off. The Sleep Timer menu will disappear automatically, or you can press STATUS/EXIT to remove it.

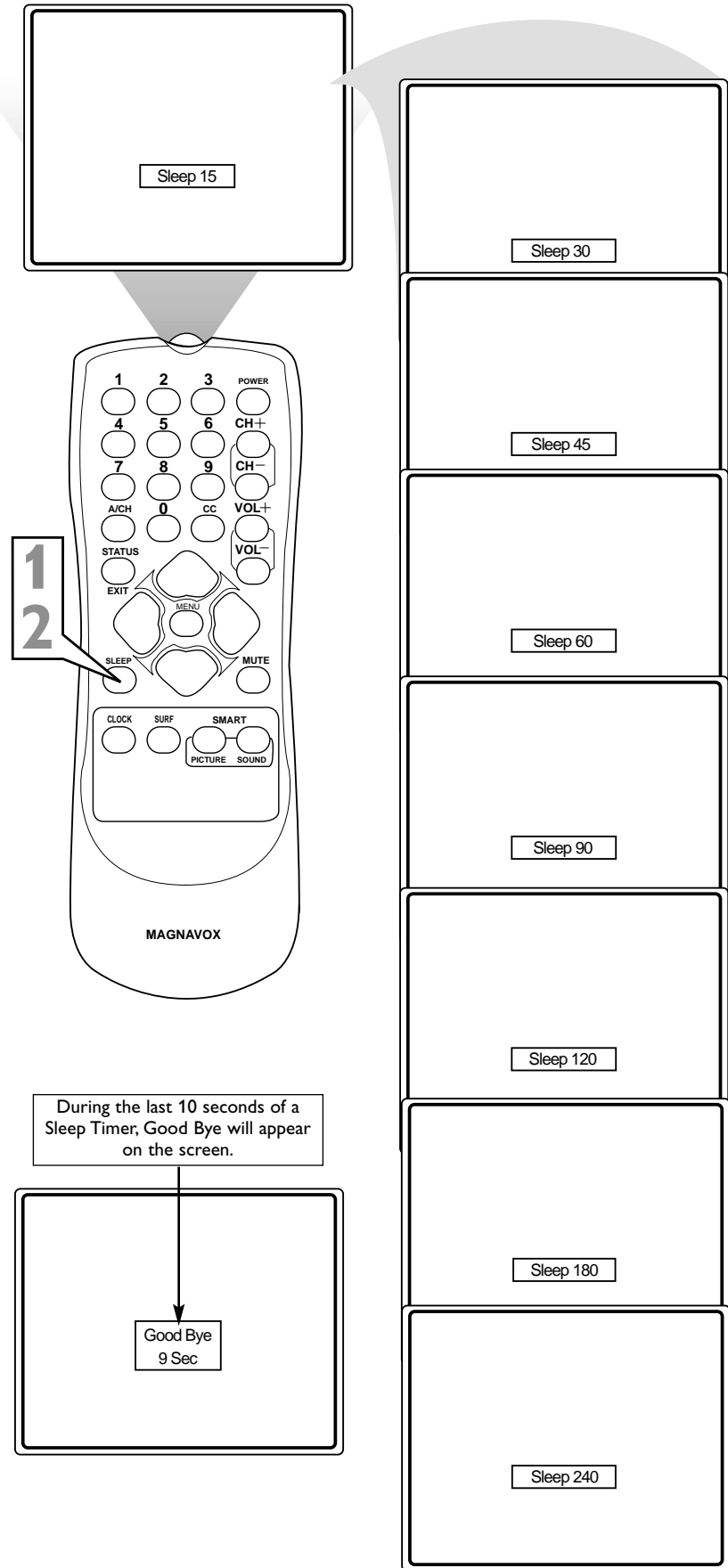

During the last minute before the TV turns off, the remaining seconds will count down on the TV screen. Pressing any button during the last minute will cancel the Sleep Timer.

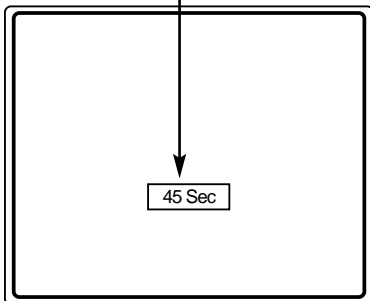

During the last 10 seconds of a Sleep Timer, Good Bye will appear on the screen.

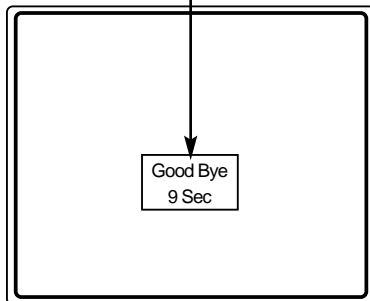



CLOSED CAPTIONS

Closed Captioning (CC) lets you read the voice content of TV programs on the TV screen. Designed to help the hearing impaired, on-screen text boxes will show dialog, conversations, and activity during TV programming.

- 1 Press CC** to see the current Closed Caption setting.
- 2 Press CC repeatedly** to select the closed caption you want: **CC Off**, **CC 1**, **CC 2**, or **CC Mute**.
CC Mute sets the TV to show closed captions when you press MUTE. The TV volume will be disabled until you press MUTE again to restore the sound.

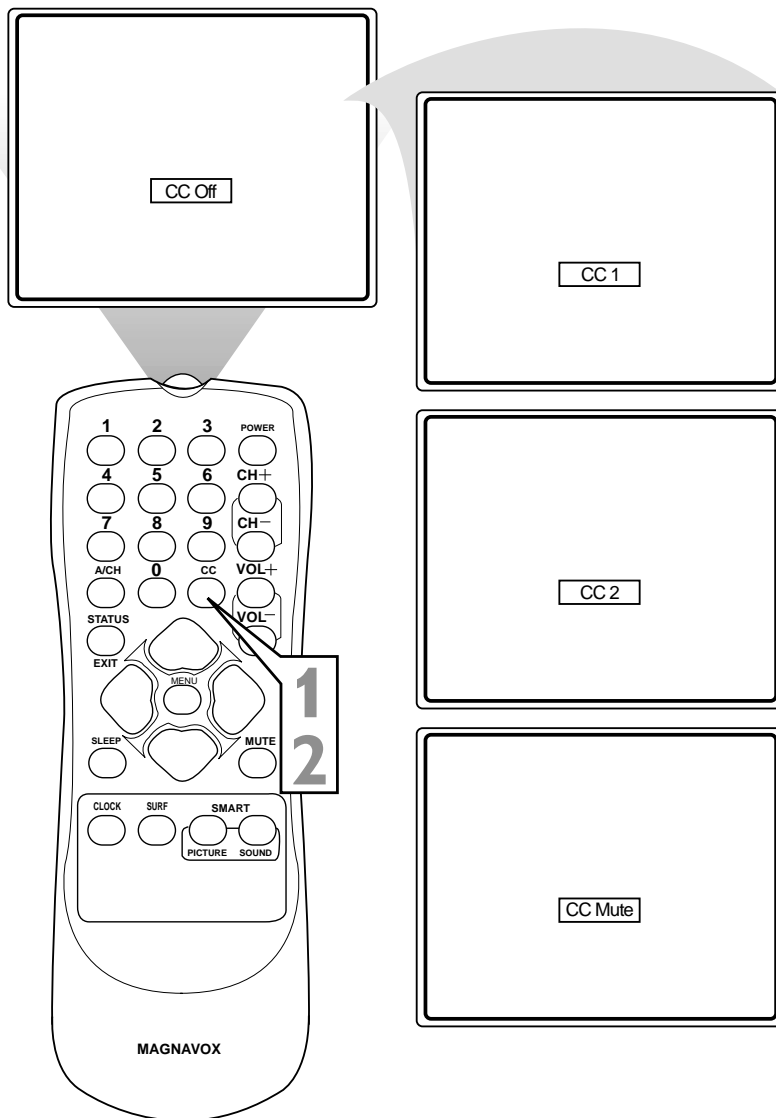

HELPFUL HINT

Not all TV programs and commercials are broadcast with Closed Captions. Neither are all Closed Caption modes transmitted by a station for a closed caption program. See your TV listings for the stations and times of Closed Captioned shows.



SmartPicture resets your TV's video settings for different types of programs and viewing conditions. Each SmartPicture setting has specific values for Brightness, Color, Picture, Sharpness, Tint, Color Temperature, Dynamic Noise Reduction (DNR), and Contrast + levels.

1 Press **SMART PICTURE** to see the current SmartPicture setting.

2 Press **SMART PICTURE** repeatedly to select PERSONAL, MOVIES, SPORTS, WEAK SIGNAL, or MULTI MEDIA.

PERSONAL - The Personal setting is what you specify with the picture adjustments as described on page 14. Personal is the only SmartPicture setting you can change. All others are set at the factory during production.

MOVIES - Use when watching videotapes or DVDs on a device that is connected to the TV.

SPORTS - Use when watching sporting events.

WEAK SIGNAL - Use when watching TV programs when the channel reception is poor.

MULTI MEDIA - Use when playing video games on a device that is connected to the TV.

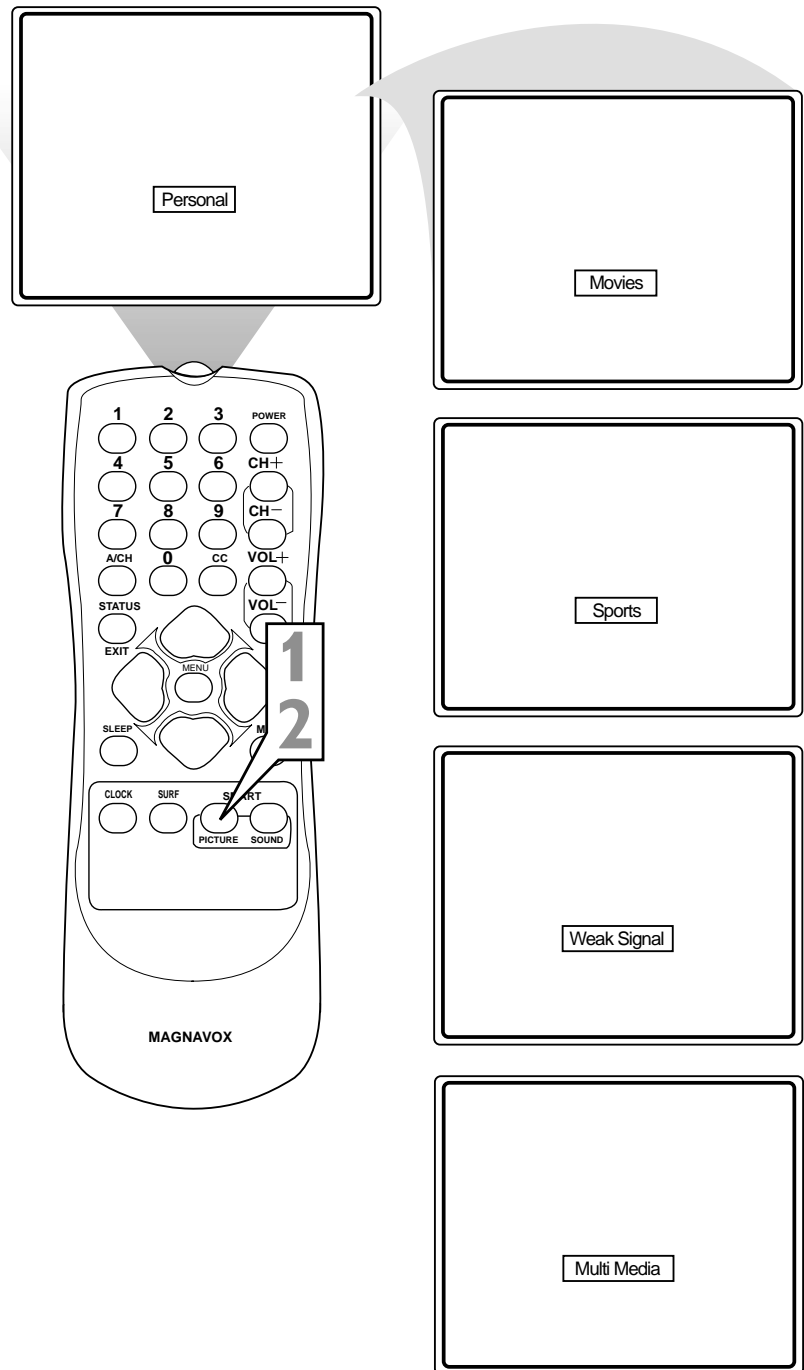



SMARTSOUND

SmartSound offers four preset sound options: Personal, Theatre, Music, and Voice. Choose the one that best suits your current programming.

- 1 Press SMART SOUND.** The current Smart Sound setting will appear on the screen.
- 2 Press SMART SOUND repeatedly** to choose: PERSONAL, THEATRE, MUSIC, or VOICE.
PERSONAL: This setting is what you specify with the sound adjustments as described on page 15. Personal is the only SmartSound setting you can change. All others are set at the factory during production.
THEATRE: Use when watching movies.
MUSIC: Use when watching a musical program that has limited dialog.
VOICE: Use when viewing programming that has primarily dialog.

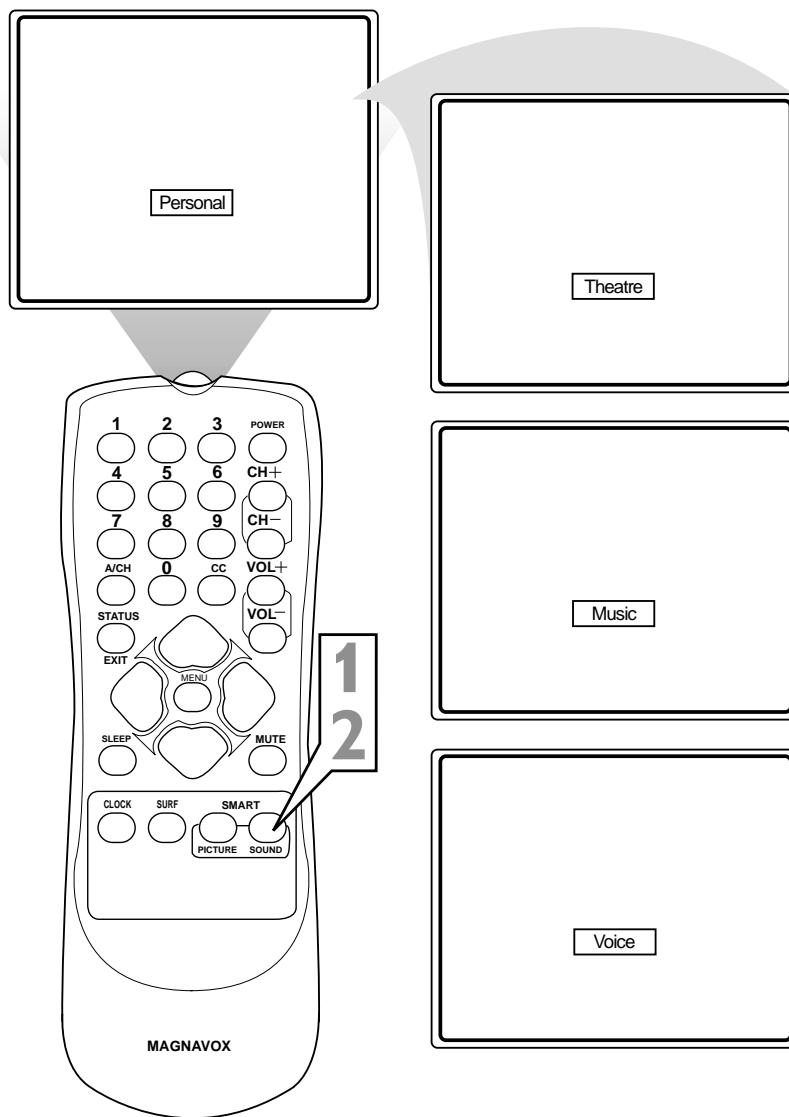



SmartSurf lets you set up to eight channels in a quick viewing list. Then, you can use the SURF button on the remote control to switch between different TV programs that currently interest you.

SmartSurf is not available with all models.

- 1** Press CH +/- or the Number buttons to select a channel to add to the SURF list.
- 2** Press SURF while the channel number appears.
- 3** Press ► or ◀ to add the channel to the SURF list or delete it from the list. An on-screen message will indicate whether you are adding or deleting the channel. Repeat steps 1 through 3 to add additional channels (up to eight) to the SURF list.

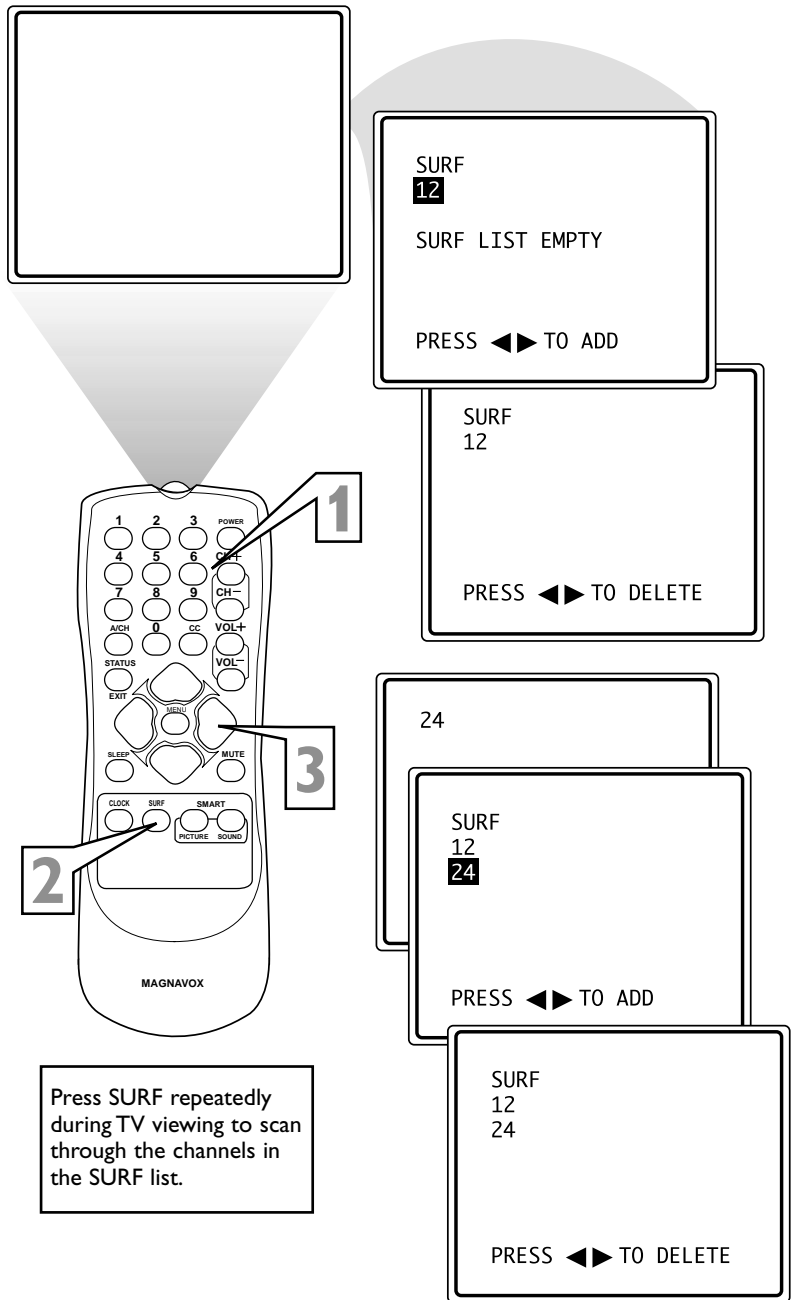

Press SURF repeatedly during TV viewing to scan through the channels in the SURF list.

A/CH Button

Your remote has an A/CH (Alternate Channel) button. Press A/CH to toggle between the current and previous channel.

The diagram shows the remote control with the A/CH button highlighted by a callout '1'. To the right, two on-screen messages are shown: one with the number '5' and another with the number '12'. Arrows indicate a bidirectional relationship between these two messages, representing the channel toggling function.



TROUBLESHOOTING

No Power

- Check the TV power cord. Disconnect the power cord from the power outlet for 10 seconds, then reinsert the plug into the outlet. Press POWER to turn on the TV again.
- Make sure the outlet is not on a wall switch.
- Make sure a fuse has not blown at the power outlet.

No Picture

- Check the antenna or Cable TV connections. Connect the antenna or Cable TV signal securely to the TV's 75Ω jack on the rear of the TV.
- Set TUNER MODE correctly. *Details are on page 11.*
- Activate AUTO PROGRAM to find all available channels. *Details are on page 12.*

No Sound

- Press the VOL+ and VOL- buttons to adjust the volume.
- Press the MUTE button on the remote control to cancel or restore the volume.
- If you have connected other equipment to the TV (such as a VCR or DVD Player), make sure the audio cables are connected securely between the TV and the other equipment.
- Check the SOUND settings. *Details are on page 15.*

Remote Control does not work.

- Check the batteries. If necessary, replace them with two AA heavy duty (zinc chloride) or alkaline batteries.
- Clean the remote control as well as the remote control sensor on the front of the TV.
- Check the TV power cord. Disconnect the power cord from the power outlet for 10 seconds, then reinsert the plug into the outlet. Press POWER to turn on the TV again.
- Make sure the outlet is not on a wall switch.
- Make sure a fuse has not blown at the power outlet.
- Always point the remote control toward the front of the TV (toward the remote sensor).

TV displays wrong channel or no channels.

- Repeat channel selection.
- Add the channel number(s) into the TV's memory. Use CHANNEL/EDIT. *Details are on page 13.*
- Make sure TUNER MODE is set correctly. *Details are on page 11.* Then activate AUTO PROGRAM to set up all available channels. *Details are on page 12.*



CARE AND CLEANING

WARNING concerning stationary images on the TV screen: Do not leave fixed images on the screen for extended periods of time. This can cause uneven aging of the picture tube.

Normal use of the TV should involve viewing of programs that have constantly moving or changing images. Do not leave non-moving images on screen for extended periods of time. Do not display the same images too frequently; if you do, subtle "ghost" images can be left on the picture tube. Sources of stationary images may be Laser discs, video games, Compact Discs Interactive (CD-i), or paused Digital Video Discs (DVDs) or videotapes.

Here are some common examples of stationary images:

- **DVD menus** list DVD content.
- **Letterbox black bars** appear at the top and bottom of the TV screen when a wide screen (16:9) movie is viewed on a TV with standard (4:3) aspect ratio. This is available with some DVDs.
- **Video game images and scoreboards**
- **Television station logos** cause a problem if they are bright and stationary. Moving or low-contrast graphics are less likely to damage the picture tube.
- **Stock market tickers** may appear at the bottom of the TV screen if the TV programming covers this news.
- **Shopping channel logos, pricing displays** may be bright and may appear constantly during the show. These are usually in the same location on the TV screen.

TV Location

- To avoid cabinet warping, cabinet color changes, and an increased chance of TV failure, do not place the TV where temperatures can become excessively hot (for example, in direct sunlight or near a heating appliance).
- Allow a free flow of air around the TV.

Cleaning

- To avoid possible shock hazard, remove the TV's power cord from the electrical outlet before cleaning.
- Regularly dust the TV with a dry, non-scratching duster.
- When cleaning the TV, take care not to scratch or damage the screen surface. Avoid wearing jewelry or using anything abrasive. Do not use household cleaners. Wipe the screen with a clean cloth dampened with water. Use even, easy, vertical strokes when cleaning.
- Gently wipe the cabinet surfaces with a clean cloth or a sponge dampened in a solution of cool, clear water and a mild soap or detergent. Use a clean, dry cloth to dry the wiped surfaces.
- Occasionally vacuum the vents on the rear of the TV.
- Never use thinners, insecticide sprays, or other chemicals on or near the cabinet. They may blemish the cabinet permanently.



Audio/Video Inputs • Jacks (standard RCA) on the front of the TV to which you connect accessory devices. These jacks receive picture and sound from equipment such as a DVD Player, VCR, Camcorder, etc.

Auto Program • Scans all available channels from regular antenna or Cable TV signals and stores only active stations in the TV's memory.

Closed Captioning • The broadcast feature that lets you read the voice content of television programs on the TV screen. Designed to help the hearing impaired, Closed Captioning shows dialog, activity, and conversations while a TV program is in progress.

Coaxial Cable • A single solid wire normally matched with a metal plug (F-type) end connector that screws (or pushes) directly onto a 75-ohm jack on the television or VCR.

Menu • An on-screen list of controls available for adjustment.

Remote Control Sensor • The window or opening on the front of the TV through which infrared remote control signals are received.

Surf • Scanning specific channels in a limited channel list.



FACTORY SERVICE LOCATIONS

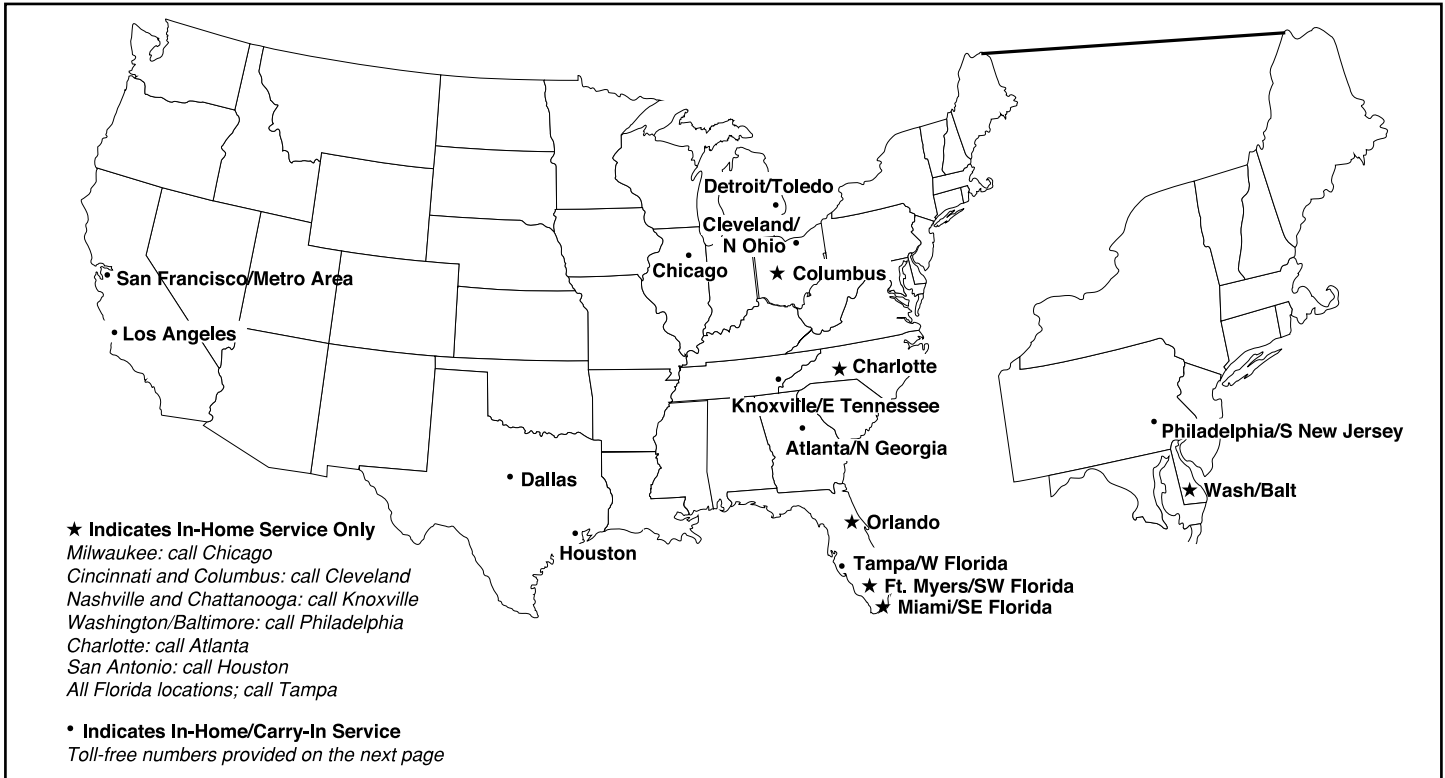

NOTE: Magnavox has chosen Philips Factory Service as its preferred, authorized servicer. Please contact a Philips Factory Service Center. If you reside in one of our Philips Factory Service Branch areas, you can contact the nearest Service Branch to obtain efficient and expedient repair for your product. If your product is In-Warranty, you should have proof-of-purchase to ensure No Charge Service. For Out-of-Warranty service, call the location nearest you.

NOTA: Si vous résidez dans une des régions desservies par une succursale de service après vente du fabricant Philips (voir liste ci-dessous), vous pourrez contacter la branche de service après vente la plus près de chez vous pour obtenir un service après vente rapide et efficace. Si le produit est sous garantie, il suffira de présenter une preuve d'achat pour bénéficier d'un service sans frais. Pour les produits non couverts par la garantie, contactez le centre le plus près de chez vous.

NOTA: Si Ud. reside en una de nuestras zonas para sucursales Philips de servicio al de fábrica (ver directorio más abajo), Ud. puede comunicarse con la sucursal de servicio más cercana para obtener una reparación oportuna y eficaz de su producto. Si su producto está todavía bajo garantía, Ud. debe presentar comprobante de compra para no ocasionar ningunos cargos por servicio. Para servicio después del vencimiento de la garantía, llame al lugar más cercano de los abajo indicados.

In Canada

To obtain efficient and expedient carry-in, mail-in, or in-home service for your product, please contact Magnavox at:

- 1-800-661-6162 (French speaking)
- 1-800-705-2000 (English or Spanish speaking)

Au Canada

Comment obtenir le service après-vente pour les produits apportés ou envoyés par la poste à notre centre de service ou le service à domicile, veuillez contacter Magnavox à:

- 1-800-661-6162 (Francophone)
- 1-800-705-2000 (Anglais ou Espagnol)

En el Canadá

Cómo recibir servicio eficiente para su producto, en persona, por correo o a domicilio, favor de comunicarse con Magnavox al:

- 1-800-661-6162 (francófono)
- 1-800-705-2000 (Inglés o Español))

FACTORY SERVICE LOCATIONS



QUALITY SERVICE IS AS CLOSE AS YOUR TELEPHONE! SIMPLY LOOK OVER THE LIST BELOW FOR THE NUMBER OF A FACTORY SERVICE CENTER NEAR YOU. MAGNAVOX HAS CHOSEN PHILIPS FACTORY SERVICE AS ITS PREFERRED, AUTHORIZED SERVICER. YOUR PRODUCT WILL RECEIVE EFFICIENT AND EXPEDIENT CARRY-IN, MAIL-IN, OR IN-HOME SERVICE, AND YOU WILL RECEIVE PEACE OF MIND, KNOWING YOUR PRODUCT IS BEING GIVEN THE EXPERT ATTENTION OF PHILIPS' FACTORY SERVICE.

COMMENT OBTENIR NOTRE SERVICE APRÈS VENTE RAPIDE ET EFFICACE SOIT PAR COURRIER, À DOMICILE, OU EN SE PRÉSENTANT À UN CENTRE DE SERVICE PHILIPS. PLUS DE 600 CENTRES DE RÉCEPTION DE PRODUITS À RÉPARER À TRAVERS LE PAYS: CONTACTER LE CENTRE DE SERVICE AUX CONSOMMATEURS LE PLUS PROCHE POUR SAVOIR L'EMPLACEMENT DE CES DÉPÔTS DANS UN RAYON DE 50 À 75 MILES (80 KM À 120 KM) DU CENTRE DE SERVICE LOCAL.

CÓMO OBTENER UN SERVICIO OPORTUNO Y EFICIENTE POR CORREO, EN CASA O EN PERSONA PARA SU PRODUCTO A TRAVÉS DE UN CENTRO PHILIPS DE SERVICIO. MAS DE 600 SITIOS POR TODO EL PAIS PARA LA RECEPCION DE PRODUCTOS NECESITADOS DE REPARACIONES: COMUNICARSE CON EL CENTRO DE SERVICIO DE FABRICA MAS CERCANO PARA ESTOS LUGARES DENTRO DE UN RADIO DE 80 A 120 KM (50 A 75 MILLAS) DEL CENTRO DE SERVICIO LOCAL.

ATLANTA

Philips Factory Service
550 Franklin Road., Suite F
Marietta, GA 30067
800-273-1501

TAMPA

Philips Factory Service
1911 US Highway 301 North, Suite 100
Tampa, FL 33619
800-442-2027

SAN FRANCISCO

Philips Factory Service
681 East Brokaw Rd.
San Jose, CA 95112
800-300-9013

HOUSTON

Philips Factory Service
1110 N. Post Oak Rd., Suite 100
Houston, TX 77055
800-952-3254

CLEVELAND

Philips Factory Service
950 Keynote Circle
Brooklyn Heights, OH 44131
800-331-7037

DETROIT

Philips Factory Service
25173 Dequindre
Madison Heights, MI 48071
800-438-1398

DALLAS

Philips Factory Service
415 N. Main Street, #107
Euless, TX 76040
800-952-3254

LOS ANGELES

Philips Factory Service
20930 Bonita, Ste.V
Carson, CA 90746
800-300-9013

CHICAGO

Philips Factory Service
1279 W. Hamilton Pkwy.
Itasca, IL 60143
800-531-2922

KNOXVILLE

Philips Factory Service
One Philips Drive
Building 2
Knoxville, TN 37914
800-821-1767

PHILADELPHIA

Philips Factory Service
354 Dunks Ferry Rd.
Bensalem, PA 19020
800-847-9320



INDEX

Activate	.24	SmartLock (AutoLock)	
Alternate Channel	.29	Access Code	.17
Antenna Connection	.7	Block All	.20
Audio In jack	.8-9	Block Channels	.18
Auto Program	.12	Blocking Options	.23
AVL (Automatic Volume Leveler)	.15	Clear All	.19
		Movie Rating	.16, 21
Balance	.15	TV Rating	.16, 22
Bass Boost	.15	SmartPicture	.27
Batteries	.5	SmartSound	.28
Blocking	.23	SmartSurf	.29
Brightness	.14	Sound	.15
		Sports (SmartPicture)	.27
Cable Box Connections	.8	Start Time	.24
Cable TV Connection	.7	Stereo	.15
Care and Cleaning	.30	Stop Time	.24
Channel (Start Time)	.24		
Channel Edit	.13	Table of Contents	.4
Clock	.24	Theatre (SmartSound)	.28
Closed Captions	.26	Time	.24
Color	.14	Tint	.14
Color Temperature	.14	Treble Boost	.15
		Troubleshooting	.30
Display (Clock)	.24	Tuner Mode	.11
DNR (Dynamic Noise Reduction)	.14	TV Operation (Basic)	.5
Factory Service Information	.32-33	Unrated	.23
FRONT channel	.9		
		Video In jack	.8-9
Glossary	.31	Voice (SmartSound)	.28
Headphone jack	.5	Warranty	.36
		Weak Signal (SmartPicture)	.27
Index	.34	Welcome	.2
Language	.10		
Limited Warranty	.36		
Mono	.15		
Movies (SmartPicture)	.27		
Multi Media (SmartPicture)	.27		
Music (SmartSound)	.28		
No Rating	.23		
Personal (SmartPicture)	.27		
Personal (SmartSound)	.28		
Picture Adjustments	.14		
Registration	.2		
Remote Control Buttons	.6		
Remote Control Operation (Basic)	.5		
Safety Instructions	.3		
Sharpness	.14		
Skipped	.13		
Sleep Timer	.25		

LIMITED WARRANTY

COLOR TELEVISION

90 Days Free Labor

One Year Parts Exchange

This product must be carried in for service.

WHO IS COVERED?

You must have proof of purchase to receive warranty service. A sales receipt or other document showing that you purchased the product is considered proof of purchase.

WHAT IS COVERED?

Warranty coverage begins the day you buy your product. For 90 days thereafter, all parts will be repaired or replaced free, and labor is free. From 90 days to one year from the day of purchase, all parts will be repaired or replaced free, but you pay for all labor charges. After one year from the day of purchase, you pay for the replacement or repair of all parts, and for all labor charges.

All parts, including repaired and replaced parts, are covered only for the original warranty period. When the warranty on the product expires, the warranty on all replaced and repaired parts also expires.

WHAT IS EXCLUDED?

Your warranty does not cover:

- labor charges for installation or setup of the product, adjustment of customer controls on the product, and installation or repair of antenna systems outside of the product.
- product repair and/or part replacement because of misuse, accident, unauthorized repair or other cause not within the control of Magnavox.
- reception problems caused by signal conditions or cable or antenna systems outside the unit.
- a product that requires modification or adaptation to enable it to operate in any country other than the country for which it was designed, manufactured, approved and/or authorized, or repair of products damaged by these modifications.
- incidental or consequential damages resulting from the product. (Some states do not allow the exclusion of incidental or consequential damages, so the above exclusion may not apply to you. This includes, but is not limited to, prerecorded material, whether copyrighted or not copyrighted.)
- a product used for commercial or institutional purposes.

WHERE IS SERVICE AVAILABLE?

Warranty service is available in all countries where the product is officially distributed by Magnavox. In countries where Magnavox does not distribute the product, the local Magnavox service organization will attempt to provide service (although there may be a delay if the appropriate spare parts and technical manual(s) are not readily available).

MAKE SURE YOU KEEP...

Please keep your sales receipt or other document showing proof of purchase. Attach it to this owner's manual and keep both nearby. Also keep the original box and packing material in case you need to return your product.

BEFORE REQUESTING SERVICE...

Please check your owner's manual before requesting service. Adjustments of the controls discussed there may save you a service call.

TO GET WARRANTY SERVICE IN U.S.A., PUERTO RICO, OR U.S. VIRGIN ISLANDS...

Contact a Magnavox factory service center (see enclosed list) or authorized service center to arrange repair.

(In U.S.A., Puerto Rico, and U.S. Virgin Islands, all implied warranties, including implied warranties of merchantability and fitness for a particular purpose, are limited in duration to the duration of this express warranty. But, because some states do not allow limitations on how long an implied warranty may last, this limitation may not apply to you.)

TO GET WARRANTY SERVICE IN CANADA...

Please contact Magnavox at:

1-800-705-2000

(In Canada, this warranty is given in lieu of all other warranties. No other warranties are expressed or implied, including any implied warranties of merchantability or fitness for a particular purpose. Magnavox is not liable under any circumstances for any direct, indirect, special, incidental or consequential damages, howsoever incurred, even if notified of the possibility of such damages.)

REMEMBER...

Please record below the model and serial numbers found on the product. Also, please fill out and mail your warranty registration card promptly. It will be easier for us to notify you if necessary.

MODEL # _____

SERIAL # _____

This warranty gives you specific legal rights. You may have other rights which vary from state/province to state/province.

Magnavox, P.O. Box 520890, Miami, FL 33152 (402) 536-4171
EL6541E001

Free Manuals Download Website

<http://myh66.com>

<http://usermanuals.us>

<http://www.somanuals.com>

<http://www.4manuals.cc>

<http://www.manual-lib.com>

<http://www.404manual.com>

<http://www.luxmanual.com>

<http://aubethermostatmanual.com>

Golf course search by state

<http://golfingnear.com>

Email search by domain

<http://emailbydomain.com>

Auto manuals search

<http://auto.somanuals.com>

TV manuals search

<http://tv.somanuals.com>