

NB500MG9

Blu-ray Disc Player

STOP! Thank you for choosing Magnavox.

Need help fast?

Read your Owner's Manual first for quick tips that make using your Magnavox product more enjoyable. If you have read assistance, you may access our online help at <http://www.funai-corp.com> or call **1-800-605-8610** while with your product (and Model / Serial number)



PRECAUTIONS

The model and serial numbers of this unit may be found on the cabinet.
You should record and retain those numbers for future reference.

Model No.: _____

Serial No.: _____

WARNING: TO REDUCE THE RISK OF FIRE OR ELECTRIC SHOCK, DO NOT EXPOSE THIS APPARATUS TO RAIN OR MOISTURE.



CAUTION
RISK OF ELECTRIC SHOCK
DO NOT OPEN



CAUTION: TO REDUCE THE RISK OF ELECTRIC SHOCK, DO NOT REMOVE COVER (OR BACK). NO USER SERVICEABLE PARTS INSIDE. REFER SERVICING TO QUALIFIED SERVICE PERSONNEL.



The lightning flash with arrowhead symbol, within an equilateral triangle, is intended to alert the user to the presence of uninsulated "dangerous voltage" within the apparatus's enclosure that may be of sufficient magnitude to constitute a risk of electric shock to persons.



The exclamation point within an equilateral triangle is intended to alert the user to the presence of important operating and maintenance (servicing) instructions in the literature accompanying the apparatus.

The caution marking is located on the rear or bottom of the cabinet.

Important Safeguards

- 1. READ INSTRUCTIONS** - All the safety and operating instructions should be read before the apparatus is operated.
- 2. RETAIN INSTRUCTIONS** - The safety and operating instructions should be retained for future reference.
- 3. HEED WARNINGS** - All warnings on the apparatus and in the operating instructions should be adhered to.
- 4. FOLLOW INSTRUCTIONS** - All operating and use instructions should be followed.
- 5. CLEANING** - Unplug this apparatus from the wall outlet before cleaning. Do not use liquid cleaners or aerosol cleaners. Use a damp cloth for cleaning.
EXCEPTION: An apparatus that is meant for uninterrupted service and, that for some specific reason, such as the possibility of the loss of an authorization code for a CATV converter, is not intended to be unplugged by the user for cleaning or any other purpose, may exclude the reference to unplugging the apparatus in the cleaning description otherwise required in item 5.
- 6. ATTACHMENTS** - Do not use attachments not recommended by the apparatus manufacturer as they may cause hazards.
- 7. WATER AND MOISTURE** - Do not use this apparatus near water, for example, near a bath tub, wash bowl, kitchen sink, or laundry tub, in a wet basement, or near a swimming pool, and the like.
- 8. ACCESSORIES** - Do not place this apparatus on an unstable cart, stand, tripod, bracket, or table. The apparatus may fall, causing serious injury to someone, and serious damage to the apparatus. Use only with a cart, stand, tripod, bracket, or table recommended by the manufacturer, or sold with the apparatus. Any mounting of the apparatus should follow the manufacturer's instructions and should use a mounting accessory recommended by the manufacturer. An apparatus and cart combination should be moved with care. Quick stops, excessive force, and uneven surfaces may cause the apparatus and cart combination to overturn.
- 9. VENTILATION** - Slots and openings in the cabinet and the back or bottom are provided for ventilation and to ensure reliable operation of the apparatus and to protect it from overheating, these openings must not be blocked or covered. The openings should never be blocked by placing the apparatus on a bed, sofa, carpet, rug, or other similar surface. This apparatus should never be placed near or over a radiator or heat register. This apparatus should not be placed in a built-in installation such as a bookcase or rack unless proper ventilation is provided or the manufacturer's instructions have been adhered to.
- 10. POWER SOURCES** - This apparatus should be operated only from the type of power source indicated on the marking label. If you are not sure of the type of power supply to your home, consult your apparatus dealer or local power company. For the apparatus's intended to operate from battery power, or other sources, refer to the operating instructions.
- 11. GROUNDING OR POLARIZATION** - This apparatus is equipped with a polarized alternating-current line plug (a plug having one blade wider than the other). This plug will fit into the power outlet only one way. This is a safety feature. If you are unable to insert the plug fully into the outlet, try reversing the plug. If the plug should still fail to fit, contact your electrician to replace your obsolete outlet. Do not defeat the safety purpose of the polarized plug.
- 12. POWER-CORD PROTECTION** - Power-supply cords should be routed so that they are not likely to be walked on or pinched by items placed upon or against them, paying particular attention to cords at plugs, convenience receptacles, and the point where they exit from the apparatus.
- 13. OUTDOOR ANTENNA GROUNDING** - If an outside antenna or cable system is connected to the apparatus, be sure the antenna or cable system is grounded so as to provide some protection against voltage surges and built-up static charges. Article 810 of the National Electrical Code, ANSI/NFPA No. 70, provides information with respect to proper grounding of the mast and supporting structure, grounding of the lead-in wire to an antenna discharge unit, size of grounding conductors, location of antenna-discharge unit, connection to grounding electrodes, and requirements for the grounding electrode. (Fig. A)

FIGURE A
EXAMPLE OF ANTENNA GROUNDING AS PER NATIONAL ELECTRICAL CODE

Labels in diagram: ANTENNA LEAD WIRE, GROUND CLAMP, ANTENNA DISCHARGE UNIT (NEC SECTION 810-20), GROUNDING CONDUCTORS (NEC SECTION 810-21), GROUND CLAMP, POWER SERVICE GROUNDING ELECTRODE SYSTEM (NEC ART 250, PART H), ELECTRIC SERVICE EQUIPMENT, NEC - NATIONAL ELECTRICAL CODE
- 14. LIGHTNING** - For added protection for this apparatus receiver during a lightning storm, or when it is left unattended and unused for long periods of time, unplug it from the wall outlet and disconnect the antenna or cable system. This will prevent damage to the apparatus due to lightning and power-line surges.
- 15. POWER LINES** - An outside antenna system should not be located in the vicinity of overhead power lines or other electric light of power circuits, or where it can fall into such power lines or circuits. When installing an outside antenna system, extreme care should be taken to keep from touching such power lines or circuits as contact with them might be fatal.
- 16. OVERLOADING** - Do not overload wall outlets and extension cords as this can result in a risk of fire or electric shock.
- 17. OBJECT AND LIQUID ENTRY** - Never push objects of any kind into this apparatus through openings as they may touch dangerous voltage points or short out parts that could result in a fire or electric shock. Never spill liquid of any kind on the apparatus.
- 18. SERVICING** - Do not attempt to service this apparatus yourself as opening or removing covers may expose you to dangerous voltage or other hazards. Refer all servicing to qualified service personnel.
- 19. DAMAGE REQUIRING SERVICE** - Unplug this apparatus from the wall outlet and refer servicing to qualified service personnel under the following conditions:
 - When the power supply cord or plug is damaged or frayed.
 - If liquid has been spilled, or objects have fallen into the apparatus.
 - If the apparatus has been exposed to rain or water.
 - If the apparatus does not operate normally by following the operating instructions. Adjust only those controls that are covered by the operating instructions, as improper adjustment of other controls may result in damage and will often require extensive work by a qualified technician to restore the apparatus to its normal operation.
 - If the apparatus has been dropped or damaged in any way.
 - If the apparatus exhibits a distinct change in performance, this indicates a need for service.
- 20. REPLACEMENT PARTS** - When replacement parts are required, be sure the service technician uses replacement parts specified by the manufacturer that have the same characteristics as the original part. Unauthorized substitutions may result in fire, electric shock, injury to persons or other hazards.
- 21. SAFETY CHECK** - Upon completion of any service or repairs to this apparatus, ask the service technician to perform routine safety checks to determine that the apparatus is in proper operating condition.
- 22. HEAT** - This apparatus should be situated away from heat sources such as radiators, heat registers, stoves, or other products (including amplifiers) that produce heat.

PRECAUTIONS

Do not place the unit on the furniture that is capable of being tilted by a child and an adult leaning, pulling, standing or climbing on it. A falling unit can cause serious injury or even death.

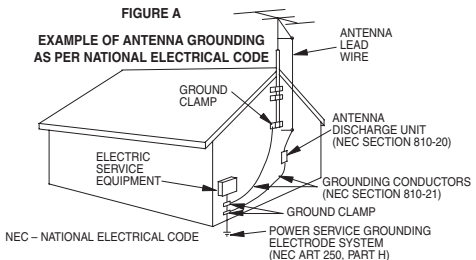
CAUTION: To prevent electric shock, match wide blade of plug to wide slot, fully insert.

FCC WARNING

This apparatus may generate or use radio frequency energy. Changes or modifications to this apparatus may cause harmful interference unless the modifications are expressly approved in the manual. The user could lose the authority to operate this apparatus if an unauthorized change or modification is made.

RADIO-TV INTERFERENCE

This apparatus has been tested and found to comply with the limits for a Class B digital device, pursuant to Part 15 of the FCC Rules. These limits are designed to provide reasonable protection against harmful interference in a residential installation. This apparatus generates, uses, and can radiate radio frequency energy and, if not installed and used in accordance with the instructions, may cause harmful interference to radio communications. However, there is no guarantee that interference will not occur in a particular installation. If this apparatus does cause harmful interference to radio or television reception, which can be determined by turning the apparatus off and on, the user is encouraged to try to correct the interference by one or more of the following measures:

- 1) Reorient or relocate the receiving antenna.
- 2) Increase the separation between the apparatus and receiver.
- 3) Connect the apparatus into an outlet on a circuit different from that to which the receiver is connected.
- 4) Consult the dealer or an experienced radio/TV technician for help.

This Class B digital apparatus complies with Canadian ICES-003.

NOTE TO CATV SYSTEM INSTALLER

This reminder is provided to call the CATV system installer's attention to Article 820-40 of the NEC that provides guidelines for proper grounding and, in particular, specifies that the cable ground should be connected to the grounding system of the building as close to the point of cable entry as practical.

LASER SAFETY

This apparatus employs a laser. Only a qualified service person should remove the cover or attempt to service this apparatus, due to possible eye injury.

CAUTION: Use of controls or adjustments or performance of procedures other than those specified herein may result in hazardous radiation exposure.

CAUTION: Visible and invisible laser radiation when open and interlock defeated. Do not stare into beam.

LOCATION: Inside, near the deck mechanism.

ABOUT COPYRIGHT

Unauthorized copying, broadcasting, public performance and lending of discs are prohibited. This product incorporates copyright protection technology that is protected by U.S. patents and other intellectual property rights. Use of this copyright protection technology must be authorized by Macrovision, and is intended for home and other limited viewing uses only unless otherwise authorized by Macrovision. Reverse engineering or disassembly is prohibited.

PRECAUTIONS

Supplied Accessories

remote control with batteries (AAx2) (NB812UD) RCA audio / video cables (WPZ0102TM015 / WPZ0102LTE01) AC cord (WAV0162LW001)



owner's manual (EN/ES/FR) (1VMN25073 / 1VMN25075 / 1VMN25293) quick start guide (EN/ES/FR) (1VMN25074 / 1VMN25076)



To Avoid the Hazards of Electrical Shock and Fire

- Do not handle the power cord with wet hands.
- Do not pull on the power cord when disconnecting it from an AC outlet. Grasp it by the plug.
- Do not put your fingers or objects into the unit.

Installation Location

For safety and optimum performance of this unit:

- Install the unit in a horizontal and stable position. Do not place anything directly on top of the unit. Do not place the unit directly on top of the TV.
- Shield it from direct sunlight and keep it away from devices of intense heat. Avoid dusty or humid places. Avoid places with insufficient ventilation for proper heat dissipation. Do not block the ventilation holes on the back and sides of the unit. Avoid locations subject to strong vibration or strong magnetic fields.
- Be sure to remove the disc and unplug the AC power cord from the outlet before carrying the unit.

Moisture Condensation Warning

Moisture condensation may occur inside the unit when it is moved from a cold place to a warm place or after heating a cold room or under conditions of high humidity. Do not use this unit at least for 2 hours until its inside gets dry.

Note about Recycling

- This unit's packaging materials are recyclable and can be reused. Please dispose of any materials in accordance with your local recycling regulations.
- Batteries should never be thrown away or incinerated but disposed of in accordance with your local regulations concerning chemical wastes.



Maintenance

Servicing

- Please refer to relevant topics on "TROUBLESHOOTING" on page 43 before returning the product.
- If this unit becomes inoperative, do not try to correct the problem by yourself. There are no user-serviceable parts inside. Turn off, unplug the power plug, and please call our toll free customer support line found on the cover of this manual to locate an authorized service center.

Cleaning the cabinet

- Wipe the front panel and other exterior surfaces of the unit with a soft, slightly damp cloth.
- Never use a solvent, thinner, benzene or alcohol to clean the unit. Do not spray insecticide liquid near the unit. Such chemicals may discolor the surface or damage the unit.

Cleaning discs

- When a disc becomes dirty, clean it with a cleaning cloth. Wipe the disc from the center to out. Do not wipe in a circular motion.
- Do not use solvents such as benzene, thinner, commercially available cleaners, detergent, abrasive cleaning agents or antistatic spray intended for analog records.

Cleaning the disc lens

- If this unit still does not perform properly although you refer to the relevant sections and to "TROUBLESHOOTING" in this user manual, the laser optical pickup unit may be dirty. Consult your dealer or an authorized service center for inspection and cleaning of the laser optical pickup unit.

Disc handling

- Handle the discs so that fingerprints and dust do not adhere to the surfaces of the discs.
- Always store the disc in its protective case when it is not used.
- Note that discs with special shapes (heart-shaped discs, octagonal discs, etc.) cannot be played back on this unit. Do not attempt to playback such discs, as they may damage the unit.

IR signal check

- If the remote control is not working properly, you can use an AM radio or digital camera (including a cellular phone with built-in camera) to see if it is sending out an infrared signal.
- **With an AM radio:** Tune the AM radio station to a non-broadcasting frequency. Point the remote control towards it, push any button and listen. If the sound from the radio flutters, it is receiving the remote control's infrared signal.



- **With a digital camera (including built-in cell phone cameras):** Point a digital camera towards the remote control. Push any button on the remote control and look through the digital camera. If the infrared light appears through the camera, the remote control is working.



PRECAUTIONS

Trademark Information



HDMI, the HDMI logo and High-Definition Multimedia Interface are trademarks or registered trademarks of HDMI Licensing LLC.



Manufactured under license from Dolby Laboratories. Dolby and the double-D symbol are trademarks of Dolby Laboratories.



Manufactured under license under U.S. Patent #'s: 5,451,942; 5,956,674; 5,974,380; 5,978,762; 6,487,535 & other U.S. and worldwide patents issued & pending. DTS and DTS Digital Surround are registered trademarks and the DTS logos and Symbol are trademarks of DTS, Inc. © 1996-2007 DTS, Inc. All Rights Reserved.

"Blu-ray Disc" and  are trademarks.

 is a trademark of DVD Format/Logo Licensing Corporation.



Java and all other Java trademarks and logos are trademarks or registered trademarks of Sun Microsystems, Inc. in the United States and / or other countries.



Product that have earned ENERGY STAR® are designed to protect the environment through superior energy efficiency.



is trademark of Eastman Kodak Company.

© 2008 Funai Electric Co., Ltd.

All rights reserved. No part of this manual may be reproduced, copied, transmitted, disseminated, transcribed, downloaded or stored in any storage medium, in any form or for any purpose without the express prior written consent of Funai. Furthermore, any unauthorized commercial distribution of this manual or any revision hereto is strictly prohibited.

Information in this document is subject to change without notice. Funai reserves the right to change the content herein without the obligation to notify any person or organization of such changes.

FUNAI with the  design is a registered trademark of Funai Electric Co., Ltd and may not be used in any way without the express written consent of Funai. All other trademarks used herein remain the exclusive property of their respective owners. Nothing contained in this manual should be construed as granting, by implication or otherwise, any license or right to use any of the trademarks displayed herein. Misuse of any trademarks or any other content in this manual is strictly prohibited. Funai shall aggressively enforce its intellectual property rights to the fullest extent of the law.

CONTENTS

Introduction

PRECAUTIONS	2
FEATURES	7
Features	7
Symbols Used in this Manual	7
FUNCTIONAL OVERVIEW	8
Front Panel	8
Rear Panel	8
Remote Control	9
Front Panel Display	11

Connections

CONNECTIONS	12
Connection to the TV	12
Connection to an Audio System	15
Connecting the AC Cord	16

Playback

INFORMATION ON PLAYBACK	17
BASIC PLAYBACK	20
Playback	20
Operations Using Title Menu, Disc Menu, and Pop-up Menu	21
Pause	21
Resume Playback	21
Playing Back an audio CD and a Disc with JPEG Files	22
Reading the SD Memory Card	23
SPECIAL PLAYBACK	25
Fast Forward / Fast Reverse	25
Slow Forward Playback	25
Step by Step Playback	25
Repeat Playback	25
A-B Repeat	26
PIP (Picture in Picture) Setting	26
Program Playback	26
Random Playback	27
Camera Angle	27
SEARCH	28
SPECIAL SETTINGS	29
Switching Subtitles	29
Switching Audio Soundtrack	29
Setting the BD Audio Mode	30
Adjusting the Picture	30

Function Setup

FUNCTION SETUP	31
Using the Setup Menu	31

Others

TROUBLESHOOTING	43
GLOSSARY	44
LANGUAGE CODE	45
SPECIFICATIONS	46
LIMITED WARRANTY	Back Cover

FEATURES

Features

Full high-definition video playback

Watch movies in the highest picture quality available for your HDTV. This unit offers full high-definition video playback up to 1080p resolution for an amazing viewing experience. A highly detailed picture and increased sharpness delivers a more true-to-life picture.

Upconvert DVD for enhanced picture quality

Your current DVD will look even better than before thanks to video upconversion. Upconversion will increase the resolution of standard definition DVD to high definition up to 1080p over an HDMI connection. The picture will be less jagged and more realistic for a near high-definition experience.

Enjoy your content on different kinds of media

Full backwards compatibility with DVD, CD ensures that you can continue to enjoy your current audio-video collection. Additionally, you can view JPEG.

Listen to the rich multi-channel surround sound

Multi-channel surround sound, which realizes real-to-life sound and makes you feel that you are really there.

Easy and simple connection to your HDTV via HDMI

Connect this unit to your HDTV with one single HDMI (high definition multimedia interface) cable. It is recommended to use High Speed HDMI Cable for better compatibility. The high definition video output signal will be transferred to your HDTV without conversion to analogue signals, so you will get an excellent picture and sound quality, completely free from noise.

Thanks to other multiple outputs, you can also easily connect to your home theater system or amplifier.

PIP

Some BD-video have the PIP (picture-in-picture) function which enables you to display the secondary video in the primary video. You can call up the secondary video by pressing **[PIP]** whenever the scene contains the secondary video.

Pop-up menu

Some BD-video have pop-up menu which is a navigation menu that can be called up and be operated on the TV screen without interrupting the playback. You can call up the pop-up menu by pressing **[POP MENU / MENU]**. Contents in the pop-up menu vary depending on the disc.

HDMI Deep Color

Deep Color reduces the posterization effect of the playback image. Refer to "HDMI Deep Color" in "FUNCTION SETUP" on page 34.

HDMI 1080p / fps output (BD only)

This unit is equipped with the feature which can provide the smooth movement in the playback of film originated material with the frame rate of 24 frames per second with progressive. (Available only when the TV is connected by an HDMI cable and compatible with 1080p24 frame input.)





Refer to "HDMI Video Resolution" in "FUNCTION SETUP" on page 34.

Playing back the contents in SD Memory Card

You can play back JPEG stored in an SD Memory Card. You can store picture-in-picture commentary, subtitles or other extras for BD-ROM Profile 1 ver.1.1 files in an SD Memory Card and play back with the BD-video.

Symbols Used in this Manual

To specify for which media type each function is, we put the following symbols at the beginning of each item to operate.

Symbol	Description
	Description refers to BD-video and BD-RE (ver. 2.1) / BD-R recorded in BDMV format
	Description refers to DVD-video
	Description refers to audio CD / DTS-CD
	Description refers to DVD, CD-RW/-R and SD Memory Card with JPEG files

If you do not find any of the symbols listed above under the function heading, the operation is applicable to all media.

FUNCTIONAL OVERVIEW

Front Panel

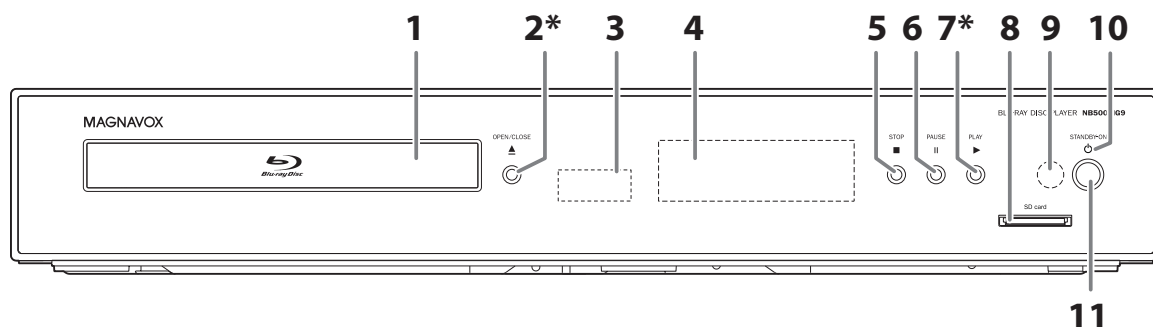

* The unit can also be turned on by pressing these buttons.

1. **Disc tray**
 - Place a disc when opening the disc tray.
2. **▲ OPEN/CLOSE button***
 - Press to open or close the disc tray.
3. **Disc indicator**
 - This indicator lights up in blue when a disc is in this unit.
4. **Display**
 - Refer to "Front Panel Display" on page 11.
5. **■ STOP button**
 - Press to stop playback.
6. **■ PAUSE button**
 - Press to pause playback.
7. **▶ PLAY button***
 - Press to start or resume playback.
8. **SD card slot**
 - Insert an SD Memory Card, and play back the contents in it.
9. **Infrared sensor window**
 - Receive signals from your remote control so that you can control the unit from a distance.
10. **STANDBY-ON indicator**
 - This indicator lights up in red when the power is on and turns off when the power is off.
11. **○ STANDBY-ON button**
 - Press to turn the unit on or off.

Rear Panel

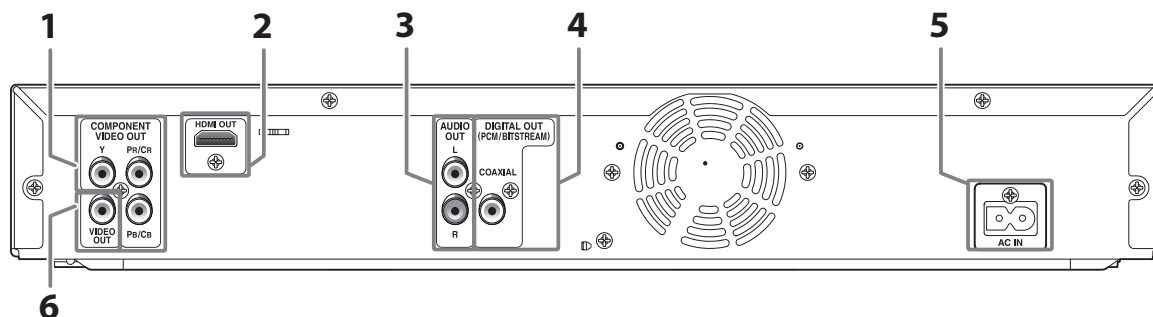

1. **COMPONENT VIDEO OUT jacks**
 - Use to connect a TV with component video inputs with an RCA component video cable.
2. **HDMI OUT jack**
 - Use to connect a TV with an HDMI compatible port with an HDMI cable.
3. **AUDIO OUT jacks**
 - Use to connect a TV, an AV receiver / amplifier or other device with an RCA audio cable.
4. **DIGITAL OUT (COAXIAL) jack**
 - Use to connect an AV receiver / amplifier, Dolby Digital / DTS decoder or other device with a digital audio coaxial input jack with a digital audio coaxial cable.
5. **AC IN Terminal**
 - Use to connect the AC outlet with the AC cord.
6. **VIDEO OUT jack**
 - Use to connect a TV, an AV receiver or other device with an RCA video cable.

Note

- Do not touch the inner pins of the jacks on the rear panel. Electrostatic discharge may cause permanent damage to the unit.
- This unit does not have the RF modulator.

Remote Control

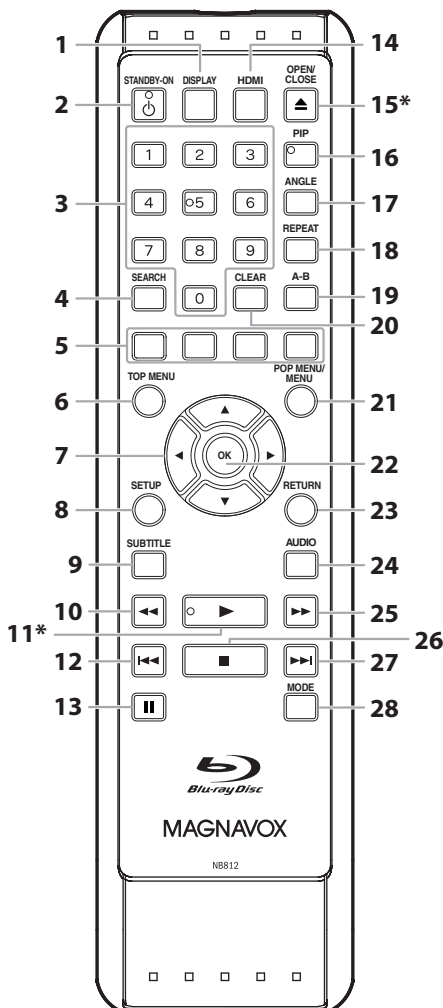

* The unit can also be turned on by pressing these buttons.

- 1. DISPLAY button**
 - Press to display the on-screen display menu.
- 2. STANDBY-ON button**
 - Press to turn the unit on or off.
- 3. Number buttons**
 - Press to enter the title, chapter, track or file number.
 - Press to enter values in the input field.
- 4. SEARCH button**
 - Press to display the search menu.
- 5. Red / Green / Blue / Yellow button**
 - Press to select items on some BD menus.
- 6. TOP MENU button**
 - Press to display the top menu.
- 7. Cursor buttons**
 - Press to select items or settings.
- 8. SETUP button**
 - Press to display the setup menu.
- 9. SUBTITLE button**
 - Press to display the subtitle menu.
- 10. REV button**
 - During playback, press to fast reverse the playback.

- 11. PLAY button***
 - Press to start playback or resume playback.
- 12. SKIP button**
 - During playback, press once to return to the beginning of the current title, chapter or track.
 - During the JPEG playback, press to return to the previous file.
 - During playback, press twice to return to the previous title, chapter or track.
- 13. PAUSE button**
 - Press to pause playback.
 - When playback is in pause mode, press repeatedly to forward the playback step by step.
- 14. HDMI button**
 - Press to set the HDMI output mode.
- 15. OPEN/CLOSE button***
 - Press to open or close the disc tray.
- 16. PIP button**
 - Press to switch picture-in-picture feature on or off (only applicable to BD-video which supports the PIP function).
- 17. ANGLE button**
 - Press to access various camera angles on the disc.
 - Press to rotate the JPEG files.
- 18. REPEAT button**
 - Press to toggle between various repeat modes.
- 19. A-B button**
 - Press to play back a defined section between point A and B repeatedly.
- 20. CLEAR button**
 - Press to clear the information once entered, to clear the marker settings, or to cancel the programming for audio CD, etc.
- 21. POP MENU/MENU button**
 - Press to display the pop-up menu / disc menu.
- 22. OK button**
 - Press to confirm or select menu items.
- 23. RETURN button**
 - Press to return to the previously displayed menu screen.
- 24. AUDIO button**
 - Press to display the audio menu.
- 25. FWD button**
 - During playback, press to fast forward the playback.
 - In pause mode, press to slow forward the playback.
- 26. STOP button**
 - Press to stop playback.
- 27. SKIP button**
 - During playback, press to skip to the next title, chapter, track or file.
- 28. MODE button**
 - During playback, press to display the picture adjustment menu.
 - During the JPEG playback, press to display menus for changing the visual effect for switching the image or changing the size of the image.
 - In stop mode with BD inserted, press to display a menu for setting the BD audio mode.
 - In stop mode with audio CD, or JPEG files inserted, press to display menus for program and random playback.

FUNCTIONAL OVERVIEW

Installing the Batteries in the Remote Control

Install the batteries (AAx2) matching the polarity indicated inside battery compartment of the remote control.

1 Open the cover.

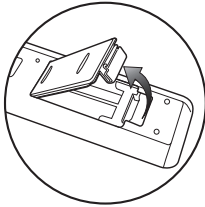

2 Insert batteries.

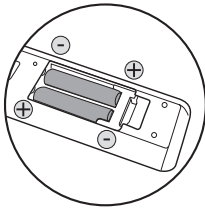

Make sure to match + and - on the batteries to the marks indicated in the battery compartment.

3 Close the cover.

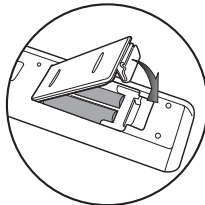

Note

Incorrect use of batteries can result in hazards such as leakage and bursting. Please observe the following:

- Do not mix new and old batteries together.
- Do not use different kinds of batteries together. Although they may look similar, different batteries may have different voltages.
- Make sure that the + and - ends of each battery match the indications in the battery compartment.
- Remove batteries from battery compartment that is not going to be used for a month or more.
- When disposing of used batteries, please comply with governmental regulations or environmental public instruction's rules that apply in your country or area.
- Do not recharge, short-circuit, heat, burn or disassemble batteries.

Using a Remote Control

Keep in mind the following when using the remote control:

- Make sure that there are no obstacles between the remote control and the infrared sensor window on the unit.
- Remote operation may become unreliable if strong sunlight or fluorescent light is shining on the infrared sensor window of the unit.
- Remote control for different devices can interfere with each other. Avoid using remote control for other device located close to the unit.
- Replace the batteries when you notice a fall off in the operating range of the remote control.
- The maximum operable ranges from the unit are as follows.
 - **Line of sight:** approx. 23 feet (7m)
 - **Either side of the center:** approx. 16 feet (5m) within 30°
 - **Above:** approx. 16 feet (5m) within 15°
 - **Below:** approx. 10 feet (3m) within 30°

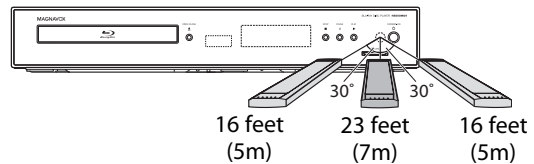

FUNCTIONAL OVERVIEW

Front Panel Display

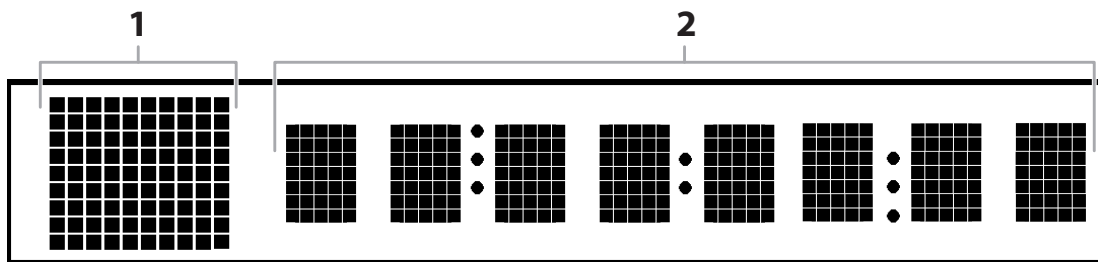

• Brightness of the display can be adjusted. Refer to “Panel Display” in “FUNCTION SETUP” on page 41.

1. Displays playback status icon. Refer to the table below.
2. Displays various kinds of information such as title number, elapsed time, repeat mode, etc.

Playback status icon		Mode
Disc	SD Memory Card	
		Playback is in progress
		Stop mode
		Pause mode
	—	Fast forward mode
	—	Fast reverse mode
	—	Slow forward mode
		Appears while repeat function is set

Example of Display Message



Title is being played back.
Indicating the current title number and the elapsed time.



Current chapter is in chapter repeat mode.



Loading a disc.

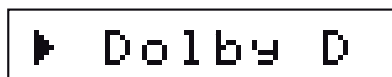

Dolby Digital audio is being played back.

CONNECTIONS

Connection to the TV

- Make one of the following connections, depending on the capabilities of your existing device.

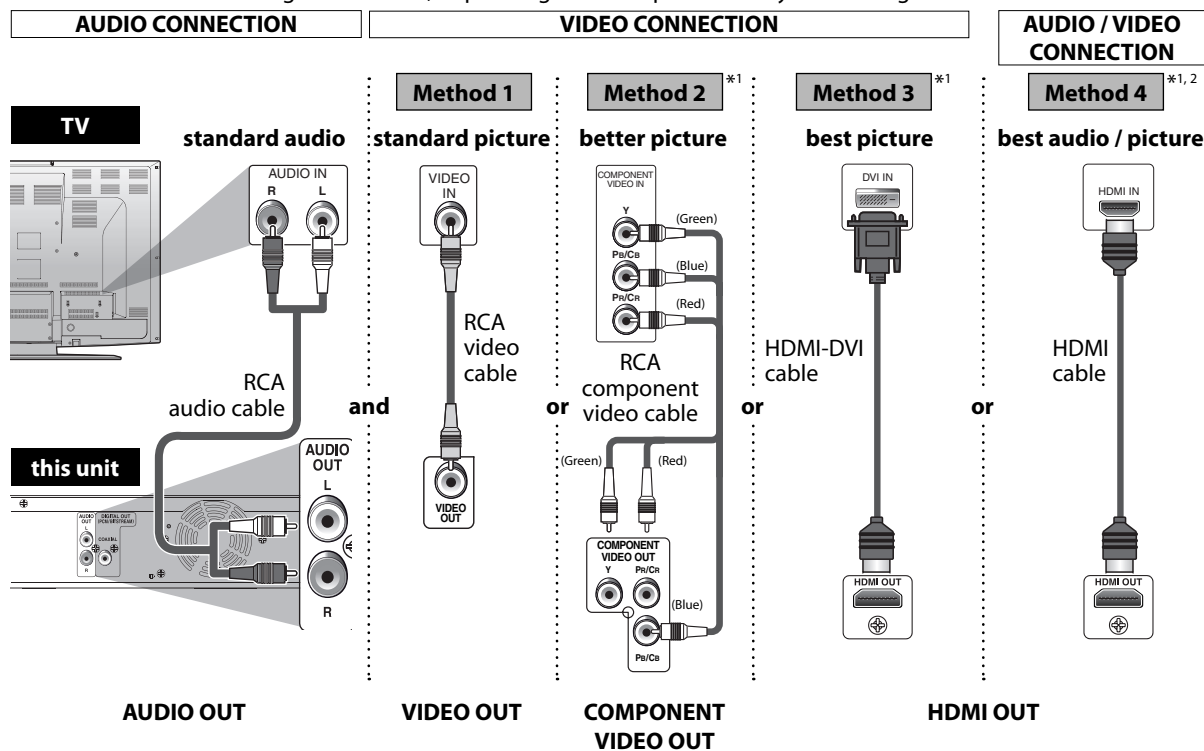

*1 This unit is compatible with the progressive scan system. The feature provides you with the higher quality pictures than traditional output system does. To utilize this feature, a component or an HDMI connection is required. Refer to "HDMI Video Resolution" or "Component Output" setting on page 34 to set the video resolution.

*2 Analog audio connection is not required for this connection.

Supplied cables used in this connection are as follows:

- RCA audio cable (L/R) x 1
- RCA video cable x 1

Please purchase the rest of the necessary cables at your local store.

Note

- Connect this unit directly to the TV. If the RCA audio / video cables are connected to a VCR, pictures may be distorted due to the copy-protection system.
- If the picture is not output properly to the TV because of "HDMI Video Resolution" or "Component Output" setting, press and hold [▶ PLAY] on the front panel for more than 5 seconds. "HDMI Video Resolution" and "Component Output" setting will be reset to the default automatically.
- A simple 1-cable connection with a device having an HDMI (high-definition multimedia interface) jack allows digital transfer of both digital video signals and multi-channel audio signals.

HDMI Output Mode and Actual Output Signals

Press **[HDMI]** to change the resolution of the video signal being output from HDMI OUT jack. The video resolution changes as follows every time **[HDMI]** is pressed.

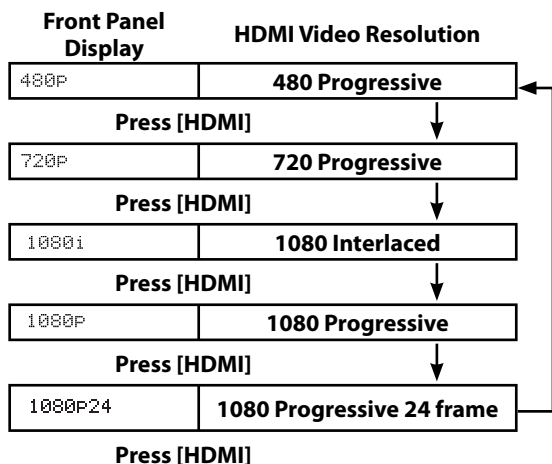

Copyright protection system

To play back the digital video images of a BD / DVD via an HDMI connection, it is necessary that both the unit and the TV (or an AV amplifier) support a copyright protection system called HDCP (high-bandwidth digital content protection system). HDCP is copy protection technology that comprises data encryption and authentication of the connected AV device. This unit supports HDCP. Please read the operating instructions of your TV (or AV amplifier) for more information.

Note

- When using HDCP-incompatible TV, the image will not be viewed properly.
- Among the devices that support HDMI, some devices can control other devices via the HDMI jack, this unit cannot be controlled by another device via the HDMI jack.
- The audio signals from HDMI OUT jack (including the sampling frequency, the number of channels and bit length) maybe limited by the device that is connected.
- Among the devices that support HDMI, some do not support audio output (e.g, projectors). In connections with device such as this unit, audio signals are not output from HDMI OUT jack.
- You cannot select the video resolutions which are not supported by the connected TV, except when this unit's HDMI OUT jack is connected to a DVI compatible display devices with an HDMI-DVI cable.
- For HDMI OUT jack to DVI connection, after you select an HDMI output mode, corresponding HDMI video resolution will be output. The HDMI video resolution you selected will be output even if the connected TV is not compatible with the HDMI video resolution. If there is no image displayed on the connected TV, please select another HDMI video resolution.
- Video and audio signals may be distorted temporarily when switching to / from the HDMI output mode.
- You can also change the HDMI output mode from "HDMI Video Resolution" setting in "Video" menu. In this menu, you can confirm what HDMI video resolutions are supported by connected TV. Refer to page 34.
- In order to get natural and high quality film reproduction of 24-frame film material, use an HDMI cable (High Speed HDMI Cable is recommended) and select "1080p24" if the connected TV is compatible with 1080p24 frame input.
- Even if you set "HDMI Video Resolution" setting to "1080p24", when the contents of the disc is not compatible for 1080p24 frame, 1080p60 frame will be output.
- There is no output from VIDEO OUT and COMPONENT VIDEO OUT jacks when you play back a BD that recorded 24-frame film material by HDMI output mode of 1080p24.
- COMPONENT VIDEO OUT jacks may not output any signals when you set "HDMI Deep Color" setting to "Auto".
- It is recommended to use High Speed HDMI Cable (also known as HDMI category 2 cable) for better compatibility.

CONNECTIONS

HDMI Audio Setting

When using HDMI connections make “HDMI Audio Out” setting in “Audio” menu according to the specifications of the device to be connected.

Device to be connected	“HDMI Audio Out” setting	Output HDMI audio signal
Device compatible with Dolby Digital, Dolby Digital Plus, Dolby TrueHD, DTS or DTS-HD decoding	HDMI Multi (Normal)	Dolby Digital, Dolby Digital Plus, Dolby TrueHD, DTS, or DTS-HD bitstream are output from HDMI OUT jack. Make the speaker settings on the connected AV amplifier, etc.
Device compatible with 3 or more channels of audio inputs (not Dolby Digital, Dolby Digital Plus, Dolby TrueHD, DTS or DTS-HD compatible)	HDMI Multi (LPCM)	Multi-channel audio signals are output from HDMI OUT jack. Make the speaker settings with the speaker setting items appear after you select “HDMI Multi(LPCM)”. Refer to page 36.
HDMI connection to a TV, and digital audio connection (coaxial) to an AV amplifier.	Audio Mute	HDMI audio will be muted, and Dolby Digital / DTS bitstream or LPCM will be output from DIGITAL OUT jack depending on “Digital Out” setting. Refer to page 37.

■ Audio signals output from HDMI OUT jack

Disc type	Audio recording format	“HDMI Audio Out” setting	
		HDMI Multi(Normal)	HDMI Multi(LPCM)
BD-video	Dolby Digital	Dolby Digital* ¹	Multi LPCM
	Dolby Digital Plus	Dolby Digital Plus* ¹	Multi LPCM* ²
	Dolby TrueHD	Dolby TrueHD* ¹	Multi LPCM* ³
	DTS	DTS* ¹	Multi LPCM
	DTS-HD	DTS-HD* ¹	Multi LPCM* ⁴
	LPCM	Multi LPCM	Multi LPCM
DVD-video	Dolby Digital	Dolby Digital	Multi LPCM
	DTS	DTS	Multi LPCM
	LPCM	Multi LPCM	Multi LPCM
audio CD		2ch LPCM	2ch LPCM
DTS-CD		DTS	Multi LPCM

*¹ If “BD Audio Mode” setting is set to “Mix Audio Output”, audio will be output as multi LPCM. Refer to page 36.

*² Outputs audio signals decoded from independent substream.

*³ Outputs audio signals decoded from Dolby Digital stream.

*⁴ Outputs audio signals decoded from DTS core stream.

• If the connected device is not compatible with the HDMI BITSTREAM, audio will be output as multi LPCM or 2-channel down-mixed LPCM depending on the capability of the connected device even if you select “HDMI Multi(Normal)” in “HDMI Audio Out” setting. Refer to page 36.

CONNECTIONS

Connection to an Audio System

- When you change the connections, all devices should be turned off.
- Refer to the manual accompanying external devices for more information.

2-Channel Analog Audio Connection

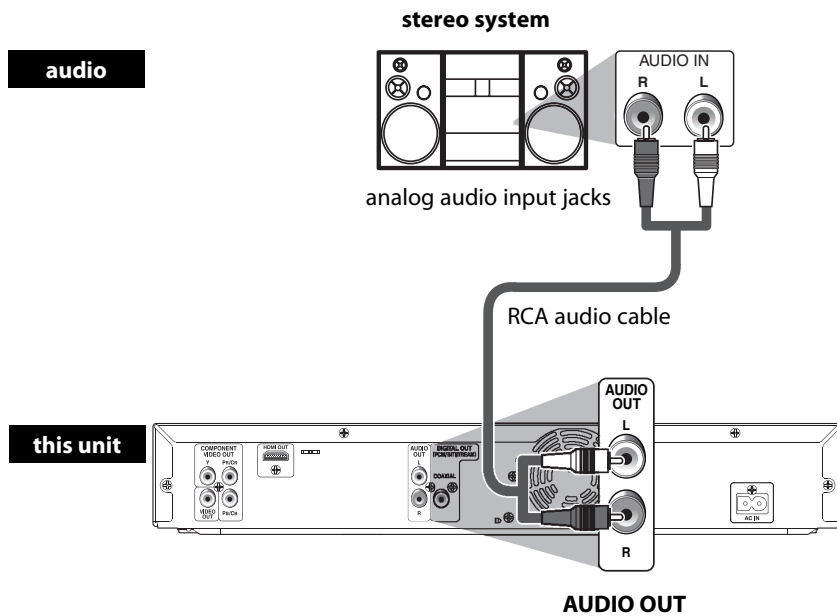

Digital Audio Connection

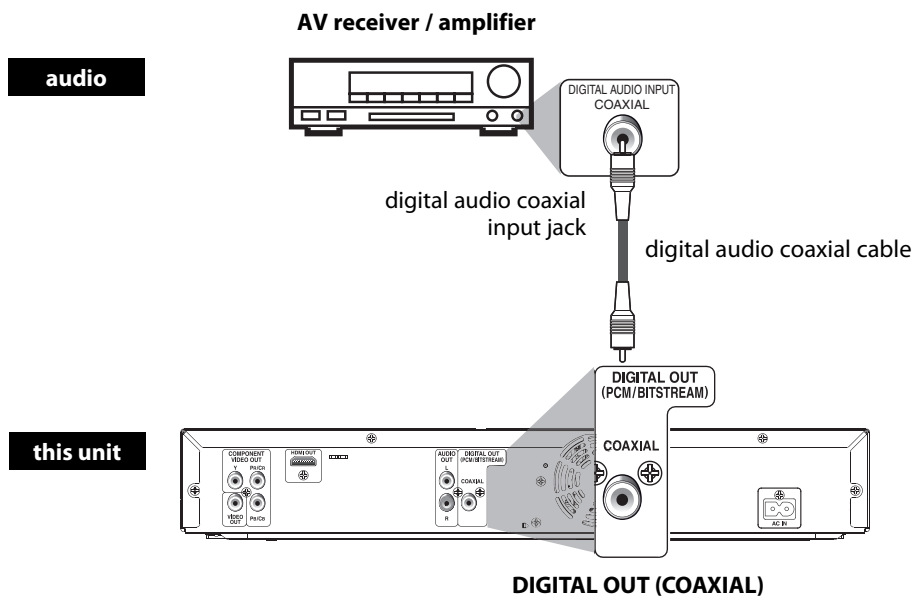

Supplied cables used in this connection are as follows:

- RCA audio cable (L/R) x 1

Please purchase the rest of the necessary cables at your local store.

CONNECTIONS

■ Audio signals output from DIGITAL OUT jack (COAXIAL)

The audio signals currently output from HDMI OUT jack will be output from DIGITAL OUT jack as well, except that Dolby Digital signal will be output instead of Dolby Digital Plus and Dolby TrueHD, and DTS signal will be output instead of DTS-HD.

When "Audio Mute" is selected in "HDMI Audio Out" setting, audio signals output from HDMI OUT jack will be muted and the audio signals output from DIGITAL OUT jack changes depending on "Digital Out" setting.

To set "Digital Out" setting, select "Audio Mute" in "HDMI Audio Out" setting.

Disc type	Audio recording format	"Digital Out" setting	
		Bitstream	LPCM
BD-video	Dolby Digital	Dolby Digital	2ch Downmix LPCM
	Dolby Digital Plus	Dolby Digital	2ch Downmix LPCM
	Dolby TrueHD	Dolby Digital	2ch Downmix LPCM
	DTS	DTS*	2ch Downmix LPCM
	DTS-HD	DTS*	2ch Downmix LPCM
	LPCM	2ch Downmix LPCM*	2ch Downmix LPCM
DVD-video	Dolby Digital	Dolby Digital	2ch Downmix LPCM
	DTS	DTS	2ch Downmix LPCM
	LPCM	2ch Downmix LPCM	2ch Downmix LPCM
audio CD		2ch LPCM	2ch LPCM
DTS-CD		DTS	2ch Downmix LPCM

* For BD titles with secondary or interactive audio, these audio will be output as Dolby Digital when all the conditions listed below are met:

- When "BD Audio Mode" setting is set to "Mix Audio Output".
- When "HDMI Audio Out" setting is set to "Audio Mute".
- When "Digital Out" setting is set to "Bitstream".

If BD titles do not have secondary or interactive audio, the audio will be output as shown in the table.

• This table applies only when HDMI cable is not connected or "Audio Mute" is selected in "HDMI Audio Out" setting.

Note

- In order to output LPCM signal from DIGITAL OUT jack while outputting the HDMI audio signal, set "BD Audio Mode" setting to "Mix Audio Output" and set "HDMI Audio Out" setting to "HDMI Multi(LPCM)".

Connecting the AC Cord

After you made all necessary connections, connect the AC cord to the AC IN. Then connect the AC cord to the AC outlet.

Insert the plugs securely. Incomplete connections will result in the generation of noise.

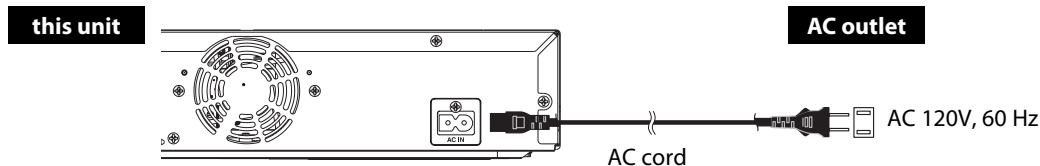

Supplied cables used in this connection are as follows:

- AC cord x 1











INFORMATION ON PLAYBACK

Before you start playing back a disc, read the following information.

Playable Discs and Files

This unit is compatible to play back the following discs / files.

To play back a disc / file, make sure that it meets the requirements for region codes and color systems as described below. You can play back discs that have the following logos. Other disc types are not guaranteed to play back.

Playable discs	Logos
Blu-ray Disc - BD-video (single / double layer) - BD-RE ver.2.1 (single / double layer) (Recorded in BDMV format) - BD-R (single / double layer) (Recorded in BDMV format) (Unclosed discs may not be played back.)	
DVD-video	
DVD+RW (single layer)	
DVD+R (single / double layer)	 
CD-DA (audio CD)	
CD-RW	 
CD-R	 
Kodak Picture CD	
DTS-CD	

Playable files	Media
JPEG	DVD, CD-RW/-R, SD Memory Card (including SDHC), miniSD Card, microSD Card

Readable cards	Playable files / data
SD Memory Card (8MB - 2GB)	
SDHC Memory Card (4GB)	JPEG, picture-in-picture commentary, subtitles or other extras for BD-ROM
miniSD Card (8MB - 2GB)	Profile 1 ver.1.1
microSD Card (8MB - 2GB)	

Note for SD Memory Cards

- Do not remove the SD Memory Card or turn off the unit while the contents of the card is in playback. It may result in malfunction or loss of the card's data.
- Please keep the SD Memory Cards in their cases when you are not using them.
- Do not try to open or modify the card.
- Do not touch the terminal surface with your fingers or any metals.
- Do not attach additional labels or stickers to cards.
- Do not remove the label of the SD Memory Cards.
- This unit supports SD Memory Card with FAT12/ FAT16 file system, and SDHC Memory Card with FAT32 file system.
- This unit may not read the SD Memory Cards formatted on computer. If that is the case, please reformat the SD Memory Cards in this unit and try again.
- This unit does not supports miniSDHC and microSDHC Memory Card.
- For miniSD Card and microSD Card, the adapter is necessary.

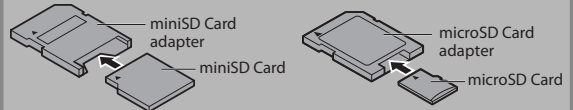

- Portions of this product are protected under copyright law and are provided under license by ARIS / SOLANA / 4C.

Unplayable Discs and Files

The following discs will not be played back in this unit.

- CD-ROM
- CD-I (compact disc-interactive)
- DVD-RAM
- VSD (video single disc)
- DVD-audio
- BD-RE (ver.1 / ver.3)
- HD DVD
- video CD
- unfinalized disc
- SVCD
- BD-RE/-R recorded in BDAV format
- DVD / CD / SD Memory Card contains MP3, Windows Media™ Audio files and DivX®
- DVD-RW/-R recorded in VR mode or non compatible recording format.
- super audio CD - Only the sound on the CD layer can be heard. The sound on the high-density super audio CD layer cannot be heard.
- Playability of dual discs are not guaranteed.

INFORMATION ON PLAYBACK

Color Systems

BD-video and DVD-video are recorded in different color systems throughout the world. The most common color system is NTSC (which is used primarily in the United States and Canada).

This unit employs NTSC color system, so the disc you play back must be recorded in the NTSC system. You cannot play back the disc recorded in other color systems.

Region Codes

This unit has been designed to play back BD-video with region A and DVD-video with region "1" or "ALL". You cannot play back BD-video or DVD-video that are labeled for other regions. Look for the symbols on the right on your BD-video or DVD-video.

If these region symbols do not appear on your BD-video or DVD-video, you cannot play back the disc in this unit. The letter or number inside the globe refers to region of the world. A BD-video or DVD-video labeled for a specific region can only be played back in the unit with the same region code.

BD-video



DVD-video



Structure of Disc / SD Memory Card Contents

The contents of BD-video / DVD-video are generally divided into titles. Titles may be further subdivided into chapters.

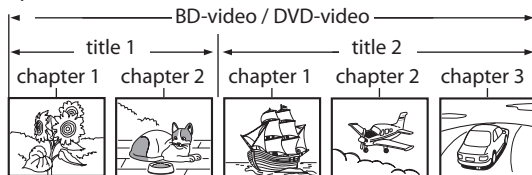

audio CD are divided into tracks.

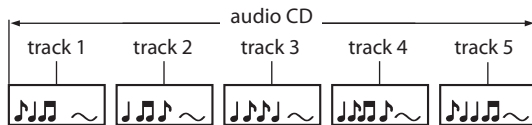

Data discs or SD Memory Cards contain JPEG are divided into folders, and the folders are subdivided into files.

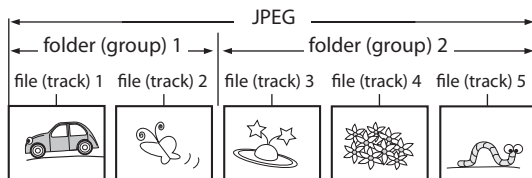

On-Screen Display

You can check information about the current disc by pressing **[DISPLAY]**.

To call the on-screen display menu, press **[DISPLAY]** during playback. Every time you press **[DISPLAY]**, the information changes. Depending on the media, available information varies.



off → Title / Chapter information
 → Title information (elapsed time)
 → Title information (remaining time)
 → HDMI information → off



off → Chapter information (elapsed time)
 → Chapter information (remaining time)
 → Title information (elapsed time)
 → Title information (remaining time)
 → Bit rate information → HDMI information → off



off → Track information (elapsed time)
 → Track information (remaining time)
 → Disc information* (elapsed time)
 → Disc information* (remaining time)
 → HDMI information → off
 (*not available during program / random playback)

JPEG

off → File name information
 → File information → HDMI information → off

- For audio CD and JPEG, during program or random playback, the indication will be displayed after the track / file information.

INFORMATION ON PLAYBACK

Chapter information



<Title / Chapter information for BD>



- 1 Current chapter number / Total number of chapters
- 2 Elapsed time / Remaining time of the current chapter
- 3 Indicates that the multi camera angle images are available on the scene
- 4 Current playback status
- 5 Current title number
- 6 Current repeat setting (Only when repeat setting is active)
(C: Chapter repeat, T: Title repeat, AB : A-B repeat)

Title information



- 1 Current title number / Total number of titles
- 2 Elapsed time / Remaining time of the current title

Bit rate information



- 1 Bit rate (The amount of video data currently being read)
- 2 Layer number (Only for 2-layered discs)
(L0: Layer 0 is played back. L1: Layer 1 is played back)

Track / File information



- 1 Current track (file) number / Total number of track (file)
- 2 Elapsed time / Remaining time of the current track
- 3 Indication of SD Memory Card playback
- 4 Current repeat setting
(Only when repeat setting is active)
(T: Track / File repeat, G: Group repeat, A: All repeat, AB: A-B repeat)

Disc information



- 1 Current track number / Total number of tracks
- 2 Elapsed time / Remaining time of the current disc

File name information



- 1 Media icon and file name
: JPEG file

HDMI information

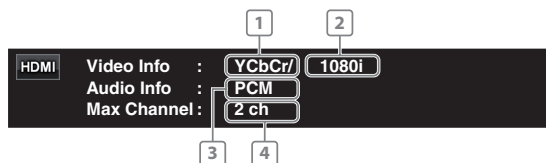

- 1 HDMI video format
- 2 Resolution of the HDMI output image
- 3 HDMI audio format
- 4 Maximum numbers of audio channels that can be accepted by the connected device



Note

- If the HDMI cable is not connected, “---” will be displayed for HDMI information.

BASIC PLAYBACK

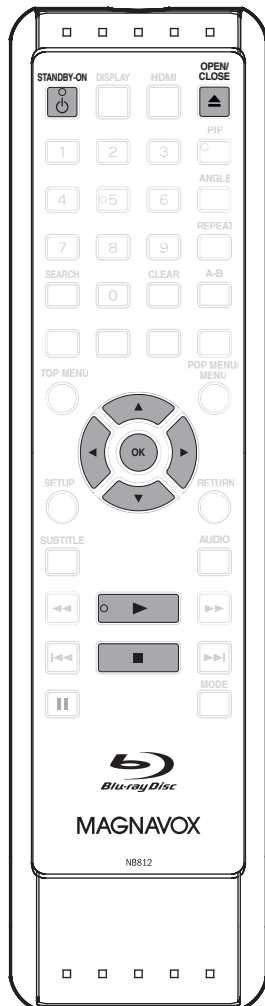



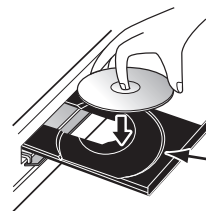

Playback



- 1 Press [STANDBY-ON ].
- 2 Turn on the TV and select the appropriate input on the TV to which the unit is connected.
- 3 Press [OPEN / CLOSE ] to open the disc tray.
- 4 Place the disc on the disc tray with its label side facing up.



Align the disc to the disc tray guide.

- 5 Press [OPEN / CLOSE ] to close the disc tray.
It may take a while to load the disc.
Some discs may start playback automatically.
- 6 Press [PLAY ] to start playback.
For many of BD-video and DVD-video, a menu screen may appear.
In this case, use [ /  /  / ] to select the desired item, then press [OK].
- 7 Press [STOP ] once to stop playback temporarily.
Refer to "Resume Playback" on page 21.

To eject the disc:

Press [OPEN / CLOSE ] to open the disc tray, then remove the disc before turning off the unit.

Note

-  may appear at the top-right on the TV screen when the operation is prohibited by the disc or this unit.
- During the playback of 2-layered disc, pictures may stop for a moment. This happens when the 1st layer switches to the 2nd layer. This is not a malfunction.
- The operation may vary when you play back BD-video and DVD-video with disc menu. Refer to the manual accompanying the disc for details.

BASIC PLAYBACK

Operations Using Title Menu, Disc Menu, and Pop-up Menu



Many of BD-video and DVD-video disc contains title menu (BD-video / DVD-video), disc menu (DVD-video) or pop-up menu (BD-video) which guides you through the available functions in the disc. The contents of the menus may differ depending on the discs.

Title menu (BD-video / DVD-video)

- 1 Press [TOP MENU].
 - The title menu will appear.
- 2 Use [▲ / ▼ / ◀ / ▶] to select an item, then press [OK].
- 3 Press [TOP MENU] to exit.

Disc menu (DVD-video)

- 1 Press [POP MENU / MENU].
 - The disc menu will appear.
- 2 Use [▲ / ▼ / ◀ / ▶] to select an item, then press [OK].
- 3 Press [POP MENU / MENU] to exit.

Pop-up menu (BD-video)

• This is a special feature available for some BD-video. When you press [POP MENU / MENU], a menu pops out on the TV screen while the contents still play back.

- 1 During the playback of BD-video, press [POP MENU / MENU].
 - The pop-up menu will appear.
- 2 Use [▲ / ▼ / ◀ / ▶] to select an item, then press [OK].
- 3 Press [POP MENU/MENU] to exit.

Note

- Contents of menus and corresponding menu operations may vary among discs. Refer to the manual accompanying the disc for details.

Pause

- 1 During playback, press [PAUSE II].
 - Playback will be paused.



- 2 Press [PLAY ▶] to return to normal playback.

Note

- For BD and DVD, set "Still Mode" setting to "Field" in "Video" menu if pictures in the pause mode are blurred (refer to page 35).

Resume Playback

- 1 During playback, press [STOP ■].
 - Resume message will appear on the TV screen.

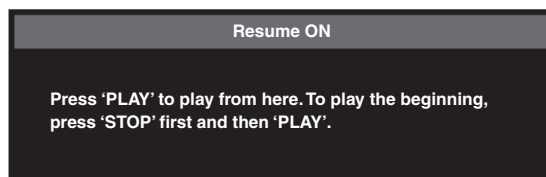

e.g.) BD

- 2 Press [PLAY ▶].
 - In a few seconds, playback will resume from the point at which it stopped last. To cancel the resume playback and start playback the disc from the beginning, press [STOP ■] again in stop mode.

Note

- The resume information will be saved even when the power is turned off.
- If you open the disc tray or press [STOP ■] again in stop mode, the resume information will be cleared.
- If you switch between "Disc" mode and "SD Memory" mode, the resume information will be cleared.
- If you change "BD Rating Level" or "DVD Rating Level" setting in "Parental" menu, the resume information will be cleared.
- For SD Memory Card, if you open the disc tray or turned off the power, resume information will be cleared.

BASIC PLAYBACK

Playing Back an audio CD and a Disc with JPEG Files



1 Insert an audio CD or a disc with JPEG files.

- The file list will appear on the TV screen.
- If file list does not appear automatically, press [POP MENU / MENU].
- Press [POP MENU / MENU] to exit and resume the file list.

2 Use [▲ / ▼] to select a desired folder or file, then press [OK]. Use [◀ / ▶] to go back and forward between the hierarchies.

- If you press [OK] on the desired file, playback will start.

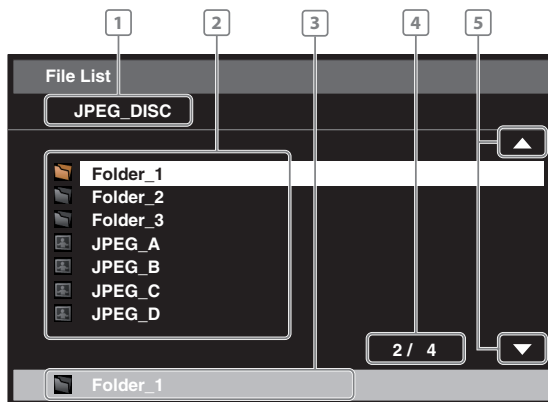

e.g.) JPEG

- 1 audio CD: "CD-DA" will be displayed.**
JPEG: Current folder name (Disc or SD Memory Card name will be displayed for the top of the hierarchies.)
- 2 audio CD: List of the track number and time.**
JPEG: List of the file / folder names in the current folder / disc
- 3 audio CD: Selected track number and time.**
JPEG: Selected file / folder name
- 4 Current page / Total page number**
- 5 Indication of previous / next page**
 - Use [SKIP |◀◀ / ▶▶] to go back and forward between the pages.
 - Press [TOP MENU] to return to the first item.

Icons:

: Folder

: audio CD track

: JPEG file

It is recommended that files to be played back in this unit are recorded under the following specifications:

<JPEG>

- Upper limit: 2,560 x 1,900 dots
(sub sampling is 4:4:4)
5,120 x 3,840 dots
(sub sampling is up to 4:2:2)
- Lower limit: 32 x 32 dots
- File size of image maximum: 12 MB

Note

- The system can recognize up to 255 folders / 999 files for CD, 999 folders / 9999 files for DVD and SD Memory Card.
- The name of folder and file can be displayed up to 28 characters. Unrecognizable characters will be replaced with asterisks.
- The 9th and deeper hierarchies cannot be displayed for CD and the 10th and deeper hierarchies cannot be displayed for DVD and SD Memory Card.
- Files whose extension is other than ".jpg / .jpeg(JPEG)" will not be listed.
- Some unplayable folders or files may be listed due to the recording status.
- High-resolution JPEG files take longer to be displayed.
- Progressive JPEG files (JPEG files saved in progressive format) cannot be played back in this unit.
- This unit recognize up to 8 characters of file name in the SD Memory Card. Characters after 9th will not be displayed.
- For the SD Memory Card playback, refer to "Reading the SD Memory Card" on pages 23-24.

BASIC PLAYBACK

Kodak Picture CD

JPEG

This unit can also run JPEG files stored on Kodak Picture CD. You can enjoy picture images on the TV set by playing back the Kodak Picture CD. This unit confirms to ver.7.0 of Kodak Picture CD. For details of Kodak Picture CD, contact a shop that provides developing service of Kodak Inc.

- 1 When Kodak Picture CD is inserted in this unit, Kodak Picture CD menu appear automatically on the TV screen.

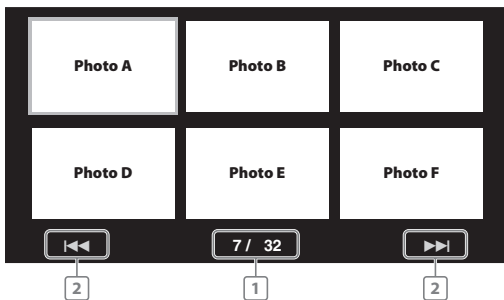

1. Current track number / The total number of tracks
2. Indication of previous / next page
 - In stop mode, press [POP MENU / MENU] to call Kodak Picture CD menu.

- 2 Use [▲ / ▼ / ◀ / ▶] to select a desired track to be played back, then press [PLAY ▶] or [OK].

- An image will be played back from the selected track and go to the next one in turn.
- Use [SKIP ◀◀ / ▶▶] to go back and forward between the pages.

- 3 Press [STOP ■] to stop playback.

Tips for JPEG / Kodak Picture CD Playback

- Every press on [ANGLE] will turn the image clockwise by 90 degrees when an image is displayed.
- To change the visual effect for switching the playback image, press [MODE] once, then use [◀ / ▶] or [OK] to switch between "Cut In/Out" and "Fade In/Out". The size change may have no effect on some files (e.g. files with a small picture size).
- During JPEG / Kodak Picture CD playback, press [MODE] twice to change the size of the playback image, then use [◀ / ▶] or [OK] to switch between "Normal" (100%) and "Small" (95%). The size change may have no effect on some files (e.g. files with a small picture size).

Reading the SD Memory Card

JPEG

You can play back the JPEG files in an SD Memory Card. With the SD Memory Card, you can also enjoy the special additional contents for BD-ROM Profile 1 ver.1.1 which can be downloaded from the internet. You can store the contents on an SD Memory Card via computer and play them back with the BD-video. For more information about the special additional contents, please refer to the instruction book that came with the disc.



■ Setting the media mode

- 1 In stop mode, press [SETUP].

- 2 Use [▲ / ▼] to select , then press [OK].

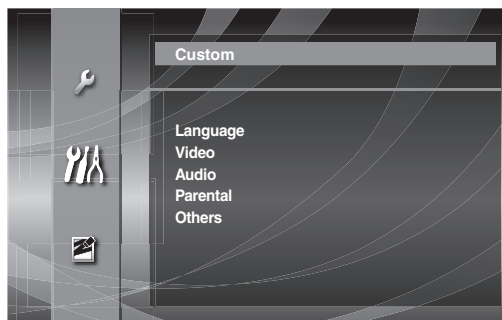

- 3 Use [▲ / ▼] to select , then press [OK].

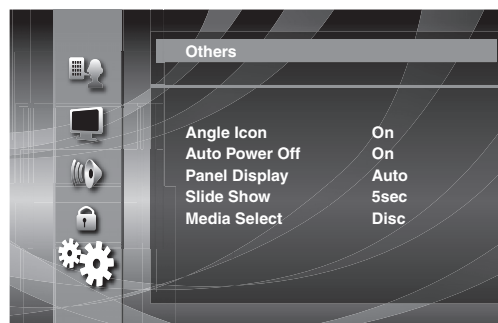

- 4 Use [▲ / ▼] to select "Media Select" setting.

5 Press [OK] repeatedly to select "SD Memory".

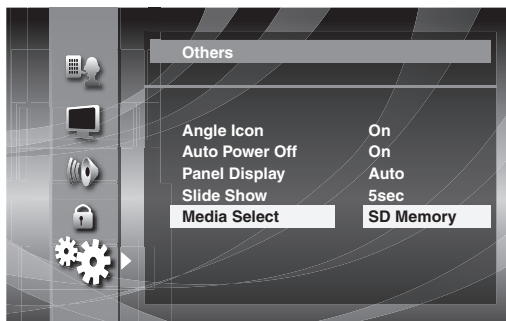

- This will set the unit to "SD Memory" mode. To play back the contents in any discs, exit "SD Memory" mode by selecting "Disc".

6 Press [SETUP] to exit.

Inserting the SD Memory Card and playback

1 Insert an SD Memory Card into the SD card slot until it clicks with the label facing up.

The file list will appear.

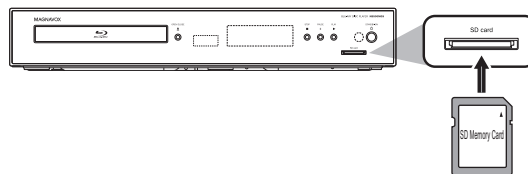

2 Follow the step 2 in "Playing Back an audio CD and a Disc with JPEG Files" on page 22.

Removing the SD Memory Card

1 In stop mode, push the SD Memory Card and then slowly remove your finger.

2 Grasp the card and pull it out from the SD card slot.

Compatible Cards:

- SD Memory Card (8MB - 2GB)
- SDHC Memory Card (4GB)
- miniSD Card (8MB - 2GB)
- microSD Card (8MB - 2GB)
- For miniSD Card and microSD Card, the adapter will be required.

Note

- Do not remove the card during its playback.
- This unit supports SD Memory Card with FAT12 / FAT16 file system, and SDHC Memory Card with FAT32 file system.
- Do not delete the folders or files in the SD Memory Card with your computer. This unit might not read the SD Memory Card.
- This unit recognize up to 8 characters of file name in the SD Memory Card. Characters after 9th will not be displayed.

SPECIAL PLAYBACK

Fast Forward / Fast Reverse



1 During playback, press [FWD ►►] repeatedly for fast forward.

During playback, press [REV ◀◀] repeatedly for fast reverse.

Every time you press [FWD ►►] or [REV ◀◀], the playback speed will change.

2 Press [PLAY ►] to return to normal playback.

Note

- For BD and DVD, the approximate speed for the fast forward or reverse playback is 1 (2x), 2(8x), 3 (20x), 4 (50x), and 5 (100x).
- For audio CD, the approximate speed is 1 (2x), 2 (8x), and 3 (30x).
- For audio CD, fast forward / fast reverse search between different tracks are not available during program and random playback.

Slow Forward Playback



1 During playback, press [PAUSE ||], then press [FWD ►►].

Every time you press [FWD ►►], playback speed will change.

2 Press [PLAY ►] to return to normal playback.

Note

- The approximate speed for the slow forward playback is 1(1/16x), 2(1/8x), 3(1/2x).
- Only slow forward is available.
- Set "Still Mode" setting to "Field" in "Video" menu if pictures in the slow forward playback mode are blurred (refer to page 35).

Step by Step Playback



1 In pause mode, press [PAUSE ||] repeatedly.

Every time you press [PAUSE ||], playback will advance one step at a time.

2 Press [PLAY ►] to return to normal playback.

Note

- Only step by step forward is available.
- Set "Still Mode" setting to "Field" in "Video" menu if pictures in step by step playback mode are blurred (refer to page 35).

Repeat Playback

Available repeat functions vary depending the discs.

1 During playback, press [REPEAT] repeatedly to select the desired repeat mode.

Repeat mode	Available media
Chapter repeat The current chapter will be played back repeatedly.	
Title repeat The current title will be played back repeatedly.	
Track repeat The current track or file will be played back repeatedly.	
Group repeat The current folder will be played back repeatedly.	
All repeat All tracks in the media will be played back repeatedly.	

Note

- The repeat setting will be canceled when you stop playback.
- The chapter, title, track or group repeat will be cleared when moving to other chapter, title, track / file or folder.
- Repeat playback does not function during A-B repeat playback.
- Chapter and title repeat are not available with some scenes.

SPECIAL PLAYBACK

A-B Repeat



You can play back the specific part (between point A and point B) repeatedly.

1 During playback, press [A-B] at the desired starting point A.

2 During playback, press [A-B] at the desired ending point B.

As soon as you set the point B, the part between point A and point B will start playback repeatedly.

- To cancel the A-B repeat, press [A-B] again.

Note

- Point B should be set within the same title or track as point A.
- A-B repeat is not available with some scenes.
- To cancel the A point which was set, press [CLEAR].
- A-B repeat does not function during chapter, title, track, group or all repeat playback.

PIP (Picture in Picture) Setting



Some BD-video have the PIP (picture-in-picture) function which enables you to display the secondary video in the primary video. You can call up the secondary video by pressing [PIP] whenever the scene contains the secondary video.

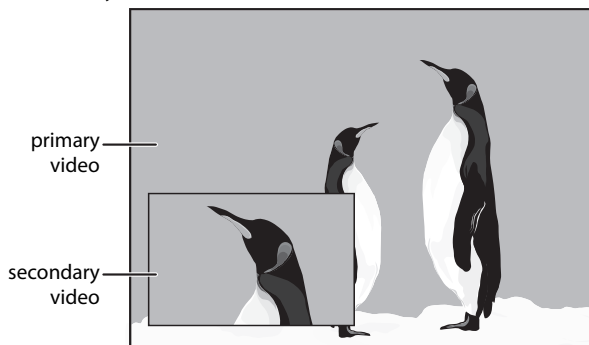

1 During playback, press [PIP].

PIP information will appear.

2 Use [▲ / ▼] to select the secondary video you want.

- The secondary video will be displayed and the secondary audio will be output.

3 Press [RETURN] or [PIP] to remove the PIP information.

Note

- The the secondary audio will not be output when the secondary audio is set to "Off" or when "BD Audio Mode" is set to "HD Audio Output". Refer to "Switching Audio Soundtrack" on page 29 and "Setting the BD Audio Mode" on page 30.

Program Playback



You can play back the disc in your desired order.

1 In stop mode, press [MODE].

- The program screen will appear.

2 Use [▲ / ▼] to select a track / file, then press [OK].

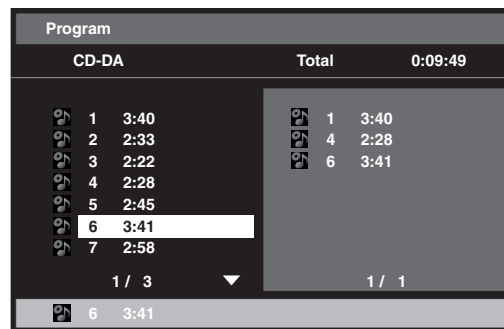

e.g.) audio CD

- For JPEG files, use [▲ / ▼] to select a folder, then press [OK] first, and then use [▲ / ▼] to select a file, then press [OK].
- Press [CLEAR] to erase the last file of the program.
- Use [▲ / ▼] to select "All Clear" at the bottom of the list to erase all the tracks / files in the program.
- The programmed tracks / files is displayed in the right hand screen.
- If the entire program cannot be displayed on the TV screen, "▼" or "▲" appears.
- Use [◀ / ▶] to go back forward between the hierarchy of folders.
- If 8 or more tracks / files were set in a program, use [SKIP ◀◀ / ▶▶] to see all the tracks / files.

3 Press [PLAY ▶] to start program playback.

- Program playback will start.

Note

- During program playback, press [STOP ■] once to set the resume point, and then press [PLAY ▶] to resume program playback from where [STOP ■] was pressed (audio CD) or from beginning of the file where [STOP ■] was pressed (JPEG).
- During program playback, press [STOP ■] twice to display the program screen. To go back to the normal program playback, press [RETURN] to exit from the program screen, then press [PLAY ▶].
- If you open the disc tray, remove the SD Memory Card or turned off the power, the program will be cleared.
- Up to 99 tracks / files can be entered.
- To repeat the current track / file in the program, press [REPEAT] repeatedly until "⏮ Track" appears during play back. To repeat the entire program, press [REPEAT] repeatedly until "⏮ All" appears during playback.
- Playback from a desired track / file and random playback are not available during program playback.

SPECIAL PLAYBACK

Random Playback



This function shuffles the playback order of tracks / files.

1 In stop mode, press [MODE] twice.

- The random screen will appear.

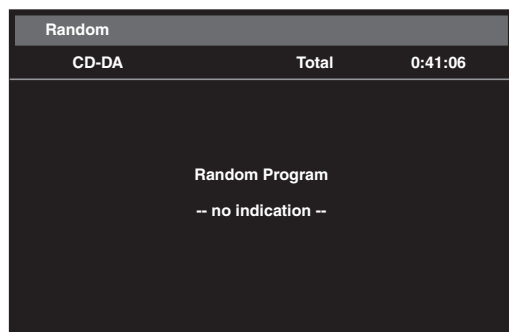

e.g.) audio CD

2 Press [PLAY ►] to start random playback.

Note

- During the random playback, press [STOP ■] once to set the resume point, and then press [PLAY ►] to resume random playback from where [STOP ■] was pressed (audio CD) or from beginning of the file where [STOP ■] was pressed (JPEG).
- During random playback, press [STOP ■] twice to display the random playback screen. To cancel the random playback, press [MODE] when the random playback screen is displayed.
- To repeat the current track / file in the random selection, press [REPEAT] repeatedly until "↶ Track" appears during playback. To repeat the entire random selection press [REPEAT] repeatedly until "↶ All" appears during playback.
- You cannot go back to the previous track / file during random playback.

Camera Angle



Some BD-video and DVD-video contain scenes which have been shot simultaneously from various angles. You can change the camera angle when  appears on the TV screen.

1 During playback, press [ANGLE].

- The selected angle will be displayed on the display bar at the top of the TV screen.

2 Use [▲ / ▼] to select your desired angle.



Note

- If "Angle Icon" setting is "Off" in "Others" menu,  will not appear. Refer to page 41.

SEARCH

Using [SKIP ◀◀ / ▶▶]

- 1 During playback, press [SKIP ▶▶] to move to the next track. Press it repeatedly to skip to subsequent tracks. Press [SKIP ◀◀] once to go back to the beginning of the current track. Press it repeatedly to go to the previous tracks.















- For JPEG files, press [SKIP ◀◀] to go back to the previous file.

Note

- For BD and DVD, if title contains no chapters, [SKIP ◀◀ / ▶▶] changes the title.
- For JPEG files, [◀ / ▶] is also available.

Using [SEARCH]

By using [SEARCH], you can select following search modes.

Search mode	Available media
 /  Chapter / Title search	 
 Track search	 
 Time search	  
 Marker search	  

- 1 During playback, press [SEARCH] repeatedly until your desired search mode appears.
- 2 Enter the desired chapter, title, track, file number or time to search for using [the Number buttons].
 - Chapter, title, track or time search will start.
 - Press [CLEAR] to erase an incorrect input.

Note

- During program and random playback, search functions are not available except the search using [SKIP ◀◀ / ▶▶].
- Time search is available only in the same track, file or title.
- For BD, chapter and time search are available only during playback.

■ Marker search

This feature allows you to assign a specific point on a title or track to be called back later.

- 1 During playback, press [SEARCH] repeatedly until the marker setting menu appears.
- 2 Use [◀ / ▶] to select a marker number (1-9).



- 3 When the disc reaches the point at which you want to set a marker, press [OK].
 - The title or track and elapsed playback time will appear on the TV screen.
- 4 Press [SEARCH] or [RETURN] to exit.
- 5 To return to the marker later, call the marker setting by pressing [SEARCH] repeatedly during playback or in stop mode, and use [◀ / ▶] to select a desired marker, then press [OK].

Note

- Opening the disc tray, turning off the power or selecting "AC" at step 2 and pressing [OK] will erase all markers.
- To clear a marker, use [◀ / ▶] to select the marker number to be cleared and press [CLEAR].
- You can mark up to 9 points.
- For BD, marker search between different titles is not available.
- For BD, you can return to the maker only during playback.

SPECIAL SETTINGS

You can select the format of audio and video as you prefer depending on the contents of the disc you are playing back.

Switching Subtitles

Some BD and DVD may have subtitles in 1 or more languages. For commercially available discs, the supported languages can be found on the disc case. Follow the steps below to switch the subtitle languages during playback.



1 During playback, press [SUBTITLE] repeatedly to display "Primary", "Secondary" or "Subtitle style".

"Primary": Sets the subtitle for the primary video.

"Secondary": Sets the subtitle for the secondary video.

"Subtitle Style": Sets style of the subtitle.

2 Use [▲ / ▼] to select your desired subtitle or style.



• Use [◀ / ▶] to switch between current subtitle setting and "Off".

3 Press [SUBTITLE] repeatedly to exit.



1 During playback, press [SUBTITLE].

2 Use [▲ / ▼] to select your desired subtitle.



• Use [◀ / ▶] to switch between current subtitle setting and "Off".

3 Press [SUBTITLE] to exit.

Note

- Some discs will only allow you to change the subtitles from the disc menu or pop-up menu. Press [TOP MENU] or [POP MENU / MENU] to display the disc menu or pop-up menu.
- If 4-digit-language code appears in the subtitle menu, refer to "LANGUAGE CODE" on page 45.
- If the disc has no subtitle language or subtitle style, "Not Available" will be displayed on the TV screen.
- During playback of the secondary video, the primary subtitle setting is not available except when there is no subtitle for the secondary video.
- Secondary subtitle setting is only available during playback of the secondary video.
- If you choose a language that has a 3-letter-language code, the code will be displayed every time you change the subtitle language setting. If you choose any other Languages, "----" will be displayed instead (refer to page 45).

Switching Audio Soundtrack

Some BD and DVD contain multiple audio streams. Those are often in different audio languages or audio formats. For BD, available audio varies depending on "BD Audio Mode" setting. Refer to page 36 for more information.



1 During playback, press [AUDIO] repeatedly to display "Primary" or "Secondary".

"Primary": Sets the audio for the primary video.

"Secondary": Sets the audio for the secondary video.

2 Use [▲ / ▼] to select your desired audio stream channel.



• For "Secondary", use [◀ / ▶] to switch between current audio setting and "Off".

3 Press [AUDIO] repeatedly to exit.



1 During playback, press [AUDIO].

2 Use [▲ / ▼] to select your desired audio stream channel.



e.g.) DVD-video

• For audio CD, you can select following options.

"Stereo": Both right and left channels are active (stereo).

"L-ch": Only left channel is active.

"R-ch": Only right channel is active.

3 Press [AUDIO] to exit.

Note

- The secondary audio will not be output when the secondary video is not displayed or when "BD Audio Mode" is set to "HD Audio Output". (For some BD, secondary audio will be output even when secondary video is off.)
- The sound mode cannot be changed during playback of discs not recorded in multiple audio.
- Some discs allow to change audio language setting on the disc menu. (Operation varies depending on the discs. Refer to the manual accompanying the disc.)
- [AUDIO] may not work on some discs with multiple audio streams or channels (e.g. DVD which allow to change audio setting on the disc menu).
- If you select a language that has a 3-letter-language code, the code will be displayed every time you change the audio language setting. If you select any other languages, "----" will be displayed instead (refer to page 45).
- If 4-digit-language code appears in the subtitle menu, refer to "LANGUAGE CODE" on page 45.
- If the disc has no audio language, "Not Available" will be displayed on the TV screen.
- For DTS-CD (5.1 music disc), selecting audio streams or channels is not available.

SPECIAL SETTINGS

Setting the BD Audio Mode



There are 2 ways to set "BD Audio Mode" setting; whether to output the secondary and interactive audio accompanied by the primary audio or only the primary audio. Depending on the setting of the mode, Dolby Digital, Dolby Digital Plus, Dolby TrueHD, DTS, or DTS-HD output changes between multi LPCM and bitstream.

- 1 In stop mode with BD inserted, press [MODE].
- 2 Use [▲ / ▼] to select your desired setting.



"Mix Audio Output":

If it is available, BD-video's secondary and interactive audio will be output with the primary audio.

- The secondary audio is the audio for the secondary video (Director's comment etc.) and the interactive audio is the audio for the interactive application (Button click sounds etc.).

"HD Audio Output":

Only the primary audio will be output. Set this mode in order to output Dolby Digital, Dolby Digital Plus, Dolby TrueHD, DTS or DTS-HD audio of BD through HDMI connection.

- 3 Press [RETURN] to exit.

- You can also set "BD Audio Mode" from the setup menu. Refer to page 36.

Note

- In "Mix Audio Output" mode, if there is no secondary and interactive audio, the audio will be output as "HD Audio Output" mode.
- In "Mix Audio Output" mode, even if you set "HDMI Multi(Normal)" in "HDMI Audio Out" setting, multi LPCM will be output from HDMI OUT jack for BD audio. Refer to page 14.
- In "Mix Audio Output" mode with HDMI audio being output, 2-channel down-mixed LPCM will be output from DIGITAL OUT jack for BD audio.
- In "Mix Audio Output" mode with "HDMI Audio Out" setting set to "Audio Mute" and "Digital Out" setting set to "Bitstream", DTS, DTS-HD and LPCM will be output as Dolby Digital for BD audio. Refer to pages 14, 16.
- You can also set "BD Audio Mode" setting from the setup menu. Refer to page 36.

Adjusting the Picture



You can adjust the picture quality.

- 1 During playback, press [MODE].
- 2 Use [▲ / ▼] to select your desired item, then use [◀ / ▶] to adjust the setting.



■ Black level

You can adjust the black level setting to make the black parts of the pictures as bright as you prefer. You can select "On" or "Off"

"On": Makes the dark parts brighter.

"Off": Shows the original picture as recorded.

■ Noise reduction

Reduces the noise of the playback picture.

"1": Executes MPEG noise reduction which reduces the block noise and mosquito noise on the subtitle on movie.

"2": Executes 3D noise reduction which detects and deletes the noise by comparing each picture frames.

"3": Executes both MPEG noise reduction and 3D noise reduction.

- 3 Press [RETURN] repeatedly to exit.

Note

- The setting remains even you turn off the unit.
- For the picture output from HDMI OUT, "Black Level" is not effective.
- For BD, noise reduction is not effective.

FUNCTION SETUP

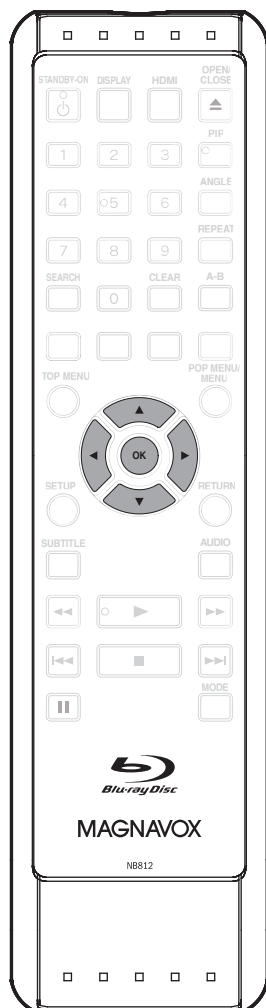

Using the Setup Menu

In the setup menu you can change the setting for audio, video, language, etc. You cannot change the setting during playback.

Quick

"Quick" menu contains setting items extracted from "Custom" menu which may be used frequently.

1 In stop mode, press [SETUP].

2 Use [▲ / ▼] to select , then press [OK].

3 Use [▲ / ▼] to select your desired setting items.

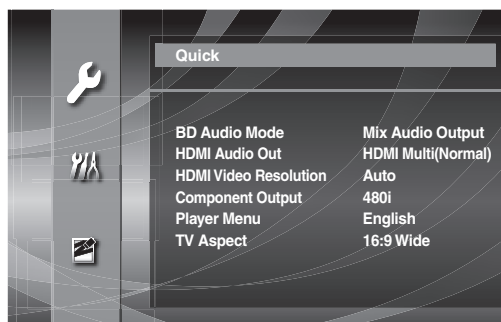

4 Follow the procedure below depending on the setting items.

A) If "▶" does not appear on the right side of the setting items when you highlight the items:

Press [OK] repeatedly to change options.

B) If "▶" appears on the right side of the setting items when you highlight the items:

1) Press [OK].

2) Use [▲ / ▼] to select options, then press [OK].

• Use [◀] or [RETURN] to go back to the previous screen.

5 Press [SETUP] to exit.

FUNCTION SETUP

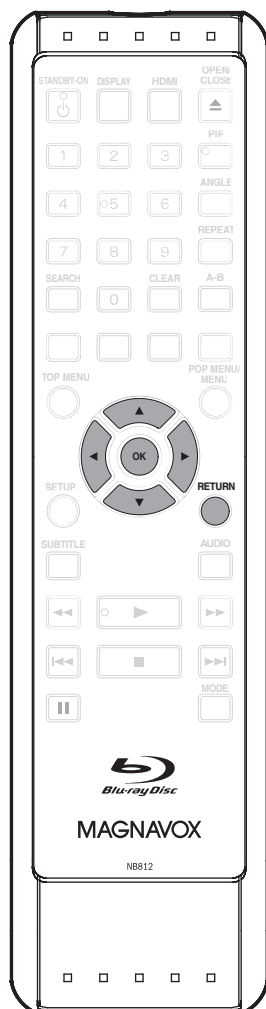

Custom

" Custom" menu contains all the setting items.

1 In stop mode, press [SETUP].

2 Use [▲ / ▼] to select , then press [OK].

3 Use [▲ / ▼] to select your desired setting category, then press [OK].

 : Language

 : Video

 : Audio

 : Parental

 : Others

- For " Parental" menu, follow the procedure on page 40.

4 Use [▲ / ▼] to select your desired setting items.

- The setting items which are not available with current situation of this unit will be displayed in gray and you cannot select them.

5 Follow the procedure below depending on the setting items.

A) If " " does not appear on the right side of the setting items when you highlight the items:

Press [OK] repeatedly to change options.

B) If " " appears on the right side of the setting items when you highlight the items:

1) Press [OK].

2) Use [▲ / ▼] to select options, then press [OK].

- Use [◀] or [RETURN] to go back to the previous screen.

6 Press [SETUP] to exit.

FUNCTION SETUP

■ Language



- For how to select the setting items and options, refer to “ Custom” on page 32.

Setting items	Options
Audio Sets the language for audio.	Original* / English / French / Spanish / German / Italian / Swedish / Dutch / Russian / Chinese / Japanese / Korean / Danish / Finnish / Norwegian / Icelandic / Hungarian / Romanian / Turkish / Greek / Irish / Portuguese / Polish / Czech / Slovak / Bulgarian / Other
Subtitle Sets the language for subtitle.	Off* / English / French / Spanish / German / Italian / Swedish / Dutch / Russian / Chinese / Japanese / Korean / Danish / Finnish / Norwegian / Icelandic / Hungarian / Romanian / Turkish / Greek / Irish / Portuguese / Polish / Czech / Slovak / Bulgarian / Other
Disc Menu Sets the language for disc menu or pop-up menu.	English* / French / Spanish / German / Italian / Swedish / Dutch / Russian / Chinese / Japanese / Korean / Danish / Finnish / Norwegian / Icelandic / Hungarian / Romanian / Turkish / Greek / Irish / Portuguese / Polish / Czech / Slovak / Bulgarian / Other
Player Menu Sets the language for OSD (on-screen display).	English* / Français / Español

- Settings with (*) are the default.
- “Quick” menu consists of the setting menus frequently used, and they are accompanied with .
- If you select “Other”, enter the 4-digit-number code for the desired language (Refer to “LANGUAGE CODE” on page 45). Only the languages supported by the disc can be selected.

FUNCTION SETUP

■ Video

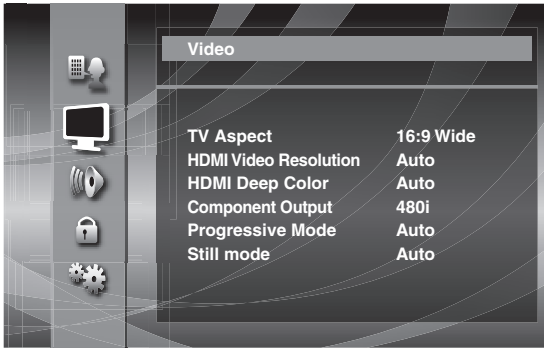

• For how to select the setting items and options, refer to “ Custom” on page 32.

Setting items	Options
TV Aspect <p>Sets the picture size according to aspect ratio of the connected TV.</p>	<p>16:9 Wide*: Select this when a wide-screen TV is connected. Discs recorded in wide-screen format is played back over the entire TV screen.</p> <p>4:3 Pan & Scan: Select this to play back the discs recorded in wide-screen format with 4:3 TV in the pan & scan mode (with the sides of the picture cut off). Discs which are not specified for pan & scan are played back in the letter box mode.</p> <p>4:3 Letter Box: Select this to play back the discs recorded in wide-screen format with 4:3 TV in the letter box mode. (with black strips at the top and bottom).</p> <p>16:9 Squeeze: When playing back 4:3 images, the picture is displayed in the center of the 16:9 screen with a 4:3 aspect ratio.</p>
HDMI Video Resolution <p>Sets the HDMI video resolution.</p>	<p>Auto*: HDMI video resolution will be selected automatically depending on the connected HDMI device.</p> <p>480p</p> <p>720p</p> <p>1080i</p> <p>1080p</p> <p>1080p24: Gives a natural and high quality film reproduction of 24-frame film material. The connected TV has to be compatible with 1080p24 frame input.</p>
HDMI Deep Color <p>Sets whether to output the picture from HDMI OUT jack with Deep Color or not.</p>	<p>Auto*: The picture from HDMI OUT jack will be output with Deep Color to the connected TV which supports HDMI Deep Color.</p> <p>Off: The picture from HDMI OUT jack will be output without Deep Color.</p>
Component Output <p>Sets the video resolution for component output.</p>	<p>480i*</p> <p>480p</p> <p>720p</p> <p>1080i</p>
Progressive Mode <p>Sets the optimum progressive mode for the image material output from HDMI OUT jack and COMPONENT VIDEO OUT jacks.</p>	<p>Auto*: Suited for playing back video material discs (TV shows or animation).</p> <p>Video: The progressive mode will detect 24-frame film material (movies) and automatically select appropriate progressive mode.</p>

FUNCTION SETUP

Setting items	Options
Still Mode Adjusts picture resolution and quality in still mode.	Auto*: Automatically selects the best resolution setting ("Frame" or "Field") based on the data characteristics of the pictures.
	Field: Stabilizes the pictures, although the picture quality may become coarse due to the limited amount of data. Select "Field" when the pictures are still unstable even if "Auto" is selected.
	Frame: Displays relatively motionless pictures in higher resolution. "Frame" improves the picture quality, although it may unstabilize the pictures due to alternate output of 2-field data.

- Settings with (*) are the default.
- "Quick" menu consists of the setting menus frequently used, and they are accompanied with .
- If you set "HDMI Video Resolution" setting to "1080p24" and the contents of the BD are not compatible for 1080p24 frame, 1080p60 frame will be output.
- An individual picture on the TV screen is called as "Frame", which consists of two separate images called as "Field". Some pictures may be blurred at the auto setting in "Still Mode" setting due to their data characteristics.
- If the picture is not output properly to the TV because of "HDMI Video Resolution" or "Component Output" setting, press and hold [▶ **PLAY**] on the front panel for more than 5 seconds. Both settings will be reset to the default automatically.
- If an HDMI cable is connected, for video resolution for the component output, you can only select video resolution that currently output from HDMI OUT jack or "480i".
- If the video resolution for the component output and HDMI video resolution do not match, the video resolution for the component output will be switched to "480i". COMPONENT VIDEO OUT jacks may not output any signals depending on the disc material.
- COMPONENT VIDEO OUT jacks may not output any signals when you set "HDMI Deep Color" setting to "Auto".
- If you play back copy-protected DVD-video, 480p signal will be output from COMPONENT VIDEO OUT jacks, when "Component Output" setting is set to "720p" or "1080i".

Introduction

Connections

Playback

Function Setup

Others

FUNCTION SETUP

■ Audio



• For how to select the setting items and options, refer to “ Custom” on page 32.

Setting items	Options
BD Audio Mode <p>For BD, selects whether to output the secondary and interactive audio with primary audio if it is available or only the primary audio. Refer to “Setting the BD Audio Mode” on page 30.</p>	Mix Audio Output*: Outputs the secondary and interactive audio with primary audio if it is available. HD Audio Output: Outputs only the primary audio. Set this mode in order to output Dolby Digital, Dolby Digital Plus, Dolby TrueHD, DTS or DTS-HD audio of BD through HDMI connection.
HDMI Audio Out <p>Sets the audio format for the audio output from HDMI OUT jack.</p>	HDMI Multi(Normal)*: The multi-channel audio signals are output from HDMI OUT jack with bitstream or LPCM. HDMI Multi(LPCM): The multi-channel audio signals are output from HDMI OUT jack with LPCM. • Refer to pages 37-39 for setting options. Audio Mute: Mutes the HDMI audio signal, and set the signal format from DIGITAL OUT jack. • Refer to “Digital out setting” on page 37 for setting options.
Down Sampling <p>Sets the digital audio output when playing back BD or DVD recorded in LPCM.</p>	On*: LPCM signals are converted to 48 kHz for output. • Set to “On” when using digital connections to an AV amplifier that is not compatible with sampling frequencies of 96 kHz. Off: For BD and DVD recorded in LPCM without copyright protection, 2-channel audio signals up to 192 kHz are output as LPCM signals with no conversion.
DRC <p>Sets whether to compress the range of sound volume (dynamic range control) when Dolby Digital, Dolby Digital Plus or Dolby TrueHD audio is played back.</p>	Auto*: When the discs recorded in Dolby TrueHD format are in playback, this unit detects DRC setting of the disc and set “DRC” setting to “On” or “Off” automatically. Off On
Virtual Surround <p>Sets to create a surround effect in a system with 2 speakers connected.</p>	Off*: Virtual surround is set to off. 1: A natural surround effect in a system with 2 speakers connected. 2: A stronger surround effect in a system with 2 speakers connected than “1”.

- Settings with (*) are the default.
- “Quick” menu consists of the setting menus frequently used, and they are accompanied with .
- Under following circumstances, “HDMI Multi(Normal)” and “HDMI Multi(LPCM)” are not available.
 - HDMI cable is not connected to HDMI OUT jack.
 - Connected TV is off.
 - Connected TV is not compatible with audio output.
- Set “Virtual Surround” setting to “Off” or lower the volume if the sound is distorted.
- For the virtual surround, audio signal will always be 2-channel LPCM.

FUNCTION SETUP

■ Digital out setting

When "Audio Mute" is selected in "HDMI Audio Out" setting, HDMI audio signal will be muted and the audio signals output from DIGITAL OUT jack changes depending on "Digital Out" setting.

Quick → HDMI Audio Out → Audio Mute → Digital Out

Bitstream*:

When playing back discs recorded in Dolby Digital, Dolby Digital Plus, Dolby TrueHD, DTS or DTS-HD, the corresponding core stream (Dolby Digital or DTS) are output.

LPCM:

LPCM signal will be output from DIGITAL OUT jack.

- This setting is not effective when the HDMI audio signal is output.

■ Speaker setting

This unit allows you to enjoy multi-channel surround sound such as 7.1-channel / 5.1-channel surround.

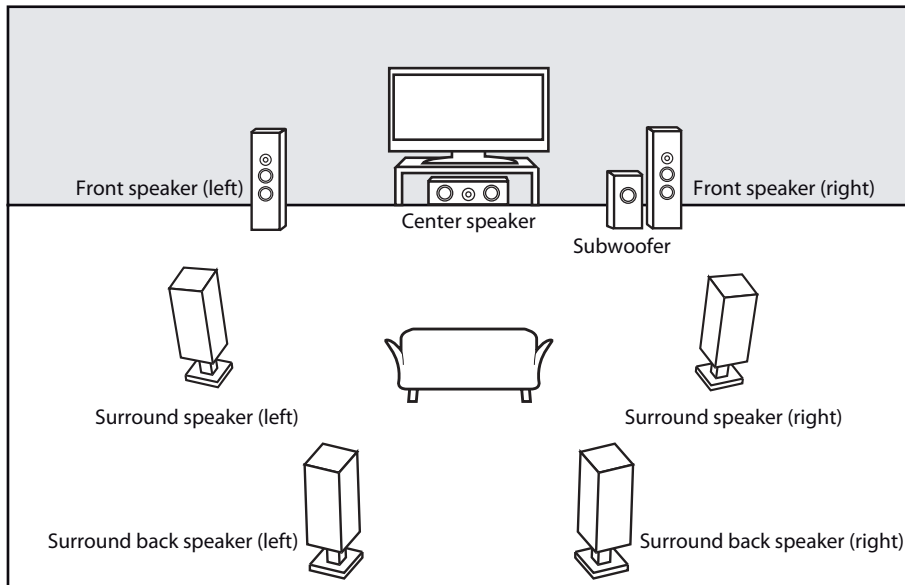

e.g.) basic layout with 7.1-channel surround system

To make the most of its feature, set up your speakers appropriately by referring to the following table.

Speaker setting options are available at the following locations;

<Speaker setting for the audio signal output from HDMI OUT jack>

(Available when you have HDMI cable connected to HDMI OUT jack)

Quick → HDMI Audio Out → HDMI Multi(LPCM)

Custom → Audio → HDMI Audio Out → HDMI Multi(LPCM)

FUNCTION SETUP

How to navigate through "HDMI Multi(LPCM)".

1 Use [▲ / ▼] to select your desired menu item then press [OK].

2 Use [▲ / ▼] to select your setting items.

- Press [RETURN] to go back to the previous screen.

3 Use [◀ / ▶] to select desired options. (Except for "Test Tone" and "Default").

For "Test Tone":

Use [◀ / ▶] to select "Off", "Manual" or "Auto", then press [OK].

- The test tone will be output. If you select "Manual", use [▲ / ▼] to select desired speaker, then use [◀ / ▶] to adjust the volume. If you select "Auto", use [◀ / ▶] to adjust the volume of the speaker that outputs the test tone.

- If you want to stop the test tone, press [RETURN].

For "Default":

Press [OK] to reset to the default.

4 Press [SETUP] to exit.

Menu	Setting items	Options	Descriptions
Speaker Size Selects the desired speaker to set. Then change the setting appropriately by referring to the descriptions.	Front	Large*	Large: For the large speakers with strong low frequency reproduction capabilities. Small: For the small speakers which do not provide strong bass sound. You cannot change the setting of "Subwoofer". If connected device is not compatible with subwoofer, "Subwoofer" will be displayed in gray.
		Small	
	Center	Large*	
		Small	
	Subwoofer	On	
	Surround	Large*	
		Small	
Surround Back	Large*		
	Small		
	Default		Select "Default", then press [OK] to reset "Speaker Size" setting to the default.
Channel Level Tests or sets the volume for each speakers.	Test Tone: "Test Tone" is the test tone which can be output from the speakers so that you can adjust the volume for each speaker.	Off*	Select "Off" to deactivate "Test Tone". Select "Manual", then press [OK] to manually set the volume for the desired speaker. Select "Auto", then press [OK] to automatically output the test tone from each speakers.
		Manual	
		Auto	
	Front Lch	0 dB to -12 dB (0 dB*)	If you have selected "Manual" in "Test Tone", select the desired speaker to set and adjust the volume for the selected speaker. If you select "Auto" in "Test Tone", test tone will automatically be output in order. Adjust the volume of the speaker that outputs the test tone.
	Center	0 dB to -12 dB (0 dB*)	
	Subwoofer	0 dB to -12 dB (0 dB*)	
	Front Rch	0 dB to -12 dB (0 dB*)	
	Surround Rch	0 dB to -12 dB (0 dB*)	
	Surround Back Rch	0 dB to -12 dB (0 dB*)	
	Surround Back Lch	0 dB to -12 dB (0 dB*)	
Surround Lch	0 dB to -12 dB (0 dB*)		
	Default		Select "Default", then press [OK] to reset "Channel Level" setting to the default.

FUNCTION SETUP

Menu	Setting items	Options	Descriptions
Delay Time This is a parameter for optimizing the timing at which the sound is output from the speakers according to their distance from the listening position.	Distance	Feet*	Set the desired measure system. This measure system will be used for "Delay Time" setting. Press [OK] to switch the settings.
		Meters	
	Front	0ft to 60ft (12ft*) (0m to 18m (3.6m*))	Select the distance from the listening position to the speaker to get the ideal delay time.
	Center	0ft to 60ft (12ft*) (0m to 18m (3.6m*))	
	Surround	0ft to 60ft (10ft*) (0m to 18m (3.0m*))	
	Surround Back	0ft to 60ft (10ft*) (0m to 18m (3.0m*))	
	Default		Select "Default", then press [OK] to reset "Delay Time" setting to the default.

- Settings with (*) are the default.
- For "Speaker Size" setting, the settings of each speaker sizes may be adjusted automatically corresponding to each setting. (e.g. If "Front" is set to "Small", you cannot set "Center", "Surround", and "Surround Back" to "Large".)
- For "Delay Time" setting, the difference among the value of the each speaker cannot exceed 15 ft (4.5m).

FUNCTION SETUP

■ Parental

Ratings control allows you to set a limit, which prevents your children from viewing inappropriate materials. Playback will be stopped if the ratings exceed the levels you set, and it will require you to enter a password before playing back the disc.

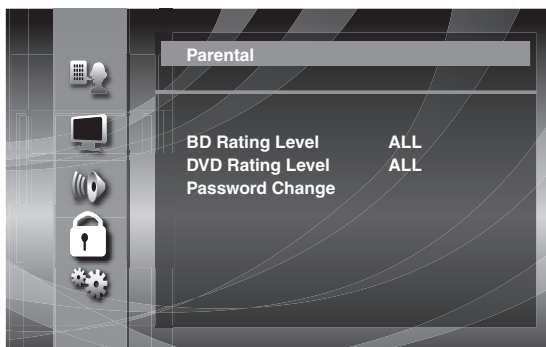

1 Use [**▲** / **▼**] to select , then press [**OK**].

2 Use [the **Number buttons**] to enter your 4-digit password.

For the first time use: Use [the **Number buttons**] enter any 4-digit number (except for 4737), then press [**OK**].

That number will be used as the password from the second time. Record your password in case you forget it.

- If you forget the password, enter [**4**], [**7**], [**3**], [**7**]. The password will be cleared and rating level will be set to "All".
- While you input the password, press [**CLEAR**] to clear the number, then re-enter the password.

3 Proceed to **A – C**

A) BD Rating Level

1) Use [**▲** / **▼**] to select "BD Rating Level", then press [**OK**].

2) Use [**▲** / **▼**] to select your desired option, then press [**OK**].

"All": To release the limitation.

"Age Setting": To set the age limitation.

- After selecting "Age Setting", use [the **Number buttons**] to enter the age from 0 – 254. (e.g. for age 15, press [**0**],[**1**],[**5**])

3) Press [**SETUP**] to exit.

B) DVD Rating Level

1) Use [**▲** / **▼**] to select "DVD Rating Level", then press [**OK**].

2) Use [**▲** / **▼**] to select your desired level, then press [**OK**].

3) Press [**SETUP**] to exit.

RATING EXPLANATIONS

- All : Parental control is inactive; all discs can be played back.
- 8 [Adult] : DVD software of any grades (adult/general/children) can be played back.
- 7 [NC-17] : No one under 17 admitted.
- 6 [R] : Restricted; under 17 requires accompanying parent or adult guardian.
- 5 [PGR] : Parental guidance recommended.
- 4 [PG-13] : Unsuitable for children under 13.
- 3 [PG] : Parental guidance suggested.
- 2 [G] : General audience.
- 1 [Kid Safe] : Suitable for children.

C) Password Change

1) Use [**▲** / **▼**] to select "Password Change", then press [**OK**].

2) Enter a new 4-digit password, then press [**OK**].

3) Press [**SETUP**] to exit.

Note

- The resume information will be cleared if you change the parental level when the resume information is on.

FUNCTION SETUP

■ ⚙️ Others

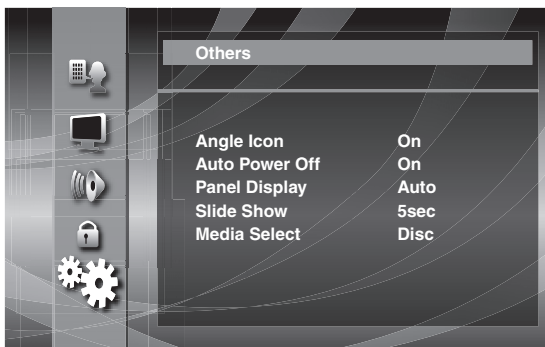

• For how to select the setting items and options, refer to “ Custom” on page 32.

Setting items	Options
Angle Icon	On*: The angle icon appears on the TV screen when playing back the scene with various angle.
	Off: The angle icon disappears on the TV screen.
Auto Power Off	On*: If this unit is left with no activity for more than 30 minutes, this unit turns off automatically.
	Off: Sets off the auto power off.
Panel Display Sets the brightness of the front panel display.	Auto*: Front panel display gets darker during playback.
	Bright: Front panel display gets brighter.
	Dimmer: Front panel display gets darker.
Slide Show Sets the display time for the still picture (in JPEG format) playback	5sec*
	10sec
Media Select Selects the media to playback.	Disc*: Select this when you play back a disc.
	SD Memory: Select this when you play back an SD Memory Card.

FUNCTION SETUP

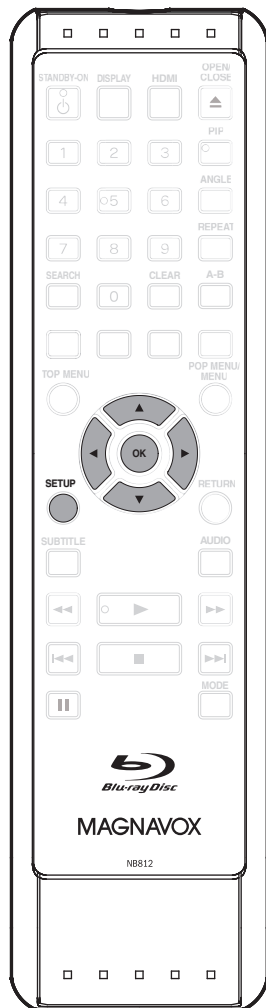

Initialize

Initialize the setting or SD Memory Card.

- 1** In stop mode, press [SETUP].
- 2** Use [▲ / ▼] to select , then press [OK].
- 3** Use [▲ / ▼] to select a desired option, then press [OK].
 - “No”: Exits without any initialization.
 - “Setup”: Resets the setup menu to the default.
 - “Memory Device”:
Initializes the SD Memory Card. After confirmation message appears, use [▲ / ▼] to select “Yes”, then press [OK].

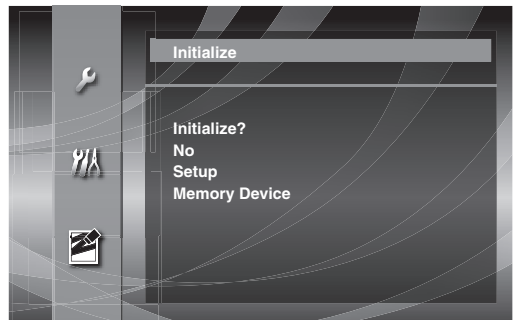

- 4** Press [OK]. (For “Setup” and “Memory Device” only)
- 5** Press [SETUP] to exit.

Note

- The setting for “ Parental” will not be reset.
- If SD Memory Card is not inserted, “Memory Device” will be displayed in gray.

TROUBLESHOOTING

If the unit does not perform properly when operated as instructed in this manual, check the unit, consulting the following checklist.

Problem	Solution
No power	<ul style="list-style-type: none"> - Check if the AC cord is properly connected. - Unplug the AC cord once, and wait for 5-10 seconds and then plug it in again.
No sound or picture	<ul style="list-style-type: none"> - Check if the connected TV is turned on. - Check if the connections are made securely and correctly. - Check whether the connected TV or other device supports HDCP. (This unit will not output a video signal unless the other device supports HDCP.) - Check whether the output format of this unit (HDMI FORMAT) matches the supported input format of other connected device. - Check if "HDMI Deep Color" setting is set to "Auto". If it is the case, set it to "Off". - Set "HDMI Video Resolution" setting other than "Auto" or "1080p24".
Distorted picture	<ul style="list-style-type: none"> - Sometimes a small amount of picture distortion may appear. This is not a malfunction. - Connect this unit directly to the TV. If the RCA audio / video cables are connected to a VCR, pictures may be distorted due to the copy right protection system.
Completely distorted picture or black / white picture with BD / DVD	<ul style="list-style-type: none"> - Make sure the disc is compatible with this unit.
No sound or distorted sound	<ul style="list-style-type: none"> - Adjust the volume. - Check that the speakers are connected correctly. - Check the HDMI connections. - Check the settings in "🔊 Audio" menu.
Picture freezes momentarily during playback	<ul style="list-style-type: none"> - Check the disc for fingerprints / scratches and clean with a soft cloth wiping from center to edge. - Clean the disc.
Disc cannot be played back	<ul style="list-style-type: none"> - Clean the disc. - Ensure the disc label is facing up. - Check if the disc is defective by trying another disc. - Cancel the ratings control or change the control level. - Insert a correct disc that can be played back on this unit.
SD Memory Card cannot be read.	<ul style="list-style-type: none"> - The format of the card does not match to this unit or the card is not compatible.
No return to start-up screen when disc is removed	<ul style="list-style-type: none"> - Reset this unit by turning it off, then on again.
The unit does not respond to the remote control	<ul style="list-style-type: none"> - Aim the remote control directly at infrared sensor window on the front panel. - Reduce the distance to infrared sensor window. - Replace the batteries in the remote control. - Re-insert the batteries with their polarities (+ / - signs) as indicated.
Buttons do not work or the unit stops responding	<ul style="list-style-type: none"> - To completely reset the unit, unplug the AC cord from the AC outlet for 5-10 seconds.
The unit does not respond to some operating commands during playback	<ul style="list-style-type: none"> - Operations may not be permitted by the disc. Refer to the instructions of the disc.
The unit cannot read BD / DVD / CD	<ul style="list-style-type: none"> - Condensation? (Let sit 1 or 2 hours) - You are attempting to playback a disc other than one with one of the marks on page 17. - Wipe the dirt off the disc or replace the disc.
Angle does not switch	<ul style="list-style-type: none"> - The angle cannot be switched for BD / DVD which do not contain multiple angles. In some cases multiple angles are only recorded for specific scenes.
Playback does not start when the title is selected	<ul style="list-style-type: none"> - Check the settings in "🔒 Parental" menu.
The password for rating level has been forgotten	<ul style="list-style-type: none"> - Enter the default password "4737", then your forgotten password will be cleared.

Note

- Some functions are not available in specific modes, but this is not a malfunction. Read the description in this manual for details on correct operations.
- Some functions are prohibited on some discs.

GLOSSARY

Analog Audio

An electrical signal that directly represents sound. Compare this to digital audio which can be an electrical signal, but is an indirect representation of sound. See also "Digital Audio".

Aspect Ratio

The width of a TV screen relative to its height. Conventional TVs are 4:3 (in other words, the TV screen is almost square); widescreen models are 16:9 (the TV screen is almost twice as wide as it is high).

BD-Java

With some BD which support Java applications, you can enjoy the interactive functions such as games or interactive menus.

Blu-ray Disc (BD)

Blu-ray Disc is a next generation optical video disc which is capable of storing much more data than a conventional DVD is. The large capacity makes it possible to benefit from the features such as high-definition videos, multi-channel surround sounds, interactive menus and so on.

Chapter

Just as a book is split up into several chapters, a title on a BD-video or DVD-video is usually divided into chapters. See also "Title".

Component Video Output

Each signal of luminance (Y) and component (P_B/C_B, P_R/C_R) is independent to output so that you can experience picture color as it is.

Also, due to compatibility with progressive video (525p/480p), you can experience higher-density picture than that in interlace (525i/480i).

Digital Audio

An indirect representation of sound by numbers. During recording, the sound is measured at discrete intervals (44,100 times a second for CD audio) by an analog-to-digital converter, generating a stream of numbers. On playback, a digital-to-analog converter generates an analog signal based on these numbers. See also "Sampling Frequency" and "Analog Audio".

Dolby Digital

The system to compress digital sound developed by Dolby Laboratories. It offers you sound of stereo (2ch) or multi-channel audio.

Dolby Digital Plus

Dolby Digital Plus is the next generation digital audio compression technology developed as an extension to Dolby Digital. Blu-ray Disc supports 7.1 multi-channel surround sound output.

Dolby TrueHD

Dolby TrueHD is a lossless coding technology developed for next generation optical discs. Blu-ray Disc supports 7.1 multi-channel surround sound output.

DTS (Digital Theater System):

DTS is a multi-channel surround sound system. By connecting to DTS decoder, you can enjoy movie dynamic and realistic sound like movie theater. DTS surround sound technologies were developed by DTS, Inc.

DTS-HD

DTS-HD is a lossless coding technology developed as an extension of the original DTS Coherent Acoustics format. Blu-ray Disc supports 7.1 multi-channel surround sound output.

HDMI (high-definition multimedia interface)

A digital interface between audio and video source. It can transmit component video, audio, and control signal with one cable connection.

JPEG (joint photographic experts group)

JPEG is a method of compressing still picture files. You can copy JPEG files on CD-RW/-R, DVD or SD Memory Card from a computer and play back the files in this unit.

PCM (pulse code modulation)

The most common system of encoding digital audio, found on CD and DAT. Excellent quality, but requires a lot of data compared to formats such as Dolby Digital and MPEG audio. For compatibility with digital audio recorders (CD, MD and DAT) and AV amplifiers with digital inputs, this unit can convert Dolby Digital and MPEG audio to PCM. See also "Digital Audio".

Region Code

Regions associate discs and players with particular areas of the world. This unit will only play back discs that have compatible region codes. You can find the region code of your unit by looking on the rear panel. Some discs are compatible with more than one region (or all regions).

Sampling Frequency

The rate which sound is measured by a specified interval to turn into digital audio data. The numbers of sampling in one second defines as sampling frequency. The higher the rate, the better the sound quality.

Title

A collection of chapters on BD-video or DVD-video. See also "Chapter".

Track

Audio CD use tracks to divide up the content of a disc. The BD-video or DVD-video equivalent is called a chapter. See also "Chapter".

LANGUAGE CODE

Language	Code
A-B	
Abkhazian	4748
Afar	4747
Afrikaans	4752
Albanian	6563
Amharic	4759
Arabic	4764
Armenian	5471
Assamese	4765
Aymara	4771
Azerbaijani	4772
Bashkir	4847
Basque	5167
Bengali;Bangla	4860
Bhutani	5072
Bihari	4854
Bislama	4855
Breton	4864
Bulgarian [BUL]	4853
Burmese	5971
Byelorussian	4851
C-E	
Cambodian	5759
Catalan	4947
Chinese [CHI]	7254
Corsican	4961
Croatian	5464
Czech [CZE]	4965
Danish [DAN]	5047
Dutch [DUT]	6058
English [ENG]	5160
Esperanto	5161
Estonian	5166
F-H	
Faroese	5261
Fiji	5256
Finnish [FIN]	5255

Language	Code
French [FRE]	5264
Frisian	5271
Galician	5358
Georgian	5747
German [GER]	5051
Greek [GRE]	5158
Greenlandic	5758
Guarani	5360
Gujarati	5367
Hausa	5447
Hebrew	5569
Hindi	5455
Hungarian [HUN]	5467
I-K	
Icelandic [ICE]	5565
Indonesian	5560
Interlingua	5547
Interlingue	5551
Inupiak	5557
Irish [IRI]	5347
Italian [ITA]	5566
Japanese [JPN]	5647
Javanese	5669
Kannada	5760
Kashmiri	5765
Kazakh	5757
Kinyarwanda	6469
Kirghiz	5771
Kirundi	6460
Korean [KOR]	5761
Kurdish	5767
L-N	
Laothian	5861
Latin	5847
Latvian;Lettish	5868
Lingala	5860
Lithuanian	5866

Language	Code
Macedonian	5957
Malagasy	5953
Malay	5965
Malayalam	5958
Maltese	5966
Maori	5955
Marathi	5964
Moldavian	5961
Mongolian	5960
Nauru	6047
Nepali	6051
Norwegian [NOR]	6061
O-R	
Occitan	6149
Oriya	6164
Oromo(Afan)	6159
Panjabi	6247
Pashto;Pushto	6265
Persian	5247
Polish [POL]	6258
Portuguese [POR]	6266
Quechua	6367
Rhaeto-Romance	6459
Romanian [RUM]	6461
Russian [RUS]	6467
S	
Samoaan	6559
Sangho	6553
Sanskrit	6547
Scots Gaelic	5350
Serbian	6564
Serbo-Croatian	6554
Sesotho	6566
Setswana	6660
Shona	6560
Sindhi	6550
Singhalese	6555

Language	Code
Siswat	6565
Slovak [SLO]	6557
Slovenian	6558
Somali	6561
Spanish [SPA]	5165
Sundanese	6567
Swahili	6569
Swedish [SWE]	6568
T	
Tagalog	6658
Tajik	6653
Tamil	6647
Tatar	6666
Telugu	6651
Thai	6654
Tibetan	4861
Tigrinya	6655
Tonga	6661
Tsonga	6665
Turkish [TUR]	6664
Turkmen	6657
Twi	6669
U-Z	
Ukrainian	6757
Urdu	6764
Uzbek	6772
Vietnamese	6855
Volapuk	6861
Welsh	4971
Wolof	6961
Xhosa	7054
Yiddish	5655
Yoruba	7161
Zulu	7267

Note

- If you choose a language that has a 3-letter-language code (written in bracket), the code will be displayed every time you change the audio or subtitle language setting on page 29. If you choose any other languages, '---' will be displayed instead.

SPECIFICATIONS

General

Media	BD-video, DVD-video, DVD+RW/+R, CD-DA, CD-RW/-R, DTS-CD
Power requirements	120V AC, 60Hz
Power consumption	30W (standby: 0.8W)
Dimensions (width x height x depth)	17.2 x 2.8 x 13.9 inches (435 x 70 x 351mm)
Weight	9.1 lbs. (4.1kg)
Operating temperature	41°F (5°C) to 104°F (40°C)
Operating humidity	Less than 80% (no condensation)

Terminals

Rear	Audio output (Analog)			
	RCA jack x 2	L/R: 2Vrms (output impedance: more than 1kΩ)		
	Video output			
	RCA jack x 1	1Vp-p (75Ω)		
	Component video output			
	RCA jack x 3	Y: 1Vp-p (75Ω)	Pb/Cb: 700mVp-p (75Ω)	Pr/Cr: 700mVp-p (75Ω)
	Audio output (Digital)			
	RCA jack x 1	500mVp-p (75Ω)		
HDMI output				
HDMI jack x 1	Video: 480p, 720p, 1080i, 1080p, 1080p24 / Audio			

Note

- The specifications and design of this product are subject to change without notice.

MEMO

Introduction

Connections

Playback

Function Setup

Others

MAGNAVOX

LIMITED WARRANTY

FUNAI CORP. will repair this product, free of charge in the USA in the event of defect in materials or workmanship as follows:

DURATION:

PARTS: FUNAI CORP. will provide parts to replace defective parts without charge for one (1) year from the date of original retail purchase. Certain parts are excluded from this warranty.

LABOR: FUNAI CORP. will provide the labor without charge for a period of ninety (90) days from the date of original retail purchase.

LIMITS AND EXCLUSIONS:

THIS WARRANTY IS EXTENDED ONLY TO THE ORIGINAL RETAIL PURCHASER. A PURCHASE RECEIPT OR OTHER PROOF OF ORIGINAL RETAIL PURCHASE WILL BE REQUIRED TOGETHER WITH THE PRODUCT TO OBTAIN SERVICE UNDER THIS WARRANTY.

This warranty shall not be extended to any other person or transferee.

This warranty is void and of no effect if any serial numbers on the product are altered, replaced, defaced, missing or if service was attempted by an unauthorized service center. This limited warranty does not apply to any product not purchased and used in the United States.

This warranty only covers failures due to defects in material or workmanship which occur during normal use. It does not cover damage which occurs in shipment, or failures which are caused by repairs, alterations or products not supplied by FUNAI CORP., or damage, which results from accident, misuse, abuse, mishandling, misapplication, alteration, faulty installation, improper maintenance, commercial use such as hotel, rental or office use of this product, or damage which results from fire, flood, lightning or other acts of God.

THIS WARRANTY DOES NOT COVER PACKING MATERIALS, ANY ACCESSORIES (EXCEPT REMOTE CONTROL), ANY COSMETIC PARTS, COMPLETE ASSEMBLY PARTS, DEMO OR FLOOR MODELS.

FUNAI CORP. AND ITS REPRESENTATIVES OR AGENTS SHALL IN NO EVENT BE LIABLE FOR ANY GENERAL, INDIRECT OR CONSEQUENTIAL DAMAGES ARISING OUT OF OR OCCASIONED BY THE USE OF OR THE INABILITY TO USE THIS PRODUCT. THIS WARRANTY IS MADE IN LIEU OF ALL OTHER WARRANTIES, EXPRESS OR IMPLIED, AND OF ALL OTHER LIABILITIES ON THE PART OF FUNAI, ALL OTHER WARRANTIES INCLUDING THE WARRANTY OF MERCHANTABILITY AND FITNESS FOR A PARTICULAR PURPOSE, ARE HEREBY DISCLAIMED BY FUNAI AND ITS REPRESENTATIVES IN THE UNITED STATES.

ALL WARRANTY INSPECTIONS AND REPAIRS MUST BE PERFORMED BY AN AUTHORIZED SERVICE CENTER. THIS WARRANTY IS ONLY VALID WHEN THE UNIT IS CARRIED-IN TO AN AUTHORIZED SERVICE CENTER.

THE PRODUCT MUST BE ACCOMPANIED BY A COPY OF THE ORIGINAL RETAIL PURCHASE RECEIPT. IF NO PROOF OF PURCHASE IS ATTACHED, THE WARRANTY WILL NOT BE HONORED AND REPAIR COSTS WILL BE CHARGED.

IMPORTANT:

THIS LIMITED WARRANTY GIVES YOU SPECIFIC LEGAL RIGHTS. YOU MAY HAVE OTHER RIGHTS THAT VARY FROM STATE TO STATE. IF, AT ANY TIME DURING THE WARRANTY PERIOD, YOU ARE UNABLE TO OBTAIN SATISFACTION WITH THE REPAIR OF THIS PRODUCT, PLEASE CONTACT FUNAI CORP.

ATTENTION:

FUNAI CORP. RESERVES THE RIGHT TO MODIFY ANY DESIGN OF THIS PRODUCT WITHOUT PRIOR NOTICE.

WARRANTY STATEMENT REGARDING NON AUTHORIZED REPAIRS:

To obtain warranty service, you must take the product, or deliver the product freight prepaid, in either its original packaging or packaging affording an equal degree of protection, to any AUTHORIZED SERVICE CENTER. FUNAI CORP. will not reimburse you for any service done by unauthorized service providers without prior written approval.

To locate your nearest AUTHORIZED SERVICE CENTER or for general service inquiries, please contact us at:

FUNAI CORPORATION

Customer Service

Tel : 1-800-605-8610

www.funai-corp.com

19900 Van Ness Avenue, Torrance, CA 90501

Quick Start Guide



NB500MG9

Playable Discs and Files

This unit is compatible to play back the following discs / files.

Playable discs	Logos	Playable files	Logos
Blu-ray Disc - BD-video (single / double layer) - BD-RE ver.2.1 (single / double layer) (Recorded in BDMV format) - BD-R (single / double layer) (Recorded in BDMV format) (Unclosed discs may not be played back.)		JPEG	SD Memory Card (including SDHC), miniSD Card, microSD Card
DVD-video		Readable cards	Playable files / data
DVD+RW (single layer)		SD Memory Card (8MB - 2GB)	JPEG, picture-in-picture commentary, subtitles or other extras for BD-ROM Profile 1 ver.1.1
DVD+R (single / double layer)		SDHC Memory Card (4GB)	
CD-DA (audio CD)		miniSD Card (8MB - 2GB)	
CD-RW		microSD Card (8MB - 2GB)	
CD-R			
Kodak Picture CD			
DTS-CD			

• For miniSD Card and microSD Card, the adapter is necessary.

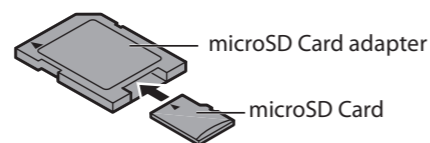
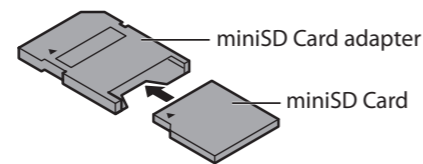

"Blu-ray Disc" and are trademarks.

is a trademark of DVD Format/Logo Licensing Corporation.

Region Codes

This unit has been designed to play back BD-video with region A and DVD-video with region "1" or "ALL".

You cannot play back BD-video or DVD-video that are labeled for other regions. Look for the symbols on the right on your BD-video or DVD-video. If these region symbols do not appear on your BD-video or DVD-video, you cannot play back the disc in this unit. The letter or number inside the globe refers to region of the world. A BD-video or DVD-video labeled for a specific region can only play back on the unit with the same region code.

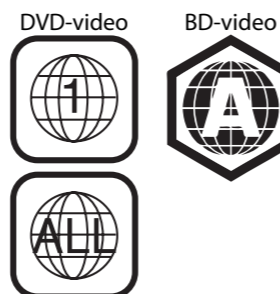

E5E20UD / E5H20UD
1VMN25074 / ★★★★★

1. Connections



All devices should be turned off and disconnected from the power outlet, when you make the connections.

Supplied cables used in this connection are as follows:

- RCA audio cable (L/R) x 1
 - RCA video cable x 1
- Please purchase the rest of the necessary cables at your local store.

Basic Connections

Make one of the following connections, depending on the capabilities of your existing device.

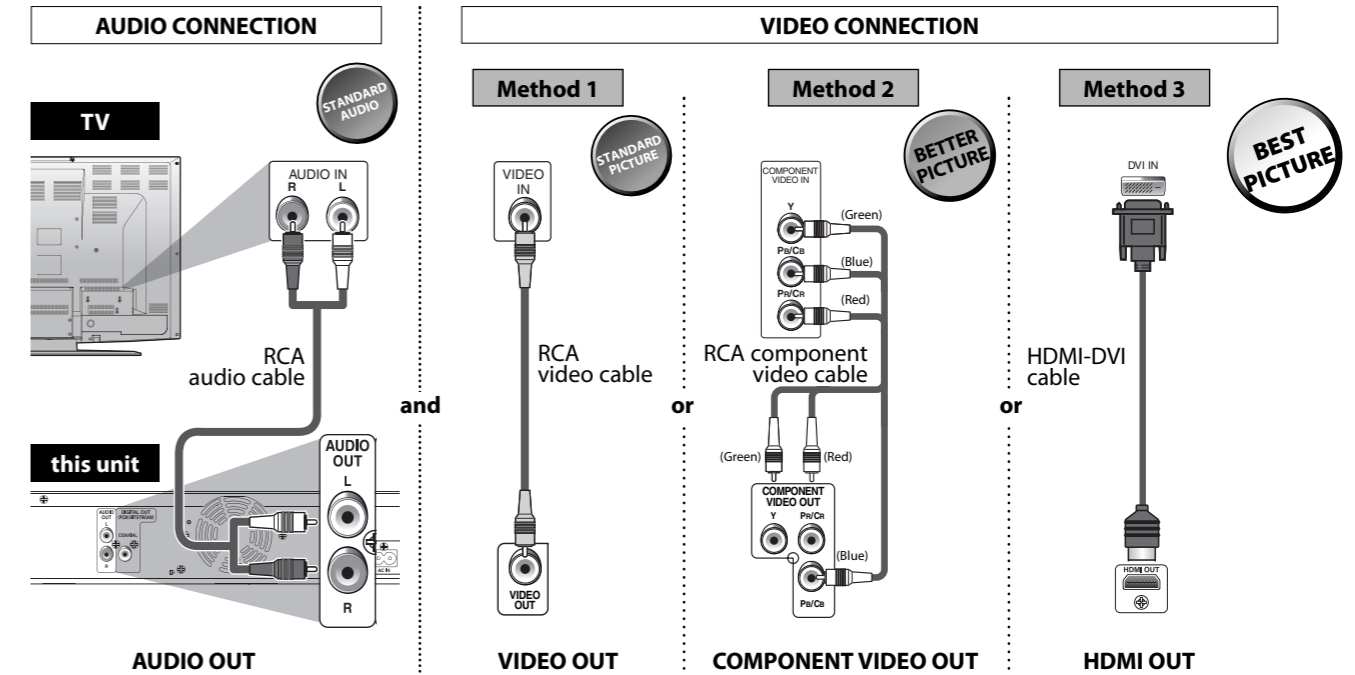

HDMI Connection

AUDIO/VIDEO CONNECTION

Method 4

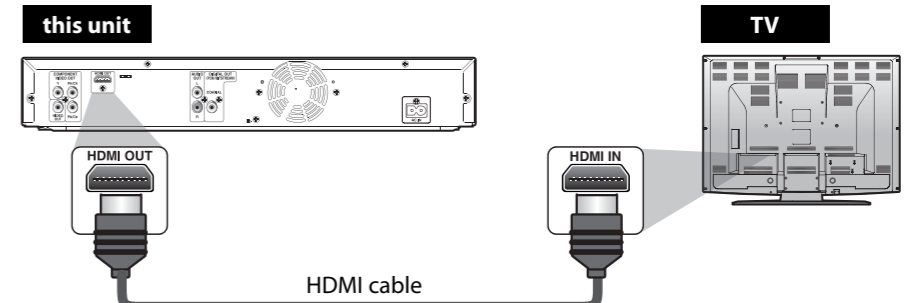

Press [HDMI] to change the resolution of the video signal being output from HDMI OUT jack. The video resolution changes as follows every time [HDMI] is pressed.

480p → 720p → 1080i → 1080p → 1080p24

Note :

- You cannot select the video resolutions which are not supported by the connected TV.
- In order to get natural and high quality film reproduction of 24-frame film material, use an HDMI cable (High Speed HDMI Cable is recommended) and select "1080p24" if the connected TV is compatible with 1080p24 frame input.

Follow to the back side of this sheet.

1. Connections (cont'd)

Connection to an Audio System

Supplied cables used in this connection are as follows:

- RCA audio cable (L/R) x 1
- Please purchase the rest of the necessary cables at your local store.

2-Channel Analog Audio Connection

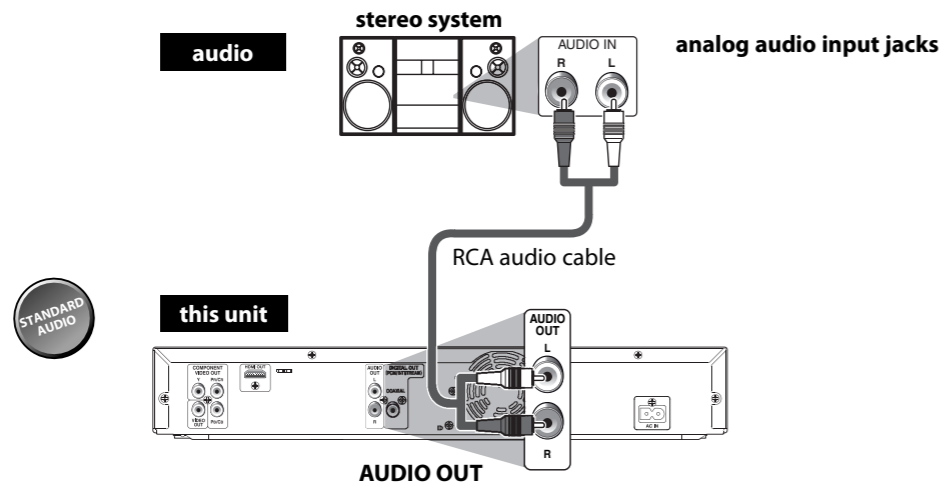

Digital Audio Connection

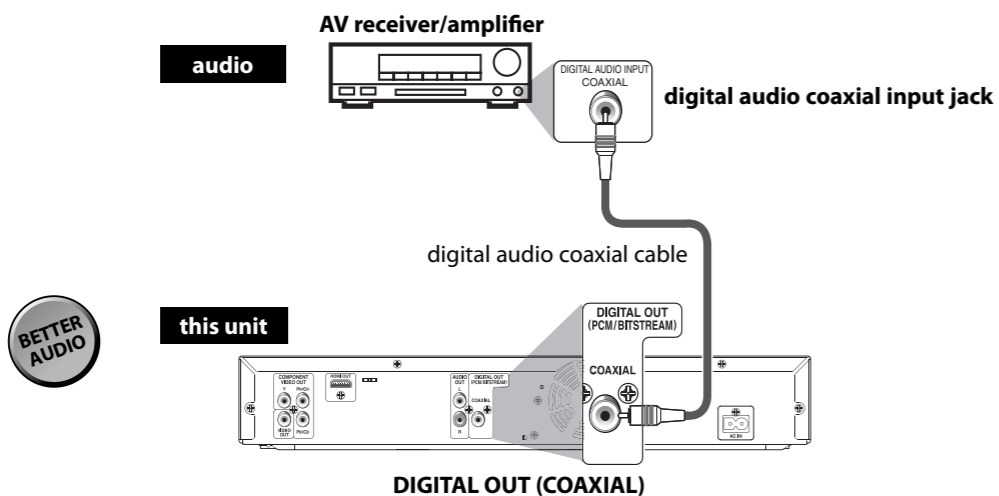

Connecting the AC Cord

Supplied cables used in this connection are as follows:

- AC cord x 1

After you made all necessary connections, connect the AC cord to the AC IN. Then connect the AC cord to the AC outlet.

Insert the plugs securely. Incomplete connections will result in the generation of noise.

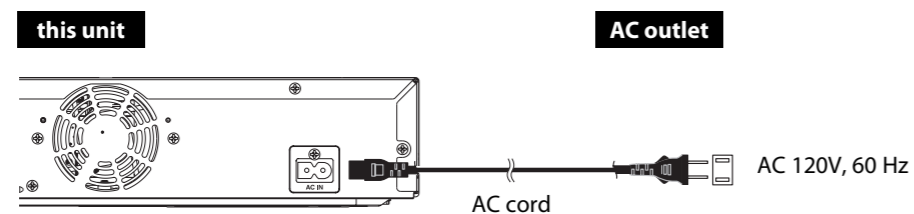

2. Playback

- 1 Press [STANDBY-ON]
- 2 Turn on the TV and select the appropriate input on the TV to which the unit is connected.

- 3 Press [OPEN / CLOSE] to open the disc tray.

- 4 Place the disc on the disc tray with its label side facing up.

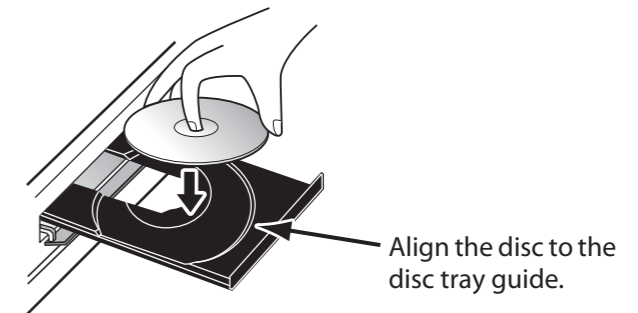

- 5 Press [OPEN / CLOSE] to close the disc tray.

It may take a while to load the disc.

Some discs may start playback automatically.

- 6 Press [PLAY] to start playback.

For many of BD-video and DVD-video, a menu screen may appear.

In this case, use [/ / /] to select the desired item, then press [OK].

To pause playback:

Press [PAUSE] .

To return to normal playback:

Press [PLAY] .

To stop playback:

Press [STOP] .

To eject the disc:

Press [OPEN / CLOSE] to open the disc tray, then remove the disc before turning off the unit.

Free Manuals Download Website

<http://myh66.com>

<http://usermanuals.us>

<http://www.somanuals.com>

<http://www.4manuals.cc>

<http://www.manual-lib.com>

<http://www.404manual.com>

<http://www.luxmanual.com>

<http://aubethermostatmanual.com>

Golf course search by state

<http://golfingnear.com>

Email search by domain

<http://emailbydomain.com>

Auto manuals search

<http://auto.somanuals.com>

TV manuals search

<http://tv.somanuals.com>