

MBP5320 Blu-ray Disc™ / DVD Player with Built-in WiFi



CONTENTS

INTRODUCTION 3

Safety Instructions.....	3
Supplied Accessories.....	3

FEATURES 4

Features.....	4
Product Info	5
Symbols Used in this Owner's Manual.....	5

FUNCTIONAL OVERVIEW 6

Front Panel	6
Rear Panel.....	6
Remote Control.....	7
Guide to On-Screen Display.....	9

CONNECTIONS 10

Connection to a TV	10
Connection to an Audio System.....	11
HDMI Audio Output.....	12
Connection to the Network.....	13

BEFORE YOU START 15

Finding a Viewing Video Source Input on Your TV ...	15
Initial Setup.....	15

INFORMATION ON PLAYBACK..... 17

Information on Playback.....	17
Guide to File List.....	20
How to Insert a Disc	21

BASIC PLAYBACK..... 22

Playing Back a Disc	22
Playing Back Contents from a USB Memory Stick.....	23
Playing Back Video / Music / Photo from DLNA	
Certified Home Media Servers.....	24
Using the Title / Disc / Pop Menu.....	25

SPECIAL PLAYBACK..... 26

Fast Forward / Fast Reverse.....	26
Slow Forward Playback.....	26
Step by Step Playback.....	26
Repeat Playback.....	27
Slide Show.....	27
PiP (BONUSVIEW™) Setting	28
Enjoying BD-Live™ Discs Using Internet.....	28
Title / Chapter Search	29
Track / File Search	29
Time Search.....	30
Switching Subtitles	30
Switching Audio Soundtrack	31
Switching Camera Angles.....	32
Black Level.....	32
Noise Reduction	33
CLEAR+	33

NETWORK FEATURES..... 34

Before Using Network Features.....	34
Information on Network Services.....	34

LIST OF SETTINGS 35

SETUPS..... 38

Network Connection	38
fun-Link (HDMI CEC).....	43
HDMI Video Resolution.....	43
Parental	44
Software Update.....	46
Restore Default Settings.....	47

TROUBLESHOOTING 48

LANGUAGE CODE LIST 52

SPECIFICATIONS..... 53

NETWORK SERVICE DISCLAIMER..... 54

MAINTENANCE..... 55

TRADEMARK INFORMATION 56

GLOSSARY..... 58

ESPAÑOL 60

Mando a Distancia	60
Encontrar el Canal de Video en su Televisor	61
Instalacion Inicial	62

LIMITED WARRANTYback cover

1. INTRODUCTION

1.1. Safety Instructions

To Avoid the Hazards of Electrical Shock and Fire

- Do not handle the AC power cord with wet hands.
- Do not pull on the AC power cord when disconnecting it from an AC outlet. Grasp it by the plug.
- Do not put your fingers or objects into the unit.

Location and Handling

- Do not install the unit in direct sunlight, near strong magnetic fields, or in a place subject to dust or strong vibration.
- Avoid a place with drastic temperature changes.
- Install the unit in a horizontal and stable position. Do not place anything directly on top or bottom of the unit. Depending on your external devices, noise or disturbance in the picture and/or sound may be generated if the unit is placed too close to them. In this case, please ensure enough space between the external devices and the unit.
- Depending on the environment, the temperature of this unit may increase slightly. This is not a malfunction.
- Be sure to remove the disc and unplug the AC power cord from the outlet before moving the unit.

Dew Condensation Warning

- Dew condensation may form inside the unit in the following conditions. If so, do not use this unit at least for a few hours until its inside gets dry.
 - The unit is moved from a cold place to a warm place.
 - Under conditions of high humidity.
 - After heating a cold room.

Note about Recycling

- This unit's packaging materials are recyclable and can be reused. Please dispose of any materials in accordance with your local recycling regulations.
 - Batteries should never be thrown away or incinerated but disposed of in accordance with your local regulations concerning chemical wastes.
 - For product recycling information, please visit - www.magnavox.com
- Click on



Notice for Progressive Scan Output

- Consumers should note that not all high definition television sets are fully compatible with this product and may cause artifacts to be displayed in the picture. In case of picture problems with 480 progressive scan output, it is recommended that the user switch the connection to the 'standard definition' output. If there are questions regarding your TV set compatibility with this 480p Blu-ray Disc™/DVD player, please contact our customer service center.

1.2. Supplied Accessories

- Remote Control (NB991UD / NB991UH)
- Batteries (AAA, 1.5V × 2)
- SETUP MANUAL

MAGNAVOX is a registered trademark of Philips Electronics North America Corporation and is used by Funai Electric Co., Ltd. and Funai Corporation, Inc. under license from Philips Electronics North America.

© 2013 Funai Electric Co., Ltd.

All rights reserved. No part of this manual may be reproduced, copied, transmitted, disseminated, transcribed, downloaded or stored in any storage medium, in any form or for any purpose without the express prior written consent of Funai. Furthermore, any unauthorized commercial distribution of this manual or any revision hereto is strictly prohibited. Information in this document is subject to change without notice. Funai reserves the right to change the content herein without the obligation to notify any person or organization of such changes.

2. FEATURES

2.1. Features

Blu-ray Disc™

You can enjoy Blu-ray Disc™ which is capable of storing five times more data than a conventional DVD.

BD-Java

With some Blu-ray discs which contain Java applications, you can enjoy interactive functions such as games or interactive menus.

DVD upscaling for enhanced picture quality

Your current DVD will look even better than before thanks to video upscaling. Upscaling will increase the resolution of standard definition DVD to high definition up to 1080p over an HDMI connection. The picture will be less jagged and more realistic for a near high definition experience.

Enjoy your content on different kinds of media

Full backwards compatibility with DVD, CD and USB Memory Stick ensures that you can continue to enjoy your current audio-video collection. Additionally, you can enjoy AVCHD (for DVD-RW/-R only) / MP3 / JPEG files.

Listen to rich multi-channel surround sound

Multi-channel surround sound, which realizes real-to-life sound and makes you feel that you are really there.

Easy and simple connection to your HDTV via HDMI

Connect this unit to your HDTV with one single HDMI (High Definition Multimedia Interface) cable. It is recommended to use a High Speed HDMI cable for better compatibility. The high definition video output signal will be transferred to your HDTV without conversion to analog signals, so you will get excellent picture and sound quality, completely free from noise. Thanks to other multiple outputs, you can also easily connect to your home theater system or amplifier.

fun-Link (HDMI CEC) (Consumer Electronics Control)

This unit supports fun-Link (HDMI CEC), which allows integrated system control over an HDMI cable and is part of the HDMI standard. This function may not work properly on some devices.

PiP (BONUSVIEW™)

Some BD-videos have the PiP function which enables you to display the Secondary Video in the Primary Video. You can call up the Secondary Video by pressing **[MODE]** whenever the scene contains a Secondary Video.

BD-Live™

BD-Live™ (BD-ROM version 2 Profile 2.0) that allows interactive functions to be used when this unit is connected to the Internet in addition to the BONUSVIEW™ function. The various functions differ depending on the disc.

Pop Menu

Some BD-videos have a Pop Menu which is a navigation menu that can be called up and be operated on the TV screen without interrupting playback. You can call up the Pop Menu by pressing **[POP MENU/MENU]**. Contents in the Pop Menu vary depending on the disc.

HDMI Deep Color

Deep Color reduces posterization (color banding) effect of the playback image.

HDMI 1080p/24 output (Blu-ray Disc™ only)

This unit is equipped with the feature which can provide smooth movement during playback of film originated material with the frame rate of 24 frames per second with progressive. (Available only when the display device is connected with an HDMI cable.) Refer to "HDMI Video Resolution" on page 43.

Playing back contents from a USB Memory Stick

You can play back MP3 / JPEG files stored on a USB Memory Stick. BD-ROM Profile 2.0 (BD-Live™) and Profile 1.1 discs sometimes store picture-in-picture commentary, subtitles or other extras on a USB Memory Stick for use during playback with the BD-video.

Playing back AVCHD files

This unit supports playback of AVCHD format files (new format for high definition video camcorders) recorded on a disc / SD Memory Card using USB card reader / USB hub (not supplied). Your high definition personal archive is playable in HD quality.

x.v.Color

This unit supports playback of video contents on discs recorded with "x.v.Color" technology. To watch this video content with the "x.v.Color" space, a TV or other display device supporting both video image reproduction using "x.v.Color" standard and capability of manual switching of its color space setting is required. Please refer to the user manual of your display device for further information.

Enjoy contents stored on DLNA certified home media servers

This unit is a DLNA certified media player that can play video, music and photo files stored on DLNA certified home media servers connected to your home network. (not warranted for wireless environment)

Netflix

With this unit, you can enjoy movies and TV episodes streamed instantly from Netflix via the Internet. In order to use this feature, you must visit www.netflix.com/Magnavox on your PC and become a Netflix member. (This feature is only available in the United States.)

continued on next page

VUDU

This unit supports VUDU which is the leading HD on-demand video service. With VUDU, you can also enjoy various kinds of Internet applications. In order to use this feature, you must connect this unit to the Internet www.vudu.com/product_overview.html (This feature is only available in the United States.)
 - www.vudu.com

YouTube™

This unit enables you to access YouTube™. On your TV screen, you can enjoy a large number of video clips streamed from YouTube™.

Digital Rights Management

This product contains technology subject to certain intellectual property rights of Microsoft.

Use or distribution of this technology outside of this product is prohibited without the appropriate license(s) from Microsoft.

2.2. Product Info

“Product Info” screen provides information about this unit’s software version. You can also download the latest software from the Magnavox website and update it yourself if it is newer than the version currently on your unit. The current version of software on your unit can be seen on the “Product Info” screen. To access “Product Info”, follow the procedure below.

1. Press **[HOME]**.
2. Use **[▲ / ▼ / ◀ / ▶]** to select “Settings”, then press **[OK]**.
3. Use **[▲ / ▼]** to select “Others”, then press **[OK]**.
4. Use **[▲ / ▼]** to select “Product Info”, then press **[OK]**.

2.3. Symbols Used in this Owner’s Manual

To specify which media type each function is applicable to, the following symbols that are at the beginning of each Symbol type.

Symbol	Description
	Description refers to BD-video
	Description refers to DVD-video
	Description refers to audio CD / DTS-CD
	Description refers to DVD-RW/-R with AVCHD files
	Description refers to BD-RE/-R, DVD-RW/-R, CD-RW/-R and USB Memory Stick with MP3 files
	Description refers to BD-RE/-R, DVD-RW/-R, CD-RW/-R and USB Memory Stick with JPEG files
	Description refers to video files in the DLNA Media Server
	Description refers to music files in the DLNA Media Server
	Description refers to photo files in the DLNA Media Server

If you do not find any of the symbols listed above under the function heading, the operation is applicable to all media.

3. FUNCTIONAL OVERVIEW

3.1. Front Panel



* The unit can also be turned on by pressing this button.

1. **Disc tray**
2. **▲ (OPEN/CLOSE) button***
3. **⏻ (POWER-ON) button**
4. **Power-On indicator**
 - Flashes while unit is starting up.
 - Dims and flickers when IR remote signal is received.
5. **Infrared sensor window**
6. **USB Input**

⚠ Caution

- Do not connect any device other than USB Memory Stick or USB card reader into the USB Input. (e.g. PC, external HDD, MP3 player, digital camera, keyboard, mouse, etc.)
- When connecting a USB Memory Stick, connect it directly to the USB Input. Do not use a USB extension cable.

📌 Note

- Due to new ENERGY STAR® requirements, this unit will automatically turn on the screen saver after 5 minutes of inactivity and enter standby mode after 25 minutes of inactivity.

3.2. Rear Panel

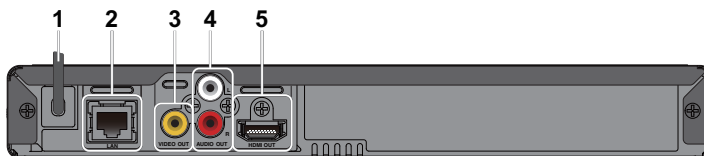

1. **AC power cord**
2. **LAN terminal**
3. **VIDEO OUT jack**
4. **AUDIO OUT jacks**
5. **HDMI OUT jack**

⚠ Caution

- Do not touch the inner pins of the jacks on the rear panel. Electrostatic discharge may cause permanent damage to the unit.
- This unit does not have a TV RF modulator.

3.3. Remote Control

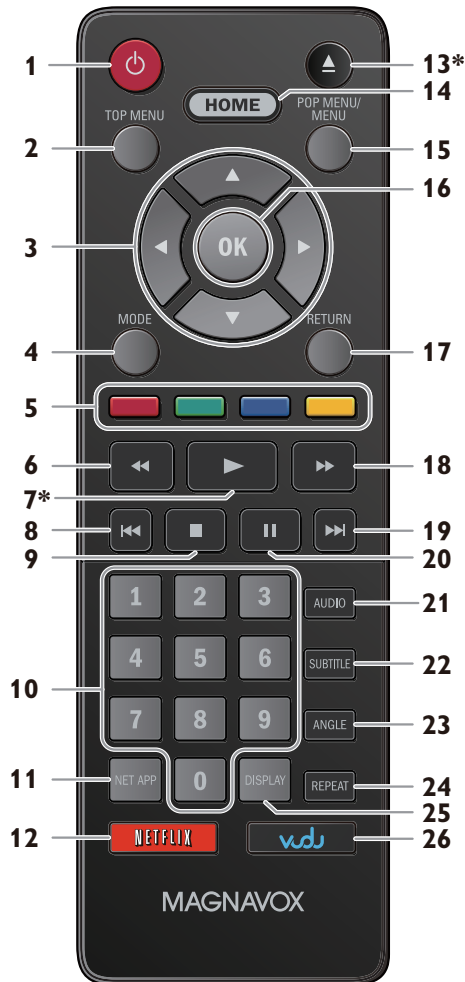

* The unit can also be turned on by pressing these buttons.

1. **⏻ (POWER-ON) button**
 - Press to Turn On the unit, or to switch the unit into Standby mode. (To completely Turn Off the unit, you must unplug the AC power cord.)
2. **TOP MENU button**

Blu-ray Disc™: Press to display the Top Menu.
DVD: Press to display the Title Menu.
3. **▲ / ▼ / ◀ / ▶ buttons**
 - Press to select items or settings.
4. **MODE button**
 - During playback, press to display the Play Menu.
5. **RED / GREEN / BLUE / YELLOW buttons**
 - Press to activate shortcut keys on some BD-video functions. When a file list is shown, press to switch between pages.
6. **◀◀ (REVERSE) button**
 - During playback, press to Fast Reverse the playback.
7. **▶ (PLAY) button***
 - Press to start playback or resume playback.
8. **◀◀ (SKIP) button**
 - During playback, press once to return to the beginning of the current Title, Chapter, Track or File.
 - During playback, press twice to return to the previous Title, Chapter, Track or File.
 - During the JPEG playback, press to return to the previous File.
9. **■ (STOP) button**
 - Press to Stop playback.
10. **NUMBER buttons**
 - Press to select a Chapter during playback.
 - Press to enter Numbers or letters in the input field.
11. **NET APP button**
 - Press to display the network application menu.
12. **NETFLIX button**
13. **▲ (OPEN/CLOSE) button***
 - Press to Open or Close the disc tray.
14. **HOME button**
 - Press to display the Home Menu.
15. **POP MENU/MENU button**

Blu-ray Disc™: Press to display the Pop Menu.
DVD: Press to display the Disc Menu.
16. **OK button**
 - Press to confirm or select menu items.
17. **RETURN button**
 - Press to Return to the previously displayed menu or screen function.
18. **▶▶ (FORWARD) button**
 - During playback, press to Fast Forward the playback.
 - When playback is in pause, press to Slow Forward the playback.
19. **▶| (SKIP) button**
 - During playback, press to Skip to the next Chapter, Track or File.
 - When playback is in pause mode, press to Forward the playback picture by picture.
20. **|| (PAUSE) button**
 - Press to Pause playback.
21. **AUDIO button**
 - Press to select the Audio Channel (such as audio languages) on a disc.
22. **SUBTITLE button**
 - Press to select Subtitles on a disc.

continued on next page

23. ANGLE button

- Press to access various camera Angles on the disc.

24. REPEAT button

- Press to select Repeat mode.

25. DISPLAY button

- Press to Display the on-screen display menu.

26. VUDU button

- Press to launch VUDU.

Note

- The Power-On indicator on the front panel dims and flickers when it receives the IR signal from the remote control.
- Use the supplied remote control. Remote-control operation on any other remote control, such as a universal remote control, is not guaranteed.

■ Installing the Batteries in the Remote Control

Install 2 AAA (1.5V) batteries matching the polarity indicated inside battery compartment of the remote control.

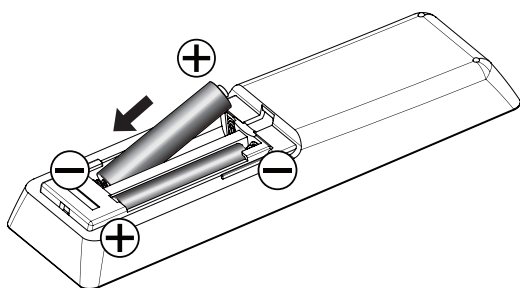

⚠ Caution

Incorrect use of batteries can result in hazards such as leakage and bursting. Please observe the following:

- Lithium or ni-cad and ni-mh rechargeable batteries are not recommended to use for remote control.
- Do not mix different types of batteries such as alkaline and standard (carbon-zinc).
- Do not mix new and old batteries together.
- Do not use different kinds of batteries together. Although they may look similar, different batteries may have different voltages.
- Make sure that the + and - ends of each battery match the indications in the battery compartment.
- Remove batteries from battery compartment, when the remote is not going to be used for a month or more.
- When disposing of used batteries, please comply with governmental regulations or environmental public rules that apply in your country or area.
- Do not recharge, short-circuit, heat, burn or disassemble batteries.

■ Using the Remote Control

Remote Control Usage Guidelines:

- Make sure that there are no obstacles between the remote control and the infrared sensor window on the unit.
- Remote operation may become unreliable if strong sunlight or fluorescent light is shining on the infrared sensor window of the unit.
- Remote controls of different devices can interfere with each other. Avoid using a remote control from another device which is located close to the unit.
- Replace the batteries when you notice a fall-off in the operating range of the remote control.
- The maximum operable ranges from the unit are as follows.

- Line of sight:

approx. 23 feet (7 m)

- Either side of the center:

approx. 16 feet (5 m) within 30°

- Above:

approx. 16 feet (5 m) within 15°

- Below:

approx. 10 feet (3 m) within 30°

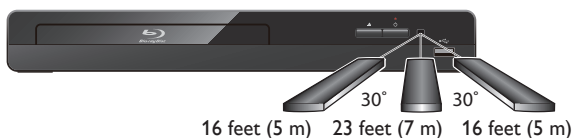

3.4. Guide to On-Screen Display

■ Home Menu

When you Turn On the unit, Home Menu will appear automatically. Otherwise, press **[HOME]**.

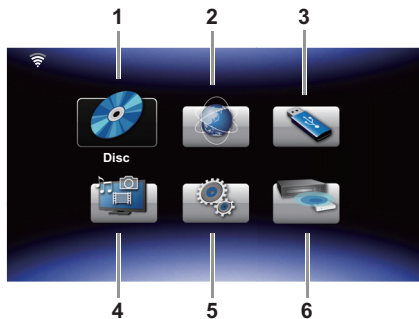

1. **“Disc”**: Initiates playback of inserted disc, displays a list of Tracks / Files or the Media Filter Menu
2. **“NET APP”**: To access the menu of network services
3. **“USB Memory Stick”**: Displays a list of Tracks / Files on the connected USB Memory Stick or the Media Filter Menu
4. **“Home Network”**: To access the home network server (DLNA)
5. **“Settings”**: To access the Setup Menu
6. **“Network Setup”**: To set up network settings

■ Network Status Icons



: The unit is connected to a wireless network. The white bars indicate the wireless signal strength.



: The unit is not connected to a wireless network.

When the unit has successfully been connected to an access point,  appears in the upper left corner of the Home Menu screen.

Note

- The network status icon does not necessarily mean that this unit is connected to the Internet.
- When “Network Setup” is set to “Wired”, the network status icon does not appear.

■ Setup Menu

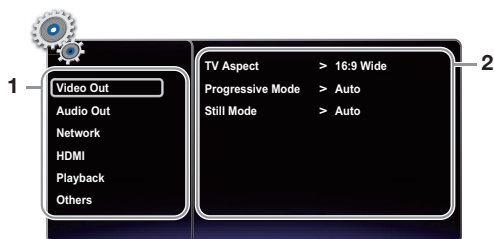

1. **Category**
2. **Menus / Options**: Displays options for the highlighted item on the left whenever available

■ Play Menu

During playback, press **[MODE]** to display the Play Menu.

e.g.) Blu-ray Disc™

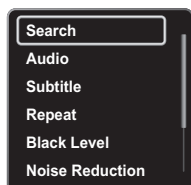

4. CONNECTIONS

4.1. Connection to a TV

■ HDMI Connection (Supports up to 1080i^(*1), 1080p^(*2), 1080p/24^(*3) resolution.)

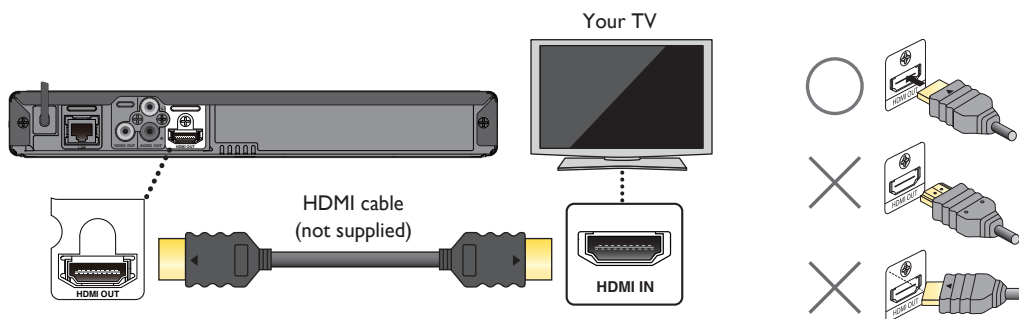

No analog audio connection required.

(*1) 1080i: Outputs video data with a frame rate of 30 frames per second.

(*2) 1080p: Outputs video data with a frame rate of 60 frames per second.

(*3) 1080p/24: Outputs video data with a frame rate of 24 frames per second.

- Do not tilt the connector when inserting it into the HDMI jack, and make sure the shapes of the jack and the connector are matched.
- When connected to an HDCP incompatible display device, the picture will not be displayed properly.
- Use an HDMI cable with the HDMI logo (a certified HDMI cable) for this connection. High Speed HDMI cable (also known as HDMI category 2 cable) is recommended for better compatibility.

ⓘ Note

- If the TV receives no Audio / Video signal after properly connecting the unit and the TV with an HDMI cable, it may be the TV. Please refer to the TV's user's manual.
- If the TV receives no Audio signal after properly connecting the unit and the TV with an HDMI cable, make sure the TV input is not an HDMI-DVI Input terminal.

■ Standard Composite Video + Standard Audio Connection (Supports only 480i resolution.)

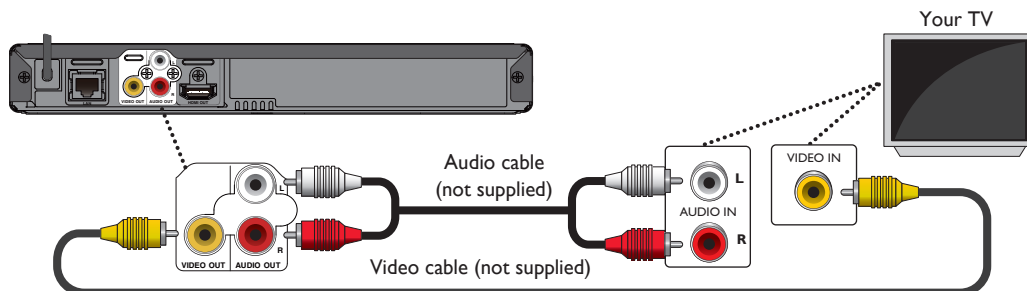

- Connect this unit directly to the TV. If the audio / video cables are connected to a VCR then the pictures may be distorted due to the copyright protection system.

4.2. Connection to an Audio System

- When you change the connections, all devices should be Turned Off.
- When connecting the unit to an external audio system, refer to the User Manual for Setup / Configuration help.

■ HDMI Audio Connection

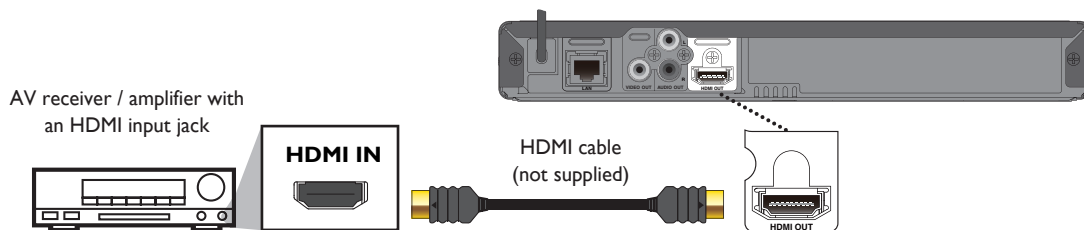

■ 2-Channel Analog Audio Connection

Stereo system with analog audio input jacks

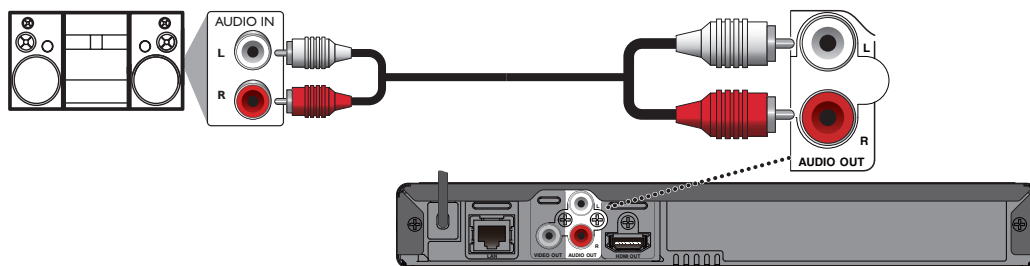

- Use an audio cable (not supplied) to connect the AUDIO OUT jacks on the unit to the audio input jacks on the connected device.

4.3. HDMI Audio Output

	“Audio Output” setting →	“Bitstream”		“LPCM”		
	“BD Audio Mode” setting →	“HD Audio Output”	“Mix Audio Output”	“HD Audio Output”	“Mix Audio Output”	
Media ↓	Audio Source ↓	Which audio format can be output depends on the compatibility of the connected device.				
BD-video	Dolby Digital	Dolby Digital		Multi LPCM		
	Dolby Digital Plus	Dolby Digital Plus	Dolby Digital	Multi LPCM* ¹	Multi LPCM* ²	
	Dolby TrueHD	Dolby TrueHD	Dolby Digital	Multi LPCM* ³	Multi LPCM* ⁴	
	DTS®	DTS®		Multi LPCM		
	DTS-HD®	DTS-HD®	DTS®	Multi LPCM* ¹	Multi LPCM* ⁵	
	LPCM	Multi LPCM		Multi LPCM		
DVD-video	Dolby Digital	Dolby Digital		Multi LPCM		
	DTS®	DTS®		Multi LPCM		
	LPCM	2ch LPCM		2ch LPCM		
Audio CD	LPCM	2ch LPCM		2ch LPCM		
DTS-CD	DTS®	DTS®		Multi LPCM		
AVCHD	Dolby Digital	Dolby Digital		Multi LPCM		
	LPCM	Multi LPCM		Multi LPCM		
MP3	MP3	2ch LPCM		2ch LPCM		
DLNA Video	Dolby Digital	Dolby Digital		Multi LPCM		
	MP2	2ch LPCM		2ch LPCM		
	LPCM	Multi LPCM		Multi LPCM		
DLNA Music	MP3 / LPCM	2ch LPCM		2ch LPCM		
Netflix	Dolby Digital Plus	Dolby Digital Plus		Multi LPCM* ¹		
	HE-AAC	2ch AAC		2ch LPCM		
VUDU	Dolby Digital	Dolby Digital		Multi LPCM		
	Dolby Digital Plus	Dolby Digital Plus		Multi LPCM* ¹		
	HE-AAC	2ch AAC		2ch LPCM		
	MP3	2ch LPCM		2ch LPCM		
YouTube™	HE-AAC	2ch AAC		2ch LPCM		

*1) Fully decoded.

*2) Only the independent substream is decoded.

*3) Dolby TrueHD stream is decoded.

*4) Only the Dolby Digital substream is decoded.

*5) Only the core substream is decoded.

⊖ Note

- If the connected device is not compatible with the HDMI BITSTREAM, audio will be output as multi LPCM or 2-channel down-mixed LPCM depending on the capability of the connected device even if you select “Bitstream” in “Audio Output” setting.
- If the connected device is not compatible with AAC, audio will be output as LPCM depending on the capability of the connected device.
- When playing back a BD-video which only contains the primary audio, the audio output will be the same case as “HD Audio Output” even if the “BD Audio Mode” is set to “Mix Audio Output”.
- HD Audio will not be output when “BD Audio Mode” is set to “Mix Audio Output” and the Button Sound feature in the content is enabled. (Button Sound setting may be found in Pop Menu.)

4.4. Connection to the Network

By connecting this unit to the Internet, you can update the software via the Internet, play contents stored on DLNA home media servers or access BD-Live™ and other network services, such as Netflix, VUDU and YouTube™.

- Software Update: For more information, refer to “Network Update” on page 46.
- DLNA home media server: For more information, refer to “Playing Back Video / Music / Photo from DLNA Certified Home Media Servers” on page 24.
- BD-Live™: For more information, refer to “Enjoying BD-Live™ Discs Using Internet” on page 28.
- Netflix / VUDU / YouTube™ : For more information, refer to “Information on Network Services” on page 34.

Note

- Wired connection is recommended when using the following features. (Using the following features with a wireless connection can be affected by other devices using radio frequencies.)
 - Play contents from DLNA certified home media servers
 - Video streaming services (Netflix / VUDU / YouTube™)
 - Network update

Wired Connection

Networking equipment
(modem, etc.)

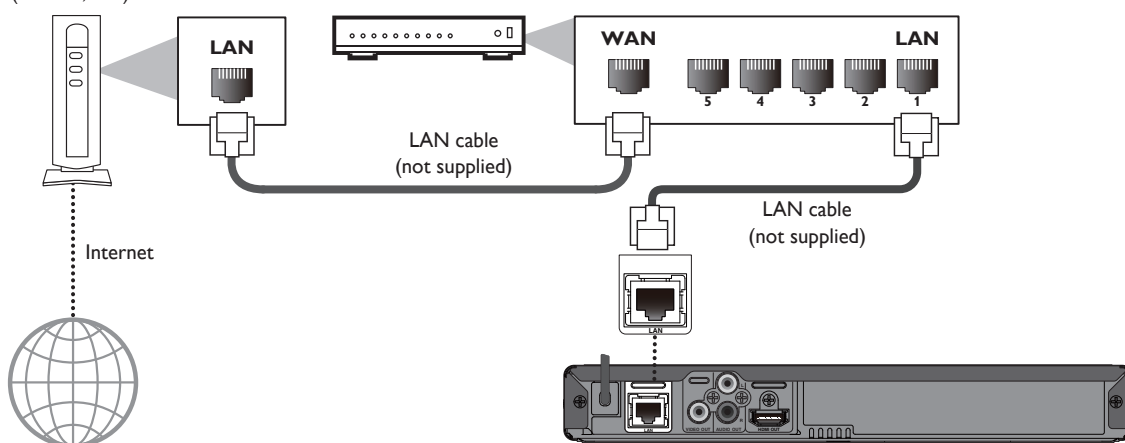

Caution

- Do not insert any cable other than a LAN cable to the LAN terminal to avoid damaging the unit.
- Do not connect your PC directly to the LAN terminal of this unit.

Note

- After you make a wired connection, set up necessary network settings.
(For network setting of wired connection, refer to “Wired Connection” on page 38.)
- If your modem does not have router functions, connect a wired router.
- If your modem has router functions but there is no vacant port, add a Switch / Hub.
- Please purchase shielded LAN cables at your local store and use them when you connect to network equipment.

continued on next page

■ Wireless Connection

Networking equipment
(modem, etc.)

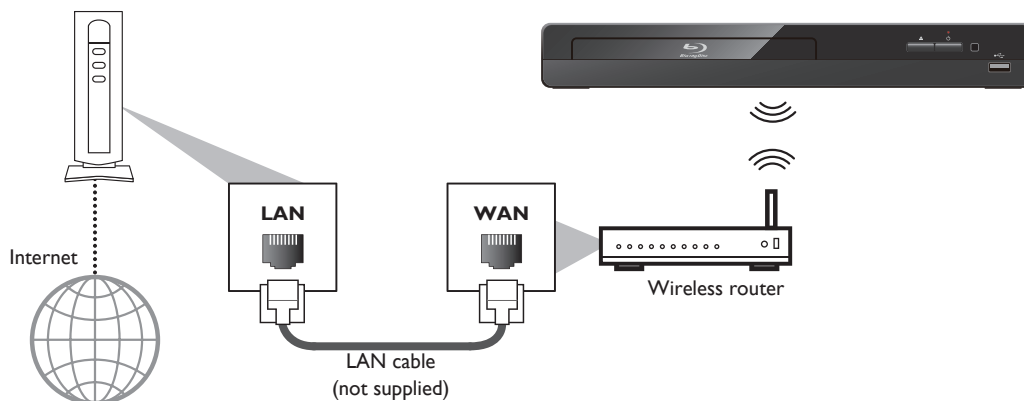

⊖ Note

- If using the wireless connection, refer to page 40 for “Wireless Connection” to configure the network setting.
- For a wireless router, use a router that supports the following IEEE 802.11 b/g/n specifications. (“n” is preferred type for a faster stable operation of the wireless network.)
- Our player supports infrastructure mode when using a wireless router. This unit does not support ad-hoc mode.
- Other radio devices or obstacles may cause interference to the wireless network connection.
- If you are experiencing signal issues with your wireless connection, please confirm that your wireless router is placed close enough to the unit.

5. BEFORE YOU START

5.1. Finding a Viewing Video Source Input on Your TV

After you have completed all of the connections to your TV, review the steps below.

1. Press [**⏻ (POWER-ON)**] to Turn On the unit.
2. Turn On your TV.
3. Please locate the Source / Input / AUX / Video button on TV's remote control. The button may vary on the TV brand and model. Once you have located the button, press until you see "Please Wait..." or the Initial Setup Menu on the Screen.

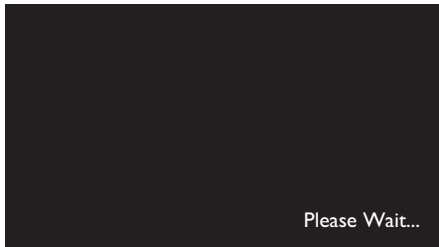

This is the correct viewing of the video Source Input.

- If the TV is connected by an HDMI cable, it may take a few moments for the opening picture to appear.
- If a certain amount of time has passed since you Turned On the unit, welcome screen only appears the first time you Turn On the unit.

5.2. Initial Setup

Please follow the instructions below to complete the initial setup.

1. While welcome screen is displayed, use [**▲ / ▼**] to select "Next", then press [**OK**].
2. Language setup screen will appear. Use [**▲ / ▼**] to select your language, then press [**OK**].



3. "Quick Start Mode" screen will appear. Use [**▲ / ▼**] to select the desired mode, then press [**OK**].
4. "Automatically check for latest software" screen will appear. Use [**▲ / ▼**] to select the desired mode, then press [**OK**].
5. Network setup screen will appear. Use [**▲ / ▼**] to select the desired mode, then press [**OK**].
 - If you select "Wired", refer to "Wired Connection" on page 38 for further operation.
 - If you select "Wireless", refer to "Wireless Connection" on page 40 for further operation.

continued on next page

■ How to Reset the OSD Language











You can reset the OSD language if you selected the wrong language.

1. Press **[HOME]** to display the Home Menu.
2. Use **[▲ / ▼ / ◀ / ▶]** to select “”, then press **[OK]**.
 - This item is “Settings” (English) / “Configuraciones” (Spanish) / “Paramètres” (French).
 - From here on, please select one of the following items you can find on screen:
3. Use **[▲ / ▼]** to select “Playback” (English) / “Reproducción” (Spanish) / “Lecture” (French), then press **[OK]**.
4. Use **[▲ / ▼]** to select “Language” (English) / “Idioma” (Spanish) / “Langue” (French), then press **[OK]**.
5. Use **[▲ / ▼]** to select your desired language, then press **[OK]**.
6. If the items that were set are displayed in your desired language, then press **[HOME]** to exit.

6. INFORMATION ON PLAYBACK

6.1. Information on Playback

■ Playable Discs and Files

Playable discs	Logos
Blu-ray Disc™ - BD-video - BD-RE* (ver. 2.1) (Recorded in BDMV format) - BD-R* (ver. 1.1 / 1.2 / 1.3) (Recorded in BDMV format) (Unfinalized disc may not be played back.)	
DVD-video	
DVD-RW (finalized video mode discs only)	
DVD-R (finalized video mode discs only)	
CD-DA (audio CD)	
CD-RW	 
CD-R	 
KODAK Picture CD	
DTS-CD	-

(*) Due to the intentional progression of the Blu-ray Disc™ format by its standard setting authority, the company cannot guarantee or warrant the playability of future extensions of the Blu-ray Disc™ format with this product.

Playable files	Media
AVCHD	DVD-RW/-R SD Memory Card using USB card reader / USB hub (not supplied)
MP3	BD-RE/-R DVD-RW/-R
JPEG	CD-RW/-R USB Memory Stick

Readable device	Playable files / data
USB Memory Stick	MP3, JPEG, picture-in-picture commentary, Subtitles or other extras for BD-ROM ver. 2 (Profile 2.0 / Profile 1.1)

⊖ Note

- This unit may not be able to play back discs recorded on PC's or other recorders.

continued on next page

EN - 17

■ Recommended Specifications

AVCHD

This unit cannot play back stand-alone AVCHD files (*.m2ts, *.mts or *.m2t) written to a DVD or copied to an SD Memory Card. The DVD or SD Memory Card containing AVCHD files must have a proper file and folder structure meeting AVCHD format specifications. Please use AVCHD compliant device / software to burn or copy AVCHD files to DVD or SD Memory Card. (Please refer to user manuals of your device / software for more information.)

MP3

- Sampling frequency: 32 kHz, 44.1 kHz or 48 kHz
- Constant bit rate: 112 kbps - 320 kbps (MP3)

JPEG

Resolution

- Upper limit: 2,560 × 1,900 dots (sub sampling is 4:4:4)
5,120 × 3,840 dots (sub sampling is up to 4:2:2)
- Lower limit: 32 × 32 dots
- Maximum file size of a picture: 12MB

■ Folder / File Number Limitations

Blu-ray Disc™, DVD and USB Memory Stick

- 999 folders (groups) and 9,999 files

CD

- 255 folders (groups) and 999 Tracks / Files

Caution / Note for USB Memory Stick

⚠ Caution

- Do not try to open or modify the USB Memory Stick.
- Do not touch the terminal surface with your fingers or any metals.

ⓘ Note

- This unit supports USB Memory Stick with FAT16 / FAT32 file system.
- This unit does not support NTFS file system.
- This unit may not read USB Memory Sticks formatted on a computer. If that is the case, please reformat the USB Memory Sticks on this unit and try again. Please note that all files stored on the USB Memory Stick will be erased upon format.
- Please keep the USB Memory Sticks in their cases when you are not using them.
- Some USB Memory Sticks may not work with this unit.
- This unit can read SD Memory Cards using a USB card reader (not supplied).
 - Readable cards: SD Memory Card (8 MB - 2 GB)
miniSD Memory Card (16 MB - 2 GB)
microSD Memory Card (256 MB - 2 GB)
SDHC Memory Card (4 GB - 32 GB)
miniSDHC Memory Card (4 GB - 8 GB)
microSDHC Memory Card (4 GB - 16 GB)
 - Readable files: AVCHD / MP3 / JPEG
- Depending on a USB card reader or USB hub, connected card or device may not be recognized.

continued on next page

■ Unplayable Media and Files

The following discs will not be played back on this unit.

- CD-ROM
- DVD-RAM
- DVD-audio
- HD DVD
- SDXC Memory Card
- unfinalized disc
- BD-RE (ver. 2.1) (Recorded in BDAV format)
- BDXL™
- Blu-ray Disc™ / DVD / CD / USB Memory Stick / SD Memory Card containing DivX® files
- Blu-ray Disc™ / USB Memory Stick that contains AVCHD files
- Blu-ray Disc™ / DVD hybrid disc (played back as a BD-video only)
- DVD-RW/-R recorded in non compatible recording format
- Super Audio CD - Only the sound on the CD layer can be heard. The sound on the high-density Super Audio CD layer cannot be heard.
- Playability of dual discs is not guaranteed.
- This unit cannot play back the disc contents protected by Windows Media™ Digital Rights Management (DRM).
- CD-I (compact disc-interactive)
- VSD (video single disc)
- video CD
- SVCD
- microSDXC Memory Card
- BD-RE (ver. 1.0)
- BD-R (ver. 1.1 / 1.2 / 1.3) (Recorded in BDAV format)

■ Region Codes

This unit has been designed to play back BD-video with region “A” and DVD-video with region “1” or “ALL”. You cannot play back BD-video or DVD-video that is labeled for other regions. Look for the symbols on your BD-video or DVD-video. If these region symbols do not appear on your BD-video or DVD-video, you cannot play back the disc on this unit. The letter or number inside the globe refers to region of the world. BD-video or DVD-video discs labeled for a specific region can only be played back on players with the same region code.

BD-video



DVD-video



■ Hint for Disc Playback

The contents of a disc are generally divided into sections or folders (group of titles / files) as shown below.

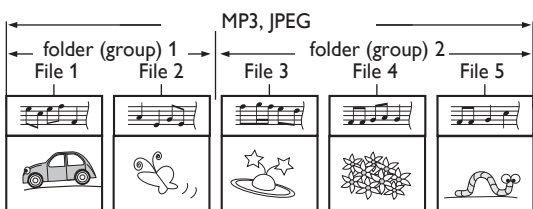
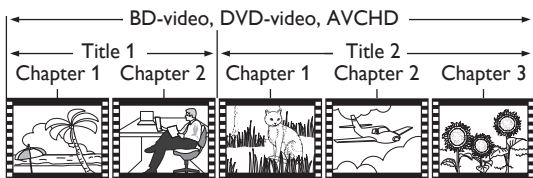

continued on next page

■ Description for Icons

[] : group (folder) icon

[] : music file icon

[] : movie file icon

[] : photo file icon

- “Folders” refers to the group of files.
- “Track” refers to the contents recorded on the audio CD.
- “Files” refers to the contents on a disc which are recorded in AVCHD, MP3, JPEG (including KODAK Picture CD) file format.

☰ Note

- Unrecognizable characters will be replaced with asterisks.

6.2. Guide to File List

■ Music File List

e.g.) MP3 mode

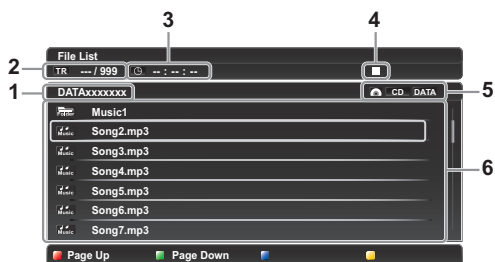

- | | |
|---|---|
| <ol style="list-style-type: none"> 1. Name of disc / USB Memory Stick 2. Current Track (File) number / Total number of Tracks (Files) 3. Elapsed playing time of the current Track | <ol style="list-style-type: none"> 4. Playback status symbol 5. Media type 6. Group (folder) / File list |
|---|---|

■ Picture File List

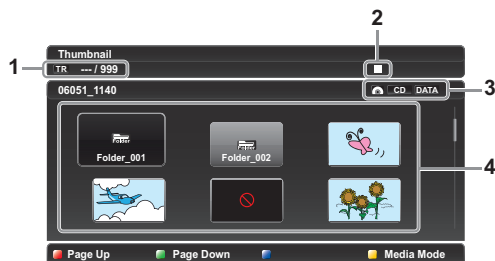

- | | |
|---|---|
| <ol style="list-style-type: none"> 1. Current File number / Total number of Files 2. Playback status symbol | <ol style="list-style-type: none"> 3. Media type 4. Group (folder) / File list (thumbnails) |
|---|---|

■ How to Navigate through the Track / File List

- For music file list, use [**▲** / **▼**] to move the highlight up and down. Press [**◀**] or [**RETURN**] to go back to the previous hierarchy.
- For picture file list, use [**▲** / **▼** / **◀** / **▶**] to move the highlight up, down, left and right. Press [**RETURN**] to go back to the previous hierarchy.
- To access the files in a Group (folder), select the desired Group (folder), then press [**OK**].
- Press [**RED**] or [**GREEN**] to change the page list up or down.
- Press [**YELLOW**] to go back to the file type (“Music” / “Photo” / “AVCHD”) selection screen.
- Press [**HOME**] to Exit.

6.3. How to Insert a Disc

1. Press [**▲** (**OPEN/CLOSE**)] to Open the disc tray.
2. Place the Disc on the disc tray with its label side facing up.
3. Press [**▲** (**OPEN/CLOSE**)] to Close the disc tray.
 - It may take a while to load the disc.

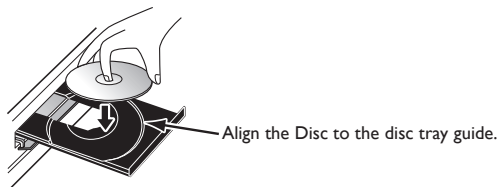

7. BASIC PLAYBACK

7.1. Playing Back a Disc



1. Insert a disc (refer to “How to Insert a Disc” on page 21).
 - For Blu-ray Disc™ / DVD / audio CD or a disc containing only one type of file, playback will start automatically. If not, press **[▶ (PLAY)]**.
 - Some discs may show a Title or a Disc Menu. In this case, refer to “Using the Title / Disc / Pop Menu” on page 25.
2. Select the type of the file you want to play back, then press **[OK]**.

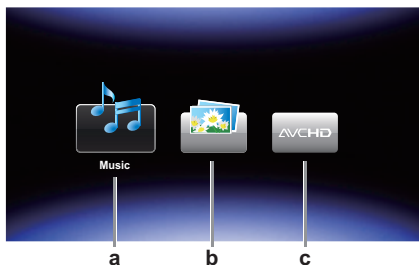

- a. For “Music”, Track / File list will be displayed. Select a Group (folder) or Track / File you want to play back then press **[▶ (PLAY)]** or **[OK]** to start playback.
 - Refer to “Music File List” on page 20 and “How to Navigate through the Track / File List” on page 21.
- b. For “Photo”, thumbnail screen will appear.
 - Refer to “Picture File List” on page 20 and “How to Navigate through the Track / File List” on page 21.
- c. For “AVCHD”, playback will start automatically.

To Skip to the next Title / Chapter / Track / File: Press **[▶▶ (SKIP)]**.

To Skip to the previous Title / Chapter / Track / File: Press **[◀◀ (SKIP)]**.

To Pause playback: Press **[|| (PAUSE)]**.

To Return to Normal playback: Press **[▶ (PLAY)]**.

To Stop playback: Press **[■ (STOP)]**.

Playback will be in Resume-On-Stop mode. To clear the resume information, press **[■ (STOP)]** again.

■ Resume-On-Stop Mode

Blu-ray Disc™ / DVD / AVCHD

When you press **[▶ (PLAY)]** next time, the playback will start from the point where it has been stopped.

Audio CD

Playback will start from the point where it is stopped next time you press **[▶ (PLAY)]**. If you press **[OK]** instead of **[▶ (PLAY)]**, playback will start from the beginning of the Track / File instead of resuming from the stop point.

MP3 / JPEG / KODAK Picture CD

Playback will start from the beginning of the current file next time you press **[▶ (PLAY)]** or **[OK]**.

⊖ Note

- Playback will also Stop and the Home Menu will appear when you press **[HOME]**.
- For BD-Java application, the Resume-On-Stop may not be available.
- If you press **[OK]** instead of **[▶ (PLAY)]**, playback can be started from the beginning of the disc even if it was in the Resume-On-Stop mode.
- Resume-On-Stop mode remains in effect even after Power is Turned Off, but will be cancelled once the disc is ejected.
- With regard to the multi-border BD-RE/-R, additionally recorded sections cannot be recognized.
- With regard to the multi-border DVD-RW/-R, additionally recorded sections may not be recognized.

⌘ Note for JPEG / KODAK Picture CD Playback

- Every press of [◀ / ▶] will turn the image by 90 degrees when an image is displayed.
- During playback, press [TOP MENU] to display thumbnail screen.
- This unit conforms to ver. 7.0 of KODAK Picture CD. For details of KODAK Picture CD, contact a shop that provides developing service for Kodak Inc.
- Some unplayable folders or files may be listed due to the recording status.
- High-resolution JPEG files take longer to be displayed.
- Progressive JPEG files (JPEG files saved in progressive format) cannot be played back on this unit.

7.2. Playing Back Contents from a USB Memory Stick

MP3

JPEG

You can play back MP3 / JPEG files stored on a USB Memory Stick. With the USB Memory Stick, you can also enjoy the following functions.

- Special additional contents for BD-ROM Profile 1 ver. 1.0.
(For more information about the special additional contents, refer to the instruction book that came with the disc.)
- BD-Live™ function (BD-ROM ver. 2 Profile 2.0). (For more information about BD-Live™, refer to page 28.)



1. Connect a USB Memory Stick.
2. Press [HOME].
3. Use [▲ / ▼ / ◀ / ▶] to select "USB Memory Stick", then press [OK].
4. Follow step 2 in "Playing Back a Disc" on page 22.

⚠ Caution

- Do not disconnect the USB Memory Stick or switch the unit to Standby mode while a content on the USB Memory Stick is being accessed. It may result in malfunction or loss of the stick's data.
- If you connect a USB Memory Stick or SD Memory Card via a USB card reader or USB hub, BD-ROM data will be written onto the first connected card or device. Connecting a USB Memory Stick directly to this unit is recommended.
- Occasionally, SD Memory Cards / Micro SD Memory Cards will not be recognized when using certain Adapters. In such cases, try a different USB Adapter.

⌘ Note

- When connecting more than two USB Memory Sticks to a USB Hub, this unit may fail to recognize them. In such cases, disconnect the USB Hub from the unit then reconnect it, or use less USB Memory Sticks at a time.
- The resume information will be cleared when;
 - [■ (STOP)] is pressed while in the Resume-On-Stop mode.
 - the USB Memory Stick is disconnected.
 - the unit is switched to Standby mode.
- Do not delete the folders or files on the USB Memory Stick with your computer. This unit may not read USB Memory Sticks formatted on a computer.
- If a folder or file name includes one of the following unrecognizable characters, the folder or file name may not be displayed correctly.
 - Unrecognizable characters: ., " = + [] ; / \ : | ¥
- This unit can read MP3 / JPEG files and AVCHD on an SD Memory Card by using USB card reader / USB hub (not supplied).

7.3. Playing Back Video / Music / Photo from DLNA Certified Home Media Servers



On this unit, you can play video, music and photo files stored on DLNA certified media servers connected to your home network. In order to use this feature, you must connect this unit to your local network. (not guaranteed to work with a wireless environment)

- For details, refer to the user manual of the DLNA certified device.
1. Follow steps 1 and 2 in “Before Using Network Features” on page 34.
 2. Start DLNA home media servers in your home network.
 3. Press **[HOME]**.
 4. Use **[▲ / ▼ / ◀ / ▶]** to select “Home Network” then press **[OK]**.
 - This unit will start loading the Media Server list.
 - To cancel loading, press **[■ (STOP)]**.
 - To reload the Media Server list, press **[YELLOW]**.
 5. After loading, Media Server list will appear. Select a Media Server you want to access, then press **[OK]**.
 6. File list of the selected Media Server will appear. Select a file you want to play back, then press **[▶ (PLAY)]** or **[OK]** to start playback.
 - For operations in file list, refer to “Guide to File List” on page 20.



To control playback, use following buttons.

Button	Action
▶▶ (SKIP)	Skip to next song, file, etc. (For video files, playback will be step by step each time the button is pressed in pause mode.)
▶▶ (FORWARD) ◀◀ (REVERSE)	During playback, press to Fast Forward or Fast Reverse the playback. (For video files, playback will be slow forward by pressing [▶▶ (FORWARD)] in pause mode.)
 (PAUSE)	Pause the playback.
▶ (PLAY)	Start or return to Normal playback.
■ (STOP)	Stop the playback. (For video files, playback will be in Resume-On-Stop mode.) Resume-On-Stop mode for video files Playback will start from the point where it is stopped next time you press [▶ (PLAY)] . If you press [OK] instead of [▶ (PLAY)] playback will start from the beginning of the file instead of resuming from the last stop point.
TOP MENU	Goes to the root directory of the file list.

continued on next page

Note

- For the Media Server list, maximum of 10 servers can be displayed.
- The system can recognize up to 2,000 files (including folders).
- The 10th and deeper hierarchies cannot be displayed.
- This unit supports the following formats. (Formats other than listed below cannot be recognized.)
 - Video : MPEG 1, MPEG 2 PS, MPEG 2 TS / TTS
 - Music : LPCM, MP3
 - Photo : JPEG (Images over 1024 x 768 pixel are not included in the warranty specification.)
- Unplayable files in the Media Server will not be displayed in the file list.
- For some files, playback is not available even if displayed in the file list.
- In order to play back the contents from Media Servers, the player and the media servers must be connected to the same local area network.
- Compatibility and available playback function may differ depending on the Media Server.
- If you select a photo file in step 6 on page 24, the selected photo will display and go to the next photo within 10 seconds.
- For a folder that only contains photo files, thumbnails may be displayed.
- For photo files, every press of [◀ / ▶] will turn the image by 90 degrees when an image is displayed.
- The quality of the playback picture or sound depends on the speed/signal strength condition of your network.
- It may take a few moments while loading a file when the unit is going to a new folder / file location during playback.

7.4. Using the Title / Disc / Pop Menu



Some BD-videos, DVD-videos or AVCHD files may contain a Title Menu which describes the contents of the disc, or a Disc Menu which guides you through the available functions on the disc.

With such discs, a Title Menu or a Disc Menu may appear automatically when you insert the disc. Otherwise, press **[TOP MENU]** or **[POP MENU/MENU]** to call up the menu. Refer to the disc's manual on how to navigate through the menu.

Note

- Menus vary among discs. Refer to the information accompanying the disc for details.
- **[TOP MENU]** or **[POP MENU/MENU]** may not work with some discs.

8. SPECIAL PLAYBACK

8.1. Fast Forward / Fast Reverse



1. During playback, press **[▶▶ (FORWARD)]** repeatedly for Fast Forward.
During playback, press **[◀◀ (REVERSE)]** repeatedly for Fast Reverse.
2. Press **[▶ (PLAY)]** to return to Normal playback.

⊖ Note

- For Blu-ray Disc™, DVD and AVCHD, speed changes at 5 different levels.
- For audio CD, MP3 and Video / Audio files on DLNA Media Server, speed changes at 3 different levels.
- For some video / music files on a DLNA Media Server, Fast Forward / Fast Reverse may not function.
- For audio CD and MP3, Fast Forward / Fast Reverse search between different files are not available.

8.2. Slow Forward Playback



1. During playback, press **[⏸ (PAUSE)]**. Then press **[▶▶ (FORWARD)]**.
Every time you press **[▶▶ (FORWARD)]**, the playback speed changes at 3 different levels.
2. Press **[▶ (PLAY)]** to return to Normal playback.

⊖ Note

- Slow Reverse is not available.
- For some video files on a DLNA Media Server, Slow Forward may not function.
- Set “Still Mode” to “Field” in “Video Out” menu if pictures in the Slow Forward playback mode are blurred.

8.3. Step by Step Playback



1. In pause mode, press **[▶▶ (SKIP)]** repeatedly.
Every time you press **[▶▶ (SKIP)]**, playback will advance one step at a time.
2. Press **[▶ (PLAY)]** or **[⏸ (PAUSE)]** to return to Normal playback.

























⊖ Note

- Step by step reverse is not available.
- Set “Still Mode” to “Field” in “Video Out” menu if pictures in the step by step playback mode are blurred.

8.4. Repeat Playback

Available repeat functions vary depending on the disc.

1. During playback, press **[REPEAT]**.
2. Use **[▲ / ▼]** to select the desired repeat mode.
 - You can also change the repeat mode by pressing **[REPEAT]** repeatedly.

REPEAT MODE	AVAILABLE MEDIA
Chapter Repeat The current Chapter will be played back repeatedly.	  
Title Repeat The current Title will be played back repeatedly.	  
Track Repeat The current Track or File will be played back repeatedly.	     
All Repeat All Tracks in the media will be played back repeatedly.	
Group Repeat The current Group (folder) will be played back repeatedly.	    
Random Repeat (Audio CD) Repeats the random playback.	
Random Repeat (MP3 / JPEG) Repeats the random playback in a folder.	    

3. Press **[RETURN]** to Exit.

⊖ Note

- The repeat setting will be cancelled when you stop playback.
- When the repeat setting is set for an MP3 or JPEG folder (file), the repeat setting will be cancelled if you select another MP3 or JPEG folder (file) to play back.
- For some video / music / photo files on a DLNA Media Server, repeat playback may not function.
- You can also use the Repeat function from the Play Menu. Play Menu can be called up by pressing **[MODE]**.

8.5. Slide Show

JPEG

1. Follow steps 1 and 2 in “Playing Back a Disc” on page 22.
2. Open the folder which contains the desired JPEG files.
3. Use **[▲ / ▼ / ◀ / ▶]** to select a desired file to be played back, then press **[▶ (PLAY)]** or **[OK]**.
 - An image will be played back from the selected file and go to the next one in turn every 10 seconds.
4. Press **[■ (STOP)]** to Stop playback.

To return to the first item: Press **[TOP MENU]**
To return to the file played last: Press **[POP MENU/MENU]**

⊖ Note

- Large-size JPEG files take a few moments to be displayed.

8.6. PiP (BONUSVIEW™) Setting



Some BD-videos have the PiP function which enables you to display the Secondary Video in the Primary Video.

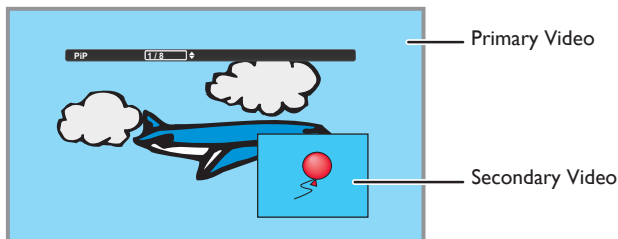

1. During playback, press **[MODE]** to display the Play Menu.
2. Use **[▲ / ▼]** to select “PiP” then press **[OK]**.
 - PiP information will appear.
3. Use **[▲ / ▼]** to select the Secondary Video you want to show.
 - The Secondary Video will be displayed with the Secondary Audio.
 - Use **[◀ / ▶]** to switch between current setting and “Off”.
4. Press **[RETURN]** to Exit.
 - How to select the Secondary Audio output, refer to “Switching Audio Soundtrack” on page 31.

⊞ Note

- Not that the secondary video will be displayed at any time during playback. Depending on the scene, the secondary video may not be available.

8.7. Enjoying BD-Live™ Discs Using Internet



You can enjoy BD-Live™ which enables you to use interactive features when the unit is connected to the Internet.

Examples of BD-Live™ features:

- Online access to additional content such as movie trailers, subtitles, BD-Java applications, etc.
- While downloading, special video data may be played back.
 - **Service and functions differ depending on the disc. Follow the instructions given by the disc when using the BD-Live™ function.**
 - **Connect a USB Memory Stick with at least 1 GB of available memory before using BD-Live™ features on a Blu-ray Disc™.**
 - **Do not disconnect the USB Memory Stick while using BD-Live™ features.**

⊞ Note

- You must connect the unit to the Internet and set up necessary settings in order to use BD-Live™.
- For the network connection, refer to “Connection to the Network” on page 13.
- For the network setup, refer to “Network Connection” on page 38.
- For certain discs, “BD-Live setting” under “Network” under “Settings” may need to be changed.
- Depending on your connection environment, it may take a few moments to connect to the Internet or the Internet may not be connected. Refer to “TROUBLESHOOTING” on page 48.
- Some discs with BD-Live™ function require memory when playing back the content. If you cannot play back a disc with BD-Live™ function, connect a USB Memory Stick (1GB or more of available memory) which is formatted on this unit.
- Not all BD-video discs have a BD-Live™ content. To enjoy the BD-Live™ features, please use discs with a BD-Live™ content.

⊞ Note for AACs Online

- The player or disc ID may be sent to the content provider when playing back a disc with BD-Live™ function.
- If you save your viewing history on the server by using these ID's, you will be introduced to other similar movies.
- You can save game score histories.

8.8. Title / Chapter Search



■ Using [◀◀ (SKIP)] / [▶▶ (SKIP)]

1. During playback, press [▶▶ (SKIP)] to Skip the current Title or Chapter and move to the next.

The Title or Chapter will move forward one at a time.

- If there is no Chapter in one Title, the current Title may be Skipped.

To go back to the beginning of the current Title or Chapter, press [◀◀ (SKIP)].

Press [◀◀ (SKIP)] repeatedly to go to the previous Title or Chapter. The Title or Chapter may move backward one at a time.

■ Using [MODE]

1. During playback, press [MODE] to display the Play Menu.
2. Use [▲ / ▼] to select “Search”, then press [OK].
3. Use [▲ / ▼] to select “**TT**” or “**CHP**”, then press [OK].

e.g.) Blu-ray Disc™



4. Use [▲ / ▼ / ◀ / ▶] to select the Title / Chapter number, then press [OK].

Playback will start from the beginning of the Title / Chapter.

■ Using [the NUMBER buttons] (Direct Search)

Chapter Search

During playback of a Title, enter the Chapter number you want to search using [the NUMBER buttons].

Playback of the Chapter will start in a few seconds.

⊖ Note

- As for the BD-video, how it performs will be strongly determined by the disc, and may not perform as described.

8.9. Track / File Search



■ Using [◀◀ (SKIP)] / [▶▶ (SKIP)]

1. During playback, press [▶▶ (SKIP)] to Skip the current Track or File and move to the next.

The Track / File will move forward one at a time. To go back to the beginning of the current Track / File, press [◀◀ (SKIP)].

Press it repeatedly to go to the previous Track / File. The Track / File will move backward one at a time.

■ Using [MODE]

1. During playback, press [MODE] to display the Play Menu.
2. Use [▲ / ▼] to select “Search”, then press [OK].
 - For MP3 / JPEG files, skip to step 4.
3. Use [▲ / ▼] to select “**TR**”, then press [OK].
4. Use [▲ / ▼] to select the Track number, then press [OK].

Playback will start from the beginning of the Track.

8.10. Time Search



1. During playback, press **[MODE]** to display the Play Menu.
2. Use **[▲ / ▼]** to select “Search”, then press **[OK]**.
 - For video files on DLNA server, skip to step 4.
3. Use **[▲ / ▼]** to select “”, then press **[OK]**.

e.g.) Blu-ray Disc™

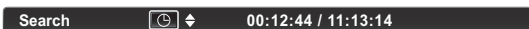

4. Use **[▲ / ▼]** or **[the NUMBER buttons]** to enter the time count you want to jump to, then press **[OK]**.
e.g.) Entering 1 hour 45 minutes and 15 seconds.



Playback will start from the desired time entered.

Note

- For some video files on DLNA Media Server, time search may not function.

8.11. Switching Subtitles

Some video materials may have subtitles in one or more languages. For commercially available discs, the supported languages can be found on the disc case. Follow the steps below to switch the Subtitle language during playback.



1. During playback, press **[SUBTITLE]**.
2. Use **[▲ / ▼]** to select “Primary”, “Secondary” or “Style”, then press **[OK]**.
 - You can also change the setting by pressing **[SUBTITLE]** repeatedly when the highlight is on “**Primary**”.

“**Primary**”: Sets the Subtitle for the Primary Video.

“**Secondary**”: Sets the Subtitle for the Secondary Video.

“**Style**”: Sets Style of the Subtitle.

3. Use **[▲ / ▼]** to select your desired Subtitle or Style.

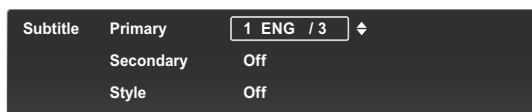

- Use **[◀ / ▶]** to switch between current Subtitle setting and “Off”.
4. Press **[RETURN]** repeatedly to Exit.



1. During playback, press **[SUBTITLE]**.
2. Use **[▲ / ▼]** to select your desired Subtitle.
 - You can also change the setting by pressing **[SUBTITLE]** repeatedly.



- Use **[◀ / ▶]** to switch between current Subtitle setting and “Off”.
3. Press **[RETURN]** to Exit.

continued on next page

Note

- Some discs will only allow you to change the subtitles from the Disc Menu or Pop Menu. Press **[TOP MENU]** or **[POP MENU/MENU]** to display the Disc Menu or Pop Menu.
- If the disc has no Subtitle language or Subtitle Style, “Not Available” will be displayed on the TV screen.
- During playback of the Secondary Video, the Primary Subtitle setting is not available except when there is no Subtitle for the Secondary Video.
- You can also change the Subtitle setting from the Play Menu. Play Menu can be called up by pressing **[MODE]**.

8.12. Switching Audio Soundtrack

When playing back video material recorded with two or more soundtracks (these are often in different audio languages or audio formats), you can switch them during playback. For Blu-ray Disc™, available audio varies depending on “BD Audio Mode” setting. Refer to page 35.



1. During playback, press **[AUDIO]**.
2. Use **[▲ / ▼]** to select “Primary” or “Secondary”, then press **[OK]**.
 - You can also change the setting by pressing **[AUDIO]** repeatedly when the highlight is on “Primary”.

“Primary”: Sets the audio for the Primary Video.
“Secondary”: Sets the audio for the Secondary Video.
3. Use **[▲ / ▼]** to select your desired audio stream channel.

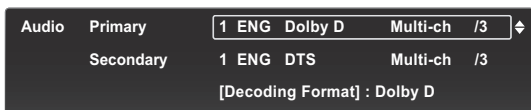

- For “Secondary”, use **[◀ / ▶]** to switch between current audio setting and “Off”.
4. Press **[RETURN]** repeatedly to Exit.



1. During playback, press **[AUDIO]**.
2. Use **[▲ / ▼]** to select your desired audio stream channel.
 - You can also change the setting by pressing **[AUDIO]** repeatedly.

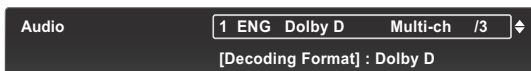

- For audio CD, you can select following options.
 - “Stereo”**: Both right and left channels are active (stereo).
 - “L-ch”**: Only left channel is active.
 - “R-ch”**: Only right channel is active.
3. Press **[RETURN]** to Exit.

Note

- The Secondary Audio will not be output when the Secondary Video is not displayed or when “BD Audio Mode” is set to “HD Audio Output”. (For some Blu-ray discs, Secondary Audio will be output even when Secondary Video is Off.)
- The sound mode cannot be changed during playback of discs not recorded in multiple audio mode.
- Some discs allow changing the audio language setting from Disc Menu. (Operation varies depending on the discs. Refer to the manual accompanying the disc.)
- **[AUDIO]** may not work on some discs with multiple audio streams or channels (e.g. DVDs that allow changing audio setting on the disc menu).
- If the disc has no audio language, “Not Available” will be displayed on the TV screen.
- For DTS-CD (5.1 music disc), selecting audio streams or channels is not available.
- You can also change the Audio setting from the Play Menu. Play Menu can be called up by pressing **[MODE]**.

8.13. Switching Camera Angles



Some BD-videos and DVD-videos contain scenes which have been shot simultaneously from various angles. You can change the Camera Angle when  appears on the TV screen.

1. During playback, press **[ANGLE]**.
2. Use **[▲ / ▼]** to select your desired angle.
 - You can also change the setting by pressing **[ANGLE]** repeatedly.
 - The selected Angle will be displayed on the display bar at the top of the TV screen.
3. Press **[RETURN]** to Exit.

Note

- If “Angle Icon” setting is set to “Off”,  will not appear on the TV screen.
- You can also change the Camera Angles from the Play Menu. Play Menu can be called up by pressing **[MODE]**.

8.14. Black Level



You can adjust the Black Level setting to make the black parts of the pictures as bright as you prefer. You can select “On” or “Off”.

1. During playback, press **[MODE]** to display the Play Menu.
2. Use **[▲ / ▼]** to select “Black Level”, then press **[OK]**.
3. Use **[▲ / ▼]** to select your desired setting.

e.g.) Blu-ray Disc™



Black Level On ↕

“On”: Makes the dark parts blacker with additional contrast and brightness.

“Off”: Shows the original picture as recorded.

4. Press **[RETURN]** to Exit.

Note

- This function can also be set during Netflix / VUDU / YouTube™ playback.
- The setting will remain the same even if the unit is switched to Standby mode.
- “Black Level” is not effective under the following conditions.
 - When the picture is output from HDMI OUT jack.

8.15. Noise Reduction



Reduces the noise of the playback picture.

1. During playback, press **[MODE]** to display the Play Menu.
2. Use **[▲ / ▼]** to select “Noise Reduction”, then press **[OK]**.
3. Use **[▲ / ▼]** to select your desired setting.

e.g.) Blu-ray Disc™



“On”: Activates noise reduction.

“Off”: Deactivates noise reduction.

4. Press **[RETURN]** to Exit.

⊖ Note

- This function can also be set during Netflix / VUDU / YouTube™ playback.
- The setting will remain the same even if the unit is switched to Standby mode.

8.16. CLEAR+



CLEAR+ enhances the contrast of the picture and makes edges crisp. It is effective especially for DVD's.

1. During playback, press **[MODE]** to display the Play Menu.
2. Use **[▲ / ▼]** to select “CLEAR+”, then press **[OK]**.
3. Use **[▲ / ▼]** to select your desired setting.

e.g.) Blu-ray Disc™



“On”: Gives low-definition videos high-definition like picture quality.

“Off”: Shows the original picture as recorded.

4. Press **[RETURN]** to Exit.

⊖ Note

- This function can also be set during Netflix / VUDU / YouTube™ playback.
- This operation is prohibited during Fast Forward, Fast Reverse, Slow Forward playback and pause mode.
- Pictures may appear whiter depending on the material and the connected TV. In this case, turn “CLEAR+” Off.
- “CLEAR+” is not effective under the following conditions.
 - When the material is in 1080p24 which is commonly used in Blu-ray discs.

9. NETWORK FEATURES

9.1. Before Using Network Features

Please follow the instructions below before using network features.

1. Connect this unit to the Internet.
 - Refer to “Connection to the Network” on page 13.
2. Set up the necessary network connection settings.
 - Refer to “Network Connection” on page 38.
3. Press **[NET APP]** to display the network application menu.
4. Use **[▲ / ▼ / ◀ / ▶]** to select the desired application, then press **[OK]**.
 - For the first time only, “Network Service Disclaimer” screen will appear. After confirming the content, use **[▲ / ▼]** to select “Agree” then press **[OK]**.
5. Press **[HOME]** to Exit.

Note

- The Network Service Disclaimer is displayed when first using a network service and its acceptance is applied to all network services.

9.2. Information on Network Services

For detailed information on the third-party Internet services, please visit each service provider’s website:

Netflix : <http://www.netflix.com/HowItWorks>

To activate Netflix, this unit requires a PC connected to the Internet. On your PC, please visit their activation website (see above) then enter the activation code displayed on the TV screen.

- Support website : <http://www.netflix.com/support>
Support number : 1-866-716-0414

VUDU : http://www.vudu.com/product_overview.html

- Support number : 1-888-554-VUDU (8838)
E-mail support : support@vudu.com

YouTube™ : http://www.youtube.com/device_support

10. LIST OF SETTINGS

In “Settings”, you can customize various kinds of settings as you prefer.

Refer to the following instructions to navigate through the Setup Menu.

1. Press **[HOME]** to access the Home Menu.
2. Use **[▲ / ▼ / ◀ / ▶]** to select “Settings”, then press **[OK]**.
3. Use **[▲ / ▼]** to select the desired Category, then press **[OK]**.
4. Use **[▲ / ▼]** to move up and down the list to select Menus / Options.
5. To make a selection or to access options of an item, select the desired item, then press **[OK]**.
 - To go back to the previous screen, press **[RETURN]**.
6. Press **[HOME]** to Exit.

Refer to the following table for the types of settings you can customize.

The item highlighted in gray is the default setting.

Category	Menus / Options	
Video Out	TV Aspect	4:3 Letter Box
		4:3 Pan & Scan
		16:9 Wide
		16:9 Squeeze
	Progressive Mode	Auto
		Video
Still Mode	Auto	
	Field	
	Frame	
Audio Out	DRC	Auto
		On
		Off
	BD Audio Mode	Mix Audio Output
		HD Audio Output
Network	Network Connection	Start
		Connection Test
	Network Status	
	Wireless Status	
	Disclaimer	
	Digital Rights Mgmt	
	Netflix ESN	
	Deactivation	Netflix
		VUDU
		YouTube
	BD-Live setting	Allow
Limited Allow		
Prohibit		
HDMI	fun-Link (HDMI CEC)	On
		Off
	Video Resolution	Auto
		480p
	Deep Color	Auto
		Off
	Audio Output	Bitstream
		LPCM
Off		

continued on next page

Category	Menus / Options		
Playback	Language	Auto	
		English	
		Español	
		Français	
	Audio	Original	
		Bulgarian	Italian
		Chinese	Japanese
		Czech	Korean
		Danish	Norwegian
		Dutch	Polish
		English	Portuguese
		Finnish	Romanian
		French	Russian
		German	Slovak
		Greek	Spanish
		Hungarian	Swedish
		Icelandic	Turkish
		Irish	Other
	Subtitle	Off	
		Bulgarian	Italian
		Chinese	Japanese
		Czech	Korean
		Danish	Norwegian
		Dutch	Polish
		English	Portuguese
		Finnish	Romanian
		French	Russian
		German	Slovak
		Greek	Spanish
		Hungarian	Swedish
		Icelandic	Turkish
		Irish	Other
	Disc Menu	Bulgarian	Italian
		Chinese	Japanese
		Czech	Korean
		Danish	Norwegian
		Dutch	Polish
		English	Portuguese
		Finnish	Romanian
		French	Russian
		German	Slovak
		Greek	Spanish
		Hungarian	Swedish
		Icelandic	Turkish
		Irish	Other
		BD Rating Level	Off
		Age Setting	
DVD Rating Level	Off		
	8 [Adult]	4 [PG-13]	
	7 [NC-17]	3 [PG]	
	6 [R]	2 [G]	
	5 [PGR]	1 [Kid Safe]	
Password Change			
Angle Icon	On		
	Off		

continued on next page

Category	Menus / Options	
Others	Software Update	Disc
		Network
		USB Memory Stick
	Automatically check for latest software	On
		Off
	Quick Start Mode*	On
		Off
	Product Info	
	Initialize	Reset Settings
		Format USB Memory Stick
		(Unit) Erase Saved BD-ROM Data
		(USB Memory Stick) Erase Saved BD-ROM Data
		Reset Network Settings
	OSS	

* When "Quick Start Mode" is set to "On", power consumption during Standby mode will increase.

11. SETUPS

11.1. Network Connection

HOME → "Settings" → "Network" → "Network Connection"

Perform the network connection setup in order to use the network features, such as BD-Live™, DLNA home media server, Netflix, VUDU, YouTube™ and the network update function.

■ Connection Test

After you enable a network connection or change the network settings, always perform the connection test to check to see if the connection is correctly made.

1. Use [▲ / ▼ / ◀ / ▶] to select "Settings" in the Home Menu, then press [OK].
2. Use [▲ / ▼] to select "Network", then press [OK].
3. Use [▲ / ▼] to select "Network Connection", then press [OK].
4. Use [▲ / ▼] to select "Connection Test", then press [OK].
 - Connection test will automatically start. The test result will appear right after the test finishes.
 - "Connecting...": The test is in progress.
 - "Pass": Connection test is successfully completed.
 - "Failed": Connection test failed. Check the connection settings.
5. If the connection test passes, press [OK].

ⓘ Note

- If the connection test passes, you are ready to use BD-Live™, DLNA home media server, Netflix, VUDU, YouTube™ and network update function, using the Internet without making any additional settings.
- If the connection test fails, you may need to check your router settings and make sure the physical connection is secure. If you need the MAC address of this unit to complete your router settings, you can view it on the "Network Status" / "Wireless Status" screen (refer to page 42).
- When connecting this unit directly to a modem for the first time or connecting it to a modem which was previously connected to any other network device (e.g. a router, PC, etc.), you may have to power cycle the modem (unplug the modem's and/or router's AC plug from its AC outlet for 30 seconds and then plug it back in), this may reset the settings in the modem. If you have a telephone/Internet modem with your cable service then you may have to use its reset button or remove the backup battery to reset this type of modem.
- If "Home Network" failed on the connection test, this unit is not connected to the router / local network. In this case, you cannot use your DLNA home media server(s).
- If "Internet" failed on the connection test, this unit is not connected to the Internet. In this case, you cannot use the BD-Live™ function or access the network services, such as Netflix. (You can use your DLNA home server(s) as long as "Home Network" passed.) Please confirm the router settings or contact your ISP (Internet Service Provider) for troubleshooting assistance.

■ Wired Connection

Select "Wired" if you made a wired connection and set the setting to "Auto" or "Manual", in accordance with your network environment.

Auto (Wired)

Select "Auto" to set the network setting automatically.

1. Use [▲ / ▼ / ◀ / ▶] to select "Network Setup" in the Home Menu, then press [OK].
2. Use [▲ / ▼] to select "Wired", then press [OK].
3. Use [▲ / ▼] to select "Auto", then press [OK].
 - The unit will automatically start the connection test. The test result will appear right after the test finishes.
4. "Network connection succeeds." will be displayed. Select "End" then press [OK] to complete the settings.

continued on next page



Manual (Wired)

In the following cases, select “Manual” to set each setting as necessary.

- When connection test failed with the setting of “Auto”.
 - When instructed by your Internet service provider to make specific settings in accordance with your network environment.
1. Follow steps 1 and 2 in “Auto (Wired)” on page 38.
 2. Use [▲ / ▼] to select “Manual”, then press [OK].
 3. Use [▲ / ▼] to select “IP Address”, then press [OK].
 4. “IP Address” setting screen will appear. Enter an IP address using the cursor buttons and the NUMBER buttons.



- Enter an IP address after checking the specifications of your router.
 - If an IP address is unknown, check the IP address of other devices (e.g. PC connected with a LAN cable). Then, in the furthest cell to the right, assign a different number from those other devices.
5. Use [▲ / ▼ / ◀ / ▶] to select “OK”, then press [OK].
 6. Configure “Subnet Mask”, “Default Gateway”, “Primary DNS” and “Secondary DNS” in the same manner.
 - Enter the DNS addresses provided by your Internet service provider.
 - If the DNS address is unknown, check the DNS address of other devices (e.g. PC connected via LAN cable) and assign the same DNS address.

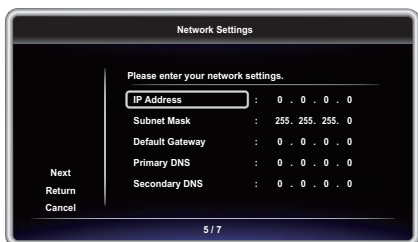

7. Use [▲ / ▼ / ◀ / ▶] to select “Next”, then press [OK].
8. Use [▲ / ▼] to select “Yes” or “No” for proxy server, then press [OK].
 - If you use a proxy server, select “Yes” then press [OK] to go to the next step.
 - If you do not use a proxy server, select “No” then press [OK] to go to step 12.
9. “Proxy Address” setting screen will appear. Enter a proxy address using the cursor buttons, the NUMBER buttons and the color keys.

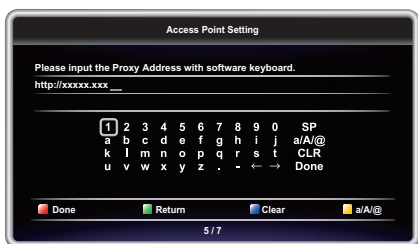

[▲ / ▼ / ◀ / ▶]:	Used to move through the menu.
[the NUMBER buttons]:	Enter number (remote control).
[OK]:	Enter the selected setting.
[RED]*:	Confirm and set the network setting.
[GREEN]:	Exit / Cancel network setting.
[BLUE]*:	Clear the enter number or letters.
[YELLOW]*:	Switch between different characters abc (lower case), ABC (uppercase), and @!/? (special characters).

* These buttons can be used in other network settings.

10. Press **[RED]** to go to the “Proxy Port” setting screen.

11. Enter the proxy port number using the NUMBER buttons, then select “OK”, then press **[OK]**.

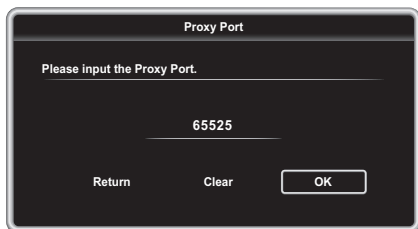

12. Connection test confirmation screen will appear. Select “Yes”, then press **[OK]** to start the connection test. The test result will appear right after the connection test finishes.

13. “Network connection succeeds.” will be displayed. Select “End” then press **[OK]** to complete the settings.

⊖ Note for “IP Address”, “Subnet Mask”, “Default Gateway”, “Primary DNS” and “Secondary DNS”

- The range of input numbers is between 0 and 255.
- If you enter a number larger than 255, the number will automatically be reset to 255.
- When you enter a wrong number, select “Clear” to clear the incorrect number. (The number will be set to “0”)
- If you want to enter a 1 or 2-digit number in one cell, press **[▶]** to move on to the next cell.

⊖ Note for “Proxy Address” and “Proxy Port”

- The range of input numbers for the port number is between 0 and 65535. (If you enter a number larger than 65535, it will be regarded as 65535.)
- For proxy port, certain ports might be closed, blocked or unusable depending on your network environment.
- When the settings are changed, the network connection may be disabled depending on the device.

■ Wireless Connection

If you connect this unit to a wireless network, select “Wireless” and set up necessary settings.

Please make a note of your SSID (Service Set Identifier — wireless network name) and its WEP* / WPA / WPA2 key before proceeding with the setup.

* “Easy Connect (WPS)” cannot be used when the Security protocol is set to “WEP”.

Easy Connect (WPS)

Push Button Method

You can set up a Wireless connection quickly.

(“Push Button Method” is only available when your router supports it. For details, please refer to the user manual of your wireless router.)

Please confirm your wireless router has a PBC* (Push Button Configuration) button.

1. Use **[▲ / ▼ / ◀ / ▶]** to select “Network Setup” in the Home Menu, then press **[OK]**.
2. Use **[▲ / ▼]** to select “Wireless”, then press **[OK]**.
3. Use **[▲ / ▼]** to select “Easy Connect (WPS)”, then press **[OK]**.
4. Use **[▲ / ▼]** to select “Push Button Method”, then press **[OK]**.

Then within 2 minutes push the PBC* (Push Button Configuration) button on your wireless router.

* PBC button may be called WPS (Wi-Fi Protection System) button on your wireless router.

- The unit will automatically start the Connection test. The test result will appear right after the test finishes.



5. “Network connection succeeds.” will be displayed. Select “End” then press **[OK]** to complete the settings.

Note

“Easy Connect (WPS)” cannot be used when the Security mode of your Access Point is set to “WEP”. Please try either method below.

- Connect the unit to the Access Point using “Auto Scan” or “Manual” mode.
 - Change the Access Point's security mode from “WEP*” to “WPA” or “WPA2”.
- * “WEP” is not recommended to be used due to its “Major security flaws”. Change the Security protocol on the wireless router to “WPA” or “WPA2 (recommended)” mode. (For Access Point configuration, please consult the user manual of your wireless router or manufacturer.)

Auto Scan (Wireless)

1. Follow steps 1 and 2 in “Push Button Method” on page 40.
2. Use [▲ / ▼] to select “Auto Scan”, then press [OK].
 - This unit will automatically start searching for nearby wireless networks.
3. The search result will be displayed. Use [▲ / ▼] to select an appropriate SSID, then press [OK].
 - If you select an SSID with “🔒” (no password is required), please go to step 5.

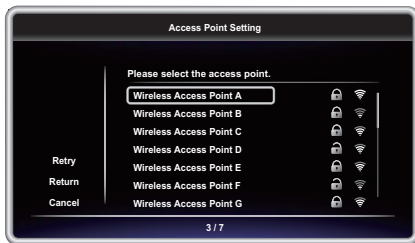

4. “WEP / WPA / WPA2 Key” entry screen will appear. Enter the WEP/WPA/WPA2 password of the selected wireless network using Cursor buttons, Number buttons and Color keys, then press [RED] to confirm the password.
 - If you do not know the WEP/WPA/WPA2 key for your wireless network, please confirm the sticker on the router.
 - The WEP / WPA / WPA2 key entries are case-sensitive.

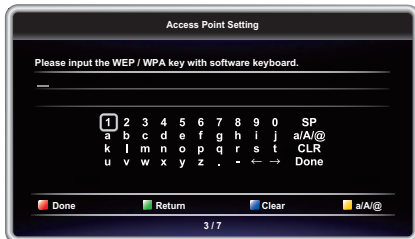

5. Use [▲ / ▼] to select “Next”, then press [OK].

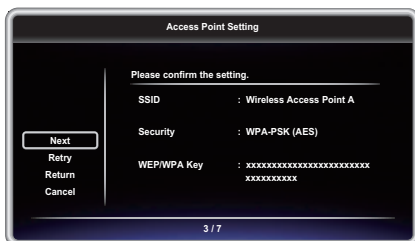

6. Use [▲ / ▼] to select “Auto” or “Manual”, then press [OK].
 - If you select “Auto”, follow step 4 in “Auto (Wired)” on page 38.
 - If you select “Manual”, follow steps 3 to 13 in “Manual (Wired)” on page 39.

Note

- The internal wireless LAN supports following specifications.
 - Wireless standards: IEEE 802.11 b/g/n
 - Frequency: 2.4 GHz
 - Security protocol: WEP* / WPA / WPA2
- * "WEP" is not recommended to be used due to its "Major security flaws". Change the Security protocol on the wireless router to "WPA" or "WPA2 (recommended)" mode.

Manual (Wireless)

Set up the connection to the wireless router manually by entering the SSID.

In the following cases, select "Manual" to set each setting as necessary.

- When connection test failed with the setting of "Auto Scan".
- Follow steps 1 and 2 in "Push Button Method" on page 40.
 - Use [**▲** / **▼**] to select "Manual", then press [**OK**].
 - SSID entry screen will appear. Enter the SSID using the Cursor buttons, the Number buttons and the Color keys, then press [**RED**].
 - Security mode selection screen will appear. Use [**▲** / **▼**] to select the desired Security mode, then press [**OK**].
 - If you select "None", please go to step 6.

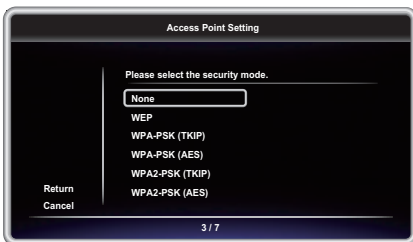

- "WEP / WPA / WPA2 Key" entry screen will appear. Enter the WEP / WPA / WPA2 password of the selected wireless network using Cursor buttons, Number buttons and Color keys, then press [**RED**] to confirm the password.
 - If you do not know the WEP / WPA / WPA2 key for your wireless network, please confirm the sticker on the router.
 - The WEP / WPA / WPA2 key entries are case-sensitive.
- Use [**▲** / **▼**] to select "Next", then press [**OK**].
- Use [**▲** / **▼**] to select "Auto" or "Manual", then press [**OK**].
 - If you select "Auto", follow step 4 in "Auto (Wired)" on page 38.
 - If you select "Manual", follow steps 3 to 13 in "Manual (Wired)" on page 39.

■ Network Status / Wireless Status

You can check the current status of network status and wireless status.

- Follow steps 1 and 2 in "Connection Test" on page 38.
- Use [**▲** / **▼**] to select "Network Status" or "Wireless Status", then press [**OK**].
 - The current network settings or wireless router setting will be displayed.
- Press [**HOME**] to return to the Home Menu.

■ Netflix ESN

You can view the ESN (Electronic Serial Number, which Netflix uses to identify your device). Netflix customer service might ask you for this number during troubleshooting.

- Follow steps 1 and 2 in "Connection Test" on page 38.
- Use [**▲** / **▼**] to select "Netflix ESN", then press [**OK**].
- Press [**HOME**] to return to the Home Menu.

11.2. fun-Link (HDMI CEC)

HOME → "Settings" → "HDMI" → "fun-Link (HDMI CEC)"

fun-Link (HDMI CEC) allows integrated system control over HDMI and is part of the HDMI standard. This function may not work properly depending on the device connected to the unit. When "fun-Link (HDMI CEC)" setting is set to "On" the functions listed below will be available.

■ One Touch Play

When the buttons below on the remote control are pressed then operations are performed on this unit, the TV will automatically be Turned On and switched to the appropriate video Source Input.

Buttons for one touch play:

- [▶ (PLAY)], [◀◀ (SKIP)], [▶▶ (SKIP)], [the NUMBER buttons], [HOME]
- [TOP MENU], or [POP MENU/MENU] (when a disc is inserted in the unit)

■ One Touch Standby

When you press and hold [⏻ (POWER-ON)] for 2 seconds, it turns Off the TV first and then Turns Off the power on this unit. When the connected fun-Link (HDMI CEC) compatible display device is Turned Off first, it then Turns Off the power to this unit.

When the connected fun-Link (HDMI CEC) compatible display device is Turned Off first, it then Turns Off the power to this unit.

■ System Information

Get & Set Menu Language

The unit recognizes the OSD language set on the TV and automatically sets the same language as the Player Menu Language (OSD menu language) for this unit. "Language" under "Playback" on page 36 for available languages.

- Feature is available only when "Auto" is selected in the Setup Menu "Language" section in "Settings" while connected via an HDMI cable.

11.3. HDMI Video Resolution

HOME → "Settings" → "HDMI" → "Video Resolution"

Set the resolution of the video signal being output from the HDMI OUT jack.

You can select the desired "Video Resolution" among the settings listed below: "Auto", "480p".

Actual Output Resolution:

Setting in the "Video Resolution"	Source				
	480i/60	720p/60	1080i/60	720p/24	1080p/24
Auto	The highest resolution supported by your display device will automatically be in effect.				
480p	480p/60				

Composite video output (VIDEO OUT) jack can only output 480i/60.

- For AVCHD, outputting the video in 24 frames per second (1080p/24) is not available.

ⓘ Note

- The selected resolution must also be supported by your display device.
- If your TV and the unit are connected by a DVI cable and if "Auto" is selected, "480p" will be automatically in effect.
- Refer also to your TV's manual.
- When connected to an HDCP incompatible display device, the picture will not be displayed properly.
- The audio signals from the HDMI OUT jack (including the sampling frequency, the number of channels and bit length) may be limited by the connected device.
- Among the display devices that support HDMI, some do not support audio output (for example, projectors). While connected to a device such as a projector, audio will not be output from the HDMI OUT jack.
- When this unit's HDMI OUT jack is connected to a DVI-D compatible display device(s) (HDCP compatible) with an HDMI-DVI converter cable, the signals are output in digital RGB.
- HDMI video resolution does not work during the playback of a BD-video.

continued on next page

Copyright protection system

To play back the digital video images of a BD-video or DVD-video via an HDMI connection, it is necessary that both the player and the display device (or an AV receiver / amplifier) support a copyright protection system called HDCP (high-bandwidth digital content protection system). HDCP is copy protection technology that comprises data encryption and authentication of the connected AV device. This unit supports HDCP. Please read the operating instructions of your display device (or an AV receiver / amplifier) for more information.

11.4. Parental

Some BD-videos or DVD-videos feature parental lock levels. Playback will stop if the ratings exceed the levels you set, it will require you to enter a password before the disc will play back. This feature prevents your children from viewing inappropriate material.

1. Use **[the NUMBER buttons]** to enter your 4-digit password.

For the first time use:

Use **[the NUMBER buttons]** to enter any 4-digit number (except for 4737). That number will be used as the password. Record your password, in case you forget it.

- If you forget the password, enter **[4], [7], [3], [7]**. The password will be cleared and rating level will be set to "Off".
- When you input the password, select "Clear" to clear the number, then re-enter the password.

■ BD Rating Level

HOME → "Settings" → "Playback" → "BD Rating Level"

1. Use **[▲ / ▼ / ◀ / ▶]** to select "Settings" in the Home Menu, then press **[OK]**.
2. Use **[▲ / ▼]** to select "Playback", then press **[OK]**.
3. Use **[▲ / ▼]** to select "BD Rating Level", then press **[OK]**.
4. Use **[the NUMBER buttons]** to enter your 4-digit password.
5. Use **[▲ / ▼]** to select your desired option, then press **[OK]**.

"Off": To release the limitation.

"Age Setting": To set the age limitation.

- After selecting "Age Setting", use **[the NUMBER buttons]** to enter the age.
(e.g., For age 6, enter **[6] + [OK]**.
For age 15, enter **[1] + [5] + [OK]**.)
6. Press **[HOME]** to Exit.

continued on next page

■ DVD Rating Level

HOME → "Settings" → "Playback" → "DVD Rating Level"

1. Use [▲ / ▼ / ◀ / ▶] to select "Settings" in the Home Menu, then press [OK].
2. Use [▲ / ▼] to select "Playback", then press [OK].
3. Use [▲ / ▼] to select "DVD Rating Level", then press [OK].
4. Use [the NUMBER buttons] to enter your 4-digit password.
5. Use [▲ / ▼] to select your desired level, then press [OK].
6. Press [HOME] to Exit.

	RATING EXPLANATIONS
Off	• Parental is inactive; all discs can be played back.
8 [Adult]	• DVD software of any grades (adult / general / children) can be played back.
7 [NC-17]	• No one under 17.
6 [R]	• Restricted; under 17.
5 [PGR]	• Parental Guidance Recommended.
4 [PG-13]	• Unsuitable for children under 13.
3 [PG]	• Parental Guidance suggested.
2 [G]	• General Audience.
1 [Kid Safe]	• Suitable for children.

■ Password Change

HOME → "Settings" → "Playback" → "Password Change"

1. Use [▲ / ▼ / ◀ / ▶] to select "Settings" in the Home Menu, then press [OK].
2. Use [▲ / ▼] to select "Playback", then press [OK].
3. Use [▲ / ▼] to select "Password Change", then press [OK].
4. Use [the NUMBER buttons] to enter your 4-digit password.
5. Use [the NUMBER buttons] to enter a new 4-digit password.
6. Use [the NUMBER buttons] to retype the same new 4-digit password.
7. Use [◀ / ▶] to select "OK", then press [OK].
8. Press [HOME] to Exit.

To temporarily disable parental lock:

Some discs allow you to temporarily disable parental lock. With these discs, the message below will appear when you try to play them back. "Enter current password."

Follow the instruction which appears on the TV screen to disable parental lock.

11.5. Software Update

HOME → "Settings" → "Others" → "Software Update"

This unit lets you update the software yourself using a software update disc, USB Memory Stick or via the Internet.

The available discs are below:

- BD-RE/-R
- DVD-RW/-R
- CD-RW/-R

■ Disc / USB Memory Stick Update

You can update the software by using a disc or USB Memory Stick.

Prepare a blank disc or USB Memory Stick for software update:

Access www.magnavox.com, and download the latest version software to a blank disc or USB Memory Stick using a PC by following the directions described on the website.

- Use a blank disc or USB Memory Stick, download one software per disc or USB Memory Stick. Write the software in the root directory of the disc or USB Memory Stick.
 - For more details on how to download the software, please refer to the website.
1. Use [**▲** / **▼** / **◀** / **▶**] to select "Settings" in the Home Menu, then press [**OK**].
 2. Use [**▲** / **▼**] to select "Others", then press [**OK**].
 3. Use [**▲** / **▼**] to select "Software Update", then press [**OK**].
 4. Use [**▲** / **▼**] to select "Disc" or "USB Memory Stick", then press [**OK**].
 5. Use [**◀** / **▶**] to select "Yes", then press [**OK**].
 6. Insert the disc or connect the USB Memory Stick for software update.
 7. After loading disc or USB Memory Stick, confirmation message will appear. Select "Yes" and press [**OK**].
 8. The unit will restart automatically, then software update will start.
 - It may take a while to complete the updating.
 9. After the update finishes, this unit will restart. Remove the disc or the USB Memory Stick from the unit.

⚠ Caution

- Please do not unplug the AC power cord, eject the disc or disconnect the USB Memory Stick or press [**⏻ (POWER-ON)**] to turn the unit to Standby mode while performing a "Disc / USB Memory Stick Update".

ⓘ Note

- Software update will not change any of the current settings.

■ Network Update

You can update the software by connecting the unit to the Internet.

1. Follow steps 1 to 3 in "Disc / USB Memory Stick Update" on page 46.
2. Use [**▲** / **▼**] to select "Network", then press [**OK**].
3. Use [**◀** / **▶**] to select "Yes", then press [**OK**].
 - The unit will connect to the server, then check for the latest software version.
4. Confirmation message will appear. Select "Yes", then press [**OK**].
5. The unit will restart automatically, then software update will start.
 - The unit will start downloading the latest software version.
6. When the download completes, confirmation message will appear. Press [**OK**].
 - The unit will start updating the software to the newer version.
 - It may take a while to complete the updating.
7. After updating finishes, this unit will restart automatically.

continued on next page

⚠ Caution

- Please do not unplug the AC power cord, LAN cable, wireless modem / router or press [⏻ (POWER-ON)] to turn the unit to Standby mode while using “Network Update”.

☰ Note

- In order to update the software via the Internet, you must connect the unit to the Internet and set up necessary settings.
- For the network connection, refer to “Connection to the Network” on page 13.
- For the network setup, refer to “Network Connection” on page 38.
- Software update will not change any of the current settings.

11.6. Restore Default Settings

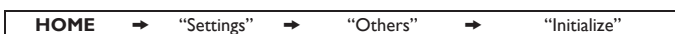

Menus to reset player settings, format a USB Memory Stick and clear network settings.

1. Use [▲ / ▼ / ◀ / ▶] to select “Settings” in the Home Menu, then press [OK].
2. Use [▲ / ▼] to select “Others”, then press [OK].
3. Use [▲ / ▼] to select “Initialize”, then press [OK].
4. Use [▲ / ▼] to select the desired setting, then press [OK].

“Reset Settings”:

All the settings except for the “Parental” and “Network Connection” settings will be reset to default.

“Format USB Memory Stick” (Only available when a USB Memory Stick is connected):

Initialize the USB Memory Stick.

“(Unit) Erase Saved BD-ROM Data”:

Clears the data saved for the BD-ROM contents, such as BD-ROM game scores, on this player.

“(USB Memory Stick) Erase Saved BD-ROM Data”

(Only available when a USB Memory Stick is connected):

Clears the supplemental data for the BD-ROM playback, such as Subtitle data, from the USB Memory Stick.

“Reset Network Settings”:

Reset the network setting to the default.

5. Use [◀ / ▶] to select “Yes”, then press [OK].
6. Confirmation message will appear. Press [OK] to complete the setting.
7. Press [HOME] to Exit.

⚠ Caution

- Do not remove the USB Memory Stick while executing “Format USB Memory Stick” or “(USB Memory Stick) Erase Saved BD-ROM Data”. It will damage the USB Memory Stick.

☰ Note

- “Format USB Memory Stick” and “(USB Memory Stick) Erase Saved BD-ROM Data” are not available when a Blu-ray Disc™ is in the unit.

12. TROUBLESHOOTING

Problem	Tip
No power.	Check the AC power cord, if it is properly connected.
	Try another power outlet.
	Unplug the AC power cord, and wait for about 5-10 seconds. Plug it back in and attempt to power On the unit.
No sound or picture.	Make sure both the TV and Blu-ray Disc™ player are Turned On.
	Confirm the connections to the TV are made properly as shown in the “CONNECTIONS” on page 10.
	Check to see whether the connected TV or another device supports HDCP. (This unit will not output a video signal unless the other device supports HDCP.)
No reaction to the remote control.	Reduce the distance to infrared sensor window.
	Confirm that the player’s AC power cord is plugged into a power outlet.
	Check the batteries in the remote control and make sure they are inserted properly by + or - symbols.
	Aim the remote at the unit’s remote receiver. Then press any arrow key and confirm the Power-On indicator dims and blinks when a remote button is pushed. Please check IR signal. Refer to “IR Signal Check” on page 55.
No Audio / Video signal on the display device via HDMI cable.	If the unit is connected to a non-certified HDMI device, the Audio / Video signal will not output to that device.
	Make sure the display device is on the correct Input / Video source.
	Perform the HDMI hotplug: Disconnecting the HDMI cable from the display device, Turn On both devices, and replug the HDMI cable back in.
	Check with the TV manufacturer, if there are any software updates available for the TV.
	Check to see if the HDMI cable is a certified version.
No high-definition video signal on the TV screen.	Does the disc contain high-definition video? High-definition video is only available when the disc contains it.
	Does the TV support high-definition video? High-definition video is only available when the TV supports it.
Distorted picture.	Sometimes a small amount of picture distortion may appear. This is not a malfunction.
	Connect this unit directly to the TV. If Audio / Video cables are connected to a VCR, pictures may be distorted due to the VCR copyright protection system.
Completely distorted picture or black / white picture with Blu-ray Disc™ / DVD.	Make sure the disc is compatible with this unit.
No sound or distorted sound.	Adjust the volume.
	Check to see if the speakers are connected correctly.
	Check the HDMI and AUDIO connections as necessary.
	Make sure the HDMI cable is not plugged into an HDMI-DVI adapter or Projector which does not handle Digital sound.
Picture freezes momentarily during disc playback.	Check the settings in “Audio Out” menu.
	Check the disc for fingerprints / scratches and clean with a soft cloth wiping from the center to the outer edge.

continued on next page

Problem	Tip
Cannot play back a disc.	Make sure that the disc is playable on this unit.
	Check the region code of the disc. This unit supports the following region codes. - Blu-ray Disc™: “A” - DVD: “ALL” or “1”
	For DVD-RW/-R, make sure that the disc is finalized.
	Clean the disc.
	Is the disc a newer title? This problem may be solved by software update. Refer to “Software Update” on page 46.
No return to start-up screen when disc is removed.	Soft reset this unit by turning it Off for 30 seconds, then On again.
	To completely reset the unit, press and hold [⏻(POWER-ON)] on the front panel for 10 seconds to shut down the unit or unplug the AC power cord from the AC outlet for 5-10 seconds.
⊘ in the upper right hand corner of the TV screen.	The operation is not possible.
Buttons do not work or the unit stops responding.	To soft reset the unit, press and hold [⏻(POWER-ON)] on the front panel for 10 seconds to shut down the unit or to hard reset the unit by unplugging the AC power cord from the AC outlet for 5-10 seconds.
The unit does not respond to some operating commands during playback.	The operations may be prohibited by the disc. Refer to the instructions for the disc.
The unit cannot read Blu-ray Disc™ / DVD/ CD.	Condensation? (Let sit 1 or 2 hours)
	Check to see if the disc is compatible with this unit. (Refer to page 17.)
	Wipe dirt off the disc from the center to the outside or replace the disc. Refer to “Cleaning Discs” on page 55.
Scene shooting Angle does not switch.	Angles cannot be switched for Blu-ray Disc™ / DVD which do not contain multiple Angles. In some cases multiple Angles are only recorded for specific scenes.
Playback does not start when a Title is selected.	Check the settings in “Parental” menu.
The password for rating level has been forgotten.	Enter the default password “4737”, then your forgotten password will be cleared. Then to change password go to “Password Change” on page 45.
Error message appears when I select “Auto” in the “Language”.	Make sure that the unit is connected to a MAGNAVOX brand fun-Link (HDMI CEC) TV and the “fun-Link (HDMI CEC)” is set to “On”.
	This error message may appear when your TV's OSD language is not supported by this unit.
Cannot play back AVCHD file.	This unit cannot play back stand-alone AVCHD files (*.m2ts, *.mts or *.m2t) written to a DVD. The DVD containing AVCHD files must have a proper file and folder structure meeting AVCHD format specifications. Please use AVCHD compliant device / software to burn or copy AVCHD files to DVD. (Please refer to user manuals of the device / software for more information.)
The capacity of the USB Memory Stick decreased.	Data may be written on the USB Memory Stick when a BD-video uses the Virtual Package feature while a USB Memory Stick is connected to the unit.
Cannot play back a MPEG-2 video and audio from the USB Memory Stick.	MPEG-2 is not compatible with this unit.
Cannot read the contents on the USB Memory Stick.	The USB Memory Stick is not compatible with this unit or the contents may be damaged.
	Try and Turn Off the unit, then turn it back On.
	To soft reset the unit, press and hold [⏻(POWER-ON)] on the front panel for 10 seconds to shut down the unit or to hard reset the unit by unplugging the AC power cord from the AC outlet for 5-10 seconds.
Cannot play back BD-video (BD-ROM Profile 2.0).	Connect a USB Memory Stick (1GB or more of available memory) which is formatted on this unit. Some discs with BD-Live™ function require memory when playing back the content.
	Do not disconnect the USB Memory Stick during playback.

continued on next page

Problem	Tip
Cannot load a Blu-ray Disc™ (stuck in “Loading...” mode) and cannot Open the disc tray to eject the disc.	Unplug unit from AC outlet for 20 seconds. Plug unit back in and press the [▲ (OPEN/CLOSE)] on the unit to eject the disc.
The software update screen appears after Turning On the unit.	Please complete the software update. When the software update has failed, the software update screen will keep appearing after turning the unit on. If the software update continues failing, please try it by using a USB Memory Stick with the update software installed in its root directory. In this case, please change the file name as below. “E***UD1000FA1.bin” → “UPDATE1000FA1.BIN” Do not change the numbers. The file name is case sensitive.
Cannot read a USB Memory Stick.	The format of the USB Memory Stick is not compatible with this unit. Please try and format it on this unit (All data will be deleted).
Cannot play back JPEG files from a disc.	Cannot play back JPEG files from a disc. Make sure that the disc was recorded in the UDF, ISO9660 or JOLIET format.
Cannot find a JPEG file.	Make sure that the selected Group (folder) does not contain more than 9,999 files for Blu-ray Disc™ / DVD / USB Memory Stick and 999 files for CD. Make sure that the file extension is .jpg / .JPG / .jpeg / or .JPEG.
Cannot play back MP3 files from a disc.	Make sure that the disc was recorded in the UDF, ISO9660 or JOLIET format. Make sure that the bit rate of the MP3 files is between 112 and 320 kbps Make sure that the sample rate of the MP3 files is 32 kHz, 44.1 kHz or 48 kHz.
Cannot find an MP3 file.	Make sure that the selected folder does not contain more than 9,999 files for Blu-ray Disc™ / DVD / USB Memory Stick and 999 files for CD. Make sure that the file extension is .mp3 or .MP3 for MP3 files.
No Audio signal from Surround system of the audio system.	Make sure the audio system is turned on. Check the Input mode on the audio system if it is on the correct channel. Check if the Surround system is compatible with either Bitstream or LPCM. If not sure please check the user manual or contact the Surround manufacturer. Once confirmed check the setting in the “Settings” of this unit. Increase the volume level of the Surround system.
Cannot connect to the network.	Check to see if the modem / router has Power turned On. Confirm if the Internet light is showing activity (light blinking) on the modem / router. Check network settings on the unit. Power cycle the modem’s and/or router’s AC plug from its AC outlet for 30 seconds, and then plug it back in. Then, try reconnecting cords. If you have a telephone / Internet modem with your cable service, then you may have to use its reset button or remove the backup battery to reset this type of modem. Now wait for the lights to show activity and try reconnecting. Check the cable connection to the router. Turn On the DHCP function on the router.
Cannot use “Easy Connect (WPS)” to connect to the Access Point.	If the Access Point's security mode is set to “WEP”, change the setting to “WPA” or “WPA2 (recommended)”, then try “Easy Connect (WPS)” again. Refer to “ⓘ Note” on page 41. (For Access Point configuration, please consult its user manual or manufacturer.) Connect the unit to the Access Point using “Auto Scan” or “Manual” mode.

continued on next page

Problem	Tip
Cannot use the wireless connection.	Once you have activated the wireless connection please wait 30 seconds for the connection to be established after Turning On the unit, before trying to access network features such as BD-Live™, DLNA home network server and the third-party network services. If  appears in the upper left corner of the Home Menu screen, this unit is connected to an Access Point. Please contact your ISP for further assistance when you cannot access BD-Live™ or network services.
Cannot connect to the network while my PC is connected to the network.	Check the content of your Internet service contract to see if your Internet Service Provider prevents multiple terminals connecting at the same time.
Cannot use the BD-Live™ function or download of data does not perform properly.	Connect a USB Memory Stick before inserting the disc.
	Connect a USB Memory Stick with enough capacity (1GB or more of available memory).
	Check to see if the USB Memory Stick is properly connected.
Folder or files stored on DLNA home media server are not displayed in the file list or files do not play back.	Check the settings on your home media server. (Refer to the user manual of the home media server.)
	Check the network connection and settings.
Cannot use Netflix feature.	Netflix is only available in the United States.
	Check to see if the network connection is properly made.
	Visit netflix.com/magnavox on your PC and become a Netflix member.
Cannot add Movies or TV episodes to the instant Queue.	Visit netflix.com on your PC.
	You may add from the player or visit netflix.com and login to your account by web.
The picture quality of a Netflix streaming movie does not improve even though my Internet connection speed improved during playback.	The picture quality does not change during playback.
	The picture quality differs based on the Internet connection speed at the time the streaming movie is loading.
The picture quality of Netflix streaming movie is poor.	Check your Internet connection speed.
	Contact your Internet service provider. (You may need to improve the broadband speed.)
Netflix streaming movie often stops or starts buffering during playback.	Contact your Internet service provider. (You may need to improve the broadband speed.)
Cannot use the VUDU service.	VUDU is only available in the United States.
	Check to see if the network connection is properly made.
Cannot rent or buy Movies / TV shows on VUDU.	You need to activate the VUDU account.
	Log into your account at http://my.vudu.com and check your payment information.
The picture quality of VUDU movie is poor.	Check your Internet connection speed. You need speeds of at least 9 Mbps to this player for high quality uninterrupted playback.
VUDU movie often stops or starts buffering during playback.	Check your Internet speed. The following are the required connection speeds for picture quality for uninterrupted streaming. SD quality (1 Mbps - 2 Mbps), HD quality (2.25 Mbps - 4.5 Mbps), HDX quality (4.5 Mbps - 9 Mbps). Please confirm your Internet environment on www.vudu.com
Can not use the YouTube™ service.	Check to see if the network connection is properly made.
The picture quality of the YouTube™ video is poor.	You may experience frequent buffering, distorted pictures or no picture at all depending on your network environment and Internet traffic.
	The picture and sound quality differ depending on the Internet service provider.

 **Note**

- Do not attempt to repair the Blu-ray Disc™ Player yourself. This may cause severe injury, irreparable damage to your Blu-ray Disc™ Player and void your warranty.
- Please have available your Blu-ray Disc™ Player model and serial number before contacting us. These numbers are available on the cabinet, as well as on the packaging.

13. LANGUAGE CODE LIST

Language	Code	Language	Code	Language	Code	Language	Code
A-B		French [FRE]	5264	Macedonian	5957	Siswat	6565
Abkhazian	4748	Frisian	5271	Malagasy	5953	Slovak [SLO]	6557
Afar	4747	Galician	5358	Malay	5965	Slovenian	6558
Afrikaans	4752	Georgian	5747	Malayalam	5958	Somali	6561
Albanian	6563	German [GER]	5051	Maltese	5966	Spanish [SPA]	5165
Amharic	4759	Greek [GRE]	5158	Maori	5955	Sundanese	6567
Arabic	4764	Greenlandic	5758	Marathi	5964	Swahili	6569
Armenian	5471	Guarani	5360	Moldavian	5961	Swedish [SWE]	6568
Assamese	4765	Gujarati	5367	Mongolian	5960	T	
Aymara	4771	Hausa	5447	Nauru	6047	Tagalog	6658
Azerbaijani	4772	Hebrew	5569	Nepali	6051	Tajik	6653
Bashkir	4847	Hindi	5455	Norwegian [NOR]	6061	Tamil	6647
Basque	5167	Hungarian [HUN]	5467	O-R		Tatar	6666
Bengali;Bangla	4860	I-K		Occitan	6149	Telugu	6651
Bhutani	5072	Icelandic [ICE]	5565	Oriya	6164	Thai	6654
Bihari	4854	Indonesian	5550	Oromo (Afan)	6159	Tibetan	4861
Bislama	4855	Interlingua	5547	Panjabi	6247	Tigrinya	6655
Breton	4864	Interlingue	5551	Pashto;Pushto	6265	Tonga	6661
Bulgarian [BUL]	4853	Inupiak	5557	Persian	5247	Tsonga	6665
Burmese	5971	Irish [GLE]	5347	Polish [POL]	6258	Turkish [TUR]	6664
Byelorussian	4851	Italian [ITA]	5566	Portuguese [POR]	6266	Turkmen	6657
C-E		Japanese [JPN]	5647	Quechua	6367	Twi	6669
Cambodian	5759	Javanese	5668	Rhaeto-Romance	6459	U-Z	
Catalan	4947	Kannada	5760	Romanian [RUM]	6461	Ukrainian	6757
Chinese [CHI]	7254	Kashmiri	5765	Russian [RUS]	6467	Urdu	6764
Corsican	4961	Kazakh	5757	S		Uzbek	6772
Croatian	5464	Kinyarwanda	6469	Samoan	6559	Vietnamese	6855
Czech [CZE]	4965	Kirghiz	5771	Sangho	6553	Volapuk	6861
Danish [DAN]	5047	Kirundi	6460	Sanskrit	6547	Welsh	4971
Dutch [DUT]	6058	Korean [KOR]	5761	Scots Gaelic	5350	Wolof	6961
English [ENG]	5160	Kurdish	5767	Serbian	6564	Xhosa	7054
Esperanto	5161	L-N		Serbo-Croatian	6554	Yiddish	7155
Estonian	5166	Laothian	5861	Sesotho	6566	Yoruba	7161
F-H		Latin	5847	Setswana	6660	Zulu	7267
Faroese	5261	Latvian;Lettish	5868	Shona	6560		
Fiji	5256	Lingala	5860	Sindhi	6550		
Finnish [FIN]	5255	Lithuanian	5866	Singhalese	6555		

Note

- If you choose a language that has a 3-letter-language code (written in bracket), the code will be displayed every time you change the Subtitle language setting on page 30 or audio language setting on page 31. If you choose any other languages, "----" will be displayed instead.

15. NETWORK SERVICE DISCLAIMER

Content and services made available through this product are transmitted by third parties by means of networks and transmission facilities over which Company has no control and third party services may be terminated or interrupted at any time, and Company makes no representation or warranty that any content or service will remain available for any period of time. Without limiting the generality of this disclaimer, Company expressly disclaims any responsibility for any interruption or suspension of any content or service made available through this product. Company is not responsible for customer service related to the content and services. Any question or request for service relating to the content or services should be made directly to the respective content and service providers.

THIRD PARTY CONTENT AND SERVICES MADE AVAILABLE THROUGH THIS PRODUCT ARE PROVIDED "AS IS." COMPANY DOES NOT WARRANT CONTENT OR SERVICES SO PROVIDED, FOR ANY PURPOSE WHATSOEVER. COMPANY EXPRESSLY DISCLAIMS ANY WARRANTIES, EXPRESS OR IMPLIED INCLUDING WITHOUT LIMITATION, WARRANTIES OF MERCHANTABILITY OR FITNESS FOR A PARTICULAR PURPOSE, ACCURACY, VALIDITY, TIMELINESS, LEGALITY, SUITABILITY, OR QUALITY OF ANY CONTENT OR SERVICE MADE AVAILABLE THROUGH THIS PRODUCT.

IN NO EVENT SHALL COMPANY BE LIABLE FOR, ANY DAMAGES, WHETHER ARISING IN CONTRACT OR TORT, INCLUDING WITHOUT LIMITATION, ANY DIRECT, INDIRECT, INCIDENTAL, SPECIAL OR CONSEQUENTIAL DAMAGES, LOST PROFITS, ATTORNEY FEES, EXPENSES, OR ANY OTHER DAMAGES ARISING OUT OF, OR IN CONNECTION WITH, ANY CONTENT (OR ANY INFORMATION CONTAINED THEREIN) OR SERVICE PROVIDED TO THE USER OR ANY THIRD PARTY, EVEN IF ADVISED OF THE POSSIBILITY OF SUCH DAMAGES.

All content and services accessible through this product belong to third parties and are protected by copyright, patent, trademark and/or other intellectual property rights. Such content and services are provided solely for the User's personal noncommercial use. User may not use any content or services in a manner that has not been authorized by the content owner or service provider. Without limiting the foregoing, unless expressly authorized by the applicable content owner or service provider, you may not modify, copy, republish, upload, post, transmit, translate, sell, create derivative works, exploit, or distribute in any manner or medium any content or services made available through this product.

16. MAINTENANCE

■ Servicing

- Please refer to relevant topics on “TROUBLESHOOTING” on page 48 before returning the product.
- If this unit becomes inoperative, do not try to correct the problem by yourself. There are no user-serviceable parts inside. Eject the disc (if possible), disconnect the USB Memory Stick (if connected to the unit), place the unit into Standby mode, unplug the AC power plug, and please contact: 1-800-605-8610 or visit : www.magnavox.com/support

■ Cleaning the Cabinet

- Wipe the front panel and other exterior surfaces of the unit with a soft cloth.
- Never use a solvent, thinner, benzene or alcohol to clean the unit. Do not spray insecticide liquid near the unit. Such chemicals may discolor the surface or damage the unit.

■ Cleaning Discs

- When a disc becomes dirty, clean it with a cleaning cloth. Wipe the disc from the center to outside. Do not wipe in a circular motion.
- Do not use solvents such as benzene, thinner, commercially available cleaners, detergent, abrasive cleaning agents or antistatic spray intended for analog records.

■ Cleaning the Disc Lens

- If this unit still does not perform properly although you refer to the relevant sections and to “TROUBLESHOOTING” in this user manual, the laser optical pickup unit may be dirty. Consult your dealer or an Authorized Service Center for inspection and cleaning of the laser optical pickup unit.

■ Disc Handling

- Handle the discs so that fingerprints and dust do not adhere to the surfaces of the discs.
- Always store the disc in its protective case when it is not used.
- Note that discs with special shapes (heart-shaped discs, octagonal discs, etc.) cannot be played back on this unit. Do not attempt to play such discs, as they may damage the unit.

■ IR Signal Check

If the remote control does not work properly, you can test IR signal using a digital camera (including a cellphone with a built-in camera) to see if the remote control sends out the infrared signal.

1. Turn On the digital camera.
 2. Direct a digital camera to the remote control, then press and hold any button on the remote control.
- If infrared light appears on the digital camera display, the remote control is working.



17. TRADEMARK INFORMATION



Manufactured under license from Dolby Laboratories. Dolby and the double-D symbol are trademarks of Dolby Laboratories.



Netflix and the Netflix logo are trademarks or registered trademarks of Netflix, Inc. <http://www.netflix.com/HowItWorks>



Manufactured under license under U.S. Patent Nos: 5,956,674; 5,974,380; 6,226,616; 6,487,535; 7,392,195; 7,272,567; 7,333,929; 7,212,872 & other U.S. and worldwide patents issued & pending. DTS-HD, the Symbol, & DTS-HD and the Symbol together are registered trademarks & DTS-HD Master Audio | Essential is a trademark of DTS, Inc. Product includes software. © DTS, Inc. All Rights Reserved.



VUDU™ is a trademark of VUDU, Inc. www.vudu.com/product_overview.html



The terms HDMI and HDMI High-Definition Multimedia Interface, and the HDMI Logo are trademarks or registered trademarks of HDMI Licensing LLC in the United States and other countries.



YouTube and the YouTube logo are trademarks of Google Inc.



DLNA®, the DLNA Logo and DLNA CERTIFIED® are trademarks, service marks, or certification marks of the Digital Living Network Alliance.

x.v.Color

"x.v.Color" and "x.v.Color" logo are trademarks of Sony Corporation.



The Wi-Fi CERTIFIED Logo is a certification mark of the Wi-Fi Alliance.



Java and all Java based trademarks and logos are trademarks or registered trademarks of Oracle and/or its affiliates.



Kodak and KODAK Picture CD Compatible are trademarks of Kodak used under license.



"AVCHD" and the "AVCHD" logo are trademarks of Panasonic Corporation and Sony Corporation.

continued on next page



“Blu-ray Disc™”, “Blu-ray” and “Blu-ray Disc™” logo are trademarks of the Blu-ray Disc Association.

DVD is a trademark of DVD Format/Logo Licensing Corporation.



“BD-Live™” and “BD-Live™” logo are trademarks of the Blu-ray Disc Association.

BONUSVIEW™

“BONUSVIEW™” and “BONUSVIEW™” logo are trademarks of the Blu-ray Disc Association.

THIS PRODUCT IS LICENSED UNDER THE AVC PATENT PORTFOLIO LICENSE FOR THE PERSONAL AND NON-COMMERCIAL USE OF A CONSUMER TO (i) ENCODE VIDEO IN COMPLIANCE WITH THE AVC STANDARD (“AVC VIDEO”) AND/OR (ii) DECODE AVC VIDEO THAT WAS ENCODED BY A CONSUMER ENGAGED IN A PERSONAL AND NON-COMMERCIAL ACTIVITY AND/OR WAS OBTAINED FROM A VIDEO PROVIDER LICENSED TO PROVIDE AVC VIDEO. NO LICENSE IS GRANTED OR SHALL BE IMPLIED FOR ANY OTHER USE. ADDITIONAL INFORMATION MAY BE OBTAINED FROM MPEG LA, L. L. C. SEE [HTTP://WWW.MPEGLA.COM](http://www.mpegla.com)

THIS PRODUCT IS LICENSED UNDER THE VC-1 PATENT PORTFOLIO LICENSE FOR THE PERSONAL AND NON-COMMERCIAL USE OF A CONSUMER TO (i) ENCODE VIDEO IN COMPLIANCE WITH THE VC-1 STANDARD (“VC-1 VIDEO”) AND/OR (ii) DECODE VC-1 VIDEO THAT WAS ENCODED BY A CONSUMER ENGAGED IN A PERSONAL AND NON-COMMERCIAL ACTIVITY AND/OR WAS OBTAINED FROM A VIDEO PROVIDER LICENSED TO PROVIDE VC-1 VIDEO. NO LICENSE IS GRANTED OR SHALL BE IMPLIED FOR ANY OTHER USE. ADDITIONAL INFORMATION MAY BE OBTAINED FROM MPEG LA, L.L.C. SEE [HTTP://WWW.MPEGLA.COM](http://www.mpegla.com)

MPEG Layer-3 audio coding technology licensed from Fraunhofer IIS and Thomson.

18. GLOSSARY

AACS

Advanced Access Content System (AACS) is the content protection scheme used with Blu-ray discs.

Analog Audio

An electrical signal that directly represents sound. Compare this to digital audio which can be an electrical signal, but is an indirect representation of sound. See also "Digital Audio".

Aspect Ratio

The width of a TV screen relative to its height. Conventional TVs are 4:3 (in other words, the TV screen is almost square); widescreen models are 16:9 (the TV screen is almost twice as wide as its height).

AVCHD

AVCHD is a new format for high definition video camcorders which can record and play high-resolution HD images.

BD-Live™

BD-Live™ is a BD-video (BD-ROM version 2 Profile 2.0) which contains new functions (e.g. Internet connection), in addition to the BONUSVIEW™ function.

Blu-ray Disc™

Blu-ray Disc™ is a next generation optical video disc which is capable of storing much more data than a conventional DVD. The large capacity makes it possible to benefit from the features such as high-definition videos, multi-channel surround sounds, interactive menus and so on.

Chapter

Just as a book is split up into several chapters, a Title on a BD-video or DVD-video is usually divided into chapters. See also "Title".

Cinavia™

Cinavia Notice

This product uses Cinavia technology to limit the use of unauthorized copies of some commercially-produced film and videos and their soundtracks. When a prohibited use of an unauthorized copy is detected, a message will be displayed and playback or copying will be interrupted. More information about Cinavia technology is provided at the Cinavia Online Consumer Information Center at <http://www.cinavia.com>

To request additional information about Cinavia by mail, send a postcard with your mailing address to: Cinavia Consumer Information Center, P.O. Box 86851, San Diego, CA, 92138, USA.

This product incorporates proprietary technology under license from Verance Corporation and is protected by U.S. Patent 7,369,677 and other U.S. and worldwide patents issued and pending as well as copyright and trade secret protection for certain aspects of such technology. Cinavia is a trademark of Verance Corporation. Copyright 2004-2010 Verance Corporation. All rights reserved by Verance. Reverse engineering or disassembly is prohibited.

Default Gateway

IP address of the electronic devices (such as router) which provide Internet access.

Digital Audio

An indirect representation of sound by numbers. During recording, the sound is measured at discrete intervals (44,100 times a second for CD audio) by an analog-to-digital converter, generating a stream of numbers. On playback, a digital-to-analog converter generates an analog signal based on these numbers. See also "Sampling Frequency" and "Analog Audio".

DLNA (Digital Living Network Alliance)

DLNA is a cross-industry organization of consumer electronics that formulates DLNA Interoperability Guidelines for sharing digital contents within a home network.

DNS Server

A server which translates Internet domain names into IP addresses.

Dolby Digital

The system to compress digital sound developed by Dolby Laboratories. It offers you sound of stereo (2ch) or multi-channel audio.

Dolby Digital Plus

Dolby Digital Plus is the next generation digital audio compression technology developed as an extension to Dolby Digital. Blu-ray Disc™ supports 7.1 multi-channel surround sound output.

Dolby TrueHD

Dolby TrueHD is a lossless coding technology developed for next generation optical discs. Blu-ray Disc™ supports 7.1 multi-channel surround sound output.

DTS® (Digital Theater System)

DTS® is a multi channel surround sound system. You can enjoy movie dynamic and realistic sound like movie theater. DTS surround sound technologies were developed by DTS, Inc.

DTS-HD®

DTS-HD® is a lossless coding technology developed as an extension of the original DTS Coherent Acoustics format. Blu-ray Disc™ supports 7.1 multi-channel surround sound output.

HDMI (High-Definition Multimedia Interface)

A digital interface between an audio and video Source. It can transmit component video, audio, and control signal with one cable connection.

IP Address

A set of numbers which are assigned to devices participating in a computer network.

continued on next page

JPEG (Joint Photographic Experts Group)

JPEG is a method of compressing still picture files. You can copy JPEG files on BD-RE/-R, DVD-RW/-R, CD-RW/-R, or USB Memory Stick from a computer and play back the files on this unit.

LAN (Local Area Network)

A group of computer networks covering a small area like a company, school or home.

Local Storage

A storage area of sub contents for playing virtual packages on BD-video.

MP3 (MPEG audio layer 3)

MP3 is a method of compressing files. You can copy MP3 files on BD-RE/-R, DVD-RW/-R, CD-RW/-R, or USB Memory Stick from the computer and play back the files on this unit.

Netflix

Netflix is online movie rental service, offering online streaming to customers in the United States.

PCM (Pulse Code Modulation)

The most common system of encoding digital audio, found on CD and DAT. Excellent quality, but requires a lot of data compared to formats such as Dolby Digital and MPEG audio. For compatibility with digital audio recorders (CD, MD and DAT) and AV amplifiers with digital Inputs, this unit can convert Dolby Digital, DTS, and MPEG audio to PCM. See also "Digital Audio".

Proxy Server

Proxy server is a server which acts as an intermediary between a workstation user and the Internet to ensure security.

Region Code

Regions associate discs and players with particular areas of the world. This unit will only play back discs that have compatible region codes. You can find the region code of your unit by looking on the rear panel. Some discs are compatible with more than one region (or all regions).

Router

A networking device which distinguishes the IP address assigned to each device and routing and forwarding information in the computer network.

Sampling Frequency

The rate which sound is measured by a specified interval to turn into digital audio data. The numbers of sampling in one second defines as sampling frequency. The higher the rate, the better the sound quality.

Subnet Mask

A mask which is used to determine what subnet an IP address belongs to.

Switch / Hub

A device used for connecting multiple devices to the network.

Title

A collection of chapters on BD-video or DVD-video. See also "Chapter".

Track

Audio CD uses Tracks to divide up the content of a disc. The BD-video or DVD-video equivalent is called a Chapter. See also "Chapter".

Virtual Package

The function which copies data to other media (local storage) from the Internet and plays Secondary Video, Secondary Audio and subtitles at the same time. The method of the playback varies depending on the disc.

VUDU

VUDU is a leading HD on-demand video service which utilizes the Internet connection to deliver the highest quality on-demand video and Internet applications.

x.v.Color

"x.v.Color" is a promotion name given to the products that have the capability to realize a wide color space based on the xvYCC specifications and is a trademark of Sony Corporation.

YouTube™

YouTube™ is one of the video-sharing web sites which you can view a large number of videos posted on the web site for free. Not only can you view videos on YouTube™, you can upload your original video clips and share them with your friends all over the world.

19. ESPAÑOL

19.1. Mando a Distancia

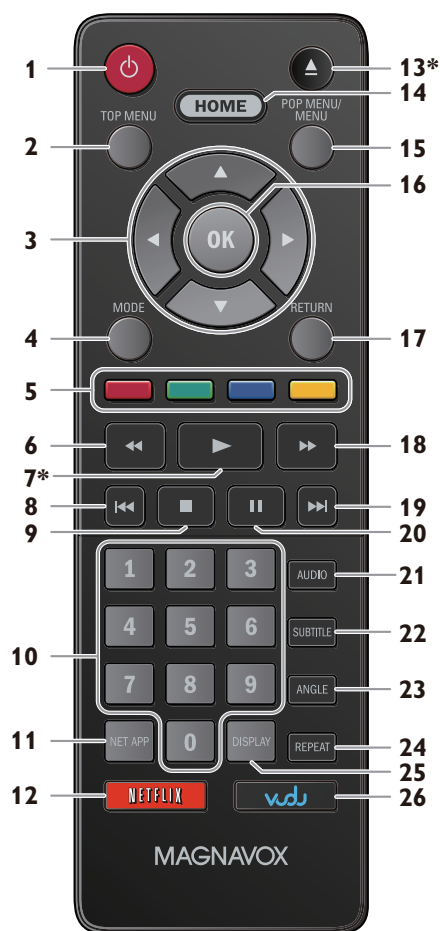

* La unidad también se puede encender pulsando estos botones.

1. Botón (ENCENDIDO)

- Pulse el botón para encender la unidad, o para pasar la unidad al modo de espera. (Para apagar completamente la unidad, debe desconectar el cable de alimentación de CA.)

2. Botón TOP MENU

- Blu-ray Disc™:** Púlselo para mostrar el menú superior.
- DVD:** Púlselo para mostrar el menú de títulos.

3. Botones de / / /

- Púlselos para seleccionar elementos o configuraciones.

4. Botón MODE

- Durante la reproducción, púlselo para visualizar el menú de reproducción.

5. Botones de ROJO / VERDE / AZUL / AMARILLO

- Púlselo para activar las teclas de atajo en algunas funciones de BD-vídeo. Cuando se despliega la lista de archivos, presione para cambiar las páginas.

6. Botón (REVERSO)

- Durante la reproducción, púlselo para invertir rápido la reproducción.

7. Botón (REPRODUCIR)*

- Púlselo para iniciar o reanudar la reproducción.

8. Botón (SALTAR)

- Durante la reproducción, púlselo una vez para volver al comienzo del título, capítulo, pista o archivo actual.
- Durante la reproducción, pulse dos veces sobre la tecla para volver al título, capítulo, pista o archivo anterior.
- Durante la reproducción de archivos JPEG, púlselo para volver al archivo anterior.

9. Botón (DETERNER)

- Púlselo para detener la reproducción.

10. Botones NUMÉRICOS

- Púlselos para seleccionar un capítulo durante la reproducción.
- Púlselos para introducir números en el campo de entrada.

11. Botón NET APP

- Púlselo para visualizar el menú de aplicación de la red.

12. Botón NETFLIX

- Pulse para abrir Netflix.

13. Botón (ABRIR/CERRAR)*

- Púlselo para cerrar o abrir la bandeja para discos.

14. Botón HOME

- Púlselo para mostrar el menú de inicio.

15. Botón POP MENU/MENU

- Blu-ray Disc™:** Púlselo para mostrar el menú emergente.
- DVD:** Púlselo para mostrar el menú del disco.

16. Botón OK

- Púlselo para confirmar o seleccionar elementos de menú.

17. Botón RETURN

- Púlselo para volver a la pantalla de funciones o menú mostrado anteriormente.

18. Botón (ADELANTAR)

- Durante la reproducción, púlselo para avanzar rápido la reproducción.
- Cuando la reproducción esté en pausa, púlselo para avanzar lentamente la reproducción.

Continúa en la página siguiente

19. Botón ►► (SALTAR)

- Durante la reproducción, púselo para saltar al siguiente capítulo, pista o archivo.
- Cuando la reproducción esté en modo de pausa, púselo para avanzar la reproducción imagen a imagen.

20. Botón II (PAUSAR)

- Púselo para pausar la reproducción.

21. Botón AUDIO

- Púselo para seleccionar el canal de sonido (como idiomas de sonido) de un disco.

22. Botón SUBTITLE

- Púselo para seleccionar los subtítulos de un disco.

23. Botón ANGLE

- Púselo para acceder a distintos ángulos de cámara del disco.

24. Botón REPEAT

- Presione para seleccionar el modo de repetición.

25. Botón DISPLAY

- Púselo para visualizar el menú desplegable en pantalla.

26. Botón VUDU

- Pulse para abrir VUDU.

⊖ Nota

- El indicador Encendido en el panel frontal se atenúa y parpadea cuando se recibe la señal IR del control remoto.
- Use el control remoto suministrado. No se garantiza la operación de control remoto en cualquier otro control remoto, tal como un control remoto universal.

19.2. Encontrar el Canal de Video en su Televisor

Revise los siguientes pasos después de haber completado todas las conexiones a su TV.

1. Presione [**⏻ (ENCENDIDO)**] para Encender la unidad.
2. Encienda su televisor.
3. Busque el botón Source / Input / AUX / Video en el control remoto del televisor. El botón puede variar en función de la marca y el modelo del televisor. Una vez localizado el botón presione hasta ver "Espere un..." o el menú de Configuración Inicial en la pantalla.

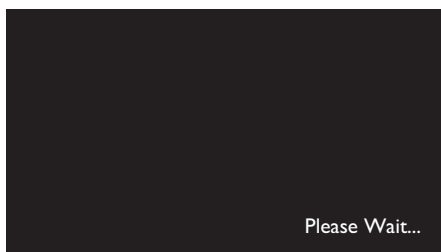

Esta es la visualización correcta de la entrada de la fuente de video.

- Si la TV está conectada por medio de un cable HDMI, puede tomar algunos minutos para que aparezca la imagen de abertura.
- Cuando pase cierto tiempo sin que haya conectado la unidad aparecerá la sola pantalla de bienvenida la primera vez que conecte la unidad.

19.3. Instalacion Inicial

Por favor, siga las instrucciones que se exponen a continuacion para completar la configuracion inicial.

1. Utilice [**▲** / **▼**] mientras se presenta la pantalla de bienvenida para seleccionar "Next" y pulse luego [**OK**].
2. Aparece la pantalla de configuracion del idioma. Utilice [**▲** / **▼**] para seleccionar su idioma y pulse luego [**OK**].

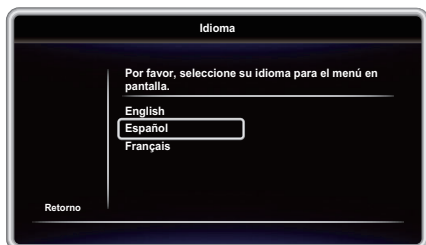

3. Aparece la pantalla de "Modo de Inicio Rápido". Utilice [**▲** / **▼**] para seleccionar el modo deseado y pulse luego [**OK**].
4. Aparece la pantalla de "Comprueba automaticamente si hay un software mas reciente". Utilice [**▲** / **▼**] para seleccionar el modo deseado y pulse luego [**OK**].
5. Aparece la pantalla de configuracion de la red. Utilice [**▲** / **▼**] para seleccionar el modo deseado y pulse luego [**OK**].
 - Si selecciona "Por cable" vea informaciones mas detalladas en el punto "Wired Connection" de la página 38.
 - Si selecciona "Inalambrico" vea informaciones mas detalladas en el punto "Wireless Connection" de la página 40.

■ Cómo restablecer el Idioma OSD

Puede restablecer el idioma OSD si seleccionó el ajuste de idioma equivocado.

1. Presione [**HOME**] para desplegar el Menú de Inicio.
2. Utilice [**▲** / **▼** / **◀** / **▶**] para seleccionar "  ", después presione [**OK**].
 - Esta partida es "Settings" (inglés) / "Configuraciones" (español) / "Paramètres" (francés).
 - A partir de aquí, por favor seleccione una de las siguientes partidas que puede encontrar en la pantalla:
3. Utilice [**▲** / **▼**] para seleccionar "Playback" (inglés) / "Reproducción" (español) / "Lecture" (francés), y después presione [**OK**].
4. Utilice [**▲** / **▼**] para seleccionar "Language" (inglés) / "Idioma" (español) / "Langue" (francés), y después presione [**OK**].
5. Utilice [**▲** / **▼**] para seleccionar el idioma que desee, después presione [**OK**].
6. Si las partidas de ajuste se despliegan en el idioma que seleccionó, presione [**HOME**] para salir.

MAGNAVOX LIMITED WARRANTY

FUNAI CORP. will repair this product, free of charge in the USA in the event of defect in materials or workmanship as follows:

DURATION:

PARTS: FUNAI CORP. will provide parts to replace defective parts without charge for one (1) year from the date of original retail purchase. Certain parts are excluded from this warranty.

LABOR: FUNAI CORP. will provide the labor without charge for a period of ninety (90) days from the date of original retail purchase.

Note: Any product sold and identified as refurbished or renewed carries a ninety (90) days labor and parts limited warranty.

LIMITS AND EXCLUSIONS:

THIS WARRANTY IS EXTENDED ONLY TO THE ORIGINAL RETAIL PURCHASER. A PURCHASE RECEIPT OR OTHER PROOF OF ORIGINAL RETAIL PURCHASE WILL BE REQUIRED TOGETHER WITH THE PRODUCT TO OBTAIN SERVICE UNDER THIS WARRANTY.

This warranty shall not be extended to any other person or transferee.

This warranty is void and of no effect if any serial numbers on the product are altered, replaced, defaced, missing or if service was attempted by an unauthorized service center. This limited warranty does not apply to any product not purchased and used in the United States.

This warranty only covers failures due to defects in material or workmanship which occur during normal use. It does not cover damage which occurs in shipment, or failures which are caused by repairs, alterations or products not supplied by FUNAI CORP., or damage, which results from accident, misuse, abuse, mishandling, misapplication, alteration, faulty installation, improper maintenance, commercial use such as hotel, rental or office use of this product, or damage which results from fire, flood, lightning or other acts of God.

THIS WARRANTY DOES NOT COVER PACKING MATERIALS, ANY ACCESSORIES (EXCEPT REMOTE CONTROL), ANY COSMETIC PARTS, COMPLETE ASSEMBLY PARTS, DEMO OR FLOOR MODELS.

FUNAI CORP. AND ITS REPRESENTATIVES OR AGENTS SHALL IN NO EVENT BE LIABLE FOR ANY GENERAL, INDIRECT OR CONSEQUENTIAL DAMAGES ARISING OUT OF OR OCCASIONED BY THE USE OF OR THE INABILITY TO USE THIS PRODUCT. THIS WARRANTY IS MADE IN LIEU OF ALL OTHER WARRANTIES, EXPRESS OR IMPLIED, AND OF ALL OTHER LIABILITIES ON THE PART OF FUNAI, ALL OTHER WARRANTIES INCLUDING THE WARRANTY OF MERCHANTABILITY AND FITNESS FOR A PARTICULAR PURPOSE, ARE HEREBY DISCLAIMED BY FUNAI AND ITS REPRESENTATIVES IN THE UNITED STATES.

ALL WARRANTY INSPECTIONS AND REPAIRS MUST BE PERFORMED BY AN AUTHORIZED SERVICE CENTER. THIS WARRANTY IS ONLY VALID WHEN THE UNIT IS CARRIED-IN TO AN AUTHORIZED SERVICE CENTER.

THE PRODUCT MUST BE ACCOMPANIED BY A COPY OF THE ORIGINAL RETAIL PURCHASE RECEIPT. IF NO PROOF OF PURCHASE IS ATTACHED, THE WARRANTY WILL NOT BE HONORED AND REPAIR COSTS WILL BE CHARGED.

IMPORTANT:

THIS LIMITED WARRANTY GIVES YOU SPECIFIC LEGAL RIGHTS. YOU MAY HAVE OTHER RIGHTS THAT VARY FROM STATE TO STATE. IF, AT ANY TIME DURING THE WARRANTY PERIOD, YOU ARE UNABLE TO OBTAIN SATISFACTION WITH THE REPAIR OF THIS PRODUCT, PLEASE CONTACT FUNAI CORP.

ATTENTION:

FUNAI CORP. RESERVES THE RIGHT TO MODIFY ANY DESIGN OF THIS PRODUCT WITHOUT PRIOR NOTICE.

WARRANTY STATEMENT REGARDING NON AUTHORIZED REPAIRS:

To obtain warranty service, you must take the product, or deliver the product freight prepaid, in either its original packaging or packaging affording an equal degree of protection, to any AUTHORIZED SERVICE CENTER. FUNAI CORP. will not reimburse you for any service done by unauthorized service providers without prior written approval.

To locate your nearest AUTHORIZED SERVICE CENTER or for general service inquiries, please contact us at:

FUNAI SERVICE CORPORATION
Tel: 1-800-605-8610
www.magnavox.com/support
2200 Spiegel Drive, Groveport, OH 43125

Free Manuals Download Website

<http://myh66.com>

<http://usermanuals.us>

<http://www.somanuals.com>

<http://www.4manuals.cc>

<http://www.manual-lib.com>

<http://www.404manual.com>

<http://www.luxmanual.com>

<http://aubethermostatmanual.com>

Golf course search by state

<http://golfingnear.com>

Email search by domain

<http://emailbydomain.com>

Auto manuals search

<http://auto.somanuals.com>

TV manuals search

<http://tv.somanuals.com>