

LOWRANCE®



Elite-7m Operation manual

Download from www.Somanuals.com. All Manuals Search And Download.

Copyright © 2012 Navico

All rights reserved.

Lowrance® and Navico® are registered trademarks of Navico.

Fishing Hot Spots® is a registered trademark of Fishing Hot Spots Inc.

Navionics® is a registered trademark of Navionics, Inc.

Navico may find it necessary to change or end our policies, regulations and special offers at any time. We reserve the right to do so without notice. All features and specifications subject to change without notice.

Compliance Statements

Lowrance Elite 7M

- meets the technical standards in accordance with Part 15.103 of the FCC rules
- complies with CE under RTTE directive 1999/5/EC
- complies with the requirements of level 2 devices of the Radiocommunications (Electromagnetic Compatibility) standard 2008

For more information please refer to our website: www.lowrance.com.

Warning

The user is cautioned that any changes or modifications not expressly approved by the party responsible for compliance could void the user's authority to operate the equipment.

This equipment has been tested and found to comply with the limits for a Class B digital device, pursuant to Part 15 of the FCC rules. These limits are designed to provide reasonable protection against harmful interference in a residential installation. This equipment generates, uses and can radiate radio frequency energy and, if not installed and used in accordance with the instructions, may cause harmful interference to radio communications. However, there is no guarantee that the interference will not occur in a particular installation. If this equipment does cause harmful interference to radio or television reception, which can be determined by turning the equipment off and on, the user is encouraged to try to correct the interference by one or more of the following measures:

- Reorient or relocate the receiving antenna
- Increase the separation between the equipment and receiver
- Connect the equipment into an outlet on a circuit different from that of the receiver
- Consult the dealer or an experienced technician for help









WARNING: When a GPS unit is used in a vehicle, the vehicle operator is solely responsible for operating the vehicle in a safe manner. Vehicle operators must maintain full surveillance of all pertinent driving and boating conditions at all times. An accident or collision resulting in damage to property, personal injury or death could occur if the operator of a GPS-equipped vehicle fails to pay full attention to travel conditions and vehicle operation while the vehicle is in motion.

Table of contents

Introduction	3	Entering text	7
Unit Controls.....	3	Cursor.....	7
Inserting microSD cards	4	Goto cursor.....	8
Basic Operation	5	Advanced Mode	8
Setup wizard.....	5	Standby mode	8
Pages	5	Restore defaults	8
Page menus	5	Pages	9
Accessing the Settings menu	6	Steer Page.....	9
Accessing menu items.....	6	Chart Page	9
Working with menus	6	Overlay Data.....	10
Dialogs.....	7		

Chart Operation	12	Alarms	26
Chart Menu.....	12	Saving Screenshots.....	26
Waypoints, Routes, Trails.....	13	Specifications	29
Routes Screen.....	14	Index	30
Trails Screen	18		
Orientation	20		
Chart Settings.....	21		
Navigation Settings	22		
Settings	24		
Settings menu.....	24		
System.....	24		

Unit Controls	
	LIGHT/POWER: controls backlight level and turns unit on/off
	KEYPAD: controls cursor & selects items on menus
	PAGES: allows you to select a page to view
	MENU: opens settings, context and page menus
	ENTER: finalizes menu selections; save waypoint at cursor position
	MOB: press and hold both Zoom keys to create a Man Overboard waypoint
	ZOOM Keys: used to zoom in/zoom out
microSD slot: insert a blank microSD card to save screen captures; or insert a microSD mapping card to use mapping data (See illustration on page 2)	

Getting Started	
Turn unit on/off	To turn on/off the unit, press and hold the LIGHT/POWER key for three seconds.
Man Overboard waypoint	Press the ZOOM IN and ZOOM OUT keys at the same time to set a Man Overboard waypoint. Your system will automatically create an active route back to the MOB waypoint. You must cancel navigation to terminate the function.
Adjusting the backlight	This unit has 10 backlight levels. Press the LIGHT/POWER key to switch backlight levels.
Muting Audio	Select Mute Audio from the System menu and press ENTER .
Selecting a GPS Source	Select GPS from the System settings menu. Highlight GPS source and press ENTER . Select the desired source.

Inserting microSD cards

Carefully slide the microSD card into the slot until it clicks into place.

To remove, carefully push in the card until it clicks out of place.

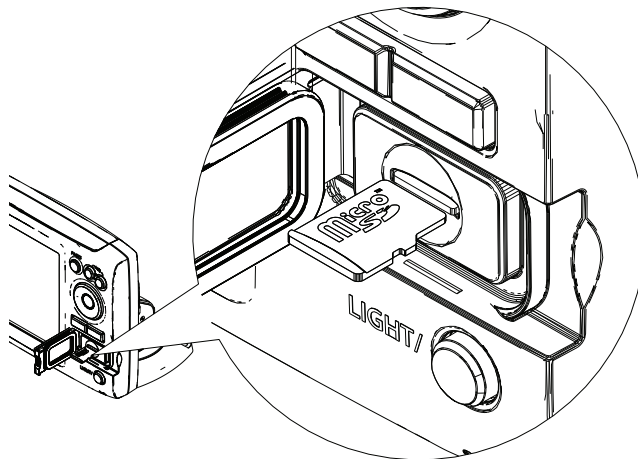

Basic Operation

Setup wizard

The Setup wizard will appear when the unit is turned on for the first time. To choose your own settings, do not run the setup wizard. To restart the Setup wizard, restore defaults.

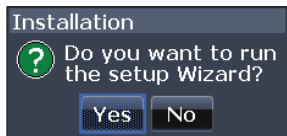

Pages

This unit has two pages: Steer and Chart. Press the pages key to switch pages.

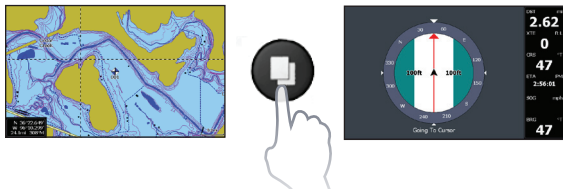

Page menus

The Steer and Chart pages have menus that can only be accessed when those pages are displayed.

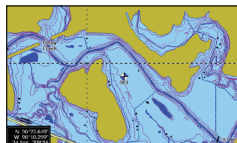

Chart page

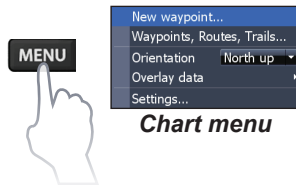
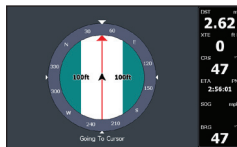
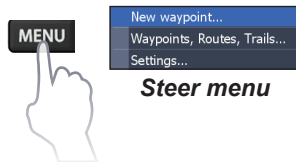

Chart menu



Steer page



Steer menu

Accessing the Settings menu

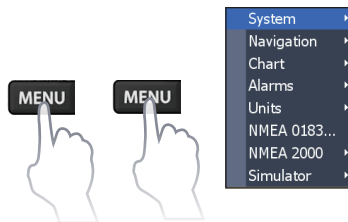

Accessing menu items

The keypad and **ENTER** key are used to select menu items and open submenus. Use the keypad to highlight the desired item and press **ENTER**.

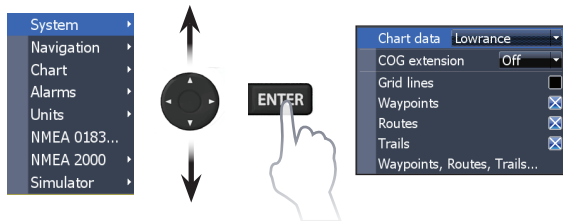

Working with menus

There are several menu types used to make adjustments to options and settings, including scrollbars, on/off features and dropdown menus.

Scrollbars

Select the scrollbar and press the keypad left (decrease) or right (increase).



On/Off features

Select the on/off item and press **ENTER** to turn it on/off.



Dropdown menus

Select the dropdown menu and press the keypad up/down to select the desired item. Press **ENTER**.

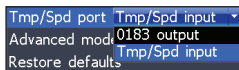

NOTE: Press the **MENU** key to Exit menus.

Dialogs

Dialogs are used for user input or for presenting information to the user. Depending on the type of information or entry, different methods are used to confirm, cancel or close the dialog.

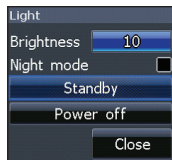

Entering text

Some functions, like naming a waypoint, route or trail, will require you to input text.

To input text:

1. Use the keypad to select the desired character and press **ENTER**.
2. Repeat Step 1 for each character.
3. When entry is completed, highlight **OK** and press **ENTER**.

Switches letters to uppercase/lowercase

Switches keyboard between Alpha and QWERTY layout

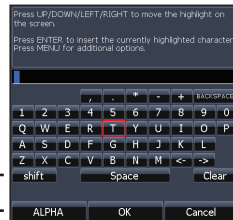

Cursor

The keypad moves the cursor around the display, allowing you to scroll the map, select map items and review sonar history.

Press **MENU** and select **Return to vessel** or **Exit cursor mode** to clear the cursor.

Goto cursor

Used to navigate to the cursor.

1. Move the cursor to a desired location and press **MENU**.
2. Select *Goto cursor* and press **ENTER**.

Advanced Mode

Enables advanced features and settings.

The following features are enabled when Advanced mode is turned on:

- Navigation (Enables arrival radius, off-course distance and Bearings setting)
- Alarms (Enables arrival, off course and anchor alarm options)
- NMEA 0183 Output
- Units (Enables distance, speed, depth, temperature, and bearings options)

Standby mode

Lowers power consumption by turning off sonar and the display.

Press the **PWR/LIGHT** key to access the Backlight dialog.

Select *Standby* and press **ENTER**.

Press any key to resume normal operation.



NOTE: *Leaving your unit in Standby mode when your boat is not in use will run down your battery.*

Restore defaults

Resets unit options and settings to defaults.

Pages

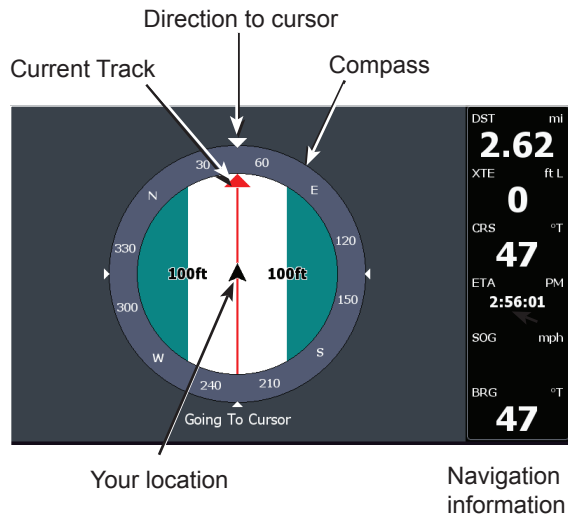

Steer Page

The Steer page has a compass that shows your current track, the direction to your destination, and a digital data navigation panel.

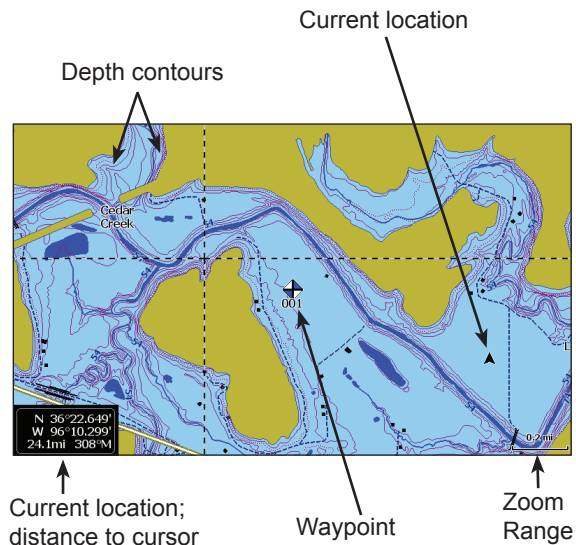
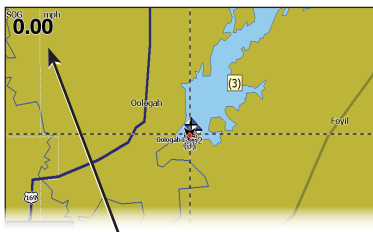

Chart Page

Consists of map that moves in real-time as you move. By default, the map is shown from a birds-eye view with North at the top of the screen.

Overlay Data

Used to select data shown on the Chart page.



Overlay data

Show

Enables/disables the display of overlay data, allowing you to remove overlay data from the screen without deleting the current overlay data configuration.

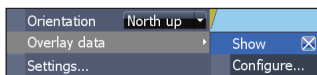

Configure

Allows you to select/customize overlay data.

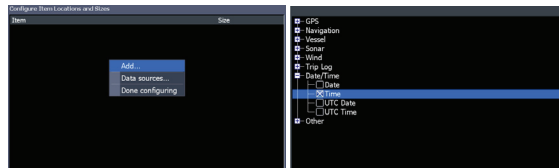

To add overlay data:

1. From the Chart page, press **MENU**.
2. Select *Overlay data* and press **ENTER**.
3. Select *Configure* and press **ENTER**.
4. Press *Menu* and select *Add*. Press **ENTER**.
5. Select a data category and press **ENTER**.
6. Select the desired data and press **ENTER**.
7. Press **MENU** and select *Return to Overlays*. Press **ENTER**.
8. Press **MENU**, select *Done Configuring* and press **ENTER**.

Customizing Overlay Data

You can select a data source, add/remove data and adjust the size and position of overlay data on the screen.

Select the desired overlay data from the Configure Item Locations and Sizes dialog and press **MENU**. The configuration menu will appear.

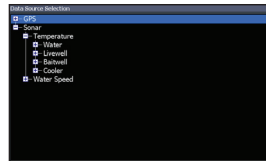
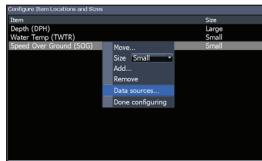
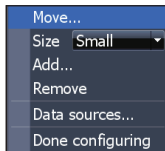

To select a data source:

1. Select *Data sources* and press **ENTER**.
2. Select the data type and press the keypad to the right.
3. Highlight the desired data source and press **ENTER**.

Data sources

Used to select the network device that will supply source data for a selected data type.

Chart Operation

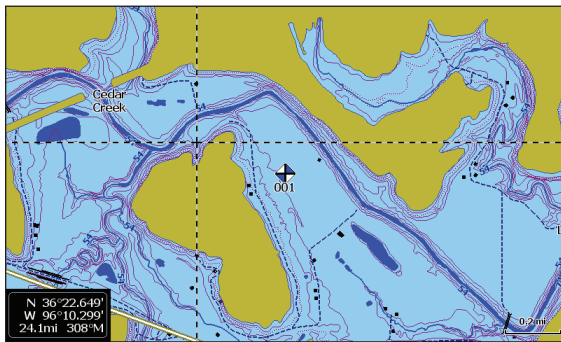
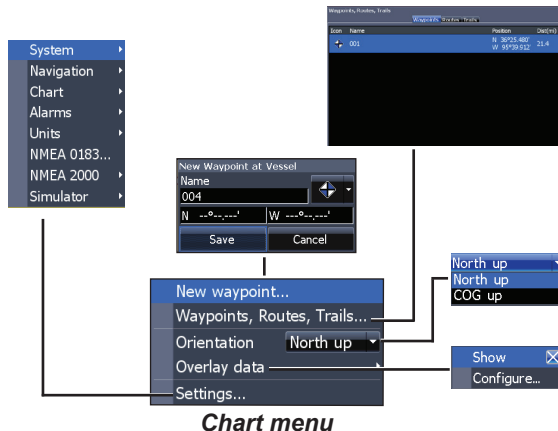

Chart Menu

Press **MENU** from any Chart pages to open the Chart menu.



New Waypoint

Creates a waypoint at your current location or at the cursor position. When the cursor is on the screen, waypoints will be saved at the cursor position; conversely, if the cursor is not displayed onscreen, waypoints will be saved at your current position.

Waypoints, Routes, Trails

Used to create, edit, navigate and delete waypoints, routes and trails.

Press the keypad left/right to toggle between waypoint, routes and trails tabs.

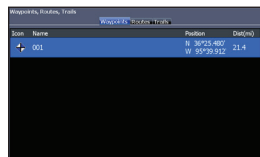

Waypoints Screen

MENU

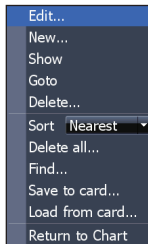

Waypoints menu

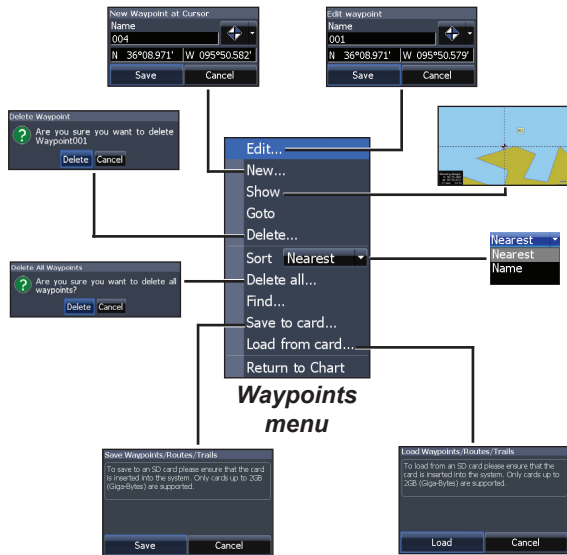

Edit

Allows you to edit the name, icon and latitude/longitude of a selected waypoint.

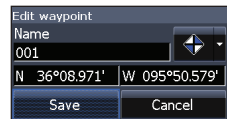

New

Creates a new waypoint at the cursor or vessel position. You can also select waypoint name, icon and latitude/longitude from the new waypoint menu.



Show

Displays the selected waypoint on the map.

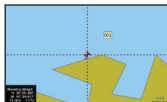

Goto

Allows you to navigate to a waypoint.

Delete and Delete All

Delete is used to delete a selected waypoint. Delete All deletes all waypoints.

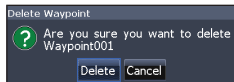

Sort

Controls how the waypoints list will be sorted — by name or by nearest.

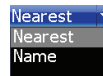

Routes Screen

Used to create, edit, navigate and delete routes. Use the keypad to highlight the Routes tab to access the Routes screen.

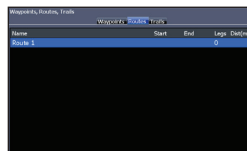

Routes screen

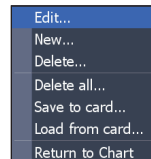

Routes menu

Creating a route

Routes can be created by inserting waypoints from the waypoints list or by using the cursor to position new points on the chart. You also can add waypoints to a route by selecting them from the chart screen.

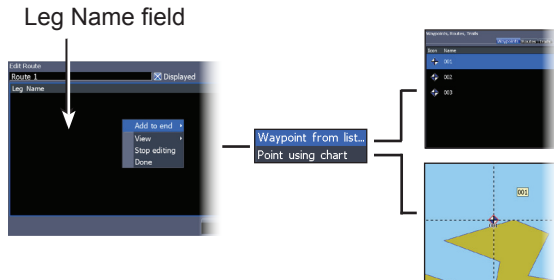
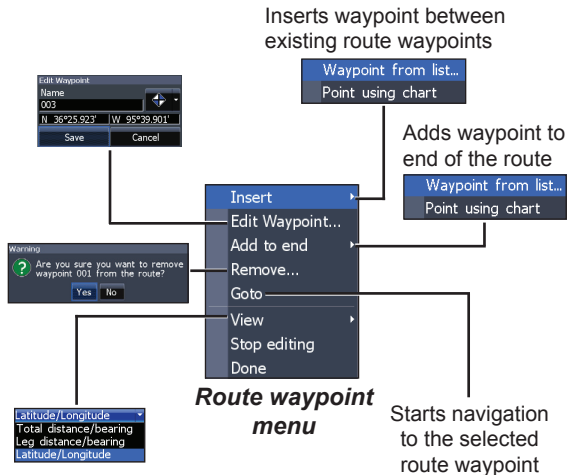

To create a route from waypoint list:

1. Press **MENU** from the Routes screen.
2. Select *New...* and press **ENTER**.
3. Press the keypad down to select the Leg Name field and press **ENTER**.
4. Press **MENU**, select *Add to End* and press **ENTER**.

5. Highlight *Waypoint* from list and press **ENTER**.
6. Select the desired waypoint and press **ENTER**.
7. Press **MENU** and select *Add to end* to add another waypoint to the route.
8. When the route is complete, press **MENU**, select *Stop Editing* and press **ENTER**.
9. Select *Save* and press **ENTER**.

Creating a route using points from chart:

1. Repeat Steps 1-4 from the instructions for Creating a route from waypoint list.
2. Select *Points from chart* and press **ENTER**. The chart page will appear.
3. Move the cursor to the desired location. Press **ENTER** to set a waypoint.
4. Repeat Step 3 to add more route waypoints.
5. Press **MENU** and select *Stop adding*. Press **ENTER**.
6. Highlight the *Save* button and press **ENTER**.

2. Select *Start* and press **ENTER**.
3. Select *Forward* or *Reverse* and press **ENTER**.
4. Press **MENU** and select *Return to Chart*. Press **ENTER**.

Navigating a route

Routes can be navigated in forward or reverse.

1. Select the desired route on the Route screen and press **MENU**.



Routes menu

To cancel navigation:

1. Press **Menu** from the chart screen.
2. Select **Navigation** and press **ENTER**.
3. Highlight **Cancel** and press **ENTER**.
4. Select **Yes** and press **ENTER**.

Edit and New Route menus

Used to edit/create routes, route names and to turn on/off the route display.

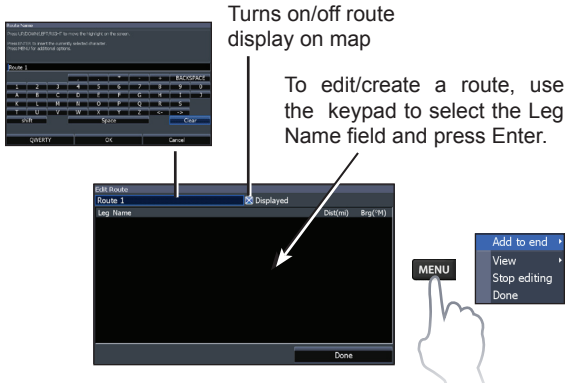

To access the Edit or New Route menu, select **Edit** or **New** on the Routes menu and press **ENTER**.

To finalize changes on the Edit or New Route menus, highlight the **Accept** button and press **ENTER**.

Displayed

Used to show/hide a route on the display, which prevents the screen from being cluttered by too many routes

Delete and Delete All

Delete is used to delete individual routes. Delete All, removes all routes.

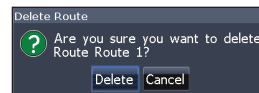

Trails Screen

Used to create, edit, navigate and delete trails. Use the keypad to highlight the Trails tab to access the Trails screen.

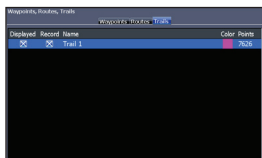

Trails screen

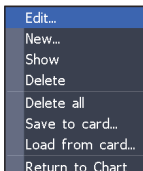

Trails menu

Creating trails

When creating a trail you can customize the trail name and color from the New Trail.

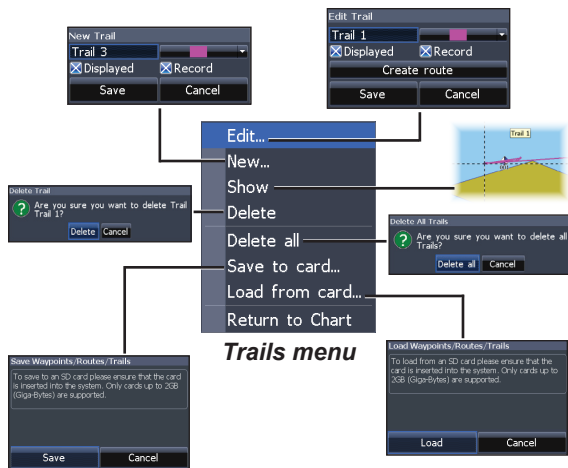

To create a trail:

1. Select *New* and press **ENTER**. The New Trail dialog will appear.
2. Select *Save* and press **ENTER**.

Edit and New Trail menus

Allows you to edit/create trails, select trails names, trail color, trail display and the trail being recorded. You can also convert a trail into a route from the Edit Trail menu.

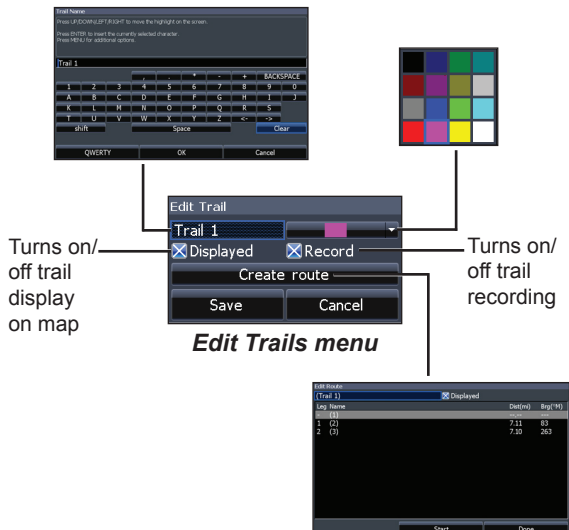

Navigating a trail

A trail must be saved as a route before it can be navigated.

To save a trail as a route:

1. Highlight the desired trail on the Trails screen and press **ENTER**. The Edit Trail menu will appear.
2. Highlight *Create Route* and press **ENTER**. The Edit Route menu will appear.
3. Highlight *Done* and press **ENTER**.
4. For navigation instructions refer to the Navigating a route segment.

Displayed and Record

Displayed allows you to show/hide trails on the map display, preventing the screen from being cluttered with trails.

The Record command allows you to record or resume recording a desired trail.

Delete and Delete All

Delete is used to remove individual trails. Delete All removes all trails.

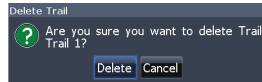

Orientation

Allows you to select North Up or Course Over Ground (COG) as the map orientation.

Overlay Data

Allows you to select data (course over ground, etc) to be displayed on top of the Chart page.

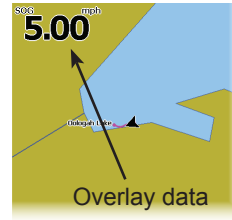

Overlay data setup is covered in the Pages section.

Settings

Accesses the Chart settings menu.

Chart Settings

Controls map data used on the chart screen as well as display settings like grid lines, waypoints, routes and trails.

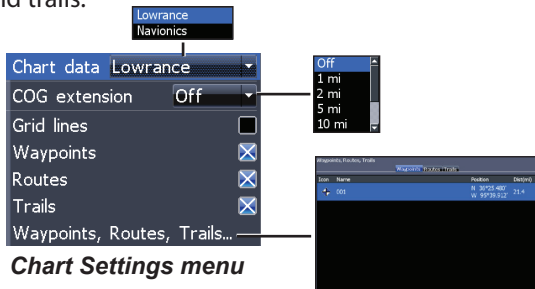

Chart Settings menu

Chart Data

Selects map data that will be used on the Chart display (Lowrance or Navionics regional map). Go to Navionics.com to see a full selection of available charts.

COG Extension

A line extending from the front of the current position icon that estimates the time and distance to areas in front of you.



Grid Lines

Displays base values for latitude and longitude, making it easier to get a general idea of your location on the latitude/longitude scale.

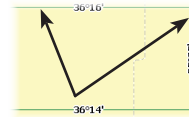

Waypoints, Routes and Trail displays

From the Chart Settings menu, you can turn on/off waypoint, route and trail display properties. Turning off display properties allows you to get a better view of the map, if the screen becomes cluttered with waypoints, routes and/or trails.

Waypoints, Routes, Trails

Accesses the Waypoints, Routes & Trails screen. Waypoints, Routes and Trails are covered in the Chart section.

Navigation Settings (Advanced mode only)

Controls Arrival Radius and Off Course distance settings and is used to turn on/off WAAS/MSAS/EGNOS.

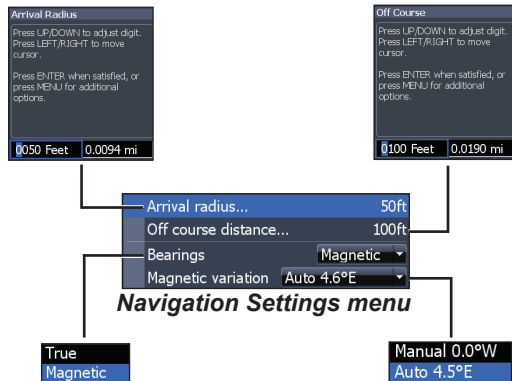

Arrival Radius

Sets the arrival radius threshold for the Arrival alarm. The arrival alarm will sound when your vessel comes within a selected distance (arrival radius) of the destination waypoint.

Off Course Distance

Sets Off Course Distance threshold for the Off Course alarm. When the selected off course distance is exceeded, the Off Course alarm will sound when the alarm is enabled.

Bearings

Controls whether bearing will be calculated using True North or Magnetic North. Magnetic North should be used when navigating with a compass course or heading; otherwise use the default setting, True North.

Magnetic Variation

Controls whether magnetic variation will be calculated using Automatic or Manual settings. Magnetic variation is the angle between magnetic north and true north. The automatic setting reconciles the variation for you.



WARNING: *You should only use the Manual magnetic variation setting if you have variation information from a verified source.*

Settings

Settings menu

Accesses installation and configuration settings for your unit.

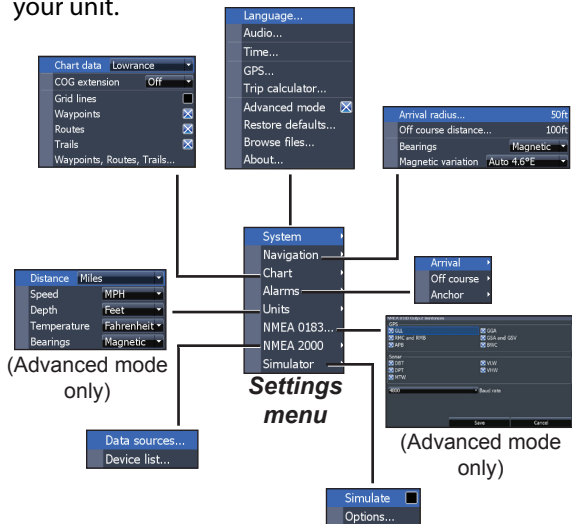

System

Adjusts unit settings like language, mute audio and advanced mode.

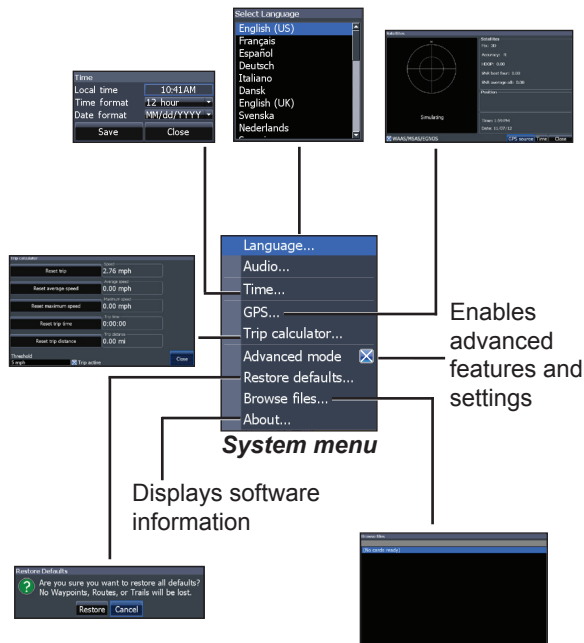

Set Language

Selects the language used on menus and text boxes.



Audio

Adjusts volume and turns on/off unit audio, like key beeps, alarm sounds, etc.

Time

Used to set local time, and time and date formats for your unit.

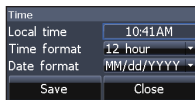

GPS

Monitors the location of satellites in view and the quality of the unit's satellite lock-on.

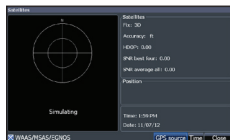

Trip Calculator

Tracks trip time, speed and distance when you are moving faster than the selected threshold.

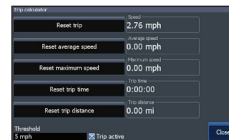

Advanced Mode

Enables features and settings only available with unit in Advanced Mode.

Restore Defaults

Switches the unit back to default settings.

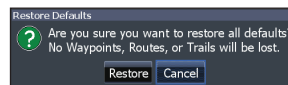

Browse Files

Allows you to view a list of the files saved to the microSD card.

Saving Screenshots

You can save screenshots to a microSD card by inserting a microSD card into the card slot and pressing Power and then Zoom (+).

You must view files on a computer or other microSD compatible device.



NOTE: You cannot save screenshots to a Navionics card or other mapping cards.

About

Displays software information about this unit. Before attempting a software update, you can check the version of software your unit is using by accessing the About screen.

Lowrance periodically updates unit software to add features and improve functionality. To see the latest available software version go to www.lowrance.com.

Alarms

Enables alarms and selects alarm thresholds. Arrival, Off Course and Anchor alarms are only available in Advanced mode.

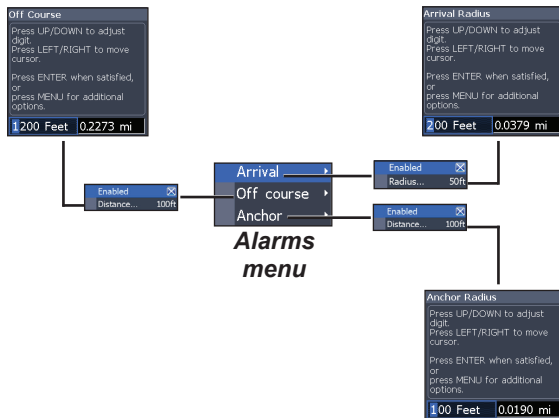

Alarms	
Arrival	sounds alarm when you are within a selected distance of your destination (Advanced Mode only)
Off Course	sounds alarm when course exceeds a selected off-course threshold (Advanced Mode only)
Anchor	sounds alarm when vessel moves a selected distance (Advanced Mode only)

Units

Allows you to select the unit of measure used by the unit. Unit options vary depending on whether the unit is in basic or advanced mode.

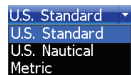

Basic Mode



Advanced Mode

NMEA 0183 Output

You can select the NMEA 0183 sentences the unit will use when connected to a VHF radio or other NMEA 0183 device.

You can also adjust the Baud rate, but the default setting works best under most conditions.

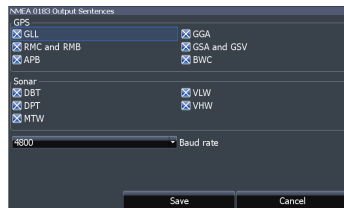

NMEA 2000

With the unit connected to a NMEA 2000 network, you can select a GPS antenna on the network as your GPS source, and share newly created waypoints with other display units on the network.

You will not be able to share existing waypoints. Only waypoints created while the unit is connected to a NMEA 2000 network can be shared, and only with units on that network.

Simulator

Simulates GPS and/or sonar activity. Simulations can be customized on the Simulator options menu.

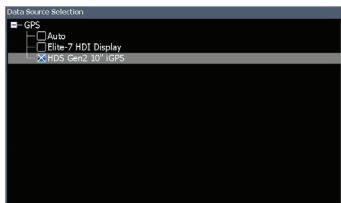

Selecting a GPS source

Data sources

Allows you to select the source this unit will use for GPS data.

Device list

Used to view data for devices connected to your NMEA 2000 network.

Elite 7m	
General	
Case Size	5.3" H (234mm) x 9.2" W (136mm); 5.9" H (151mm) with bracket
Display	(7" diagonal) 16-bit color Full VGA Solar MAX™ 800x480 color TFT
Waterproof standard	IPX7
Backlight	LED (10 levels)
Communications	NMEA 2000 NMEA 0183 Output
Declaration of Conformity	Part 15.103 FCC rules & CE RTTE directive 1999/5/EC
Power	
Transmit Power	250W RMS
Power Requirement	12V
Voltage Input	10 to 17V
Current drain	Typical: 1.1A
Fuse type	3-amp Automotive

GPS	
Mapping card slot	microSD and microSDHC
GPS Antenna	16 parallel channel (internal); optional external GPS antenna sold separately
Mapping compatibility	Fishing Hot Spots, NauticPath & Navionics (Hotmaps, Premium and Gold)
Waypoints, Routes & Trails	Up to 3000 waypoints, 100 routes and 100 retracable plot trails

Index

- A**
 - About 26
 - Advanced Mode 8
 - Alarms 26
 - Anchor alarm 27
 - Arrival alarm 27
 - Arrival Radius 23
- B**
 - Bearings 23
 - Browse Files 25
- C**
 - Cancel navigation 17
 - Chart 21
 - Chart Data 21
 - Chart menu 21
 - Chart Page 9
 - COG Extension 21
 - Creating a route 14
 - Creating trails 18
 - Cursor 7
- D**
 - Data Port 25
 - Dialogs 7
 - Dropdown menus 7
- E**
 - Editing waypoints 13
- G**
 - Goto cursor 8
 - Goto waypoint 14
 - GPS Source 25
 - GPS Status 25
 - Grid Lines 21
- L**
 - Language 25
- M**
 - Magnetic Variation 23
 - Man Overboard waypoint 3
 - Man Overboard waypoint 3
 - microSD cards 4
 - Mute Audio 25
- N**
 - Navigating a route 16
 - Navigating a trail 19
 - Navigation 22
 - Navigation menu 22
 - New Waypoint 12
 - NMEA 0183 27
 - NMEA 2000 27
 - Data sources 28
- O**
 - Off Course alarm 27
 - Off Course Distance 23
 - On/Off features 6
 - Orientation 20

Overlay Data 10, 20
 Configure 10
 Customizing 11
 Show 10

P

Page menus 5

R

Route display 22
Routes Screen 14

S

Saving Screenshots 26
Scrollbars 6
Setup wizard 5
Software Updates 26
Sort waypoints 14

Standby mode 8
Steer Page 9
System settings 24

T

Text entry 7
Time 25
Trail display 22
Trails Screen 18
Turn unit on/off 3

U

Unit Controls 3
Units 27

W

Waypoint display 22
Waypoints, Routes,
 Trails 13
Working with menus 6

Navico Databases License Agreement

THIS IS A LEGAL AGREEMENT BETWEEN THE END-USER WHO FIRST PURCHASES THIS PRODUCT AS A CONSUMER ITEM FOR PERSONAL, FAMILY, OR HOUSEHOLD USE ("YOU") AND NAVICO, THE MANUFACTURER OF THIS PRODUCT ("WE", "OUR", OR "US").

USING THE PRODUCT ACCOMPANIED BY THIS LICENSE AGREEMENT CONSTITUTES ACCEPTANCE OF THESE TERMS AND CONDITIONS.

IF YOU DO NOT ACCEPT ALL TERMS AND CONDITIONS, PROMPTLY RETURN THE PRODUCT WITHIN 30 DAYS OF PURCHASE. PLEASE RETURN USING THE ENCLOSED UPS SHIPPING LABEL AND INCLUDE: PROOF OF PURCHASE, NAME, ADDRESS, AND PHONE NUMBER. YOUR PURCHASE PRICE AND ANY APPLICABLE TAXES WILL BE REFUNDED. PLEASE ALLOW 4-6 WEEKS TO PROCESS YOUR REFUND.

1. This License Agreement applies to the one or more databases that your product may contain. We refer to these singly as a "Database" and together as the "Databases." Your product may thus include the "WBS Database" which contains worldwide background surface mapping data, the "Indigo Database" which contains inland mapping data, or other Databases.
2. The Databases that your product may contain are licensed, not sold. We grant to you the nonexclusive, nonassignable right to use these Databases for supplemental navigation reference purposes, but only as long as you comply with the terms and conditions of this License Agreement. We reserve the right to terminate this license if you violate any aspect of this License Agreement. You are responsible for using official government charts and prudent navigation for safe travel.
3. The Databases housed in your product are protected by the copyright notices appearing on the product or its screen(s). You may NOT modify, adapt, translate, reverse engineer, decompile, disassemble, rent, lease, or resell any Database, and you may NOT create derivative works based upon any Database or its contents. Any unauthorized reproduction, use, or transfer of a Database may be a crime and may subject you to damages and attorney fees.
4. This License Agreement will terminate immediately without prior notice from us if you fail to comply with or violate any of the provisions of this Agreement. Upon termination, you will promptly return all products containing one or more Databases to us.
5. Prices and programs are subject to change without notice.
6. This License Agreement shall be governed by the laws of the State of Oklahoma and comprises the complete and exclusive understanding between you and us concerning the above subject matter.

Databases Limited Warranty

"We", "our", or "us" refers to Navico, the manufacturer of this product. "You" or "your" refers to the first person who purchases the product as a consumer item for personal, family, or household use. The Databases Limited Warranty applies to the one or more databases that your product may contain. We refer to each of these as a "Database" or together as the "Databases." Your product may thus include the "WBS Database" which contains worldwide background surface mapping data, the "Indigo Database" which contains inland mapping data, or other Databases.

We warrant to you that we have accurately compiled, processed, and reproduced the portions of the source material on which the Databases are based. However, we are under no obligation to provide updates to the Databases, and the data contained in the Databases may be incomplete when compared to the source material. WE MAKE NO EXPRESS OR IMPLIED WARRANTY OF ANY KIND ABOUT THE ACCURACY OF THE SOURCE MATERIAL ITSELF, INCLUDING BUT NOT LIMITED TO IMPLIED WARRANTIES OF MERCHANTABILITY OR FITNESS FOR A PARTICULAR PURPOSE.

If there is a defect in any Database, your exclusive remedy shall be, at our option, either a refund of the price you paid for the product containing the defective Database or a replacement of such product. WE WILL NOT UNDER ANY CIRCUMSTANCES BE LIABLE TO ANYONE FOR ANY SPECIAL, CONSEQUENTIAL, INCIDENTAL, OR OTHER INDIRECT DAMAGE OF ANY KIND.

Some states do not allow the exclusion or limitation of incidental or consequential damages, so the above limitations or exclusions may not apply to you.

This warranty does NOT apply in the following circumstances: (1) when the product has been serviced or repaired by anyone other than us; (2) when the product has been connected, installed, combined, altered, adjusted, or handled in a manner other than according to the instructions furnished with the product; (3) when any serial number has been effaced, altered, or removed; or (4) when any defect, problem, loss, or damage has resulted from any accident, misuse, negligence, or carelessness, or from any failure to provide reasonable and necessary maintenance in accordance with the instructions of the owner's manual for the product.

We reserve the right to make changes or improvements in our products from time to time without incurring the obligation to install such improvements or changes on equipment or items previously manufactured.

This warranty gives you specific legal rights and you may also have other rights which may vary from state to state.

Your remedies under this warranty will be available so long as you can show in a reasonable manner that the defect occurred within one (1) year from the date of your original purchase, and we must receive your warranty claim no later than 30 days after such 1-year period expires. Your claim must be substantiated by a dated sales receipt or sales slip.

Contact information

Customer Service:

1-800-628-4487

(8 a.m. to 5 p.m. Central Standard Time, M-F)

(Canada)

1-855-361-1564

canada@navico.com

(8 a.m. to 5 p.m. Eastern Standard Time, M-F)

Ordering Accessories

<http://store.navico.com/>

Visit our website

www.lowrance.com

Visit our website:

www.lowrance.com



Download from Www.Somanuals.com. All Manuals Search And Download.



Free Manuals Download Website

<http://myh66.com>

<http://usermanuals.us>

<http://www.somanuals.com>

<http://www.4manuals.cc>

<http://www.manual-lib.com>

<http://www.404manual.com>

<http://www.luxmanual.com>

<http://aubethermostatmanual.com>

Golf course search by state

<http://golfingnear.com>

Email search by domain

<http://emailbydomain.com>

Auto manuals search

<http://auto.somanuals.com>

TV manuals search

<http://tv.somanuals.com>