



## Little Glass House

Integrated Secured Protection  
for Network Equipment

# USER MANUAL

English



<b>SAFETY INSTRUCTIONS .....</b>	<b>3</b>
<b>GLOSSARY OF SYMBOLS.....</b>	<b>3</b>
<b>INTRODUCTION .....</b>	<b>4</b>
UPS SUPPORT.....	5
<b>INSTALLATION.....</b>	<b>5</b>
UNLOADING AND INSPECTION .....	5
LOCATION.....	5
INSTALLATION CONNECTIONS .....	6
INSTALLING CUSTOMER EQUIPMENT .....	6
START-UP .....	7
<b>OPERATION .....</b>	<b>8</b>
ENVIRONMENTAL CONTROL MODULE (ECM) & UNINTERRUPTIBLE AIR SUPPLY™ (UAS).....	8
FORCED AIR COOLING (FAC).....	8
SITENET® INTEGRATOR®.....	8
SENSOR OPTIONS .....	9
<b>MAINTENANCE .....</b>	<b>10</b>
FILTER CLEANING.....	10
ECM REPLACEMENT.....	10
UPS REPLACEMENT .....	10
<b>TABLES .....</b>	<b>11</b>
FORCED AIR COOLING (FAC) PERFORMANCE DATA (WITH 30PPI FILTER) .....	11
ENVIRONMENTAL COOLING MODULE (ECM) PERFORMANCE DATA.....	11
FIXED SERVICE CONNECTION (AMPS).....	12
MAX. AVAILABLE CUSTOMER EQUIPMENT AMPS .....	12
FULL LOAD AMP DRAW (230V - 50Hz) .....	12
<b>DRAWINGS.....</b>	<b>13</b>
<b>TROUBLESHOOTING.....</b>	<b>23</b>

<b>Model Number Breakdown</b>					
<b>RD</b>	<b>78 38</b>	<b>M</b>	<b>D</b>	<b>E</b>	<b>K</b>
Enclosure Rack Width	Enclosure Height/ Depth	Main or Cluster	Primary Cooling System	UPS Rack-Mount	Input Power
RD=24" Rack HD=19" Rack	78" Height 72" Height 38" Depth 34" Depth (Nominal)	M = Main C = Cluster	A = FAC-190 B = FAC-360 C = ECM-42 D = ECM-62 E = N/A F = ECM-80	0 = None A = N/A B = N/A C = GXT-1000 D = N/A E = GXT-1500 F = N/A G = GXT-2000	K = 120V/60Hz/1PH S = 230V/50Hz/1PH

## SAVE THESE IMPORTANT SAFETY INSTRUCTIONS

**WARNING:** Do not attempt to service this product yourself. Opening or removing covers will risk exposure to dangerous voltages. Refer all servicing to qualified service personnel.

- 1. SAVE THESE INSTRUCTIONS.** THIS MANUAL CONTAINS IMPORTANT SAFETY INSTRUCTIONS. Read all safety and operating instructions before operating the Little Glass House (LGH). Adhere to all warnings on the unit and in this manual. Follow all operating and user instructions.  
CONSERVER CES INSTRUCTIONS. CETTE NOTICE CONTIENT DES INSTRUCTIONS IMPORTANTES CONCERNANT LA SÉCURITÉ.
- This product is designed for Commercial/Industrial use only. It is not intended for use with life support and other designated "critical" devices. Maximum load must not exceed that shown on the LGH rating label. If uncertain, consult your dealer. See Limited Warranty.
- The LGH must be permanently connected to the input AC/mains supply and protected by a suitable circuit breaker or fuse.
- The LGH must be powered from a suitable single phase supply rated in accordance with the equipment data plate, and must be suitably grounded/earthed.
- The utility/mains supply socket or means of isolation must be within 2 meters of the equipment and accessible to the operator.
- This equipment complies with the requirements of the EMC Directive 89/336/EEC and the published technical standards. Continued compliance requires installation in accordance with these instructions and the use of manufacturer approved accessories with output cables not exceeding 10 meters (30 ft.) in length. Use a shielded cable for the external communications interface.
- Route power supply cords so they are not walked on or pinched.
- Never block or insert any object into the ventilation holes or other openings. Maintain a minimum clearance of 305 mm (12 inches) in front and rear of the LGH for proper air flow and cooling.
- Operate the LGH in an indoor environment only with an ambient temperature range of 0° C to +40° C (32° F to +104° F). Install it in a clean environment, free from moisture, flammable liquids, gasses, or corrosive substances.
- Storing magnetic media on top of the LGH may result in data loss or corruption.
- Do not stand beverage containers on the LGH.
- This equipment can be operated by individuals without previous training.
- 13. Qualified Personnel should be consulted for the following conditions:**
  - Power cable is damaged
  - Liquid spilled into product
  - LGH does not operate when operating instructions have been followed.

## Glossary of Symbols



Indicates weight



Indicates a Ground/Earth connection



Indicates a **Warning** - Hazardous Voltage Present



Consult the user's manual for additional information



Indicates **Caution:** Note the accompanying instruction



Indicates alternating current

# INTRODUCTION

Your Liebert Little Glass House™ (LGH) will provide a secure controlled environment in a single factory assembled enclosure. The integrated/matched models are designed to control the environment and provide smooth reliable power so that your sensitive computer and network equipment will provide the reliable performance you depend upon for your business operations.

The Little Glass House is completely factory assembled and tested, ready for you to install your equipment and plug the unit into a 120 V~/60 Hz or 230 V~/50 Hz dedicated outlet. For 60 Hz models, the required power receptacle/socket may be 15, 20, or 30 Amps, depending on your selected LGH. Models with 60 Hz ECM-80 uses two input power connections, with one 20 Amp plug for the ECM-80 and the other plug either 15 or 20 Amps depending on the UPS model. For 50 Hz models, a power cord is included for connection to a customer supplied plug.

Refer to drawings and tables in this manual for dimensions, environmental performance data, and input power requirements. Refer to the separate UPS manual for UPS performance details.

## ENCLOSURE

The enclosure can accommodate shelf mounted or rack mounted equipment, on either 19 or 24 inch punched rails (per EIA-310). The 19 inch rack cabinets are 25 inches (635 mm) wide. Cabinets with 24 inch racks are 30 inches (765 mm) wide. The enclosures can be nominal 72 or 78 inches (1830 or 1980 mm) high, and 34 or 38 inches (865 or 965 mm) deep. The unit is mounted on casters and leveling feet. Interior insulation is provided in models with Environmental Control Module (ECM) cooling.

A solid panel (metal) front door is standard. A smoked plastic front window is available to maintain enclosure security while allowing you to monitor equipment status. The rear door provides convenient access to customer wiring. Two horizontal cable entrance raceways are provided. An optional internal cable management raceway (vertical) is available. Both doors have a key lock and a four point latch.

## ENVIRONMENTAL CONTROL

The Uninterruptible Air Supply™ (UAS) consists of an Environmental Control Module (ECM) and a Back-up Cooling Fan. The ECM is normally sized to match the capacity of the UPS module plus heat transmitted into the LGH. Three ECM modules, ECM-42, ECM-62, and ECM-80 are available. Air is controlled and circulated within the enclosure. Outside (ambient) air is used to remove heat from the enclosure through the air cooled condenser. Two-speed fans are used to provide quiet operation. At rated maximum ambient conditions, the temperature inside the enclosure will be from 70° to 95°F (21 to 35°C), depending on the electronics load. If the internal cabinet temperature reaches 100°F (38°C) -- for example, during a power failure -- the Back-up Cooling Fan operated on UPS battery power will flow filtered ambient air through the enclosure.

The Back-up Cooling Fan is standard on UAS models. All UAS or ECM models require a clearance of 12 inches (305 mm) both on top and rear of the LGH for proper airflow. The 50 Hz back-up cooling options have an On/Off (O/I) switch located in the inlet channel to the ECM condenser coil. This switch should be on during normal operation.

If environmental control as previously described is not required, Forced Air Cooling (FAC) is available. Filtered ambient air is drawn through the enclosure from the bottom front to the top rear. A two-speed fan is controlled by a thermostat factory set at 80°F (27°C), which measures air entering the unit. The two-speed fan design provides quiet low-speed operation below the thermostat set point. A single fan (nominally rated at 190 CFM - 323 CMH) or dual fans (nominally rated at 360 CFM - 611 CMH) can be provided. A clearance of 12 inches (305 mm) is required both on top and rear of the LGH for FAC models.

## UPS SUPPORT

The integrated/matched models include an uninterruptible power supply (UPS) module to provide surge suppression, regulated voltage and frequency, and battery backed operating time. This will allow you to perform a controlled computer shutdown in the event of a utility/mains power failure. The UPS supplied is a rackmount model factory installed in the rack rails and supported by brackets. UPS models available include the on-line Liebert UPStation GXT in 1000, 1500, or 2000 VA capacity. Refer to the separate UPS manual for more details.

## EQUIPMENT MOUNTING OPTIONS

Optional equipment mounting hardware is available including a fixed shelf, a pullout shelf, 19 inch to 24 inch rack rail adapters, threaded adapters, adjustable position rack rails and Compaq® adapters. Each optional kit is supplied with installation hardware.

## CLUSTERED CONFIGURATIONS

For applications requiring more than one enclosure, an optional Cluster Enclosure is available. In addition to providing more space for electronic equipment, this configuration allows cabinets to be connected side-by-side so that an ECM, FAC, or UPS can serve more than one cabinet. Refer to separate installation instructions provided with the cluster cabinet.

## HEAT REJECTION DUCT

For applications in confined spaces (equipment rooms or closets), an optional Heat Rejection Duct is available to connect the Little Glass House to a ducted ventilation system. Refer to drawing on page 19 in this manual for details.

# INSTALLATION

## UNLOADING AND INSPECTION

Refer to drawing on page 13 for dimensions, weight, and connection locations for your model.

Carefully unload your new Little Glass House™ (LGH) from the box and from the pallet. Note the unit weight for your model. Use at least two people for safe handling.

Unloading Procedure:

1. Cut bands. Use caution.
2. Remove cardboard and plastic.
3. Remove two 2 X 4's from sides of unit.
4. Remove one 2 X 6 from rear of unit.
5. Remove four lag bolts from front of skid.
6. Remove one 2 X 6 from front of unit.
7. Slide 4 X 4 runner from under front of skid.
8. Move unit forward until skid and unit tilt.
9. Roll unit off front of skid.

Open the doors and locate the keys, which are shipped inside the enclosure. The front and rear locks use the same key. To open either door, turn key clockwise 1/8 turn to unlock, lift bottom of handle, then turn handle away from unit 1/4 turn to open.

Inspect exterior and interior for shipping damage. If any damage is noted, file a claim with the shipper and inform your Liebert supplier.

## LOCATION

The unit should be located in a room where the ambient air is adequately ventilated for the peripheral equipment (printers, etc.) outside the LGH. The maximum ambient operating condition for 60 Hz units is 105°F (40°C). For 50 Hz units, maximum ambient temperature is 100°F (38°C). Place unit on a level surface, or use leveling feet to level the unit.

Note the dimensions for your selected Little Glass House model to determine space required. Units with UAS or ECM require a clearance of 12 inches (305 mm) both on top and rear of the LGH. Units with Forced Air Cooling (FAC) require 12 inches (305 mm) of top and rear clearance. Air is drawn through the front intake louver and discharged at the rear. Do not block air flow at the front or the rear. The optional Heat Rejection Duct will require additional rear clearance.

<b>ALCOVE INSTALLATION</b>			
	ECM	ECM/UAS	FAC
Rear	12"	12"	12"
Top	12"	12"	12"
Sides	0"	0"	0"
Bottom	Non-Restricted		

The unit can be rolled forward on casters for easy access to Liebert and customer wiring at the rear of the unit. To open the front door, clearance required depends on the size of your unit. No side clearance is needed.

For applications requiring more than one enclosure, an optional Cluster Enclosure is available. In addition to providing more space for electronic equipment, this configuration allows cabinets to be connected side-by-side so that an ECM, FAC, or UPS can serve more than one cabinet.

### INSTALLATION CONNECTIONS

The Little Glass House is a self-contained unit. The only required connection is for electric power. For 60 Hz models, the power cord is 9 (2.7 m) feet long and has a NEMA 120 V~ plug, sized for current (Amps) based on equipment specified when ordered. For 50 Hz models, a power cord is included for connection to a customer supplied plug. The 60 Hz ECM-80 model uses two input power connections, with one 20 Amp plug for the ECM-80 and the other plug either 15 or 20 Amps depending on the UPS model. Refer to table on page 11. The LGH and its protected equipment should be on a dedicated circuit and circuit breaker.

Do not defeat ground/earth connections between the utility/mains outlet and the Little Glass House. All plug receptacles/sockets in the vicinity of where the LGH will be used must be a ground/earth type and grounded/earthed with an insulated ground/earth conductor of identical size, insulation material, and thickness to the grounded/earthed and ungrounded/earthed supply conductors which is grounded/earthed to ground/earth at the service equipment or separately derived source.

NOTE: The utility/mains output must have the neutral and ground/earth bonded, per the National Electrical Code, to prevent damage to the UPS. Damage related to faulty utility/mains wiring is not covered by Liebert warranty.

Contacts are provided to annunciate two alarms: High Temperature (100°F - 38°C internal, Back-

up Cooling Fan operating) and Dirty Air Filter (filter is clogged and requires cleaning). Customer connection is two compression lug terminals inside the rear of the unit. These normally open contacts are rated for 40 milliAmps at 30 volts maximum (Class 2 wiring).

A contact is provided on the rear of the ECM to indicate power to the compressor (Compressor on/off). This normally open contact is rated for 0.5 Amp at 120 V~.

A control contact is provided inside the ECM (under access plate at top left rear) for remote shutdown/ startup. To use, replace jumper on 37 and 38 with a normally open non-powered switch, rated for 5 Amps at 120 V~.

To allow communications between the UPS and a LAN server or other computer system, the available UPStation GXT is equipped with an RS-232 interface port. Other UPS communication options are available, including SNMP. Refer to the separate UPS manual for details.

The optional SiteNet™ Integrator is a separate rackmount unit which communicates status of the UPS and Little Glass House (including temperature/humidity and several contact closures) in SNMP protocol to a network management system.

No plumbing connections are required as ECM condensate is evaporated into the heat rejection airstream. A condensate drain tube (3/8 inch O.D. copper) is provided with ECM, but a customer connection is not necessary. The drain connection may need to be used in exceptional situations, such as if a door is left open for longer than 15 minutes while the ECM is operating.

### INSTALLING CUSTOMER EQUIPMENT

The Little Glass House can accommodate rack mounted or freestanding computer and network equipment. The unit contains 19 or 24 inch punched rack rails (per EIA 310), depending on model selected. Rack rails are provided at the front and rear of the enclosure. Mounting hardware available from your Liebert representative includes a fixed shelf, a pullout shelf, 19 inch to 24 inch rack rail adapters, threaded adapters, adjustable position rack rails and Compaq® adapters. Each optional kit is supplied with installation hardware.

To maintain unit center of gravity as low as possible, install customer equipment from the

bottom up, starting with the heavier units. Leave available space (if any) at the top of the enclosure.

**CAUTION:** To avoid tipping the unit when it is being moved, push slowly on the lower part of the enclosure. After customer equipment is installed, the Little Glass House may have a high center of gravity.

The LGH can support an electrical load based on the UPS capacity. For integrated/matched models, the Environmental Control Module is normally sized to match the capacity of the UPS plus heat transmitted into the enclosure. A larger UPS can be supplied for longer battery time. For 60 Hz units without a UPS, the customer specifies maximum Amp load to determine proper NEMA power plug rating.

**NOTE:** To charge the UPS batteries before using the unit, you can apply power to the UPS module while you are installing your equipment. Install your critical equipment in the Little Glass House. Use the two vertical channels at the rear of the unit for routing customer wiring. Power and communication wiring should be kept separate as much as possible.

The optional power strip includes a circuit breaker. The 60 Hz model includes 10 5-15R 15 Amp, 120 V~ receptacles/sockets. The 50 Hz model includes 10 CEE22 (IEC320) 10 Amp, 250 V~ receptacles/sockets. The power strip is protected by the UPS if a UPS is included. As viewed from the rear, the ten power outlets are on the right side. Power wiring is intended to be routed on the right. Communication and control wiring should be routed to the left side.

Provide enough length on customer supplied cables to allow unit to be rolled forward for rear access. Remember to connect a cable to the Little Glass House alarm contacts if required for your installation. Route customer wiring through the two horizontal cable entrance raceways. An optional internal cable management raceway (vertical) is available.

## START-UP

Before applying power, make sure the computer equipment and power switches are in the OFF position. Plug the Little Glass House power cable into the customer provided receptacles/sockets. Be certain there are no obstructions (such as wires, conduit, or trash) to the front or sides of the ECM. Make sure all doors shut and seal properly. Roll the unit into final position according to the location section on page 4. If heat rejection duct option is included, be sure there are no loops or kinks in the duct.

Turn on the Environmental Control Module (ECM), or Forced Air Cooling system (FAC). Then turn on the UPS, if included. If UPS status indication is normal, turn on your computer and network equipment. The UPS will immediately supply regulated power. Battery back-up will be available after batteries are fully charged.

The 60Hz Environmental Control Module has a lighted power switch. The power switch for the 50 Hz models is the circuit breaker "B" on the electric service assembly. ECM temperature and capacity controls, including hot gas bypass, are factory set. The FAC models have a temperature switch factory set at 80°F (27°C), which measures air entering the unit. The front air filter requires periodic cleaning.

**CAUTION:** To avoid excessive condensation, turn off the Environmental Control Module any time an LGH door will be open for more than 15 minutes.

The UPS module has user friendly controls and indicators. Refer to separate UPS manual for details of UPS operation and LED indicators.

**CAUTION:** To maintain UPS battery capacity, do not store Little Glass House for more than 6 months without applying power.

Call your Liebert supplier if you have any questions or problems during the installation or operation of your Little Glass House.

## OPERATION

### ENVIRONMENTAL CONTROL MODULE (ECM) & UNINTERRUPTIBLE AIR SUPPLY™ (UAS)

For integrated/matched models, the Environmental Control Module is normally sized to match the capacity of the UPS module and heat transmitted into the Little Glass House™. The module is located at the bottom of the enclosure. Internal air is conditioned and circulated within the enclosure. Outside (ambient) air is used to remove heat from the enclosure through the air cooled condenser. The outside air is drawn through a louver and filter at the bottom front of the unit and is discharged at the rear (near the bottom).

The lighted ON/OFF switch is located inside the front door, on the left side of the electrical panel on 60 Hz models. For 50 Hz models, use circuit breaker "B" of electrical service assembly for ECM On/Off.

At rated maximum ambient conditions, the temperature inside the enclosure will be from 70° to 95°F (21 to 35°C), depending on the electronics load. The two speed fans are factory set to operate at the lower speed for quiet operation when the outside air entering the condenser is below 80°F (27°C). The compressor in the Environmental Control Module will turn off if the internal cabinet temperature goes below 65°F (18°C).

The hot gas bypass valve is factory set so the compressor will operate nearly continuously for maximum compressor life. This valve modulates automatically to match compressor capacity to the present load. Consult factory if adjustment is desired.

In UAS systems, during an enclosure high temperature condition (100°F - 38°C) a separate Back-up Cooling Fan operated on UPS battery power (if included) will use filtered ambient air to cool the enclosure. This would occur only during a power failure or an Environmental Control Module failure. To annunciate a high temp condition, an alarm beeper sounds and the alarm contact closes (press Alarm Silence switch to turn off beeper). Outside air is drawn through a louver and filter at the bottom front of the unit and is discharged at the rear (near the top).

### FORCED AIR COOLING (FAC)

Forced Air Cooling can be provided by a single fan (nominally rated at 190 CFM - 323 CMH), or by dual fans (nominally rated at 360 CFM - 611 CMH). The two-speed fans are activated by a temperature switch. Ambient air is drawn through the filter at the bottom front of the unit, and discharged at the top rear.

**The ON/OFF control switch is located inside the front door, on the left side. The same control box includes the temperature switch factory set at 80°F (27°C), which measures air entering the unit. If the entering air temperature goes above 80°F (27°C), the fan speed switches from low to high.**

### UNINTERRUPTIBLE POWER SUPPLY (UPS)

The Little Glass House may be supplied with one of several Liebert UPS units, or with no UPS. For integrated/matched models, the UPS and ECM are normally sized with matched capacities. A larger UPS can be supplied for more battery time, but the connected electronics load should not exceed the ECM rating.

For LGH models supplied with a UPS, refer to the separate UPS manual for operation and specifications.

### SITENET® INTEGRATOR®

Refer to the Integrator Electrical Connection Diagram on page 21 for specifics regarding installation.

The SiteNet Integrator is a separate rackmount unit that communicates status of the UPS and LGH. The option consists of a SiteNet Integrator module that is typically mounted in the top of the LGH cabinet.

The SiteNet Integrator is powered by one or two externally mounted power supplies. One is standard, the second is optional. These power supplies provide the 9VDC required to power the Integrator module. One supply will be plugged into the UPS or the UPS outlet strip located in the rear hinge side of the cabinet. The output cable is plugged into the SiteNet Integrator Power Supply Main input receptacle/socket. The (optional) second supply will be plugged into the electrical service power inlet in the lower rear of the LGH cabinet. The supply's output cable is plugged into the SiteNet Integrator Power Supply Aux input receptacle/socket.



An optional UPS status communication cable is available that allows transmission of information between the UPS and the SiteNet Integrator. This cable will plug into the 25 pin D Type connector on the rear of the UPS marked DB-25P. The opposite end of the cable is plugged into the 9 pin D Type receptacle on the rear of the SiteNet Integrator marked UPS RS-232 DB-9P.

## SENSOR OPTIONS

**Door Ajar** -- This option consists of two normally open switches that are mounted to the cabinet front and rear frame supports. The switches will indicate by the position of the doors (opened or closed) as determined by the status of the dry-contact inputs to which they are connected on the rear of the SiteNet Integrator.

**Temperature and Humidity Sensors (Internal and External)** -- The sensors allow monitoring of temperature and humidity status by the SiteNet Integrator. The internal option is for installation inside the LGH cabinet and is supplied with a 12 foot (3.6 m) cord for connection between the temperature/humidity sensor and the SiteNet Integrator. Refer to the connection diagram for wiring specifics. The external option is supplied with a 30 foot (0.1 m) cord for monitoring of temperature humidity status outside the LGH cabinet. The sensor and connections for both options are identical.

**Water Detect** -- The water detect option includes a Liquitect (LT-400S) dry contact sensor mounted in the bottom of the LGH cabinet. The sensor is powered by a 24 VDC power supply mounted in the frame channel of the LGH cabinet. (Multiple options may share this same general power supply. The supply is rated for 1.6 Amps at 24 VDC). The water detector is connected to the dry-contact input on the rear of the SiteNet Integrator by a 30 foot two-conductor cable. The detector may be relocated outside the LGH cabinet by user discretion for external water detection.

**Remote ECM On-Off Control** -- This option allows on-off control of the ECM by the SiteNet Integrator. It consists of a 24 VDC Power Supply with Control Relay that is mounted in the frame channel of the LGH cabinet. The 24 VDC power supply may also be used to power other options. A black SJ two-conductor (black & red) cable is connected between the power supply relay normally open contacts and the ECM power terminal strip (terminals 37 & 38) in the

rear of the ECM. A two-conductor control cable is connected between the power supply terminal strips marked "Close to Energize Relay R1" and the Relay Output K1 terminal strip on the rear of the SiteNet Integrator. When the relay output contacts on the SiteNet Integrator close, the relay in the power supply is energized closing the normally open contacts and shorting between terminals 37 & 38 in the rear of the ECM. This will allow power to be applied to the ECM and cause the ECM to begin operation if the ECM On/Off switch is in the On position. Consequently, de-energizing the relay will allow the ECM to be turned off remotely by the SiteNet Integrator.

**Smoke Detector Option** -- A four-wire smoke detector with normally open contacts, heat sensor and sounder alarm is mounted in the top of the LGH cabinet. The smoke detector is powered by a 24VDC power supply (\*) mounted in the frame channel of the LGH cabinet. The power supply is normally powered from the UPS (if available), but may be powered from utility/mains by customer discretion. Power to the smoke detector is supplied by a two-conductor cable between the power supply and the smoke detector. A second two-conductor cable connects between the smoke detector and the Integrator dry-contact inputs. If smoke, flame, or high temperature change are detected, the normally open contacts of the smoke detector will close to provide alarm status to the Integrator. The smoke detector sounder alarm will also activate. This alarm can be silenced only by removing power from the smoke detector. This is accomplished by unplugging the smoke detector power supply.

\*The smoke detector power supply is a general purpose supply that may be used to power any option requiring 24 VDC. Multiple options may share the same supply. The supply is rated for 1.6 Amps at 24 VDC.

All the above options are available factory installed with the order. The options are also available for field installation. Field installed options are shipped as kits containing the sensors with appropriate mounting hardware, cable, and cable restraint fixtures. Field installation requires hand tools for termination of control cables and routing of the cables.

All other standard alarm signals provided by the LGH (High Temp, Clogged Filter, Cooling Status) are also pre-wired for monitoring by the SiteNet Integrator.

## MAINTENANCE

**CAUTION:** To avoid tipping the unit when it is being moved, push slowly on the lower part of the enclosure. After customer equipment is installed, the Little Glass House™ may have a high center of gravity.

### FILTER CLEANING

**NOTE:** Inspect the air filter periodically to determine the necessary cleaning interval based on conditions at your installation.

If the air filter becomes dirty and clogged, the alarm contact closes (no beeper alarm is sounded). The filter is behind the louver at the bottom of the front door. Remove two screws, pull up the filter, clean with mild soapy water, rinse, dry, and replace.

### ECM REPLACEMENT

TO REMOVE THE ECM FOR FACTORY REPAIRS:

-Turn off power. Unplug Environmental Control Module from receptacle inside rear of the Little Glass House.

-Remove the screws retaining the access plate at top left rear of ECM. Remove the plate and tuck the ECM power cord and plug inside the opening to allow the ECM to pass beneath the UPS or mounted shelves. For models including a UPS, do not replace this access panel until after ECM has been removed.

-Models containing a 60 Hz ECM80 require the removal of the plug from the ECM power cord. Once removed the power cord strain relief may be loosened to allow the power cord to slide through when the ECM is withdrawn from the cabinet. Observe wiring polarity when reinstalling the plug on the replacement unit.

-If connected, remove customer wiring to ECM compressor power contact and/or remote shutdown/startup contact.

-Remove four screws retaining the front electrical panel. Pivot panel to the left. Cables are long enough to move the box out of the way so the Environmental Control Module can be pulled forward after removing four rack mount screws.

-Replace cable access cover on ECM. Package unit for return to Liebert.

-Install the replacement ECM.

### UPS REPLACEMENT

To remove the UPS for factory repairs:

-Turn off power. Unplug UPS from receptacle inside rear of the Little Glass House.

-Unplug the power strip, ECM or FAC controls, and any other equipment plugged into the UPS.

-Disconnect any optional communication cables.

-Remove screws retaining the UPS.

-Remove the UPS from the front of the LGH.

-Install the replacement UPS.

### PLUG WIRING

	50 Hz	60 Hz
Line (L)	Brown	Black
Neutral (N)	Blue	White
Ground/Earth (G)	Gold	Gold

## TABLES

### FORCED AIR COOLING (FAC) PERFORMANCE DATA (WITH 30PPI FILTER)

MODEL #	# FANS	AIRFLOW (w/Filter)		SOUND LEVEL		INPUT POWER (1PH) FLA / WSA / OPD	
		HIGH SPEED	LOW SPEED	HIGH SPEED	LOW SPEED	120V/60Hz	220V/50Hz
FAC-190	1	190 CMF 112 CMH	90 CMF 53 CMH	61 dBa	47 dBa	0.5/15/15	0.5/15/15
FAC-360	2	360 CMF 212 CMH	175 CMF 103 CMH	59 dBa	49 dBa	1.0/15/15	1.0/15/15

### ENVIRONMENTAL COOLING MODULE (ECM) PERFORMANCE DATA

MODEL NUMBER	RATED CAPACITY	SUPPORT LOAD	RATED/MAX AMBIENT		HEIGHT		DIMENSIONS WIDTH		DEPTH	TOTAL HEAT REJ.	INPUT POWER (1PH)		WEIGHT
	BTUH/Watt	BTUH/Watt	60Hz	50Hz	U	In/mm	In/mm	Rack	In/mm	BTUH/Watt	120V/60Hz	220V/50Hz	(lbs/Kg)
ECM-42	4200/1230	2730/800	105F 41C	100F 38C	6	10.5/ 265	17.5/ 445	19	27/ 685	7625/ 2235	8/15/15	7/15/15	95/43
ECM-62	6200/1815	4095/1200	105F 41C	100F 38C	7	12.3/ 310	22/ 560	24	27/ 685	11310/ 3315	12/20/20	9/15/15	115/52
ECM-80	8000/2345	5800/1700	105F 41C	100F 38C	9	15.8/ 400	22/ 560	24	29/ 735	14605/ 4280	16/20/20	16/20/20	167/76

ECM Notes:                      Standard Offerings - All Systems

1. 60Hz: R-22 refrigerant / 50Hz: R-134A refrigerant
2. Two-Speed Operation - Switch low-high speed on ambient temperature external to LGH enclosure
3. Automatic Load Matching: Hot gas by-pass factor set for minimum capacity; by-pass will adjust to match supported loads
4. Condensate Re-evaporation & Removal: Drain connection only required if enclosure seal is violated.

## Electrical Service / Connection

The 60 Hz LGH is provided with a single NEMA plug and cord input power connection (except for ECM-80 systems).

### 60 Hz Systems with UPS - Service Connection

If a UPS is supplied, the system power rating and plug connection are fixed.

<b>FIXED SERVICE CONNECTION (AMPS)</b>			
<b>Cooling System</b>	<b>UPS-GXT (VA)</b>		
	1000	1500	2000
FAC-190	15	15	20
FAC-360	15	15	20
UAS/ECM-42	20	--	--
UAS/ECM-62	30	30	--
UAS/ECM-80*	ECM-80 - 20 Amp / UPS-Load - 20 Amp		

**\*LGH ECM-80 systems provided with separate ECM & UPS power connections.**

### 60 Hz Systems with NO UPS - Service Connection Selection

If a UPS is not supplied, the system power rating and plug connection are customer selected based on the Cooling System and customer Amp load.

<b>MAX. AVAILABLE CUSTOMER EQUIPMENT AMPS (based on customer selected Service Connection)</b>			
<b>Cooling System</b>	<b>SERVICE CONNECTION</b>		
	15 Amp	20 Amp	30 Amp
FAC-190	11.5	15.5	23.5
FAC-360	11	15	23
ECM-42 only	--	8	16
UAS-42	--	7	15
ECM-62 only	--	--	12
UAS-62	--	--	10
UAS/ECM-80*	--	--	--

\*Power strip is rated for 15 Amp service

### 50 Hz Systems with NO UPS or WITH UPS - Full Load Amp Draw

The 50 Hz LGH is provided with a cord for input power connection; an appropriate plug is to be field supplied. Selection charts below are to be used to determine plug requirements per local codes.

<b>FULL LOAD AMP DRAW (230V - 50Hz)</b>				
<b>Cooling System</b>	<b>UPS</b>	<b>UPS-G (VA)</b>		
		1000	1500	2000
FAC-190	.5	4.5	6.5	8.7
FAC-360	1	5	7	9.2
UAS/ECM-42E only	7	11	--	--
UAS/ECM-42E	7.5	11	--	--
UAS/ECM-62E only	9	13	15	--
UAS/ECM-62E	9	13	15	--
UAS/ECM-80E	9	13	15	17

Note: Power strip is rated for 10 Amp service

# DRAWINGS

## LIEBERT LITTLE GLASS HOUSE

### DISTRIBUTED PROCESSING (DP) ENCLOSURE - DIMENSIONAL DATA

FRONT VIEW  
SHOWN WITH FRONT DOOR OPEN

SIDE VIEW

TOP VIEW

**NOTES:**

- ① SEE ECM DATA SHEET.
- ② SEE UPS DATA SHEET.
- ③ AVAILABLE U = TOTAL U - ECM U - UPS U
- ④ EXTERNAL KEYBOARD TRAY (OPTIONAL). SECURITY LOCKS ADDS 0.75" TO CLOSED DEPTH. OPTION CANNOT BE APPLIED TO ADJACENT LGH ENCLOSURES.
- ⊕ REDUCE WEIGHT BY 22 lbs/10kg FOR ENCLOSURE WITH FAC (NO INSULATION). NET WEIGHT FOR ENCLOSURE ONLY, ADD ECM AND UPS WEIGHT WHERE APPROPRIATE.
- ⊕ U = RACK UNIT, IU = 1.75" = 45mm

### ENCLOSURE DIMENSIONS

MODEL	Overall Dims. (in/mm)			Rack Width (in/mm)		FREE SPACE				NET Weight* (lbs/Kg)	
	H	W	D	EIA	A	Width/depth		Height			
						B	⊕	ECM U	UPS U		Avail. U
HD7234	73/1850	25/635	34/865	19	17.8/450	22.5/570	40 U	ECM U	UPS U	Avail. U	320/145
HD7238	73/1850	25/635	38/965	19	17.8/450	26.5/675	40 U				335/152
HD7834	79/2005	25/635	34/865	19	17.8/450	22.5/570	43 U				340/155
HD7838	79/2005	25/635	38/965	19	17.8/450	26.5/675	43 U				365/166
RD7234	73/1850	30/760	34/865	24	22.8/580	22.5/570	40 U				345/157
RD7238	73/1850	30/760	38/965	24	22.8/580	26.5/675	40 U				370/168
RD7834	79/2005	30/760	34/865	24	22.8/580	22.5/570	43 U				365/166
RD7838	79/2005	30/760	38/965	24	22.8/580	26.5/675	43 U				390/177

DRG. NO. DFP0022A	DATE 6-18-97	ORDER NO.
TITLE DISTRIBUTED PROCESSING SYSTEM LITTLE GLASS HOUSE		

1000 BARNBURY DRIVE, P.O. BOX 3070, COVINGTON, LA 70439

# LIEBERT LITTLE GLASS HOUSE

## DISTRIBUTED PROCESSING (DP) CABLING & ELECTRICAL FEATURES

CABLE ENTRANCE RACEWAY  
INTEGRAL CABINET SEALING.  
PANDUIT BOX 3" / 75mm WIDE X 1" / 25mm DEEP  
SEE DETAIL BELOW

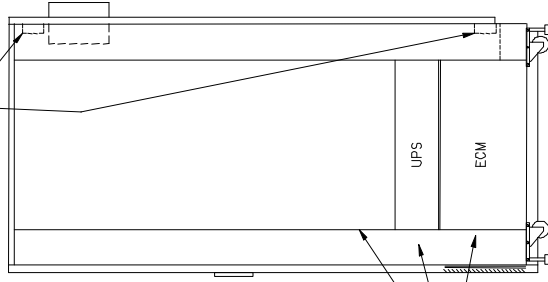

SIDE VIEW

ALARM, SILENCE &/OR FAC  
ON/OFF (ECM, FAC, UPS) AND ALARM SILENCE  
SWITCHES LOCATED INSIDE FRONT DOOR  
EXCEPT 50Hz ECM & FAC ON/OFF LOCATED ON  
POWER DISTRIBUTION BOX IN REAR OF UNIT

OUTPUT POWER RECEPTACLES (OPTIONAL)  
(10) UPS PROTECTED NEMA 5-15R RECEPTACLES (60Hz)  
OR IEC320 RECEPTACLES (50Hz)

INTERNAL CABLE MANAGEMENT RACEWAY (OPTIONAL)  
PANDUIT BOX (2" / 50mm WIDE X 2" / 50mm DEEP)  
SEE DETAIL BELOW

POWER DISTRIBUTION BOX

ALARM CONNECTIONS

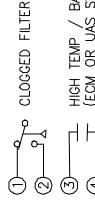

REPLACE JUMPER BETWEEN TERMINALS 37 AND 38  
WITH A NORMALLY OPEN NON-POWERED SWITCH, HAVING  
A MINIMUM 5A, 120VAC OR 3A, 250VAC RATING.

CABLE ENTRANCE RACEWAY  
INPUT POWER CONNECTION

120V/1PH/60Hz

ALL SYSTEMS INCLUDE  
9 FT/2.7m POWER CORD WITH  
APPROPRIATE PLUG  
CONNECTOR  
- EXCEPT ECM-80 SYSTEMS  
INCLUDE SEPARATE LOAD/UPS  
& ECM 9 FT/2.7m CORDS.

SYSTEM SERVICE	REQUIRED CUSTOMER CONNECTION
15 AMP	NEMA 5-15R
20 AMP	NEMA 5-20R
30 AMP	NEMA L5-30R

230V/1PH/50Hz

ALL SYSTEMS INCLUDE 9 FT/2.7m POWER CORD.  
PLUG CONNECTOR SUPPLIED LOCALLY.

SYSTEM SERVICE	REQUIRED CUSTOMER CONNECTION
20 AMP	SUPPLIED LOCALLY

CABLE ENTRANCE RACEWAY

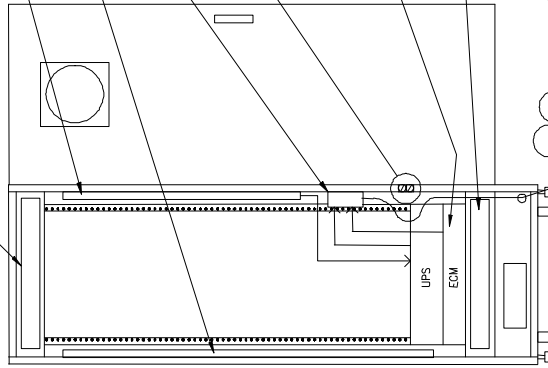

REAR VIEW

SHOWN WITH REAR DOOR OPEN

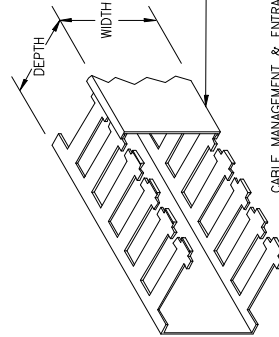

CABLE MANAGEMENT & ENTRANCE DETAIL

TITLE DISTRIBUTED PROCESSING SYSTEM  
LITTLE GLASS HOUSE

DRG. NO. DATE ORDER NO.  
DPS0031A 6-18-97



# LIEBERT LITTLE GLASS HOUSE

## DISTRIBUTED PROCESSING (DP) ELECTRICAL SERVICES / POWER DISTRIBUTION BOX

60 HERTZ / 120 VAC

15 AMP SERVICE:

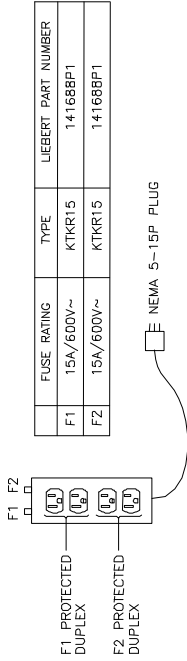

20 AMP SERVICE:

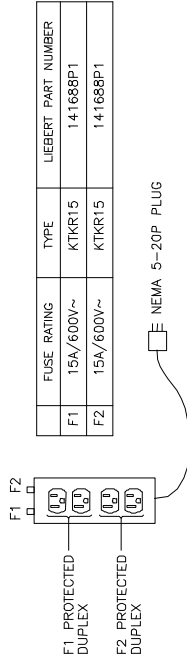

30 AMP SERVICE:

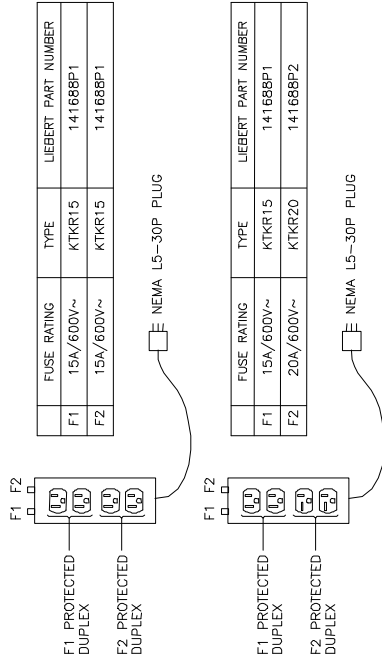

ALL FUSES ARE CLASS CC

**WARNING**  
FOR CONTINUED PROTECTION REPLACE WITH ONLY WITH SAME TYPE & RATING OF FUSE

50 HERTZ / 230 VAC

20 AMP SERVICE:

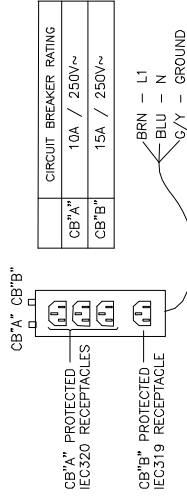
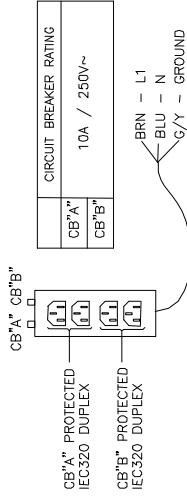

**WARNING**

OBSERVE POLARITY FOR FIELD SUPPLIED PLUG  
3 PRONG PLUG REQUIRED

TITLE

DISTRIBUTED PROCESSING SYSTEM  
LITTLE GLASS HOUSE

DRG. NO. DATE ORDER NO.  
DPS0031B 6-18-97



## LIEBERT LITTLE GLASS HOUSE

### DISTRIBUTED PROCESSING (DP) SYSTEM WITH FORCED AIR COOLING (FAC) – FEATURES

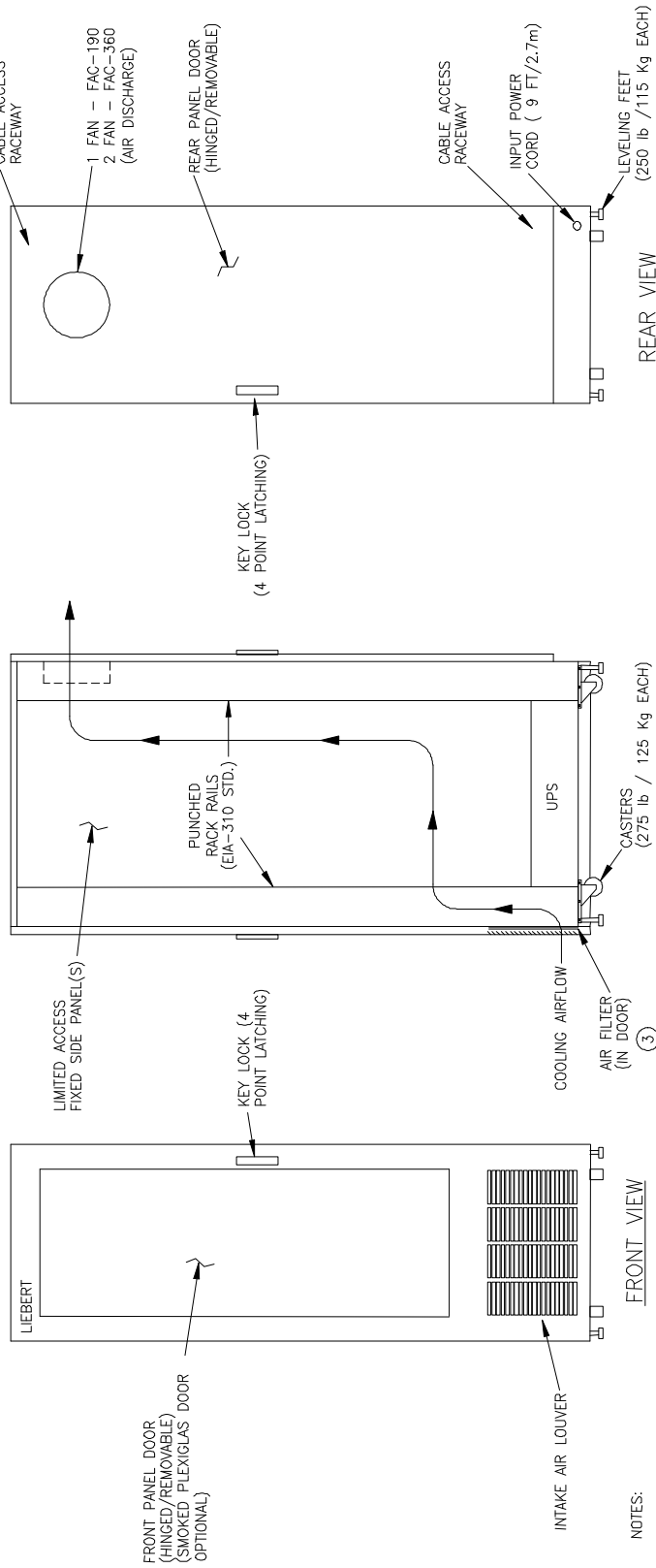

NOTES:

- ① TEMPERATURE DIFFERENCE = LEAVING – ENTERING AIR TEMPERATURE WITH FULLY LOADED UPS.
- ② LOW SPEED FACTORY SET BELOW 80°F/27°C ENTERING AIR TEMPERATURE.
- ③ FILTER: WASHABLE / 30PPI.

### LGH INTEGRATED / MATCHED SYSTEMS

UPS	FAC	Rated Capacity		Quantity Fans	FLA/WVA/OPD	TEMP. DIFF. ①		Sound Level Low Spd.
		UPS	FAC			RD & HD ENCLOSURES Rated/Low Spd ②	Rated/Low Spd ②	
GXT1000	FAC-190	1000VA	190CFM/112CMH	1	120V/60Hz	230V/50Hz	12°F(7°C)/17°F(9°C)	47dBA
GXT1500	FAC-360	1500VA	360CFM/212CMH	2	8/15/15	4.6/20/20	12°F(7°C)/16°F(9°C)	49dBA

TITLE DISTRIBUTED PROCESSING SYSTEM LITTLE GLASS HOUSE		
DRG. NO. DP-S0012A	DATE 6-18-97	ORDER NO.





**LIEBERT LITTLE GLASS HOUSE**  
**DISTRIBUTED PROCESSING (DP) SYSTEM WITH ENVIRONMENTAL CONTROL MODULE - FEATURES**

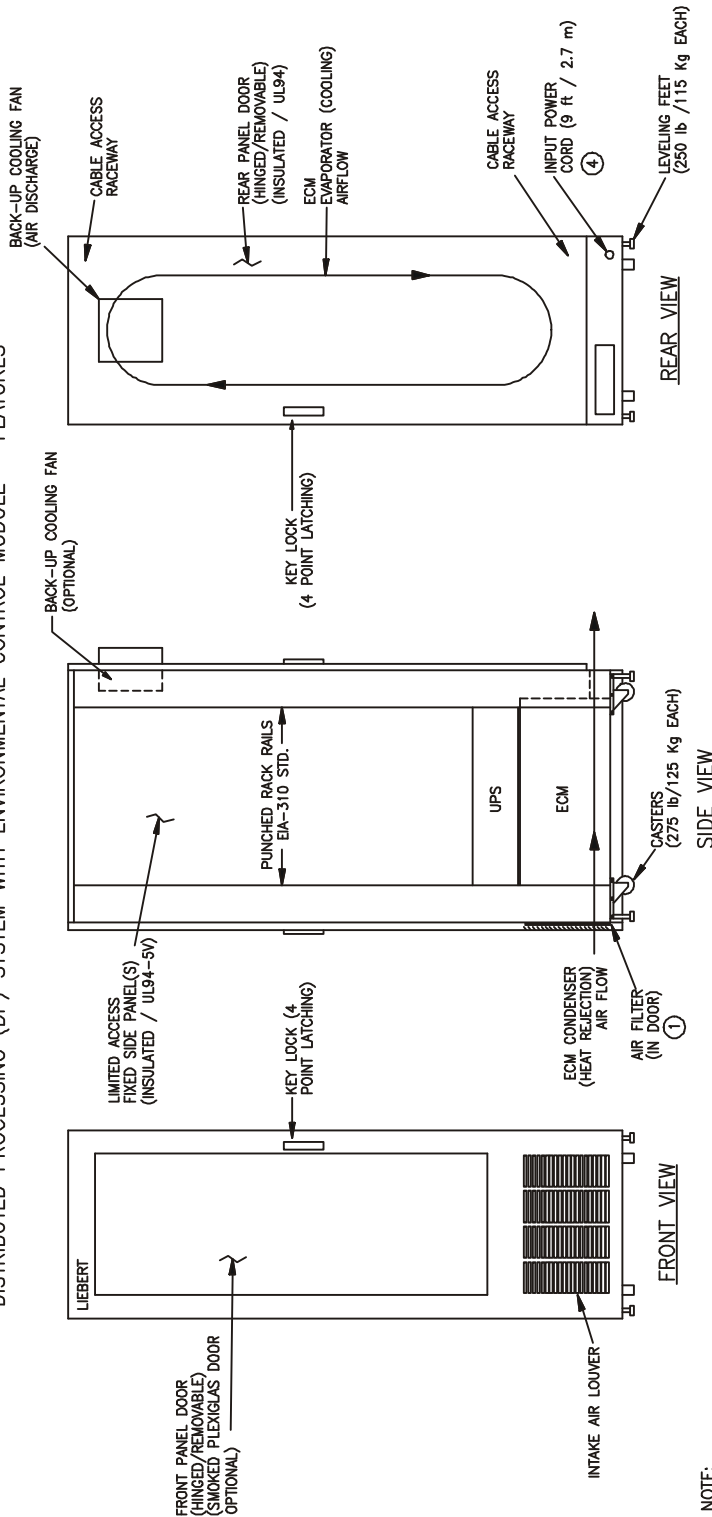

- NOTE:**
- ① FILTER: WASHABLE / 12 LAYER METAL
  - ② TOTAL CAPACITY: ELECTRONICS LOAD + LOSSES (ENCLOSURE & UPS)
  - ③ NET CAPACITY: CUSTOMER ELECTRONICS ONLY.
  - ④ 60Hz ECM-80 & GXT2100 CONNECTED SEPARATELY - FLA/WSA/DPD RATINGS: ECM-80 16/20/20; UG&X2100 16/20/20; 9 ft / 2.7 m POWER CORDS.

**LGH INTEGRATED / MATCHED SYSTEMS**

UPS	Rated Capacity		Rated - Max Amb.		MIN Enclosure		FLA/WSA/DPD		Sound Level	
	ECM	ECM-80	60Hz	50Hz	Rack/Width/Depth	120V/60Hz	230V/50Hz	16/20/20	10.9/15/15	<80F/27c Amb.
GXT1000	ECM-42	1000VA	4200BTUH	700 WATT	19"/25"(635mm)/34"(865mm)	120V/60Hz	230V/50Hz	16/20/20	10.9/15/15	55dBA
GXT1500	ECM-62	1500VA	6200BTUH	1050 WATT	24"/30"(765mm)/34"(865mm)	105F/41C	100F/38C	24/30/30	14.2/20/20	55dBA
GXT2000	ECM-80	2100VA	8000BTUH	1500 WATT	24"/30"(765mm)/38"(965mm)	105F/41C	100F/38C	④ 16/20/20	16/20/20	57dBA

TITLE: DISTRIBUTED PROCESSING SYSTEM  
 LITTLE GLASS HOUSE

DRG. NO. DP50002A      DATE 6-18-97      ORDER NO.

389 SEASIDE BLVD., P.O. BOX 27868, COLUMBIA, MD 21048

# LIEBERT LITTLE GLASS HOUSE

## CLUSTERED SYSTEM LAYOUT & SETUP - FORCED AIR COOLING (FAC) SYSTEM

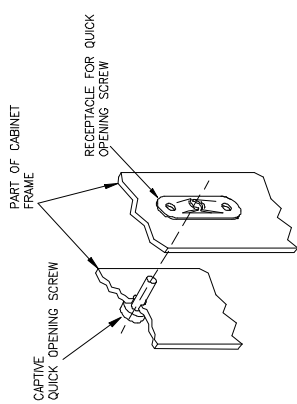
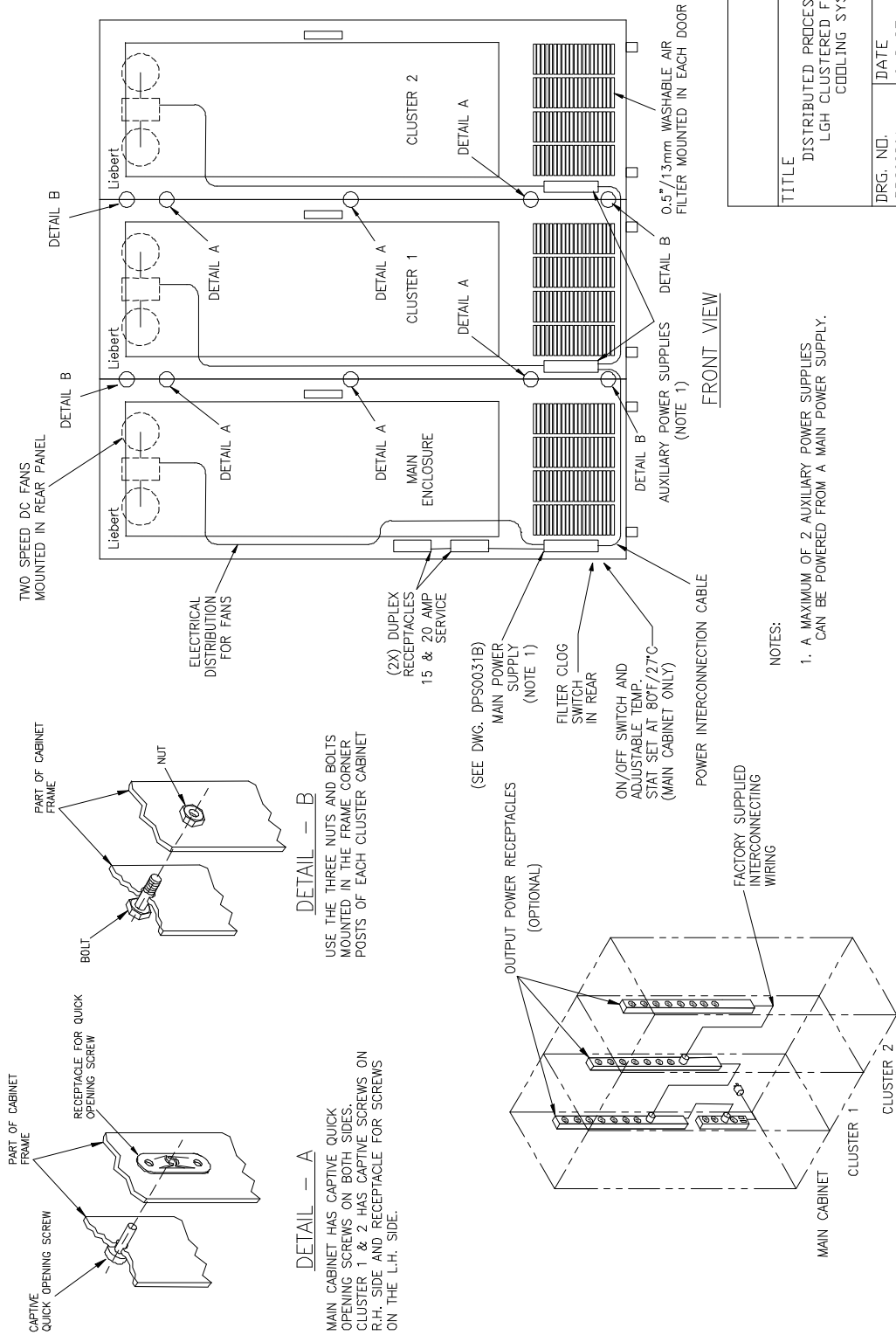

**DETAIL - A**

MAIN CABINET HAS CAPTIVE QUICK OPENING SCREWS ON BOTH SIDES. CLUSTER 1 & 2 HAS CAPTIVE SCREWS ON R.H. SIDE AND RECEPTACLE FOR SCREWS ON THE L.H. SIDE.

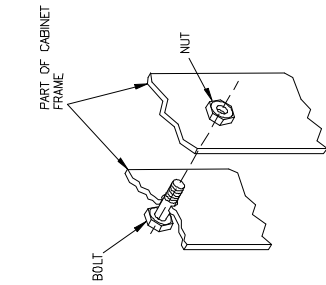

**DETAIL - B**

USE THE THREE NUTS AND BOLTS MOUNTED IN THE FRAME CORNER POSTS OF EACH CLUSTER CABINET

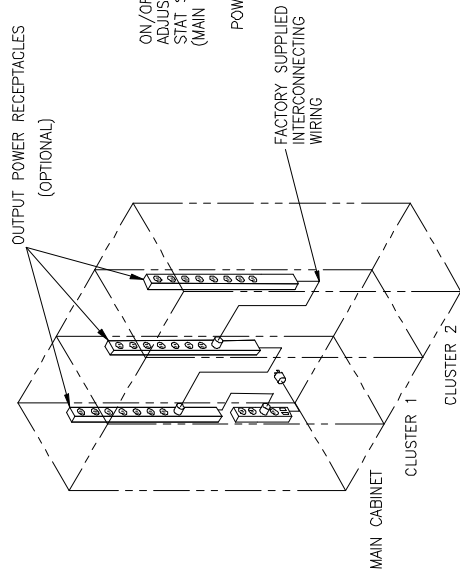

**ELECTRICAL INTERCONNECTION DETAIL**

- NOTES:
1. A MAXIMUM OF 2 AUXILIARY POWER SUPPLIES CAN BE POWERED FROM A MAIN POWER SUPPLY.

TITLE	
DISTRIBUTED PROCESSING SYSTEM LGH CLUSTERED FORCED AIR COOLING SYSTEM	
DRG. NO.	DATE
DPS0090A	6-3-97
ORDER NO.	



LIEBERT LITTLE GLASS HOUSE  
 CLUSTERED SYSTEM LAYOUT & SETUP – ENVIRONMENTAL CONTROL MODULE (ECM) SYSTEM

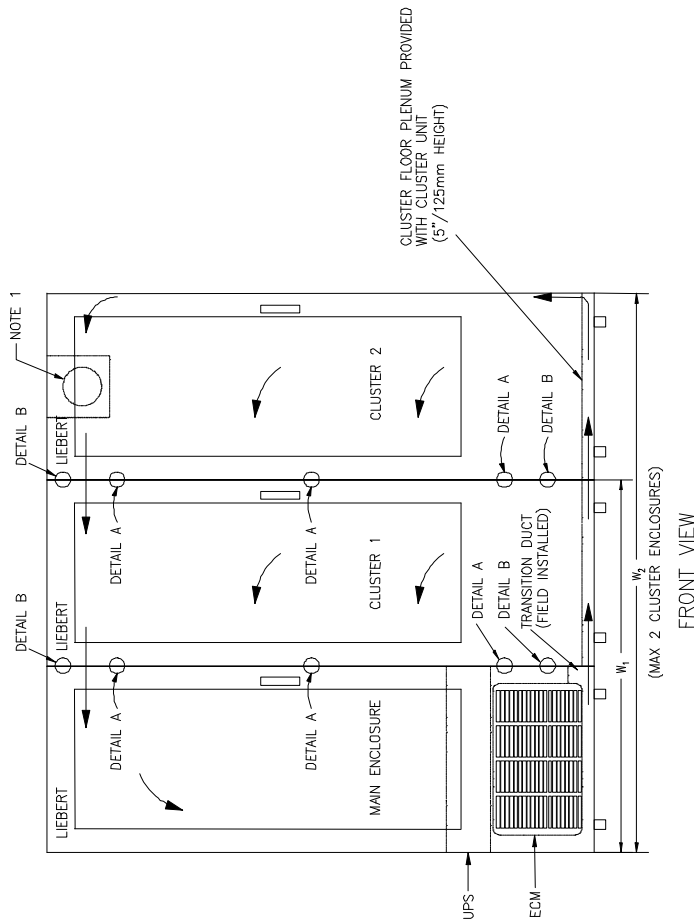

NOTE:  
 1. UAS FAN LOCATION FOR UAS 42, 62, AND 80  
 (REFER TO INSTALLATION INSTRUCTIONS).

TITLE  
 DISTRIBUTED PROCESSING SYSTEM  
 LGH CLUSTERED A/C (ECM) SYSTEM

DRG. NO.  
 DPS0080A

DATE  
 6-3-97

ORDER NO.



SYSTEM OVERALL WIDTH	
STANDARD END WIDTH	W <sub>2</sub>
24" RACK	58" / 1475mm
19" RACK	48" / 1220mm

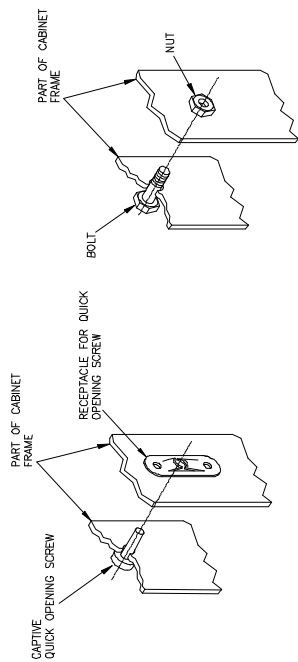

DETAIL – A

MAIN CABINET HAS CAPTIVE QUICK OPENING SCREWS ON BOTH SIDES. CLUSTER 1 & 2 HAS CAPTIVE SCREWS ON R.H. SIDE AND RECEPTACLE FOR SCREWS ON THE L.H. SIDE.

DETAIL – B

USE THE FOUR NUTS AND BOLTS MOUNTED IN THE FRAME CORNER POSTS OF EACH CLUSTER CABINET

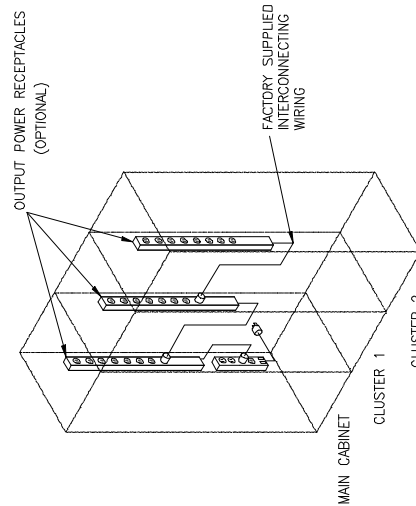

ELECTRICAL INTERCONNECTION DETAIL

LIEBERT LITTLE GLASS HOUSE  
DISTRIBUTED PROCESSING (DP) – HEAT REJECTION DUCT (HRD)

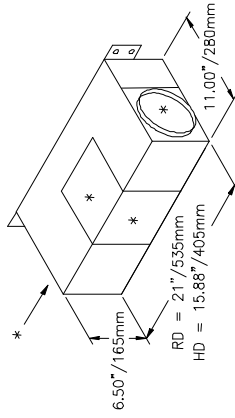

HRD COMPONENTS

- DISCHARGE BOX  
AIR EXIT FIELD LOCATED  
IN 1 OF 4 POSITIONS (\*)
- BOOSTER BLOWER
  - WALL MOUNTING BRACKET PROVIDED
  - 60 Hz SYSTEMS PROVIDED WITH 10 FT/3m CORD AND NEMA 5–15P PLUG CONNECTION.
  - 50 Hz SYSTEMS PROVIDED WITH 10 FT/3m CORD AND REQUIRE CUSTOMER SUPPLIED PLUG.

MODEL	CFM	WATTS	WEIGHT
HRD19 & 24	418	95	11.0 LBS/5Kg
HRD–24H	636	150	11.0 LBS/5Kg

D	d	ø	a	B
13.2 IN. 335mm	8.0 IN. 205mm	1.0 IN. 25mm	9.1 IN. 23mm	

SHOWN WITHOUT MOUNTING BRACKET  
WHICH ADDS 1”/25mm TO Ø D DIM.

- DUCT PIECES
  - 6”/150mm CLEARANCE DUCT: FLEXIBLE/LENGTH 12”/305mm
  - 6”/150mm TO 8”/205mm TRANSITION: SHEETMETAL/LENGTH 6”/150mm
  - DISCHARGE DUCT: FLEXIBLE/LENGTH 12 FT/3.6m X 8”/205mm DIA.
- MISC CONNECTIONS

ALL REQUIRED SCREWS AND DUCT CLAMPS PROVIDED

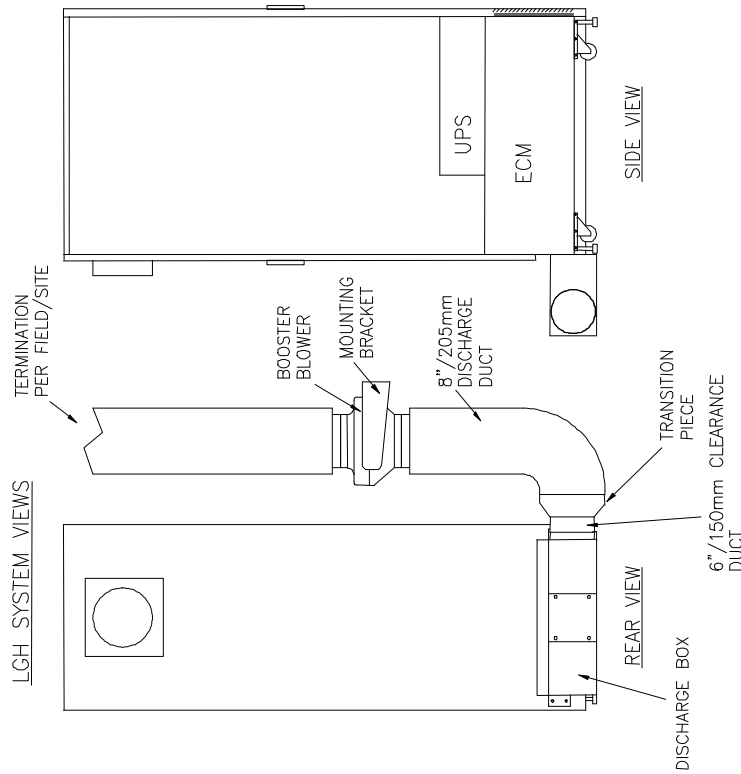

INSTALLATION NOTES (FIELD ASSEMBLY):

1. Apply gasket (provided) to duct box surfaces where required.
2. Determine preferred location for 6”/150mm discharge collar (left, right, rear, or top). Exchange with solid plate if required.
3. Mark and drill holes for four (4) sheet metal mounting screws (provided). Attach duct box with 4 screws.
4. Attach 12”/305mm piece of flexible 6”/150mm clearance duct to collars with hose clamps. Insulation should be outside of hose clamps. Avoid skin exposure to insulation fibers. Use duct tape to contain fibers after securing clamps.
5. Attach mounting bracket to blower. Instructions provided with bracket.
6. Apply power to blower to confirm airflow direction.
7. Mount blower using bracket.
8. Attach 8”/205mm flexible duct to transition piece and blower using same process as step 4.
9. Attach customer supplied duct (if required), and apply power to blower.

TITLE  
DISTRIBUTED PROCESSING SYSTEM  
LITTLE GLASS HOUSE  
HEAT REJECTION DUCT

DRG. NO.  
DPS0022C

DATE  
6-18-97

ORDER NO.



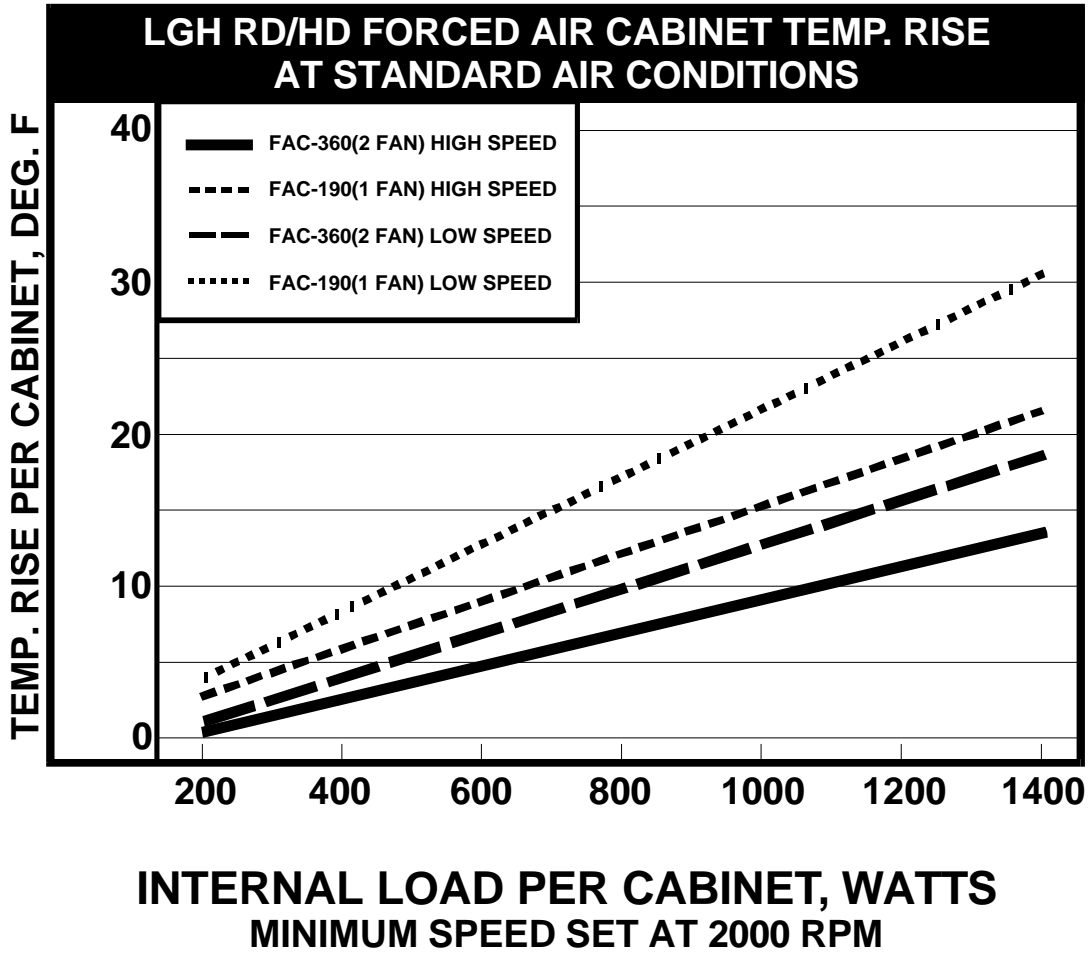

# INTEGRATOR POWER, UPS, & TERMINAL CONNECTIONS

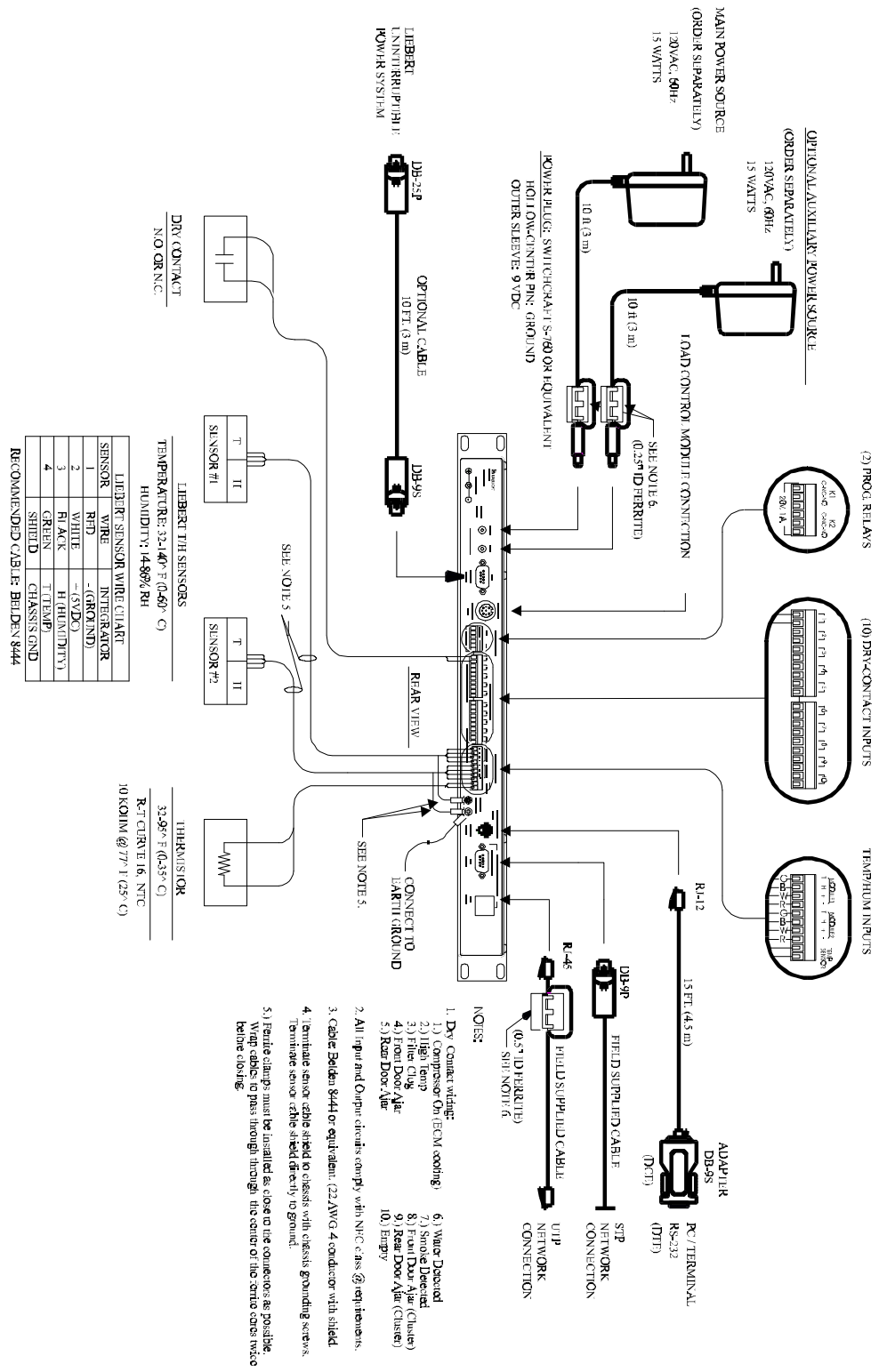

- NOISE:**
1. Dry Contact wiring:
  - 1.1) Compressor On (ECM cooling)
  - 2.1) High Temp
  - 3.1) Filter Plug
  - 4.1) Front Door Ajar
  - 5.1) Rear Door Ajar
  - 6.1) Water Detected
  - 7.1) Smoke Detected
  - 8.1) Front Door Ajar (Cluster)
  - 9.1) Rear Door Ajar (Cluster)
  - 10.1) Empty
2. All input and output circuitry with NTC class ② components. Terminate sensor cable shield to chassis grounding screws.
  3. Cable Belden 8444 or equivalent. (22 AWG 4 conductor with shield.)
  4. Terminate sensor cable shield to chassis with chassis grounding screws.
  - 5.1) Ferrite clamps must be installed as close to the connectors as possible. Wrap cables to pass through the center of the ferrite cores twice before clamping.

**LIBERTY TH SENSORS**

TEMPERATURE: 32.4°F (0.60° C)  
HUMIDITY: 14.89% RH

LIBERTY SENSOR WIRE COLOR	WIRE	INTEGRATOR
1	WHITE	-(GND)
2	WHITE	-(S/D)
3	BLACK	H (HUMIDITY)
4	GREEN	T (TEMP)
	SHIELD	CHASSIS GND

RECOMMENDED CABLE: Belden 8444

**TEMPERATURE**

32.96° F (0.35° C)  
R-17 CURVE 16 NTC  
10 KOHM @ 77° F (25° C)

## TROUBLESHOOTING

PROBLEM	CAUSE	SOLUTION
ECM Not Cooling	No Power	60 HZ: Verify F2 fuse not blown by checking on/off switch. If not lit, fuse is blown 50Hz: Verify breaker has not tripped.
	Filter Clogged	Clean, or replace filter
	Refrigerant loss	Verify leak. If refrigerant system needs repaired, replace ECM.
	Hot Gas Bypass Valve set incorrectly	Set valve correctly per LGH handbook
	Squirrel cage free spinning on evaporator or condenser blowers	Reattach and tighten squirrel cage to blower shaft
	Clogged Condenser coil	Clean coil
Fans blowing warm air	Compressor trips on thermal overload.	Open LGH doors and let compressor cool. Turn ECM on and verify compressor is energized (humming). Verify cold air is being discharged from evaporator discharge (right side of ECM).
	Faulty Compressor	Verify Compressor has failed. Replace ECM. If electrical component has failed causing compressor not to run, replace component.
Condensate draining continuously	Excessive opening of doors	Reduce the amount of opening. Suggest external keyboard tray. Turn ECM off when opening door.
	Enclosure not properly sealed	Verify leak and fix or replace gasket
	Evaporator drain kinked or clogged	Remove ECM and verify plastic tubing is attached to drain and not kinked or clogged.
Excessive vibration or noise	Defective motor in blower	Replace motor
	Defective squirrel cage in blower	Replace squirrel cage, or reattach and tighten to blower shaft.
Cabinet is excessively hot	ECM is overloaded	Verify the correct UPS and load on UPS. If no UPS; verify watt load of equipment does not exceed ECM rating.
	Heat not rejected from room	Verify LGH is located in room with air circulation and heat rejected from ECM is sufficiently removed from room.
	ECM not cooling	See above
	UAS operation	Verify UAS operation by jumpering terminals on high temperature stat

**Limited Warranty**  
**(for U.S. Sales and Installations)**

We are pleased that you have purchased the Little Glass House™ product to enhance the environment and the reliability of the available AC power for your sensitive electronic equipment.

Liebert Corporation warrants to the original user all parts that make up the Little Glass House for a period of thirteen (13) months from the factory ship date or proof of purchase date, including the LGH enclosure and the Environmental Control Module (ECM). The UPS module and batteries have a parts warranty of twenty-four (24) months from factory ship date or proof of purchase date. Complete removal of the UPS and Environmental Control Module is required for warranty field replacement. Extended warranty contracts are available for the Little Glass House.

Note that the limited warranty for the Little Glass House is for parts only.

NOTE: UPS Warranty is void if the battery is allowed to discharge below the minimum battery voltage cutoff point.

CAUTION: To prevent excessive battery discharge. DO NOT leave the UPS POWER switch ON for more than 2 days without AC/mains power being supplied to the UPS. The battery must be recharged every 4 to 6 months if not in use.

Circuit breaker resetting is not covered by this warranty and may indicate use beyond capability of the product. No warranty applies to products which have been abused, mishandled, modified, damaged by act of God or source external to the product, repaired by others, or which have product serial numbers removed or altered.

There are no warranties other than that described herein. In no event will Liebert be responsible beyond the purchase price of the product. SELLER DISCLAIMS ANY IMPLIED WARRANTY OF MERCHANTABILITY OF THE GOODS OR THE FITNESS OF THE GOODS FOR ANY INTENDED PURPOSES.

LIEBERT ASSUMES NO RESPONSIBILITY FOR INCIDENTAL OR CONSEQUENTIAL DAMAGES, INCLUDING WITHOUT LIMITATION, LOSS OF USE, PROFIT, OR INCOME.

To make a warranty claim for replacement of a part/module, first call your Liebert supplier with the unit model number and serial number. He will obtain the required warranty return authorization from Liebert Corporation. Customer is to package and ship the defective module or part to Liebert as outlined on the Warranty Return Tag. The Warranty Return Tag needs to be completed with description of defect, installer's name and telephone number, and must accompany the defective module or part back to Liebert. The Warranty Return Tag is included with the packing of the new or reconditioned part from Liebert.





1050 Dearborn Drive Columbus, OH 43229 614-888-0246

## Little Glass House

### Integrated Secured Protection for Network Equipment

#### Technical Support

---

U.S.A.	1-800-222-5877
Outside the U.S.A.	614-841-6755
U.K.	+44 (0) 1793 553355
France	+33 (0) 1 43 60 01 77
Germany	+49 89 99 19 220
Italy	+39 2 98250 1
Netherlands	+31 (0) 475 503333
E-mail	upstech@liebert.com
Web site	http://www.liebert.com
Worldwide FAX tech support	+614-841-5471

#### The Company Behind The Products

With more than 500,000 installations around the globe, Liebert is the world leader in computer protection systems. Since its founding in 1965, Liebert has developed a complete range of support and protection systems for sensitive electronics:

- Environmental systems: close-control air conditioning from 1.5 to 60 tons.
- Power conditioning and UPS with power ranges from 250 VA to more than 1000 kVA.
- Integrated systems that provide both environmental and power protection in a single, flexible package.
- Monitoring and control — on-site or remote — from systems of any size or location.
- Service and support, through more than 100 service centers around the world, and a 24-hour Customer Response Center.

While every precaution has been taken to ensure accuracy and completeness of this literature, Liebert Corporation assumes no responsibility, and disclaims all liability for damages resulting from use of this information or for any errors or omissions.

©1997 Liebert Corporation All rights reserved throughout the world. Specifications subject to change without notice.

® Liebert and the Liebert logo are registered trademarks of Liebert Corporation. All names referred to are trademarks or registered trademarks of their respective owners.

SL-15050 (5/97) Rev. 4

## Free Manuals Download Website

<http://myh66.com>

<http://usermanuals.us>

<http://www.somanuals.com>

<http://www.4manuals.cc>

<http://www.manual-lib.com>

<http://www.404manual.com>

<http://www.luxmanual.com>

<http://aubethermostatmanual.com>

Golf course search by state

<http://golfingnear.com>

Email search by domain

<http://emailbydomain.com>

Auto manuals search

<http://auto.somanuals.com>

TV manuals search

<http://tv.somanuals.com>