



RV-8 Receiver
User Guide

IMPORTANT SAFETY INSTRUCTIONS

1. Read these instructions.
2. Keep these instructions.
3. Heed all warnings.
4. Follow all instructions.
5. Do not use this apparatus near water.
6. Clean only with a dry cloth.
7. Do not block any ventilation openings. Install in accordance with the manufacturer's instructions.
8. Do not install near any heat sources such as radiators, heat registers, stoves, or another apparatus (including amplifiers) that produces heat.
9. Do not defeat the safety purpose of the polarized or grounding-type plug. A polarized plug has two blades with one wider than the other. A grounding-type plug has two blades and a third grounding prong. The wide blade or the third prong are provided for your safety. If the provided plug does not fit into your outlet, consult an electrician for replacement of the obsolete outlet.
10. Protect the power cord from being walked on or pinched particularly at plugs, convenience receptacles, and the point where they exit from the apparatus.
11. Only use attachments/accessories specified by the manufacturer.

12. Use only with the cart, stand, tripod, bracket, or table specified by the manufacturer, or sold with the apparatus. When a cart is used, use caution when moving the cart/apparatus combination to avoid injury from tip-over.



13. Unplug this apparatus during lightning storms or when unused for long periods of time.
 14. Refer all servicing to qualified service personnel. Servicing is required when the apparatus has been damaged in any way, such as when a power-supply cord or plug is damaged, liquid has been spilled or objects have fallen into the apparatus, the apparatus has been exposed to rain or moisture, does not operate normally, or has been dropped.
- Refer to the manufacturer's operating instructions for power requirements. Be advised that different operating voltages may require the use of different line cord and/or attachment plug.
 - Do not install the unit in an unventilated rack, or directly above heat-producing equipment such as power amplifiers. Observe the maximum ambient operating temperature listed in the product specification.

- Never attach audio power amplifier outputs directly to any of the unit's connectors.

This equipment has been tested and found to comply with the limits for a Class B digital device, pursuant to Part 15 of FCC Rules. These limits are designed to provide reasonable protection against harmful interference in a residential installation. This equipment generates, uses, and radiates radio frequency energy and, if not installed and used in accordance with the instructions, may cause harmful interference to radio or television reception, which can be determined by turning the equipment off and on. The user is encouraged to try to correct the interference by one or more of the following measures:

- Re-orient or relocate the receiving antenna.
- Increase the separation between the equipment and the receiver.
- Connect the equipment into an outlet on a circuit different from that to which the receiver is connected.
- Consult the dealer or an experienced radio/television technician for help.

WARNING

To reduce the risk of fire or electric shock, do not expose this apparatus to rain or moisture. Do not place objects containing liquid, such as vases, on this apparatus.

This triangle, which appears on your component, alerts you to the presence of uninsulated, dangerous voltage inside the enclosure - voltage that may be sufficient to constitute a risk of shock.



CAUTION
RISK OF ELECTRIC SHOCK
DO NOT OPEN



This triangle, which appears on your component, alerts you to important operating and maintenance instructions in this accompanying literature.



H A Harman International Company

Lexicon Inc.
3 Oak Park
Bedford, MA 01730-1413 USA
Tel 781-280-0300
Fax 781-280-0490
www.harmanpecialtygroup.com

Customer Service
Telephone: 781-280-0300
Sales Fax: 781-280-0495
Service Fax: 781-280-0499

Part No. 070-15838 | Rev 1 | 01/06

Manufactured under license from Dolby Laboratories. "Dolby," "Pro Logic," "Surround EX," and the double-D symbol are trademarks of Dolby Laboratories.

Manufactured under license from Digital Theater Systems, Inc. U.S. Pat. No's 5,451,942; 5,956,674; 5,974,380; 5,978,762; 6,226,616; 6,487,535 and other U.S. and world-wide patents issued and pending. DTS, DTS-ES, Neo:6, and DTS 96/24 are trademarks of Digital Theater Systems, Inc. Copyright 1996, 2003 Digital Theater Systems, Inc. All rights reserved.

Manufactured under license from THX Ltd. U.S. patent numbers 5,043,970; 5,189,703 and/or 5,222,059. European patent number 0323830. Other U.S. and foreign patents pending. Ultra2 and THX are trademarks or registered trademarks of THX Ltd. Surround EX is a trademark of Dolby Laboratories. Used under authorization.

SACD is a trademark of Sony Electronics, Inc.

SHARC is a Trademark of Analog Devices, Inc.

Hammerhead is a trademark of Analog Devices, Inc.

Lexicon, Logic 7 and the L7 logo are registered trademarks of Harman International Industries, Inc. U.S. Patent Nos. D454,553; D454,860; 5,796,844; 5,870,480 and other worldwide patents issued and pending. Lexicon LIVE is a trademark of Harman International Industries, Inc.

© 2006 Harman International Industries, Incorporated. All rights reserved.

This document should not be construed as a commitment on the part of Harman Specialty Group. The information it contains is subject to change without notice. Harman Specialty Group assumes no responsibility for errors that may appear within this document.

DOCUMENTATION CONVENTIONS

This document contains general safety, installation and operation instructions for the RV-8 Receiver. It is important to read this user guide before attempting to use the product. Pay particular attention to safety instructions.

The following symbols are used in the document:



Appears on the component to indicate the presence of uninsulated, dangerous voltage inside the enclosure – voltage that may be sufficient to constitute a risk of shock.



Appears on the component to indicate important operating and maintenance instructions in the accompanying literature.

WARNING

Calls attention to a procedure, practice, condition or the like that, if not correctly performed or adhered to, could result in injury or death.

CAUTION!

Calls attention to a procedure, practice, condition or the like that, if not correctly performed or adhered to, could result in damage or destruction to part or all of the product.

Note:

Calls attention to information that is essential to highlight.

SETUP ▶ INPUTS ▶ DVD1 ▶ NAME ▶ EDIT INPUT NAME

Represents a menu path. The menu items in gray boxes must be selected with the remote control Menu ▶ arrow to access the menu or menu item in the black box. For example, the SETUP, INPUTS, and DVD1 menu items must be selected to open the DVD1 INPUT SETUP menu.

The DVD1 INPUT SETUP menu is used here as an example and will continue to be used as an example throughout this document. Whenever it appears, any other INPUT SETUP menu may be substituted. Likewise, whenever the DVD1 input appears as a step in a menu path, any other input may be substituted.

This document uses the term DTS(-ES) to indicate that DTS-ES encoding may or may not be present in the input source.

Table of Contents

Documentation Conventions..... ii

Getting Started

About the RV-8..... 1-2

 Highlights 1-4

Product Registration 1-5

Installation Considerations..... 1-5

Remote Control Battery Installation 1-6

Basic Operation

Front-Panel Overview 2-2

Rear-Panel Overview..... 2-6

Tuner Overview..... 2-10

 Selecting a Station 2-10

 Direct Station Access 2-10

 Tune/Seek Access 2-10

 Scan Mode 2-11

 Loading Presets 2-11

 Saving Presets 2-11

 Naming Presets 2-11

 Editing Presets 2-12

 Autoload 2-12

Amplifier Overview..... 2-13

 Amplifier Channel Status 2-13

 Making Connections With the Amplifier Output 2-13

Headphone Overview..... 2-14

Remote Control Overview 2-14

 Operation Considerations 2-14

 MAIN Menu 2-15

 Menu Navigation 2-15

 Menu Item Selection 2-15

 Remote Control Buttons 2-17

 Command Matrix 2-18

Understanding the Zones..... 2-28

Two-Line Status..... 2-28

STATUS Menus..... 2-29

 STATUS Menu Parameter Descriptions 2-34

STATUS Menu Level Meters..... 2-35

Setup

Setup 3-2

Input Setup 3-4

 Changing Input Names 3-5

 Assigning Audio and Video Input Connectors 3-7

 Selecting Preferred Listening Modes 3-12

 Configuring Advanced Input Settings 3-17

 INPUT SELECT Parameter Settings 3-19

 ZONE2 in Parameter Settings 3-22

Speaker Setup 3-25

 Setting Crossover Points 3-25

 Speaker Setup Parameters 3-29

 Automatic Calibration 3-36

 Manual Calibration 3-53

I/O Config..... 3-60

Display Setup 3-63

 On-Screen Display Setup 3-64

 Front-panel Display Setup 3-66

Volume Control Setup..... 3-68

Trigger Setup 3-70

Tuner Setup 3-72

 Tuner Region Band Limit And Increments 3-73

Lock Options..... 3-79

LIVE! CALIBRATION 3-80

Audio Controls

Audio Controls 4-2

Tuner Presets

Tuner Presets 5-2

Mode Adjust

Mode Adjust 6-2

Listening Mode Activation 6-2

 Preferred Listening Mode Selection 6-3

 MODE ▲ and ▼ BUTTONS 6-3

 Listening MODE SELECTION BUTTONS 6-3

Listening Mode Descriptions 6-4

Listening Mode Menu Option and Parameter Descriptions 6-39

Mode – Parameter Relationships 6-47

Troubleshooting and Maintenance

Troubleshooting 7-2

Routine Maintenance 7-4

Restoring Factory-Default Settings 7-4

Appendix A

Specifications A-2

Declaration of Conformity A-4

Appendix B

Menu Tree B-2

Appendix C

Remote Control Programming C-2

 Device Activation C-2

 Macro Operations C-3

 Remote Programming Overview C-4

 Programming Macro Buttons C-10

Three-digit Preprogrammed Codes C-18

Appendix D

Installation Worksheet D-2

Getting Started

About the RV-8.....	1-2
Highlights	1-4
Product Registration.....	1-5
Installation Considerations.....	1-5
Remote Control Battery Installation	1-6

ABOUT THE RV-8

Thank you for purchasing the RV-8 Receiver, an 8-channel audio and video control center with independent zone monitoring that provides control of audio and video source selection in three zones at the same time. The RV-8 includes eight configurable inputs, each of which can be assigned to its built-in tuner, eight digital audio, eight analog audio, phono, five composite video, five S-Video or three component video input connectors. The analog connectors can be configured for up to two 5.1-channel sources.

The RV-8 features an integrated 7-channel power amplifier that is designed to achieve high levels of power and performance. Equipped with a toroidal power transformer, the amplifier also provides thermal and DC protection.

The RV-8 AM/FM stereo radio tuner features four tuning regions, allows for the automatic or manual storing of up to 40 preset stations, can receive elements of the Radio Data System (RDS) broadcasts, and is fully configurable for ease of operation. The RV-8 also includes a phono input.

Inside and out, the RV-8 is designed for possible future developments. The rear panel houses one RS-232 connector capable of performing configuration downloads and flash memory software upgrades, and another capable of supporting future developments. The rear panel also includes one removable access panel to accommodate connectors for emerging technologies.

More than just an audio and video control center, the RV-8 features the latest version of Lexicon's critically acclaimed Logic 7[®] decoding, which creates 7.1-channel output from stereo, and 5.1-and 6.1-channel sources. Unlike other decoders, Logic 7 is compatible with all input sources and requires no special encoding. Because the improvement it provides is clearly audible, Logic 7

decoding is widely regarded as the finest available. A Logic 7-encoded downmix of multichannel source material is available when using the Headphone listening mode. If a stereo source is present, the HEADPHONE L7 listening mode processes it using LOGIC7, then uses Head Related Transfer Functions to create a headphone output that introduces a subtle sense of surround sound, while preserving the original stereo image.

In addition to Logic 7, the RV-8 offers Dolby Digital Surround EX, Dolby Pro Logic IIx, Dolby Pro Logic, DTS 96/24, DTS neo:6, DTS-ES, THX Ultra2 and THX Surround EX decoding. THX Ultra2 certification guarantees that the RV-8 meets the highest THX[®] specifications.

The RV-8 also offers LIVE! (Lexicon Intelligent Variable Environment), designed to transform the way your listening room sounds with the live sound that is created within the room by the occupants of the room. LIVE! does not (nor is it meant to) work with prerecorded material. LIVE! provides a realistic illusion of a larger, more reverberant listening space—ideal for musicians wishing to practice or perform with the sound of a larger venue.

LIVE! is a unique, sophisticated reverberation system that uses a combination of microphones and digital signal processing (DSP) to enhance a room's acoustics and create the illusion of a much larger space. When you engage in normal conversation, it seems as if you are in a large room. When you practice or perform with a musical instrument, it seems as if you are in a concert hall. Choose from one of three customizable presets to create an ambience to liven up a party or amaze your friends.

With two floating-point Hammerhead™ digital signal processing (DSP) engines, the RV-8 boasts enormous processing power. These

powerful processors perform custom Lexicon processing such as Logic 7 decoding, bass enhancement, dialogue enhancement, auto azimuth, five-speaker enhancement, bass management, high-precision digital crossovers and audio controls. These features are available at sample rates of up to 96kHz, with 24-bit resolution to retain top performance from all sources. In addition, a third DSP engine is dedicated to decoding multichannel compressed audio sources.

The RV-8 is one of the most advanced audio and video control centers available. High-precision 24-bit/96kHz A/D converters can be used to convert stereo analog audio input signals to digital signals, allowing the RV-8 to provide the benefits of precise digital signal processing without sacrificing signal integrity. 24-bit/192kHz D/A converters are available for all output channels. Alternatively, 5.1-channel and stereo analog signals can bypass A/D conversion and internal processing, following a pure signal path directly to the output connectors.

Digital audio input signals are processed through a two-stage phase lock loop for extremely low intrinsic jitter and high rejection. Lexicon's proprietary auto azimuth technology corrects timing and

level imbalances in stereo sources, ensuring exceptionally accurate playback of surround-encoded sources. A digital audio pass-through output is available for recording digital signals with a CD recorder or a similar component.

Complementing its audio performance, the RV-8 features broadcast-quality video switchers. An ultrawide-bandwidth component video switcher accepts analog component or RGB video signals, while a composite and S-Video switcher accepts high-quality NTSC, PAL or SECAM video signals. Composite and S-Video sources can be converted to 480i NTSC (576i PAL) component video. The component video switcher can pass high-definition TV (HDTV) signals and standard-definition (SD) TV signals. Both switchers are designed to pass video signals without alteration or degradation.

Built to professional standards, the RV-8 is designed to serve as the control center in any high-quality home theater. Even the most demanding enthusiast will be impressed with its unique combination of power, performance, flexibility and technological sophistication. With extensive expansion capabilities, the RV-8 represents a solid investment that will retain its value in the face of rapidly emerging technologies.

HIGHLIGHTS

- Eight channels
- Eight configurable inputs
- Three independent zones
- Integrated 7-channel amplifier with thermal and DC protection and toroidal power transformer
- Compatible with 2Ω speaker impedances
- AM/FM stereo radio tuner
- RDS
- Phono input with 2-channel analog bypass path
- Up to two 5.1-channel analog audio input connectors
- Analog bypass option for 5.1 analog stereo audio input connectors
- Auto switching between digital and analog audio input connectors
- Headphone output with LOGIC7 processing
- Two 32-bit DSP engines for custom processing
- Separate DSP engine for decoding compressed audio sources
- Four S/PDIF coaxial and four S/PDIF optical (Toslink) digital audio input connectors
- One S/PDIF coaxial and one S/PDIF optical (Toslink) digital audio output connectors
- 24-Bit/192kHz D/A converters for all audio channels
- Two sets of analog A/V Zone 2 outputs; one fixed, one variable
- One set of analog Zone 3 outputs, variable level
- Broadcast-quality video switching
- Video up conversion from S-video/ composite to component video
- Automatic and manual calibration of speaker distances and output levels
- Three component video input connectors with full HDTV compatibility
- Five composite video input connectors
- Five S-Video input connectors
- One component video output
- Logic 7 decoding
- Two 32-bit DSP engines
- LIVE! (Lexicon Intelligent Variable Environment)
- Dolby Digital Surround EX, Dolby Pro Logic IIx, and Dolby Pro Logic decoding
- DTS 96/24, DTS NEO:6, and DTS-ES (discrete and matrix) decoding
- THX Ultra2 and THX Surround EX decoding
- THX Ultra2 certification
- RS-232 control
- Two trigger output connectors
- Rear-panel IR input connector
- Two microphone input connectors
- Two internal expansion slots
- Removable access panel
- Flash memory software upgrade capabilities
- Optional 19-inch rack-mount kit
- IR preprogrammed/learning remote control with LCD display
- Maximum volume level

PRODUCT REGISTRATION

Please register the RV-8 Receiver within 15 days of purchase. Register online at www.lexicon.com or complete and return the product registration card attached to the back cover of this user guide. Retain the sales receipt as proof of warranty coverage.

INSTALLATION CONSIDERATIONS

The RV-8 requires special care during installation to ensure optimal performance. Pay particular attention to instructions below and to other precautions that appear throughout this user guide.

DO install the RV-8 on a solid, flat, level surface such as a table or shelf. The RV-8 can also be installed in a standard 19-inch equipment rack using an optional rack-mount kit available from an authorized Lexicon dealer.

DO select a dry, well-ventilated location out of direct sunlight.

DO NOT expose the RV-8 to high temperatures, humidity, steam, smoke, dampness or excessive dust. Avoid installing the RV-8 near radiators or stacking the RV-8 over other heat-producing equipment such as a power amplifier.

DO NOT install the RV-8 near unshielded TV or FM antennas, cable TV decoders, or other RF-emitting devices that might cause interference.

DO NOT place the RV-8 on a thick rug or carpet, or cover the RV-8 with a cloth, as this might prevent proper cooling.

DO NOT place the RV-8 on a windowsill or any location exposed to direct sunlight.

DO NOT obstruct the front-panel IR receiver window. The remote control must be in line of sight with the IR receiver for proper operation.

DO NOT install the RV-8 on a surface that is unstable or unable to support all four feet.

CAUTION!

Before moving the RV-8, power the unit off using the rear-panel power switch and unplug the power cord from the wall outlet.

REMOTE CONTROL BATTERY INSTALLATION

The remote control requires four AAA batteries. The batteries should be replaced as needed. Alkaline batteries, which last longer without leaking, are recommended. When battery power is low, the remote control enters a low-voltage condition, preventing it from operating the RV-8. When this occurs, replace the batteries. Normal operation will resume when new batteries are installed.

To replace the remote control batteries:

1. Locate the battery compartment on the back of the remote control. Press the tab (1) and lift the cover (2) away from the remote control.
2. Remove old batteries (if applicable).
3. Observing the proper polarity, insert four AAA batteries (3).
4. Align the cover over the battery compartment and gently press down until it snaps back into place (4).
5. Dispose of the old batteries (if applicable).

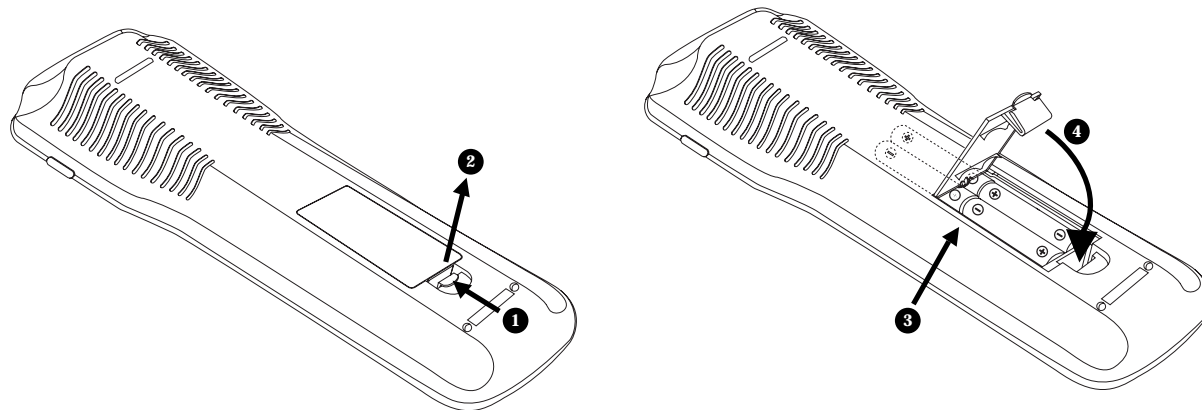

2

Basic Operation

Front-Panel Overview	2-2
Rear-Panel Overview	2-6
Tuner Overview	2-10
Selecting a Station	2-10
Direct Station Access	2-10
Tune/Seek Access	2-10
Scan Mode	2-11
Loading Presets	2-11
Saving Presets	2-11
Editing Presets	2-12
Autoload	2-12
Amplifier Overview	2-12
Amplifier Channel Status	2-13
Making Connections With the Amplifier Output	2-13
Headphone Overview	2-13
Remote Control Overview	2-14
Operation Considerations	2-14
MAIN Menu	2-14
Menu Navigation	2-14
Menu Item Selection	2-15
Remote Control Buttons	2-17
Command Matrix	2-18
Understanding the Zones	2-28
Two-Line Status	2-28
STATUS Menus	2-29
STATUS Menu Parameter Descriptions	2-34
STATUS Menu Level Meters	2-35

FRONT-PANEL OVERVIEW

The RV-8 is shown below. The numbers in the front-panel illustrations correspond with the numbered items in the text.

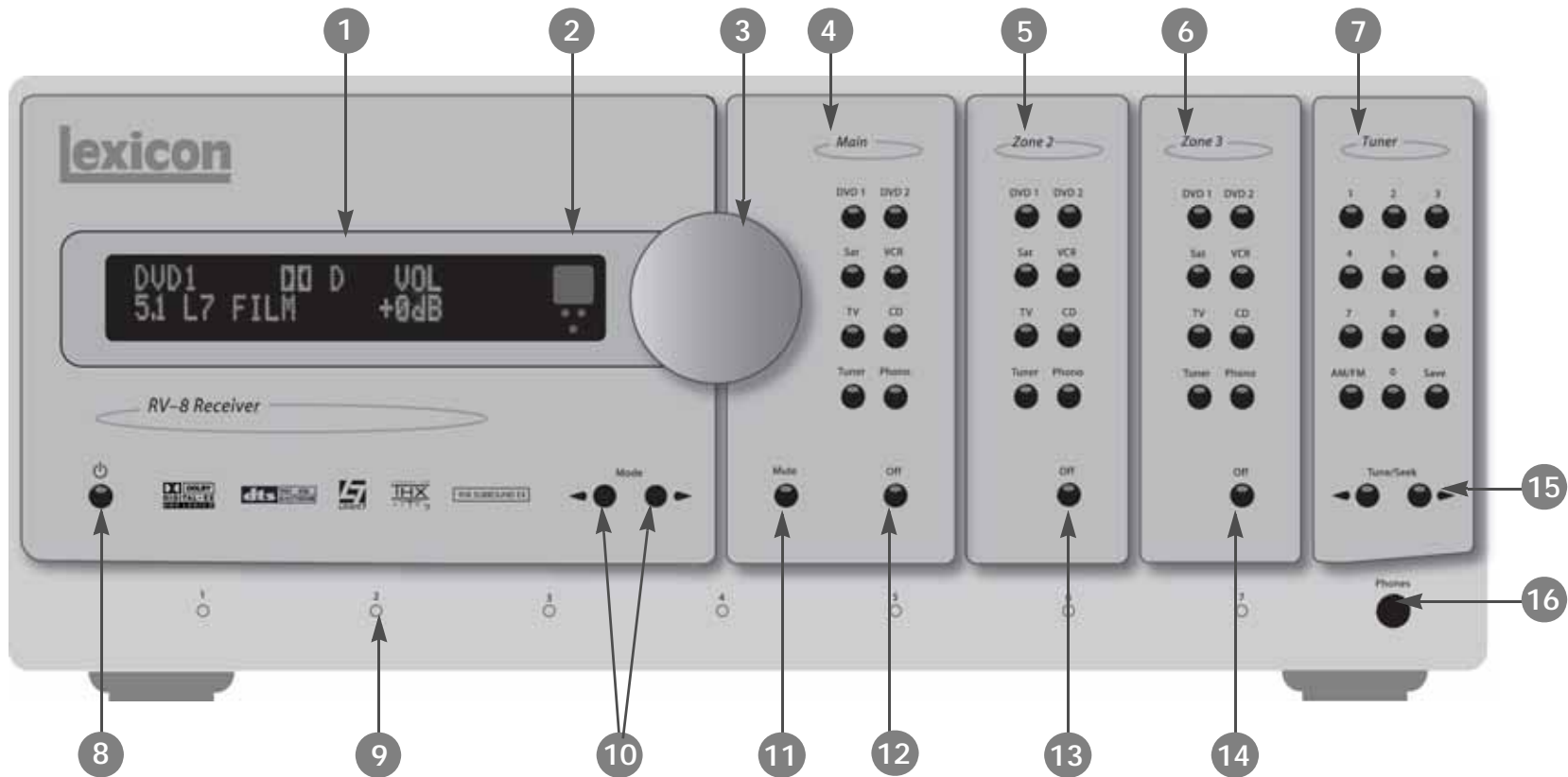

1 FRONT-PANEL DISPLAY

Use the front-panel display to view the current input, listening mode, input source and volume level. If the built-in tuner is active, the display will show the frequency, band, listening mode and volume level. The 2 x 20 character display also functions as a display for messages and menus, one line at a time.

Note:

Power is still supplied to the RV-8 when standby mode is activated.

2 IR RECEIVER

The IR receiver receives infrared commands from the RV-8 remote control. There are three associated LEDs.

- The amber LED blinks when a remote control command is received.
- The red LED lights when the A/D converters are overloading.
- The blue LED lights when the RV-8 is powered on and activated – even if the FRONT PANEL DISPLAY menu STATUS parameter is set to ALWAYS OFF.

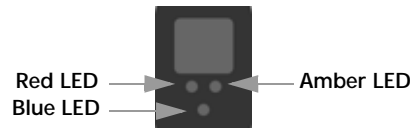

3 VOLUME KNOB

Use the volume knob to adjust volume level in all Zones.

To adjust the Main Zone volume level:

Rotate the volume knob clockwise to increase or counterclockwise to decrease volume level in 1dB increments. A horizontal bar graph indicating the current Main Zone volume level is displayed in the on-screen and front-panel displays. The Main Zone volume range is -80 to +12dB.



To adjust the Zone 2 or Zone 3 volume level:

1. Press and hold the front-panel Zone 2 or Zone 3 input selection button that corresponds with the current input source. For instance, if the current input source is using the DVD1 input, press and hold the DVD1 input selection button in the desired zone.
2. While holding the desired zone input selection button, rotate the volume knob clockwise to increase or counterclockwise to decrease volume level in 1dB increments. The corresponding horizontal graph appears in the on-screen and front-panel displays, and indicates the position at which the current Zone 2 or Zone 3 volume level falls within the -80 to +12dB volume range.
3. Release the selected Zone 2 input selection button when Zone 2 or Zone 3 volume level has been set.



Note:

When RV-8 output levels have been properly calibrated, the +0dB volume level setting corresponds to THX reference levels (75dB).

FRONT-PANEL OVERVIEW (continued)**4 MAIN ZONE INPUT SELECTION BUTTONS**

Selects the corresponding input in the Main Zone. When an input is selected, a blue LED lights on the corresponding input selection button. When the Main Zone is deactivated, pressing a Main Zone input selection button activates the corresponding input in the Main Zone. Zone 2 and Zone 3 remain deactivated until a Zone 2 or Zone 3 input is selected.

5 ZONE 2 INPUT SELECTION BUTTONS

Selects the corresponding input in Zone 2. When an input is selected, an amber LED lights on the corresponding input selection button. When Zone 2 is deactivated, pressing a Zone 2 input selection button activates the corresponding input in Zone 2. The Main Zone and Zone 3 remain deactivated until a Main Zone or Zone 3 input is selected.

6 ZONE 3 INPUT SELECTION BUTTONS

Selects the corresponding input in Zone 3. When an input is selected, a red LED lights on the corresponding input selection button. When Zone 3 is deactivated, pressing a Zone 3 input selection button activates the corresponding input in Zone 3. The Main Zone and Zone 2 remain deactivated until a Main Zone or Zone 2 input is selected.

7 TUNER SELECTION BUTTONS

Tuner selection buttons allow for direct entry of station frequencies, selection of AM or FM broadcast bands and the saving/recalling of

presets. See "Tuner Overview" on page 2-10 for additional information.

8 STANDBY BUTTON

Toggles the RV-8 between on and standby. When the RV-8 is powered on, pressing this button places the RV-8 into standby and lights the red LED on the button. Power is supplied to the RV-8 when in standby. When the RV-8 is in standby, pressing the button turns the unit on and activates all zones that were active in the previous operating session.

In the event of a power outage, the RV-8 will display a BROWN OUT!! PRESS STANDBY message. To turn the unit on, use the STANDBY button. For more information, see "POWER MANAGEMENT" on page 3-3.

9 CHANNEL STATUS LEDs

Each amplifier channel has a blue LED on the front panel that is illuminated when the unit is powered on. If there is a problem with an amplifier channel, the corresponding LED will turn off. See "Amplifier Overview" on page 2-13 for additional information.

10 MODE ◀ and ▶ BUTTONS

Use the Mode buttons to scroll to the previous (◀) or next (▶) available listening mode. Scrolling occurs in the order shown in the MODE ADJUST menu. Refer to "Listening Mode Activation" on page 6-2 for more information.

11 MUTE BUTTON

Mutes or restores the RV-8 Main Zone volume to its original level. Press the Mute button to mute volume level; "MUTE ON" appears in the on-screen and front-panel displays. Press the Mute button again to restore the volume to its original level. The VOLUME CONTROL SETUP and MUTE LEVEL parameter can be used to set mute levels.

Mute may be activated automatically or manually. For example, the RV-8 briefly activates mute when changing input sources or listening modes. The amber Mute button LED lights whenever mute is activated.

12 MAIN ZONE OFF BUTTON

Deactivates the Main Zone.

13 ZONE 2 OFF BUTTON

Deactivates Zone 2.

14 ZONE 3 OFF BUTTON

Deactivates Zone 3.

15 TUNE/SEEK BUTTONS

Allow for manual or automatic tuning of the AM/FM stereo radio tuner.

16 HEADPHONE OUTPUT

Features multiple listening modes including LOGIC7 headphone processing. The headphone output follows the signal selected in the Main Zone. When headphones are plugged into the headphone output, all Main Zone amplifier outputs are muted. If amplifier outputs 3 and 7 are assigned to Zone 2 or Zone 3, they remain unmuted. The Main Zone preamplifier outputs are also muted when headphones are plugged in. Preamplifier outputs for Zone 2 and Zone3 remain unmuted. See "Headphone Overview" on page 2-14 for additional headphone information. Headphone listening mode information starts on page 6-34.

REAR-PANEL OVERVIEW

The RV-8 is shown below. The numbers in the rear-panel illustrations correspond with the numbered items in the text.

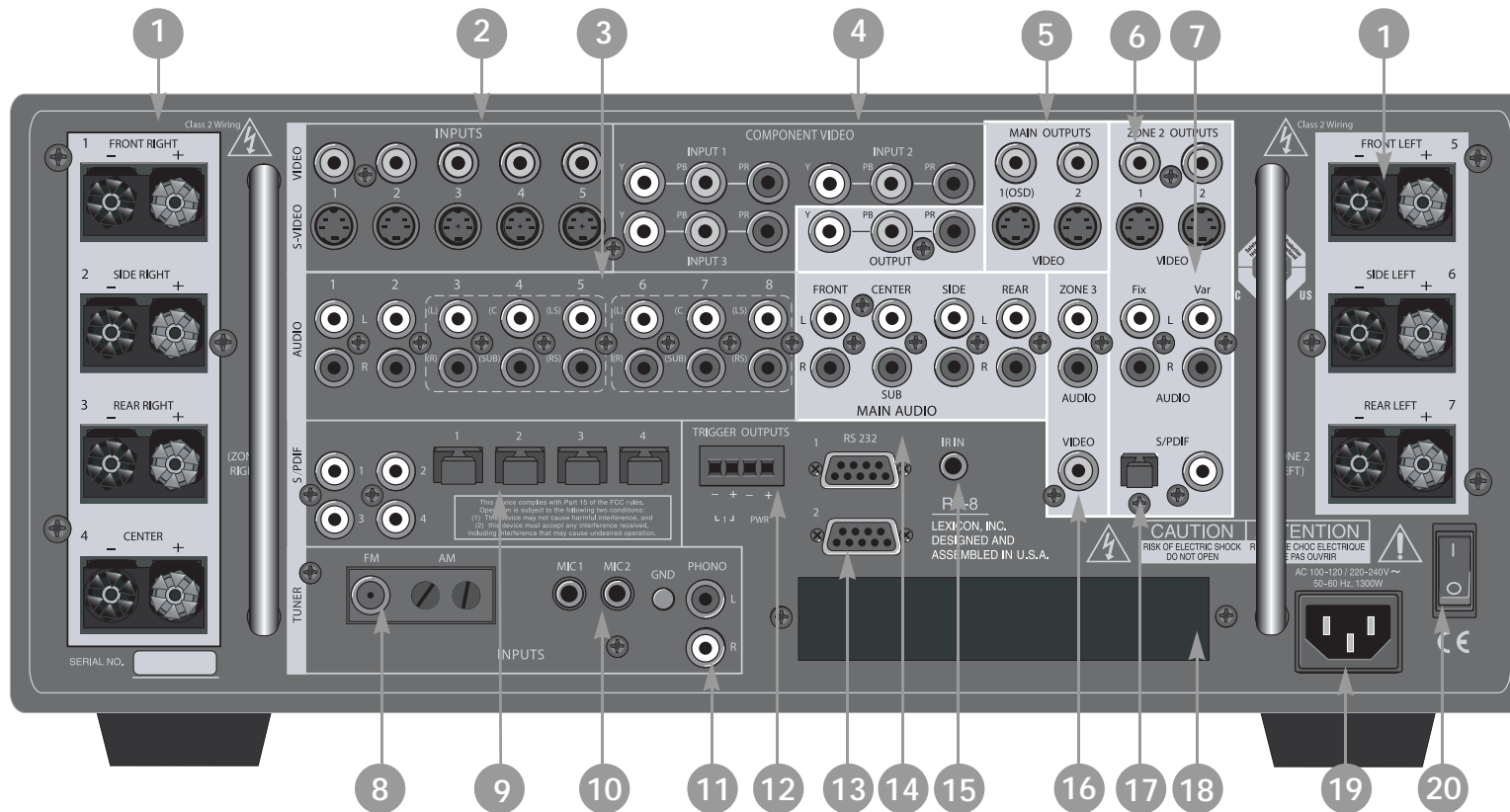

CAUTION! Never make or break connections to the RV-8 unless the RV-8 and all associated components are powered off.

1 AMPLIFIER OUTPUTS

Provide audio outputs to the speakers. The Center channel output and all Right channel outputs are located on the left-hand side of the rear-panel. All Left channel outputs are located on the right-hand side of the rear-panel. This organizaion facilitates making speaker connections. The amplifier binding posts accommodate the following connectors:

- standard 0.75-inch banana plugs
- size 10-12 gauge spade connectors
- up to 10-gauge bare wire

See page 2-13 for additional amplifier information.

2 VIDEO INPUT CONNECTORS

Provide video input in the Main Zone, Zone 2 and Zone 3. Five composite video connectors labeled Video 1 to 5, and five S-Video connectors labeled S-Video 1 to 5 are available.

3 ANALOG AUDIO INPUT CONNECTORS

Provide analog audio input in the Main Zone, Zone 2 and Zone 3. Eight stereo analog audio input connectors labeled Audio 1 to 8 are available. Connectors labeled 3, 4, 5, 6, 7 and 8 can be configured as 5.1-channel connectors.

When a 5.1-channel analog audio source is present in the Main Zone, input signals are sent to the Main Zone audio output connectors as indicated in the following table. When a 5.1-channel analog source is

present in the Main Zone, only the Front (L) and (R) input signals are sent to the Zone 2 and Zone 3 audio output connectors. If the ZONE2 IN parameter is set to DMIX, a downmix of the 5.1 analog source is sent to the Zone 2 audio output connectors. See "ZONE2 in Parameter Settings" on page 3-22 for additional information.

Input Connector	Output Connector
(L)	Front L
(R)	Front R
(C)	Center
(SUB)	Subwoofer
(LS)	Side L and Rear L
(RS)	Side R and Rear R

4 COMPONENT VIDEO INPUT CONNECTORS

Three component video input connectors labeled Component Video 1 to 3 are available for use in the Main Zone and have full HDTV compatibility. The ultra-wide bandwidth component video switcher accepts any analog component or RGB video input type. The component video connectors are not available for Zone 2 or Zone 3.

5 MAIN ZONE VIDEO OUTPUT CONNECTORS

Provide video output in the Main Zone. Two composite video connectors, two S-Video connectors and one component video connector are available.

REAR-PANEL OVERVIEW (continued)**6 ZONE 2 VIDEO OUTPUT CONNECTORS**

Provide video output in Zone 2. One composite video connector and one S-Video connector is available. Alternatively, these connectors can be used to connect a video recording device.

Note:

- *Composite video output connectors are available when a composite or S-Video source is present.*
- *S-Video output connectors are available when an S-Video source is present.*
- *Component video output connectors are available when a component video source is present.*

7 ZONE 2 ANALOG AUDIO OUTPUT CONNECTORS

Provide analog audio output in Zone 2. Two pairs of connectors, one labeled "Fix" and the other labeled "Var" are available. These connectors can also be used to connect a recording device. For recording, use the output connector labeled "Fix," which provides a fixed output level of +0dB. If output level adjustment is needed, use the output labeled "Var" and adjust the Zone 2 volume.

Note:

When using an analog input source, the Zone 2 and Zone 3 audio outputs are approximately 2dB lower than the Main audio outputs labeled Front L/R. When using a digital input source, the Zone 2 audio outputs are approximately 6dB higher than the Main audio outputs labeled Front L/R. This is to accommodate THX level requirements.

8 TUNER ANTENNA CONNECTORS

Provide two antenna connections for the AM/FM stereo radio tuner.

9 DIGITAL AUDIO INPUT CONNECTORS (S/PDIF)

Provide digital audio input in the Main Zone or Zone 2. Four S/PDIF coaxial and four S/PDIF optical (Toslink) input connectors are available. Connectors are compatible with PCM (44.1, 48, 88.2 and 96kHz), Dolby Digital and DTS(-ES) sources. Connectors are not compatible with MPEG (MP3) sources.

10 MICROPHONE INPUT CONNECTORS

Provides microphone input for automatic calibration.

11 PHONO INPUT CONNECTORS

Provide a phono level input, which can be assigned to any of the eight RV-8 inputs. A 2-channel analog bypass path is available (with RIAA curve). A ground connector is also provided. The phono input is optimized for moving magnet phono cartridges.

12 TRIGGER OUTPUT CONNECTORS

Provide 12V DC output to control connected components. Two trigger output connectors are available on a removable terminal block. The PWR connector (the power trigger output connector) is not configurable. It is activated when the RV-8 is powered on, and deactivated when the RV-8 is powered off from the rear panel or by

putting the RV-8 into standby. The trigger output connector (labeled 1) can be configured for remote or program operation. See "Trigger Setup" on page 3-70 for more information.

13 RS-232 CONNECTORS

The RS-232 serial connector (1) provides serial control and is used to perform configuration downloads and flash memory software upgrades. The RS-232 connector (2) is reserved for future developments.

14 MAIN ZONE AUDIO OUTPUT CONNECTORS

Provide analog audio output in the Main Zone. Eight connectors labeled Front L/R, Center, Sub, Side L/R and Rear L/R are available.

15 IR IN CONNECTOR

Accepts input of IR signals from infrared distribution equipment. One 3.5mm jack that accepts a stereo plug (Tip/Ring/Sleeve connection) or mono plug (Tip/Sleeve connection) is available.

16 ZONE 3 AUDIO/VIDEO OUTPUT CONNECTORS

Provide analog audio/video output in Zone 3. One stereo analog audio output (variable level) is available and can derive its source from a variety of analog sources. One composite video output is available and can derive its source from any composite or S-video source.

17 ZONE 2 DIGITAL AUDIO OUTPUT CONNECTORS (S/PDIF)

Provides digital audio output in Zone 2. One S/PDIF coaxial and one S/PDIF optical (Toslink) connector is available.

18 REMOVABLE ACCESS PANEL

Reserved for future developments.

19 AC INPUT CONNECTOR

Provides power to the RV-8 through the supplied power cord.

20 POWER SWITCH

Use the Power switch to connect or disconnect power from the AC Input connector to the RV-8. The **I** and **O** positions represent "on" and "off" status, respectively. When the RV-8 is powered on, the front-panel Standby button or remote control On button can be used to activate and deactivate standby mode. When the RV-8 is powered off, standby mode is not available.

In the event of a power outage, the RV-8 will display a BROWNOUT, CYCLE POWER message. To turn the unit back on, use the rear-panel power switch. In this instance, the front-panel StandBy switch has no effect.

TUNER OVERVIEW

The RV-8 features an AM/FM stereo radio tuner. The front panel displays the currently selected frequency, band, listening mode and volume. Forty presets can store AM or FM frequencies, identified by the preset number/name and station frequency/band. For example: WABC/90.90 FM or Preset 02/10.30 AM. Two antennas are supplied with the RV-8: one for AM and one for FM stereo. At a minimum, use of the supplied antennas is recommended to ensure consistent tuner performance.

The tuner can be setup to receive elements of the Radio Data System (RDS) broadcasts. Originated in Europe and now with limited availability in the US, the RDS is a standard for broadcasting digital data along with an FM radio broadcast. When the RDS option is active and RDS data is received, the RV-8 tuner displays the identity of the broadcast station, receipt of alternate station frequencies and any additional text (referred to as RT or Radio Text) that the station broadcasts. For more information on RDS features, see "Tuner Setup" on page 3-72.

SELECTING A STATION

Begin selecting a radio station by activating the built-in tuner input. To activate the tuner input, press the front-panel TUNER button or select the TUNER option from the remote-control MAIN screen. See the "Tuner Setup" on page 3-72 for more information.

Next, determine if the desired frequency band is active by pushing the front-panel or remote-control AM/FM button to toggle between the AM and FM frequency bands.

Once the frequency band is set, there are several ways to select a radio station: direct station access, tune/seek access, scan mode and presets.

DIRECT STATION ACCESS

To access a specific frequency, use the numeric buttons on either the front panel or remote control to enter the desired station frequency.

To directly access a station from the front panel or remote control:

1. Press the AM/FM button to select the desired band.
2. Enter the three or four digit station frequency. For example, to load FM station 90.9, press 9-0-9. To load AM station 1030, press the AM/FM button to select the AM band, then press 1-0-3-0.

Note:

When digits are first entered, a "Loading Preset" status message appears in the front-panel (and on-screen) display. When a third digit is entered, the RV-8 senses a frequency is being entered and changes the status message to "Setting Frequency."

TUNE/SEEK ACCESS

Press one of the Tune/Seek buttons on the front panel (◀ / ▶) or remote control (◀◀ / ▶▶) to navigate to the next available frequency. For example, if the currently loaded frequency is 101.7FM, press the Tune/Seek ▶ button to load 101.9FM. Press the Tune/Seek ▶ button again to load 102.1FM, and so on.

Press one of the Tune/Seek buttons on the front panel (◀ / ▶) or remote control (◀◀ / ▶▶) for 2 seconds to activate seek mode. Seek mode searches for the next available radio station. If the tuner is having difficulty locating stations, raise the sensitivity level. See "SCAN SENS" on 3-73 for more information.

SCAN MODE

Scan Mode scans through all available stations, pausing for two seconds on each station before scanning to the next one.

To enter Scan Mode:

Press and hold the front-panel (◀ / ▶) or remote-control (◀◀ / ▶▶) Tune/Seek buttons until ◀ SCAN or SCAN ▶ is displayed.

To stop scanning:

Press either Tune/Seek button.

LOADING PRESETS

To load a preset:

Enter a preset (number between 1 and 40) using the front-panel or remote-control number buttons.

A "Loading Preset" status message appears in the front-panel (and on-screen) display. If a third digit is entered, the tuner switches over to Direct Station Access mode and the front-panel status message changes to "Setting Frequency."

To skip through available presets in order:

Press the remote-control ◀◀ or ▶▶ button. For example, if preset 1 is loaded and the ▶▶ button is pressed, the RV-8 will load preset 2 (or the next available preset). If preset 1 is loaded and the ◀◀ button is pressed, the RV-8 will load preset 40 (or the next available preset).

Note:

This feature is only accessible via the remote control.

SAVING PRESETS

The RV-8 has 40 presets available for storing AM or FM stations. The presets are divided into four banks with ten presets per bank. It is possible to store a combination of AM and FM stations in each bank. Storing presets on the RV-8 can be accomplished from either the front panel or the remote control. The operation is identical.

To save a station as a preset on the RV-8:

1. Press the front-panel or remote-control SAVE button. A status message displaying "Saving Preset" appears in the front-panel (and on-screen) display.
2. Enter a number between 1 and 40 to save the currently loaded frequency as the corresponding preset.

For example, if the tuner is currently playing 101.7FM, press the SAVE button, then the 1 button to save 101.7FM as preset number 1.

Press the 1 button followed by the 5 button to save as preset number 15. Pressing more than two numbers resets the preset number to the third digit entered.

Pressing the SAVE button a second time cancels the saving process.

NAMING PRESETS

Preset stations use a naming system based on the RDS system. In the US, each preset channel is identified by the station's call letters, or what the broadcast information identifies as the call letters. In Europe and Japan, each preset channel is identified by the station's Program Service (PS) name.

If the RDS information is not available, the preset name defaults to PresetXX, where XX is the listed number position in the Preset menu.

For example, if Preset #01 is FM 90.90 and the call letters are WABC, then the name for that position is WABC. If Preset #23 does not broadcast their call letters, then that location is identified as Preset23 in the menu.

EDITING PRESETS

It is possible to customize the name of each preset on the RV-8.

To edit the preset name:

1. Select TUNER PRESETS from the MAIN MENU. The TUNER PRESETS menu contains a list of preset pages. PAGE 1 contains presets 1 through 10, PAGE 2 contains presets 11 through 20, etc.
2. Select the page containing the desired preset.
A list of presets appears.
3. Select the desired preset.
The EDIT PRESET menu opens and displays the preset call letters (or PS), frequency, and band.

The EDIT PRESET menu options are as follows:

- Select LISTEN TO PRESET to load the preset frequency.
- Select NAME to customize the preset name. The preset name can be up to eight characters long.
- Select CLEAR PRESET to clear the frequency and band information from the preset.

See "Tuner Presets" on page 5-2 for additional information.

AUTOLOAD

The RV-8 can automatically scan and store presets. This can be accomplished only from the remote control. See "Tuner Setup (continued)" on page 3-74 for additional information.

To start autoloading:

1. Select AUTOLOAD from the MAIN MENU : SETUP : TUNER SETUP menu.
2. Press menu ▶ to start AUTOLOAD.

AMPLIFIER OVERVIEW

The RV-8 features a 7-channel power amplifier with 140W per channel. The RV-8 can be configured so that all amplifier channels are dedicated to the Main Zone or so that outputs 3 and 7 (labeled Rear Right and Rear Left) are used for Zone 2 or Zone 3. Heavy duty gold plated 5-way binding posts are provided for speaker connections.

The amplifiers feature advanced thermal current and DC protection for each channel. Thermal protection monitors the temperature of the chassis and heatsinks and automatically deactivates the specific channel(s) when they exceed their normal safe operating temperature. Current protection ensures that the output transistors are protected by limiting the current capability which is determined by the output voltage, while DC protection prevents DC and frequencies below 10Hz from reaching the speakers. Dedicated channel status LEDs are located on the front panel to provide at-a-glance viewing of channel status at all times. If the main power transformer temperature exceeds 100°C, the transformer will deactivate, all channel status LEDs will no longer be lit and the red standby LED will flash rapidly. Once the transformer has cooled, it automatically resets and the amplifier operates normally; the channel status LEDs turn back on, and the red standby LED is no longer lit.

The amplifiers are designed to meet the highest standards of performance and sound quality. In addition, THX Ultra2 certification ensures that the amplifiers meet the highest standards set forth by Lucasfilm's Home THX division.

AMPLIFIER CHANNEL STATUS

Each channel has a blue Channel Status LED on the front panel that is illuminated when the unit is powered on. If there is a problem with an amplifier channel, the LED will turn off.

MAKING CONNECTIONS WITH THE AMPLIFIER OUTPUT

The amplifier output connectors can accept bare speaker wires, banana plug connectors or certain spade connectors. When using bare speaker wires, loosen the connector, insert the wire into the top of the receptacle, then tighten the connector. The same procedure should be used for spade connectors. Banana plugs should be inserted into the outward-facing receptacle.

Use heavy-gauge speaker cable to ensure low-impedance connections between the amplifier and the speakers. Observe correct speaker polarity.

CAUTION! Do not connect the outputs of one channel to the outputs of other channels or to other amplifiers.

HEADPHONE OVERVIEW

Headphones can be connected to the RV-8 via the Headphone output on the front panel. The headphone output follows the signal selected in the Main Zone. If the Main Zone source is multichannel, a downmix of the source is sent to the headphone output. LOGIC7 headphone processing is also available for stereo or multichannel sources. To listen to a stereo source without enhanced processing, set the 2-CH parameter in the INPUT SETUP menu to the 2-CHANNEL listening mode. When headphones are plugged into the headphone output, all amplifier outputs are muted (including outputs 3 and 7, unless they are assigned to Zone 2 or Zone 3). The Main Zone preamplifier outputs are also muted. Preamplifier outputs for Zone 2 and Zone 3 remain unmuted. Use the front-panel volume knob or the remote-control Volume Up/Down buttons to adjust the headphone output level.

When the headphones are plugged into the headphone output, the volume defaults to the HEADPHONE parameter value selected in the VOLUME CONTROL SETUP menu. When the headphones are unplugged, the volume defaults to the value of the MAIN PWR ON parameter in the VOLUME CONTROL SETUP menu. See page 6-34 for headphone listening mode descriptions.

REMOTE CONTROL OVERVIEW

The RV-8 remote control provides full operation of the RV-8, including commands, such as menu navigation, that are not available from the front panel. It is also designed to provide control for the entire home theater system. This section provides a brief overview of the remote control. For detailed operation/programming instructions and manufacturing codes, refer to Appendix C.

OPERATION CONSIDERATIONS

The following factors can improve or impede remote control operation.

Note the following before operating the RV-8 remote control:

- The remote control must be in line-of-sight with the front-panel IR receiver. Eliminate obstructions between the remote control and the IR receiver. The remote control may become unreliable if strong sunlight or fluorescent light shines on the IR receiver.
- For optimal performance, position the remote control at a 30-degree angle no more than 40 to 60 feet (12.2m to 18.3m) from the RV-8. Placing the RV-8 inside a smoked glass cabinet will reduce the remote control range.
- Remote controls for different components can interfere with one another. Avoid using remote controls for different components at the same time.
- Remote-control batteries should be replaced as needed.

MAIN MENU

Use the MAIN MENU to open the four main menu branches: MODE ADJUST, AUDIO CONTROLS, TUNER PRESETS and SETUP.



MENU NAVIGATION

Use the remote-control arrow buttons to navigate the extensive menu structure starting on page B-2. The table below indicates the navigation commands that the remote-control buttons perform when the Main Zone command bank is activated.

Note:

The DVD1 device has been preprogrammed to control the Lexicon RT-10 and RT-20 disc players.

MENU ITEM SELECTION

Use the remote-control Menu arrows to navigate menus and to select menu items.

To select a menu item on the open menu:

1. Press the remote-control ▲ and ▼ arrows to highlight the desired menu item.
2. When the desired menu item is highlighted, press the Menu ► arrow to select the highlighted item. If an option is selected, another menu opens. If a parameter is selected, a parameter drop-down menu or horizontal graph opens.

Arrow	Navigation Functions
►	<ul style="list-style-type: none"> • When a menu is open, press the remote-control Menu ► arrow to select the highlighted menu item. • When no menus are open, press the Menu ► arrow to open the MAIN MENU.
◄	<ul style="list-style-type: none"> • When a menu is open, press the Menu ◄ arrow to close the menu and, in most cases, open the previous menu. Subsequent presses continue to close the current menu and open the previous menu until the MAIN MENU is closed. When the MAIN MENU is closed, the menu structure is also closed. • When no menus are open, pressing the Menu ◄ arrow button performs no function. • When a drop-down menu is open, press the Menu ◄ arrow to select the current setting and close the drop-down menu.
▲ ▼	<ul style="list-style-type: none"> • When a menu is open, press the Menu ▲ and ▼ arrow buttons to scroll upward and downward through the complete list of menu items. The highlighted menu item appears in the front-panel display. All menu items appear in the on-screen display. A scroll bar appears in the left side of the on-screen display when menu items exceed the on-screen display's top and bottom margins. The cursor automatically wraps to the next menu item when the first or last menu item is passed.

MENU OPTIONS

Selecting a menu option opens another menu within the menu structure. For example, selecting SETUP from the MAIN MENU opens the SETUP menu.

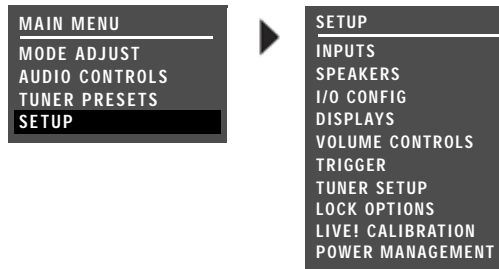

PARAMETER DROP-DOWN MENUS

Selecting some menu options opens a drop-down menu that contains a list of available parameter settings. For example, selecting the CUSTOM NAME parameter from the DISPLAY SETUP menu opens a drop-down menu which is used to select the ON or OFF setting.



To select a setting in a parameter drop-down menu:

1. When the drop-down menu opens, press the remote-control ▲ and ▼ arrows to scroll upward and downward through the complete list of available settings. The current setting is displayed beneath the parameter name in the on-screen and front-panel displays.

2. When the desired setting appears beneath the parameter name, press the ◀ arrow to accept the setting and close the drop-down menu.

HORIZONTAL BAR GRAPHS

Selecting some menu parameters opens a horizontal bar graph. The bar graph indicates the position at which the current parameter setting falls within the entire parameter range.

For example, selecting the A/V SYNC DELAY parameter from the DISPLAY SETUP menu opens the horizontal bar graph shown below, which is used to adjust the amount of audio delay.



To adjust a parameter setting with a horizontal bar graph:

1. When the horizontal bar graph appears, press the remote-control ▲ and ▼ arrows to increase or decrease the setting in the designated increments. The setting appears to the right of the parameter name in the on-screen and front-panel displays.
2. When the desired adjustments have been made, press the ◀ arrow to select the setting and close the horizontal bar graph.

Note:

Menu item selection instructions differ for certain menus. These instances are noted throughout this user guide.

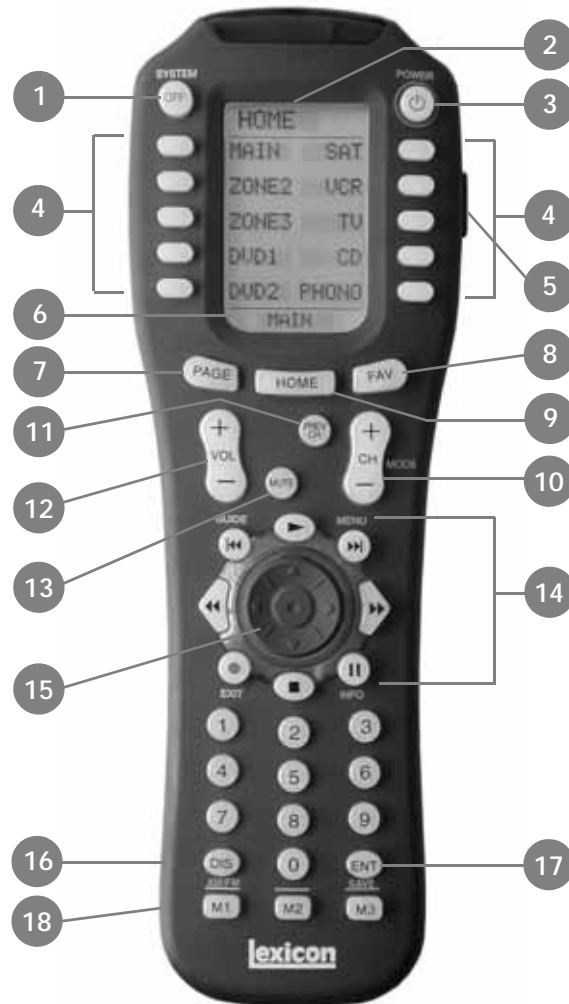

REMOTE CONTROL BUTTONS

1. SYSTEM POWER OFF
2. Displays the name of the selected device.
3. POWER ON
4. Device and function buttons
5. Light
6. Displays page number/currently selected device
7. LCD page change
8. FAVORITE
9. HOME menu
10. CHANNEL/Listening Mode (+/-)
11. Previous channel
12. VOLUME (+/-)
13. MUTE
14. TRANSPORT functions (PLAY, STOP, REWIND, PAUSE, REC, SKIP and FF) for VCR, DVD and CD
15. JOYSTICK (left, right, up, down and center press)
16. DISPLAY/AM/FM
17. ENTER/SAVE
18. MACRO buttons

COMMAND MATRIX

The command matrix describes the commands that the remote control buttons perform when each command bank is active.



BUTTON	HOME	MAIN PAGE1	MAIN PAGE2	ZONE2 PAGE1	ZONE2 PAGE2
1	Enters RV-8 standby mode.				
2	Activates the RV-8.				
3	Displays the MAIN Zone command bank, which includes commands that control the Main Zone.	Displays the Main Zone Status.	Selects the Dolby Digital listening mode family.	Displays the Zone 2 Status.	Toggles RV8 between 5 speaker and 7 speaker modes.
4	Displays the Zone 2 command bank, which includes commands that control Zone 2.	Deactivates the Main Zone.	Selects the DTS listening mode family.	Deactivates Zone 2.	Adjusts the AUDIO CONTROLS menu Main Zone BALANCE to the left.
5	Displays the Zone 3 command bank, which includes commands that control Zone 3.	Selects the Tuner input for the Main Zone.	Selects the THX listening mode family.	Selects the Tuner input for Zone 2.	Sets the Main Zone Volume level to -15dB.
6	Displays the DVD1 command bank, which includes commands that control DVD1.	Selects the DVD1 input for the Main Zone.	Toggles between the current listening mode and the 2-CHANNEL listening mode.	Selects the DVD1 input for Zone 2.	Shows status menu for current Main Zone input stream. STAT2 button: see page 2-29 for more information.
7	Displays the DVD2 command bank, which includes commands that control DVD2.	Selects the DVD2 input for the Main Zone.	Analog Bypass Toggle.	Selects the DVD1 input for Zone 2.	Activates the RV-8.
8	Displays the SAT command bank, which includes commands that control the Satellite box.	Selects the SAT input for the Main Zone.	Selects the L7 FILM listening mode.	Selects the Satellite input for Zone 2.	Reserved for future expansion.



BUTTON	ZONE3 PAGE1	ZONE3 PAGE2	DVD1 PAGE1	DVD1 PAGE2
1	Enters RV-8 standby mode.		Reserved for future expansion.	
2	Activates the RV-8.		Toggles RT-10 or RT-20 power.	
3	Displays the Status of Zone 3.	Resets the AUDIO CONTROLS menu BASS, TREBLE, and TILT EQ parameter to +0.0dB.	Opens and closes the RT-10 or RT-20 disc tray.	
4	Deactivates Zone 3.	Decreases the AUDIO CONTROLS menu Main Zone BASS parameter in .5dB increments.	Opens the RT-10 or RT-20 Top menu.	Opens and closes the RT-10 or RT-20 Video Adjust bar.
5	Selects the TUNER input for Zone 3.	Decreases the AUDIO CONTROLS menu Main Zone TREBLE parameter in .5dB increments.	Activates RT-10 or RT-20 random playback.	Opens the RT-10 or RT-20 Angle bar.
6	Selects the DVD1 input for Zone 3.	Decreases the AUDIO CONTROLS menu Main Zone TILT EQ parameter in .2dB increments.	Activates RT-10 or RT-20 repeat playback.	Activates the RT-10 or RT-20 condition memory mode.
7	Selects the DVD2 input for Zone 3.	Deactivates AUDIO CONTROLS menu Main Zone LOUDNESS parameter.	Activates RT-10 or RT-20 A-B repeat playback.	Activates the RT-10 or RT-20 last memory playback.
8	Selects the Satellite input for Zone 3.	Reserved for future expansion.	Opens the RT-10 or RT-20 Setup menu.	Creates up to five shortcuts for frequently adjusted RT-10 or RT-20 Setup menu parameters.



BUTTON	HOME	MAIN PAGE1	MAIN PAGE2	ZONE2 PAGE1	ZONE2 PAGE2
9	Selects the VCR command bank, which includes commands that control the VCR.	Selects the VCR input for the Main Zone.	Selects the L7 Music listening mode.	Selects the VCR input for Zone 2.	Adjusts the Audio Controls menu Main Zone BALANCE parameter to the right.
10	Selects the TV command bank, which includes commands that control the TV.	Selects the TV input for the Main Zone.	Selects the L7 TV listening mode.	Selects the TV input for Zone 2.	Sets the Main Zone volume level to -30dB.
11	Selects the CD command bank, which includes commands that control the CD player.	Selects the CD input for the Main Zone.	Selects the L7 Music Surround listening mode.	Selects the CD input for Zone 2.	Toggles the Setup ON SCREEN DISPLAY parameter.
12	Selects the Phono command bank, which includes commands that control the associated device.	Selects the Phono input for the Main Zone.	Toggles between setting the input to auto, analog or digital.	Selects the Phono input for Zone 2.	Deactivates the RV-8.
13	N/A	Selects Page 2 of the Main Zone command bank.	Selects Page 1 of the Main Zone command bank.	Selects Page 2 of the Zone 2 command bank.	Selects Page 1 of the Zone 2 command bank.
14	Selects the Home command bank.				
15	Scrolls through Favorite Channel pages.				
16	History-dependent*	Increases the Main Zone volume level in 1dB increments.		Increases the Zone 2 volume level in 1dB increments.	

* History-dependent buttons perform different functions, depending on the Zone or device that is currently being controlled. Check the bottom of the LCD for the currently controlled device.



BUTTON	ZONE3 PAGE1	ZONE3 PAGE2	DVD1 PAGE1	DVD1 PAGE2
9	Selects the VCR input for Zone 3.	Increases the AUDIO CONTROLS menu BASS parameter in .5dB increments.	Closes certain Setup menus without saving the changes.	Activates and deactivates the RT-10 or RT-20 rear-panel video output connectors.
10	Selects the TV input for Zone 3.	Increases the AUDIO CONTROLS menu TREBLE parameter in .5dB increments.	Activates the RT-10 or RT-20 display mode.	Controls the brightness of front-panel display characters.
11	Selects the CD input for Zone 3.	Increases the AUDIO CONTROLS menu Main Zone TILT EQ parameter level in .2dB increments.	Opens the RT-10 or RT-20 Subtitle bar.	Activates the RT-10 or RT-20 search mode.
12	Selects the Phono input for Zone 3.	Activates the AUDIO CONTROLS menu Main Zone LOUDNESS parameter.	Opens the RT-10 or RT-20 Audio bar.	Activates the RT-10 or RT-20 program mode.
13	Displays Zone 3 Page 2 command bank.	Displays Zone 3 Page 1 command bank.	Displays DVD1 Page 2 command bank.	Displays DVD1 Page 1 command bank.
14	Displays the Home command bank.			
15	Scrolls through Favorite Channel pages.			
16	Increases Zone 3 volume level in 1dB increments		Increases RV-8 Main volume level in 1dB increments	



BUTTON	HOME	MAIN PAGE1	MAIN PAGE2	ZONE2 PAGE1	ZONE2 PAGE2
17	History-dependent*	Decreases Main Zone volume level in 1dB increments.		Decreases Zone2 volume level in 1dB increments.	
18	History-dependent*	Toggles between fully muting Main Zone volume level and restoring Main Zone volume level to its original level.		Centers the AUDIO CONTROLS menu BALANCE and FADER parameters.	
19	History-dependent*	Toggles between muting Main Zone volume level and restoring Main Zone volume level to its original level.		Toggles between fully muting Zone 2 volume level and restoring Zone 2 volume level to its original level.	
20	History-dependent*	Scrolls upward through listening modes.		Adjusts the AUDIO CONTROLS menu Main Zone FADER parameter towards the front.	
21	History-dependent*	Scrolls downward through listening modes.		Adjusts the AUDIO CONTROLS menu Main Zone FADER parameter towards the back.	
22	History-dependent*	If the RV-8's built-in tuner is the currently selected input, press ◀ to skip back to next available preset.			
23	History-dependent*	Activates the Trigger output connector labeled 1.			
24	History-dependent*	If the RV-8's but-in tuner is the currently selected input, press ▶ to skip forward to next available preset.			

* History-dependent buttons perform different functions, depending on the Zone or device that is currently being controlled. Check the bottom of the LCD for the currently controlled device.



BUTTON	ZONE3 PAGE1	ZONE3 PAGE2	DVD1 PAGE1	DVD1 PAGE2
17	Decreases Zone 3 volume level in .1dB increments.		Decreases Main Zone volume level in .1dB increments.	
18	Activates the 5.1 THX, 5.1 THX Ultra2 or the THX SurEX listening mode when a 5.1-channel THX source is present. Activates Dolby PLIIx+THX when a stereo source is present.		Toggles between fully muting the RV-8 Main Zone volume level and restoring Main Zone volume level to its original level.	
19	Toggles between fully muting Zone 3 volume level and restoring Zone 3 volume to its original level.		Toggles between muting the RV-8 Main Zone volume level and restoring Main Zone volume level to its original level.	
20	Increases Subwoofer output in 1dB increments.		Scrolls upward through RV-8 listening modes.	
21	Decreases Subwoofer output in 1dB increments.		Scrolls downward through RV-8 listening modes.	
22	If the RV-8's built-in tuner is the currently selected input, press ◀◀ to skip back to the next available preset.		Skips to the beginning of the current chapter or track. Subsequent presses skip to the beginning of the previous chapter or track.	
23	Activates the output connector labeled Trigger 1.		Activates playback of the loaded disc at regular playback speed.	
24	If the RV-8's built-in tuner is the currently selected input, press ▶▶ to skip forward to the next available preset.		Skips to the beginning of the next chapter or track. Subsequent presses skip to the beginning of the next chapter or track.	



BUTTON	HOME	MAIN PAGE1	MAIN PAGE2	ZONE2 PAGE1	ZONE2 PAGE2
25	History-dependent*	If the RV-8's built-in tuner is the currently selected input, press ◀◀ once to tune to the next available tuner frequency. Pressing for 2 seconds activates seek mode, which searches for the next available radio station. To enter Scan Mode, press and hold until the display shows ◀ SCAN or SCAN ▶ .			
26	History-dependent*				
27	History-dependent*	When a DTS(-ES) source is present, toggles the ES decoding parameter, cycling through the AUTO, ON, and OFF settings.			
28	History-dependent*	Deactivates the output connector labeled Trigger 1.			
29	History-dependent*	Activates the Dolby DIGITAL EX or Dolby DIGITAL listening mode when a 5.1- channel Dolby Digital source is present.			
30	History-dependent*	When a menu is open, scrolls upward through menu items.			
31	History-dependent*	Opens the menu structure and selects the highlighted menu item, which opens another menu, opens a parameter drop-down menu, or selects the highlighted parameter setting.			
32	History-dependent*	When a menu is open, scrolls downward through menu items.			

* History-dependent buttons perform different functions, depending on the Zone or device that is currently being controlled. Check the bottom of the LCD for the currently controlled device.



BUTTON	ZONE3 PAGE1	ZONE3 PAGE2	DVD1 PAGE1	DVD1 PAGE2
25	If the RV-8's built-in tuner is the currently selected input, press ◀◀ once to tune to the next available tuner frequency. Pressing for 2 seconds activates seek mode, which searches for the next available radio station. To enter Scan Mode, press and hold until the display shows ◀ SCAN or SCAN ▶.		When RT-10 or RT-20 playback is activated, scans through the disc in reverse direction.	
26			When RT-10 or RT-20 playback is activated, scans through the disc in forward direction.	
27	When a DTS(-ES) source is present, toggles the ES decoding parameter, cycling through the AUTO, ON and OFF settings.		Opens the RT-10 or RT-20 disc menu.	
28	Deactivates the output connector labeled Trigger 1.		Stops playback of the loaded disc.	
29	Activates the Dolby DIGITAL EX or Dolby DIGITAL listening mode when a 5.1-channel Dolby Digital source is present. Activates Dolby PLIIx Movie when a stereo source is present.		Activates RT-10 or RT-20 pause mode.	
30	When a menu is open, scrolls upward through menu items.			
31	Opens the menu structure and selects the highlighted item. When no menu is open, opens the MAIN MENU.		Navigates to the right in the RT-10 or RT-20 menu structure.	
32	When a menu is open, scrolls downward through menu items.			



BUTTON	HOME	MAIN PAGE1	MAIN PAGE2	ZONE2 PAGE1	ZONE2 PAGE2
33	History-dependent*	When a menu is open, closes the menu and (in most cases), opens the previous menu. Subsequent presses continue to close the current menu and open the previous menu until the MAIN MENU is closed. When no menus are open, shows the two-line status.			
34	History-dependent*	When a menu is open, closes the menu structure. When no menus are open, shows the 2-line status.			
35	History-dependent*	Numbers 0 to 9, are used to enter the frequency of radio stations or to save/load presets when the RV-8's built-in tuner is the currently selected input.			
36	History-dependent*	If the RV-8's built-in tuner is the currently selected input, toggles between AM/FM frequency bands.			
37	History-dependent*	If the RV-8's built-in tuner is the currently selected input, pressing this button will save the currently selected tuner frequency into a preset slot. Also use this button when programming the remote. See page C-4 for additional information.			
38	History-dependent*	Macro Buttons: M1 is for Macro 1, M2 is for Macro 2 and M3 is for Macro 3. See page C-9 for additional information on how to use and program macros.			
39	History-dependent*	Activates the remote control backlight that illuminates the buttons and LCD screen for easier visibility.			

* History-dependent buttons perform different functions, depending on the Zone or device that is currently being controlled. Check the bottom of the LCD for the currently controlled device.



BUTTON	ZONE3 PAGE1	ZONE3 PAGE2	DVD1 PAGE1	DVD1 PAGE2
33	When a menu is open, closes the menu and, in most cases, opens the previous menu. Subsequent presses continue to close the current menu and open the previous menu until the MAIN MENU is closed. When no menus are open, this button performs no function.		Navigates to the left in the RT-10 or RT-20 menu structure.	
34	When a menu is open, closes the menu structure. When no menus are open, shows the two-line status.		Selects the highlighted RT-10 or RT-20 menu item.	
35	Numbers 0 to 9 are used to enter the frequency of radio stations or to save/load presets when the RV-8's built-in tuner is the currently selected input.		Direct RT-10 or RT-20 title, chapter, group or track number selection.	
36	If the RV-8 built-in tuner is the currently selected input, toggles between AM/FM frequency bands.		Enters values 10 and above on the RT-10 or RT-20. Press once for numbers in the teens, twice for numbers in the twenties, and so on. Then press a number button (0 to 9) to enter a second digit.	
37	If the RV-8's built-in tuner is the currently selected input, saves the currently selected tuner frequency as a preset. Also used to program the remote. See page C-4 for additional information.		Deletes entries when RT-10 or RT-20 search modes and certain playback modes are activated.	
38	Macro Buttons: M1 is for Macro 1, M2 is for Macro 2 and M3 is for Macro 3. See page C-9 for additional information on how to use and program macros.			
39	Activates the remote-control backlight to illuminate the buttons and LCD screen for easier visibility.			

UNDERSTANDING THE ZONES

The RV-8 features three zones of operation: the Main Zone, Zone 2 and Zone 3. The Main Zone controls audio and video signals in the primary listening space. Zone 2 controls digital and analog audio and composite or S-Video signals for a second zone or recording device. Zone 3 is designed to control analog audio and composite or S-video signals in an additional listening space. The headphone output follows the source selected in the Main Zone. LOGIC7 Headphone processing is available on this output.

The following are exceptions to independent zone operation:

1. The same Dolby Digital or DTS(-ES) input source can be simultaneously selected for the Main Zone and Zone 2. However, different Dolby Digital or DTS(-ES) input sources cannot be present in the Main Zone and Zone 2.
2. Zone 2 can provide a 2-channel downmix of Main Zone multi-channel audio when all of the following conditions are met:
 - The same input must be selected in the Main Zone and Zone 2.
 - A Dolby Digital, DTS(-ES) or 5.1a input source must be present in the Main Zone.
 - The INPUT SETUP menu ZONE2 IN parameter must be set to DMIX. See "ZONE2 in Parameter Settings" on page 3-22 for more information.
3. The Zone 2 and Zone 3 audio output connectors will receive Front L/R when a 5.1a source is present in the Main Zone and the ZONE2 IN parameter is set to ANLG.
4. When 5.1a BYPASS or 2-CH BYPASS is selected, a downmix to Zone 2 is not available.

TWO-LINE STATUS

The two-line status opens in the on-screen and front-panel displays whenever the RV-8 detects a change in input source or listening mode. The Main Zone two-line status appears when the RV-8 detects a Main Zone change, and the Zone 2 (or Zone 3) two-line status appears when a Zone 2 (or Zone 3) status change is detected.

The ON-SCREEN DISPLAY menu STATUS parameter is used to control the length of time the two-line status appears in the on-screen display. The ON-SCREEN DISPLAY menu POSITION parameter is used to control the vertical alignment of the two-line status in the display device screen.

Note:

When the display device is connected to a component video output connector and the MAIN ADV menu COMPONENT OSD parameter is set to OFF, the on-screen display does not appear on the associated display.

MAIN ZONE TWO-LINE STATUS

Opens in the on-screen and front-panel displays whenever the RV-8 detects a Main Zone status change. The Main Zone two-line status indicates the current input, input source, listening mode and volume level selected in the Main Zone.



ZONE 2 TWO-LINE STATUS

Opens in the on-screen and front-panel displays whenever the RV-8 detects a Zone 2 status change. The Zone 2 two-line status indicates the current input, input source and volume level selected in Zone 2.



ZONE 3 TWO-LINE STATUS

Opens in the on-screen and front-panel displays whenever the RV-8 detects a Zone 3 status change. The Zone 3 two-line status indicates the current input, input source and volume level selected in Zone 3.



TUNER STATUS

The Tuner status indicates the current frequency, band, listening mode and volume level. The Tuner status takes the place of the two-line status display for inputs using the built-in tuner.



STATUS MENUS

Pressing the remote control STAT2 button opens the STATUS menu for the current input source of the Main Zone, which contains parameters that provide information about the current input source and listening mode. STATUS menus are available for 2-channel, Dolby Digital, DTS(-ES) and 5.1 analog input sources. Unlike most other menus, STATUS menus cannot be opened through the selection of menu options. Rather, the remote control STAT2 button must be pressed.

To open and navigate the STATUS menu for the current input source:

- Under Zone 2 page 2, press "STAT2." The first page of the STATUS menu for the current input source appears in the on-screen and front-panel displays.

If the STATUS menu includes a second page, the PG1 indicator appears in the top-right corner of the menu. Press the STAT2

button to open the second page. If the STATUS menu does not include a second page, pressing the STAT2 button closes the menu. If this occurs, begin again with step 1.

- When the desired STATUS menu page has been opened, press the remote-control Menu ▲ and ▼ arrows to scroll upward and downward through the complete list of available parameters.

Note:

STATUS menu parameters provide information about the current input source and listening mode. These parameters cannot be adjusted.

- Press the STAT2 button or the Menu ◀ arrow to close the STATUS menu. If the second page of the STATUS menu opens, press the STAT2 button or the Menu ▶ arrow again to close the STATUS menu.

STATUS menu descriptions begin on the next page. The table beneath each description lists the default and possible settings for each parameter. STATUS menu parameter descriptions begin on page 2-34. STATUS menu level meters are described on page 2-35.

2CH STATUS

Provides information about 2-channel input sources. Features L and R level meters.

Parameter	Possible Settings
INPUT	The current input
MODE	The current listening mode
INPUT TYPE	ANLG, PCM
SAMPLE RATE	44.1kHz, 48kHz, 88.2kHz, 96kHz

See "STATUS Menu Parameter Descriptions" on page 2-34 for detailed information.

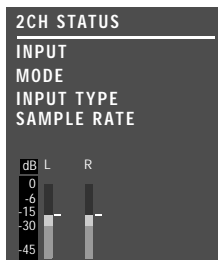

D STATUS

Provides information about Dolby Digital input sources. Features L, C, R, SL, SR and LFE level meters.

Parameter	Possible Settings
INPUT	The current input
MODE	The current listening mode
CHANNELS	3/2.1, 3/2, 3/1, 2/2, 2/1, 2/0, 1/0
BIT RATE	32 to 640kbps
EX ENCODED	MATRIX, NONE
SAMPLE RATE	48kHz
2.0 ENCODING	MATRIX, NONE
DIALOG OFFSET	-27 to +4dB
MIX ROOM	SMALL, LARGE
CENTER MIX LVL	-3.0dB, -4.5dB, -6.0dB
SURR MIX LVL	+0.0dB, -3.0dB, -6.0dB

See "STATUS Menu Parameter Descriptions" on page 2-34 for detailed information.

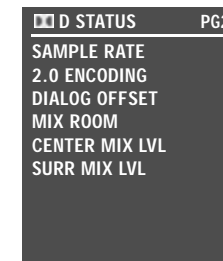
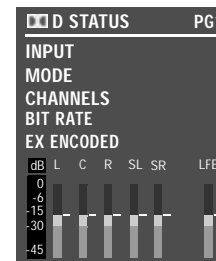

STATUS

Provides information about DTS(-ES) input sources. Includes L, C, R, SL, SR, SB and LFE level meters. The SB level meter appears when a 6.1-channel input source is present, or when a 5.1-channel input source is present and the ES DECODING parameter is set to ON.

Parameter	Possible Settings
INPUT	The current input
MODE	The current listening mode
CHANNELS	3/3.1, 3/2.1
BIT RATE	754.5 to 1509.7 kbps
ES ENCODING	DISCRETE, MATRIX, OFF
WORD LENGTH	16 bits, 20 bits, 24 bits
SAMPLE RATE	44.1kHz, 48kHz, 88.2kHz, 96kHz

See "STATUS Menu Parameter Descriptions" on page 2-34 for detailed information.

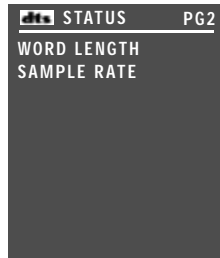
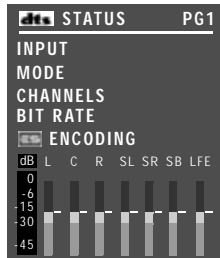

5.1a BYPASS STATUS

Provides information about 5.1-channel analog input sources when the MAIN ADV menu ANALOG BYPASS parameter is set to ON.

Parameter	Possible Settings
INPUT	The current input
MODE	5.1a BYPASS
INPUT TYPE	BYPASS

See "STATUS Menu Parameter Descriptions" on page 2-34 for detailed information.

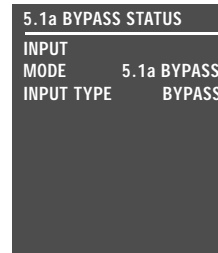

2CH BYPASS STATUS

Provides information about 2-channel analog input sources when the MAIN ADV menu 2-CH ANLG BYP parameter is set to ON.

Parameter	Possible Settings
INPUT	The current input
MODE	2CH BYPASS
INPUT TYPE	BYPASS

See "STATUS Menu Parameter Descriptions" on page 2-34 for detailed information.

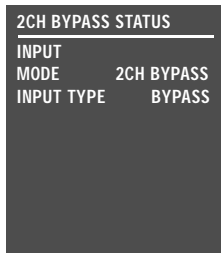

DIGITAL STATUS

Provides information about digital input sources for which a sample rate is detected, but no audio is present in the input signal.

Parameter	Possible Settings
INPUT	The current input
MODE	The current listening mode
INPUT TYPE	---
SAMPLE RATE	44.1kHz, 48kHz, 88.2kHz, 96kHz

See "STATUS Menu Parameter Descriptions" on page 2-34 for detailed information.

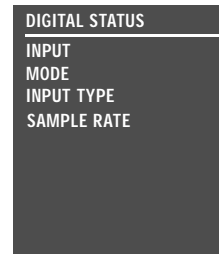

5.1 ANALOG STATUS

Provides information about 5.1-channel analog input sources.

Parameter	Possible Settings
INPUT	The current input
MODE	The current listening mode
INPUT TYPE	ANLG
SAMPLE RATE	96kHz

See "STATUS Menu Parameter Descriptions" on page 2-34 for detailed information.

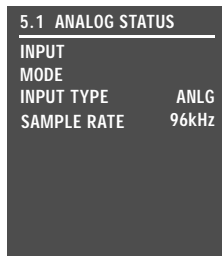

LIVE! STATUS

Provides information about LIVE! input sources. Features L and R level meters.

Parameter	Possible Settings
INPUT	The current input
MODE	The current listening mode
INPUT TYPE	MIC
SAMPLE RATE	48kHz

See "STATUS Menu Parameter Descriptions" on page 2-34 for detailed information.

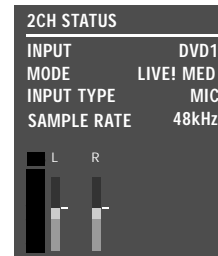

STATUS MENU PARAMETER DESCRIPTIONS

2.0 ENCODING

MATRIX, NONE

Indicates whether or not a matrix-encoded source is detected. When the parameter setting is MATRIX, a matrix-encoded source is detected. When the parameter setting is NONE, a matrix-encoded source is not detected. The RV-8 cannot automatically detect matrix encoding in non-flagged input sources.

BIT RATE

32 to 640 kbps or 754 to 1509.7kbps

Indicates the rate at which the input signal is encoded. A higher bit rate indicates that less compression was used during the encoding process. Possible settings for Dolby Digital sources range from 32 to 640 kbps. Possible settings for DTS(-ES) sources range from 754 to 1509.7 kbps.

CENTER MIX LVL

-3.0dB, -4.5dB, -6.0dB

Indicates the relative level of the center channel that was used during the mixing process.

CHANNELS

3/3.1, 3/2.1, 3/2, 3/1, 2/2, 2/1, 2/0, 1/0

Indicates the number of channels present in the input source. The first digit indicates the number of front channels present. The digit after the slash indicates the number of surround channels present. The digit after the decimal point indicates the presence of LFE (low-frequency effects) information. For instance, if the parameter setting is 3/2.1, an input source with three front channels, two surround channels and LFE information is present. LFE information is sent to the Main Zone audio output connector labeled Sub.

Possible settings for Dolby Digital input sources include 3/2.1, 3/2, 3/1, 2/2, 2/1, 2/0 and 1/0. Possible settings for DTS(-ES) input sources include 3/3.1 and 3/2.1.

DIALOG OFFSET

-27 to +4dB

Indicates the dialog normalization value applied to the input signal. Dolby Digital input sources reproduce dialog at 27 decibels below full-scale (-27dBFS). When the dialog normalization value of the incoming signal is higher or lower, the DIALOG OFFSET parameter indicates the amount of adjustment the RV-8 makes to normalize dialog to -27dBFS.

ES ENCODING

DISCRETE, MATRIX, OFF

Indicates whether or not a DTS-ES-encoded source is detected. When the parameter setting is DISCRETE, a discrete 6.1-channel DTS-ES source is detected. When the parameter setting is MATRIX, a 5.1-channel DTS-ES source with a surround-encoded back channel is detected. When the parameter setting is NONE, a standard DTS source with no DTS-ES encoding is detected.

EX ENCODING

MATRIX, NONE

Indicates whether or not a Dolby Digital Surround EX-encoded source is detected. When the parameter setting is MATRIX, a 5.1-channel Dolby Digital source recorded with Dolby Digital Surround EX is detected. When the parameter setting is NONE, a standard 5.1-channel Dolby Digital source recorded without Dolby Digital Surround EX encoding is detected. The RV-8 cannot automatically detect Dolby Digital Surround EX encoding in non-flagged input sources.

INPUT

Indicates the selected input (e.g., DVD1).

INPUT TYPE ANLG, BYP, PCM, MIC, ---

Indicates the input source that is present. When the parameter setting is ANLG, a 2-channel analog audio source is present and the MAIN ADV menu 2-CH ANLG BYP parameter is set to OFF. When the parameter setting is BYP (Bypass), a 2-channel analog audio source is present and the 2-CH ANLG BYP parameter is set to ON. When the parameter setting is PCM, a 2-channel digital audio source is present. When the parameter is set to MIC, a microphone source is present. When the parameter setting is ---, an unknown digital audio source is present.

MIX ROOM SMALL, LARGE

Indicates the size of the mixing room that was used during the mixing process. When the parameter setting is LARGE, setting the RE-EQUALIZATION parameter to ON for THX listening modes is recommended.

MODE

Indicates the activated listening mode (e.g., L7 FILM).

SAMPLE RATE 44.1kHz, 48kHz, 88.2kHz, 96kHz

Indicates the sample rate of the input source that is present.

SURR MIX LVL +0.0dB, -3.0dB, -6.0dB

Indicates the relative surround channel level that was used during the mixing process.

WORD LENGTH 16 bits, 20 bits, 24 bits

Indicates the word length of the audio data present in the input signal.

STATUS MENU LEVEL METERS

Most STATUS menus contain level meters that indicate fluctuating input levels in the front left (L), center (C), front right (R), surround left (SL), surround right (SR), surround back (SB) and subwoofer (SUB) channels. These level meters indicate input levels for both analog and digital input sources. For instance, the level meters indicate digital audio input levels when a digital audio source is present.

Different combinations of level meters appear on each STATUS menu, depending on the source that is present. The SB level meter appears when a 6.1-channel source is present, or when a 5.1-channel source is present and the ES DECODING parameter is set to ON.

Level meters appear in combinations of green, yellow and red when the on-screen display is configured for a blue-screen background. Green indicates low levels, yellow indicates normal levels, and red indicates high levels and the onset of overload. Level meters appear in white when the on-screen display is not configured for a blue-screen background.

3

Setup

Setup	3-2
Input Setup	3-4
Changing Input Names.....	3-5
Assigning Audio and Video Input Connectors	3-7
Selecting Preferred Listening Modes.....	3-12
Configuring Advanced Input Settings.....	3-17
INPUT SELECT Parameter Settings.....	3-19
ZONE2 in Parameter Settings.....	3-22
Speaker Setup	3-25
Setting Crossover Points.....	3-25
Speaker Setup Parameters.....	3-29
Automatic Calibration	3-36
Manual Calibration	3-53
I/O Config.....	3-60
Display Setup	3-63
On-Screen Display Setup	3-64
Front-panel Display Setup	3-66
Volume Control Setup.....	3-68
Trigger Setup	3-70
Tuner Setup	3-72
Tuner Region Band Limit And Increments	3-73
Lock Options.....	3-79
LIVE! CALIBRATION	3-80

SETUP

Selecting SETUP from the MAIN MENU opens the SETUP menu.

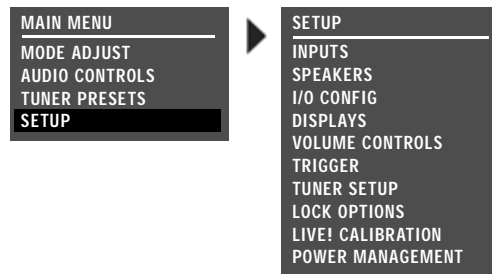

INPUTS

SETUP ► INPUTS

Prompts the selection of a desired input (e.g., DVD1) and opens the corresponding INPUT SETUP menu, which is used to change input names, assign audio and video input connectors, select preferred listening modes and configure Main Zone and Zone 2 input settings. See "INPUT SETUP" on page 3-4 for more information.

SPEAKERS

SETUP ► SPEAKERS

Opens the SPEAKER SETUP menu, which is used to configure the Main Zone audio output connectors for the desired speaker setup, set speaker distances and calibrate output levels. See "SPEAKER SETUP" on page 3-25 for more information.

I/O CONFIG

SETUP ► I/O CONFIG

Opens the I/O CONFIG menu, which is used to configure the analog audio input connectors as eight stereo connectors, one 5.1-channel and five stereo connectors, or two stereo and two 5.1-channel connectors. It can also be used to configure the amplifier outputs. See "I/O CONFIGURATION" 3-60 for more information.

DISPLAYS

SETUP ► DISPLAYS

Opens the DISPLAY SETUP menu, which is used to customize the on-screen and front-panel displays, restore audio/video synchronization, and create and activate a custom unit name. See "DISPLAY SETUP" on page 3-63 for more information.

VOLUME CONTROLS

SETUP ► VOLUME CONTROLS

Opens the VOLUME CONTROL SETUP menu, which is used to configure Main Zone, Mute, Zone 2, Zone 3 and Headphone volume levels. See "VOLUME CONTROL SETUP" on page 3-68 for more information.

TRIGGER

SETUP ► TRIGGER

Opens the TRIGGER SETUP menu, which is used to configure the trigger output connector labeled 1. See "TRIGGER SETUP" on page 3-70 for more information.

TUNER SETUP

SETUP ▶ TUNER SETUP

Opens the TUNER SETUP menu, which is used to configure the AM/FM tuner. See "TUNER SETUP" on page 3-72 for more information.

LOCK OPTIONS

SETUP ▶ LOCK OPTIONS

Opens the LOCK OPTIONS menu, which is used to protect MODE ADJUST, AUDIO CONTROLS and SETUP menu branch settings from accidental changes. For more information, see "Lock Options" on page 3-79.

LIVE! CALIBRATION

SETUP ▶ LIVE! CALIBRATION

Opens the LIVE! CALIBRATION menu, which is used to perform the necessary calibration before using the LIVE! modes. See "LIVE! CALIBRATION" on page 3-80 for more information.

POWER MANAGEMENT

ON, OFF

SETUP ▶ POWER MANAGEMENT

Opens the POWER MANAGEMENT menu, which is used to automatically put the RV-8 into standby mode during brownouts.

When set to ON, the RV-8 detects low voltage levels or a momentary loss of power and puts the device in standby mode. In the event of a power brown out, the RV-8 will display a BROWN OUT!! PRESS STANDBY message. To turn the unit back on, use the front panel STANDBY button.

When set to OFF, the RV-8 will attempt to function during a momentary power loss, however software settings may become corrupt and need to be reset.

When the RV-8 is in standby mode, pressing the button turns the unit on and activates all zones that were active in the previous operating session.

INPUT SETUP

SETUP ► INPUTS ► (INPUT) ► INPUT SETUP

Selecting the SETUP menu INPUTS option prompts the selection of a desired input (e.g., DVD1). Selecting an input opens the corresponding INPUT SETUP menu, which is used to change the input name, assign audio and video input connectors, select preferred listening modes and configure advanced Main Zone and Zone 2 input settings.

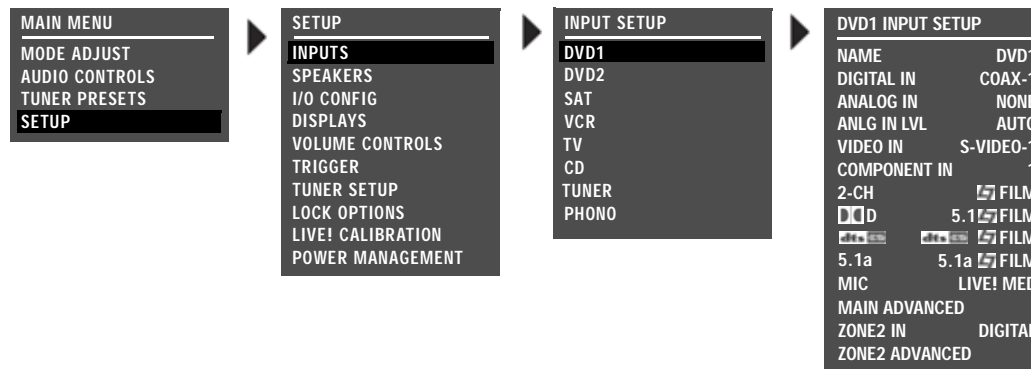

The DVD1 INPUT SETUP menu is shown here as an example, and will continue to be shown as an example throughout this section. Whenever it appears, any other INPUT SETUP menu can be substituted. Likewise, whenever the DVD1 input appears as a step in a menu path, any other input can be substituted.

All INPUT SETUP menus are shown in the Appendix on page A-6. The parameters on the left side of the INPUT SETUP menus are identical, regardless of which input is selected. The parameter settings on the right side are adjustable. Default parameter settings differ from input to input. The INPUT SETUP menus shown in the Appendix indicate factory-default parameter settings for each input.

CHANGING INPUT NAMES

Selecting the INPUT SETUP menu NAME parameter opens the INPUT NAME menu, which is used to customize or restore the factory-default name of the selected input. Factory-default input names correspond to front-panel and remote-control input selection button labels.

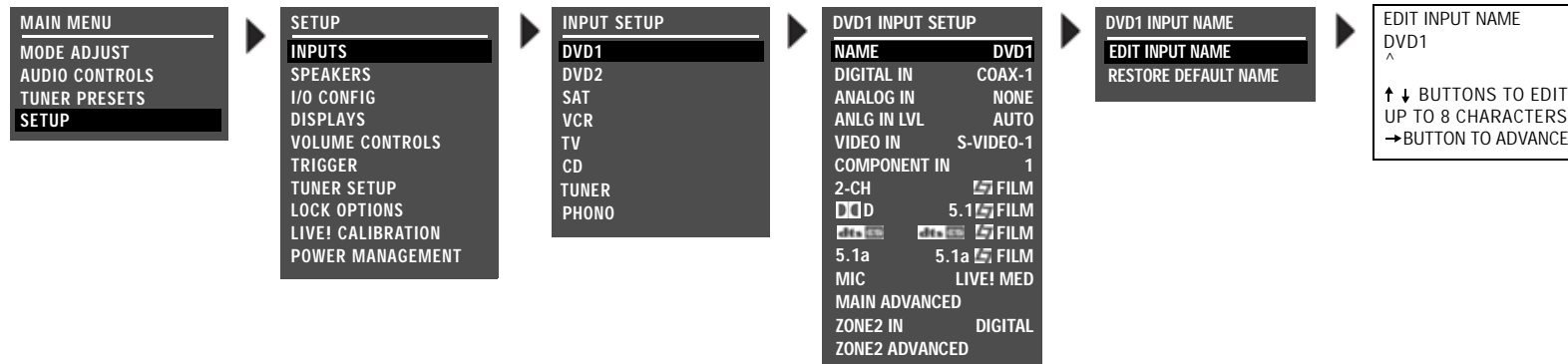

EDIT INPUT NAME



Opens the EDIT INPUT NAME drop-down menu, which is used to customize the name of the selected input. Custom input names can include up to eight characters.

To customize the name of the selected input:

1. Follow the EDIT INPUT NAME menu path to open the EDIT INPUT NAME drop-down menu.
2. When the EDIT INPUT NAME menu opens, the current input name appears on the second line. Using the remote-control ▲ and ▼ arrow buttons, change the character above the cursor (^).
3. When the desired character has been changed, press the ► arrow button to advance to the next character space. The cursor will

automatically wrap to the first character space when the last character space is passed.

4. Repeat steps 2 and 3 to enter all characters in the new name.
5. When the desired input name has been entered, press the ◀ arrow button to close the menu and return to the INPUT NAME menu.

The custom input name appears in the on-screen and front-panel displays. Both the custom and factory-default input names appear in the INPUT SETUP menu. The custom input name appears against the left margin of the on-screen display, and the factory-default input name appears in parentheses against the right margin.

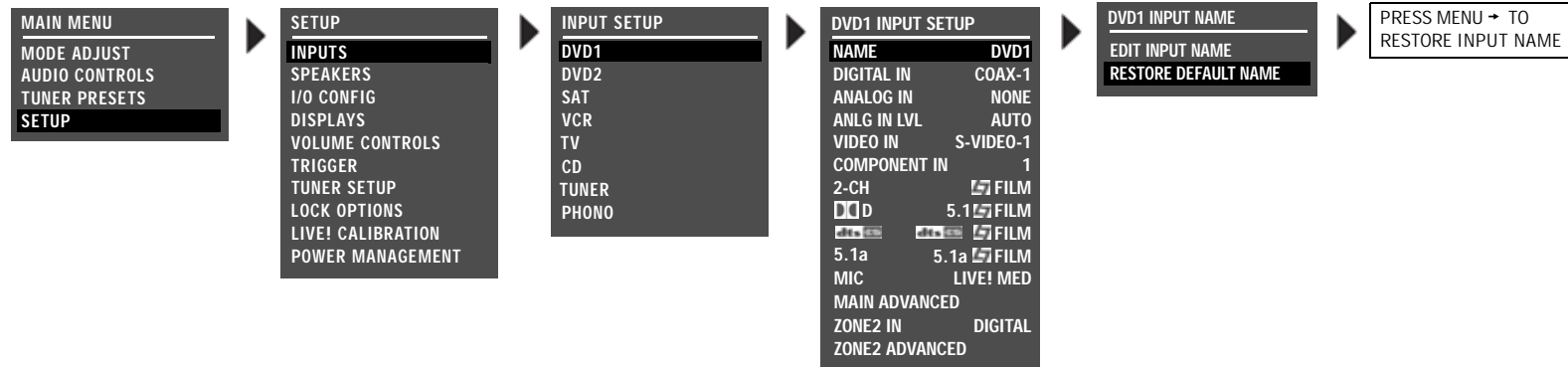

RESTORE DEFAULT NAME

SETUP ► INPUTS ► DVD1 ► NAME ► RESTORE DEFAULT NAME

Restores the factory-default name of the selected input. Factory-default input names correspond to front-panel and remote-control input selection button labels.

To restore the factory-default name of the selected input:

1. Follow the RESTORE DEFAULT NAME menu path to open the INPUT NAME menu.
2. When the INPUT NAME menu opens, press the remote control ▲ and ▼ arrow buttons to highlight the RESTORE DEFAULT NAME option.
3. When the RESTORE DEFAULT NAME option is highlighted, press the ► arrow button to select this option. The message "PRESS MENU → TO RESTORE INPUT NAME" appears in the on-screen and front-panel displays.
4. When this message appears, press the ► arrow button to restore the factory-default name of the selected input and close the message. (Press the ◀ arrow button to close the message without restoring the factory-default name of the selected input.)

ASSIGNING AUDIO and VIDEO INPUT CONNECTORS

The RV-8 has eight configurable inputs, each of which can be assigned to its eight digital audio, eight analog audio, the built-in tuner, the phono input, five composite video, five S-Video or three component video input connectors.

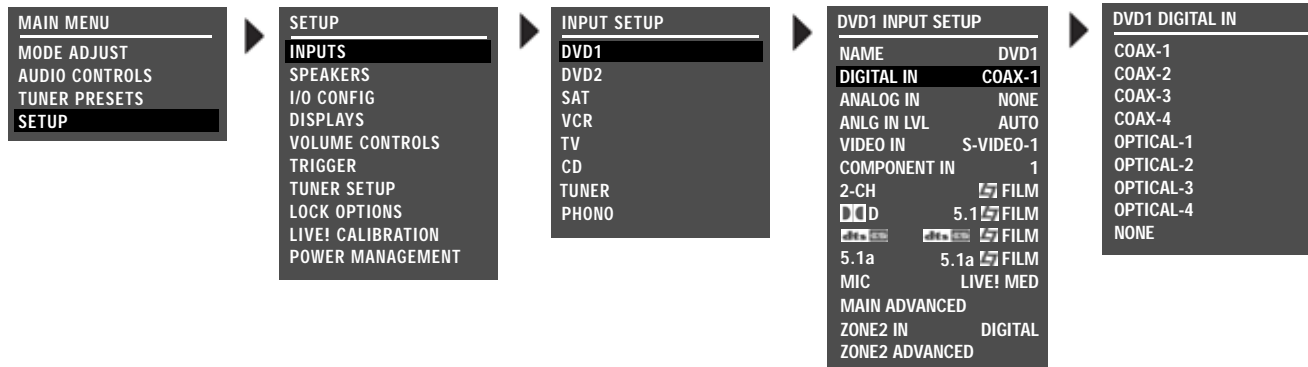

The table below indicates the INPUT SETUP menu parameters that can be used to assign audio and video input connectors. The ANLG IN LVL parameter can be used to adjust 2-channel analog audio input levels for the selected input.

Parameter	Possible Settings
DIGITAL IN	COAX-1 to 4, OPTICAL-1 to 4, NONE
ANALOG IN	ANALOG-1 to 8, 5.1 ANLG (3-5) or (6-8), PHONO, TUNER, NONE, LIVE!
ANLG IN LVL	AUTO, -18dB to +12dB
VIDEO IN	COMPOSITE-1 to 5, S-VIDEO-1 to 5, NONE
COMPONENT IN	COMPONENT-1 to 3, VIDEO, NONE

Note:

The digital audio input connectors are compatible with PCM (44.1, 48, 88.2 and 96kHz), Dolby Digital and DTS (-ES) sources. The digital audio input connectors are not compatible with MPEG or MP3 sources.

DIGITAL IN COAX-1 TO 4, OPTICAL-1 TO 4, NONE



Opens the DIGITAL IN menu, which is used to assign a digital audio input connector for the selected input. The RV-8 has eight configurable inputs, each of which can be assigned to any of its eight digital audio input connectors.

Please note the following:

- When no digital audio input connector is assigned, the RV-8 will automatically set the MAIN ADV menu INPUT SELECT parameter to ANALOG (see page 3-17).
- A digital audio input connector must be assigned when no analog audio input connector is assigned. Refer to the next page for information about assigning an analog audio input connector.

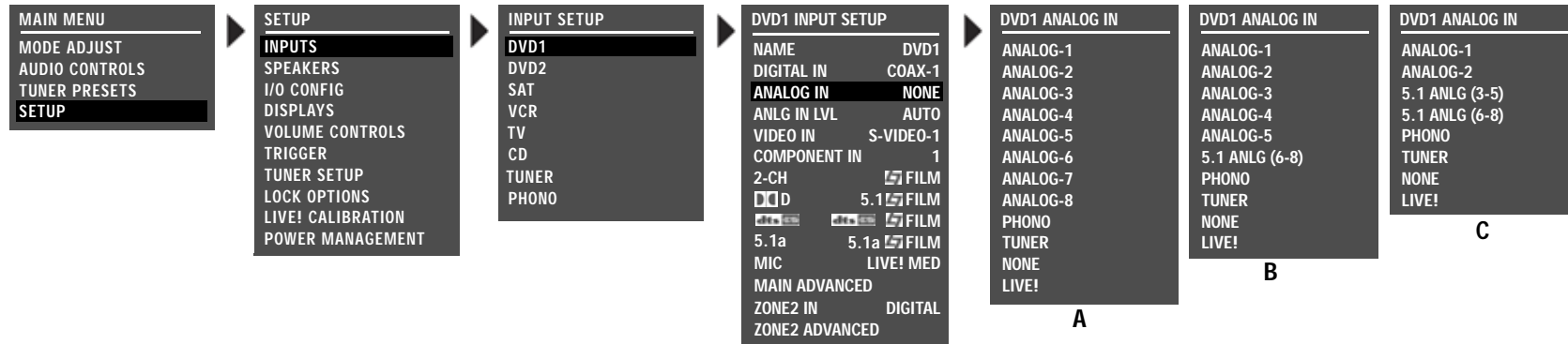
ASSIGNING AUDIO and VIDEO INPUT CONNECTORS (continued)**ANALOG IN**

SETUP ► INPUTS ► DVD1 ► ANALOG IN

Opens the ANALOG IN menu, which is used to assign an analog audio input connector for the selected input. The RV-8 has eight configurable inputs, each of which can be assigned to any of its eight analog audio input connectors.

The appearance of the ANALOG IN menu depends on the configuration of the analog audio input connectors.

- The ANALOG IN menu (A above) appears when the I/O CONFIG menu 8 STEREO INPUTS option is selected (see page 3-60).
- The ANALOG IN menu (B above) appears when the I/O CONFIG menu 5 ST. & 5.1 ANLG option is selected (see page 3-61).
- The ANALOG IN menu (C above) appears when the I/O CONFIG menu 2 ST. & (2) 5.1 ANLG option is selected (see page 3-61).

ANALOG-1 to 8, 5.1 ANLG (3-5) or (6-8), PHONO, TUNER, NONE, LIVE!

Please note the following:

- When no analog audio input connector is assigned, the RV-8 automatically sets the MAIN ADV menu INPUT SELECT parameter to DIGITAL (see page 3-17).
- An analog audio input connector must be assigned when no digital audio input connector is assigned. Refer to the previous page for information about assigning a digital audio input connector.
- The PHONO input corresponds to the built-in phono connector.
- The TUNER input corresponds with the internal AM/FM radio tuner.
- LIVE! cannot be selected until LIVE! CALIBRATION is run. When the ANALOG IN selection is LIVE!, the digital input selection is disabled for this input until a different analog input is selected.

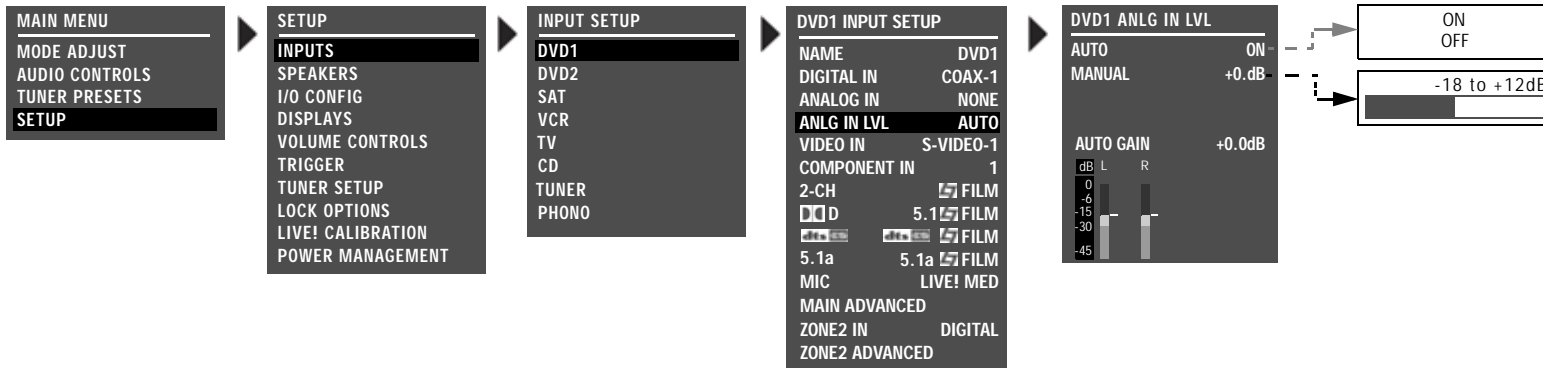

ANLG IN LVL

AUTO, -18dB to +12dB

SETUP ▶ INPUTS ▶ DVD1 ▶ ANLG IN LVL

Opens the ANLG IN LVL menu, which is used to adjust the 2-channel analog audio input levels for the selected input. Despite attempts at standardization, analog audio sources have a wide range of levels. To compensate for this, the RV-8 allows independent input level adjustment for each of its stereo and multichannel analog audio input connectors, phono input and the internal tuner. Input level adjustment is not available when analog bypass is on.

Note:

Adjustments made in the ANLG IN LVL menu are applied to the analog audio input connector assigned for the selected input, these adjustments are automatically applied to the new connector.

Parameter	Possible Settings
AUTO	ON, OFF
MANUAL	-18 to +12dB
AUTO GAIN*	-18 to +12dB

* This parameter cannot be adjusted.

ASSIGNING AUDIO and VIDEO INPUT CONNECTORS (continued)**AUTO**

ON, OFF

SETUP ▶ INPUTS ▶ DVD1 ▶ ANLG IN LVL ▶ **AUTO**

Provides automatic adjustment of analog audio input levels. When set to ON, the RV-8 automatically monitors and optimizes input levels. When the input signal is too high, the RV-8 quickly decreases input levels to avoid overload. When the input signal is too low, the RV-8 slowly increases input levels to maximize signal-to-noise ratio and dynamic range.

When OFF is selected, the RV-8 does not automatically monitor and optimize analog audio input levels. Rather, input levels must be adjusted with the MANUAL parameter (see below).

MANUAL

-18dB to +12dB

SETUP ▶ INPUTS ▶ DVD1 ▶ ANLG IN LVL ▶ **MANUAL**

Provides manual adjustment of analog audio input levels. When manual adjustments are made, the RV-8 automatically sets the ANLG IN LVL menu AUTO parameter to OFF, deactivating automatic input level adjustment. Manual input level adjustments are retained when the AUTO parameter is ON.

Note:

When the AUTO parameter is ON, the RV-8 will not make adjustments that exceed the ANLG IN LVL menu MANUAL parameter setting.

AUTO GAIN

SETUP ▶ INPUTS ▶ DVD1 ▶ ANLG IN LVL ▶ **AUTO GAIN**

Indicates the current amount of input level adjustment for the selected analog audio input connector. When the ANLG IN LVL menu AUTO parameter is ON, the AUTO GAIN parameter indicates the amount of automatic input level adjustment. When the AUTO parameter is OFF, the AUTO GAIN parameter indicates the amount of manual input level adjustment. (In other words, the AUTO GAIN parameter reflects the setting of the ANLG IN LVL menu MANUAL parameter.)

When the AUTO parameter is ON, the AUTO GAIN parameter continues to indicate the amount of manual input level adjustment until automatic adjustments have been made.

LEVEL METERS

SETUP ▶ INPUTS ▶ DVD1 ▶ **ANLG IN LVL**

Indicate fluctuating input levels for the selected input. Like the STATUS menu level meters, ANLG IN LVL menu level meters indicate input levels for both analog and digital audio sources. However, ANLG IN LVL menu input level adjustments affect only analog audio sources.

Level meters appear in combinations of green, yellow and red when the on-screen display is configured for a blue-screen background. Green indicates low levels; yellow indicates normal levels; and red indicates the onset of overload. Level meters appear in white when the on-screen display is not configured for a blue-screen background.

VIDEO IN COMPOSITE-1 TO 5, S-VIDEO-1 TO 5, NONE

SETUP ▶ INPUTS ▶ DVD1 ▶ VIDEO IN

Opens the VIDEO IN menu, which is used to assign a composite or S-Video input connector for the selected input. The RV-8 has eight configurable inputs, each of which can be assigned to any of its five composite or five S-Video input connectors.

Note:

Composite video output connectors are available when a composite or S-Video source is present.

S-Video output connectors are available when an S-Video source is present.

COMPONENT IN COMPONENT-1 to 3, VIDEO, NONE

SETUP ▶ INPUTS ▶ DVD1 ▶ COMPONENT IN

Opens the COMPONENT IN menu, which is used to assign a component video input connector for the selected input. The RV-8 has eight configurable inputs, each of which can be assigned to any of its three component video input connectors.

Alternatively, COMPONENT IN can be assigned to VIDEO. This will cause the composite or S-Video signal selected for the VIDEO IN parameter to be converted to component input. The NONE setting shuts off the component output.

Note:

When the component is set to NONE, black and blue lines appear on the screen if the monitor does not have auto-sense.

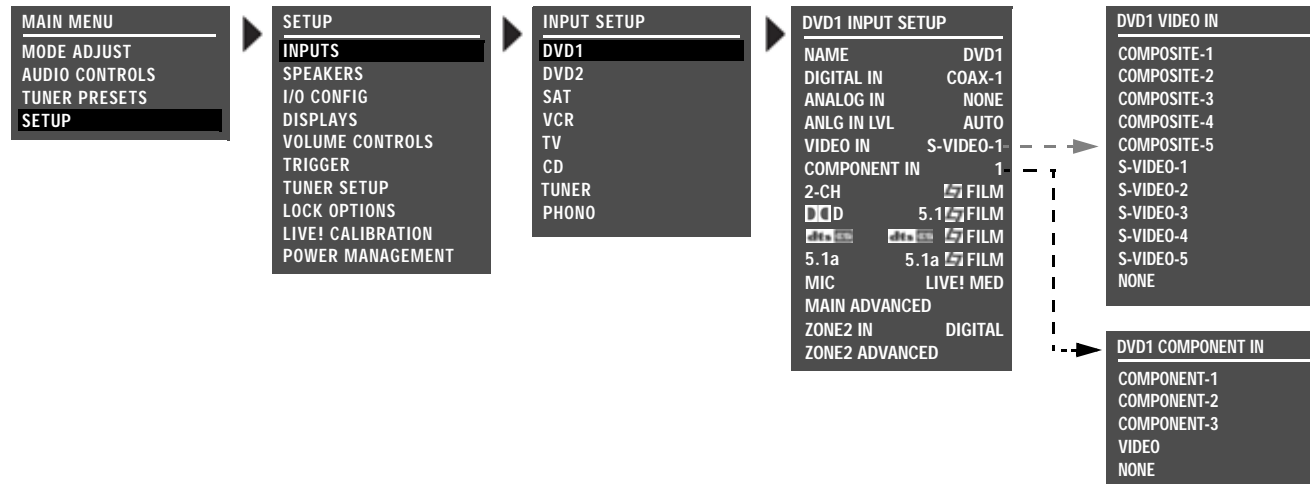



SELECTING PREFERRED LISTENING MODES

Preferred listening modes can be pre-selected so that when a particular type of input source is played, the pre-selected listening mode is activated.

The RV-8 allows five preferred listening modes for each Main Zone input: one listening mode each for 2-channel, Dolby Digital, DTS(-ES), 5.1a and MIC (LIVE!) sources. The table to the right indicates the INPUT SETUP menu parameters that can be used to select preferred listening modes.

Preferred Listening Mode Selection Parameters

2-CH	Selects a preferred listening mode for 2-channel sources
 D	Selects a preferred listening mode for Dolby Digital sources
 ES	Selects a preferred listening mode for DTS(-ES) sources
5.1a	Selects a preferred listening mode for 5.1 analog sources
MIC	Selects a preferred listening mode for microphone sources (LIVE!)

Menus showing DVD1 parameters selected as preferred listening modes.

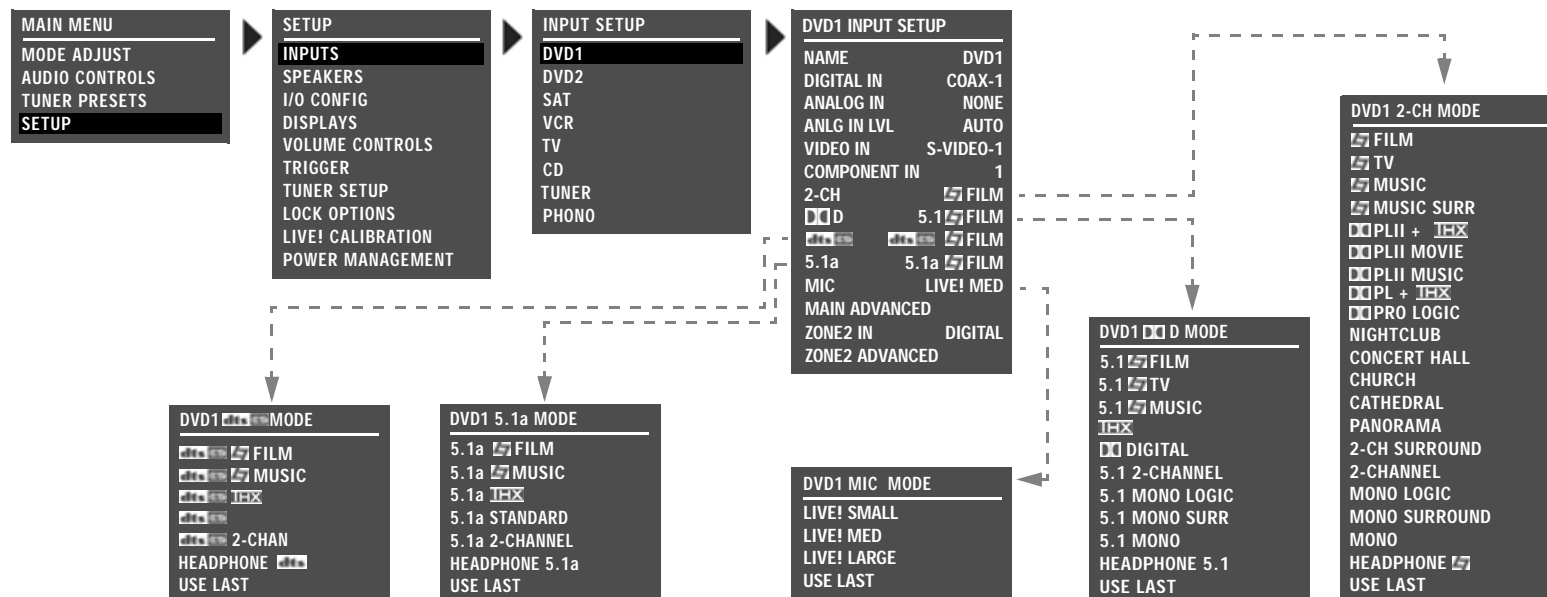

When a preferred listening mode is selected, that listening mode is automatically activated whenever a new input is selected or an appropriate input source is present. For example, the following can occur when a preferred listening mode is activated (also refer to the corresponding menus on 3-12):

If the DVD1 input is selected and a 2-channel source is played, the L7 FILM listening mode is activated. If a Dolby Digital source is played, the 5.1 L7 FILM listening mode is activated. If a DTS(-ES) source is played, the DTS(-ES) L7 FILM listening mode is activated.

Dynamic Listening Modes

Dynamic listening modes are only available under certain conditions. For example, many of the dynamic modes are only available when the RV-8 is configured for seven main output channels and source material with specific encoding is played. All Dynamic Listening Modes are available through the remote control or front panel Mode button. The dynamic listening modes are listed in the table below.

Dynamic modes		
2-Channel	Dolby Digital	DTS
Dolby PLIIx + THX	Dolby Digital or Dolby Digital EX	DTS THX or DTS THX UL2Cin or DTS ES THX
Dolby PLIIx MOV	THX or THX UL2Cin or THX SurEX	DTS or DTS ES MATRIX or DTS ES DISCR
Dolby PLIIx MUS	THX MUSIC	DTS THX MUSIC
DTS NEO:6 + THX	5.1 PLIIx MOV	DTS L7 FILM or DTS ES L7 FILM
DTS NEO:6 CIN	5.1 PLIIx MUS	DTS L7 MUSIC or DTS ES L7 MUSIC
DTS NEO:6 MUSIC		DTS 2-CHAN or DTS ES 2-CHAN

Modes that Do Not Appear in the Input Setup Menu

The RV-8 features the ability to assign preferred listening modes for each input and incoming audio format. However, not all listening modes will appear in the Input Setup Menu. Listening modes that do

not appear in the Input Setup menu as preferred listening modes under any circumstances are listed in the table below.

Modes that do not appear in the Input Setup menu		
2-Channel	Dolby Digital	DTS
Dolby PLIIx + THX	THX MUSIC	DTS THX MUSIC
Dolby PLIIx MOV	5.1 PLIIx MOV	5.1 MONO LOGIC
Dolby PLIIx MUS	5.1 PLIIx MUS	5.1 MONO SURR
DTS NEO:6 + THX		5.1 MONO
DTS NEO:6 CIN		
DTS NEO:6 MUSIC		

SELECTING PREFERRED LISTENING MODES *(continued)***The Use Last Parameter**

When the RV-8 is set to use a preferred listening mode for a selected input, selecting another mode from the Mode scroll list replaces the preferred selection. However, this newly selected mode will be lost when switching between inputs.

The USE LAST parameter was designed to allow the RV-8 software to “remember” the last used listening mode for a given input source. Once selected, that mode will always be active on the corresponding input until another listening mode is selected as demonstrated in the following example:

1. Select Main Menu ▶ SETUP ▶ INPUTS ▶ DVD1 ▶  ▶ USE LAST.
2. Press the MENU button.
3. Press the DVD-1 button.
4. Play a DTS input source.
5. Press the MODE + button until you reach DTS(-ES) 2-CHAN.
6. Press the TV button

The RV-8 switches to the TV input and the on-screen display identifies the preferred listening mode.

7. Press the DVD-1 button.

The on-screen display should identify that the active listening mode for the DVD1 input is still DTS(-ES) 2-CHAN. As the DTS(-ES) 2-CHAN mode is a preferred listening mode, it can also be set in the SETUP menu.

When seven speakers are selected in the SPEAKER SETUP menu, and the appropriate source material is played, the dynamic listening mode (or mode that does not appear in the input setup menu) can always be accessed using the MODE + or MODE - buttons whether or not a preferred mode is set. When a preferred listening mode is set

and a dynamic listening mode (or mode that does not appear in the input setup menu) is active, the selected dynamic mode is lost when switching between inputs.

When USE LAST is selected as the preferred listening mode, and a dynamic listening mode (or mode that does not appear in the input setup menu) is active, the selected listening mode is retained when switching between inputs, even when the RV-8 is set to standby as in the following example:

1. Select Main Menu ▶ SETUP ▶ INPUTS ▶ DVD1 ▶ 2-CH ▶ USE LAST.
2. Press the MENU button.
3. Press the DVD-1 button.
4. Play a 2-channel input source.
5. Press the MODE + button until you reach  PLIIx MOV.
6. Press the TV button

 PLIIx MOV is a dynamic listening mode.

The RV-8 switches to the TV input and the on-screen display identifies the preferred listening mode.

7. Press the DVD-1 button.

The on-screen display should identify that the active listening mode for the DVD1 input is still  PLIIx MOV. This is the only method of setting up a dynamic mode (or mode that does not appear in the input setup menu) to behave like a preferred listening mode.

Note:

When a dynamic mode (or mode that does not appear in the input setup menu) is set as in the above example, the setting is retained even when the RV-8 is set to standby.

2-CH

SETUP ► INPUTS ► DVD1 ► 2-CH

Opens the 2-CH MODE menu, which is used to select a preferred listening mode for 2-channel input sources. The RV-8 activates the selected listening mode whenever a 2-channel source is present.

When the 2-CH parameter is set to USE LAST:

The RV-8 activates the listening mode that was activated the last time a 2-channel source was present

The remote control 2 CH button toggles between the 2-CHANNEL listening mode and the previous listening mode, and ignores the USE LAST setting. Instead, it uses the listening mode (for example, L7 FILM) that was activated before the 2-CHANNEL listening mode.

The RV-8 activates a DTS NEO:6 listening mode if a DTS NEO:6 listening mode was activated the last time a 2-channel source was present, and a 44.1kHz or 48kHz PCM digital source is present. Since the DTS NEO:6 listening modes are dynamic, they cannot be selected as the preferred listening mode for 2-channel sources.

DOLBY D

SETUP ► INPUTS ► DVD1 ► DOLBY D

Opens the DOLBY DIGITAL MODE menu, which is used to select a preferred listening mode for Dolby Digital input sources. The RV-8 activates the selected listening mode whenever a new input is selected or a new Dolby Digital source is present.

When the DOLBY D parameter is set to USE LAST:

The RV-8 activates the listening mode that was activated the last time a Dolby Digital source was present

The RV-8 activates the Dolby PLIIx MOV (Movie) listening mode if this listening mode was activated the last time a Dolby Digital source was present. Since Dolby PLIIx MOV is a dynamic listening mode, it cannot be selected as the preferred listening mode for Dolby Digital sources.

SELECTING PREFERRED LISTENING MODES *(continued)*

Opens the DTS(-ES) MODE menu, which is used to select a preferred listening mode for DTS(-ES) input sources. The RV-8 automatically activates the selected listening mode whenever a new input is selected or a new DTS(-ES) source is present.

When the DTS-ES parameter is set to USE LAST:

- The RV-8 activates the listening mode that was activated the last time a DTS(-ES) source was present
- The RV-8 activates the DTS THX MUSIC listening mode if it was activated the last time a DTS(-ES) source was present. Since DTS THX MUSIC is a dynamic listening mode, it cannot be selected as the preferred listening mode for DTS(-ES) sources.

MIC

Opens the MIC MODE menu, which is used to select a preferred listening mode for the LIVE! source. The RV-8 automatically activates the preferred listening mode when a LIVE! input is selected.

When the MIC parameter is set to USE LAST:

The RV-8 activates the listening mode (LIVE! SMALL, LIVE! MED or LIVE! LARGE) that was activated the last time a MIC source was present.

5.1a

Opens the 5.1a MODE menu, which is used to select a preferred listening mode for 5.1-channel analog sources. The RV-8 automatically activates the preferred listening mode whenever a 5.1-channel analog source is present.

When the 5.1a parameter is set to USE LAST:

The RV-8 activates the 5.1-channel analog listening mode that was activated the last time a 5.1-channel analog source was present. 5.1a MUSIC cannot be selected as the preferred listening mode for 5.1-channel analog sources. However, when the 5.1a parameter is set to USE LAST, the RV-8 will activate 5.1a MUSIC if this listening mode was activated the last time a 5.1-channel analog source was present.

CONFIGURING ADVANCED INPUT SETTINGS

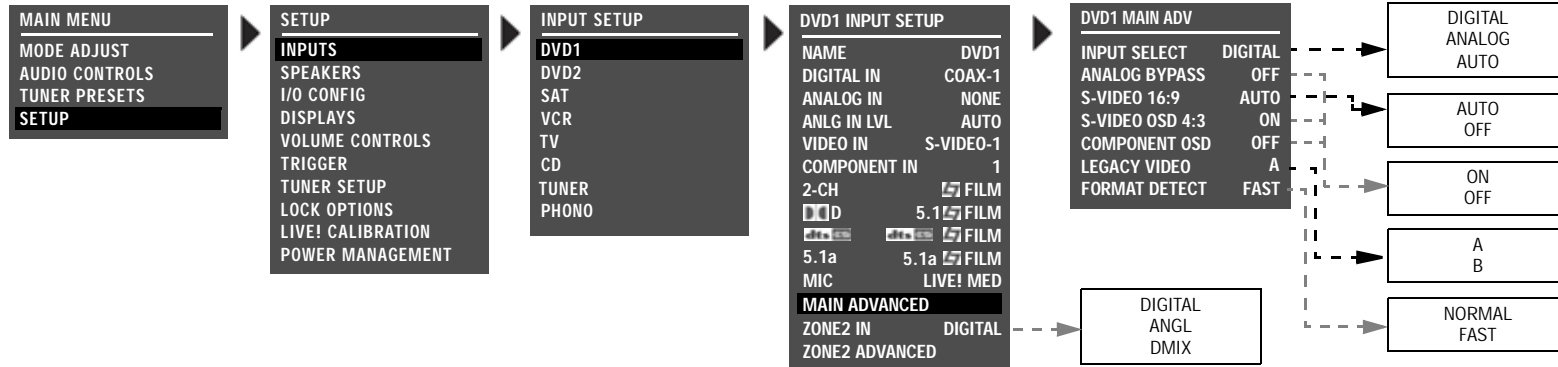

MAIN ADVANCED



Selecting the INPUT SETUP menu MAIN ADVANCED option opens the MAIN ADV menu shown above. The parameters on the left side of this menu are identical, regardless of which input is selected. The settings on the right side are adjustable. Default parameter settings differ from input to input.

Parameter	Possible Settings
INPUT SELECT	DIGITAL, ANALOG, AUTO
ANLOG BYPASS	ON, OFF
S-VIDEO 16:9	AUTO, OFF
S-VIDEO OSD 4:3	ON, OFF
COMPONENT OSD	ON, OFF
LEGACY VIDEO	A, B
FORMAT DETECT	NORMAL, FAST

INPUT SELECT

DIGITAL, ANALOG, AUTO



Controls the interaction of the digital and analog audio input connectors assigned to the current Main Zone input. The INPUT SETUP menu is used to assign one digital and one analog audio input connector for the selected input. The table on page 3-19 describes INPUT SELECT parameter settings.

Note:

When the INPUT SELECT parameter is set to AUTO, the RV-8 will not select the assigned analog audio input connector when a valid digital audio input source is present. Some DVD and CD players output digital signals (data) when the player is paused or stopped or when the player is powered on and the disc drawer is empty. When this occurs, the RV-8 automatically selects the assigned digital audio input connector.

CONFIGURING ADVANCE INPUT SETTINGS *(continued)***ANALOG BYPASS**

ON, OFF

SETUP ▶ INPUTS ▶ DVD1 ▶ MAIN ADVANCED ▶ ANALOG BYPASS

When set to ON, the RV-8 passes the analog input signal to the Main Zone audio output connectors. For stereo analog sources, the input is sent to the FRONT L/R outputs. For a 5.1-channel analog source, the (L) input is sent to the FRONT L output. The (R) input is sent to the FRONT R output. The (C) input is sent to the center output. The (SUB) input is sent to the SUB output. The (LS) input is sent to the SIDE L and REAR L outputs. The (RS) input is sent to the SIDE R and REAR R outputs. When ANALOG BYPASS is set to OFF, the unit routes the analog input signal through A/D conversion. This makes it possible to utilize internal processing, including listening modes, crossovers and equalization. Neither Zone 2 nor Zone 3 provide multichannel outputs. If the 5.1-channel analog input is selected for Zone 2 or Zone 3, only the front left and right (L)/(R) inputs will be available.

When LIVE! is the selected analog input, the MAIN ADVANCED ▶ INPUT SELECT parameter is forced to ANALOG, and ANALOG BYPASS is disabled.

Note:

If the Main Zone source is 5.1 analog, only the Front L/R channels will be sent to the Zone 2 S/PDIF outputs.

S-VIDEO 16:9

AUTO, OFF

SETUP ▶ INPUTS ▶ DVD1 ▶ MAIN ADVANCED ▶ S-VIDEO 16:9

Controls the passage of anamorphic trigger signals present in some video sources. When set to AUTO, the RV-8 allows anamorphic video input signals to pass through the S-Video switcher, enabling compatible display devices to automatically switch between anamorphic and non-anamorphic display modes.

When OFF, the RV-8 prevents anamorphic video input signals from passing through the S-Video switcher, preventing compatible display devices from automatically switching between anamorphic and non-anamorphic display modes.

INPUT SELECT PARAMETER SETTINGS		
DIGITAL	ANALOG	AUTO
<p>The RV-8 sends the assigned digital audio input connector to the Main Zone audio output connectors. The RV-8 ignores the assigned analog audio input connector.</p> <p>Note the following:</p> <ul style="list-style-type: none"> The digital audio input connectors are compatible with PCM (44.1, 48, 88.2 and 96kHz), Dolby Digital and DTS(-ES) sources. The digital audio input connectors are not compatible with MPEG or MP3 sources. If an incompatible digital audio source (e.g., MPEG or MP3) is present, the RV-8 automatically selects the assigned analog audio input connector. The RV-8 automatically sets the INPUT SELECT parameter to DIGITAL when the ANALOG IN parameter is set to NONE. If ANALOG IN is set to NONE, the RV-8 will mute. The DIGITAL IN parameter can be used to assign a digital audio input connector for the selected input. 	<p>The RV-8 sends the assigned analog audio input connector to the Main Zone audio output connectors. The RV-8 ignores the digital audio input connector.</p> <p>Note the following:</p> <ul style="list-style-type: none"> The RV-8 automatically sets the INPUT SELECT parameter to ANALOG when the DIGITAL IN parameter is set to NONE. The ANALOG IN parameter can be used to assign an analog audio input connector for the selected input. 	<p>The RV-8 toggles between sending the assigned digital and analog audio input connectors to the Main Zone audio output connectors, based on the input source that is present.</p> <p>For example:</p> <ul style="list-style-type: none"> When a 2-channel PCM, Dolby Digital or DTS(-ES) source is present, the RV-8 automatically selects the assigned digital audio input connector. When an SACD™ source is present, the RV-8 automatically selects the assigned analog audio input connector. <p>Note the following:</p> <ul style="list-style-type: none"> The RV-8 automatically sets the INPUT SELECT parameter to AUTO when both digital and analog audio input connectors are assigned. When no compatible digital source is present, the RV-8 automatically selects the assigned analog audio input connector. The AUTO setting is recommended for components that generate both digital and analog input signals, such as DVD/SACD players.

CONFIGURING ADVANCE INPUT SETTINGS *(continued)***S-VIDEO OSD 4:3**

ON, OFF

SETUP ▶ INPUTS ▶ DVD1 ▶ MAIN ADVANCED ▶ S-VIDEO OSD 4-3

Controls the appearance of the on-screen display when the display device is connected to an S-Video output connector. When set to ON, the display device shows the on-screen display in a 4:3 aspect ratio, regardless of the incoming signal.

Aspect ratio refers to the ratio between the height and width of the picture on the display device or to the ratio between the height and width of the display device. A 4:3 aspect ratio is almost square. A 16:9 aspect ratio, often referred to as "widescreen," is almost twice as wide as it is high.

When OFF, the display device shows the on-screen display in the same aspect ratio as the incoming video input signal.

Note:

The on-screen display appears horizontally stretched across the display device screen when all of the following conditions are present:

- *The S-VIDEO OSD 4:3 parameter is OFF.*
- *An anamorphic video input signal is present.*
- *A 16:9 display device (widescreen) is connected to an S-Video output connector.*

COMPONENT OSD

ON, OFF

SETUP ▶ INPUTS ▶ DVD1 ▶ MAIN ADVANCED ▶ COMPONENT OSD

Controls the appearance of the on-screen display when the display device is connected to the component video output connector. When ON, the display device shows the on-screen display as a 480i video signal on a full blue-screen background. To minimize viewing distractions, the two-line status does not appear in the on-screen display. When OFF, the display device does not show the on-screen display, including the two-line status.

Note:

When the ON-SCREEN DISPLAY menu BACKGROUND parameter is OFF, the display device using the component video output connector will not show the on-screen display.

LEGACY VIDEO

A, B

SETUP ▶ INPUTS ▶ DVD1 ▶ MAIN ADVANCED ▶ LEGACY VIDEO

When video played back from a VCR is converted to component video by the RV-8, the resulting picture quality depends on both the quality of the VCR playback and the capabilities of the component display device. The LEGACY VIDEO menu item has two selections, A and B. Use the one that gives the best picture for the Combination of the VCR and display device.

Note:

Some combinations of VCR and display device may not produce a satisfactory picture with either setting. In such cases, better results may be achieved by connecting to the display device via composite or S-video.

FORMAT DETECT

NORMAL, FAST

SETUP ▶ INPUTS ▶ DVD1 ▶ MAIN ADVANCED ▶ FORMAT DETECT

Controls how the RV-8 reacts when it detects silence in the digital audio stream. Digital sources typically output a short period of silence when switching between sources.

When set to NORMAL, the RV-8 will not mute when silence is detected. This setting is appropriate for most sources.

When set to FAST, the RV-8 will mute when approximately 2ms of continuous digital silence is detected. Once valid audio is received, the RV-8 will configure its processing and deactivate mute. This prevents digital noise from occurring during digital audio signal changes. For example, when switching from Dolby Digital to DTS. Use this setting if audible noise occurs during input digital format changes.

ZONE2 IN

DIGITAL, ANLG, DMIX

SETUP ▶ INPUTS ▶ DVD1 ▶ ZONE2 IN

Controls the interaction of the digital and analog audio input connectors assigned to the current Zone 2 inputs. The INPUT SETUP menu can be used to assign one digital and one analog input connector for the selected input. See page 3-7 for more information. The table on the next page describes ZONE2 IN parameter settings.

Note

When using DTS-encoded discs, set the ZONE2 IN parameter to DMIX.

When the ZONE2 IN parameter is set to DIGITAL, the unit recognizes DTS-encoded discs as audio signals (not data signals) and outputs loud digital noise from the ZONE2 analog and digital audio outputs. For maximum flexibility with Dolby Digital and DTS (-ES) sources:

1. Select a Main Zone DIGITAL IN connector.
2. Set the ZONE2 IN parameter to ANLG.
3. Connect the digital and analog outputs on the DVD player to the corresponding digital and analog inputs on the RV-8.

The unit will use the digital connector for the Main Zone, and the analog connectors for Zone 2.

ZONE2 IN PARAMETER SETTINGS		
DIGITAL	ANLG (Analog)	DMIX (Downmix)
<ul style="list-style-type: none"> The RV-8 automatically sets the ZONE2 IN parameter to DIGITAL when the ANALOG IN parameter is set to NONE. The RV-8 sends the assigned DIGITAL IN connector specified in the INPUT SETUP menu to the ZONE 2 ANALOG and DIGITAL AUDIO OUTPUTS. Only PCM digital input sources are compatible with ZONE 2 analog audio outputs. Dolby Digital and DTS sources are compatible with the Zone 2 digital audio output when the DIG BYPASS parameter is set to ON. Audio will not be available in Zone 2 analog outputs when a Dolby Digital, DTS (-ES) or unknown digital input source is present. 	<ul style="list-style-type: none"> The ANALOG IN connector specified in the INPUT SETUP menu is sent to the ZONE 2 ANALOG and DIGITAL AUDIO OUTPUTS. Only Front L/R Audio will be available in Zone 2 when one of the 5.1 analog inputs is selected for the Main Zone. 	<ul style="list-style-type: none"> Set the ZONE2 IN parameter to DMIX to send a downmixed version of Main Zone audio to the Zone 2 audio output connectors. Downmixes can be generated for Dolby Digital, DTS(-ES) and 5.1a sources. To generate a downmix, the same input must be selected in the Main Zone and Zone 2. Otherwise, the Zone 2 audio output connectors will mute. Main Zone listening mode activation affects the Zone 2 audio output connectors. For instance, when the MONO listening mode is activated in the Main Zone, the Zone 2 audio output connectors will generate mono output signals. It is recommended that you set the ZONE2 IN parameter to DMIX when recording from a DVD player without built-in Dolby Digital or DTS-ES decoding to a VCR or PVR (e.g. Tivo® or Replay TV®). A 2-channel downmixed version of Main Zone audio is sent to the ZONE 2 ANALOG and DIGITAL AUDIO OUTPUTS. Downmixes can be generated for Dolby Digital, DTS(-ES) and 5.1 analog input sources. To generate a downmix, the input that is selected in Zone 2 must also be selected in the Main Zone (e.g., DVD1). Otherwise, the ZONE 2 ANALOG and DIGITAL AUDIO OUTPUTS will mute. Downmixes cannot be generated when the 5.1a BYPASS listening mode is selected in the Main Zone.

ZONE2 ADVANCED

SETUP ▶ INPUTS ▶ DVD1 ▶ ZONE2 ADVANCED

Opens the ZONE2 IN menu, which is used to configure advanced

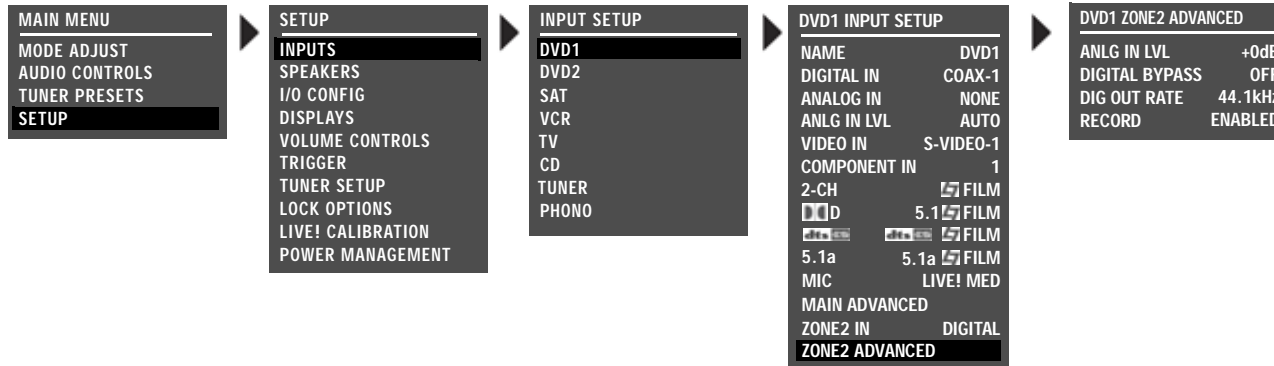

Parameter	Possible Settings
ANLG IN LVL	-18dB to + 12dB
DIGITAL BYPASS	ON, OFF
DIG OUT RATE	96kHz, 88.2kHz, 48kHz, 44.1kHz
RECORD	BLOCKED, ENABLED

ANLG IN LVL -18 to +12dB

SETUP ▶ INPUTS ▶ DVD1 ▶ ZONE2 ADVANCED ▶ ANLG IN LVL

Allows adjustment of analog audio input levels for input signals sent to the Zone 2 digital audio output connectors. The RV-8 applies these adjustments to input signals before passing them to the Zone 2 digital audio output connectors. This parameter can be adjusted when an input source is present to prevent the internal A/D converter from overloading.

DIGITAL BYPASS

ON, OFF

SETUP ▶ INPUTS ▶ DVD1 ▶ ZONE2 ADVANCED ▶ DIGITAL BYPASS

Allows digital sources to bypass decoding for direct digital recording. When ON is selected, the RV-8 passes digital input signals directly to the Zone 2 digital audio output connectors, preserving the original format of the input signal. This would be useful if you want to send a multichannel-encoded signal to a second device for decoding. When OFF is selected and the ZONE2 IN parameter is set to DIGITAL, Dolby Digital and DTS sources will not be passed to the Zone 2 digital audio outputs. When OFF is selected and a PCM source is present, the RV-8 will send the PCM audio to the Zone 2 digital audio output connectors. If a Dolby Digital or DTS source is present and the ZONE2 IN parameter is set to DMIX, a downmix of the source will be sent to the Zone 2 digital audio output connectors.

DIG OUT RATE

96kHz, 88.2kHz, 48kHz, 44.1kHz

SETUP ▶ INPUTS ▶ DVD1 ▶ ZONE2 ADVANCED ▶ DIG OUT RATE

Controls the sample rate of analog input signals sent to the Zone 2 digital audio output connectors.

When a value is selected, the RV-8 runs the Zone 2 A/D converters at the selected sample rate. It is recommended to set the DIG OUT RATE parameter to the appropriate value when using a recording format that operates on a single sample rate, such as CD-R format (44.1kHz).

Note:

DIG OUT RATE only affects analog input signals. It does not change the sample rate of digital input signals, or downmixed signals.

RECORD

BLOCKED, ENABLED

SETUP ▶ INPUTS ▶ DVD1 ▶ ZONE2 ADVANCED ▶ RECORD

Prevents recording device feedback loops. When BLOCKED is selected, the RV-8 blocks the Zone 2 audio output connectors to prevent feedback loops. However, the RV-8 still passes video input signals to the Zone 2 video output connectors. When ENABLED is selected, the RV-8 passes audio and video input signals to the Zone 2 audio and video output connectors.

SPEAKER SETUP

SETUP ▶ SPEAKERS

Select the SPEAKER SETUP menu to configure the Main Zone audio output connectors for the desired speaker setup. The Main Zone includes eight audio output connectors labeled Front L/R, Center, Subwoofer, Side L/R and Rear L/R.

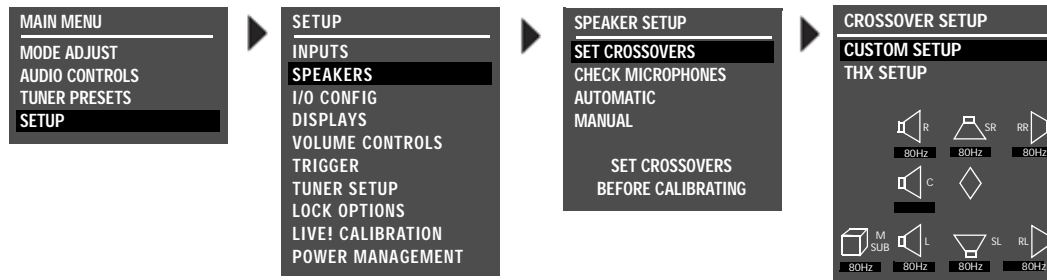

SETTING CROSSOVER POINTS

SETUP ▶ SPEAKERS ▶ SET CROSSOVERS

Selecting the SPEAKER SETUP menu SET CROSSOVERS option opens the CROSSOVER SETUP menu, which is used to configure a custom or THX setup.

Note:

It is important to set crossover points before calibrating output levels or LIVE!. Setting crossover points afterwards could invalidate calibrated output levels and will invalidate the LIVE! calibration.

CUSTOM SPEAKER SETUPS

Selecting the CROSSOVER SETUP menu CUSTOM SETUP option opens the CUSTOM SETUP menu, which assigns independent crossover points for each Main Zone audio output connector. Possible crossover settings include FULL, FULL + SUB, and 10Hz increments within a 30Hz to 120Hz range. The graphs shown on the next page indicate the frequency response of each crossover point.

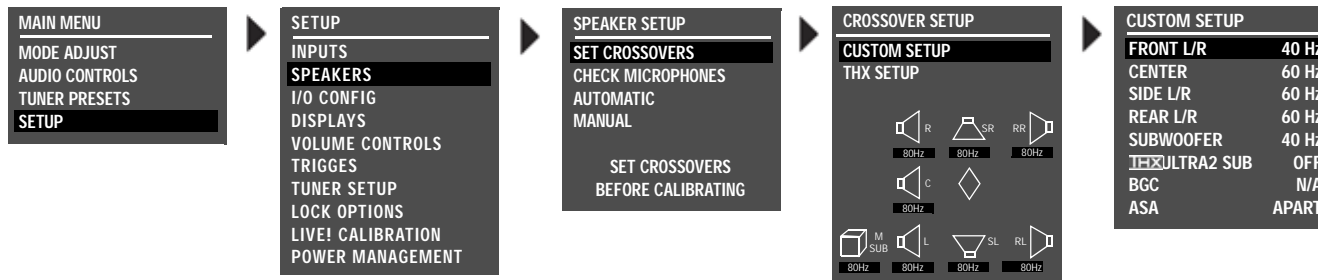

To configure a custom speaker setup:

- Select the crossover point closest to the low frequency rating of the associated speakers. For example, set the FRONT L/R parameter to the crossover point closest to the low-frequency rating of the front speakers.
- Select the subwoofer crossover point equal to the lowest crossover point of any of the other speakers. For example, if CUSTOM SETUP menu parameters are set as shown above, set the SUBWOOFER parameter to 40Hz – the lowest crossover point of the other speakers.

In a custom setup, low frequencies are generally redirected from speakers with the highest crossover points to speakers with the lowest crossover points. Signals lower than the lowest crossover point are redirected to the subwoofer. If the lowest crossover point is FULL, low-frequency signals, excluding LFE information, are not redirected to the subwoofer.

Low frequencies between the Subwoofer and any or all of the other speaker channels can be duplicated. To do this, select the FULL + SUB crossover setting for the front, center, side or rear speakers. Making this selection can result in excessive bass.

In general, low frequencies will be redirected from speakers with the highest crossover points to speakers with the lowest crossover points. Low-frequency signals lower than the lowest crossover point will be redirected to the subwoofer. If the lowest crossover point is FULL, low frequency signals, excluding LFE information, will not be redirected to the subwoofer.

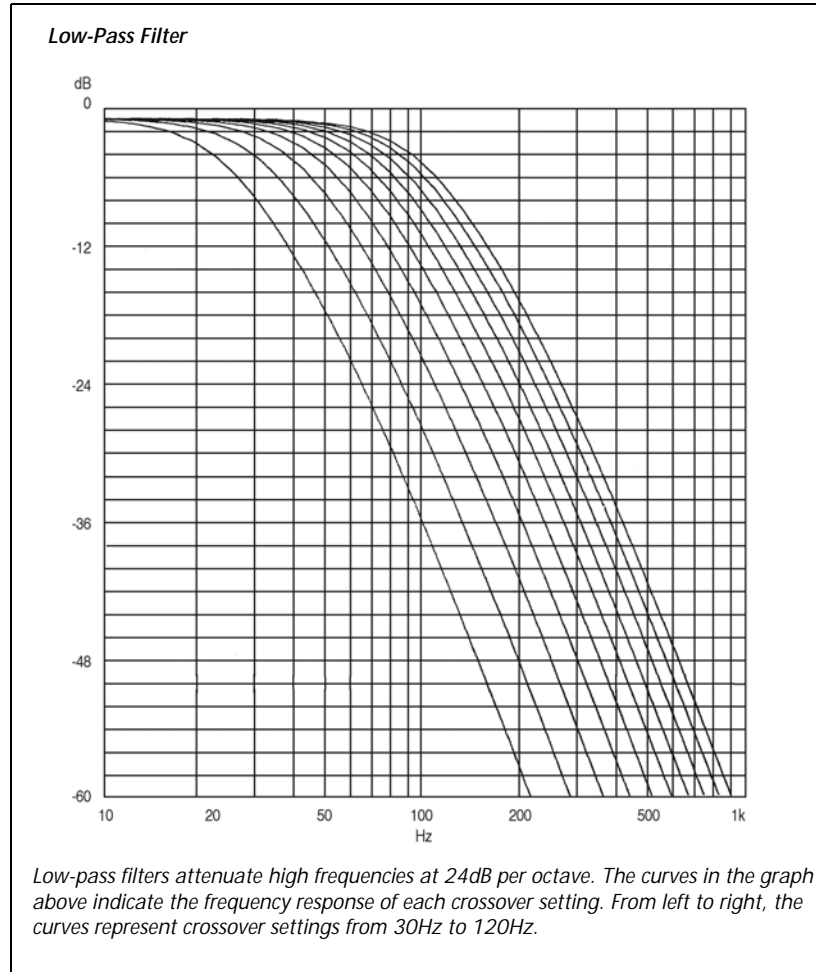
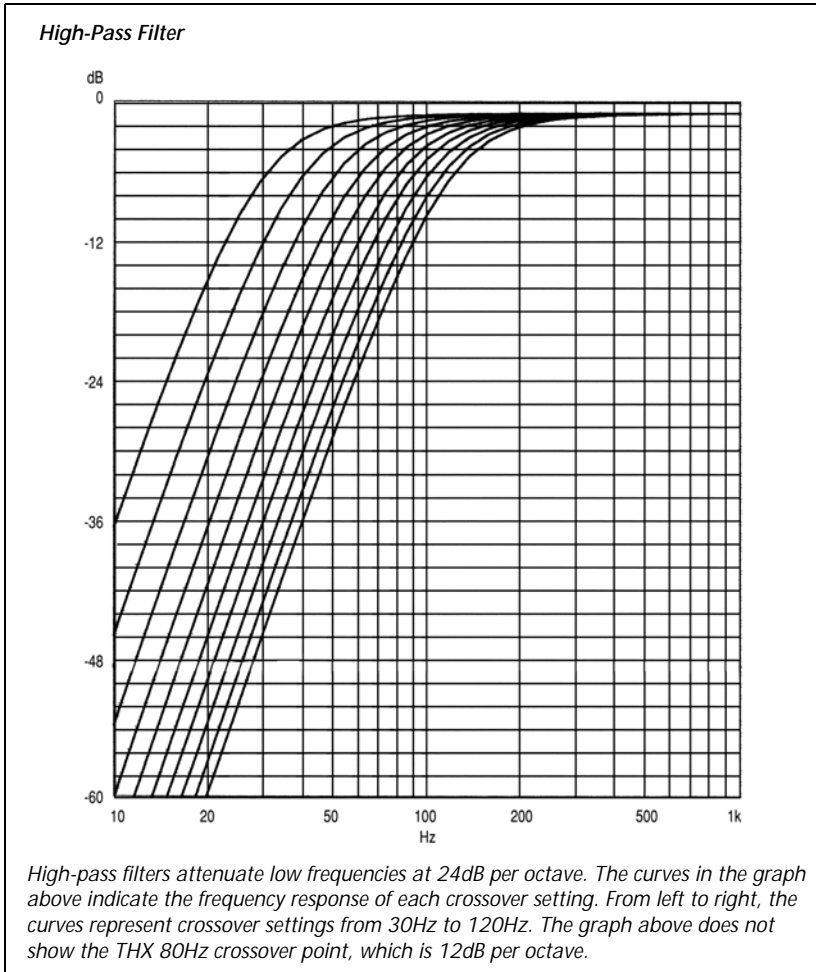

THX SPEAKER SETUPS

Selecting THX SETUP opens the THX SPEAKER SETUP screen, which indicates that pressing the ► arrow button will automatically configure the Main Zone audio output connectors for a THX speaker setup. Use THX-certified speakers in a THX speaker setup.

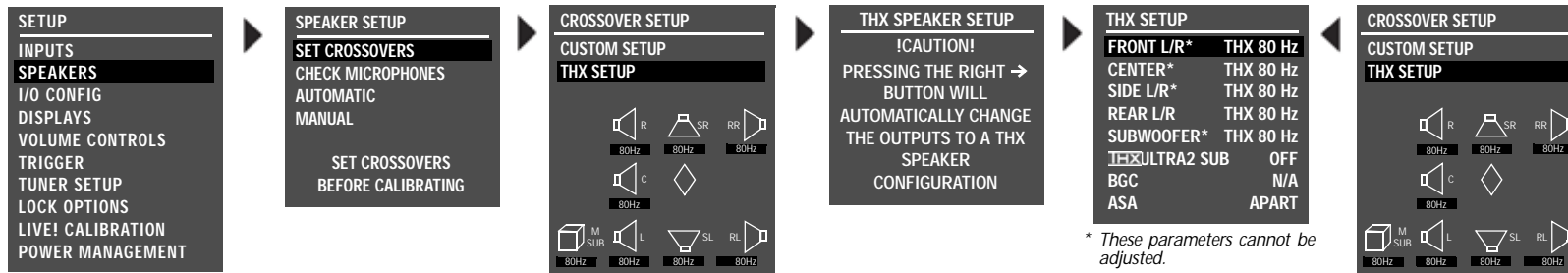

Selecting THX SETUP opens the THX SPEAKER SETUP screen, which indicates that pressing the ► arrow button will automatically configure the Main Zone audio output connectors for a THX speaker setup. Use THX-certified speakers in a THX speaker setup.

When the THX SPEAKER SETUP screen opens:

- Press the ► arrow button to configure the Main Zone audio output connectors for a THX speaker setup. The THX SETUP menu will open on the in-screen display.
- Press the ◀ arrow button to close the message without configuring the Main Zone audio output connectors for a THX speaker setup.

When a THX speaker setup is selected, the RV-8 applies a THX 80Hz crossover point with a 12dB-per-octave filter to the Front L/R, Center, Side L/R and Rear L/R output connectors. The RV-8 applies a THX 80Hz crossover point with a 24dB-per-octave filter to the Subwoofer output connector.

Notes:

- A THX speaker setup is not required to activate THX listening modes.
- In the THX SETUP menu, only the REAR L/R, THX ULTRA2 SUB, BGC and ASA parameters can be changed.

SPEAKER SETUP PARAMETERS

SETUP ▶ SPEAKERS ▶ SET CROSSOVERS ▶ CUSTOM SETUP ▶ or SETUP ▶ SPEAKERS ▶ SET CROSSOVERS ▶ THX SETUP ▶▶

The table below indicates the speaker setup parameters for configuring the Main Zone audio output connectors for the desired speaker setup. These parameters are available in the CUSTOM SETUP and THX SETUP menus.

Speaker setup parameters perform the same function regardless of the selected speaker setup. When a parameter setting is adjusted on one menu, the corresponding parameter setting is automatically adjusted on the other menu. For example, when a THX speaker setup is selected, the crossover settings on the CUSTOM SETUP menu are set to THX 80Hz.

Parameter	CUSTOM SETUP Menu		THX SETUP Menu	
	Default Setting	Possible Settings	Default Setting	Possible Settings
FRONT L/R*	80Hz	FULL, FULL + SUB, 30 to 120Hz, THX 80Hz	THX 80Hz	THX 80Hz
CENTER*	80Hz	FULL, FULL + SUB, 30 to 120Hz, THX 80Hz, NONE	THX 80Hz	THX 80Hz
SIDE L/R*	80Hz	FULL, FULL + SUB, 30 to 120Hz, THX 80Hz, NONE	THX 80Hz	THX 80Hz
REAR L/R	80Hz	FULL, FULL + SUB, 30 to 120Hz, THX 80Hz, NONE	THX 80Hz	THX 80Hz, NONE
SUBWOOFER*	80Hz	FULL, 30 to 120Hz, THX 80Hz, NONE	THX 80Hz	THX 80Hz
THX ULTRA2 SUB	OFF	ON, OFF	OFF	ON, OFF
BGC	N/A†	ON, OFF	N/A†	ON, OFF
ASA	APART	APART, CLOSE, TOGETHER	APART	APART, CLOSE, TOGETHER

* These parameters cannot be adjusted on the THX SETUP menu.
 † When the THX ULTRA2 SUB parameter is set to OFF, the BGC parameter is not available (N/A).

SPEAKER SETUP PARAMETERS (continued)

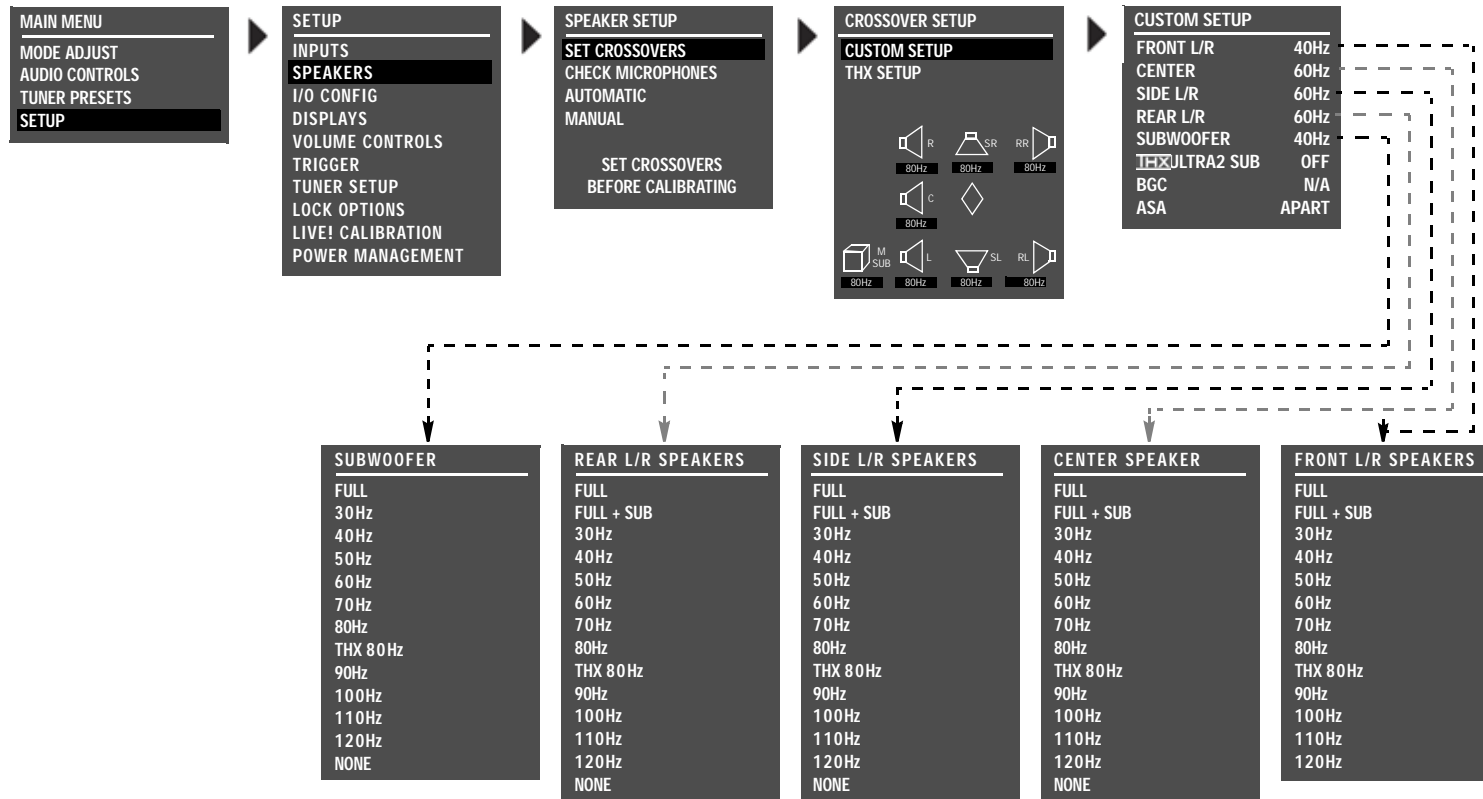

FRONT L/R FULL, FULL + SUB, 30 to 120HZ, THX 80HZ

SETUP ▶ SPEAKERS ▶ SET CROSSOVERS ▶ CUSTOM SETUP ▶ FRONT L/R

Assigns a crossover point for the Main Zone audio output connectors labeled Front L/R when a custom speaker setup is selected. Opens the FRONT L/R SPEAKERS menu to select a crossover point for the Front L/R output connectors.

- Select FULL to send a full-range signal to the front speakers. Otherwise, select the crossover point closest to the low-frequency rating of the front speakers.
- Select FULL + SUB to send a full-range signal to the front speakers and duplicate bass frequencies to the SUB output. (The set crossover point of the SUB parameter determines the upper range of duplicate bass.) Selecting the FULL + SUB option can result in excessive bass.

SETUP ▶ SPEAKERS ▶ SET CROSSOVERS ▶ THX SETUP ▶ ▶

When THX speaker setup is selected, a THX 80Hz crossover point is applied to the Front L/R output connectors, and the FRONT L/R parameter cannot be adjusted.

CENTER FULL, FULL + SUB, 30 to 120HZ, THX 80HZ, NONE

SETUP ▶ SPEAKERS ▶ SET CROSSOVERS ▶ CUSTOM SETUP ▶ CENTER

Assigns a crossover point for the Main Zone audio output connector labeled CENTER when a custom speaker setup is selected. Opens the CENTER SPEAKER menu to select a crossover point for the CENTER output connector.

- Select FULL to send a full-range signal to the center speaker. Otherwise, select the crossover point closest to the low-frequency rating of the center speaker.
- Select FULL + SUB to send a full-range signal to the center speaker and duplicate bass frequencies to the SUB output. (The set crossover point of the SUB parameter determines the upper range of duplicate bass.) Selecting the FULL + SUB option can result in excessive bass.
- When the speaker setup does not include a center speaker, select NONE to redirect center channel signals to the Front L/R output connectors – unless the 5.1a BYPASS listening mode is activated. In this case, configure the speaker setup with the associated DVD-A/ SACD player to redirect center channel signals.

SETUP ▶ SPEAKERS ▶ SET CROSSOVERS ▶ THX SETUP ▶ ▶

When THX speaker setup is selected, a THX 80Hz crossover point is applied to the Center output connector, and the CENTER parameter cannot be adjusted.

SPEAKER SETUP PARAMETERS *(continued)***SIDE L/R** FULL, FULL + SUB, 30 to 120Hz, THX 80Hz, NONE

SETUP ▶ SPEAKERS ▶ SET CROSSOVERS ▶ CUSTOM SETUP ▶ SIDE L/R

Assigns a crossover point for the Main Zone audio output connectors labeled SIDE L/R when a custom speaker setup is selected.

- Select FULL to send a full-range signal to the side speakers. Otherwise, select the crossover point closest to the low-frequency rating of the side speakers.
- Select FULL + SUB to send a full-range signal to the side speakers and duplicate bass frequencies to the SUB output. (The set crossover point of the SUB parameter determines the upper range of duplicate bass.) Selecting the FULL + SUB option can result in excessive bass.
- When the speaker setup does not include side speakers, select NONE to redirect side channel signals to the Rear L/R output connectors. If the REAR L/R parameter is also set to NONE, the RV-8 will redirect surround channel signals to the Front L/R output connectors.

Note:

When the SIDE L/R parameter is set to NONE, Dolby Digital Surround EX, THX Ultra2, THX Surround EX, DTS(-ES) decoding, the ASA parameter and PLIIx modes are not available.

SETUP ▶ SPEAKERS ▶ SET CROSSOVERS ▶ THX SETUP ▶ ▶

When THX speaker setup is selected, a THX 80Hz crossover point is applied to the SIDE L/R output connectors, and the SIDE L/R parameter cannot be adjusted.

REAR L/R FULL, FULL + SUB, 30 to 120Hz, THX 80Hz, NONE

SETUP ▶ SPEAKERS ▶ SET CROSSOVERS ▶ CUSTOM SETUP ▶ REAR L/R

Assigns a crossover point for the Main Zone audio output connectors labeled REAR L/R when a custom speaker setup is selected.

- Select FULL to send a full-range signal to the rear speakers. Otherwise, select the crossover point closest to the low-frequency rating of the rear speakers.
- Select FULL + SUB to send a full-range signal to the rear speakers and duplicate bass frequencies to the SUB output. (The set crossover point of the SUB parameter determines the upper range of duplicate bass.) Selecting the FULL + SUB option can result in excessive bass.
- When the speaker setup does not include rear speakers, select NONE to redirect rear channel signals to the Side L/R output connectors. If the SIDE L/R parameter is also set to NONE, the RV-8 redirects surround channel signals to the Front L/R output connectors.

Note:

When the REAR L/R parameter is set to NONE, Dolby Digital Surround EX, THX Ultra2, THX Surround EX, PLIIx modes, DTS(-ES) decoding and the ASA parameter are not available.

SETUP ▶ SPEAKERS ▶ SET CROSSOVERS ▶ THX SETUP ▶ ▶

When THX speaker setup is selected, the THX REAR SPEAKERS menu opens which is used to activate or deactivate the REAR L/R output connectors.

To activate and configure the Rear L/R output connectors for a 7.1-channel THX speaker, setup select THX 80Hz. To deactivate the Rear L/R output connectors and configure the Main Zone audio output connectors for a 5.1-channel THX speaker setup, select NONE.

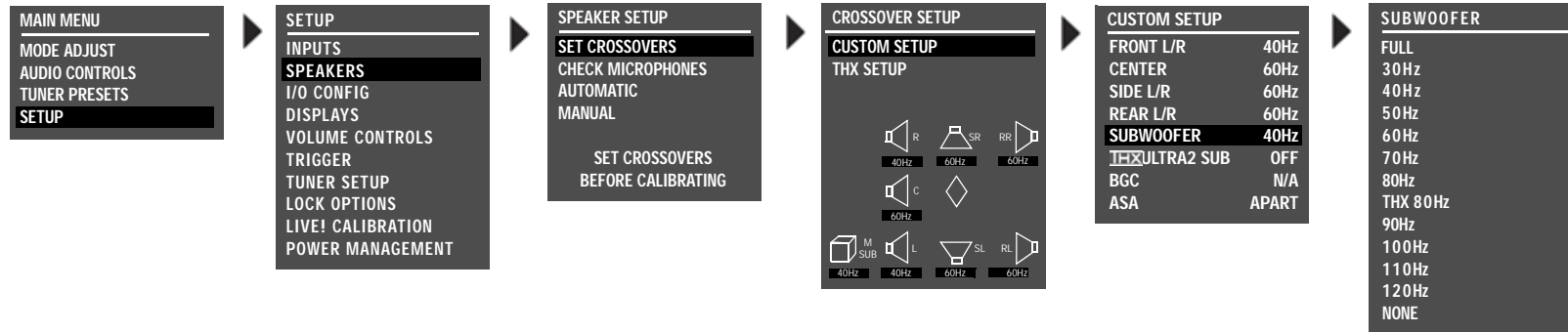

SUBWOOFER FULL, 30 TO 120 Hz, THX 80Hz, NONE



Assigns a crossover point for the Main Zone audio output connector labeled Subwoofer. When set to FULL, the RV-8 sends a full-range audio output signal to this connector. Otherwise, the RV-8 activates a crossover point at the selected setting. Choose the setting equal to the lowest setting of the other speakers.

Note:

When the SUBWOOFER parameter is set to NONE, subwoofer signals will not be redirected if the 5.1a BYPASS listening mode is activated. To redirect subwoofer signals, configure the speaker setup with the associated DVD-A/SACD player.SETUP

SPEAKER SETUP PARAMETERS (continued)

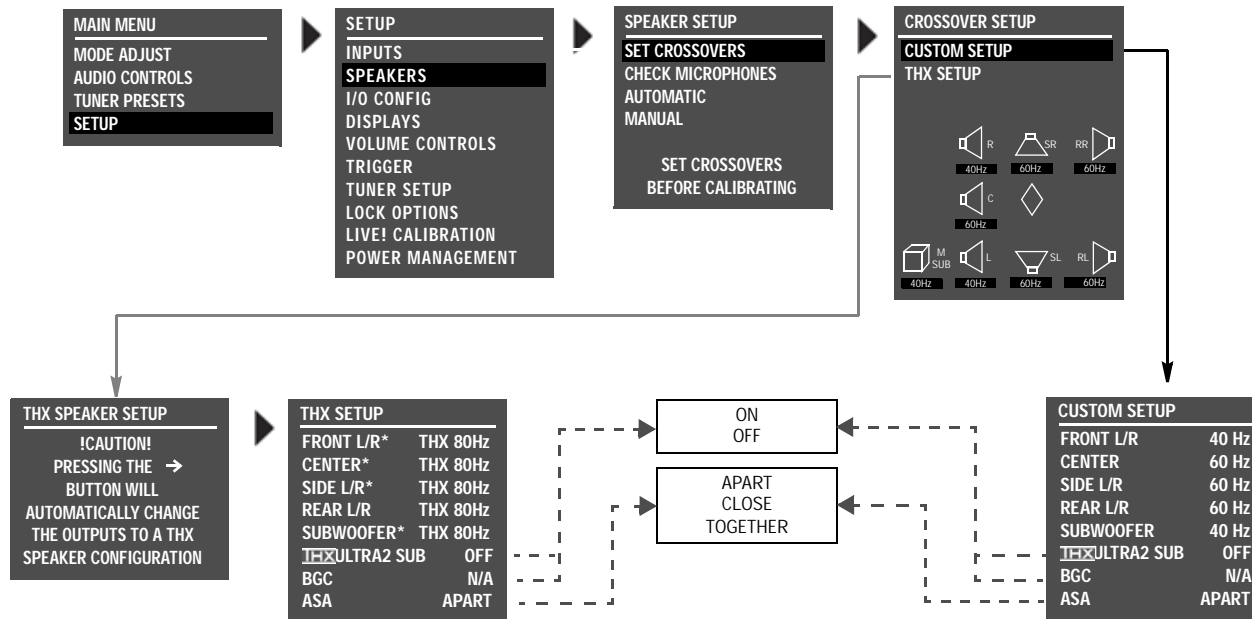

* These parameters cannot be adjusted.

THX ULTRA2 SUB

ON, OFF

SETUP ▶ SPEAKERS ▶ CUSTOM SETUP ▶ ~~THX~~ ULTRA2 SUB or SETUP ▶ SPEAKERS ▶ THX SETUP ▶ ~~THX~~ ULTRA2 SUB

Indicates whether or not the subwoofer connected to the Main Zone audio output connector labeled Subwoofer is Ultra2-certified. Select the ON setting if the connected subwoofer is Ultra2-certified and the OFF setting if the connected subwoofer is not Ultra2-certified. When

set to ON, the CUSTOM and THX SETUP menu BGC parameter can be used to adjust boundary gain compensation. When set to OFF, the BGC parameter is not available (N/A).

BGC (BOUNDARY GAIN COMPENSATION) ON, OFF

- ▶ SETUP ▶ SPEAKERS ▶ CUSTOM SETUP ▶ BGC
- ▶ SETUP ▶ SPEAKERS ▶ THX SETUP ▶▶ BGC

Adjusts boundary gain compensation when the CUSTOM and THX SETUP menu THX ULTRA2 SUB parameter is set to ON. When the BGC parameter is set to ON, a highpass 55Hz filter is applied to all audio output connectors for all Main Zone listening modes. When set to OFF, no filter is applied to Main Zone listening modes and audio output connectors. When the parameter setting is N/A, the THX ULTRA2 SUB parameter is set to OFF, and boundary gain compensation cannot be adjusted.

Note:

BGC compensates for increased bass energy that is caused by the proximity of the speakers to the listening room walls.

ASA (ADVANCED SPEAKER ARRAY) APART, CLOSE, TOGETHER

- ▶ SETUP ▶ SPEAKERS ▶ CUSTOM SETUP ▶ ASA
- ▶ SETUP ▶ SPEAKERS ▶ THX SETUP ▶▶ ASA

A proprietary THX technology that processes signals sent to the rear speakers, optimizing the listening experience for THX Ultra2 listening modes. To maximize the effectiveness of ASA processing, it is recommended that you configure a 7-channel speaker setup in which the rear speakers are placed close together facing the center of the listening space. **The ASA parameter is not available unless the 5.1 THX ULTRA2, 5.1 THX MUSIC, DTS THX ULTRA2 or DTS THX MUSIC listening mode is activated.**

Select the TOGETHER setting if the distance between the rear speakers is less than 1 foot (0.3m). Select the CLOSE setting if the distance between the rear speakers is greater than 1 foot (0.3m), but less than 4 feet (1.2m). Select the APART setting if the distance between the rear speakers is greater than 4 feet (1.2m).

Note:

ASA processing is only available when both side and rear speakers are present.

When the remote control 7/5 button is used to toggle between 7 and 5-channel playback:

- *ASA processing is not available during 5-channel playback.*
- *The RV-8 automatically switches between the 5.1 THX ULTRA2 and 5.1 THX or DTS THX ULTRA2 and DTS THX listening modes.*

AUTOMATIC CALIBRATION

The RV-8 offers automatic calibration of speaker distances, output level, or both. The table below indicates available automatic calibration options. **A successful microphone check is required before automatic calibration can be performed.**

Automatic Options	Details
MICROPHONE CHECK	<ul style="list-style-type: none"> • Confirms that the microphones are properly connected and functioning. • Calculates an average level for the microphones connected to the microphone input connectors, allowing the RV-8 to compensate for individual microphone sensitivities during automatic calibration. • Ensures that microphone levels are consistent, eliminating automatic calibration errors from individual microphone levels.
DISTANCES & LEVELS	<ul style="list-style-type: none"> • Activates automatic calibration of speaker distances and output levels. • Offers accurate calibration with minimal interaction, automatically applying calibrated speaker distances and output levels. • Calibrates speaker distances within 0.5 foot (.15m) of the physical distance between the primary listening position and the speaker. • Calibrates individual speaker output levels within +/-0.5dB of each other and overall speaker output levels within +/-3.0dB of THX reference levels (75dB).
DISTANCES	<ul style="list-style-type: none"> • Activates automatic calibration of speaker distances. • Provides a comparison between original and calibrated speaker distances, allowing selection of the desired values. • Calibrates speaker distances within 0.5 foot (.15m) of the physical distance between the primary listening position and the speaker.
LEVELS	<ul style="list-style-type: none"> • Activates automatic calibration of output levels. • Provides a comparison between original and calibrated output levels, allowing selection of the desired values. • Calibrates individual speaker output levels within +/-0.5dB of each other and overall speaker output levels within +/-3.0dB of THX reference levels (75dB).

CONNECTING THE MICROPHONES

CAUTION!

- The microphones included in the Lexicon Microphone Kit require careful handling. Dropping or otherwise physically abusing the microphones might cause errors during use or irreparable damage to the microphones.
- The microphone wires also require careful handling. Do not sharply bend the wires or place objects on them.
- Never make or break microphone input connections unless the RV-8 is powered off with the rear-panel power switch, OR standby mode is activated with the front-panel or remote control standby button.

Note the following:

- Automatic calibration requires the microphones included in the Lexicon Microphone Kit, available at authorized Lexicon dealers. Performing automatic calibration with microphones other than those in the kit will produce unpredictable results.
- Proper microphone placement is essential to achieving the desired automatic calibration results. Pay particular attention to the microphone placement instructions and illustrations included in this section.
- It is important to read and observe the care and handling documentation included with the Lexicon Microphone Kit to ensure optimal microphone performance.
- If power is lost during automatic calibration of speaker levels or speaker distances, previous settings may be lost and recalibration of speaker levels and speaker distances is required.

To connect the microphones:

4. Make sure the RV-8 is powered off OR in standby mode.
5. Connect the microphones included in the Lexicon Microphone Kit to the microphone input connectors on the RV-8 rear panel. Make sure the microphone cable plug is fully inserted for a solid connection.

During the microphone check, the microphones will be referred to as 1 or 2, based on the input connector to which the microphone is connected. You should label the microphones for troubleshooting purposes.
6. Power on the RV-8 or deactivate standby mode.

POSITIONING THE MICROPHONES FOR THE MICROPHONE CHECK

Refer to the microphone placement examples that begin below to position the microphones for the microphone check.

PROPER *microphone positioning for the microphone check*

During the microphone check, position the microphones:

- ✓ As close together as possible
- ✓ Relatively centered between and equidistant from the front left and right speakers
- ✓ In a clear line-of-sight path with the speakers
- ✓ In a location unobstructed by furniture and other fixtures, where echoes will not obscure calibration noise signals
- ✓ At least 2 feet (0.61m) from all speakers and walls, but within 30 feet (9.14m) of all speakers

The illustration to the right provides an example of proper microphone placement during the microphone check. All of the microphones are positioned as close together as possible in an unobstructed location that is equidistant from the front left and right speakers.

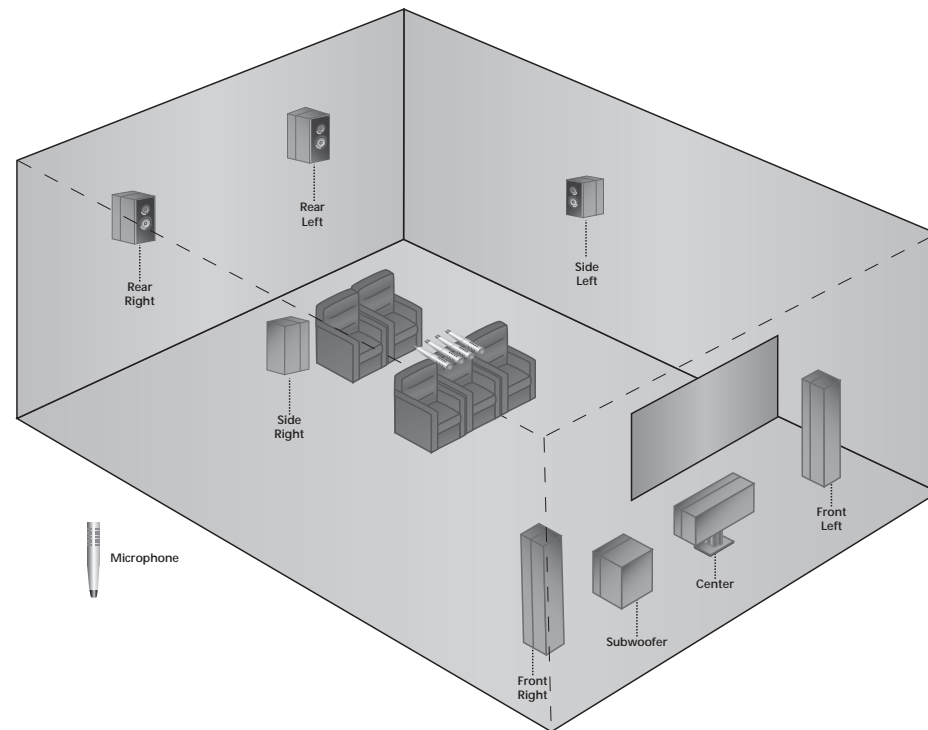

IMPROPER *microphone positioning for the microphone check*

During the microphone check, DO NOT:

- ✗ Separate the microphones
- ✗ Scatter the microphones throughout the listening space
- ✗ Obstruct the line-of-sight path between the microphones and the speakers
- ✗ Position the microphones on the floor, on seat cushions, or in locations obstructed by furniture and other fixtures, where echoes might obscure calibration noise signals
- ✗ Position the microphones within 2 feet (0.61m) of speakers and walls or more than 30 feet (9.14m) from any one speaker

The illustration to the right provides an example of improper microphone placement during the microphone check. The microphones are scattered throughout the listening space rather than positioned as close together as possible in a location that is equidistant from the front left and right speakers.

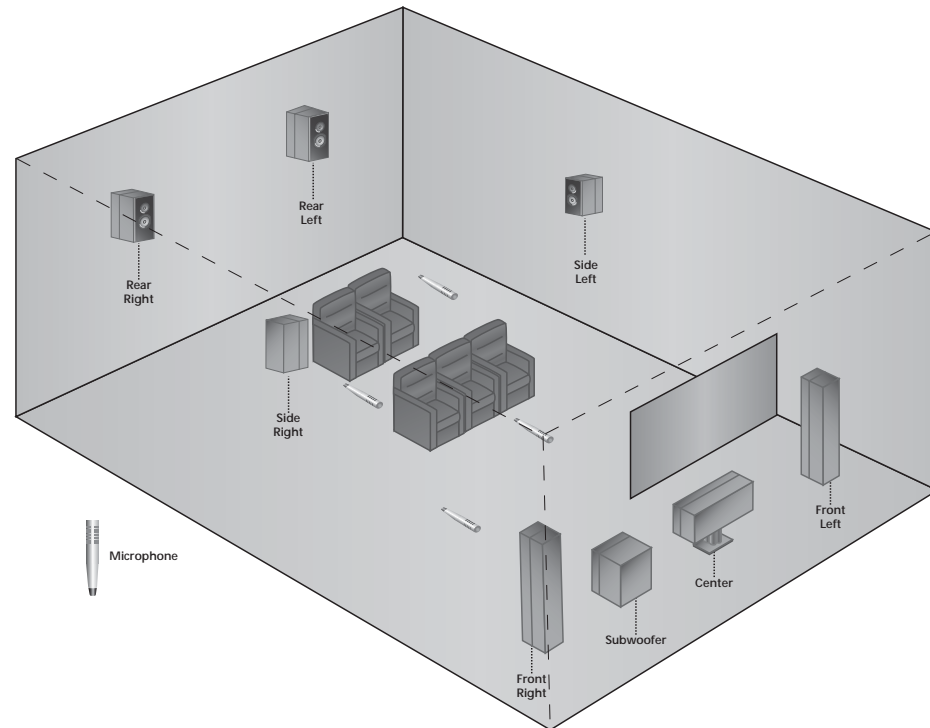

CHECKING THE MICROPHONES

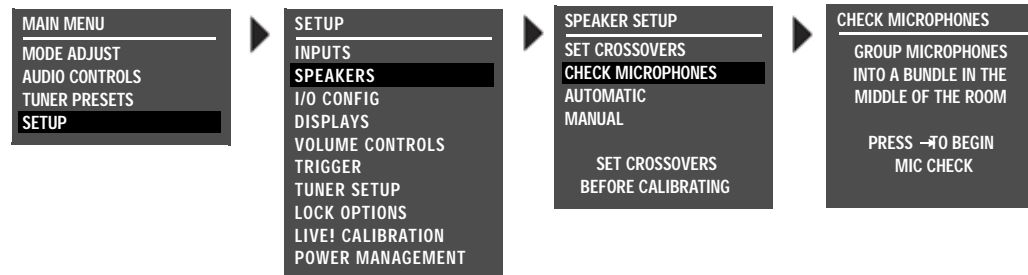

Note the following:

- The RV-8 outputs calibration noise signals between 55dB and 95dB, beginning with 55dB and increasing in 5dB increments until the microphones detect the required level. If the calibration noise signal becomes too loud, press the ◀ arrow button to cancel the microphone check.
 - Although the calibration noise signal is output at a fixed volume level, you should set all volume controls for associated components (i.e., speakers, subwoofers and power amplifiers) to a reasonable level before performing automatic calibration. When the procedure is finished, the RV-8 automatically reverts to the last volume level that was selected before automatic calibration began.
 - During automatic calibration, you should refer to the on-screen display instead of the front-panel display, as additional information and instructions are available in the on-screen display.
1. Select the SPEAKER SETUP menu CHECK MICROPHONES option, as shown above.

2. The first CHECK MICROPHONES screen opens in the on-screen display, indicating the importance of proper microphone placement to achieve accurate automatic calibration results.
3. Press the ▶ arrow button to begin the microphone check. The following screens appears in the on-screen display as the microphone check is performed:

CHECKING FOR SILENCE

Appears in the on-screen display while the RV-8 determines the relative noise level of the listening space and the internal noise level of the microphones. After eliminating microphones that are not detected or not functioning, the RV-8 calculates an average level for all microphones.

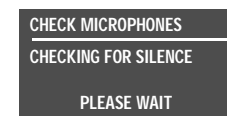

CHECKING MICROPHONES

Appears in the on-screen display while the RV-8 confirms the microphone level calculated during the silence check. To do this, the RV-8 sends alternating calibration noise signals to the front left and right speakers. These signals are output between 55dB and 95dB, beginning with 55dB and increasing in 5dB increments until the microphones detect the required level. If the signal becomes too loud, press the ◀ arrow button to cancel the microphone check.

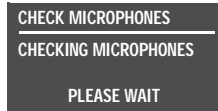

The RV-8 uses the calibration noise signal to eliminate microphones that register the signal at a level that is too low or too high. Then, the RV-8 determines the appropriate output level for the calibration noise signal used during automatic calibration.

CHECK MICROPHONES Results

Appears in the on-screen display when the RV-8 is finished checking the microphones. This display indicates the individual check results for each microphone.

- An OK result indicates that the microphone passed the microphone check.
- An ERROR result indicates that the microphone did not pass the microphone check.

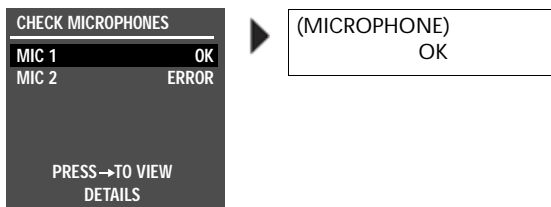

4. Press the ▲ and ▼ arrow buttons to highlight the desired microphone parameter. The RV-8 refers to the microphones according to the input connector to which the microphone is connected.
5. Press the ▶ arrow button to view more detailed results for the selected microphone. A message similar to the one shown at the bottom of the previous column opens in the on-screen display. Refer to the table on the next page for information about all possible microphone check messages.

Note the following:

- The RV-8 retains the calculated microphone level until the SPEAKER SETUP menu is closed. Once this menu is closed, another microphone check is required before automatic calibration can be performed.
- Optional microphone kits that include two microphones are available. Perform automatic calibration with two microphones that have passed the microphone check.
However, the RV-8 will perform automatic calibration as long as at least one microphone passes the microphone check. In this circumstance, place the successfully checked microphone in the primary listening position.
- If a microphone check was successful, do not disconnect the microphones from the microphone input connectors. If the microphones are disconnected, you should perform the microphone check again before proceeding to automatic calibration.

CHECKING THE MICROPHONES *(continued)*

Message	Description	Troubleshooting
(MICROPHONE) OK	The microphone detected the calibration noise signal without error.	<ul style="list-style-type: none"> N/A
(MICROPHONE) NOT DETECTED	The RV-8 did not detect the microphone during the silence check.	<ul style="list-style-type: none"> Examine microphone input connections to ensure that the microphones are properly connected to the RV-8 and that microphone cable plugs are fully inserted for a solid connection. The microphone may be damaged. Contact an authorized Lexicon dealer for assistance.
(MICROPHONE) SIGNAL TOO LOW	The RV-8 detected the microphone during the silence check. However, the microphone level determined during the silence check was not confirmed during the microphone check.	<ul style="list-style-type: none"> Examine microphone input connections to ensure that the microphones are properly connected to the RV-8 and that microphone cable plugs are fully inserted for a solid connection. The microphones may be positioned too far from the front speakers. Refer to the microphone placement examples that begin on page 3-38 to confirm that the microphones are appropriately positioned for the microphone check. The microphone may be damaged. Contact an authorized Lexicon dealer for assistance.
(MICROPHONE) OUT OF RANGE	The microphone level is more than 20dB below the highest microphone level.	<ul style="list-style-type: none"> Examine microphone input connections to ensure that the microphones are properly connected to the RV-8 and that microphone cable plugs are fully inserted for a solid connection. The microphones might be positioned too far from the front speakers. Refer to the microphone placement examples that begin on page 3-38 to confirm that the microphones are appropriately positioned for the microphone check. The microphone may be damaged. Contact an authorized Lexicon dealer for assistance.
(MICROPHONE) TOO MUCH ROOM NOISE	The microphone level could not be determined because of excessive room noise in the listening space.	<ul style="list-style-type: none"> Eliminate extraneous noises in the listening space, including conversations, air conditioners and sounds that filter in through open doors and windows. The microphone may be damaged. Contact an authorized Lexicon dealer for assistance.

POSITIONING THE MICROPHONES FOR AUTOMATIC CALIBRATION

Proper microphone placement is essential to achieving the desired automatic calibration results. Microphone placement determines whether the RV-8 calibrates optimal speaker distances and output levels for a single listening position, several listening positions in a single row, or several listening positions in the listening space.

- Refer to the microphone placement examples that begin on the next page to position the microphones for automatic calibration. Select the microphone placement that best meets the needs of the listening space.

PROPER *microphone placement to achieve the best results for a single listening position*

When calibrating for a single listening position, place the microphones:

- ✓ As close together as possible in a single listening position (the primary listening position)
- ✓ At the approximate spot where the listener's head will be during listening
- ✓ In a clear line-of-sight path with the speakers
- ✓ In a location unobstructed by furniture and other fixtures, where echoes will not obscure calibration noise signals
- ✓ At least 2 feet (0.61m) from all speakers and walls, but within 30 feet (9.14m) of all speakers

The illustration to the right provides an example of proper microphone placement when calibrating for a single listening position. The microphones are positioned as close together as possible in a single listening position, allowing the RV-8 to calibrate optimal speaker distances and output levels for that position.

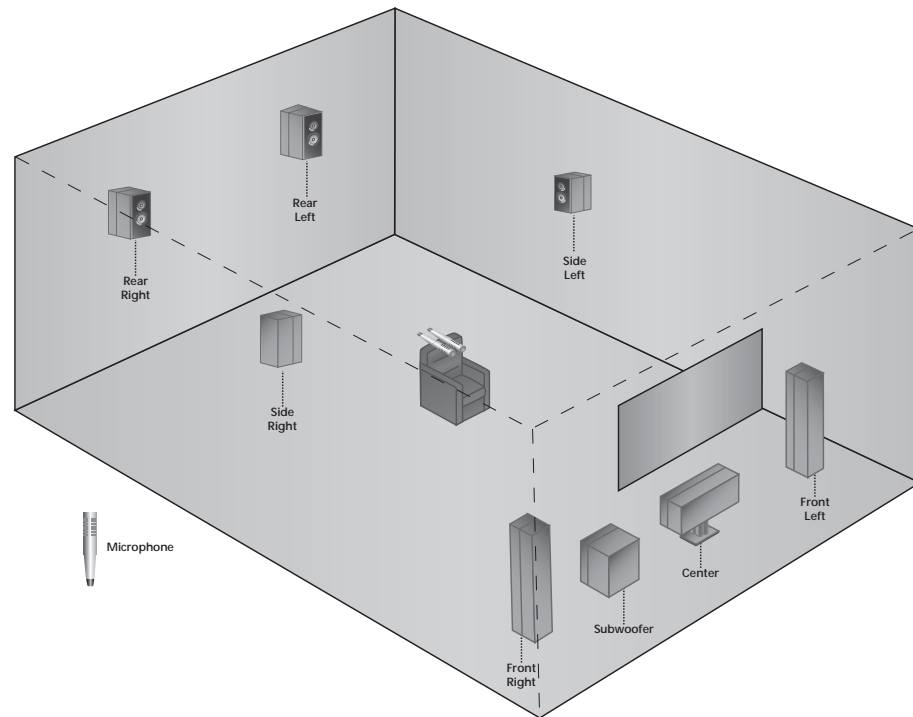

POSITIONING THE MICROPHONES FOR AUTOMATIC CALIBRATION *(continued)*

PROPER *microphone placement to achieve the best results for multiple listening positions in a single row*

When calibrating for multiple listening positions in a single row, position the microphones:

- ✓ At the approximate spot where the listener's head will be during listening
- ✓ In a clear line-of-sight path with the speakers
- ✓ In a location unobstructed by furniture and other fixtures, where echoes will not obscure calibration noise signals
- ✓ At least 2 feet (0.61m) from all speakers and walls, but within 30 feet (9.14m) of all speakers

The illustration to the right provides an example of proper microphone placement when calibrating for multiple listening positions in a single row. Each microphone is positioned in a single listening position within a single row, allowing the RV-8 to calibrate optimal speaker distances and output levels for that row at the expense of a single listening position.

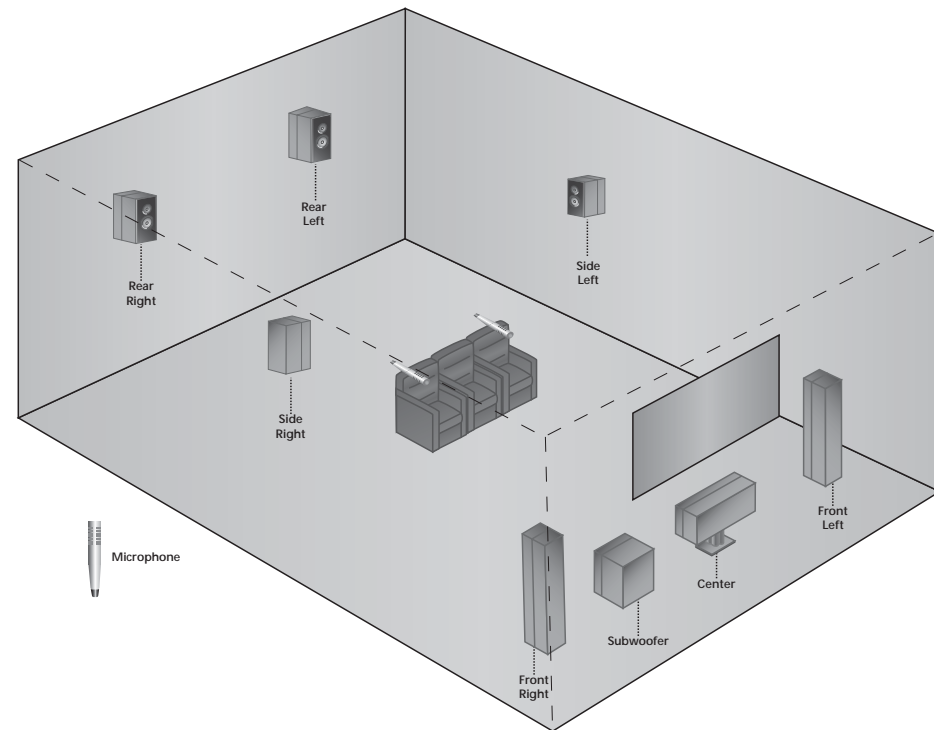

PROPER *microphone placement to achieve the best results for multiple listening positions in multiple rows*

When calibrating for multiple listening positions in multiple rows, position the microphones:

- ✓ At the approximate spot where the listener's head will be during listening
- ✓ In a clear line-of-sight path with the speakers
- ✓ In a location unobstructed by furniture and other fixtures, where echoes will not obscure calibration noise signals
- ✓ At least 2 feet (0.61m) from all speakers and walls, but within 30 feet (9.14m) of all speakers

The illustration to the right provides an example of proper microphone placement when calibrating for multiple listening positions in multiple rows. Each microphone is positioned in a single listening position within a row, allowing the RV-8 to calibrate optimal speaker distances and output levels for a larger listening area at the expense of a single listening position.

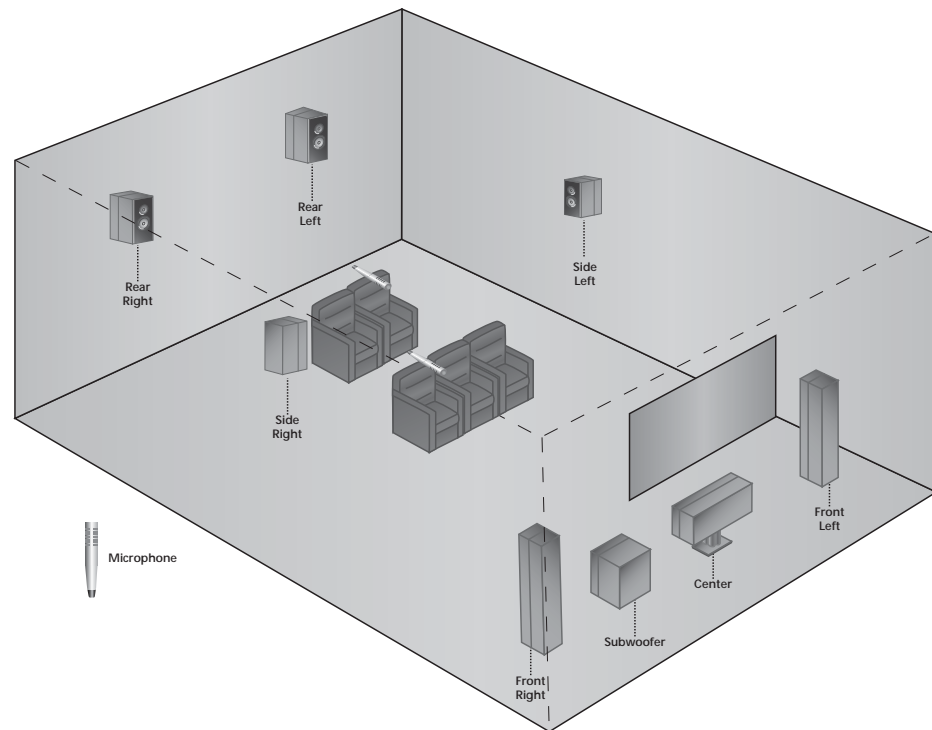

POSITIONING THE MICROPHONES FOR AUTOMATIC CALIBRATION (continued)**IMPROPER** *microphone positioning for automatic calibration***During the automatic calibration, do not:**

- ✗ Arrange the microphones along the perimeter of the listening positions or space
- ✗ Position the microphones in spots where the listeners' heads will not be during listening
- ✗ Obstruct the line-of-sight path between the microphones and the speakers
- ✗ Position the microphones on the floor, on seat cushions, or in locations obstructed by furniture and other fixtures, where echoes might obscure calibration noise signals
- ✗ Position the microphones within 2 feet (0.61m) of speakers and walls or more than 30 feet (9.14m) from any one speaker

The illustration to the right provides an example of improper microphone placement during the microphone check. The microphones are positioned on the floor along the perimeter of the listening space, making it difficult for the RV-8 to calibrate optimal speaker distances and output levels for the actual listening positions.

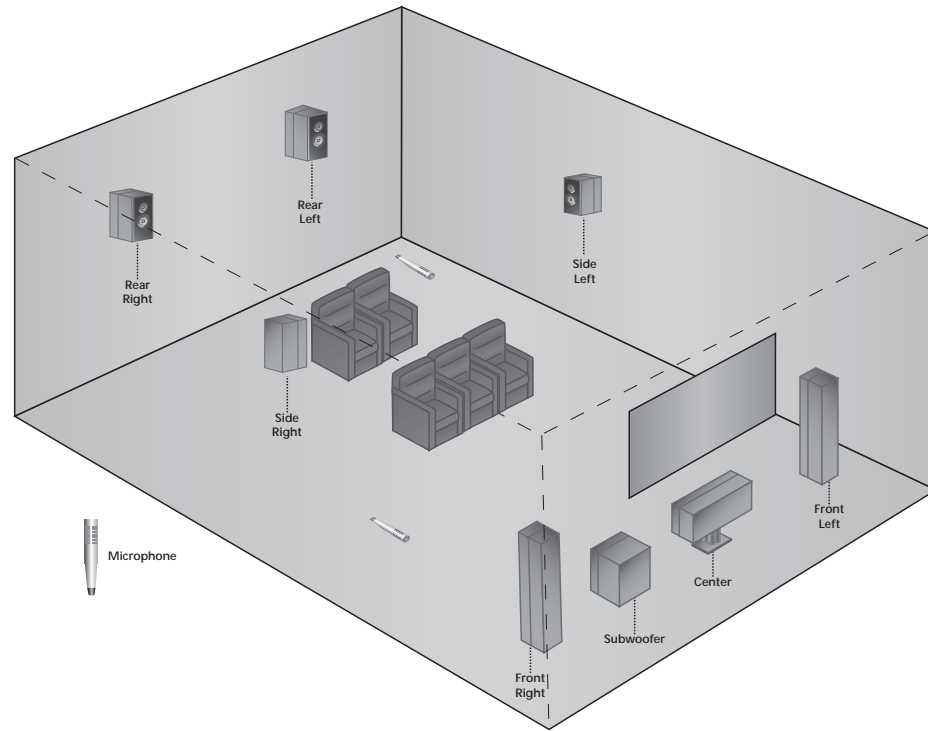

IMPROPER *microphone positioning for automatic calibration*

During the automatic calibration, do not:

- ✗ Arrange the microphones along the perimeter of the listening positions or space
- ✗ Position the microphones at spots where the listeners' heads will not be during listening
- ✗ Obstruct the line-of-sight path between the microphones and the speakers
- ✗ Position the microphones on the floor, on seat cushions, or in locations obstructed by furniture and other fixtures, where echoes might obscure calibration noise signals
- ✗ Position the microphones within 2 feet (0.61m) of speakers and walls or more than 30 feet (9.14m) from any one speaker

The illustration to the right provides an example of improper microphone placement during the microphone check. The microphones are positioned on seat cushions rather than in spots where the listener's heads will be during listening.

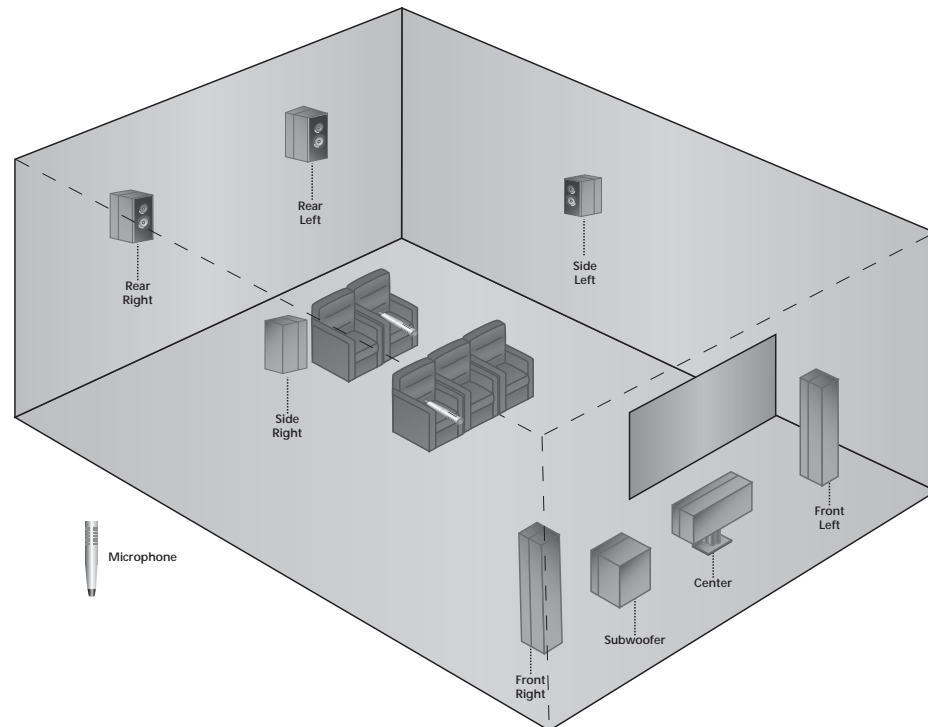

PERFORMING AUTOMATIC CALIBRATION

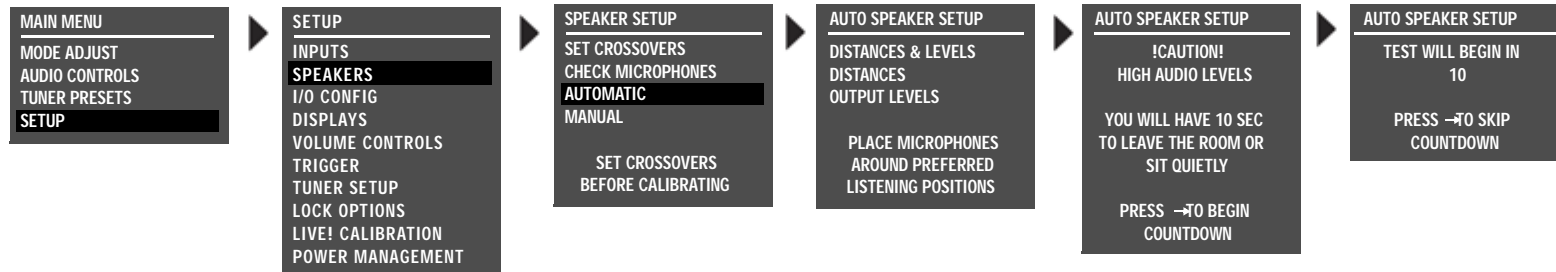

Follow the procedures in the appropriate table column for the desired type of automatic calibration.

STEP	DISTANCES	DISTANCES & LEVELS	LEVELS
1	<p>Select the SPEAKER SETUP menu AUTOMATIC option, as shown in the menu illustration above.</p> <ul style="list-style-type: none"> If a microphone check is successful, the AUTO SPEAKER SETUP menu appears in the on-screen display. Press the ▲ or ▼ arrow button to highlight the automatic calibration option you want. Then press the ▶ arrow button to select this option. Refer to the table on page 3-36 for more information about automatic calibration options. If a microphone check is unsuccessful, one of the error messages shown to the right appears in the on-screen display, indicating that a successful microphone check is required before automatic calibration, and also the reason the previous check failed. If this occurs, go back to "Connecting the Microphones" on page 3-37 and work your way back to this page. 		<div style="border: 1px solid black; padding: 5px; text-align: center;">MIC CHECK REQUIRED FOR AUTO CALIBRATION</div> <div style="border: 1px solid black; padding: 5px; text-align: center; margin-top: 10px;">NO MICROPHONE DETECTED</div>
2	<p>The following AUTO SPEAKER SETUP messages are displayed before automatic calibration begins:</p> <ul style="list-style-type: none"> The !CAUTION! HIGH AUDIO LEVELS message indicates that the RV-8 generates loud calibration noise signals during automatic calibration. If the signals become too loud, press the ◀ arrow button to cancel automatic calibration. Press the ▶ arrow button to open the next AUTO SPEAKER SETUP menu. The countdown display notifies you that automatic calibration will begin in 10 seconds. The primary reason for the 10 second delay is to give you time to leave the listening space before automatic calibration begins. If you choose to remain in the room, your movements could affect the calibration results. If you leave the room, you can return in about 10 minutes (the calibration procedure should be completed). Press the ▶ arrow button to skip the countdown and begin automatic calibration. The RV-8 automatically activates automatic calibration when the countdown ends. 		



STEP	DISTANCES	DISTANCES & LEVELS	LEVELS
3	<p>The SETTING DISTANCES menu is displayed when the RV-8 calibrates speaker distances.</p> <ul style="list-style-type: none"> During speaker distance calibration, the RV-8 sends calibration noise signals to the Main Zone audio output connectors in the order shown on the SETTING DISTANCES menu. The cursor automatically scrolls downward through speaker calibration parameters, highlighting each parameter while the RV-8 calculates a distance for the corresponding speaker. As it finishes each parameter, the RV-8 enters the calibrated value or an ERROR message to the right of the parameter label. Because of the way low-frequency signals propagate in most listening spaces, automatic speaker distance calibration often produces unreliable results for subwoofers. For this reason, the RV-8 does not send calibration noise signals to the Subwoofer connector during speaker distance calibration. Instead, the RV-8 automatically calibrates the subwoofer distance to the shortest distance of the other speakers. These distances can be manually adjusted. See "PERFORMING MANUAL SPEAKER DISTANCE CALIBRATION" on page 3-54. 		<p>This step does not occur when the AUTO SPEAKER SETUP menu LEVELS option is selected.</p>
4	<p>This step does not occur when the AUTO SPEAKER SETUP menu DISTANCES option is selected.</p>	<p>The SETTING LEVELS menu is displayed when the RV-8 calibrates output levels.</p> <ul style="list-style-type: none"> During speaker levels calibration, the RV-8 sends calibration noise signals to the Main Zone audio output connectors in the order shown on the SETTING LEVELS menu. The cursor automatically scrolls downward through speaker calibration parameters, highlighting each parameter while the RV-8 calculates an output level for the corresponding speaker. As it finishes each parameter, the RV-8 enters the calibrated value or an ERROR message to the right of the parameter label. 	

PERFORMING AUTOMATIC CALIBRATION (continued)

STEP	DISTANCES	DISTANCES & LEVELS	LEVELS																																										
5	<table border="1"> <thead> <tr> <th colspan="2">AUTO DISTANCES</th> </tr> </thead> <tbody> <tr><td>FRONT LEFT</td><td>12.0ft</td></tr> <tr><td>CENTER</td><td>10.5ft</td></tr> <tr><td>FRONT RIGHT</td><td>12.0ft</td></tr> <tr><td>SIDE RIGHT</td><td>4.5ft</td></tr> <tr><td>REAR RIGHT</td><td>ERROR</td></tr> <tr><td>REAR LEFT</td><td>6.0ft</td></tr> <tr><td>SIDE LEFT</td><td>4.5ft</td></tr> <tr><td>SUBWOOFER</td><td>N/A</td></tr> </tbody> </table> <p style="text-align: center;">FRONT LEFT</p> <p style="text-align: center;"><i>Refer to the table on page 3-52 for information about all possible speaker calibration messages.</i></p> <p>If there was a DISTANCES calibration error, an AUTO DISTANCES menu automatically displays.</p> <ul style="list-style-type: none"> A value indicates that no errors occurred during the calibration procedure. An ERROR message indicates that a value was calculated, but at least one error occurred during the calibration procedure. Press the ▲ or ▼ arrow button to highlight the speaker calibration parameter you want. Then press the ▶ button to view more detailed results for the selected speaker. A message similar to the one shown above will display. Refer to the table on page 3-52 for information about all possible speaker calibration messages. This menu is displayed, but not user accessible during Auto Distance Calibration or after Auto Calibration. 	AUTO DISTANCES		FRONT LEFT	12.0ft	CENTER	10.5ft	FRONT RIGHT	12.0ft	SIDE RIGHT	4.5ft	REAR RIGHT	ERROR	REAR LEFT	6.0ft	SIDE LEFT	4.5ft	SUBWOOFER	N/A	<table border="1"> <thead> <tr> <th colspan="2">AUTO SPEAKER SETUP</th> </tr> </thead> <tbody> <tr><td>DISTANCES</td><td>OK</td></tr> <tr><td>LEVELS</td><td>ERROR</td></tr> </tbody> </table> <p style="text-align: center;">AUTO VALUES APPLIED PRESS → TO VIEW DETAILS</p> <p>When the RV-8 is finished calibrating speaker distances and output levels, if there was a calibration error, the AUTO SPEAKER SETUP screen is displayed, indicating the results for each calibration procedure.</p> <ul style="list-style-type: none"> An OK message indicates that no errors occurred during the calibration procedure. An ERROR message indicates that values were calculated, but at least one error occurred during calibration. Press the ▲ or ▼ arrow button to highlight the desired calibration procedure. DISTANCES displays the AUTO DISTANCES screen shown in the left column of this table. LEVELS displays the AUTO LEVELS screen shown in the right column of this table. Press the ▶ arrow button to select this procedure. Refer to the instructions in the appropriate column to view more detailed results for each individual speaker. If a speaker is highlighted in either the Distances or Levels menus, the speaker name is displayed. 	AUTO SPEAKER SETUP		DISTANCES	OK	LEVELS	ERROR	<table border="1"> <thead> <tr> <th colspan="2">AUTO LEVELS</th> </tr> </thead> <tbody> <tr><td>FRONT LEFT</td><td>-2.0dB</td></tr> <tr><td>CENTER</td><td>ERROR</td></tr> <tr><td>FRONT RIGHT</td><td>-2.0dB</td></tr> <tr><td>SIDE RIGHT</td><td>-4.5dB</td></tr> <tr><td>REAR RIGHT</td><td>-3.0dB</td></tr> <tr><td>REAR LEFT</td><td>-3.0dB</td></tr> <tr><td>SIDE LEFT</td><td>-4.5dB</td></tr> <tr><td>SUBWOOFER</td><td>N/A</td></tr> </tbody> </table> <p style="text-align: center;">FRONT LEFT</p> <p style="text-align: center;"><i>Refer to the table on page 3-52 for information about all possible speaker calibration messages.</i></p> <p>If there was a LEVELS calibration error, an AUTO LEVELS menu automatically displays.</p> <ul style="list-style-type: none"> A value indicates that no errors occurred during the calibration procedure. An ERROR message indicates that a value was calculated, but at least one error occurred during the calibration procedure. Press the ▲ or ▼ arrow button to highlight the desired speaker calibration parameter. Then, press the ▶ arrow button to view more detailed results for the selected speaker. A message similar to the one shown above will display. Refer to the table on page 3-52 for information about all possible speaker calibration messages. This menu is displayed, but not user accessible during Auto Distance Calibration or after Auto Calibration. 	AUTO LEVELS		FRONT LEFT	-2.0dB	CENTER	ERROR	FRONT RIGHT	-2.0dB	SIDE RIGHT	-4.5dB	REAR RIGHT	-3.0dB	REAR LEFT	-3.0dB	SIDE LEFT	-4.5dB	SUBWOOFER	N/A
AUTO DISTANCES																																													
FRONT LEFT	12.0ft																																												
CENTER	10.5ft																																												
FRONT RIGHT	12.0ft																																												
SIDE RIGHT	4.5ft																																												
REAR RIGHT	ERROR																																												
REAR LEFT	6.0ft																																												
SIDE LEFT	4.5ft																																												
SUBWOOFER	N/A																																												
AUTO SPEAKER SETUP																																													
DISTANCES	OK																																												
LEVELS	ERROR																																												
AUTO LEVELS																																													
FRONT LEFT	-2.0dB																																												
CENTER	ERROR																																												
FRONT RIGHT	-2.0dB																																												
SIDE RIGHT	-4.5dB																																												
REAR RIGHT	-3.0dB																																												
REAR LEFT	-3.0dB																																												
SIDE LEFT	-4.5dB																																												
SUBWOOFER	N/A																																												

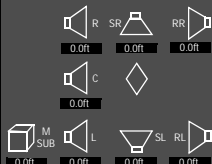
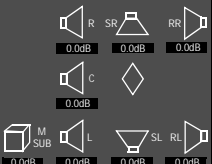
STEP	DISTANCES	DISTANCES & LEVELS	LEVELS																																																
6	<div style="display: flex; justify-content: space-between;"> <div style="border: 1px solid black; padding: 5px; width: 45%;"> <p>SET DISTANCES</p> <p>AUTO DISTANCES</p> <p>ORIGINAL DISTANCES</p>  </div> <div style="border: 1px solid black; padding: 5px; width: 45%;"> <p>AUTO DISTANCES</p> <table border="1"> <tr><td>FRONT LEFT</td><td>12.0ft</td></tr> <tr><td>CENTER</td><td>10.5ft</td></tr> <tr><td>FRONT RIGHT</td><td>12.0ft</td></tr> <tr><td>SIDE RIGHT</td><td>4.5ft</td></tr> <tr><td>REAR RIGHT</td><td>ERROR</td></tr> <tr><td>REAR LEFT</td><td>6.0ft</td></tr> <tr><td>SIDE LEFT</td><td>4.5ft</td></tr> <tr><td>SUBWOOFER</td><td>N/A</td></tr> </table> </div> </div> <p>Use the SET DISTANCES menu to select the desired speaker distances.</p> <ol style="list-style-type: none"> Press the ◀ arrow button to return to the SET DISTANCES menu. Press the ▲ or ▼ arrow button to toggle between calibrated speaker distances (AUTO) and original speaker distances. The speaker graphics at the bottom of the menu update to indicate the selected values. Press the ▶ button to apply the selected values. A confirmation message is displayed to indicate the applied values. Press the ◀ button twice in succession to return to the SPEAKER SETUP menu. <p>The AUTO DISTANCES menu is only accessible after the DISTANCES & LEVELS calibration is performed as a combined procedure.</p>	FRONT LEFT	12.0ft	CENTER	10.5ft	FRONT RIGHT	12.0ft	SIDE RIGHT	4.5ft	REAR RIGHT	ERROR	REAR LEFT	6.0ft	SIDE LEFT	4.5ft	SUBWOOFER	N/A	<div style="display: flex; justify-content: space-between;"> <div style="border: 1px solid black; padding: 5px; width: 45%;"> <p>AUTO SPEAKER SETUP</p> <p>DISTANCES OK</p> <p>LEVELS ERROR</p> <p>AUTO VALUES APPLIED</p> <p>PRESS → TO VIEW DETAILS</p> </div> <div style="border: 1px solid black; padding: 5px; width: 45%;"> <p>AUTO DISTANCES*</p> <table border="1"> <tr><td>FRONT LEFT</td><td>12.0ft</td></tr> <tr><td>CENTER</td><td>10.5ft</td></tr> <tr><td>FRONT RIGHT</td><td>12.0ft</td></tr> <tr><td>SIDE RIGHT</td><td>4.5ft</td></tr> <tr><td>REAR RIGHT</td><td>ERROR</td></tr> <tr><td>REAR LEFT</td><td>6.0ft</td></tr> <tr><td>SIDE LEFT</td><td>4.5ft</td></tr> <tr><td>SUBWOOFER</td><td>N/A</td></tr> </table> </div> </div> <p>Use the AUTO SPEAKER SETUP menu to select speaker distances or levels.</p> <ol style="list-style-type: none"> Press the ◀ arrow button to return to the AUTO SPEAKER SETUP results screen. To select the other calibration procedure, follow the instructions in Step 5. Otherwise, press the ◀ button to return to the SPEAKER SETUP menu. <p>* <i>Note: The AUTO DISTANCES screen is shown above as an example. The AUTO LEVELS screen can be substituted.</i></p>	FRONT LEFT	12.0ft	CENTER	10.5ft	FRONT RIGHT	12.0ft	SIDE RIGHT	4.5ft	REAR RIGHT	ERROR	REAR LEFT	6.0ft	SIDE LEFT	4.5ft	SUBWOOFER	N/A	<div style="display: flex; justify-content: space-between;"> <div style="border: 1px solid black; padding: 5px; width: 45%;"> <p>SET LEVELS</p> <p>AUTO LEVELS</p> <p>ORIGINAL LEVELS</p>  </div> <div style="border: 1px solid black; padding: 5px; width: 45%;"> <p>AUTO LEVELS</p> <table border="1"> <tr><td>FRONT LEFT</td><td>-2.0dB</td></tr> <tr><td>CENTER</td><td>ERROR</td></tr> <tr><td>FRONT RIGHT</td><td>-2.0dB</td></tr> <tr><td>SIDE RIGHT</td><td>-4.5dB</td></tr> <tr><td>REAR RIGHT</td><td>-3.0dB</td></tr> <tr><td>REAR LEFT</td><td>-3.0dB</td></tr> <tr><td>SIDE LEFT</td><td>-4.5dB</td></tr> <tr><td>SUBWOOFER</td><td>N/A</td></tr> </table> </div> </div> <p>Use the SET LEVELS menu to select the desired speaker levels.</p> <ol style="list-style-type: none"> Press the ◀ arrow button to return to the SET LEVELS menu. <ul style="list-style-type: none"> Press the ▲ and ▼ arrow buttons to toggle between calibrated output levels (AUTO) and original output levels. The speaker graphics at the bottom of the menu update to indicate the selected values. Press the ▶ arrow button to apply the selected values. A confirmation message is displayed to indicate the applied values. Press the ◀ arrow button twice in succession to return to the SPEAKER SETUP menu. <p>The AUTO LEVELS menu is only accessible after the DISTANCES & LEVELS calibration is performed as a combined procedure.</p>	FRONT LEFT	-2.0dB	CENTER	ERROR	FRONT RIGHT	-2.0dB	SIDE RIGHT	-4.5dB	REAR RIGHT	-3.0dB	REAR LEFT	-3.0dB	SIDE LEFT	-4.5dB	SUBWOOFER	N/A
FRONT LEFT	12.0ft																																																		
CENTER	10.5ft																																																		
FRONT RIGHT	12.0ft																																																		
SIDE RIGHT	4.5ft																																																		
REAR RIGHT	ERROR																																																		
REAR LEFT	6.0ft																																																		
SIDE LEFT	4.5ft																																																		
SUBWOOFER	N/A																																																		
FRONT LEFT	12.0ft																																																		
CENTER	10.5ft																																																		
FRONT RIGHT	12.0ft																																																		
SIDE RIGHT	4.5ft																																																		
REAR RIGHT	ERROR																																																		
REAR LEFT	6.0ft																																																		
SIDE LEFT	4.5ft																																																		
SUBWOOFER	N/A																																																		
FRONT LEFT	-2.0dB																																																		
CENTER	ERROR																																																		
FRONT RIGHT	-2.0dB																																																		
SIDE RIGHT	-4.5dB																																																		
REAR RIGHT	-3.0dB																																																		
REAR LEFT	-3.0dB																																																		
SIDE LEFT	-4.5dB																																																		
SUBWOOFER	N/A																																																		

PERFORMING AUTOMATIC CALIBRATION (continued)

Message	Description	Troubleshooting
(SPEAKER) OK	The RV-8 successfully calibrated the value for the selected speaker without error.	<ul style="list-style-type: none"> N/A
(SPEAKER) SPEAKER IS NOT ENABLED	The selected speaker is not present in the speaker setup.	<ul style="list-style-type: none"> Set the corresponding CUSTOM or THX SETUP menu parameter to include the selected speaker in the speaker setup. (The RV-8 only calibrates values for speakers that are included in the speaker setup.)
(SPEAKER) SPEAKER OUT OF PHASE	The microphones detected out-of-phase calibration noise signals, but the calibrated value is still accurate.	<ul style="list-style-type: none"> Examine speaker/associated amplifier connections to ensure that speaker wires are not crossed. Dipolar speakers could cause this error. However, the RV-8 does not report this error unless at least half of the microphones detect out-of-phase calibration noise signals. Reflections from room objects could cause this error. Drivers intentionally wired out-of-phase could cause this error.
(SPEAKER) SIGNAL TOO LOW	The microphones detected calibration noise signals at an unusually low level.	<ul style="list-style-type: none"> The microphones might be positioned more than 30 feet (9.14m) from the selected speaker or in a location where echoes obscure calibration noise signals. Refer to the placement examples on pages 3-40 to 3-44 to confirm that the microphones are appropriately positioned for automatic calibration. Examine microphone input connections to ensure that the microphones are properly connected to the RV-8 and that microphone cable plugs are fully inserted for a solid connection.
(SPEAKER) UNABLE TO CALCULATE	The microphones did not detect calibration noise signals or the RV-8 could not calculate a value.	<ul style="list-style-type: none"> Refer to the microphone placement examples on pages 3-41 to 3-45 to confirm that the microphones are appropriately positioned for automatic calibration. Examine microphone input connections to ensure that the microphones are properly connected to the RV-8 and that microphone cable plugs are fully inserted for a solid connection.
(SPEAKER) MAY NOT BE ACCURATE	One or more microphones did not detect calibration noise signals at a reasonable level. The calibrated value could be inaccurate.	<ul style="list-style-type: none"> Refer to the microphone placement examples on pages 3-41 to 3-45 to confirm that the microphones are appropriately positioned for automatic calibration.
(SPEAKER) SPKR OUTPUT TOO HIGH	The microphones detected calibration noise signals at an unusually high level.	<ul style="list-style-type: none"> Decrease associated amplifier volume levels – including (if applicable) powered subwoofer amplifiers. The microphones may be positioned too close (within 2 feet [0.61m]) of the selected speaker. Refer to the microphone placement examples on pages 3-41 to 3-45 to confirm that the microphones are appropriately positioned for automatic calibration.
(SPEAKER) SPKR OUTPUT TOO LOW	The microphones detected calibration noise signals at an unusually low level.	<ul style="list-style-type: none"> Increase associated amplifier volume levels – including (if applicable) powered subwoofer amplifiers. The microphones may be positioned too far away (more than 30 feet [9.14m]) from the selected speaker. See the microphone placement examples on pages 3-41 to 3-45 to confirm that the microphones are appropriately positioned for automatic calibration.

MANUAL CALIBRATION

SETUP ▶ **SPEAKERS** ▶ **MANUAL**

Selecting the SPEAKER SETUP menu MANUAL option displays the MANUAL SPEAKER SETUP menu, to manually calibrate speaker distances and output levels. The table below indicates available manual calibration options.

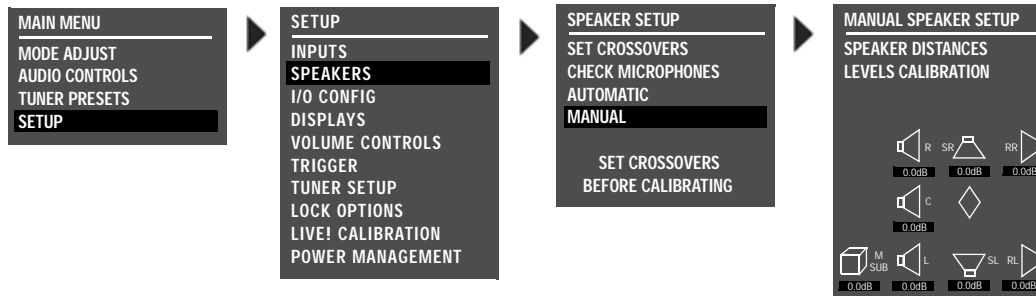

Manual Options	Details
SPEAKER DISTANCES	<ul style="list-style-type: none"> Provides manual calibration and individual adjustment of speaker distances.
INTERNAL NOISE TEST	<ul style="list-style-type: none"> Provides manual calibration and individual adjustment of output levels. Automatically sends an internal calibration noise signal to each Main Zone audio output connector, allowing for simultaneous output level adjustment.
EXTERNAL NOISE TEST	<ul style="list-style-type: none"> Provides manual calibration and individual adjustment of output levels. Requires an external calibration source such as an audio calibration disc. Activates an appropriate listening mode based on the current Main Zone input source.
BASS PEAK LIMITERS	<ul style="list-style-type: none"> Provides amplitude limits for low-frequency signals sent to the Main Zone audio output connector labeled Subwoofer, and low-frequency signals redirected to other Main Zone audio output connectors. Protects speakers against input sources that produce low-frequency signal peaks.

PERFORMING MANUAL SPEAKER DISTANCE CALIBRATION

SETUP ► SPEAKERS ► MANUAL ► SPEAKER DISTANCES

Selecting the MANUAL SPEAKER SETUP menu SPEAKER DISTANCES option displays the SPEAKER DISTANCES menu, to manually calibrate speaker distances.

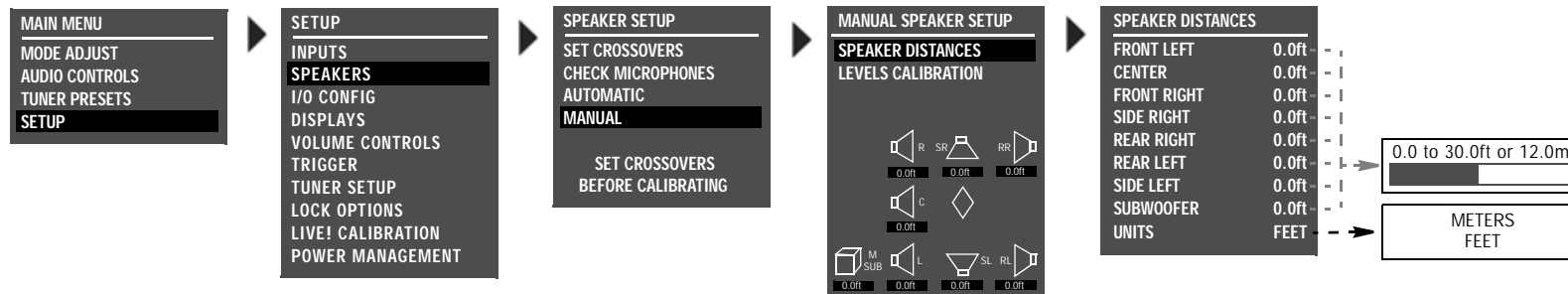

To manually calibrate speaker distances:

1. Follow the menu path shown above to select MANUAL SPEAKER SETUP ► SPEAKER DISTANCES. The SPEAKER DISTANCES menu shown above will open in the on-screen display.
2. Press the ▲ or ▼ arrow buttons to highlight the desired speaker distance parameter. Then, press the ► arrow button to select the highlighted speaker distance parameter.

3. To determine the appropriate speaker distance, measure the distance between the primary listening position and the front of the speaker.

For example, when the FRONT LEFT parameter is selected, measure the distance between the primary listening position and the front of the front left speaker (connected to the Main Zone audio output connector labeled Front L).

4. When the speaker distance has been measured, press the ▲ and ▼ arrow buttons to set the parameter to the closest available value.

PERFORMING MANUAL OUTPUT LEVEL CALIBRATION

SETUP ▶ SPEAKERS ▶ MANUAL ▶ LEVELS CALIBRATION

Selecting the MANUAL SPEAKER SETUP menu LEVELS CALIBRATION option displays the LEVELS CALIBRATION menu shown below, to manually calibrate output levels.

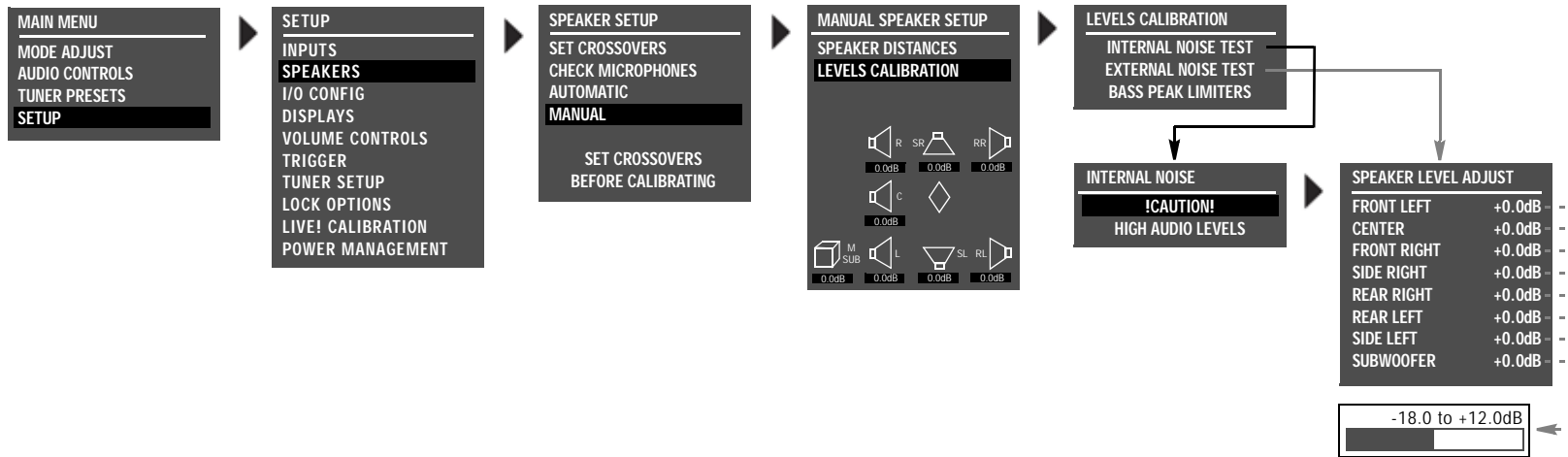

Note the following:

- Use a Sound Pressure Level (SPL) meter to manually calibrate output levels. A SPL meter is a device that measures the relative loudness of the speakers to ensure accurate output level calibration. SPL meters are available from electronic retailers such as Radio Shack.
- Output levels should be calibrated from the primary listening position, placing the SPL meter at the approximate location where the listener’s head will be during listening.
- Output levels for speakers that are not included in the speaker setup cannot be adjusted during the internal noise test. These output levels can be adjusted during the external noise test, but there is no need to do so.

INTERNAL NOISE TEST

SETUP ► SPEAKERS ► MANUAL ► LEVELS CALIBRATION ► INTERNAL NOISE TEST

Opens the INTERNAL NOISE message shown on the previous page, which indicates that the internal noise test generates loud calibration noise signals.

When the INTERNAL NOISE message opens:

- Press the ► arrow button to open the SPEAKER LEVEL ADJUST menu shown on the previous page. When the SPEAKER LEVEL ADJUST menu opens, the internal noise test automatically begins.
- Press the ◀ button to skip the internal noise test.

During the internal noise test, the RV-8 sends calibration noise signals to each speaker in the order shown on the SPEAKER LEVEL ADJUST menu. The cursor automatically scrolls through output level parameters, highlighting each parameter as the RV-8 sends the calibration noise signal to the corresponding speaker. The calibration noise signal is sent to each speaker for about 4 seconds.

Note:

When the internal noise test begins, the RV-8 automatically sets volume level to +0dB. Avoid adjusting the master volume level while the test is in progress, to achieve THX reference levels (75dB).

To manually calibrate output levels during the internal noise test:

1. Set the SPL meter to "C" weighting and "SLOW" response.
2. Place the SPL meter at the primary listening position.
3. Press the ▲ or ▼ arrow button to highlight the desired output level parameter. Then, quickly press the ► button to select this output level parameter. The horizontal bar graph shown on the previous page will open in the on-screen display and automatic scrolling will stop.

Note:

During the internal noise test, it is possible to select an output level parameter just as the cursor is about to automatically scroll to the next parameter, causing the RV-8 to send the calibration noise signal to both speakers. If this occurs, reselect the desired speaker.

4. When the horizontal bar graph opens, press the ▲ or ▼ button to select the output level that achieves a 75dB SPL meter reading from the primary listening position.
5. Press ◀ to close the parameter. The internal noise test will continue and automatic scrolling will resume.
6. Repeat steps 2, 3, 4 and 5 until all desired output levels have been set.





EXTERNAL NOISE TEST

SETUP ▶ SPEAKERS ▶ MANUAL ▶ LEVELS CALIBRATION ▶ EXTERNAL NOISE TEST

Selecting the LEVELS CALIBRATION menu EXTERNAL NOISE TEST option opens the SPEAKER LEVEL ADJUST menu shown on page 3-55, which manually calibrates output levels.

The external noise test requires an external calibration source such as an audio calibration disc. When the external noise test is conducted, the RV-8 activates a listening mode based on the current Main Zone input source. Refer to the table below for more information about external noise test listening mode activation.

When a listening mode is activated during the external noise test, all custom listening mode menu parameter settings are ignored. The listening mode is applied to the current Main Zone input source in its factory-default condition. When the external noise test is finished, the listening mode returns to its custom condition.

INPUT SOURCE	LISTENING MODE
2-Channel	 DOLBY PLII MOVIE,  DOLBY PLIIx MOVIE*
Dolby Digital	 DIGITAL**
DTS(-ES)	 **
5.1-Channel Analog	5.1a BYPASS***

* These listening modes depend on the speaker configuration. Dolby Pro Logic IIx MOVIE will only load when side and rear speakers are present.

**These listening mode names differ depending on the current input source, speaker setup and parameter settings. Refer to the Listening Mode Descriptions section beginning on page 6-4 for more information.

***If the Advanced Menu input is set to "ANALOG BYPASS OFF" the listening mode for the EXTERNAL NOISE TEST is "5.1a STANDARD".

Note:

When the external noise test begins, the RV-8 automatically sets volume level to +0dB. Avoid adjusting the master volume level while the test is in progress, to achieve THX reference levels (75dB).

To manually calibrate output levels during the external noise test:

1. Set the SPL meter to "C" weighting and "SLOW" response.
2. Place the SPL meter at the primary listening position.
3. Press the ▲ or ▼ arrow button to highlight the output level parameter you want. Then press the ▶ button to select this output level parameter.

The horizontal bar graph shown on page 3-55 is displayed.
4. Begin playback of the external calibration source and press the ▲ or ▼ arrow button to select the output level that achieves a 75dB SPL Meter reading.
5. After selecting the output level, press the ◀ arrow button to close the horizontal bar graph.
6. Repeat steps 3, 4 and 5 until you have set all the output levels you want.

SETTING BASS PEAK LIMITERS

SETUP ► SPEAKERS ► MANUAL ► LEVELS CALIBRATION ► BASS PEAK LIMITERS

The BASS PEAK LIMITERS option displays the BASS PEAK LIMITERS menu, to set amplitude limits on low-frequency signals sent to the Main Zone audio output connectors, including the Subwoofer. The RV-8 is equipped with an internal limiter to prevent low-frequency signals from exceeding a designated output level. This is essential for Dolby Digital and DTS(-ES) sources that produce low-frequency signal peaks at much higher output levels than 2-channel sources. In home theaters, there is a danger of the subwoofers and their associated amplifiers overloading when attempting to reproduce low-frequency signals.

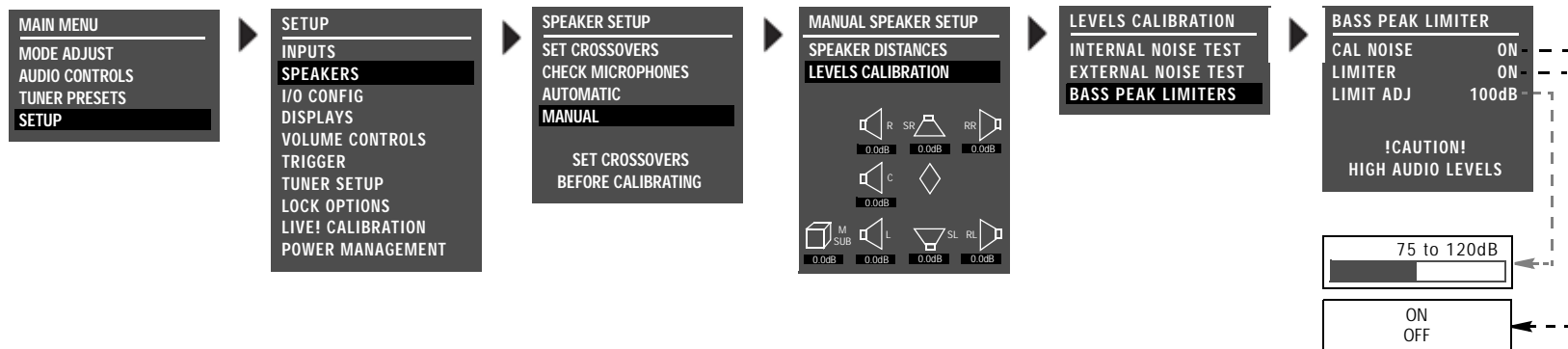

Parameter	Default Setting	Possible Setting
CAL NOISE	ON	ON, OFF
LIMITER	ON	ON, OFF
LIMIT ADJ	100dB	75 to 120dB

Note:

Configure BASS PEAK LIMITERS menu parameter settings whether output levels are automatically or manually calibrated.

CAL NOISE

ON, OFF

SETUP ► SPEAKERS ► MANUAL ► LEVELS CALIBRATION ► BASS PEAK LIMITERS ►
CAL NOISE

Determines whether bass peak limiters are set with an internal or external calibration source.

To set the CAL NOISE parameter:

- Select ON to activate an internal calibration noise signal to set bass peak limiters.
- Select OFF to deactivate the internal calibration noise signal.

Setting bass peak limiters with the calibration noise set to OFF requires an external calibration source such as an audio calibration disc.

LIMITER

ON, OFF

SETUP ▶ SPEAKERS ▶ MANUAL ▶ LEVELS CALIBRATION ▶ BASS PEAK LIMITERS ▶
LIMITER

Limits low-frequency signals sent to the subwoofer or redirected to other speakers.

To set the LIMITER parameter:

- Select ON to restrict the output level of the low-frequency signals to the LIMIT ADJ parameter setting.
- Select OFF to allow an unrestricted signal output level, regardless of the LIMIT ADJ parameter setting.

LIMIT ADJ

75 to 120dB

SETUP ▶ SPEAKERS ▶ MANUAL ▶ LEVELS CALIBRATION ▶ BASS PEAK LIMITERS ▶
LIMITER ADJ

Sets amplitude limits applied to the Subwoofer output connector, and to other Main Zone audio output connectors to which low-frequency signals are redirected.

To set the LIMIT ADJ parameter:

1. Select the LIMIT ADJ parameter.
The parameter initially sets to 75dB.
2. Press the ▲ and ▼ arrow buttons to change the parameter value.
The selected amplitude is applied when the SUB LIMITER parameter is set to ON.

I/O CONFIG

SETUP ▶ I/O CONFIG

The I/O CONFIG option is used to configure the analog audio input connectors as eight (Left/Right) stereo connectors, five (Left/Right) stereo connectors and one 5.1-channel configuration (Front L/R, Center, Subwoofer, Side L/R), or as two stereo connectors and two 5.1-channel configurations.

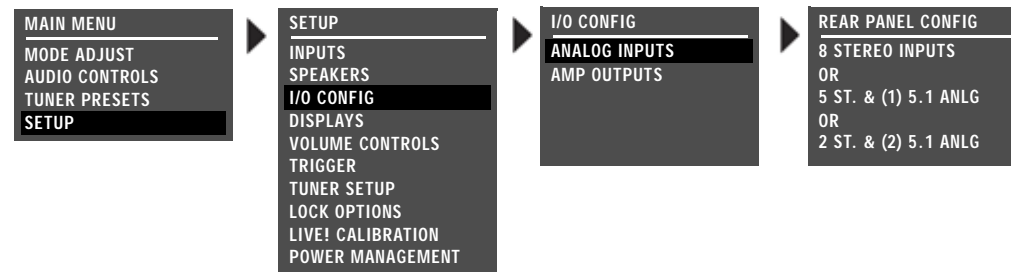

8 STEREO INPUTS

SETUP ▶ I/O CONFIG ▶ ANALOG INPUTS ▶ 8 STEREO INPUTS

Select the 8 STEREO INPUTS option to configure the analog audio input connectors as eight stereo connectors.

When 8 STEREO INPUTS is selected:

- All analog audio input connectors are configured as stereo connectors.
- The 5.1-channel connectors are not available.
- Input sources that were assigned to the 5.1 ANLG (3-5) and 5.1 ANLG (6-8) are reassigned to the stereo connectors labeled 3 and 6, respectively.

5 ST. & (1) 5.1 ANLG

SETUP ▶ I/O CONFIG ▶ ANALOG INPUTS ▶ 5 ST. & (1) 5.1 ANLG

Configures the analog audio input connectors as five stereo connectors and one 5.1-channel configuration.

When the analog audio input connectors are configured as five stereo and one 5.1-channel configuration:

- The connectors labeled 1, 2, 3, 4 and 5 are configured as stereo connectors.
- The connectors labeled 6, 7 and 8 are configured as a 5.1-channel connector. This connector is sent to the Main Zone audio output connectors, as indicated in the table at the bottom of the next column.
- Two-channel sources that were assigned to the stereo connectors labeled 6, 7 and 8 are reassigned to the 5.1-channel connector labeled 5.1 ANLG (6-8). The 5.1-channel connectors should only be used with 5.1-channel analog sources such as DVD-As and SACDs.

2 ST. & (2) 5.1 ANLG

SETUP ▶ I/O CONFIG ▶ ANALOG INPUTS ▶ 2 ST. & (2) 5.1 ANLG

Configures the analog audio input connectors as two stereo connectors and two 5.1-channel configurations.

When the analog audio input connectors are configured as two stereo and two 5.1-channel connectors:

- The connectors labeled 1 and 2 are configured as stereo connectors.
- The connectors labeled 3, 4 and 5 are configured as a 5.1-channel connector, and the connectors labeled 6, 7 and 8 are configured as a 5.1-channel connector. These connectors are sent to the Main Zone audio output connectors as indicated in the table at the bottom of this column.
- 2-channel sources that were assigned to the stereo connectors labeled 3, 4 and 5 are reassigned to the 5.1-channel connector labeled 5.1 ANLG (3-5). Two-channel sources that were assigned to the stereo connectors labeled 6, 7 and 8 are reassigned to the 5.1-channel connector labeled 5.1 ANLG (6-8). The 5.1-channel connectors should only be used with 5.1-channel analog sources such as DVD-As and SACDs.

The 5.1-channel analog audio input connectors are sent to the Main Zone analog audio output connectors, as shown in the table below.

Input Connector	Output Connector
(L)	Front L
(R)	Front R
(C)	Center
(SUB)	Sub
(LS)	Side L and Rear L
(RS)	Side R and Rear R

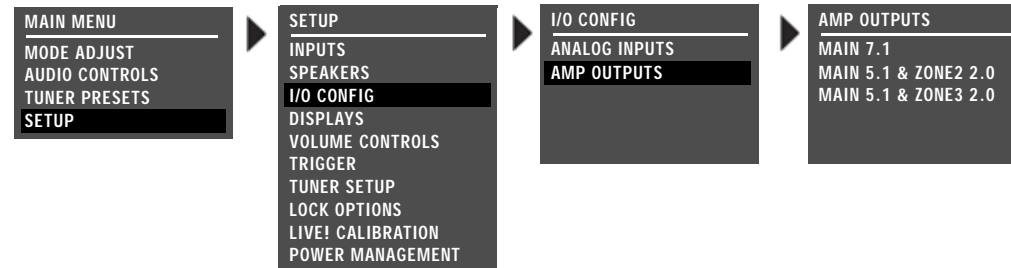
I/O CONFIG (continued)**MAIN 7.1**

SETUP ▶ I/O CONFIG ▶ AMP INPUTS ▶ MAIN 7.1

When set to MAIN 7.1, all of the amplifier outputs on the rear panel will be configured for use in the Main Zone. Outputs 3 and 7 are used for the rear speakers (Rear L/R).

MAIN 5.1 & ZONE2 2.0

SETUP ▶ I/O CONFIG ▶ AMP INPUTS ▶ MAIN 5.1 & ZONE2 2.0

Configures amplifier outputs 3 and 7 for use in Zone 2. Outputs 1, 2, 4, 5 and 6 will be configured for use in the Main Zone. The input source selected for Zone 2 will be output on amplifier outputs 3 and 7.

Note:

If the current speaker configuration is using rear speakers, a warning message will appear alerting the user to the fact that the rear speakers will be disabled for the Main Zone when the 5.1 MAIN & ZONE2 2.0 setting is chosen. Press the right menu button to confirm the change. Pressing any other button will cancel the change.

MAIN 5.1 & ZONE3 2.0

SETUP ▶ I/O CONFIG ▶ AMP INPUTS ▶ MAIN 5.1 & ZONE3 2.0

Configures amplifier outputs 3 and 7 for use in Zone 3. Outputs 1, 2, 4, 5 and 6 will be configured for use in the Main Zone. The input source selected for Zone 3 will be output on amplifier outputs 3 and 7.

Note:

If the current speaker configuration is using rear speakers, a warning message will appear alerting the user to the fact that the rear speakers will be disabled for the Main Zone when the 5.1 MAIN & ZONE3 2.0 setting is chosen. Press the right menu button to confirm the change. Pressing any other button will cancel the change.

DISPLAY SETUP

SETUP ► DISPLAYS

Selecting the SETUP menu DISPLAYS option opens the DISPLAY SETUP menu, which is used to customize the on-screen and front-panel displays, restore audio/video synchronization, and activate and create a custom unit name.

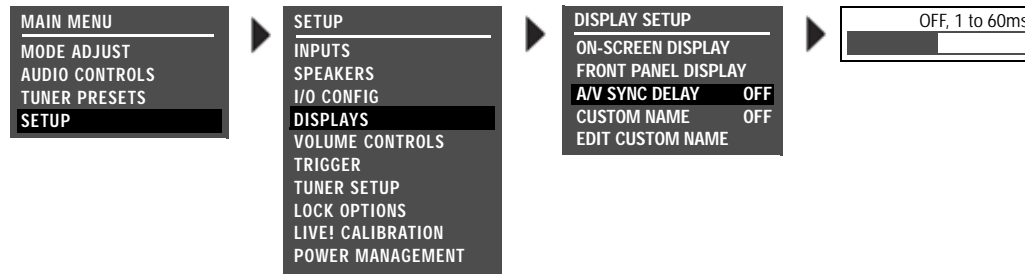

Parameter	Default Setting	Possible Setting
ON-SCREEN DISPLAY	Refer to page 3-64	
FRONT PANEL DISPLAY	Refer to page 3-66	
A/V SYNC DELAY	OFF	OFF, 1 to 60ms
CUSTOM NAME	OFF	ON, OFF
EDIT CUSTOM NAME	N/A	N/A

ON-SCREEN DISPLAY SETUP

SETUP ► DISPLAYS ► ON-SCREEN DISPLAY

Opens the ON-SCREEN DISPLAY menu, which is used to customize the on-screen display.



Parameter	Default Setting	Possible Settings
STATUS	2 SECONDS	ALWAYS ON, 2 SECONDS, ALWAYS OFF
POSITION	TOP	TOP, CENTER, BOTTOM
FORMAT	NTSC	SECAM, PAL, NTSC
BACKGROUND	ON	ON, OFF

STATUS

ALWAYS ON, 2 SECONDS, ALWAYS OFF

SETUP ► DISPLAYS ► ON-SCREEN DISPLAY ► STATUS

Activates and deactivates the on-screen display sent to the Main Zone video output connector. When set to ALWAYS ON, the on-screen display remains on at all times. When set to 2 SECONDS, the on-screen display appears for 2 seconds whenever the input source changes or the RV-8 receives a command. When set to ALWAYS OFF, the on-screen display remains off at all times. It will not reappear until the ON-SCREEN DISPLAY menu STATUS parameter is set to ALWAYS ON or 2 SECONDS.

Note:

When the ON-SCREEN DISPLAY menu STATUS parameter is set to ALWAYS OFF, the on-screen display immediately disappears. Use the front-panel display as a guide to reset the parameter to ALWAYS ON or 2 SECONDS.

POSITION

TOP, CENTER, BOTTOM

SETUP ▶ DISPLAYS ▶ ON-SCREEN DISPLAY ▶ POSITION

Controls the vertical position of the two-line status on the display device screen. When set to TOP, the two-line status appears near the top of the display device screen. When set to CENTER, the two-line status is centered on the display device screen. When set to BOTTOM, the two-line status appears near the bottom of the display device screen. Refer to page 2-28 for more information about the two-line status.

FORMAT

SECAM, PAL, NTSC

SETUP ▶ DISPLAYS ▶ ON-SCREEN DISPLAY ▶ FORMAT

Controls the compatibility between the video input connectors, the video switcher and the display device. Select the setting that is compatible with the source components and display device.

Note:

The FORMAT parameter affects the composite and S-Video output connectors. It does not affect the component video output connector.

BACKGROUND

ON, OFF

SETUP ▶ DISPLAYS ▶ ON-SCREEN DISPLAY ▶ BACKGROUND

Activates and deactivates the menu background. When set to ON, on-screen display menus appear over a solid blue or gray background (depending on the display device). When set to OFF, on-screen display menus appear over the video input signal.

Note:

When the BACKGROUND parameter is set to OFF, the on-screen display will disappear if the display device is using the component video output connector.

FRONT-PANEL DISPLAY SETUP

Opens the FRONT PANEL DISPLAY menu, which is used to customize the front-panel display.



Parameter	Default Setting	Possible Settings
STATUS	ALWAYS ON	ALWAYS ON, 2 SECONDS, ALWAYS OFF
BRIGHTNESS	100%	100%, 75%, 50%, 25%

Note:

When the FRONT PANEL DISPLAY menu STATUS parameter is set to ALWAYS OFF, the front-panel display immediately disappears. Use the on-screen display as a guide to reset the parameter to ALWAYS ON or 2 SECONDS.

STATUS ALWAYS ON, 2 SECONDS, ALWAYS OFF

SETUP ► DISPLAYS ► FRONT PANEL DISPLAY ► STATUS

Activates and deactivates the front-panel display. When set to ALWAYS ON, the front-panel display remains on at all times. When set to 2 SECONDS, the front-panel display appears for 2 seconds whenever the input source changes or the RV-8 receives a command. When set to ALWAYS OFF, the front-panel display remains off at all times.

BRIGHTNESS 100%, 75%, 50%, 25%

SETUP ► DISPLAYS ► FRONT PANEL DISPLAY ► BRIGHTNESS

Controls the brightness of front-panel display characters. When a setting is selected, front-panel display illumination automatically adjusts to the selected brightness.

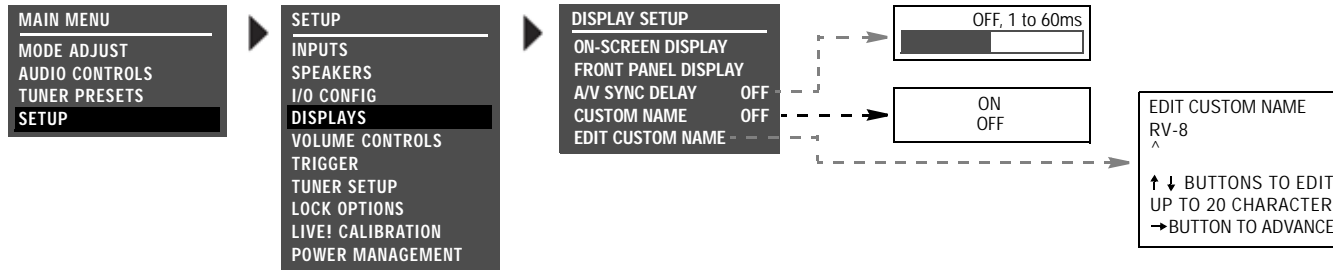

A/V SYNC DELAY

OFF, 1 to 60ms

SETUP ▶ DISPLAYS ▶ A/V SYNC DELAY

Restores audio/video synchronization when using products such as video processors that introduce a video signal delay. This parameter can be used to set an audio signal delay to compensate for the video signal delay.

CUSTOM NAME

ON, OFF

SETUP ▶ DISPLAYS ▶ CUSTOM NAME

Activates the display of a custom unit name, which appears when the RV-8 is activated. When set to ON, the custom name scrolls across the on-screen and front-panel displays when the RV-8 is activated. When set to OFF, the custom name does not appear when the RV-8 is activated. The custom name can be entered in the DISPLAY SETUP menu EDIT CUSTOM NAME menu.

EDIT CUSTOM NAME

SETUP ▶ DISPLAYS ▶ EDIT CUSTOM NAME

Opens the EDIT CUSTOM NAME menu shown below, which can be used to create a custom unit name. When the CUSTOM parameter is set to ON, the custom unit name appears in the on-screen and front-panel displays when the RV-8 is activated.

To customize the name of the RV-8:

1. Follow the EDIT CUSTOM NAME menu path to open the EDIT CUSTOM NAME drop-down menu shown below.
2. When the EDIT CUSTOM NAME drop-down menu opens, press the remote control ▲ and ▼ arrow buttons to change the character above the cursor (^).
3. When the desired character has been selected, press the ▶ arrow button to advance to the next character space. The cursor will automatically wrap to the first character space when the last character space is passed.
4. Repeat steps 2 and 3 to enter the desired custom unit name.
5. When the desired custom unit name has been entered, press the ◀ arrow button to close the EDIT CUSTOM NAME drop-down menu and return to the DISPLAY SETUP menu.

VOLUME CONTROL SETUP

SETUP ► VOLUME CONTROLS

Opens the VOLUME CONTROL SETUP menu, which is used to configure Main Zone, Zone 2, Zone 3, and Headphone volume levels.

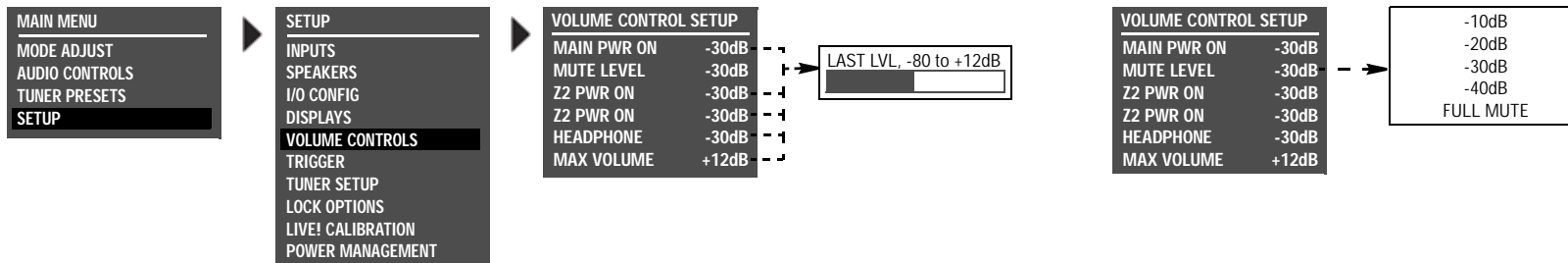

Parameter	Default Setting	Possible Settings
MAIN PWR ON	-30dB	LAST LVL, -80 to +12dB
MUTE LEVEL	-30dB	-40dB, -30dB, -20dB, -10dB, FULL
Z2 PWR ON	-30dB	LAST LVL, -80 to +12dB
Z3 PWR ON	-30dB	LAST LVL, -80 to +12dB
HEADPHONE	-30dB	LAST LVL, -80 to +12dB
MAX VOLUME	-12dB	-80 to +12dB

MAIN PWR ON LAST LVL, -80 to +12dB

SETUP ► VOLUME CONTROLS ► MAIN PWR ON

Sets the Main Zone volume level that will be selected whenever the Main Zone is activated. When set to LAST LVL, the Main Zone activates at the volume level that was last selected in the previous operating session.

MUTE LEVEL -40dB, -30dB, -20dB, -10dB, FULL MUTE

SETUP ► VOLUME CONTROLS ► MUTE LEVEL

Sets the amount of attenuation that occurs in the Main Zone when the front-panel or remote control Mute button is pressed. When set to FULL MUTE, Main Zone volume level will be fully attenuated. Otherwise, Main Zone volume level will be attenuated to the selected level.

Z2 PWR ON LAST LVL, -80 to +12dB

SETUP ► VOLUME CONTROLS ► ZONE PWR ON

Sets the Zone 2 volume level that will be selected whenever Zone 2 is activated. When set to LAST LVL, Zone 2 activates at the volume level that was last selected in the previous operating session. LAST LVL is displayed on power up if the Zone 2 was powered off using the Zone 2 Off button on the remote control or front panel.

Z3 PWR ON

LAST LVL, -80 to +12dB

SETUP ▶ VOLUME CONTROLS ▶ ZONE PWR ON

Sets the Zone 3 volume level that will be selected whenever Zone 3 is activated. When set to LAST LVL, Zone 3 activates at the volume level that was last selected in the previous operating session. LAST LVL is displayed on power up if the Zone 3 was powered off using the Zone 3 Off button on the remote control or front panel.

HEADPHONE

LAST LVL, -80 to +12dB

SETUP ▶ VOLUME CONTROLS ▶ ZONE PWR ON

Sets the Headphone volume level that will be selected whenever headphones are plugged in to the RV-8. When set to LAST LVL, the

headphones will activate at the last volume level that was selected when they were last plugged in. When the headphones are unplugged, the volume will revert to the MAIN PWR ON setting.

MAX VOLUME

-80 TO +12dB

SETUP ▶ VOLUME CONTROLS ▶ MAX VOLUME

Selects the maximum volume level for the Main Zone. When a value is selected, the RV-8 automatically sets Main Zone volume level to the selected value when the current level is higher.

TRIGGER SETUP

SETUP ► TRIGGER

Selecting the SETUP menu TRIGGER option opens the TRIGGER SETUP menu shown to the right, which can be used to configure the trigger output connector labeled 1. The RV-8 rear panel houses two 12V DC trigger output connectors. The connector labeled PWR – the power trigger output connector – is not configurable. It is activated when the RV-8 is activated, and deactivated when the RV-8 is deactivated. The trigger output connector labeled 1 can be configured for remote or program operation.

Parameter	Default Setting	Possible Settings
REMOTE ONLY	ON	ON, OFF
Program Operation	OFF	ON, OFF

REMOTE ONLY ON, OFF

SETUP ► TRIGGER ► REMOTE ONLY

Configures the trigger output connector labeled 1 for remote operation. When set to ON, this connector is configured for remote operation. The remote control play and stop buttons turns the trigger on and off. The RV-8 ignores all other TRIGGER SETUP menu parameter settings. When set to OFF, the trigger output connector labeled 1 is not configured for remote operation. It can be configured for program operation.

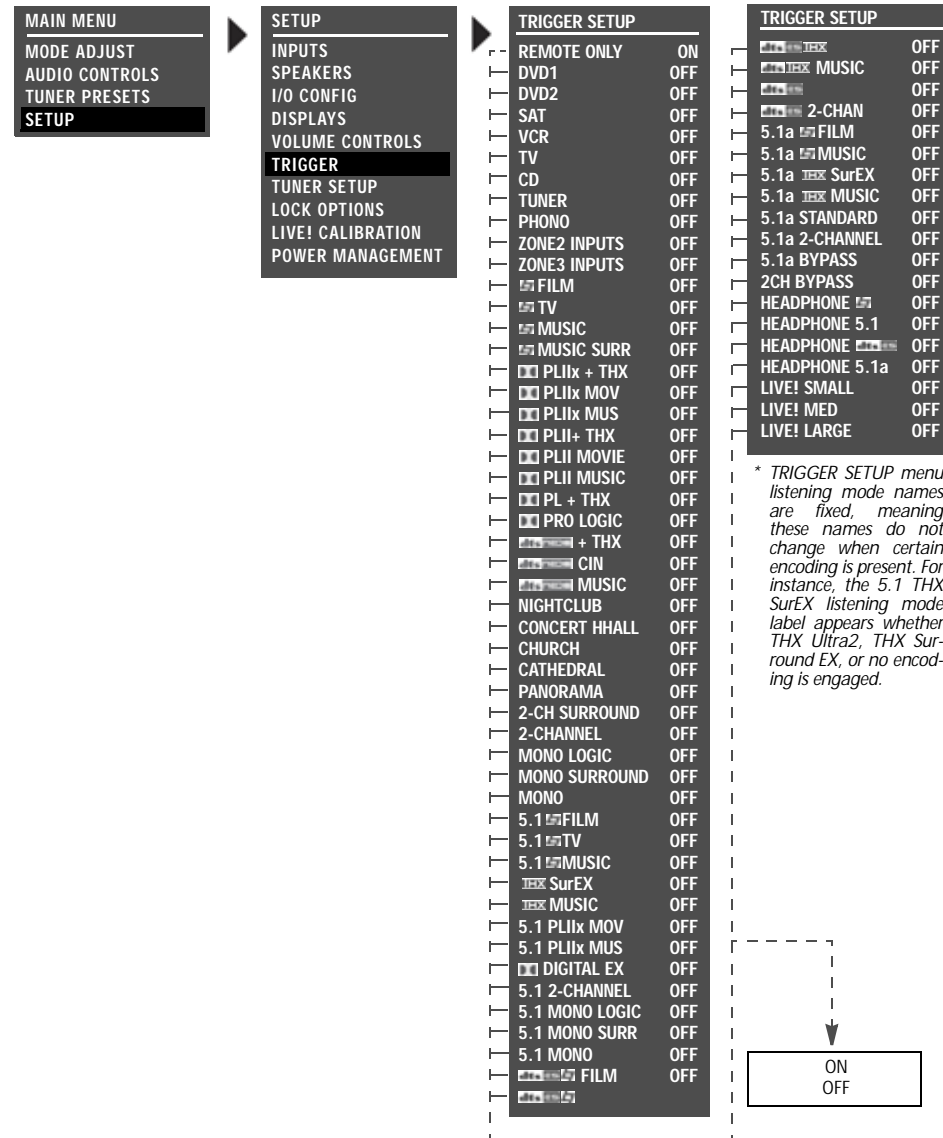

PROGRAM OPERATION PARAMETERS ON, OFF

SETUP ▶ TRIGGER ▶ (PROGRAM OPERATION PARAMETER)

Configure the trigger output connector labeled 1 for program operation. All TRIGGER SETUP menu parameters—except the REMOTE ONLY parameter—are considered program operation parameters. The connector can be associated with multiple inputs and listening modes at the same time.

When the REMOTE ONLY parameter is set to OFF and program operation parameters are set to ON, the trigger output connector labeled 1 is associated with the corresponding Main Zone inputs, Main Zone listening modes or Zone 2 inputs. (The connector cannot be associated with individual Zone 2 inputs; rather, it can be associated with the Zone 2 inputs as a group.) When configured for program operation, the connector is activated when the corresponding inputs and listening modes are selected and deactivated when the corresponding inputs and listening modes are deselected.

Note:

When the CUSTOM menu RESET MODE option is selected to restore the factory default version of the selected listening mode, the corresponding TRIGGER SETUP menu listening mode parameter is automatically set to OFF.

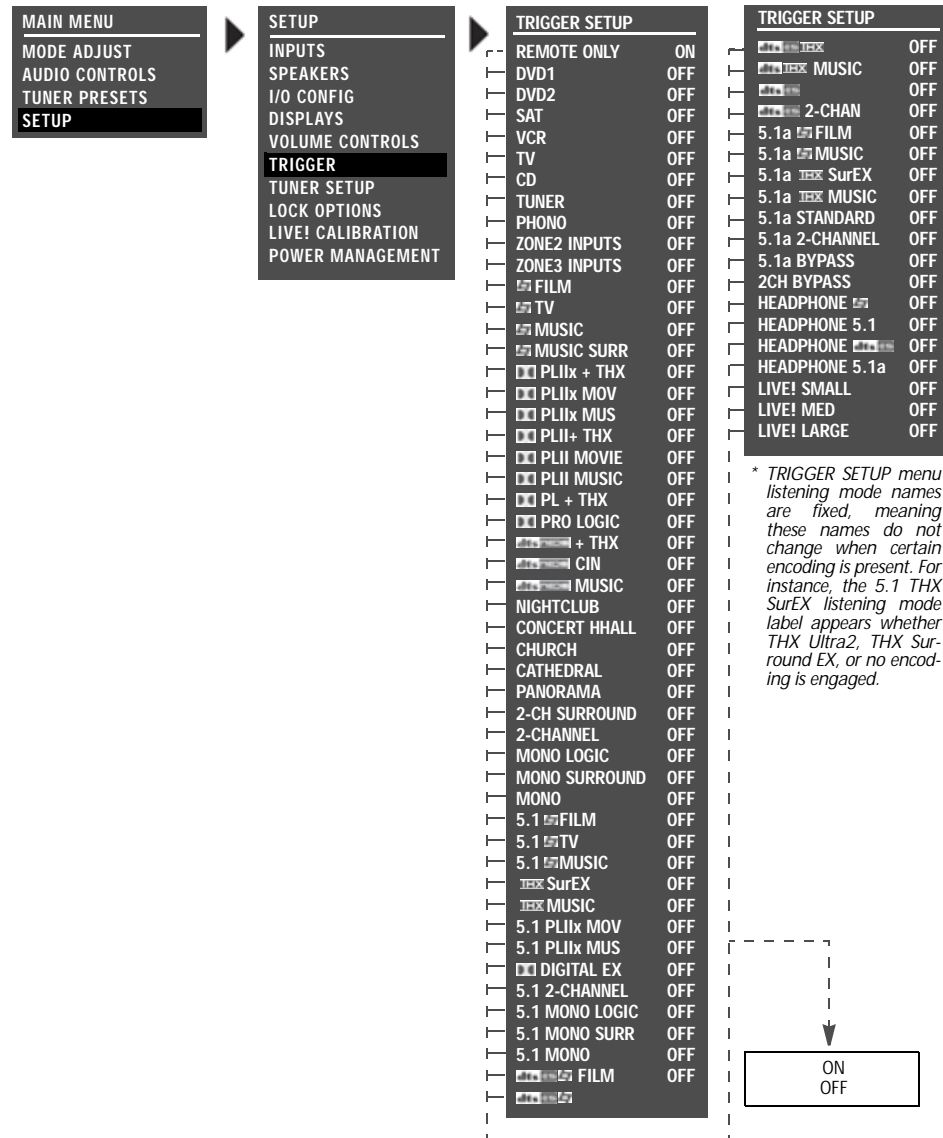

TUNER SETUP

SETUP ► TUNER SETUP

Selecting the SETUP menu TUNER SETUP option opens the TUNER SETUP menu, which is used to configure the AM/FM radio tuner.

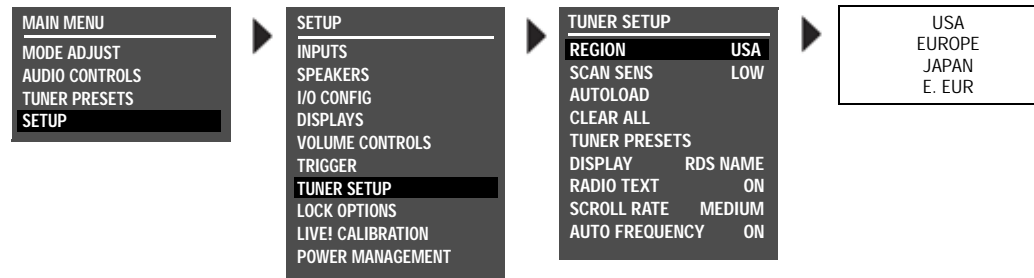

Parameter	Default Setting	Possible Settings
REGION	USA	USA, EUROPE, JAPAN, E. EUR
SCAN SENS	LOW	LOW, MED, HIGH
AUTOLOAD	N/A	N/A
CLEAR ALL	N/A	N/A
TUNER PRESETS	N/A	N/A
DISPLAY	RDS NAME	RDS NAME, PRESET NAME, FREQUENCY
RADIO TEXT	ON	ON, OFF
SCROLL RATE	MEDIUM	SLOW, MEDIUM, FAST
AUTO FREQUENCY	ON	ON, OFF

REGION

USA, EUROPE, JAPAN, E. EUR

SETUP ► TUNER SETUP ► REGION

Sets the tuner region. The four regions are USA, EUROPE, JAPAN and E. EUR. The table on the next page lists the band limits and increments for these regions.

Note:

The tuner user interface will not allow illegal frequencies to be entered. It will always set at the closest valid frequency. For example, if the RV-8 has USA set as the current region, entering 107.8MHz will result in 107.9MHz being the actual tuner frequency. If the value is less than the lowest frequency, it will set it to LO LIMIT for the appropriate region. Likewise, if the dialed value is larger than the highest allowed frequency, it will actually set it to the HI LIMIT for the appropriate region.

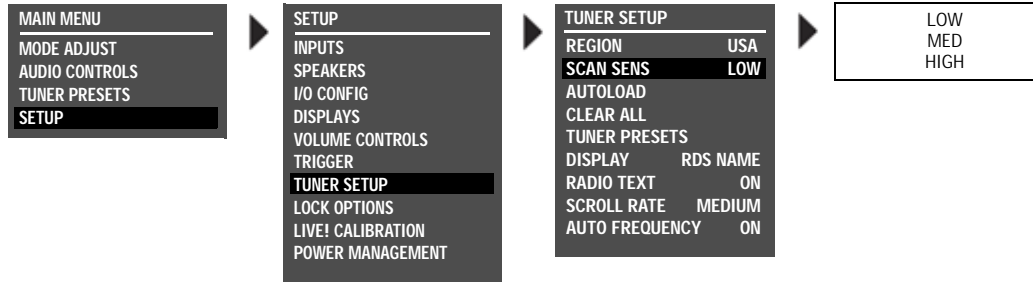

SCAN SENS

LOW, MED, HIGH

SETUP ▶ TUNER SETUP ▶ REGION

Selects the Scan Sensitivity parameter, which can be used to set the threshold the system will use to tune to a new station. The default setting is LOW sensitivity (only the strongest station frequencies will tune). If the LOW setting does not tune enough stations, try the MED (medium) or HIGH settings.

TUNER REGION BAND LIMIT AND INCREMENTS

REGION	FM LO LIMIT	FM HI LIMIT	FM INCREMENT	AM LO LIMIT	AM HI LIMIT	AM INCREMENT
USA	87.90MHZ	107.90MHZ	200 KHZ/.2MHZ	520KHZ	1720KHZ	10KHZ
EUROPE	87.50MHZ	108.00MHZ	50KHZ/.05MHZ	520KHZ	1602KHZ	9KHZ
JAPAN	76.00MHZ	91.00MHZ	50KHZ/.05MHZ	522KHZ	1720KHZ	9KHZ
E. EUR	64.00MHZ	76.00MHZ	50KHZ/.05MHZ	520KHZ	1720KHZ	9KHZ

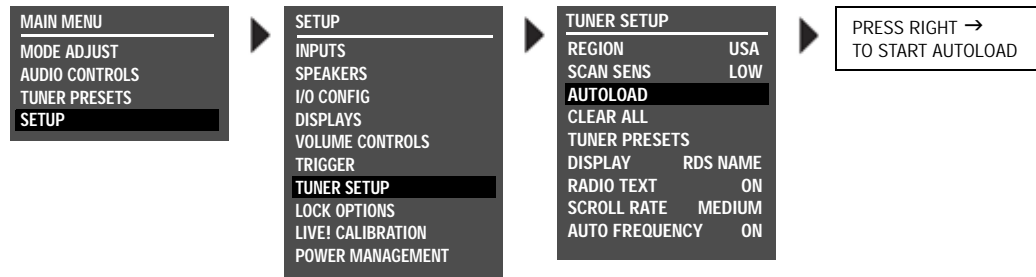
TUNER SETUP (continued)**AUTOLOAD**

SETUP ▶ TUNER SETUP ▶ AUTOLOAD

Automatically scans and stores presets for the currently selected frequency band.

To select the AUTOLOAD option, highlight AUTOLOAD in the TUNER SETUP menu and press the right (▶) arrow. The message "PRESS RIGHT ▶ TO START AUTOLOAD" appears in the on-screen and front-panel displays.

- To cancel the AUTOLOAD command, press the left (◀) arrow.
- AUTOLOAD skips presets with previously stored values and uses the next available preset.
- Once all available stations have been scanned, or if any TUNER button is pressed (including the remote's buttons), AUTOLOAD will stop.
- To autoloading stations from the other frequency band, select that band and restart AUTOLOAD.

Note:

Presets are saved when the unit is powered down. Because the AUTOLOAD function preserves any existing presets, consider using the CLEAR ALL function before using AUTOLOAD. Note that some channels may be repeated in the preset section if AUTOLOAD is used more than once since the last CLEAR ALL.

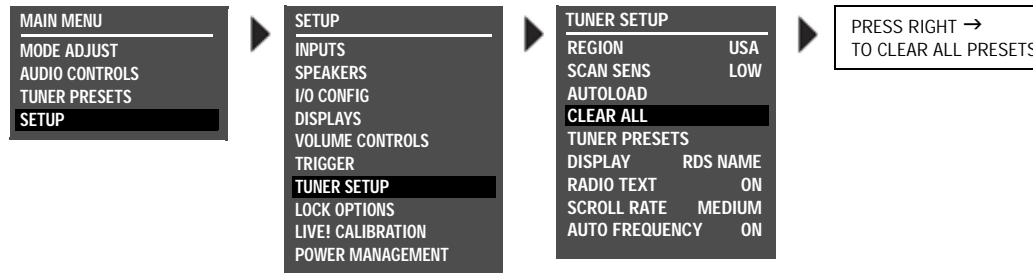

CLEAR ALL

SETUP ▶ TUNER SETUP ▶ CLEAR ALL

Clears all of the presets. When this option is highlighted, press the right (▶) arrow to select. The message “PRESS RIGHT ▶ TO CLEAR ALL PRESETS” will appear in the on-screen and front-panel displays. (Press the left (◀) arrow to cancel the CLEAR ALL command.)

This should be used after all presets have been entered but it is desired to rescan in order to obtain new presets. For example, if you have moved to a new city, it would be necessary to clear all existing presets and scan for local stations.

TUNER PRESETS

SETUP ▶ TUNER SETUP ▶ TUNER PRESETS

This selection provides an alternative access point to the TUNER PRESETS menu. For more information, see “Tuner Presets” on page 5-2.

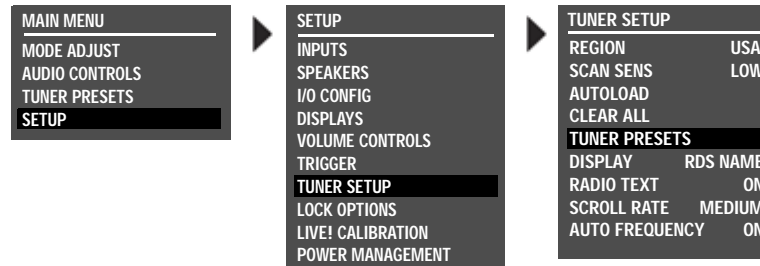

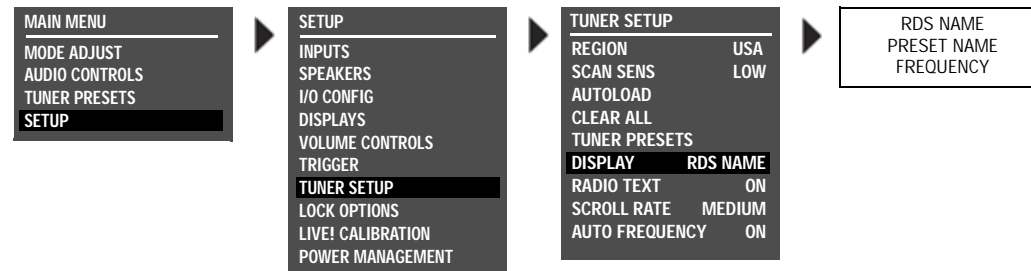
TUNER SETUP (continued)**DISPLAY**

RDS NAME, PRESET NAME, FREQUENCY

SETUP ▶ TUNER SETUP ▶ DISPLAY

Identifies the current channel setting, in the top right corner of the OSD and front panel display. There are three possible selections: RDS NAME, PRESET NAME, and FREQUENCY. The default setting is RDS NAME.

PRESET NAME displays the name given to the preset frequency of the currently selected channel. If the current channel is not a tuner preset, then the channel frequency will be displayed.

RDS NAME displays the station's Program Service (PS) name, which is intended to be used to identify a station or station program. If the RDS information is not available, then the channel frequency will be displayed.

FREQUENCY displays the actual frequency value of the channel selected.

Note:

In the US, some stations broadcast other information in place of the Program Service (PS) name, such as a text messaging feature similar to Radio Text (RT). This can make it difficult to identify the station. You may wish to select PRESET NAME instead of an RSD NAME in this instance.

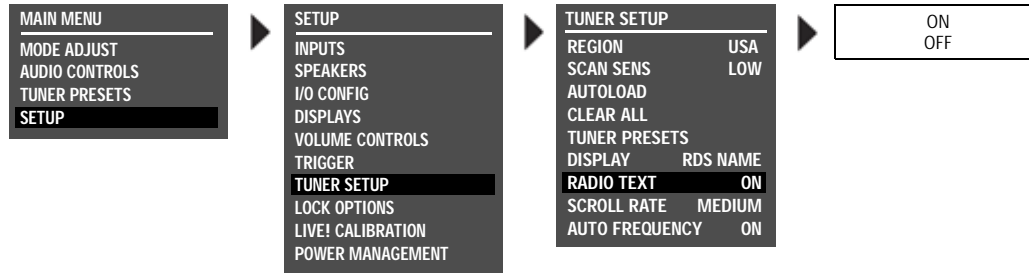

RADIO TEXT ON, OFF

SETUP ▶ TUNER SETUP ▶ RADIO TEXT

Activates the RADIO TEXT (RT) feature. Radio Text is presented as scrolling text in the bottom row of the front-panel and on-screen displays. Radio text can contain up to 64 characters and whatever text the station broadcasts - such as the title and performer of the current song, the station call letters or the station byline. Not all stations broadcast RT. When tuned to a station that broadcasts Radio Text, it will take approximately ten seconds to display the text.

When Radio Text is active, additional information is displayed in the scrolling text. After the RT from the radio station has finished scrolling, double asterisks (**) are displayed, followed by the currently set listening mode, volume level, and tuner frequency. A second set of double asterisks identifies the end of the tuner information and the beginning repeat of the station's Radio Text.

SCROLL RATE SLOW, MEDIUM, FAST

SETUP ▶ TUNER SETUP ▶ SCROLL RATE

Controls the scrolling speed of the Radio Text. The default setting is MEDIUM. For faster text scrolling, select FAST. For slower text scrolling, select SLOW.

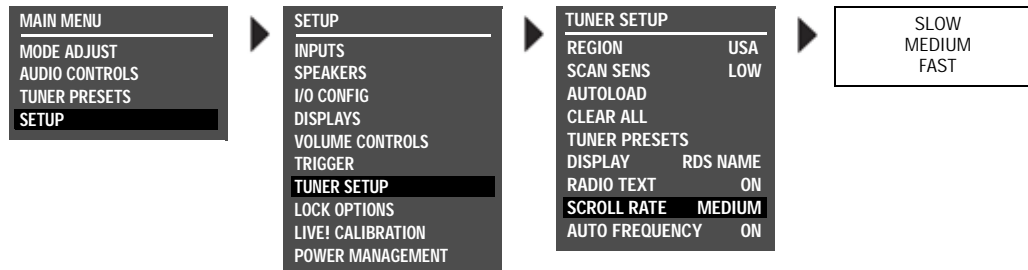

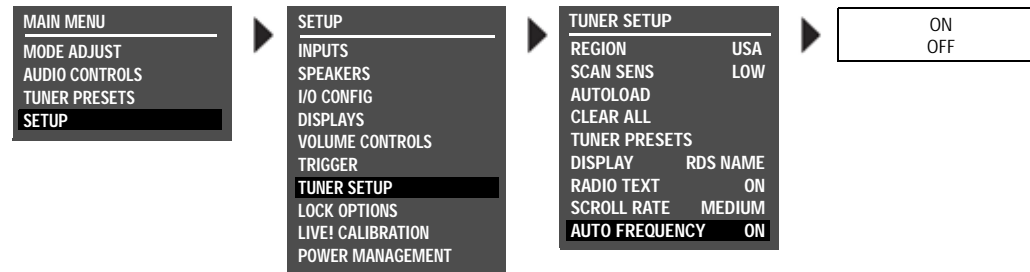
TUNER SETUP (continued)**AUTO FREQUENCY**

ON, OFF

SETUP ▶ TUNER SETUP ▶ **AUTO FREQUENCY**

Checks for alternate frequency broadcasts in case of station drop out or signal fade. The default setting is ON. Many radio stations broadcast on several frequencies simultaneously. When active, AUTO FREQUENCY checks for these alternate frequency broadcasts when signal failure is detected.

If the main frequency drops out and AUTO FREQUENCY is activated, the volume will mute briefly until the alternate broadcast is received.

AUTO FREQUENCY will only switch to a new frequency when the following conditions are met:

- The main frequency signal starts to fade.
- The channel identification of the alternate frequency is an exact match of the currently selected frequency.
- The alternate frequency detected has a stronger signal strength than the currently selected frequency.
- The AUTO FREQUENCY feature is ON.

LOCK OPTIONS

SETUP ▶ LOCK OPTIONS

Selecting the SETUP menu LOCK OPTIONS option opens the LOCK OPTIONS menu, which is used to protect MODE ADJUST, AUDIO CONTROLS and SETUP menu branch parameter settings from accidental changes.

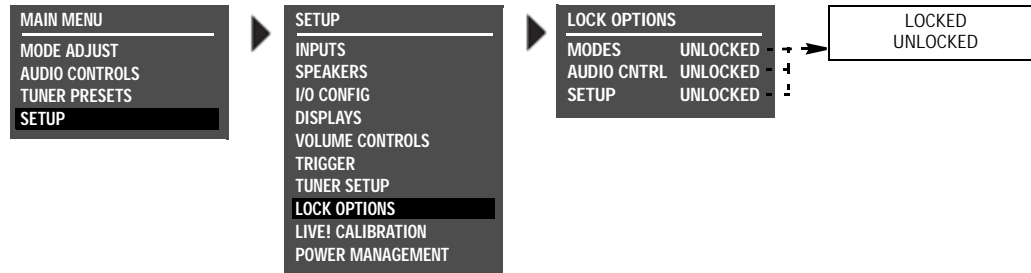

Parameter	Default Setting	Possible Settings
MODES	UNLOCKED	LOCKED, UNLOCKED
AUDIO CNTRL	UNLOCKED	LOCKED, UNLOCKED
SETUP	UNLOCKED	LOCKED, UNLOCKED

MODES

LOCKED, UNLOCKED

SETUP ▶ LOCK OPTIONS ▶ MODES

Controls MODE ADJUST menu branch settings, which includes all listening mode menu settings. When set to LOCKED, these settings cannot be adjusted. When set to UNLOCKED, these settings can be adjusted.

AUDIO CNTRL

LOCKED, UNLOCKED

SETUP ▶ LOCK OPTIONS ▶ AUDIO CNTRL

Controls AUDIO CONTROLS menu branch settings. When set to LOCKED, these settings cannot be adjusted. When set to UNLOCKED, these settings can be adjusted.

SETUP

LOCKED, UNLOCKED

SETUP ▶ LOCK OPTIONS ▶ SETUP

Controls SETUP menu branch settings. When set to LOCKED, these settings cannot be adjusted. When set to UNLOCKED, these settings can be adjusted.

LIVE! CALIBRATION

SETUP ► LIVE! CALIBRATION

LIVE! (Lexicon Intelligent Variable Environment) is a proprietary mode designed to transform the way your listening room sounds. LIVE! uses a combination of microphones and digital signal processing (DSP) to enhance the room acoustics and create the illusion of a larger, more reverberant listening space. LIVE! CALIBRATION must be completed before using any of the LIVE! modes.

Notes:

You should run automatic calibration before running LIVE! CALIBRATION. See page 3-36 for instructions on running an automatic calibration. Any changes to the LEVELS CALIBRATION or CROSSOVER SETUP in the SPEAKER SETUP menu will cause LIVE! to become uncalibrated.

If power is lost during calibration of LIVE!, previous settings may be lost and recalibration of speaker levels and distances, as well as LIVE! is required.

The Bass, Treble, Tilt EQ and Loudness controls do not function when LIVE! is running. While LIVE! is active, the BASS, TREBLE, and TILT EQ parameters are shown in the AUDIO CONTROLS menu as set to 0. The LOUDNESS parameter is shown as set to OFF.

LIVE! requires two microphones, available in a kit from your authorized Lexicon dealer. (If you own the Lexicon four-microphone kit, there is no need to purchase the two-microphone kit. The microphones should be permanently mounted in the listening room. Performing LIVE! CALIBRATION with microphones other than those in the kit can produce undesirable results.

LIVE! requires that a minimum of four speakers (Front L/R, and either side L/R or Rear L/R) be set up and connected to the amplifier. If no

subwoofer is present, the crossover setting of the Front L/R speakers should be set to FULL.

Proper microphone placement, both during calibration and when running LIVE!, is essential to achieving the desired results. Microphone placement instructions and illustrations are included in this section.

The location of the sound source (piano, guitar, voices, etc.) is not critical. LIVE! compensates for sounds that are closer to one microphone or another.

CONNECTING THE MICROPHONES

CAUTION!

- **The Lexicon microphones require careful handling. Dropping or otherwise physically abusing the microphones can cause irreparable damage to the microphone.**
- **The microphone wires also require careful handling. Do not sharply bend the wires or place objects on them.**

1. Make sure the RV-8 is powered off or in standby mode.
2. Connect the Lexicon microphones to the microphone input 1 and 2 connectors on the RV-8 rear panel. Connector 1 is for the left microphone, connector 2 is for the right. Make sure each microphone cable plug is fully inserted for a solid connection.

During the microphone check, the microphones will be referred to as 1 and 2, based on the input connector to which the microphone is connected. You should label the microphones for troubleshooting purposes.

3. Power on the RV-8 or deactivate standby mode.

POSITIONING THE MICROPHONES FOR LIVE!

Refer to the microphone placement examples below to position the microphones for LIVE!

PROPER *microphone positioning for LIVE!*

Position the microphones:

- ✓ On or near opposite side walls
- ✓ Approximately halfway between the front and side speakers
- ✓ At an approximate height between the waist and head of a standing person
- ✓ In a location unobstructed by furniture and other fixtures
- ✓ At least 2 feet (0.61m) from all speakers

Note:

LIVE! can potentially create feedback in the system. The processing is designed to prevent this, but you should avoid placing the microphones too close to speakers.

The illustration to the right provides an example of proper microphone placement during LIVE! calibration and also for permanent location.

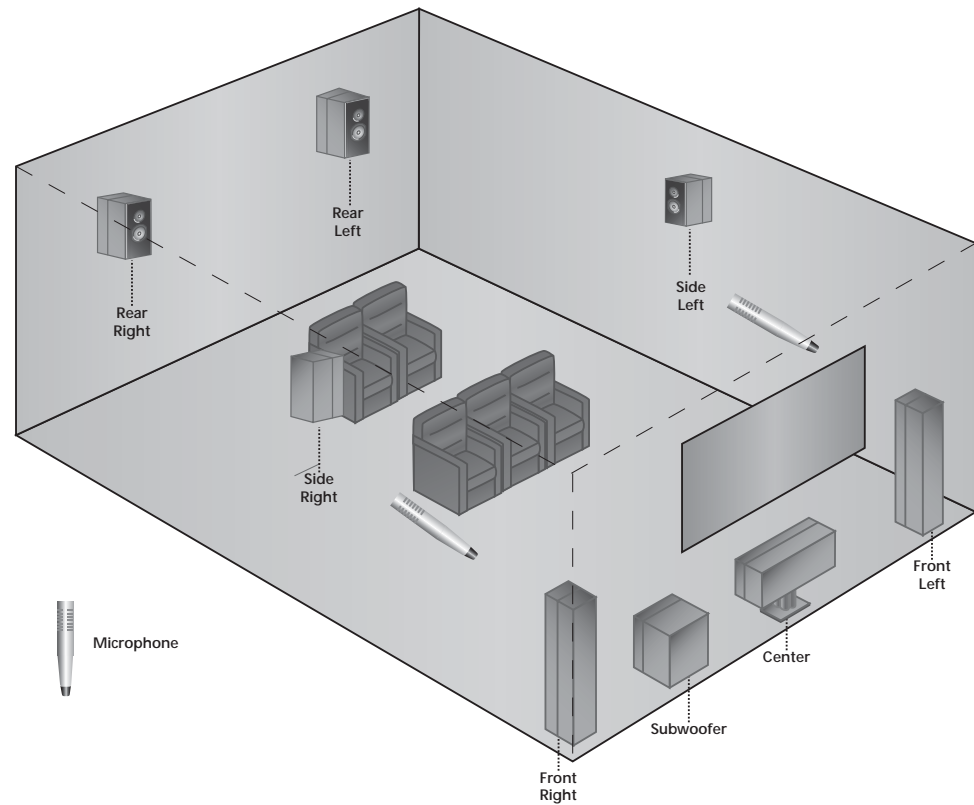

IMPROPER *microphone positioning for LIVE!*

When positioning the microphones, DO NOT:

- ✗ Place the microphones on the front or rear walls
- ✗ Place the microphones near the floor or ceiling
- ✗ Obstruct the microphones with furniture or other fixtures
- ✗ Place the microphones within 2 feet (0.61m) of any speaker

The illustration to the right provides an example of improper microphone placement for LIVE! calibration or for a permanent location.

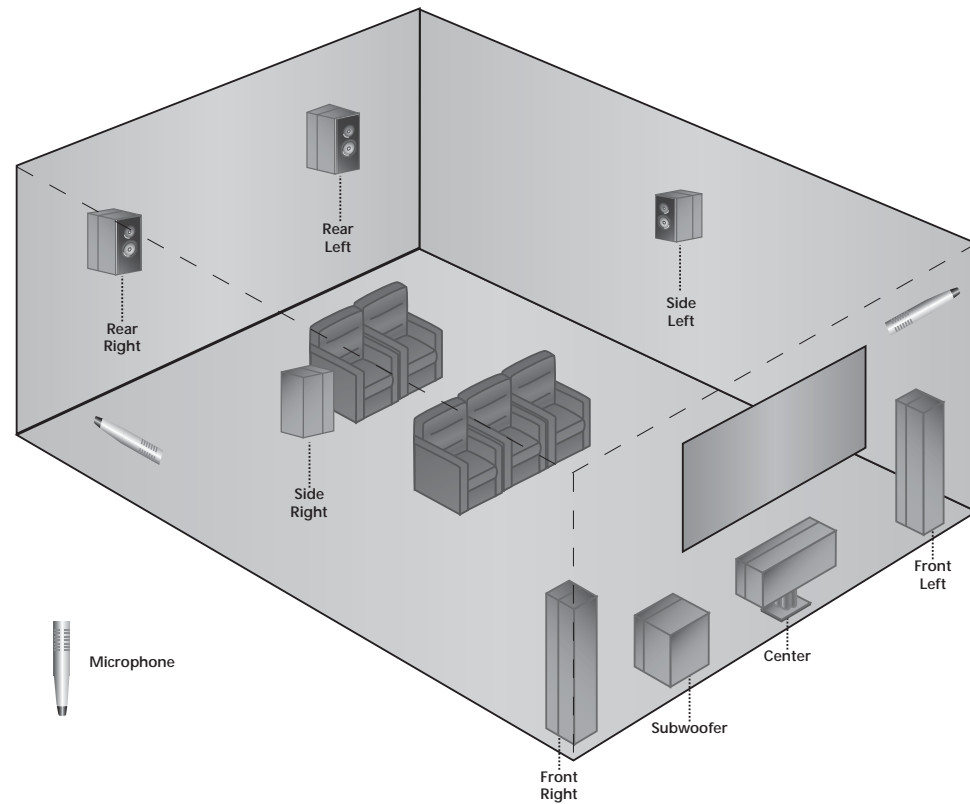

PERFORMING LIVE! CALIBRATION

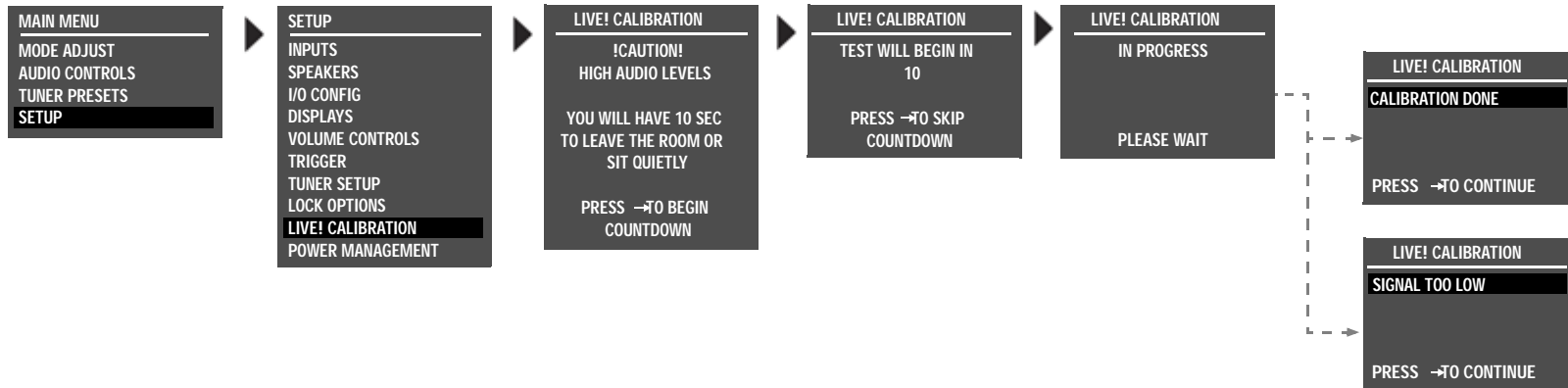

To perform LIVE! calibration:

1. Select SETUP ► LIVE! CALIBRATION as shown above.
2. The !CAUTION! HIGH AUDIO LEVELS message appears to indicate that the RV-8 generates loud calibration noise signals during LIVE! calibration. If the signals become too loud, press the ◀ button to cancel LIVE! calibration. Press the ▶ button to begin calibration.
3. The countdown display notifies you that LIVE! calibration begins in 10 seconds. The primary reason for the 10-second delay is to give you time to leave the listening space before automatic calibration begins. If you choose to remain in the room, your movements could affect the calibration results. If you leave the room, you can return in about 3 minutes (the calibration procedure should be completed). Press the ▶ arrow button to skip the countdown and begin LIVE! calibration. The RV-8 automatically activates LIVE! calibration when the countdown ends.

When the LIVE! calibration is finished, the LIVE CALIBRATION results screen displays one of the following two messages.

- The CALIBRATION DONE message indicates that no errors occurred during the calibration procedure.
 - The SIGNAL TOO LOW message indicates that the microphones failed to pick up sufficient calibration noise signals for calibration to complete.
4. After reading the message, press ► to continue.

If the SIGNAL TOO LOW message appears:

- Examine microphone input connections to ensure that the microphones are properly connected to the RV-8 in microphone inputs 1 and 2 and that microphone cable plugs are fully inserted for a solid connection.
- Examine the speakers and the associated amplifier to ensure that speaker wires are connected and the amplifier is on.
- Run a Microphone Check to determine whether a microphone has been damaged. See page 3-40 for instructions on checking the microphones.

4

Audio Controls

Audio Controls.....	4-2
---------------------	-----

AUDIO CONTROLS

Selecting AUDIO CONTROLS opens the AUDIO CONTROLS menu, which is used to customize the Main Zone audio output connectors and to control the balance of the Zone 2 and Zone 3 audio output connectors. The BASS, TREBLE, TILT EQ, LOUDNESS, BALANCE and FADER parameters affect the Main Zone audio output connectors, including all Main Zone inputs and listening modes, except the 5.1a BYPASS and 2CH BYPASS listening modes. The ZONE2 BALANCE parameter controls the balance of the Zone 2 audio output connectors, including all Zone 2 inputs. The ZONE3 BALANCE parameter controls the balance of the Zone 3 audio output connectors, including all Zone 3 inputs.

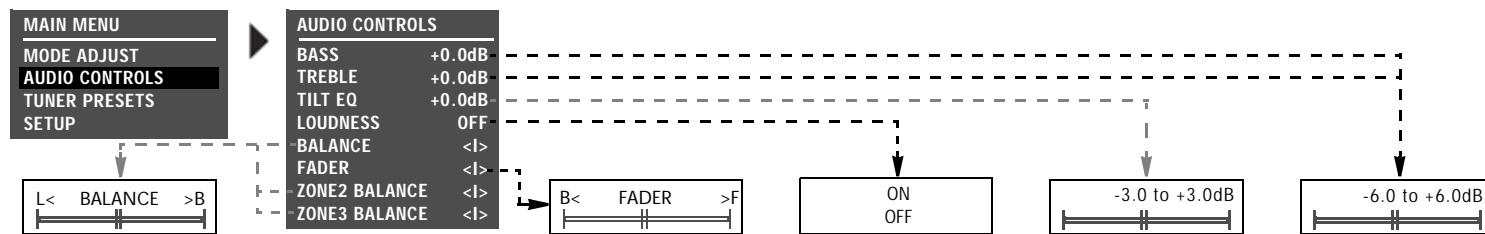

Parameter	Default Setting	Possible Settings
BASS	+0.0dB	-6.0 to +6.0dB
TREBLE	+0.0dB	-6.0 to +6.0dB
TILT EQ	+0.0dB	-3.0 to +3.0dB
LOUDNESS	OFF	ON, OFF
BALANCE	< >	L< to < > to >R
FADER	< >	B< to < > to >F
ZONE2 BALANCE	< >	L< to < > to >R
ZONE3 BALANCE	< >	L< to < > to >R

Note:

When LIVE! is active, the BASS, TREBLE, TILT EQ, and LOUDNESS controls do not function and the corresponding parameters in the AUDIO CONTROLS menu default to +0.0dB. The LOUDNESS parameter defaults to OFF.

BASS

-6.0dB to +6.0dB



Controls the amount of low-frequency boost or cut applied to the Main Zone audio output connectors labeled Front L/R, Center, and Subwoofer. The *BASS Parameter Settings* graph on the next page indicates the frequency response of all BASS parameter settings.

TREBLE

-6.0dB to +6.0dB



Controls the amount of high-frequency boost or cut applied to the Main Zone audio output connectors labeled Front L/R and Center. The *TREBLE Parameter Settings* graph on the next page indicates the frequency response of all TREBLE parameter settings.

BASS Parameter Settings

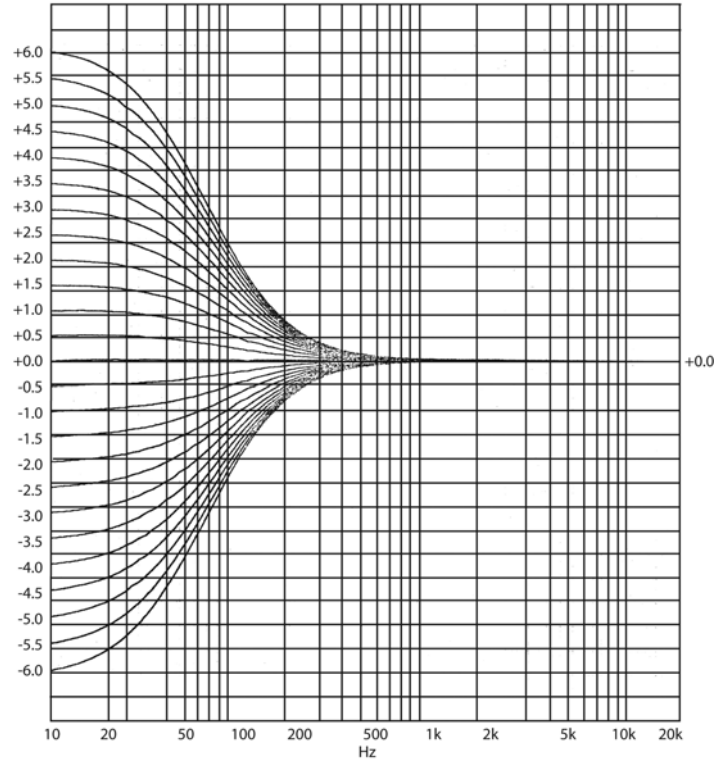

The BASS parameter controls the amount of low-frequency boost or cut applied to the Main Zone audio output connectors labeled Front L/R, Center and Sub.

TREBLE Parameter Settings

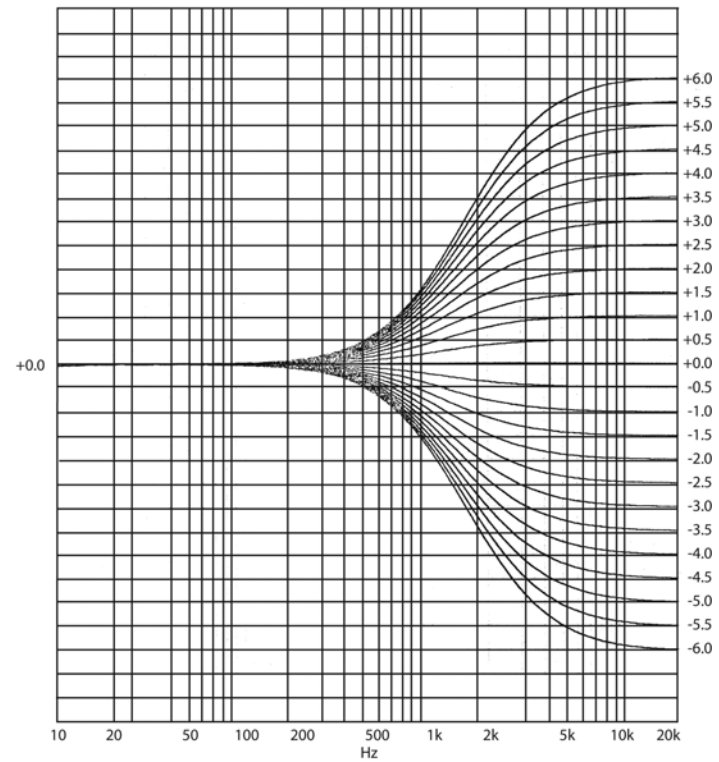

The TREBLE parameter controls the amount of high-frequency boost or cut applied to the Main Zone audio output connectors labeled Front L/R and Center.

AUDIO CONTROLS (continued)

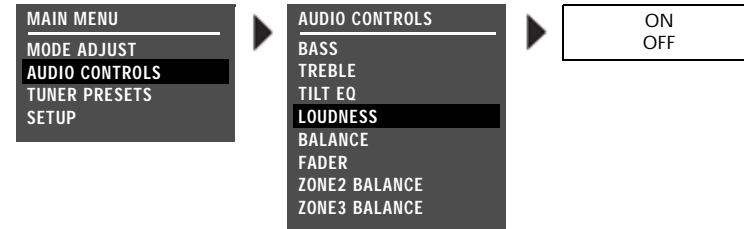
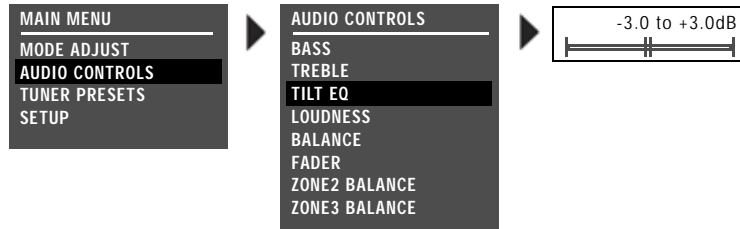

TILT EQ

-3.0dB to +3.0dB

AUDIO CONTROLS ▶ TILT EQ

Controls the amount of tilt equalization applied to the Main Zone audio output connectors labeled Front L/R, Center and Sub. This parameter setting affects the entire frequency spectrum with a hinge point at 1kHz. As the setting increases, frequencies higher than 1kHz are boosted while frequencies lower than 1kHz are simultaneously cut. As the setting decreases, frequencies higher than 1kHz are cut while frequencies lower than 1kHz are simultaneously boosted. The *TILT EQ Parameter Settings* graph on the next page indicates the frequency response of all TILT EQ parameter settings.

LOUDNESS

ON, OFF

AUDIO CONTROLS ▶ LOUDNESS

Controls the amount of low-frequency boost that is automatically applied to the Main Zone audio output connectors labeled Front L/R, Center and Sub. When ON is selected, loudness compensation is automatically applied, based on volume level. As volume level increases, the amount of boost automatically decreases. The loudness contour is optimized for input sources calibrated to THX reference levels. When OFF is selected, no loudness compensation is applied.

The *LOUDNESS Parameter Settings* graph on the next page indicates the frequency response that is automatically applied when the LOUDNESS parameter is set to ON and Main Zone volume level is adjusted.

TILT EQ Parameter Settings

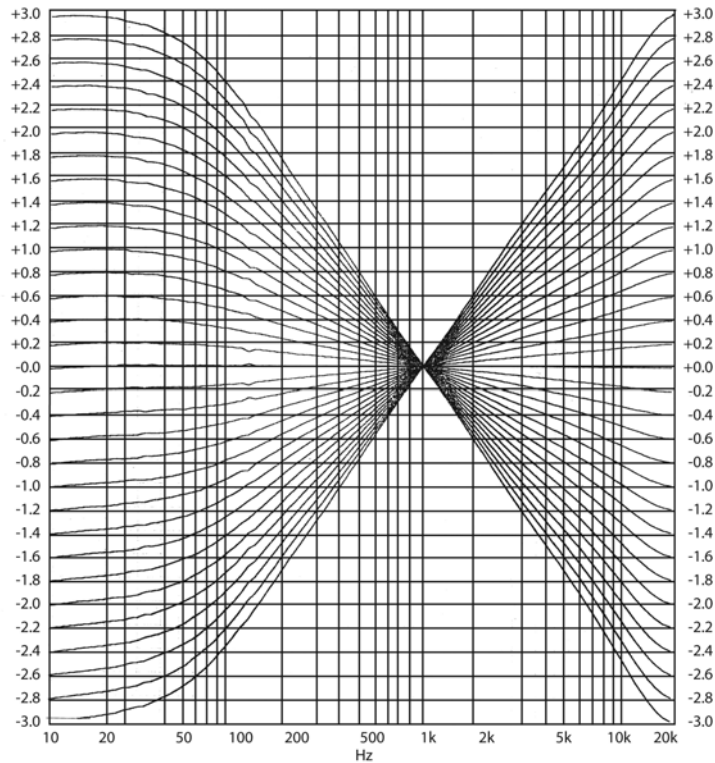

The TILT EQ parameter controls the amount of tilt equalization applied to the Main Zone audio output connectors labeled Front L/R, Center and Sub.

LOUDNESS Parameter Settings

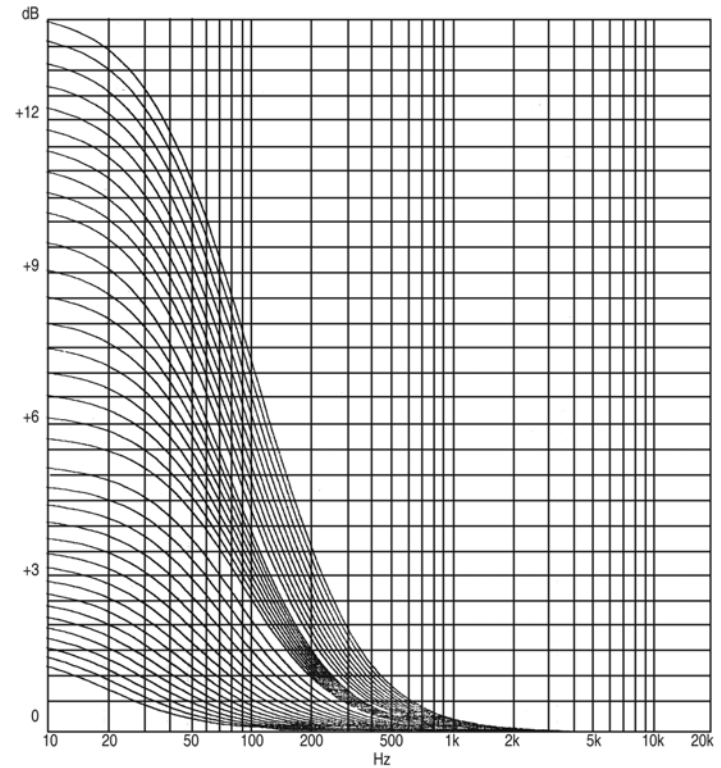

The LOUDNESS parameter controls the amount of low-frequency boost that is automatically applied to the Main Zone audio output connectors labeled Front L/R, Center and Sub.

AUDIO CONTROLS (continued)

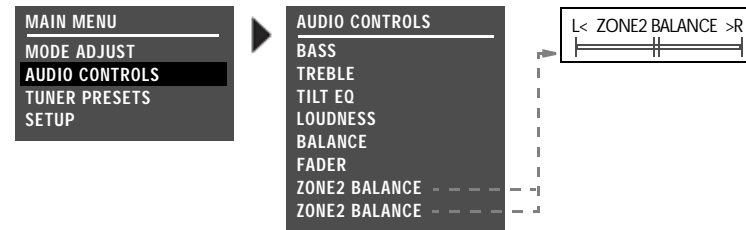
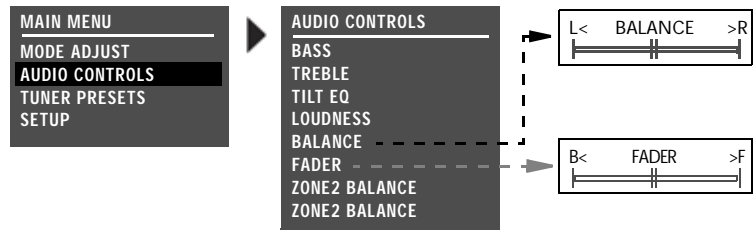

BALANCE

L< <|> >R

AUDIO CONTROLS ▶ BALANCE

Controls the left-to-right balance of the Main Zone audio output connectors.

FADER

B< <|> >F

AUDIO CONTROLS ▶ FADER

Controls the front-to-back balance of the Main Zone audio output connectors.

ZONE2 BALANCE

L< <|> >R

AUDIO CONTROLS ▶ ZONE2 BALANCE

Controls the left-to-right balance of the Zone 2 audio output connectors.

ZONE3 BALANCE

L< <|> >R

AUDIO CONTROLS ▶ ZONE3 BALANCE

Controls the left-to-right balance of the Zone 3 audio output connectors.

5

Tuner Presets

Tuner Presets	5-2
---------------------	-----

TUNER PRESETS

Selecting TUNER PRESETS from the MAIN MENU displays a list of the pages of existing presets. The preset number, preset name (if available), frequency and broadcast band is displayed.

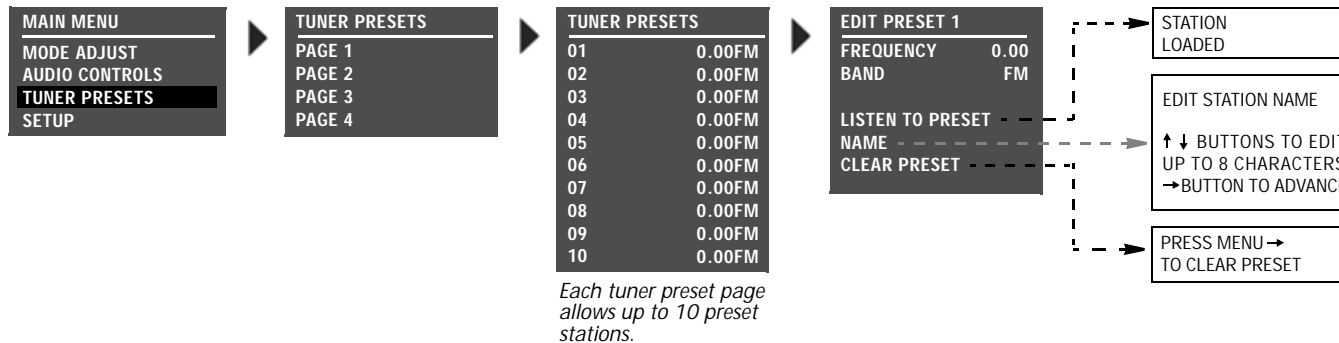

In the US, each preset channel is identified by the station's call letters, or what their broadcast information identifies as the call letters. In Europe and Japan, each preset channel is identified by the station's Program Service (PS) name. If RDS information is not available, then the Preset name will be Preset XX, where XX is the listed number location in the Preset menu for that position. For example, if Preset #01 is FM 90.90 and the call letters are WABC, then the name for that position is WABC.

To edit a preset, press the menu \blacktriangle / \blacktriangledown arrows until the desired preset is highlighted, then press the menu \blacktriangleright arrow to open the parameters menu for the selected preset.

Parameter

LISTEN TO PRESET

NAME

CLEAR PRESET

LISTEN TO PRESET**TUNER PRESETS** ▶ **PAGE 1** ▶ **01** ▶ **LISTEN TO PRESET**

Loads the current preset station. Press the menu ▶ arrow to load the station preset. The front panel and on-screen display will display "STATION LOADED."

NAME**TUNER PRESETS** ▶ **PAGE 1** ▶ **01** ▶ **NAME**

Edits the station name. The station name can be up to 8 characters long. The available characters are letters A to Z, numbers 0 to 9, and 10 additional symbols: ., -, +, :, (,), !, @, # or a blank space.

CLEAR PRESET**TUNER PRESETS** ▶ **PAGE 1** ▶ **01** ▶ **CLEAR PRESET**

Clears the current preset entry. The front-panel and on-screen display will display "PRESS MENU ▶ TO CLEAR PRESET." Press the ◀ menu arrow to cancel without clearing the preset.

6

Mode Adjust

Mode Adjust	6-2
Listening Mode Activation.....	6-2
Listening Mode Descriptions	6-4
Listening Mode Menu Option and Parameter Descriptions.....	6-39
Mode – Parameter Relationships	6-47

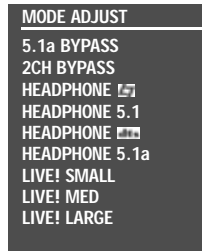
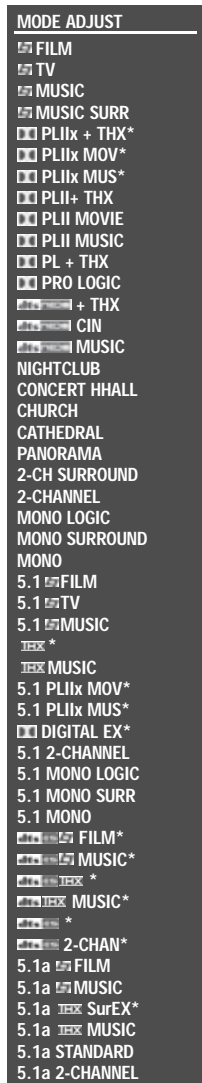
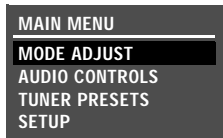

* These listening mode names differ depending on the current input source, speaker setup and parameter settings. Refer to the Listening Mode Descriptions for more information.

MODE ADJUST

Selecting the MODE ADJUST option opens the MODE ADJUST menu, which is used to select a listening mode for adjustment. When the MODE ADJUST menu opens, the currently activated Main Zone listening mode is highlighted.

Selecting a listening mode does not activate that listening mode for the current Main Zone input source. Rather, selecting a listening mode opens the corresponding listening mode menu, which is used to customize the selected listening mode. These adjustments are applied when the listening mode is selected with one of the methods described in the Listening Mode Activation section that begins below.

LISTENING MODE ACTIVATION

Listening modes are available for 2-channel, Dolby Digital, DTS(-ES), MIC and analog input sources. The RV-8 allows listening mode selection for all Main Zone sources. In some cases, the RV-8 automatically activates a listening mode in response to certain commands. For this reason, it is important to understand the three methods through which listening mode activation occurs.

Note:

When headphones are plugged into the RV-8, all listening modes are downmixed to two channels with the following exceptions: HEADPHONE L7, HEADPHONE 5.1, HEADPHONE DTS and HEADPHONE 5.1a. These listening modes are described in detail on page 6-34.

Listening mode activation occurs through:

- the INPUT SETUP menu preferred listening mode selection parameters (page 3-12).
- the front-panel or remote control Mode button (page 2-17).
- the remote control listening mode family selection buttons (page 2-17).

PREFERRED LISTENING MODE SELECTION

The INPUT SETUP menus include four preferred listening mode selection parameters labeled 2-CH, DOLBY D, DTS(-ES), 5.1a and MIC. These parameters are used to select a preferred listening mode for 2-channel, Dolby Digital, DTS(-ES), 5.1a and LIVE! input sources. The RV-8 automatically activates the selected listening mode whenever a new input is selected or a new input source is present.

MODE ▲ AND ▼ BUTTONS

The front-panel and remote-control Mode arrow buttons can be used to audition listening modes with the current Main Zone input source. Pressing these buttons scrolls up (▲) or down (▼) through listening modes available for the current Main Zone source. Listening modes are scrolled in the order that appears in the MODE ADJUST menu.

For example, if a 2-channel input source is present, press the ▲ or ▼ arrow buttons to scroll through available 2-channel listening modes. The selected listening mode appears in the bottom-left corner of the Main Zone two-line status.

Dynamic Listening Mode Selection

Dynamic listening modes are only available under certain conditions. For example, many of the dynamic modes are only available when the RV-8 is configured for seven main output channels and source material with specific encoding is played. All dynamic listening modes are available through the remote control or front panel Mode button.

See "Dynamic Listening Modes" on page 3-13 for a complete listing of dynamic listening modes.

LISTENING MODE SELECTION BUTTONS

The remote control listening mode selection buttons can be used to activate the Logic 7 Film, Dolby, DTS(-ES), THX, Logic 7 Music, or Logic 7 TV listening mode that is appropriate for the Main Zone input source. For instance, if the L7 button is pressed while a 2-channel source is present, the L7 FILM listening mode is activated. The table below indicates the listening modes associated with each mode family selection button.

Button	2-Channel Sources	Dolby Digital Sources	DTS(-ES) Sources	5.1a Sources
L7 F	L7 FILM	5.1 L7 FILM	DTS(-ES) L7 FILM	5.1a L7 FILM
L7 M	L7 MUSIC	5.1 L7 MUSIC	DTS(-ES) L7 MUSIC	5.1a L7 MUSIC
L7 TV	L7 TV	5.1 L7 TV	MODE SELECTION NOT AVAILABLE**	N/A
L7 MS	L7 MUSIC SURROUND	5.1 L7 MUSIC	DTS(-ES) L7 MUSIC	N/A
DOLBY	DOLBY PLIIX MOV	DD 5.1 PLIIX MOV*	MODE SELECTION NOT AVAILABLE**	N/A
DTS	DTS NEO:6 CIN	MODE SELECTION NOT AVAILABLE**	DTS(-ES)	N/A
THX	DOLBY PLIIX + THX	THX UL2CIN	DTS THX DTS THX UL2 CIN DTS(-ES) THX***	5.1a THX Sur EX

* These listening mode names differ depending on the input source, the speaker configuration and certain parameter settings. For 5.1 systems with only side or rear speakers (but not both), pressing the **■** button loads the DOLBY DIGITAL mode.

** The "MODE SELECTION NOT AVAILABLE" message appears in the on-screen and front-panel displays when no listening mode is available for the Main Zone input source that is present.

*** For ES source.

LISTENING MODE DESCRIPTIONS

Each listening mode description lists the default and possible settings for each listening mode menu parameter. All listening mode menus are shown in the Appendix. Listening mode menu option and parameter descriptions begin on page 6-39.

L7 FILM



This listening mode is designed for enhanced playback of 2-channel stereo or matrix-encoded film sources.

Logic 7 FILM is a proprietary Lexicon listening mode that derives seven channels from 2-channel input sources. Logic 7 also derives full-frequency stereo surround channels that realistically increase the perceived width, length and sense of envelopment of the listening space. Logic 7 provides remarkable improvement compared to other decoders.

Parameter	Default Setting	Possible Settings
AUTO AZIMUTH	ON	ON, OFF
VOCAL ENHANCE	+0.0dB	+6.0dB, +3.0dB, +0.0dB
RE-EQUALIZER	ON	ON, OFF
SOUND STAGE	REAR	FRONT, NEUTRAL, REAR
5 SPKR ENHANCE	ON	ON, OFF
BASS ENHANCE	OFF	ON, OFF
SURR ROLLOFF	7.0kHz	500Hz to 20.0kHz, OFF
REAR DLY OFFSET	15ms	OFF, 1 to 30ms
OUTPUT LEVELS	Refer to page 6-37	
CUSTOM	Refer to page 6-37	

See "Listening Mode Menu Option and Parameter Descriptions" on page 6-39 for detailed descriptions.

L7 TV



This listening mode is designed for playback of 2-channel stereo or matrix-encoded television broadcast sources.

Logic 7 TV is a proprietary Lexicon listening mode based on the Logic 7 FILM listening mode, but specifically tailored for broadcast sources.

Parameter	Default Setting	Possible Settings
AUTO AZIMUTH	ON	ON, OFF
VOCAL ENHANCE	+0.0dB	+6.0dB, +3.0dB, +0.0dB
FRONT STEERING	FILM	OFF, MSURR, MUSIC, FILM
RE-EQUALIZER	OFF	ON, OFF
SOUND STAGE	REAR	FRONT, NEUTRAL, REAR
5 SPKR ENHANCE	ON	ON, OFF
BASS ENHANCE	OFF	ON, OFF
SURR ROLLOFF	7.0kHz	500Hz to 20.0kHz, OFF
REAR DLY OFFSET	15ms	OFF, 1 to 30ms
OUTPUT LEVELS	Refer to page 6-37	
CUSTOM	Refer to page 6-37	

See "Listening Mode Menu Option and Parameter Descriptions" on page 6-39 for detailed descriptions.

L7 MUSIC

MODE ADJUST ► **MUSIC**

This listening mode is designed for playback of 2-channel stereo or matrix-encoded music sources.

Logic 7 MUSIC is a proprietary Lexicon listening mode based on the Logic 7 FILM listening mode, but specifically tailored for music sources.

Parameter	Default Setting	Possible Settings
VOCAL ENHANCE	+0.0dB	+6.0dB, +3.0dB, +0.0dB
FRONT STEERING	MUSIC	OFF, MSURR, MUSIC, FILM
SOUND STAGE	NEUTRAL	FRONT, NEUTRAL, REAR
5 SPKR ENHANCE	ON	ON, OFF
BASS ENHANCE	OFF	ON, OFF
SURR ROLLOFF	7.0kHz	500Hz to 20.0kHz, OFF
REAR DLY OFFSET	15ms	OFF, 1 to 30ms
OUTPUT LEVELS	Refer to page 6-37	
CUSTOM	Refer to page 6-37	

See "Listening Mode Menu Option and Parameter Descriptions" on page 6-39 for detailed descriptions.

L7 MUSIC SURR

MODE ADJUST ► **MUSIC SURR**

This listening mode is designed for playback of 2-channel stereo music sources recorded in real spaces and for playback of recordings that contain added reverb. It is recommended for classical music sources, which are often recorded in real spaces with added reverb to enhance the stereo mix.

Logic 7 MUSIC SURR is a proprietary Lexicon listening mode that is similar to the MUSIC SURROUND listening mode in other Lexicon products. Logic 7 extracts ambient sounds from the input source and sends these sounds to all speakers. Ambient sounds are heard from all directions, creating a realistic playback presentation that simulates what listeners experience in real spaces.

Parameter	Default Setting	Possible Settings
VOCAL ENHANCE	+0.0dB	+6.0dB, +3.0dB, +0.0dB
FRONT STEERING	MSURR	OFF, MSURR, MUSIC, FILM
SOUND STAGE	NEUTRAL	FRONT, NEUTRAL, REAR
5 SPKR ENHANCE	ON	ON, OFF
BASS ENHANCE	OFF	ON, OFF
SURR ROLLOFF	7.0kHz	500Hz to 20.0kHz, OFF
REAR DLY OFFSET	15ms	OFF, 1 to 30ms
OUTPUT LEVELS	Refer to page 6-37	
CUSTOM	Refer to page 6-37	

See "Listening Mode Menu Option and Parameter Descriptions" on page 6-39 for detailed descriptions.

DOLBY PLIIx + THX & DOLBY PLII + THX

MODE ADJUST ► **DOLBY PLIIx + THX** OR MODE ADJUST ► **DOLBY PLII + THX**

Dolby Pro Logic IIx technology is an extension to Dolby Pro Logic II that enables the listener to experience natural and seamless 6.1- or 7.1-channel (six or seven speakers and a subwoofer) surround sound from any native two-channel (stereo) or 5.1-channel source.

The modes are recommended for home theaters with THX-certified speakers. Dolby PLII(x) + THX encoding:

- Applies THX re-equalization to simulate high-frequency rolloffs that occur in movie theaters. Most films are mixed for movie theaters, and might sound too bright when played back in home theaters without re-equalization.
- Applies THX timbre matching to minimize timbre differences between the front and surround channels, which results in smoother sound movements between them.

The PLIIx listening mode is only available when the front, side and rear speakers are present. The PLII listening mode is available when the front and side speakers are present.

Activating the DOLBY PLIIx + THX listening mode

The DOLBY PLIIx + THX listening mode is a dynamic listening mode and cannot be assigned as a preferred listening mode for 2-channel Dolby Surround-encoded sources. To activate this listening mode, play the 2-channel Dolby Surround-encoded source, then select DOLBY PLIIx + THX using the front-panel or remote control Mode buttons.

When the 2-CH parameter is set to USE LAST, the RV-8 will automatically activate the DOLBY PLIIx + THX listening mode if this listening mode was activated the last time a 2-channel Dolby Surround-encoded source was present.

Note:

The PLIIx mode does not appear in the list of available listening modes if either the side or rear speakers are missing from the configuration.

Parameter	Default Setting	Possible Settings
RE-EQUALIZER	ON	ON, OFF
OUTPUT LEVELS	Refer to page 6-37	
CUSTOM	Refer to page 6-37	

See "Listening Mode Menu Option and Parameter Descriptions" on page 6-39 for detailed descriptions.

DOLBY PLIIx MOV & DOLBY PLII MOVIE

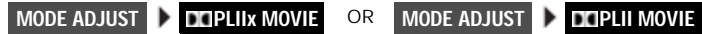

Dolby Pro Logic IIx technology is an extension to Dolby Pro Logic II that enables the listener to experience natural and seamless 6.1- or 7.1-channel (six or seven speakers and a subwoofer) surround sound from any native two-channel (stereo) or 5.1-channel source.

Dolby PLIIx MOV and Dolby PLII MOVIE modes:

- Are designed for playback of Dolby Surround-encoded sources.
- Provide impressive enhancement compared to Dolby Pro Logic decoding.
- Are appropriate for Dolby Surround-encoded film sources.

The PLIIx listening mode is only available when the front, side and rear speakers are present.

Activating the DOLBY PLIIx MOV listening mode

The DOLBY PLIIx MOV listening mode is a dynamic listening mode and cannot be assigned as a preferred listening mode for 2-channel Dolby Surround-encoded film sources. To activate the DOLBY PLIIx Mov listening mode, play the 2-channel source input, and select the DOLBY PLIIx MOV listening mode using the front-panel or remote control Mode buttons.

When the 2-CH parameter is set to USE LAST, the RV-8 will automatically activate the DOLBY PLIIx MOV listening mode if this listening mode was activated the last time a 2-channel Dolby Surround-encoded film source was present.

Note:

The PLIIx MOV mode does not appear in the list of available listening modes if either the side or rear speakers are missing from the configuration.

Parameter

OUTPUT LEVELS	Refer to page 6-37
CUSTOM	Refer to page 6-37

See "Listening Mode Menu Option and Parameter Descriptions" on page 6-39 for detailed descriptions.

DOLBY PLIIx MUS & DOLBY PLII MUSIC

MODE ADJUST ► **DOLBY PLIIx MUS** OR MODE ADJUST ► **DOLBY PLII MUSIC**

Dolby Pro Logic IIx technology is an extension to Dolby Pro Logic II that enables the listener to experience natural and seamless 6.1- or 7.1-channel (six or seven speakers and a subwoofer) surround sound from any native two-channel (stereo) or 5.1-channel source.

The PLIIx listening mode is only available when the front, side and rear speakers are present.

Activating the DOLBY PLIIx MUS listening mode

The DOLBY PLIIx MUS listening mode is a dynamic listening mode and cannot be assigned as a preferred listening mode for 2-channel Dolby Surround-encoded film sources. To activate the DOLBY PLIIx MUS listening mode, play the 2-channel source input, and select the DOLBY PLIIx MUS listening mode using the front-panel or remote control Mode buttons.

When the 2-CH parameter is set to USE LAST, the RV-8 will automatically activate the DOLBY PLIIx MUS listening mode if this listening mode was activated the last time a 2-channel Dolby Surround-encoded film source was present.

Note:

The DOLBY PLIIx MUS mode does not appear in the list of available listening modes if either the side or rear speakers are missing from the configuration.

Parameter	Default Setting	Possible Settings
PANORAMA	OFF	ON, OFF
CTR WIDTH	3	MIN, 1 to 6, MAX
DIMENSION	NEUTRAL	FRONT, NEUTRAL, REAR
SURROUND DLY	10ms	0 to 15ms
OUTPUT LEVELS	Refer to page 6-37	
CUSTOM	Refer to page 6-37	

See "Listening Mode Menu Option and Parameter Descriptions" on page 6-39 for detailed descriptions.

DOLBY PL + THX



This mode is designed for playback of Dolby Surround-encoded sources and decodes four channels: three front channels and one mono surround channel with a high-frequency rolloff above 7kHz. This mode is recommended for home theaters with THX-certified speakers. Dolby PL + THX mode:

- Applies THX re-equalization to simulate high-frequency rolloffs that occur in movie theaters. Most films are mixed for movie theaters, and may sound too bright when played back in home theaters without re-equalization.
- Applies THX timbre matching to minimize timbre differences between the front and surround channels, which results in smoother sound movements between them.

Parameter	Default Setting	Possible Settings
RE-EQUALIZER	ON	ON, OFF
OUTPUT LEVELS	Refer to page 6-37	
CUSTOM	Refer to page 6-37	

See "Listening Mode Menu Option and Parameter Descriptions" on page 6-39 for detailed descriptions.

DOLBY PRO LOGIC



The Dolby PRO LOGIC mode is designed for playback of Dolby Surround-encoded sources. It decodes four channels from Dolby Surround-encoded sources, and uses a mono surround channel with a high-frequency rolloff above 7kHz.

This mode is useful for comparison purposes, particularly with the L7 FILM, Dolby PLIIx MOVIE and DTS Neo:6 CIN listening mode.

Parameter

OUTPUT LEVELS	Refer to page 6-37
CUSTOM	Refer to page 6-37

See "Listening Mode Menu Option and Parameter Descriptions" on page 6-39 for detailed descriptions.

DTS NEO:6 + THX



This mode is designed for playback of matrix-encoded digital stereo film sources. DTS Neo:6 derives six channels when both side and rear speakers are present (rear channels will be in parallel). It derives five channels when only side or rear speakers are present.

In addition to THX processing, THX re-equalization is applied to simulate high-frequency rolloffs that occur in movie theaters. Most films are mixed for movie theaters, and may sound too bright when played back in home theaters without re-equalization.

This listening mode is a dynamic listening mode and cannot be assigned as a preferred listening mode. To select this listening mode use the remote control or front-panel Mode button. When the 2-CH parameter is set to USE LAST, the RV-8 will automatically activate a DTS Neo:6 + THX listening mode if this mode was activated the last time a 2-channel source was present.

Parameter	Default Setting	Possible Settings
RE-EQUALIZER	ON	ON, OFF
OUTPUT LEVELS	Refer to page 6-37	
CUSTOM	Refer to page 6-37	

See "Listening Mode Menu Option and Parameter Descriptions" on page 6-39 for detailed descriptions.

DTS NEO:6 CIN & DTS NEO:6 MUSIC



These modes are designed for playback of matrix-encoded digital stereo film or music sources. DTS Neo:6 derives six channels when both side and rear speakers are present (rear channels will be in parallel). It derives five channels when only side or rear speakers are present.

These listening modes are dynamic listening modes and cannot be assigned as preferred listening modes. To select either of these listening modes, use the remote control or front-panel Mode button. When the 2-CH parameter is set to USE LAST, the RV-8 will automatically activate a DTS Neo:6 listening mode if this mode was activated the last time a 2-channel source was present.

Note:

- The RV-8 will not automatically activate a DTS NEO:6 listening mode unless a 44.1kHz or 48kHz PCM digital source is present. The DTS Neo:6 listening modes are not available with 88.2kHz or 96kHz, Dolby Digital or analog sources.
- The DTS Neo:6 MUSIC listening mode can be activated with the front-panel or remote control Mode buttons. The DTS Neo:6 CIN listening mode can also be activated with the remote control DTS button when a 2-channel input source is present.

Parameter

OUTPUT LEVELS	Refer to page 6-37
CUSTOM	Refer to page 6-37

See "Listening Mode Menu Option and Parameter Descriptions" on page 6-39 for detailed descriptions.

NIGHTCLUB

MODE ADJUST ▶ **NIGHTCLUB**

The NIGHTCLUB mode is designed for playback of “dry” music sources that benefit from the addition of room reflections, especially music sources that lack ambience in the recording. The NIGHTCLUB mode generates early reflections and sends them to the front, side and rear channels to simulate small, intimate listening spaces.

The NIGHTCLUB mode is a superior room simulation listening mode because it uses a proprietary reverb algorithm inherited from Lexicon professional products.

Parameter	Default Setting	Possible Settings
CENTER DEPTH	11	0 to 18
SPEECH DETECT	ON	ON, OFF
SIZE	5m	4 to 20m
LIVENESS	196ms	30ms to 20.2s
PRE-DELAY	5ms	OFF, 1 to 100ms
ROLLOFF	9.0kHz	500Hz to 20.0kHz, OFF
EFFECT LVL	+3dB	-12 to +6dB
OUTPUT LEVELS	Refer to page 6-37	
CUSTOM	Refer to page 6-37	

See “Listening Mode Menu Option and Parameter Descriptions” on page 6-39 for detailed descriptions.

CONCERT HALL

MODE ADJUST ▶ **CONCERT HALL**

The CONCERT HALL mode generates early reflections and sends them to the front, side and rear channels to simulate large listening spaces.

The CONCERT HALL mode is a superior room simulation listening mode because it uses a proprietary reverb algorithm inherited from Lexicon professional products.

Parameter	Default Setting	Possible Settings
CENTER DEPTH	12	0 to 18
SPEECH DETECT	ON	ON, OFF
SIZE	20m	4 to 20m
LIVENESS	1.72s	30ms to 20.2s
PRE-DELAY	OFF	OFF, 1 to 100ms
ROLLOFF	2.4kHz	500Hz to 20.0kHz, OFF
EFFECT LVL	-2dB	-12 to +6dB
OUTPUT LEVELS	Refer to page 6-37	
CUSTOM	Refer to page 6-37	

See “Listening Mode Menu Option and Parameter Descriptions” on page 6-39 for detailed descriptions.

CHURCH

MODE ADJUST ► CHURCH

The CHURCH mode uses a reverb algorithm to emphasize the rich, smooth, reverberant decay characteristic of small and medium listening spaces – such as churches and chambers – with long reverberation time relative to their sizes.

The CHURCH mode is a superior room simulation listening mode because it uses a proprietary reverb algorithm inherited from Lexicon professional products.

Parameter	Default Setting	Possible Settings
CENTER DEPTH	5	0 to 18
SPEECH DETECT	ON	ON, OFF
SIZE*	20m	4 to 30m
MID RT*	1.56s	24ms to 24.3s
BASS RT*	1.87s	5ms to 48.6s
PRE-DELAY	24ms	OFF, 1 to 100ms
ROLLOFF	2.4kHz	500Hz to 20.0kHz, OFF
EFFECT LVL	-3dB	-12 to +6dB
OUTPUT LEVELS	Refer to page 6-37	
CUSTOM	Refer to page 6-37	

* BASS RT, MID RT and SIZE parameter settings are interdependent, meaning that the full parameter range might not be available depending on the other parameter settings. See "Listening Mode Menu Option and Parameter Descriptions" on page 6-39 for detailed descriptions.

CATHEDRAL

MODE ADJUST ► CATHEDRAL

The CATHEDRAL mode is similar to the CHURCH listening mode. It uses a reverb algorithm to emphasize the rich, smooth, reverberant decay characteristic of large listening spaces – such as cathedrals – with long reverberation time relative to their size.

The CATHEDRAL mode is a superior room simulation listening mode because it uses a proprietary reverb algorithm inherited from Lexicon professional products.

Parameter	Default Setting	Possible Settings
CENTER DEPTH	12	0 to 18
SPEECH DETECT	ON	ON, OFF
SIZE*	30m	4 to 30m
MID RT*	3.72s	24ms to 24.3s
BASS RT*	4.47s	5ms to 48.6s
PRE-DELAY	23ms	OFF, 1 to 100ms
ROLLOFF	3.1kHz	500Hz to 20.0kHz, OFF
EFFECT LVL	-8dB	-12 to +6dB
OUTPUT LEVELS	Refer to page 6-37	
CUSTOM	Refer to page 6-37	

* BASS RT, MID RT and SIZE parameter settings are interdependent, meaning that the full parameter range might not be available depending on the other parameter settings. See "Listening Mode Menu Option and Parameter Descriptions" on page 6-39 for detailed descriptions.

PANORAMA

MODE ADJUST ▶ PANORAMA

The PANORAMA mode is designed for playback of stereo and matrix-encoded sources. PANORAMA uses proprietary Lexicon algorithms to move the stereo image outward from the front speakers, producing a wider stereo field with greater depth.

Sound quality depends on proper location of the listening position and front speakers. When the front speakers are positioned close to either side of the display device, the effect is produced over a wider area than when the front speakers are positioned at a large angle from the display device.

Parameter	Default Setting	Possible Settings
EFFECT LVL	+4dB	-12 to +6dB
BASS CONTENT	STEREO	BINAURL, MONO, STEREO
LOW FREQ WIDTH	+0	-25 to +25dB
SURR ROLLOFF	3.1kHz	500Hz to 20.0kHz, OFF
REAR DLY OFFSET	15ms	OFF, 1 to 30ms
INPUT BALANCE	< >	L< to < > to >R
CALIBRATION	Refer to next column	
OUTPUT LEVELS	Refer to page 6-37	
CUSTOM	Refer to page 6-37	

See "Listening Mode Menu Option and Parameter Descriptions" on page 6-39 for detailed descriptions.

PANORAMA CALIBRATION

MODE ADJUST ▶ PANORAMA ▶ CALIBRATION

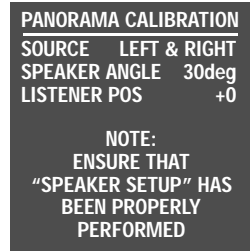

Select PANORAMA ▶ CALIBRATION to open the PANORAMA CALIBRATION menu shown to the left, to calibrate the PANORAMA listening mode. **This listening mode must be calibrated to take full advantage of its effects.**

For best results, you should center the primary listening position between the front left and right speakers as shown in the **Center** illustration at the top of the next page. Otherwise, the PANORAMA listening mode will be calibrated with varying results.

An external calibration source is required to calibrate the PANORAMA listening mode. You should select a familiar stereo source.

Parameter	Default Setting	Possible Settings
SOURCE	LEFT & RIGHT	RIGHT, LEFT & RIGHT, LEFT
SPEAKER ANGLE	30deg	10 to 90deg
LISTENER POS	+0	-127 to +127

See "Listening Mode Menu Option and Parameter Descriptions" on page 6-39 for detailed descriptions.

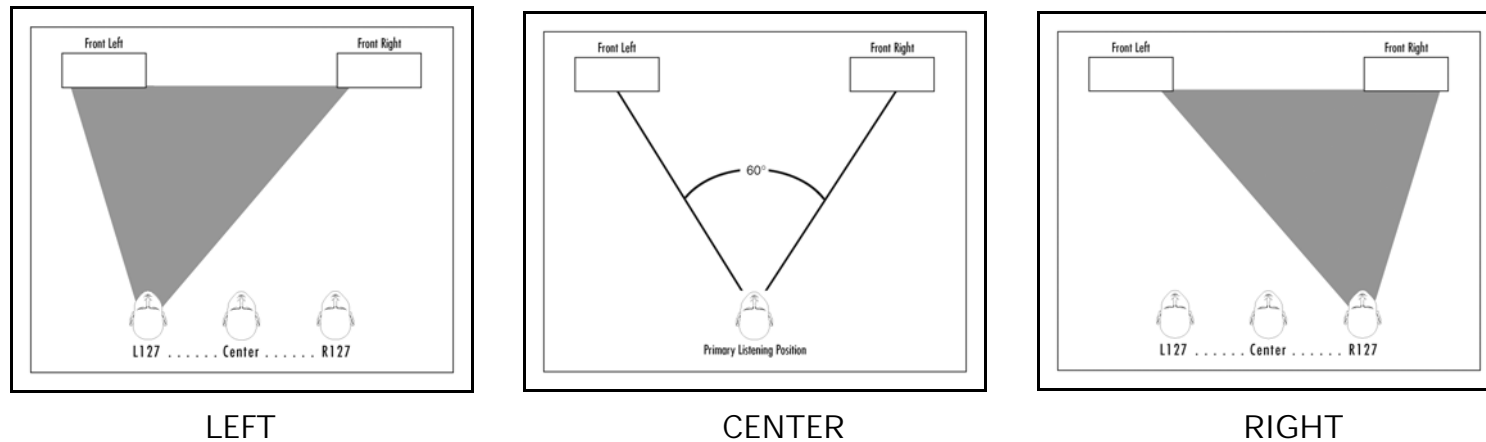

LEFT

CENTER

RIGHT

To calibrate the PANORAMA listening mode:

1. Remove all obstructions between the speakers and the primary listening position.
2. Make sure the distances between the speakers and the primary listening position are properly measured. To do this, select one of the following options.
 - Select the AUTO SPEAKER SETUP menu DISTANCES option to have the RV-8 automatically calibrate speaker distances.
 - Measure the distance between the primary listening position and the front baffle of each speaker. Then, set the corresponding SPEAKER DISTANCES menu parameters to the closest available value.
3. Sit in the primary listening position. If the primary listening position is not centered between the front left and right speakers as shown in illustration B (above), set the PANORAMA CALIBRATION ► LISTENER POS parameter to compensate for the difference using the remote control ▲ and ▼ arrow buttons. Each increment within the -127 to +127 parameter range represents about one-third of an inch. The Left illustration shows the left-of-center position. The Right illustration shows the right-of-center position
4. Set the SOURCE parameter to RIGHT.
5. Begin playback of the external calibration source.
6. When playback of the external calibration source is in progress, set the SPEAKER ANGLE parameter so the sound is not heard in the right ear.
7. To confirm the LISTENER POS and SPEAKER ANGLE parameter settings, set the SOURCE parameter to LEFT & RIGHT. If the PANORAMA listening mode is properly calibrated, the sound should be perceived to come from all around the primary listening position. If not, go back to Step 1 and repeat the calibration procedure.

2-CH SURROUND

MODE ADJUST ► 2-CH SURROUND

This mode, designed for playback of stereo sources, sends the left channel to Front, Side and Rear Left channels and the right channel to Front, Side and Rear Right channels, and sums the Left and Right for the center. It is recommended for background music.

Parameter

OUTPUT LEVELS	Refer to page 6-37
CUSTOM	Refer to page 6-37

2-CHANNEL

MODE ADJUST ► 2-CHANNEL

This mode, designed for playback of stereo sources, sends the left and right channels to the Front L/R and Subwoofer channels. It is recommended for two-speaker playback with subwoofers and for comparison purposes with other listening modes.

Parameter

Default Setting

Possible Settings

SUB LEVEL	+0dB	OFF, -30 to +12dB
CUSTOM	Refer to page 6-37	

See "Listening Mode Menu Option and Parameter Descriptions" on page 6-39 for detailed descriptions.

MONO LOGIC

MODE ADJUST ► MONO LOGIC

This mode, designed for playback of mono sources, uses proprietary Lexicon reverb algorithms to realistically expand mono sources to use all channels. This dramatically increases the perceived width and sense of envelopment of the listening space.

Parameter

Default Setting

Possible Settings

EFFECT LVL	-9dB	-12 to +6dB
ACADEMY FILTER	ON	ON, OFF
SURR ROLLOFF	3.1kHz	500Hz to 20.0kHz, OFF
OUTPUT LEVELS	Refer to page 6-37	
CUSTOM	Refer to page 6-37	

See "Listening Mode Menu Option and Parameter Descriptions" on page 6-39 for detailed descriptions.

MONO SURROUND

MODE ADJUST ► MONO SURROUND

This mode, designed for playback of mono sources, sends the mono source to all channels.

Parameter

OUTPUT LEVELS	Refer to page 6-37
CUSTOM	Refer to page 6-37

MONO

MODE ADJUST ► MONO

This mode, designed for playback of mono sources, sends mono sources to the center channel and subwoofer.

Parameter	Default Setting	Possible Settings
SUB LEVEL	+0dB	OFF, -30 to +12dB
CUSTOM	Refer to page 6-37	

See "Listening Mode Menu Option and Parameter Descriptions" on page 6-39 for detailed descriptions.

5.1 L7 FILM

MODE ADJUST ► 5.1 L7 FILM

The 5.1 L7 FILM mode is a proprietary Lexicon listening mode designed for playback of 5.1-channel Dolby Digital-encoded film sources, and provides remarkable improvement compared to other decoders.

It derives seven channels from 5.1-channel input sources with enhanced front steering. When both side and rear speakers are present, the 5.1 L7 FILM listening mode also increases the perceived length and sense of envelopment of the listening space.

Parameter	Default Setting	Possible Settings
VOCAL ENHANCE	+0.0dB	+6.0dB, +3.0dB, +0.0dB
RE-EQUALIZER	ON	ON, OFF
SOUND STAGE	REAR	REAR, NEUTRAL, FRONT
5 SPKR ENHANCE	ON	ON, OFF
BASS ENHANCE	OFF	ON, OFF
SURR ROLLOFF	7kHz	500HZ to 20kHz, OFF
REAR DLY OFFSET	15ms	OFF, 1ms to 30ms
COMPRESSION	OFF	AUTO, ON, OFF
LFE MIX	+0.0dB	-10.0dB to +0.0dB
OUTPUT LEVELS	Refer to page 6-37	
CUSTOM	Refer to page 6-37	

See "Listening Mode Menu Option and Parameter Descriptions" on page 6-39 for detailed descriptions.

5.1 L7 TV

MODE ADJUST ▶ 5.1 TV

This proprietary Lexicon listening mode is designed for playback of 5.1-channel Dolby Digital-encoded broadcast sources. Based on the 5.1 L7 FILM listening mode, 5.1 L7 TV derives seven channels from 5.1-channel input sources with enhanced front steering.

Parameter	Default Setting	Possible Settings
VOCAL ENHANCE	+0.0dB	+6.0dB, +3.0dB, +0.0dB
FRONT STEERING	FILM	OFF, MSURR, MUSIC, FILM
RE-EQUALIZER	OFF	ON, OFF
SOUND STAGE	REAR	REAR, NEUTRAL, FRONT
5 SPKR ENHANCE	ON	ON, OFF
BASS ENHANCE	OFF	ON, OFF
SURR ROLLOFF	7kHz	500HZ to 20kHz, OFF
REAR DLY OFFSET	15ms	OFF, 1ms to 30ms
COMPRESSION	OFF	AUTO, ON, OFF
LFE MIX	+0.0dB	-10.0dB to +0.0dB
OUTPUT LEVELS	Refer to page 6-37	
CUSTOM	Refer to page 6-37	

See "Listening Mode Menu Option and Parameter Descriptions" on page 6-39 for detailed descriptions.

5.1 L7 MUSIC

MODE ADJUST ▶ 5.1 MUSIC

This proprietary Lexicon listening mode is designed for playback of 5.1-channel Dolby Digital-encoded music sources. Based on the 5.1 L7 FILM listening mode, 5.1 L7 MUSIC derives seven channels from 5.1-channel input sources with enhanced front steering.

Parameter	Default Setting	Possible Settings
VOCAL ENHANCE	+0.0dB	+6.0dB, +3.0dB, +0.0dB
FRONT STEERING	MUSIC	OFF, MSURR, MUSIC, FILM
RE-EQUALIZER	OFF	ON, OFF
SOUND STAGE	NEUTRAL	REAR, NEUTRAL, FRONT
5 SPKR ENHANCE	ON	ON, OFF
BASS ENHANCE	OFF	ON, OFF
SURR ROLLOFF	7kHz	500HZ to 20kHz, OFF
REAR DLY OFFSET	15ms	OFF, 1ms to 30ms
COMPRESSION	OFF	AUTO, ON, OFF
LFE MIX	+0.0dB	-10.0dB to +0.0dB
OUTPUT LEVELS	Refer to page 6-37	
CUSTOM	Refer to page 6-37	

See "Listening Mode Menu Option and Parameter Descriptions" on page 6-39 for detailed descriptions.

THX, THX UL2Cin & THX SurEX

MODE ADJUST ▶ THX OR THX UL2Cin OR THX SurEX

These modes are designed for 7-channel playback of 5.1-channel Dolby Digital film sources that do not have THX Surround EX encoding. They apply THX re-equalization to simulate high-frequency rolloffs that occur in movie theaters. Most films are mixed for movie theaters, and might sound too bright when played back in home theaters without re-equalization. THX timbre matching is applied to minimize timbre differences between the front and surround channels, which results in smoother sound movements between them. These modes are recommended for home theaters with THX-certified speakers.

The listening mode name differs, depending on the encoding present in the input source, the SURROUND EX parameter setting and the speaker setup.

The table at the bottom of the page shows the conditions for the behavior of the THX Ultra2 and THX Surround EX modes when activated:

- The THX UL2Cin listening mode is available when both the side and rear speakers are present and THX ULTRA2 decoding is engaged. THX Ultra2 decoding is engaged when the SURROUND EX parameter is set to OFF or AUTO and a non-flagged

5.1-channel Dolby Digital source with or without THX Surround EX encoding is detected.

- The THX SurEX listening mode is available when both the side and rear speakers are present and THX Surround EX decoding is engaged. THX Surround EX decoding is engaged when the SURROUND EX parameter is set to ON or AUTO and a *flagged* 5.1-channel Dolby Digital source with THX Surround EX encoding is detected.
- The THX listening mode is available when both Ultra2 and THX Surround EX decoding are deactivated.

Note:

Some EX-encoded sources are not flagged, and require manually setting the SURROUND EX parameter to ON for EX decoding.

When THX Ultra2 decoding is active:

- Adaptive de-correlation is applied to increase the perceived width of the listening space. De-correlation of the mono surround channel increases the perceived width of the surround field in home theaters.

Parameter Setting	Input Source		
	5.1-Channel Dolby Digital	5.1-Channel THX Surround EX Dolby Digital (Flagged)	5.1-Channel THX Surround EX Dolby Digital (Non-Flagged)
SURROUND EX: AUTO	THX ULTRA2	THX SurEX	THX ULTRA2
SURROUND EX: ON	THX SurEX	THX SurEX	THX SurEX
SURROUND EX: OFF	THX ULTRA2	THX ULTRA2	THX ULTRA2

- ASA processing is applied to signals sent to the rear speakers. Refer to the ASA parameter description on page 3-31 for more information.

When THX Surround EX decoding is active:

Matrix decoding is applied to derive three surround channels from 5.1-channel Dolby Digital sources.

Parameter	Default Setting	Possible Settings
RE-EQUALIZER	ON	ON, OFF
SURROUND EX	AUTO	AUTO, ON, OFF
COMPRESSION	OFF	AUTO, ON, OFF
LFE MIX	+0.0dB	-10.0 to +0.0dB
OUTPUT LEVELS	Refer to page 6-37	
CUSTOM	Refer to page 6-37	

See "Listening Mode Menu Option and Parameter Descriptions" on page 6-39 for detailed descriptions.

Note:

The THX UL2Cin listening mode is a dynamic listening mode and cannot be assigned as a preferred listening mode for Dolby Digital sources. Activate this listening mode with the front-panel or remote control Mode buttons.

When the DOLBY D parameter is set to USE LAST, the RV-8 will automatically activate a THX UL2Cin listening mode if this mode was activated the last time a Dolby Digital source was present.

THX MUSIC



This listening mode is designed for playback of 5.1-channel Dolby Digital music sources, and cannot be activated unless side and rear speakers are present. ASA processing is applied to signals sent to the rear speakers. See "ASA" on page 3-35 for more information. For best results, place the rear speakers close together in your home theater.

Parameter	Default Setting	Possible Settings
COMPRESSION	OFF	AUTO, ON, OFF
LFE MIX	+0.0dB	-10.0 to +0.0dB
OUTPUT LEVELS	Refer to page 6-37	
CUSTOM	Refer to page 6-37	

See "Listening Mode Menu Option and Parameter Descriptions" on page 6-39 for detailed descriptions.

Note:

The THX MUSIC listening mode is a dynamic listening mode and cannot be assigned as a preferred listening mode for Dolby Digital sources. Activate this listening mode with the front-panel or remote control Mode arrow buttons.

When the DOLBY D parameter is set to USE LAST, the RV-8 will automatically activate a THX MUSIC listening mode if this mode was activated the last time a Dolby Digital source was present.

5.1 PLIIx MOV

MODE ADJUST ► 5.1 PLIIx MOV

The 5.1 PLIIx MOV (MOVIE) listening mode is designed to play back 7.1 discrete channels decoded from 5.1-channel Dolby Digital film sources. The seven main channels are full-frequency. The .1 channel, often referred to as LFE information, has a limited frequency range of up to 120Hz.

The 5.1 PLIIx MOV listening mode is only available when the front, side and rear speakers are present.

Note:

The RV-8 cannot detect Dolby Digital Surround EX encoding in non-flagged 5.1-channel Dolby Digital input sources.

Activating the 5.1 PLIIx MOV listening mode

The 5.1 PLIIx MOV listening mode is a dynamic listening mode and cannot be assigned as a preferred listening mode for Dolby Digital film sources. To activate this listening mode, use the front-panel or remote control Mode buttons.

When the DOLBY D parameter is set to USE LAST, the RV-8 will automatically activate the dynamic 5.1 PLIIx MOV listening mode if this listening mode was activated the last time a Dolby Digital source was present.

Note:

The 5.1 PLIIx MOV mode will not appear in the list of available listening modes if either the side or rear speakers are missing from the configuration.

Parameter	Default Setting	Possible Settings
EX DECODING	AUTO	AUTO, ON, OFF
COMPRESSION	OFF	AUTO, ON, OFF
LFE MIX	+0.0dB	-10.0 to +0.0dB
OUTPUT LEVELS	Refer to page 6-37	
CUSTOM	Refer to page 6-37	

See "Listening Mode Menu Option and Parameter Descriptions" on page 6-39 for detailed descriptions.

5.1 PLIIx MUS

MODE ADJUST ▶ 5.1 PLIIx MUS

The 5.1 PLIIx MUS (MUSIC) listening mode is designed to playback 7.1 discrete channels decoded from 5.1-channel Dolby Digital music sources. The seven main channels are full-frequency. The .1 channel, often referred to as LFE information, has a limited frequency range of up to 120Hz.

Note:

The RV-8 cannot detect Dolby Digital Surround EX encoding in non-flagged 5.1-channel Dolby Digital input sources.

Activating the 5.1 PLIIx MUS listening mode

The 5.1 PLIIx MUS listening mode is a dynamic listening mode and cannot be assigned as a preferred listening mode for Dolby Digital sources. To activate this listening mode, use the front-panel or remote control Mode buttons.

When the DOLBY D parameter is set to USE LAST, the RV-8 will automatically activate the dynamic 5.1 PLIIx MUS listening mode if this listening mode was activated the last time a Dolby Digital source was present.

Note:

The 5.1 PLIIx MUS mode does not appear in the list of available listening modes if either the side or rear speakers are missing from the configuration.

Parameter	Default Setting	Possible Settings
EX DECODING	AUTO	AUTO, ON, OFF
COMPRESSION	OFF	AUTO, ON, OFF
LFE MIX	+0.0dB	-10.0 to +0.0dB
OUTPUT LEVELS	Refer to page 6-37	
CUSTOM	Refer to page 6-37	

See "Listening Mode Menu Option and Parameter Descriptions" on page 6-39 for detailed descriptions.

DOLBY DIGITAL & DOLBY DIGITAL EX



These listening modes are designed to decode and play back 5.1 discrete channels from 5.1-channel Dolby Digital sources. The five main channels are full-frequency. The .1 channel, often referred to as LFE information, has a limited frequency range of 120Hz.

The mode name differs, depending on the encoding present in the input source, the EX DECODING parameter setting and the speaker setup.

The Dolby DIGITAL EX listening mode is recommended for Dolby Digital sources recorded with Dolby Digital Surround EX encoding. This listening mode can also be used with other types of 5.1-channel Dolby Digital sources with mixed results. The table at the bottom of the page shows the conditions for the behavior of the Dolby Digital EX mode when activated.

The Dolby DIGITAL EX listening mode is available when both the side and rear speakers are present and Dolby Digital Surround EX decoding is activated. Matrix decoding is then applied to derive a surround back channel from the other surround channels.

- Dolby Digital Surround EX decoding is activated when the EX DECODING parameter is set to ON or AUTO and a flagged 5.1-channel Dolby Digital source recorded with Dolby Digital Surround EX encoding is detected.

- Dolby Digital Surround EX decoding is not activated when the EX DECODING parameter is set to OFF or AUTO and a non-flagged 5.1-channel Dolby Digital source recorded with or without Dolby Digital Surround EX encoding is detected.

Parameter	Default Setting	Possible Settings
EX DECODING	AUTO	AUTO, ON, OFF
COMPRESSION	OFF	AUTO, ON, OFF
LFE MIX	+0.0dB	-10.0 to +0.0dB
OUTPUT LEVELS	Refer to page 6-37	
CUSTOM	Refer to page 6-37	

Note:

The RV-8 cannot detect Dolby Digital Surround EX encoding in non-flagged 5.1-channel Dolby Digital input sources because they do not include information in the input signal that identifies Dolby Digital Surround EX encoding.

Parameter Setting	Input Source		
	5.1-Channel Dolby Digital	5.1-Channel Surround EX (Flagged)	5.1-Channel Surround EX (Non-Flagged)
EX DECODING: AUTO	DOLBY DIGITAL	DOLBY DIGITAL EX	DOLBY DIGITAL
EX DECODING: ON	DOLBY DIGITAL EX	DOLBY DIGITAL EX	DOLBY DIGITAL EX
EX DECODING: OFF	DOLBY DIGITAL	DOLBY DIGITAL	DOLBY DIGITAL

5.1 2-CHANNEL

MODE ADJUST ▶ 5.1 2-CHANNEL

This mode, recommended for recording purposes, is designed for converting 5.1-channel Dolby Digital-encoded input sources into 2-channel Logic 7-encoded output signals.

The downmixed 5.1-channel Dolby Digital input signals are sent to the Front L/R speakers and subwoofer.

Parameter	Default Setting	Possible Settings
CENTER MIX	+0dB	-25 to +5dB
SURROUND MIX	+0dB	-5 to +5dB
CNTR DLY SAMPLES	+0	-127 to +127
MASTER LEVEL	+0dB	-5 to +5dB
COMPRESSION	OFF	AUTO, ON, OFF
LFE MIX	+0.0dB	-20.0 to +0.0dB
SUB LEVEL	+0dB	OFF, -30 to +12dB
CUSTOM	Refer to page 6-37	

See "Listening Mode Menu Option and Parameter Descriptions" on page 6-39 for detailed descriptions.

5.1 MONO LOGIC

MODE ADJUST ▶ 5.1 MONO LOGIC

This listening mode, designed for playback of Dolby Digital-encoded mono sources, uses proprietary Lexicon reverb algorithms to realistically expand mono sources to use all channels. This dramatically increases the perceived width and sense of envelopment of the listening space.

Note that:

When a 1.0 Dolby Digital source is present, the RV-8 automatically activates the 5.1 MONO LOGIC listening mode.

Parameter	Default Setting	Possible Settings
EFFECT LVL	-9dB	-12 to +6dB
ACADEMY FILTER	ON	ON, OFF
SURR ROLLOFF	3.1kHz	500Hz to 20.0kHz, OFF
OUTPUT LEVELS	Refer to page 6-37	
CUSTOM	Refer to page 6-37	

See "Listening Mode Menu Option and Parameter Descriptions" on page 6-39 for detailed descriptions.

5.1 MONO SURR

MODE ADJUST ► 5.1 MONO SURR

This listening mode, designed for playback of Dolby Digital-encoded mono sources, sends mono signals to all channels.

Parameter

OUTPUT LEVELS	Refer to page 6-37
CUSTOM	Refer to page 6-37

See "Listening Mode Menu Option and Parameter Descriptions" on page 6-39 for detailed descriptions.

5.1 MONO

MODE ADJUST ► 5.1 MONO

This listening mode, designed for playback of Dolby Digital-encoded mono sources, sends mono signals to the center channel and subwoofer.

Parameter	Default Setting	Possible Settings
SUB LEVEL	+0dB	OFF, -30 to +12dB
CUSTOM	Refer to page 6-37	

See "Listening Mode Menu Option and Parameter Descriptions" on page 6-39 for detailed descriptions.

DTS-ES DECODING

The DTS, DTS-ES, and DTS-ES Discr listening modes are designed for, at a minimum, playback of 5.1-channel DTS, 5.1-channel matrix-encoded DTS-ES and 6.1-channel discrete-encoded DTS-ES sources.

The DTS, DTS-ES, and DTS-ES Discr listening mode names differ depending on the encoding present in the input source, the DECODING parameter setting and the speaker setup.

DTS-ES listening modes are available when DTS-ES decoding is activated. The table at the bottom of the page shows the conditions for the behavior of DTS-ES decoding when it is activated.

- DTS-ES decoding is activated when both the side and rear speakers are present and the ES DECODING parameter is set to ON or AUTO and a 5.1-channel matrix-encoded or a 6.1-channel discrete-encoded DTS-ES source is detected.

- DTS-ES decoding is deactivated when the ES DECODING parameter is set to OFF or when the ES DECODING parameter is set to AUTO and a 5.1-channel DTS source is detected.
- DTS-ES Discr mode decodes 6.1-channel discrete-encoded DTS-ES sources when ES decoding is set to AUTO or ON in the MODE ADJUST menu. The mode appears in the Setup menu when a DTS 6.1 source is present and seven speakers are selected in the SPEAKER SETUP menu.

Note:

The table below is not applicable to the DTS-ES THX, DTS THX ULTRA2 and DTS THX MUSIC listening modes. These listening modes will be explained in greater detail later in this manual.

Parameter Setting	Input Source		
	5.1-Channel DTS	5.1-Channel Matrix-Encoded DTS-ES	6.1-Channel Discrete-Encoded DTS-ES
ES DECODING: AUTO	DTS	DTS-ES	DTS-ES
ES DECODING: ON	DTS-ES	DTS-ES	DTS-ES
ES DECODING: OFF	DTS	DTS	DTS

DTS-ES L7 FILM & DTS L7 FILM

MODE ADJUST ►  OR 

These proprietary Lexicon listening modes use an advanced matrix to decode seven channels from 5.1- and 6.1-channel film sources with enhanced front steering. When both side and rear speakers are present, the DTS-ES L7 FILM listening mode also increases the perceived length and sense of envelopment of the listening space.

The listening modes are designed for enhanced playback of 5.1-channel DTS, 5.1-channel matrix-encoded DTS-ES, or 6.1-channel discrete-encoded DTS-ES film sources. The listening mode name differs, depending on the encoding present in the input source, the ES DECODING parameter setting and the speaker setup.

Option/Parameter	Default Setting	Possible Settings
VOCAL ENHANCE	+0.0dB	+6.0dB, +3.0dB, +0.0dB
RE-EQUALIZER	ON	ON, OFF
SOUND STAGE	REAR	REAR, NEUTRAL, FRONT
5 SPKR ENHANCE	ON	ON, OFF
BASS ENHANCE	OFF	ON, OFF
SURR ROLLOFF	7kHz	500Hz to 20kHz, OFF
REAR DLY OFFSET	15ms	OFF, 1 to 30ms
LFE MIX	+0.0dB	-10.0 to +0.0dB
ES DECODING	AUTO	AUTO, ON, OFF
OUTPUT LEVELS	Refer to page 6-37	
CUSTOM	Refer to page 6-37	

See "Listening Mode Menu Option and Parameter Descriptions" on page 6-39 for detailed descriptions.

DTS-ES L7 MUSIC & DTS L7 MUSIC

MODE ADJUST ►  OR 

These proprietary Lexicon listening modes, similar to the DTS-ES L7 FILM listening mode, use an advanced matrix to decode seven channels from 5.1 and 6.1-channel music sources with enhanced front steering to provide remarkable sound improvement compared to other decoders.

The listening modes are designed for enhanced playback of 5.1-channel DTS, 5.1-channel matrix-encoded DTS-ES, or 6.1-channel discrete-encoded DTS-ES music sources. The listening mode name differs, depending on the encoding present in the input source, the ES DECODING parameter setting and the speaker setups.

Option/Parameter	Default Setting	Possible Settings
VOCAL ENHANCE	+0.0dB	+6.0dB, +3.0dB, +0.0dB
FRONT STEERING	MUSIC	OFF, MSURR, MUSIC, FILM
RE-EQUALIZER	OFF	ON, OFF
SOUND STAGE	NEUTRAL	REAR, NEUTRAL, FRONT
5 SPKR ENHANCE	ON	ON, OFF
BASS ENHANCE	OFF	ON, OFF
SURR ROLLOFF	7kHz	500Hz to 20kHz, OFF
REAR DLY OFFSET	15ms	OFF, 1 to 30ms
LFE MIX	+0.0dB	-10.0 to +0.0dB
ES DECODING	AUTO	AUTO, ON, OFF
OUTPUT LEVELS	Refer to page 6-37	
CUSTOM	Refer to page 6-37	

See "Listening Mode Menu Option and Parameter Descriptions" on page 6-39 for detailed descriptions.

DTS-ES THX & DTS THX UL2Cin



The DTS THX UL2Cin (ULTRA2 CINEMA) and DTS-ES THX listening modes allow 7-channel playback of 5.1-channel DTS sources that lack DTS-ES encoding. They are designed for playback of 5.1-channel DTS, 5.1-channel matrix-encoded DTS-ES, or 6.1-channel DTS-ES discrete-encoded film sources. DTS THX UL2Cin and DTS-ES THX are recommended for home theaters with THX-certified speakers. These modes apply:

- THX re-equalization to simulate high-frequency rolloffs that occur in movie theaters. Most films are mixed for movie theaters, and might sound too bright when played back in home theaters without re-equalization.
- THX timbre matching to minimize timbre differences between the front and surround channels, which results in smoother sound movements between them.

The listening mode name differs, depending on the encoding present in the input source, the ES DECODING parameter setting and the speaker setup.

The DTS THX UL2Cin listening mode

The DTS THX UL2Cin listening mode is available when both side and rear speakers are present and THX Ultra2 decoding is activated.

To activate DTS THX UL2Cin decoding:

1. Press MODE ADJUST ► ► DECODING.
2. Use the ▲ or ▼ arrow to select either AUTO (the default) or OFF.

When the ES DECODING parameter is set to OFF, the DTS-ES THX UL2 Cin listening mode is always active. When the parameter is set to AUTO, the DTS-ES THX UL2 Cin listening mode activates when a 5.1-channel DTS source is detected.

When THX UL2Cin decoding is activated:

- Adaptive de-correlation is applied to increase the perceived width of the listening space. De-correlation of the mono surround channel increases the perceived width of the surround field in home theaters.
- ASA processing is applied to signals sent to the rear speakers. Refer to the ASA parameter description on page 3-35 for more information.

The DTS-ES THX listening mode

The DTS-ES THX listening mode is available when both the side and rear speakers are present and DTS-ES decoding is active.

DTS-ES decoding is activated when the ES DECODING parameter is set to AUTO (the default) or ON and a 5.1-channel matrix-encoded or 6.1-channel discrete-encoded DTS-ES source is detected.

The table on the next page shows the conditions for the behavior of the DTS THX UL2Cin and DTS-ES THX modes when activated:

Option/Parameter	Default Setting	Possible Settings
RE-EQUALIZER	ON	ON, OFF
LFE MIX	+0.0dB	-10.0 to +0.0dB
ES DECODING	AUTO	AUTO, ON, OFF
OUTPUT LEVELS	Refer to page 6-37	
CUSTOM	Refer to page 6-37	

See "Listening Mode Menu Option and Parameter Descriptions" on page 6-39 for detailed descriptions.

DTS-ES THX & DTS THX UL2CIN (continued)

Parameter Setting	Input Source		
	5.1-Channel DTS	5.1-Channel Matrix-Encoded DTS-ES	6.1-Channel Discrete-Encoded DTS-ES
ES DECODING: AUTO	DTS THX UL2Cin	DTS-ES THX	DTS-ES THX
ES DECODING: ON	DTS-ES THX	DTS-ES THX	DTS-ES THX
ES DECODING: OFF	DTS THX UL2Cin	DTS THX UL2Cin	DTS THX UL2Cin

DTS THX MUSIC



The DTS THX MUSIC listening mode is designed for playback of 5.1-channel DTS music sources when the side and rear speakers are present. ASA processing is applied to signals sent to the rear speakers. Refer to the ASA parameter description on page 3-35 for more information. This mode is recommended for home theaters with THX-certified speaker setups.

Option/Parameter	Default Setting	Possible Settings
LFE MIX	+0.0dB	-10.0 to +0.0dB
OUTPUT LEVELS	Refer to page 6-37	
CUSTOM	Refer to page 6-37	

See "Listening Mode Menu Option and Parameter Descriptions" on page 6-39 for detailed descriptions.

Note:

The DTS THX MUSIC is a dynamic listening mode and can only be activated with the front-panel or remote control Mode ▲ and ▼ buttons.

DTS, DTS-ES & DTS(-ES) Discr

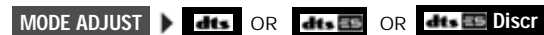

This mode decodes 5.1 matrix or 6.1 discrete channels from DTS-ES sources. It is designed for playback of 5.1-channel DTS, 5.1-channel matrix-encoded DTS-ES, and 6.1-channel discrete-encoded DTS-ES sources.

The six decoded main channels are full-frequency. The .1 channel, often referred to as LFE information, has a limited frequency range of 120Hz.

The listening mode name differs, depending on the encoding present in the input source, the DECODING parameter setting, and the speaker setup. Refer to page 6-25 for more information.

Option/Parameter	Default Setting	Possible Settings
LFE MIX	+0.0dB	-10.0 to +0.0dB
ES DECODING	AUTO	AUTO, ON, OFF
OUTPUT LEVELS	Refer to page 6-37	
CUSTOM	Refer to page 6-37	

See "Listening Mode Menu Option and Parameter Descriptions" on page 6-39 for detailed descriptions.

DTS 2-CHAN & DTS-ES 2-CHAN

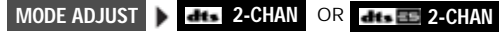

These modes, recommended for recording purposes, send downmixed 5.1-channel or 6.1-channel DTS-ES input signals to the front speakers and subwoofer as 2-channel Logic 7-encoded output signals.

Option/Parameter	Default Setting	Possible Settings
CENTER MIX	+0dB	-25 to +5dB
SURROUND MIX	+0dB	-5 to +5dB
CNTR DLY SAMPLES	+0	-127 to +127
MASTER LEVEL	+0dB	-5 to +5dB
LFE MIX	+0.0dB	-20.0 to +0.0dB
ES DECODING	AUTO	AUTO, ON, OFF
SUB LEVEL	+0dB	OFF, -30 to +12dB
CUSTOM	Refer to page 6-37	

See "Listening Mode Menu Option and Parameter Descriptions" on page 6-39 for detailed descriptions.

5.1a L7 FILM



The 5.1a LOGIC7 FILM listening mode is a proprietary Lexicon listening mode that uses LOGIC7 decoding to derive seven channels from 5.1-channel analog film sources with enhanced front steering.

This listening mode allows 5.1-channel analog sources to use bass management, speaker crossovers, speaker distance calibration, and audio controls (tone controls).

Option/Parameter	Default Setting	Possible Settings
VOCAL ENHANCE	+0.0dB	+6.0dB, +3.0dB, +0.0dB
RE-EQUALIZER	ON	ON, OFF
SOUND STAGE	REAR	REAR, NEUTRAL, FRONT
5 SPKR ENHANCE	ON	ON, OFF
BASS ENHANCE	OFF	ON, OFF
SURR ROLLOFF	7kHz	500Hz to 20kHz, OFF
REAR DLY OFFSET	15ms	OFF, 1 to 30ms
LFE MIX	+0.0dB	-10.0 to +0.0dB
OUTPUT LEVELS	Refer to page 6-37	
CUSTOM	Refer to page 6-37	

See "Listening Mode Menu Option and Parameter Descriptions" on page 6-39 for detailed descriptions.

5.1a L7 MUSIC

MODE ADJUST ▶ 5.1a  MUSIC

The 5.1a LOGIC7 MUSIC listening mode is similar to the 5.1a LOGIC7 FILM listening mode, but specifically tailored for music sources. This mode is designed and recommended for playback of 5.1-channel analog music sources.

Option/Parameter	Default Setting	Possible Settings
VOCAL ENHANCE	+0.0dB	+6.0dB, +3.0dB, +0.0dB
FRONT STEERING	MUSIC	OFF, MSURR, MUSIC, FILM
RE-EQUALIZER	OFF	ON, OFF
SOUND STAGE	NEUTRAL	REAR, NEUTRAL, FRONT
5 SPKR ENHANCE	ON	ON, OFF
BASS ENHANCE	OFF	ON, OFF
SURR ROLLOFF	7kHz	500Hz to 20kHz, OFF
REAR DLY OFFSET	15ms	OFF, 1 to 30ms
LFE MIX	+0.0dB	-10.0 to +0.0dB
OUTPUT LEVELS	Refer to page 6-37	
CUSTOM	Refer to page 6-37	

See "Listening Mode Menu Option and Parameter Descriptions" on page 6-39 for detailed descriptions.

5.1a THX UL2Cin, 5.1a THX SurEX & 5.1a THX

MODE ADJUST ▶ 5.1a  OR 5.1a  OR 5.1a 

The 5.1a THX UL2Cin, 5.1a THX SurEX, and 5.1a THX listening modes are designed to convert 5.1-channel analog film sources that lack THX Surround EX encoding into seven channel audio. The modes also allow 5.1-channel analog sources to use bass management, speaker crossovers, speaker distance calibration, and audio controls (tone controls). The 5.1a THX UL2Cin, 5.1a THX SurEX, and 5.1a THX listening modes are recommended for home theaters with THX-certified speakers. These modes apply:

- THX re-equalization to simulate high-frequency rolloffs that occur in movie theaters. Most films are mixed for movie theaters, and might sound too bright when played back in home theaters without re-equalization.
- THX timbre matching to minimize timbre differences between the front and surround channels, which results in smoother sound movements between them.

The listening mode name differs depending on the encoding present in the input source, the SURROUND EX parameter setting, and the speaker setup.

The table at the top of the next page indicates the conditions in which THX Ultra2 and THX Surround EX decoding are activated.

Parameter Setting	Input Source		
	5.1-Channel Analog	5.1-Channel THX Surround EX Analog (Flagged)	5.1-Channel THX Surround EX Analog (Non-Flagged)
SURROUND EX: ON	5.1a THX SurEX	5.1a THX SurEX	5.1a THX SurEX
SURROUND EX: OFF	5.1a THX ULTRA2	5.1a THX ULTRA2	5.1a THX ULTRA2

The 5.1a THX UL2Cin listening mode

The 5.1a THX UL2Cin listening mode is available when both side and rear speakers are present and THX Ultra2 decoding is active. THX Ultra2 decoding is activated when the SURROUND EX parameter is set to OFF. When THX Ultra2 decoding is activated:

- Adaptive de-correlation is applied to increase the perceived width of the listening space. De-correlation of the mono surround channel increases the perceived width of the surround field in home theaters.
- ASA processing is applied to signals sent to the rear speakers. Refer to the ASA parameter description on page 3-35 for more information.

The 5.1a THX SurEX listening mode

The 5.1a THX SurEX listening mode is available when both side and rear speakers are present and THX surround EX decoding is active. THX Surround EX decoding is activated when the SURROUND EX parameter is set to ON.

When THX Surround EX decoding is activated Matrix decoding is applied to derive three surround channels from 5.1-channel analog sources.

The 5.1a THX listening mode

The 5.1a THX listening mode is available when neither THX Ultra2 nor THX Surround EX decoding is active.

Parameter	Default Setting	Possible Settings
RE-EQUALIZER	ON	ON, OFF
SURROUND EX	OFF	ON, OFF
LFE MIX	+0.0dB	-10.0 to +0.0dB
OUTPUT LEVELS	Refer to page 6-37	
CUSTOM	Refer to page 6-37	

See "Listening Mode Menu Option and Parameter Descriptions" on page 6-39 for detailed descriptions.

5.1a THX MUSIC

MODE ADJUST ▶ 5.1a THX MUSIC

The 5.1a THX MUSIC listening mode is designed for playback of 5.1-channel analog music sources. It cannot be activated unless side and rear speakers are present. This mode performs best in home theaters where the rear speaker are placed close together.

ASA processing is applied to signals sent to the rear speakers. Refer to the ASA parameter description on page 3-35 for more information.

Option/Parameter	Default Setting	Possible Settings
LFE MIX	+0.0dB	-10.0 to +0.0dB
OUTPUT LEVELS	Refer to page 6-37	
CUSTOM	Refer to page 6-37	

See "Listening Mode Menu Option and Parameter Descriptions" on page 6-39 for detailed descriptions.

Note:

The 5.1a THX MUSIC listening mode can only be activated with the front-panel or remote control Mode buttons.

5.1a STANDARD

MODE ADJUST ▶ 5.1a STANDARD

This mode allows 5.1-channel analog sources to use bass management, speaker crossovers, speaker distance calibration, and audio controls (tone controls). When these features are not used, the 5.1a STANDARD listening mode is similar to the 5.1a BYPASS listening mode. The 5.1a STANDARD mode sends identical signals (with appropriate time delays) to the Main Zone audio output connectors labeled Side L and Rear as well as Side R and Rear R.

Parameter

OUTPUT LEVELS	Refer to page 6-37
CUSTOM	Refer to page 6-37

See "Listening Mode Menu Option and Parameter Descriptions" on page 6-39 for detailed descriptions.

5.1a 2-CHANNEL

MODE ADJUST ► 5.1a 2-CHANNEL

This mode downmixes 5.1-channel analog input signals into 2-channel LOGIC7-encoded output signals. It sends these signals to the front speakers and the subwoofer. It is recommended for recording purposes, particularly for recording from a DVD-A or multi-channel SACD player to a CD-R or another 2-channel recording format.

Parameter	Default Setting	Possible Settings
CENTER MIX	+0dB	-25 to +5dB
SURROUND MIX	+0dB	-5 to +5dB
CNTR DLY SAMPLES	+0	-127 to +127
MASTER LEVEL	+0dB	-5 to +5dB
LFE MIX	+0.0dB	-20.0 to +0.0dB
SUB L/R LVL	+0dB	OFF, -30 to +12dB
CUSTOM	Refer to page 6-37	

See "Listening Mode Menu Option and Parameter Descriptions" on page 6-39 for detailed descriptions.

5.1a BYPASS

MODE ADJUST ► 5.1a BYPASS

- Designed for playback of 5.1-channel analog sources, such as DVD-A or SACD players.
- Sends the 5.1-channel analog audio input connector directly to the Main Zone volume control and audio output connectors, as shown on pages 2-9 and 3-59. These signals receive no internal processing.
- When both side and rear speakers are present, surround channel signals are sent in parallel to the side and rear speakers. To configure a 5-channel speaker setup, set the OUTPUT LEVELS menu SIDE L/R or REAR L/R parameter to OFF to deactivate the associated surround speakers.
- Pressing the remote control HOME/MAIN/AGE2/A BYP then 2CH buttons toggles the MAIN ADV menu ANALOG BYPASS parameter between ON and OFF.

Parameter	Default Setting	Possible Settings
OUTPUT LEVELS	Refer to page 6-37	
CUSTOM	Refer to page 6-37	

Note:

Speaker crossover settings, speaker distances and audio (tone) controls are not available when the 5.1a BYPASS listening mode is activated.

2CH BYPASS

MODE ADJUST ► 2CH BYPASS

This listening mode sends 2-channel analog audio input signals to the Main Zone audio output connectors labeled Front L/R with no internal processing.

The 2CH BYPASS listening mode is automatically activated whenever a 2-channel analog source is present and the MAIN ADV menu ANALOG BYPASS parameter is set to ON. The 2CH BYPASS listening mode is not available when a digital source is present and the MAIN ADV menu INPUT SELECT parameter is set to AUTO.

Pressing the remote control HOME/MAIN/PAGE2/A BYP button then 2CH buttons toggles the MAIN ADV menu ANALOG BYPASS parameter between ON and OFF.

Note:

Speaker crossover settings, speaker distances and audio controls (tone) are not available when the 2CH BYPASS listening mode is activated.

HEADPHONE L7

MODE ADJUST ► HEADPHONE L7

HEADPHONE L7 is a proprietary Lexicon listening mode designed for enhanced playback of 2-channel sources through headphones. This listening mode uses LOGIC7 processing and Head Related Transfer Functions to realistically increase the perceived sense of envelopment when listening through headphones.

The HEADPHONE listening mode is recommended for 2-channel sources when listening through headphones. No parameters for the HEADPHONE listening mode are available.

HEADPHONE 5.1

MODE ADJUST ► HEADPHONE 5.1

HEADPHONE 5.1 is a proprietary Lexicon listening mode designed for enhanced playback of Dolby Digital-encoded music or film sources through headphones. This listening mode uses LOGIC7 processing and Head Related Transfer Functions to realistically increase the perceived sense of envelopment when listening through headphones.

The HEADPHONE 5.1 listening mode is recommended for Dolby Digital-encoded sources when listening through headphones. No parameters for the HEADPHONE 5.1 listening mode are available.

HEADPHONE DTS

MODE ADJUST ► HEADPHONE 

HEADPHONE DTS is a proprietary Lexicon listening mode designed for enhanced playback of DTS(-ES)-encoded music or film sources through headphones. This listening mode uses LOGIC7 processing and Head Related Transfer Functions to realistically increase the perceived sense of envelopment when listening through headphones.

The HEADPHONE DTS listening mode is recommended for DTS-encoded sources when listening through headphones. No parameters for the HEADPHONE DTS listening mode are available.

HEADPHONE 5.1a

MODE ADJUST ► HEADPHONE 5.1a

HEADPHONE 5.1a is a proprietary Lexicon listening mode designed for enhanced playback of 5.1-channel analog music or film sources through headphones. This listening mode uses LOGIC7 processing and Head Related Transfer Functions to realistically increase the perceived sense of envelopment when listening through headphones.

The HEADPHONE 5.1a listening mode is recommended for 5.1-channel analog sources when listening through headphones. No parameters for the HEADPHONE 5.1a listening mode are available.

LIVE! SMALL, LIVE! MED & LIVE! LARGE

MODE ADJUST ► LIVE! SMALL OR LIVE! MED OR LIVE! LARGE

LIVE! (Lexicon Intelligent Variable Environment) is a proprietary mode designed to transform the way your listening room sounds. It provides a realistic illusion of a larger, more reverberant listening space. LIVE! SMALL simulates the reverberations of a room that is small, but larger than an average living room. LIVE! MED simulates the reverberations of a small hall. LIVE! LARGE simulates the reverberations of a large hall. LIVE! requires two permanently mounted microphones. (See "LIVE! CALIBRATION" on page 3-80 for placement and calibration instructions.) LIVE! cannot be used with prerecorded sources such as CDs or DVDs.

LIVE! SMALL parameter settings:

Parameter	Default Setting	Possible Settings
MID RT	597ms	115ms to 15.4s
BASS RT	597ms	23ms to 30.8ms
ROLLOFF	3.1kHz	500Hz to 20kHz
TREB CUT RT	3.1kHz	500Hz to 20kHz
PRE-DELAY	10ms	10ms to 100ms
ADVANCED		
CUSTOM	Refer to page 6-37	

LIVE! SMALL ADVANCED parameter settings:

Parameter	Default Setting	Possible Settings
REVERB LVL	+0dB	-80dB to +0dB
EARLY RFLX LVL	-13dB	-80dB to +12dB
BASS XOVER	156Hz	30Hz to 19.9kHz, OFF
SHAPE	0	0 to 4
SPREAD	0%	0% to 100%
SIZE	19m	4m to 60m

LIVE! MED parameter settings:

Parameter	Default Setting	Possible Settings
MID RT	1.84s	115ms to 15.4s
BASS RT	2.76s	23ms to 30.8ms
ROLLOFF	2.4kHz	500Hz to 20kHz
TREB CUT RT	3.1kHz	500Hz to 20kHz
PRE-DELAY	18ms	10ms to 100ms
ADVANCED		
CUSTOM	Refer to page 6-37	

LIVE! MED ADVANCED parameter settings:

Parameter	Default Setting	Possible Settings
REVERB LVL	-4dB	-80dB to +0dB
EARLY RFLX LVL	-14dB	-80dB to +12dB
BASS XOVER	156Hz	30Hz to 19.9kHz, OFF
SHAPE	2	0 to 4
SPREAD	25%	0% to 100%
SIZE	30m	4m to 60m

LIVE! LARGE parameter settings:

Parameter	Default Setting	Possible Settings
MID RT	4.71s	115ms to 30.8s
BASS RT	4.71s	23ms to 30.8ms
ROLLOFF	3.1kHz	500Hz to 20kHz
TREB CUT RT	2.4kHz	500Hz to 20kHz
PRE-DELAY	20ms	10ms to 100ms
ADVANCED		
CUSTOM	Refer to page 6-37	

LIVE! LARGE ADVANCED parameter settings:

Parameter	Default Setting	Possible Settings
REVERB LVL	-6dB	-80dB to +0dB
EARLY RFLX LVL	-17dB	-80dB to +12dB
BASS XOVER	156Hz	30Hz to 19.9kHz, OFF
SHAPE	2	0 to 4
SPREAD	28%	0% to 100%
SIZE	38m	4m to 60m

See "Listening Mode Menu Option and Parameter Descriptions" on page 6-39 for detailed descriptions.

OUTPUT LEVELS

MODE ADJUST ▶ Listening Mode ▶ OUTPUT LEVELS

OUTPUT LEVELS	
CENTER	+0dB
SIDE L/R	+0dB
REAR L/R	+0dB
SUB	+0dB

Opens the OUTPUT LEVELS menu, which is used to adjust output levels for the Main Zone audio output connectors labeled Center, Subwoofer, Side L/R and Rear L/R.

The OUTPUT LEVELS option does not appear on listening mode menus when the selected listening mode does not accommodate multichannel output signals. Instead, an output-specific parameter appears. For example, the MONO listening mode menu includes a SUB LVL parameter.

Parameter	Default Setting	Possible Settings
CENTER	+0dB	OFF, -30 to +12dB
SIDE L/R	+0dB	OFF, -30 to +12dB
REAR L/R	+0dB	OFF, -30 to +12dB
SUB	+0dB	OFF, -30 to +12dB

See "Listening Mode Menu Option and Parameter Descriptions" on page 6-39 for detailed descriptions.

CUSTOM

MODE ADJUST ▶ (Listening Mode) ▶ CUSTOM

Opens the CUSTOM menu, which can be used to compare custom and factory-default versions of the selected listening mode and to restore the factory-default version of the selected listening mode.

CUSTOM VS PRESET

MODE ADJUST ▶ (Listening Mode) ▶ CUSTOM ▶ CUSTOM VS PRESET

Allows comparison listening between the custom and factory-default versions of the selected listening mode. When PRESET is selected, the listening mode is heard in its factory-default condition, as if all listening mode menu parameters were set to their factory-default settings.

When CUSTOM is selected, the listening mode is heard in its custom condition, including all current listening mode menu parameter settings. The PRESET and CUSTOM versions of the selected listening mode will sound identical when all listening mode menu parameters are set to their factory-default settings.

Note:

The CUSTOM VS PRESET option does not affect current listening mode menu parameter settings.



To toggle between the custom and factory-default versions of the selected listening mode:

1. Follow the CUSTOM VS PRESET menu path to open the CUSTOM VS PRESET drop-down menu.
2. When the CUSTOM VS PRESET option drop-down menu is open, press the remote control ▲ and ▼ arrow buttons to toggle between the PRESET (factory-default) and CUSTOM versions of the selected listening mode.
3. When finished, press the ◀ arrow button to close the CUSTOM VS PRESET drop-down menu.

RESET MODE

MODE ADJUST ► (Listening Mode) ► CUSTOM ► RESET MODE

Restores the factory-default version of the selected listening mode, restoring all listening mode menu parameters to their factory default settings.

To restore the factory-default version of the selected listening mode:

1. Follow the RESET MODE menu path to select the RESET MODE option. The PRESS RIGHT → TO RESTORE MODE message appears in the on-screen display.



2. Press the ► arrow button to restore the factory-default version of the selected listening mode. Press the ◀ arrow button to close the message without restoring the factory-default.

Note:

When the CUSTOM menu RESET MODE option is selected to restore the factory-default version of the selected listening mode, the corresponding TRIGGER SETUP menu listening mode parameter is automatically set to OFF.

LISTENING MODE MENU OPTION and PARAMETER DESCRIPTIONS

5 SPKR ENHANCE ON, OFF

Simulates 7-channel playback in 5-channel speaker configurations. When set to ON, the RV-8 provides an increased sense of spaciousness and envelopment through the surround speakers. This enhancement is most noticeable when the surround speakers are positioned to the side of the primary listening position, or when the primary listening position is located against the rear wall. The effectiveness of this parameter varies within the listening space. For best results, it is recommended that you position the surround speakers to the left and right sides of the primary listening position.

ACADEMY FILTER ON, OFF

When set to ON, restores the proper tonal balance of older mono film sources that have much narrower frequency responses than more recent mono film sources.

AUTO AZIMUTH ON, OFF

Maximizes matrix steering accuracy. When set to ON, the RV-8 continually monitors the 2-channel input signal and automatically adjusts the relative level and time offset of the input channels to ensure that signals are sent to the appropriate channels with maximum separation. When set to OFF, the accuracy of the selected listening mode varies among sources. It is recommended that you set this parameter to ON for film and broadcast sources and to OFF for music sources.

BASS CONTENT BINAURAL, MONO, STEREO

Adjusts the bass content of binaural, mono and stereo recordings. When set to BINAURAL, the RV-8 activates low-frequency compensation. Select this setting for true binaural sources recorded with dummy head microphones. Select the MONO setting for sources

recorded with mono bass. Select the STEREO setting for sources recorded with stereo bass.

BASS ENHANCE ON, OFF

Enhances stereo bass, which results in low-frequency reproduction that is less localizable and more realistic in the listening space. The effectiveness of the BASS ENHANCE parameter varies, depending on room acoustics and the ability of the surround speakers to reproduce low frequencies. It is recommended that you use front, side or rear speakers that are capable of reproducing frequencies of 40Hz or lower.

BASS RT 5ms to 48.6s

Works with the MID RT and SIZE parameters to adjust the amount of time required for low-frequency information to decay below 60dB in level. The BASS RT parameter setting should match the MID RT parameter setting for more natural effects in smaller listening spaces.

CAUTION!
Setting the BASS RT, MID RT and SIZE parameters to a high value may produce undesirable or damaging audio.

BASS XOVER 30Hz to 19.9kHz, OFF

Sets the frequency to which BASS RT applies.

CALIBRATION

Opens the PANORAMA listening mode CALIBRATION menu, which is used to calibrate the PANORAMA listening mode. Refer to "PANORAMA" on page 6-13 for more information.

LISTENING MODE MENU OPTION and PARAMETER DESCRIPTIONS (continued)**CENTER** OFF, -30 to +12dB

Controls the output level of the audio output connector labeled Center. Available in all except 2 CH modes (2-CHANNEL, 2 CH BYPASS, DTS(-ES) 2-CHAN, 5.1 2-CHANNEL), MONO, 5.1 MONO and LIVE! modes.

CENTER DEPTH 0 to 18

Adjusts the amount of processing applied to the center channel, changing the perceived distance of the center speaker. Higher settings increase and lower settings decrease the perceived distance of the center speaker from the listening position. Available in NIGHTCLUB, CONCERT HALL, CHURCH and CATHEDRAL modes.

CENTER MIX -25 to +5dB

Indicates the relative center channel level for downmixing. Set this parameter to +0dB for film sources and -5dB for music sources. Available in 5.1 2-CHANNEL and DTS(-ES) 2-CHAN modes.

CNTR DLY SAMPLES -127 to +127

Controls the relative time offset of the center channel. Set this parameter to +0 unless the center channel is not properly timed and the value of the error is known. Available in 5.1 2-CHANNEL and DTS(-ES) 2-CHAN modes.

COMPRESSION AUTO, ON, OFF

Reduces wide volume level changes and increases dialogue intelligibility at lower listening levels for Dolby Digital input sources. When ON, full compression is applied, regardless of volume level. When OFF, compression is not applied. Set this parameter to AUTO or ON for Dolby Digital input sources that are listened to at lower volume levels,

especially for nighttime viewing to avoid disturbing others. Available in all Dolby Digital modes.

CTR WIDTH MIN, 1 to 6, MAX

Adjusts the center image. When set to MIN, the center image is heard from just the center speaker. When set to MAX, the center image is heard as a "phantom" center image from the front left and right speakers. When set on the 1 to 6 scale, the center image is heard in various combinations of the front and center speakers. Available in Dolby PLII MUSIC and Dolby PLIIX MUSIC modes.

CUSTOM

Opens the CUSTOM menu, which is used to compare custom and factory-default versions of the selected listening mode and to restore the factory default version of the selected listening mode. Available in all modes.

CUSTOM VS PRESET

Allows comparison listening to the custom and factory-default versions of the selected listening mode. Refer to page 5-32 for information. Available in all modes.

DIMENSION FRONT, NEUTRAL, REAR

Controls the relative balance of the sound field, which can be useful with certain recordings to achieve a more suitable balance among all speakers. When set to FRONT, the sound field is balanced toward the front of the listening space. When set to NEUTRAL, the sound field is balanced at the center of the listening space. When set to REAR, the sound field is balanced toward the rear of the listening space. Available in Dolby PLII MUSIC and Dolby PLIIX MUSIC modes.

EARLY RFLX LVL -80dB to +12dB, OFF
Controls the amount of additional early reflections. Available in all LIVE! modes.

EFFECT LVL -12 to +6dB
Adjusts the amount of effect applied to the listening mode. Available in NIGHTCLUB, CONCERT HALL, CHURCH, CATHEDRAL, PANORAMA, MONO LOGIC and 5.1 MONO LOGIC modes.

ES DECODING AUTO, ON, OFF
Controls DTS-ES decoding, which extracts a rear channel from 5.1-channel DTS, 5.1-channel matrix-encoded DTS-ES and 6.1-channel discrete-encoded DTS-ES sources. When ON is selected, DTS-ES decoding is activated for all DTS-ES sources. When OFF is selected, DTS-ES decoding is deactivated for all DTS-ES sources.

DTS-ES decoding is activated when AUTO is selected and a 5.1-channel matrix-encoded or a 6.1-channel discrete-encoded DTS-ES source is detected. DTS-ES decoding is deactivated when a 5.1-channel DTS source is detected.

DTS-ES listening modes are available when DTS-ES decoding is engaged. DTS listening modes are available when DTS-ES decoding is not engaged. Refer to the DTS-ES Decoding section that begins on page 5-25 for more information.

Note the following:

- DTS-ES decoding cannot be engaged unless both side and rear speakers are present.
- The DTS-ES STATUS menu includes an SB level meter when the ES DECODING parameter is set to ON and a 5.1-channel DTS source is present or when the ES DECODING parameter is set to AUTO and a 5.1-channel matrix-encoded or 6.1-channel

discrete-encoded DTS-ES source is present.

This parameter is available in all DTS modes.

EX DECODING AUTO, ON, OFF

Controls Dolby Digital Surround EX decoding, which extracts a rear channel from 5.1-channel Dolby Digital sources recorded with or without Dolby Digital Surround EX. When ON, Dolby Digital Surround EX decoding is engaged for all 5.1-channel Dolby Digital sources. When OFF, Dolby Digital Surround EX decoding is disengaged for all 5.1-channel Dolby Digital sources.

When AUTO is selected, Dolby Digital Surround EX decoding is engaged when a flagged 5.1-channel Dolby Digital source recorded with Dolby Digital Surround EX encoding is detected. Dolby Digital Surround EX decoding is not engaged when a non-flagged 5.1-channel Dolby Digital source recorded with or without Dolby Digital Surround EX encoding is detected.

Note:

The RV-8 cannot automatically detect Dolby Digital Surround EX encoding in non-flagged 5.1-channel Dolby Digital sources. A non-flagged input source does not identify Dolby Digital Surround EX encoding in the input signal.

The Dolby DIGITAL EX listening mode is available when Dolby Digital Surround EX decoding is engaged. The Dolby DIGITAL listening mode is available when Dolby Digital Surround EX decoding is not engaged. Refer to the Dolby DIGITAL EX & Dolby DIGITAL listening mode descriptions that begin on page 5-22 for more information.

Note the following:

- Dolby Digital Surround EX decoding cannot be engaged unless both side and rear speakers are present.

LISTENING MODE MENU OPTION and PARAMETER DESCRIPTIONS *(continued)*

- This parameter is available in 5.1 PLIIx MOV, 5.1 PLIIx MUS, DOLBY DIGITAL EX and DOLBY DIGITAL modes.
- When the Shift command bank is activated, pressing the remote control DOLBY button while a 5.1-channel Dolby Digital source is present activates the Dolby DIGITAL EX or Dolby DIGITAL listening mode. Subsequent presses adjust the EX DECODING parameter, cycling through the AUTO, ON and OFF settings.

FRONT STEERING OFF, MSURR, MUSIC, FILM

Adjusts front steering between the front left, front right, and center speakers. When set to FILM, maximum front steering is applied to the center channel. When set to MUSIC, moderate front steering is applied. When set to MSURR, minimum front steering is applied. When set to OFF, no front steering is applied. It is recommended that you set this parameter to FILM for film and broadcast sources and to MUSIC, MSURR or OFF for music sources. Available in L7 TV, L7 MUSIC, L7 MUSIC SURR, all 5.1 L7 modes and all DTS L7 modes.

INPUT BALANCE L< to <|> to >R

Controls the balance of the selected stereo analog audio input connectors, compensating for audio input sources with audible channel imbalance. Available in PANORAMA mode.

LFE MIX -20.0 or -10.0 to +0.0dB

Controls the output level of LFE information – the .1 channel in a 5.1- or 6.1-channel input source – that is sent to the audio output labeled Subwoofer. Low frequencies from up to seven other channels might be combined with the LFE information to create the subwoofer output signal, which significantly increases subwoofer output levels.

Careful adjustment of this parameter allows achievement of proper tonal balance and reduces the risk of subwoofer overload. When the speaker setup does not include a subwoofer, LFE information is mixed into speakers for which the corresponding CUSTOM SETUP menu parameter is set to FULL or to the lowest crossover points. Available in all Dolby Digital modes except MONO modes (5.1 MONO LOGIC, 5.1 MONO SURR, 5.1 MONO) and all DTS modes.

LISTENER POS -127 to +127

Compensates for primary listening positions that are not centered between the front left and right speakers. Each increment within the -127 to +127 parameter range represents about one-third of an inch. Refer to the Calibration section that begins on page 5-13 for more information. Available in PANORAMA CALIBRATION mode.

Note:

The LISTENER POS parameter range might extend past the location of the front left and right speakers.

LIVENESS 30ms to 20.2s

Depends on the SIZE parameter setting. The LIVENESS parameter adjusts the amount of effect recirculation. Higher settings mimic more reflective surfaces and increase decay time. Available in NIGHTCLUB and CONCERT HALL modes.

LOW FREQ WIDTH -25 to +25dB

Applies low-frequency spatial correction to the input signal. This correction is applied to uncorrelated input signals below 60Hz. Available in PANORAMA mode.

MASTER LEVEL -5 to +5dB

Adjusts the output level of 2-channel Logic 7-encoded sources. Available in 5.1 2-CHANNEL and DTS(-ES) 2-CHAN modes.

MID RT 24ms to 24.3s

Works with the SIZE parameters to adjust the amount of time required for mid-frequency information to decay below 60dB in level. The full parameter range might not be available depending on the SIZE parameter setting. Available in CHURCH, CATHEDRAL and all LIVE! modes.

CAUTION!

Setting the BASS RT, MID RT or SIZE parameters to a high value may produce undesirable or damaging audio.

OUTPUT LEVELS

Opens the OUTPUT LEVELS menu, which is used to adjust output levels for the Main Zone audio output connectors labeled Center, Subwoofer, Side L/R and Rear L/R. Refer to page 5-32 for more information. Available in all except 2-CHANNEL, MONO, 5.1 2-CHANNEL, 5.1 MONO, DTS (-ES) 2-CHAN, 2CH BYPASS and LIVE! modes.

PANORAMA ON, OFF

When set to ON, Dolby PLII MUSIC and Dolby PLIIx MUSIC listening modes extend the front stereo image to include surround channel signals, which creates a “wraparound” effect with side wall imaging. Available in Dolby PLII MUSIC and Dolby PLIIx MUSIC modes.

Note:

The PANORAMA parameter within the Dolby PLII MUSIC and Dolby PLIIx MUSIC listening modes should not be confused with the separate PANORAMA listening mode (page 6-13).

PRE-DELAY 1 to 100ms, OFF

Adjusts delay time between the direct sound and the onset of reverberation. Higher settings make the simulated space sound larger. Because some pre-delay is inherent in all source material, you should begin with the parameter set to the lowest setting, then make adjustments accordingly. Available in NIGHTCLUB, CONCERT HALL, CHURCH, CATHEDRAL and all LIVE! modes.

RE-EQUALIZER ON, OFF

Simulates high-frequency rolloffs that occur in movie theaters. When set to ON, the RV-8 applies a high-frequency filter. When set to OFF, the RV-8 does not apply a high-frequency filter. It is recommended that you set this parameter to ON for film sources, as many films are mixed for movie theaters and might sound too bright when played back in home theaters without re-equalization. Available in L7 FILM, L7 TV, Dolby PLII + THX, Dolby PLIIx + THX, 5.1 L7 FILM, 5.1 L7 TV, THX ULTRA2, THX SurEX, THX, DTS (-ES) L7 FILM, DTS(-ES) THX ULTRA2 and DTS(-ES) THX modes.

REAR DLY OFFSET OFF, 1 to 30ms

Increases the perceived depth of the listening space by delaying the arrival time of rear speaker signals. It is recommended that you increase the setting when using side and rear speakers that are located close together or when a greater sense of depth is desired in the listening space. Available in all Logic 7 modes and PANORAMA mode.

LISTENING MODE MENU OPTION and PARAMETER DESCRIPTIONS (continued)**REAR L/R** -30 to +12dB, OFF

Controls the output level of the Main Zone audio output connector labeled Rear L/R. Available in all except 2-CHANNEL, MONO, 5.1 2-CHANNEL, 5.1 MONO, DTS (-ES) 2-CHAN, 2CH BYPASS and LIVE! modes.

RESET MODE

Restores the factory-default version of the selected listening mode, restoring all listening mode menu parameters to their factory-default settings. Available in all modes.

REVERB LVL -80 to +0dB, OFF

Controls the amount of added reverb. Available in all LIVE! modes.

ROLLOFF 500Hz to 20.0kHz, OFF

Simulates the absorption of high frequencies in a real space. It is recommended that you begin with a low setting to simulate high-frequency absorptive spaces. Available in NIGHTCLUB, CONCERT HALL, CHURCH, CATHEDRAL and all LIVE! modes.

SHAPE 0 TO 4

Controls the buildup of the energy that most audibly creates the sound of a real room. SHAPE and SPREAD work together – if either is set to zero, the other has no effect. Available in all LIVE! modes.

SIDE L/R -30 to +12dB, OFF

Controls the level of the Side L/R audio output connectors in the Main Zone. Available in all except 2-CHANNEL, MONO, 5.1 2-CHANNEL, 5.1 MONO, DTS (-ES) 2-CHAN, 2CH BYPASS and LIVE! modes.

SIZE 4 to 20 or 30m

Adjusts the length of the listening space within a 4m to 20m or 30m range (depending on the listening mode). Increase the size of the space to increase the reverb effect. Available in NIGHTCLUB, CONCERT HALL, CHURCH, CATHEDRAL and all LIVE! modes.

CAUTION!

Setting the BASS RT, MID RT and SIZE parameters to a high value may produce undesirable or damaging audio.

SOUND STAGE FRONT, NEUTRAL, REAR

Dynamically controls the relative balance of the audio output connectors. When set to FRONT, Side L/R and Rear L/R output levels are attenuated by 6dB, shifting the perceived balance of the sound field to the front of the listening space. When set to NEUTRAL, Side L/R and Rear L/R output levels are slightly attenuated by 3dB, shifting the perceived balance of the sound field to the center of the listening space. When set to REAR, Side L/R and Rear L/R output levels are not attenuated, preserving the intended balance of the sound field. Available in all Logic 7 modes.

SOURCE

RIGHT, LEFT & RIGHT, LEFT

Controls the perceived direction of the PANORAMA listening mode external calibration source signal. When RIGHT is selected, the sound is perceived to come from the right of the primary listening position. When LEFT is selected, the sound is perceived to come from the left of the primary listening position. When LEFT & RIGHT is selected, the sound is perceived to come from all around the primary listening position. Refer to the Calibration section that begins on page 6-13 for more information about the SOURCE parameter. Available in PANORAMA CALIBRATION.

Note:

The SOURCE parameter controls the perceived direction of the sound, although both the front left and right speakers generate the external calibration source signal.

SPEAKER ANGLE

10 to 90deg

Compensates for a wide or narrow speaker angle relative to the primary listening position. Select the setting closest to the angle between the front left and right speakers and the primary listening position. Refer to the Calibration section that begins on page 6-13 for more information about the SPEAKER ANGLE parameter. Available in PANORAMA CALIBRATION.

SPEECH DETECT

ON, OFF

Distinguishes monaural speech from other input sources. When set to ON, effects are lowered to minimize interference and unnatural echo in monaural speech. When stereo input sources are present, the front left and right channels are independently used as inputs for ambience synthesis. When strong monaural speech is present in the input source, the monaural component of the ambience effect is reduced and the stereo component of the effect is increased. When set to OFF, the amount of ambience synthesis is dynamically controlled. Available in NIGHTCLUB, CONCERT HALL, CHURCH and CATHEDRAL modes.

SPREAD

0 to 100%

Controls the timing between the initial reflections that most audibly create the sound of a real room. SHAPE and SPREAD work together; if either is set to 0, the other has no effect. Available in all LIVE! modes.

SUB & SUB LVL

OFF, -30 to +12dB

Controls the output level of the Main Zone audio output connector labeled Subwoofer. The SUB parameter appears on the listening mode OUTPUT LEVELS menu. The SUB LVL parameter appears on listening mode menus when the listening mode does not accommodate multichannel output signals. Available in all except LIVE! modes.

SURR ROLLOFF

500Hz to 20.0kHz, OFF

Applies high-frequency attenuation control to the audio output connectors labeled Side L/R and Rear L/R. This filter is only applied to output signals generated by the RV-8. Available in all Logic 7 modes.

SURROUND DLY

0 to 15ms

Increases the perceived depth of the listening space by delaying the arrival time of signals from the side and rear speakers. It is recommended that you increase the setting when a greater sense of depth is desired in the listening space.

SURROUND EX

AUTO, ON, OFF

Controls the THX Surround EX decoding feature, which can be used to extract a rear channel from 5.1-channel Dolby Digital sources. When ON is selected, THX Surround EX decoding is engaged for all 5.1-channel Dolby Digital sources. When OFF is selected, THX Surround EX decoding is not engaged for all 5.1-channel Dolby Digital sources. Available in THX ULTRA2, THX SurEX and THX modes.

LISTENING MODE MENU OPTION and PARAMETER DESCRIPTIONS (continued)

When AUTO is selected, THX Surround EX decoding is engaged when a flagged 5.1-channel Dolby Digital source with THX Surround EX encoding is detected. THX Surround EX decoding is not engaged when a non-flagged 5.1-channel Dolby Digital source with or without THX Surround EX encoding is detected.

LISTENING MODE MENU OPTION and PARAMETER DESCRIPTIONS (continued)

not engaged when a non-flagged 5.1-channel Dolby Digital source with or without THX Surround EX encoding is detected.

Note:

The RV-8 cannot automatically detect THX Surround EX encoding in non-flagged 5.1-channel Dolby Digital sources. A non-flagged input source does not include information in the input signal that identifies THX Surround EX encoding.

THX Surround EX listening modes are available when Dolby Digital Surround EX decoding is engaged. THX or THX ULTRA2 listening modes are available when THX Surround EX decoding is not engaged. Refer to the 5.1 THX ULTRA2, 5.1 THX SurEX and 5.1 THX listening mode descriptions that begin on page 6-18, or the DTS THX ULTRA2 and DTS-ES THX listening mode descriptions that begin on page 6-27 for more information.

Note the following:

- Toggling the SURROUND EX parameter setting produces low level clicks in the front speakers.
- THX Surround EX decoding cannot be engaged unless both side and rear speakers are present.

SURROUND MIX

-5 to +5dB

Controls the relative level of surround channel information sent to the audio output connectors labeled Front L/R. It is recommended that you set this parameter to +2dB or +3dB for all input sources. Available in 5.1 2-CHANNEL and DTS (-ES) 2-CHAN modes.

TREB CUT RT

500Hz to 20kHz

Sets the frequency above which high frequencies are rolled off in the reverberated signal, causing reverberated signals to grow progressively darker. This results in a more natural sound because it simulates the effect of air absorption in a real hall. Setting this parameter to a low frequency dampens the audio as it re-circulates, and consequently can actually shorten the reverb time. Available in all LIVE! modes.

VOCAL ENHANCE

+6.0dB, +3.0dB, +0.0dB

Controls the level of dialog-boost in the audio output connector labeled Center. Increase this setting to improve dialog intelligibility, particularly at lower volume levels. Available in all Logic 7 modes.

MODE – PARAMETER RELATIONSHIPS

The following table lists each parameter and the modes in which it is used.

The parameter...	Is used in these modes
5 SPKR ENHANCE	All L7 modes
ACADEMY FILTER	MONO LOGIC and 5.1 MONO LOGIC
AUTO AZIMUTH	L7 FILM and L7 TV
BASS CONTENT	PANORAMA
BASS ENHANCE	All L7 modes
BASS RT	CHURCH, CATHEDRAL and all LIVE! modes
CALIBRATION	PANORAMA
CENTER	All except 2 CH modes (2-CHANNEL, 2 CH BYPASS, DTS(-ES) 2-CHAN, 5.1 2-CHANNEL, MONO, 5.1 MONO and LIVE! modes)
CENTER DEPTH	NIGHTCLUB, CONCERT HALL, CHURCH, CATHEDRAL
CENTER MIX	5.1 2-CHANNEL, DTS(-ES) 2-CHAN
CNTR DLY SAMPLES	5.1 2-CHANNEL, DTS(-ES) 2-CHAN
COMPRESSION	All Dolby Digital modes
CTR WIDTH	Dolby PLII MUSIC and Dolby PLIIx MUSIC
CUSTOM	All modes
CUSTOM VS PRESET	All modes
DIMENSION	Dolby DPLII MUSIC and Dolby PLIIx MUSIC
EARLY RFLX LVL	All LIVE! modes
EFFECT LVL	NIGHTCLUB, CONCERT HALL, CHURCH, CATHEDRAL, PANORAMA, MONO LOGIC and 5.1 MONO LOGIC
ES DECODING	All DTS modes

MODE-PARAMETER RELATIONSHIPS (continued)

The parameter...	Is used in these modes
EX DECODING	5.1 PLIIx MOV, 5.1 PLIIx MUS, DOLBY DIGITAL EX and DOLBY DIGITAL
FRONT STEERING	L7 TV, L7 MUSIC, L7 MUSIC SURR, all 5.1 L7 modes and all DTS L7 modes
INPUT BALANCE	PANORAMA
LFE MIX	All Dolby Digital modes except MONO modes (5.1 MONO LOGIC, 5.1 MONO SURR, 5.1 MONO), all DTS modes and 5.1a BYPASS
LISTENER POS	PANORAMA CALIBRATION
LIVENESS	NIGHTCLUB, CONCERT HALL
LOW FREQ WIDTH	PANORAMA
MASTER LEVEL	5.1 2-CHANNEL, DTS(-ES) 2-CHAN
MID RT	CHURCH, CATHEDRAL and all LIVE! modes
OUTPUT LEVELS	All except 2-CHANNEL, MONO, 5.1 2-CHANNEL, 5.1 MONO, DTS(-ES) 2-CHAN, 2CH BYPASS and LIVE! modes
PANORAMA	Dolby PLII MUSIC and Dolby PLIIx MUSIC
PRE-DELAY	NIGHTCLUB, CONCERT HALL, CHURCH, CATHEDRAL and all LIVE! modes
RE-EQUALIZER	L7 FILM, L7 TV, Dolby PLII + THX, Dolby PLIIx + THX, 5.1 L7 FILM, 5.1 L7 TV, THX ULTRA2, THX SurEX, THX, DTS (-ES) L7 FILM, DTS (-ES) THX ULTRA2 and DTS (-ES) THX
REAR DLY OFFSET	All L7 modes and PANORAMA
REAR L/R	All except 2-CHANNEL, MONO, 5.1 2-CHANNEL, 5.1 MONO, DTS(-ES) 2-CHAN, 2CH BYPASS and LIVE! modes
RESET MODE	All modes
REVERB LVL	All LIVE! modes
ROLLOFF	NIGHTCLUB, CONCERT HALL, CHURCH, CATHEDRAL and all LIVE! modes
SHAPE	All LIVE! modes
SIDE L/R	All except 2-CHANNEL, MONO, 5.1 2-CHANNEL, 5.1 MONO, DTS(-ES) 2-CHAN, 2CH BYPASS and LIVE! modes

The parameter...	Is used in these modes
SIZE	NIGHTCLUB, CONCERT HALL, CHURCH, CATHEDRAL and all LIVE! modes
SOUND STAGE	All L7 modes
SOURCE	PANORAMA CALIBRATION
SPEAKER ANGLE	PANORAMA CALIBRATION
SPEECH DETECT	NIGHTCLUB, CONCERT HALL, CHURCH and CATHEDRAL
SPREAD	All LIVE! modes
SUB & SUB LVL	All except LIVE! modes
SURR ROLLOFF	All L7 modes
SURROUND DLY	Dolby PLII MUSIC and Dolby PLIIx MUSIC
SURROUND EX	THX ULTRA2, THX SurEX, THX
SURROUND MIX	5.1 2-CHANNEL and DTS(-ES) 2-CHAN
TREB CUT RT	All LIVE! modes
VOCAL ENHANCE	All L7 modes

7

Troubleshooting and Maintenance

Troubleshooting.....	7-2
Routine Maintenance	7-4
Restoring Factory-Default Settings.....	7-4

TROUBLESHOOTING

The RV-8 does not power on.

1. Make sure the rear-panel power switch is set to the | (“on”) position.
2. Attempt to power on the RV-8 with the front-panel Standby button and remote control On button.
3. Examine the power cord to ensure a good connection between the rear-panel AC input connector and the wall outlet.
4. Check the electrical circuit and breaker.

The remote control does not work.

1. Eliminate obstructions between the remote control and the front-panel IR receiver. When the RV-8 is not using the rear-panel IR IN connector, the remote control must be in line of sight with the front-panel IR receiver for proper operation. The remote control might also become unreliable if strong sunlight or fluorescent light is shining on the IR receiver.
2. Make sure the remote control batteries are correctly inserted with the proper polarity (page 1-6).
3. Replace the remote control batteries. When the batteries are low on power, the remote control enters a low-voltage condition that prevents it from operating the RV-8.

The RV-8 is powered on, but there is no audio.

1. Make sure volume level is audible. Volume level can be increased with the front-panel volume knob or the remote control VOL ▲ and ▼ buttons.
2. Make sure audio has not been muted. The message “MUTE ON” or “FULL MUTE ON” will appear in the on-screen and

front-panel displays when audio has been muted. To deactivate mute, press the Mute button or adjust the volume level.

3. Check the INPUT SETUP menu DIGITAL IN and ANALOG IN parameters to ensure the appropriate audio connector is assigned to the selected input.
4. Make sure the RV-8 is receiving an audio signal. To do this, follow the instructions that begin on page 2-29 to open the STATUS menu for the current input source.

Dialogue sounds muffled.

If the speaker setup does not include a center speaker, make sure a custom – as opposed to a THX – speaker setup is selected. Then, make sure the CUSTOM SETUP menu CENTER parameter is set to NONE (page 3-31).

A humming sound is present in the audio.

1. If a cable TV connection is present, disconnect the cable from the wall outlet. If this eliminates the humming sound, a ground loop isolation device is required. Contact your dealer or the cable provider for assistance.
2. Disconnect components one at a time to isolate the problem. Once the problem is identified, make sure the associated component is properly grounded and connected to the same electrical circuit as the RV-8.

The RV-8 is powered on, but there is no video.

1. Examine the video cables – particularly the S-Video cables – to ensure a good connection to the associated component.

2. Check the INPUT SETUP menu VIDEO IN and COMPONENT IN (page 3-11) parameters to ensure the appropriate video connector is assigned to the selected input.

RF interference is present in the audio or video.

1. Make sure the RV-8 is not positioned near unshielded TV or FM antennas, cable TV decoders and other RF-emitting devices.
2. Replace unshielded cables with shielded cables wherever possible.

The RV-8 is exhibiting erratic behavior.

1. Set the rear-panel power switch to the ○ ("off") position. Wait 10 seconds. Then set the rear-panel power switch to the | ("on") position.
2. Use the RV-8 configuration tool to download the current RV-8 configuration to a personal computer (PC) or document all user-defined settings on the Installation Worksheet that begins on page D-2. Then, follow the instructions on the next page to restore factory-default settings.

If all else fails...

1. Document all user-defined settings on the Installation Worksheet that begins on page D-2. Then, follow the instructions on page 7-4 to restore factory-default settings.

2. Contact an authorized Lexicon dealer.
3. Contact Lexicon customer service at 781-280-0300 or www.lexicon.com.

Note:

Visit the knowledgebase at <http://www.lexicon.com/kbase> for answers to frequently asked questions and additional troubleshooting information.

The tuner volume suddenly went mute, then after a minute it resumed. This seems to happen occasionally.

Under the TUNER SETUP menu, is the AUTO FREQUENCY option active? You may be experiencing broadcast station dropouts. When the broadcast signal drops out, the volume is muted and AUTO FREQUENCY activates, scanning for alternate broadcast frequencies and then verifying that the station ID is an exact match. If the station ID matches and the alternate frequency is a stronger signal, then the tuner switches to the alternate frequency and turns off the volume mute. Otherwise, auto frequency scans for another alternate frequency and repeats the procedure. If there are a lot of alternate broadcast frequencies, this process can take a noticeable amount of time. To stop this behavior, simply turn off the Auto frequency option.

ROUTINE MAINTENANCE

The bulleted items below describe routine maintenance that should be performed on a periodic basis.

- Clean the RV-8 exterior surface with a soft, lint-free cloth. Do not use alcohol, benzene, acetone-based cleaners or strong commercial cleaners. Do not use a cloth made with steel wool or metal polish. If the RV-8 is exposed to a dusty environment, a low-pressure blower can be used to remove dust from its exterior surface.
- Replace the remote control batteries as needed. The remote control requires four AAA batteries. When these batteries are low on power, the remote control enters a low-voltage condition that prevents it from operating the RV-8. Normal operation will resume when new batteries are installed.

RESTORING FACTORY-DEFAULT SETTINGS

When factory-default settings are restored, all parameters and user-defined values are restored to their factory-default settings. Before restoring factory-default settings, record all user-defined settings in the Installation Worksheet in the Appendix on page D-2.



To restore factory-default settings:

1. Record all user-defined settings on the Installation Worksheet that begins on page D-2. When factory-default settings are restored, all parameters and user-defined values are restored to their factory-default settings.
2. If the RV-8 is powered on, press the front-panel standby button or the remote control Off button to activate standby mode and deactivate the RV-8. If the RV-8 is in standby mode, proceed to step 3.
3. Press the front-panel standby button or the remote control On button to deactivate standby mode and activate the RV-8.
4. Quickly press and hold the front-panel or remote control Mute button until the FACTORY SETTINGS menu opens in the on-screen and front-panel displays.
5. Press the remote control ▲ and ▼ arrow buttons to highlight the desired option. Highlight the RESTORE DEFAULTS option to restore factory-default settings. Highlight the EXIT option to close the FACTORY SETTINGS menu without restoring factory-default settings.
6. When the desired option is highlighted, press the remote control ► arrow button to select this option.
 - If the RESTORE DEFAULTS option was selected, the FACTORY SETTINGS message shown in the previous page will appear in the on-screen and front-panel displays. When this message appears, press a front-panel or remote control button to restart the RV-8.
 - If the EXIT option is selected, the FACTORY SETTINGS menu will close and the two-line status will open in the on-screen and front-panel displays.

A

Appendix

Specifications A-2

Declaration of Conformity A-4

SPECIFICATIONS

Audio Input & Output Connectors	
Analog Audio Inputs	Eight stereo (RCA) or five stereo and one 5.1-channel or 2 stereo and two 5.1-channel connectors
Digital Audio Inputs	<ul style="list-style-type: none"> Four S/PDIF coaxial (RCA) and four S/PDIF optical connectors Coaxial and optical input connectors conform to IEC-958, S/PDIF standards Accepts 44.1, 48, 88.2 and 96kHz sample rates Accepts 16-24-bit PCM audio, Dolby Digital, DTS, DTS-ES discrete and DTS-96K data formats
Main Zone Audio Outputs	Eight unbalanced (RCA) connectors for Front L/R, Center, Sub, Side L/R and Rear L/R
Zone 2 Audio Outputs	<ul style="list-style-type: none"> One unbalanced (RCA, variable output level) stereo connector One unbalanced (RCA, fixed output level) stereo connector One S/PDIF coaxial (RCA) connector and one optical connector
Zone 3 Audio Outputs	One stereo (RCA, variable output level) connector
Headphone	One stereo (1/4-inch phone) connector
Amplifier	Seven channels, two channels can be assigned to Zone 2 or Zone 3

Main Zone Audio Performance	
A/D Conversion	24-Bit, 96kHz, dual-bit $\Delta\Sigma$ architecture
D/A Conversion	24-Bit, 44.1 to 192kHz, multibit $\Delta\Sigma$ architecture
*Frequency Response	20Hz to 20kHz, +0.1dB/-0.1dB, -0.25dB at 40kHz, -0.5dB at 40kHz, reference 1kHz
*THD + Noise	Below 0.02%, 20Hz to 20kHz, 140W Rms all channels driven
*Dynamic Range	<ul style="list-style-type: none"> 105dB minimum, 22kHz bandwidth, "A" weighted 102dB minimum, 22kHz bandwidth, unweighted
*Signal-to-Noise Ratio	<ul style="list-style-type: none"> 105dB minimum, 22kHz bandwidth, "A" weighted 102dB minimum, 22kHz bandwidth, unweighted

Main Zone Audio Performance	
Input Sensitivity	200mV Rms (2V Rms for maximum output level) at 0dB input gain
Input Impedance	100k Ω in parallel with 150pF
Preamp Output Level	<ul style="list-style-type: none"> 150mV Rms typical, 6V Rms maximum (RCA connectors) Maximum value with full-scale input signal and volume at +12dB
Preamp Output Impedance	500 Ω in parallel with 150pF (RCA connectors)

Zone 2 and Zone 3 Audio Performance	
A/D Conversion	24-Bit, 44.1 to 96kHz, multibit $\Delta\Sigma$ architecture (Zone 2 only)
D/A Conversion	24-Bit, 44.1 to 192kHz, multibit $\Delta\Sigma$ architecture
Frequency Response	10Hz to 20kHz, +0.1dB/-0.25dB, -0.75dB at 40kHz, reference 1kHz
THD + Noise	Below 0.005% at 1kHz, (1V Rms output level)
Dynamic Range	101dB minimum, 22kHz bandwidth
Signal-to-Noise Ratio	101dB minimum, 22kHz bandwidth
Input Sensitivity	200mV Rms (4V Rms for maximum output level)
Input Impedance	100k Ω in parallel with 150pF
Preamp Output Level	<ul style="list-style-type: none"> 200mV Rms typical, 4V Rms maximum Maximum value with full-scale input signal and volume at 0dB
Preamp Output Impedance	300 Ω in parallel with 150pF

Video Input & Output Connectors	
Video Inputs	Five composite (RCA), five S-Video and three component video (RCA)
Video Outputs	Two composite (RCA, one monitor and one Zone 2), two S-Video (one monitor and one Zone 2) and one component (RCA)

Composite & S-Video Performance	
Compatibility	NTSC, PAL and SECAM
Switching	Active
Output Level	1.0V peak-to-peak
Impedance	75Ω
Input Return Loss	>40dB
Differential Gain	<0.5%
Differential Phase	<0.5°
Bandwidth	>25MHz
K Factor	<0.3%
Gain	±0.15dB
Signal-to-Noise Ratio	>65dB
Frequency Response	10Hz to 10MHz + 0.1/-0.3dB

Component Video Performance	
Compatibility	3-Channel (Y, Pr, Pb), format-independent
Switching	Passive
Impedance	75Ω
Insertion Loss	<3dB
Bandwidth	>150MHz
Video Converter	NTSC, PAL, SECAM, to Y/Pb/Pr

Microphone Input Connectors	
Inputs	Two microphone jacks
Input Sensitivity	10mV Rms (400mV maximum input level)
Input Impedance	20kΩ (accepts balanced or unbalanced input signals)

FM Tuner Performance	
Tuning Range	64MHz to 108MHz
Usable Sensitivity	<4uV, 1.6mV typical

FM Tuner Performance	
Selectivity	>87dBmV, 93dBmV typical
Frequency Response	50Hz to 16kHz, +0.1dB/-1.0dB
THD + Noise	<0.4% at 1 kHz (stereo)
Signal-to-Noise Ratio	50dB minimum at 60dBmV
Image Rejection	>50dB, >60dB typical
AM Suppression	>45dB, >55dB typical

AM Tuner Performance	
Tuning Range	520 to 1720kHz
Usable Sensitivity	<8uV, 4uV typical
THD + Noise	< 0.56%, 0.20% typical (1kHz, 60dBmV, 30% mod)
Wideband AGC	>80dBmV

Phono Performance (MM)	
Frequency Response	50Hz to 20kHz, +0.5dB/-0.5dB, rumble filter -4dB at 10Hz
THD + Noise	< 0.20%, 20Hz to 10kHz, 4.7mV input
Signal-to-Noise Ratio	72dB minimum

Compatible Amplifier Connectors	
Banana Plugs	Standard 0.75 inch plugs
Spade Connectors	Size 10-12 gauge
Bare Wire	Up to 10 gauge bare wire

Other	
Trigger Outputs	One power on/off and one programmable connector on detachable screw terminals (+12 VDC, 0.5 amps each)
RS-232 Serial Input/Output	Two 9-pin D-sub connectors

Other	
Power Requirements	120-230 VAC, 50-60Hz, 60W (universal line input), detachable power cord
RV-8 Dimensions & Weight	<ul style="list-style-type: none"> • Height (with feet): 7.76 inches (197.1mm) • Width: 17.3 inches (440mm) • Depth: 21.2 inches (538.48mm) • Weight: 65 lb. (29.48kg)
Rack-Mounting	<ul style="list-style-type: none"> • Optional brackets are available for installation in a standard 19" equipment rack (two rack units required)
Environment	<ul style="list-style-type: none"> • Operating temperature: 0° to 35°C (32° to 95°F) • Storage temperature: -30° to 75°C (-22° to 167°F) • Relative humidity: 95% maximum without condensation
Remote Control	<ul style="list-style-type: none"> • Handheld, backlit infrared remote control unit, preprogrammed and learning • Requires four AAA batteries (alkaline batteries recommended)

Specifications are subject to change without notice.

DECLARATION OF CONFORMITY

Application of Council Directive(s):
89/336/EEC and 93/68/EEC

Standard(s) to Which Conformity is Declared:

EN 55013:2001
EN 55020:2002

EN 61000-3-2-2000
EN 61000-3-3:1995+A1:2001

EN 61000-3-11:2000
EN 60065:1998

Manufacturer: Harman Specialty Group
3 Oak Park
Bedford, MA 01730-1413 USA

The equipment identified here conforms to the Directive(s) and Standard(s) specified above.

Type of Equipment: Digital Controller

Model: Lexicon RV-8

Date: August 2005

Harman Specialty Group
Vice President of Engineering
3 Oak Park
Bedford, MA 01730-1413 USA
Tel: 781-280-0300
Fax: 781-280-0490

B

Appendix

Menu Tree	B-2
-----------------	-----

MENU TREE

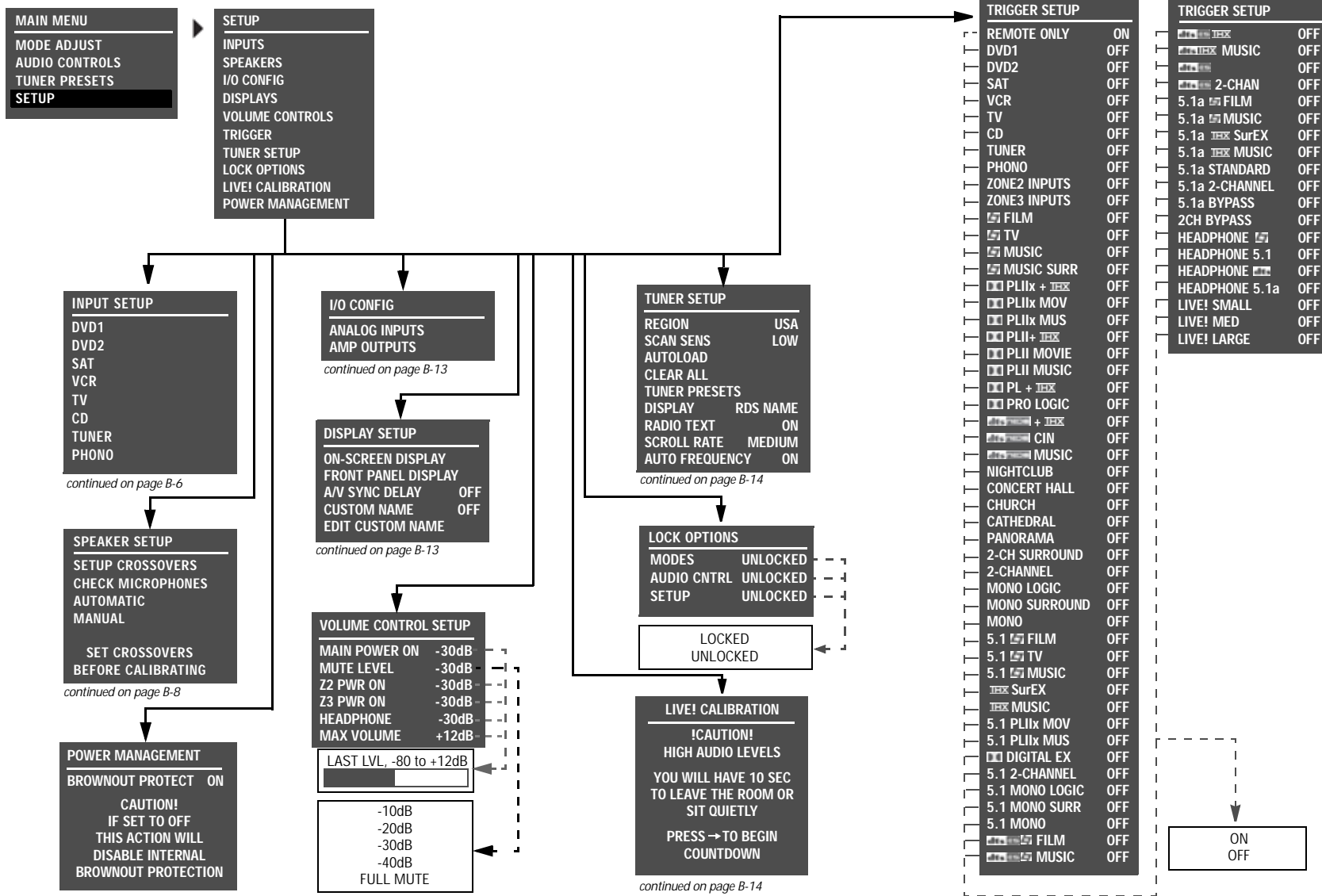

SETUP MENU: INPUTS

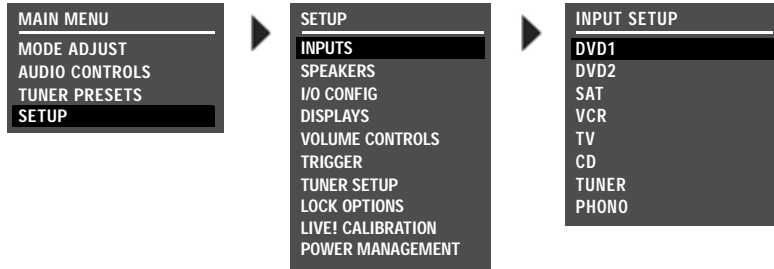

Selecting SETUP ► INPUTS prompts the selection of the desired input (for example, DVD1). Selecting an input opens the corresponding INPUT SETUP menu shown below. The parameters on the left side of the INPUT SETUP menus are identical regardless of which input is selected. The parameter settings on the right side are adjustable. Default parameter settings differ from input to input. The INPUT SETUP menus shown below indicate default parameter settings for each input.

DVD1 INPUT SETUP	
NAME	DVD1
DIGITAL IN	COAX-1
ANALOG IN	NONE
ANLG IN LVL	AUTO
VIDEO IN	S-VIDEO-1
COMPONENT IN	1
2-CH	FILM
D	5.1 FILM
	FILM
5.1a	5.1a FILM
MIC	LIVE! MED
MAIN ADVANCED	
ZONE2 IN	DIGITAL
ZONE2 ADVANCED	

SAT INPUT SETUP	
NAME	SAT
DIGITAL IN	OPTICAL-1
ANALOG IN	ANALOG-1
ANLG IN LVL	AUTO
VIDEO IN	S-VIDEO-3
COMPONENT IN	3
2-CH	TV
D	5.1 TV
	FILM
5.1a	5.1a FILM
MIC	LIVE! MED
MAIN ADVANCED	
ZONE2 IN	ANLG
ZONE2 ADVANCED	

TV INPUT SETUP	
NAME	TV
DIGITAL IN	OPTICAL-2
ANALOG IN	ANALOG-3
ANLG IN LVL	AUTO
VIDEO IN	S-VIDEO-5
COMPONENT IN	3
2-CH	TV
D	5.1 TV
	FILM
5.1a	5.1a FILM
MIC	LIVE! MED
MAIN ADVANCED	
ZONE2 IN	ANLG
ZONE2 ADVANCED	

TUNER INPUT SETUP	
NAME	TUNER
DIGITAL IN	NONE
ANALOG IN	TUNER
ANLG IN LVL	AUTO
VIDEO IN	NONE
COMPONENT IN	NONE
2-CH	MUSIC
D	5.1 MUSIC
	MUSIC
5.1a	5.1a MUSIC
MIC	LIVE! MED
MAIN ADVANCED	
ZONE2 IN	ANLG
ZONE2 ADVANCED	

DVD2 INPUT SETUP	
NAME	DVD2
DIGITAL IN	COAX-2
ANALOG IN	NONE
ANLG IN LVL	AUTO
VIDEO IN	S-VIDEO-2
COMPONENT IN	2
2-CH	FILM
D	5.1 FILM
	FILM
5.1a	5.1a FILM
MIC	LIVE! MED
MAIN ADVANCED	
ZONE2 IN	DIGITAL
ZONE2 ADVANCED	

VCR INPUT SETUP	
NAME	VCR
DIGITAL IN	NONE
ANALOG IN	ANALOG-2
ANLG IN LVL	AUTO
VIDEO IN	S-VIDEO-4
COMPONENT IN	3
2-CH	FILM
D	5.1 FILM
	FILM
5.1a	5.1a FILM
MIC	LIVE! MED
MAIN ADVANCED	
ZONE2 IN	ANLG
ZONE2 ADVANCED	

CD INPUT SETUP	
NAME	CD
DIGITAL IN	COAX-3
ANALOG IN	NONE
ANLG IN LVL	AUTO
VIDEO IN	NON
COMPONENT IN	NONE
2-CH	MUSIC
D	5.1 MUSIC
	MUSIC
5.1a	5.1a MUSIC
MIC	LIVE! MED
MAIN ADVANCED	
ZONE2 IN	DIGITAL
ZONE2 ADVANCED	

PHONO INPUT SETUP	
NAME	PHONO
DIGITAL IN	NONE
ANALOG IN	PHONO
ANLG IN LVL	AUTO
VIDEO IN	NONE
COMPONENT IN	NONE
2-CH	MUSIC
D	5.1 MUSIC
	MUSIC
5.1a	5.1a MUSIC
MIC	LIVE! MED
MAIN ADVANCED	
ZONE2 IN	ANLG
ZONE2 ADVANCED	

SETUP MENU: INPUTS (continued)

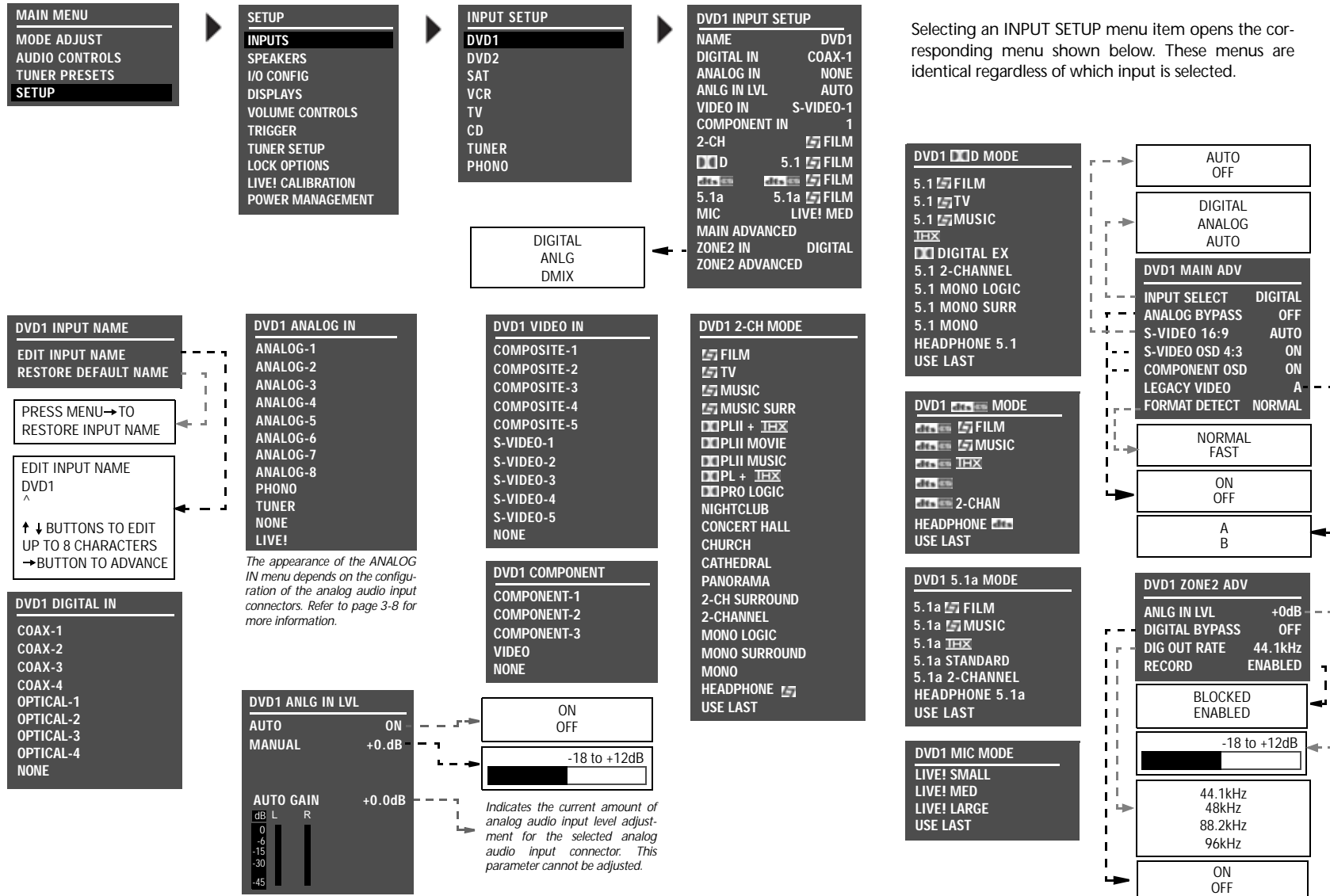

Selecting an INPUT SETUP menu item opens the corresponding menu shown below. These menus are identical regardless of which input is selected.

SETUP MENU: SPEAKERS

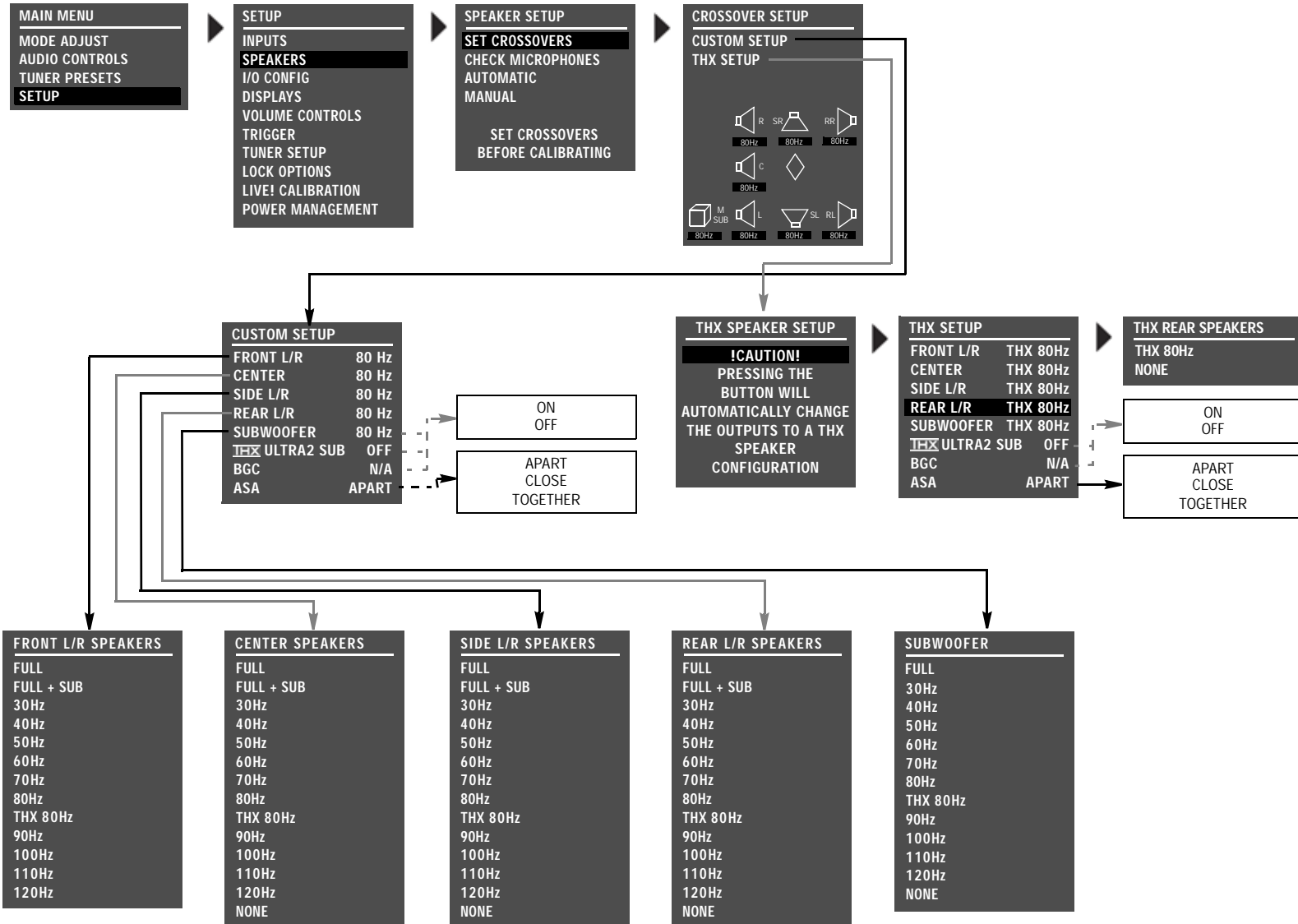

SETUP MENU: SPEAKERS (continued)

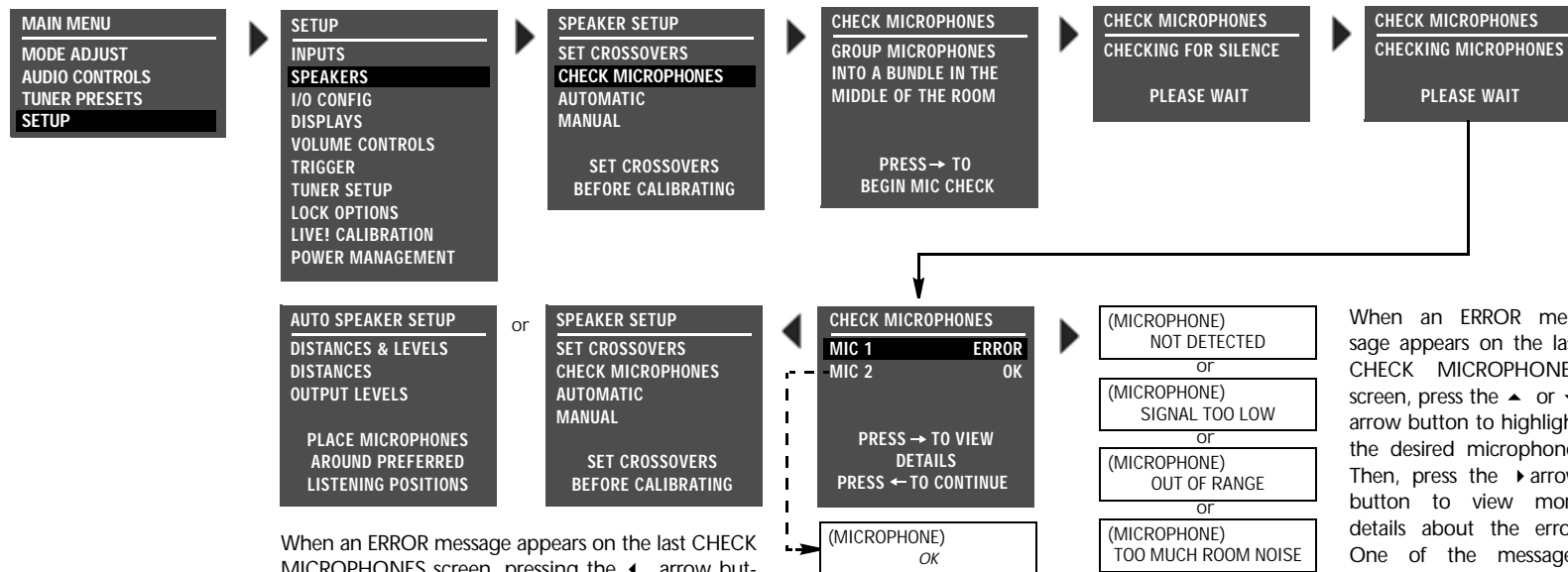

When an ERROR message appears on the last CHECK MICROPHONES screen, pressing the ◀ arrow button opens the SPEAKER SETUP menu. When no ERROR message appears on the last CHECK MICROPHONES screen, pressing the ◀ arrow button opens the AUTO SPEAKER SETUP menu.

When an ERROR message appears on the last CHECK MICROPHONES screen, press the ▲ or ▼ arrow button to highlight the desired microphone. Then, press the ▶ arrow button to view more details about the error. One of the messages shown to the left will appear in the on-screen display.

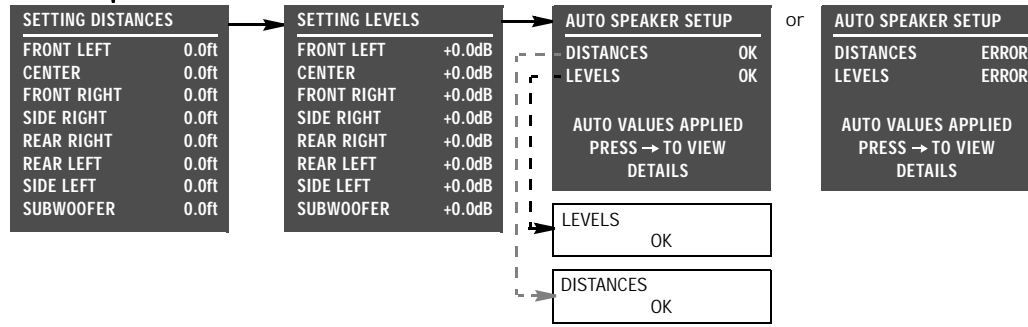
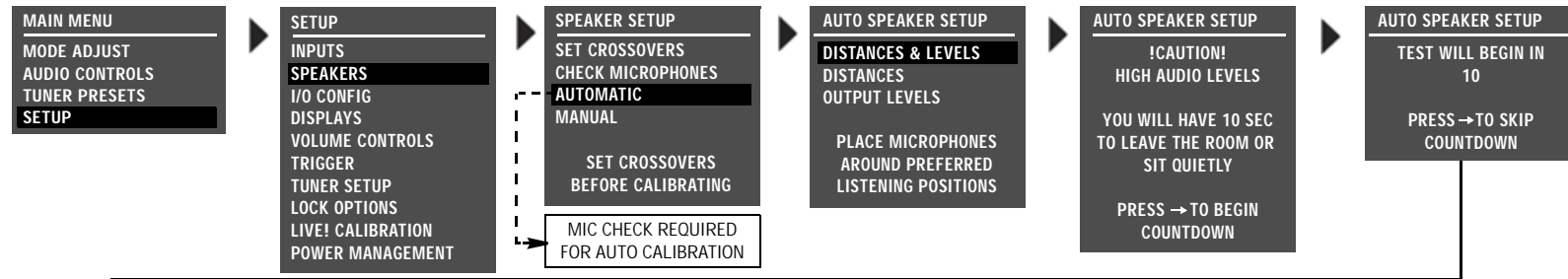

When the RV-8 is finished calibrating speaker distances and output levels, the AUTO SPEAKER SETUP results screen shown at the left will open in the on-screen display, indicating the results for each calibration procedure. If there is an error, press the ▲ or ▼ arrow button to highlight the desired calibration procedure. Then, press the ► arrow button to select this procedure. Selecting DISTANCES opens the AUTO DISTANCES screen shown below. Selecting the LEVELS option opens the AUTO LEVELS screen shown below.

The AUTO DISTANCES and AUTO LEVELS screens shown on the right indicate the individual calibration results for each speaker. Press the ▲ and ▼ arrow buttons to highlight the desired speaker calibration parameter. Then, press the ► arrow button to view more detailed results for the selected speaker.

Press the ◀ arrow button to return to the AUTO SPEAKER SETUP results screen shown above (right). Then, press the ► arrow button to select the other calibration procedure or press the ◀ arrow button to return to the SPEAKER SETUP menu.

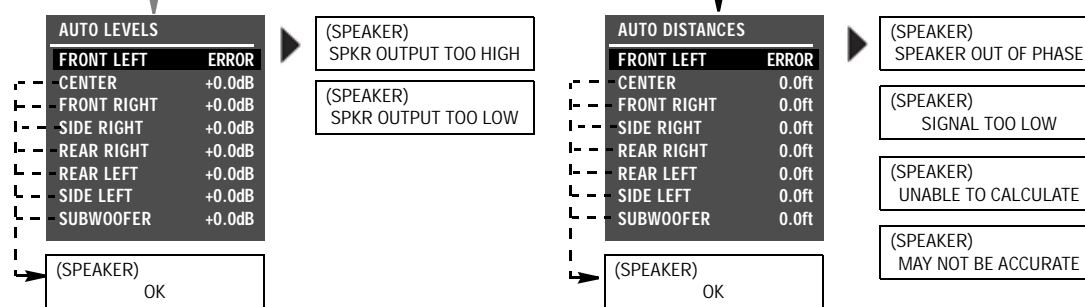

SETUP MENU: SPEAKERS (continued)

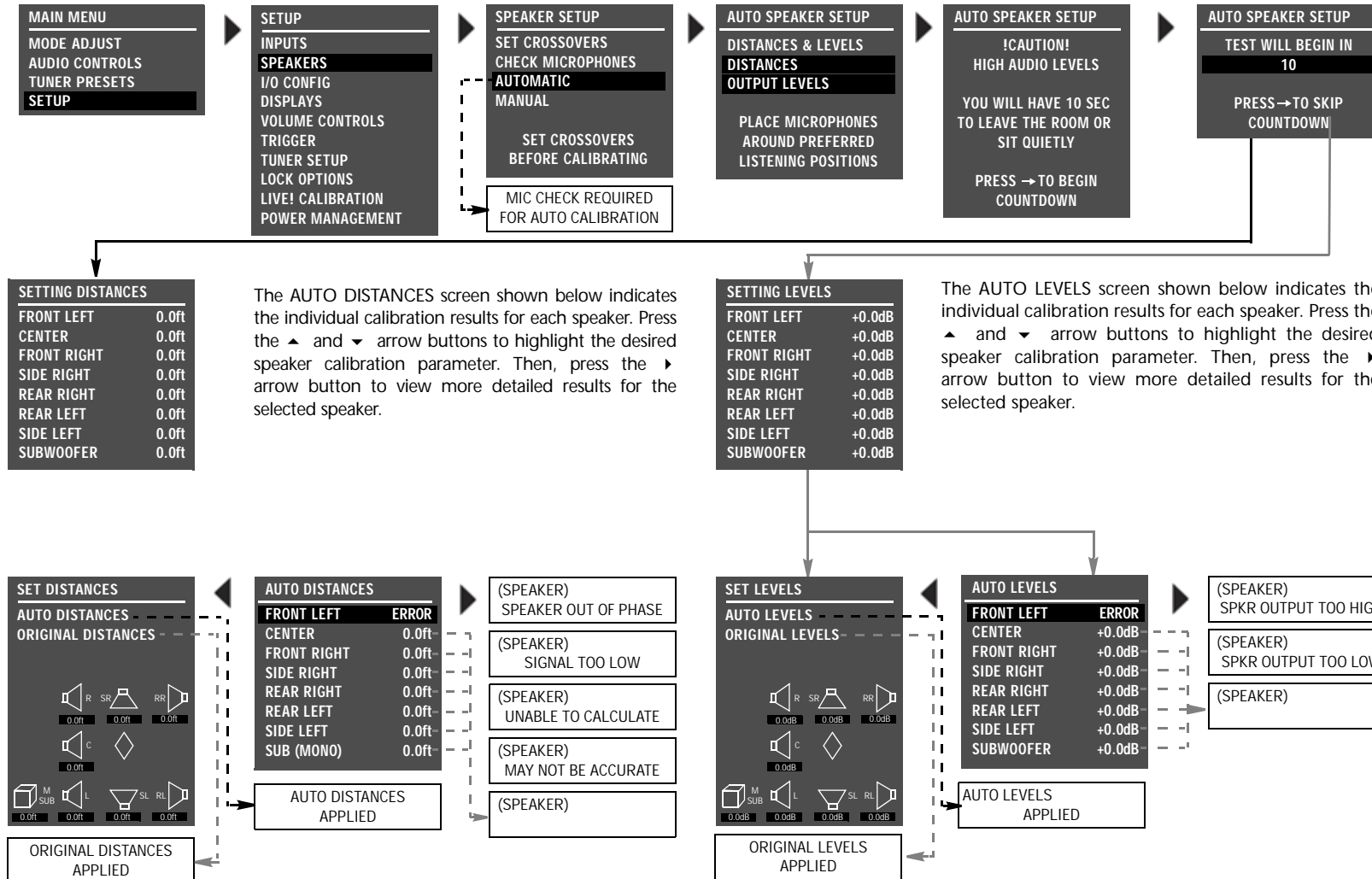

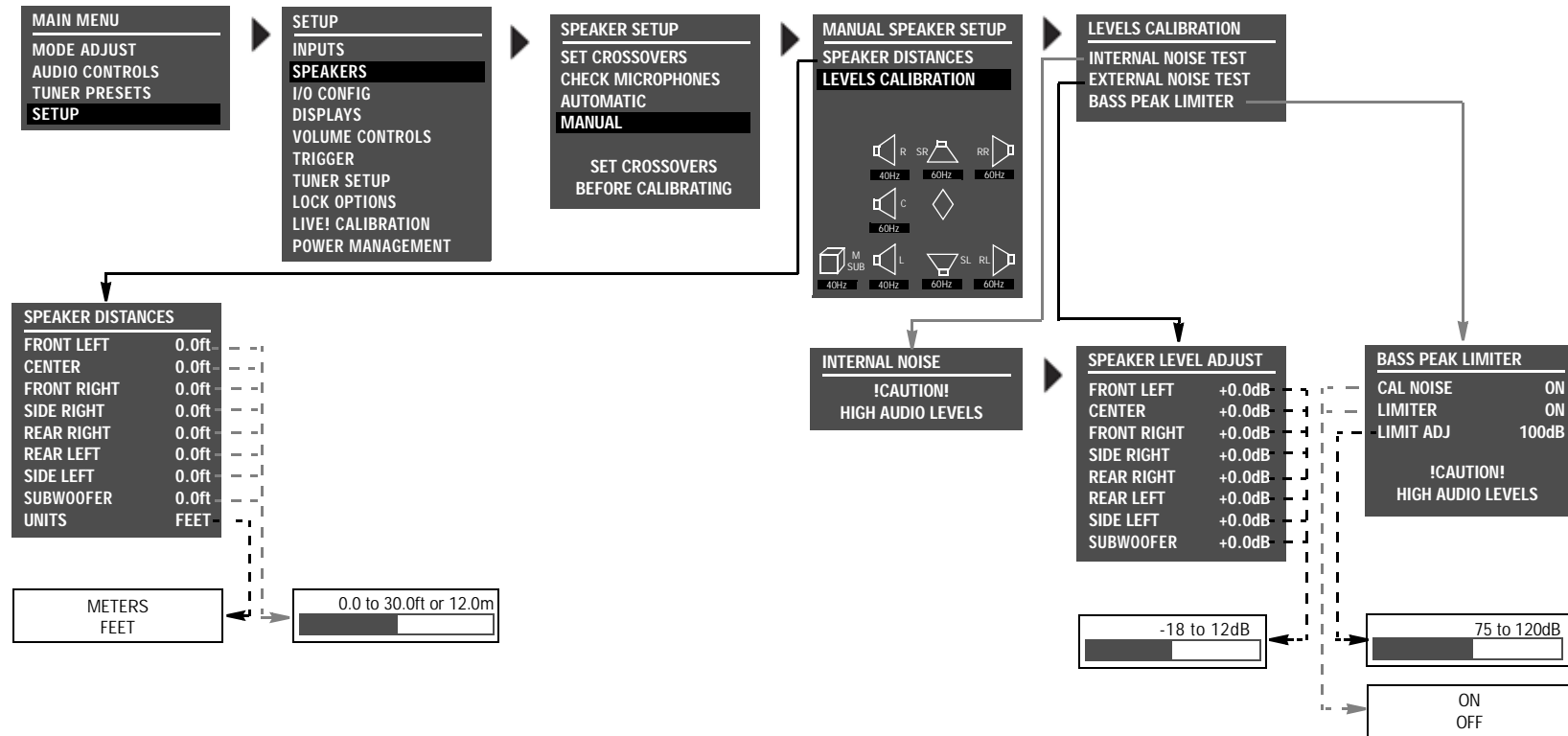

SETUP MENU: I/O CONFIG

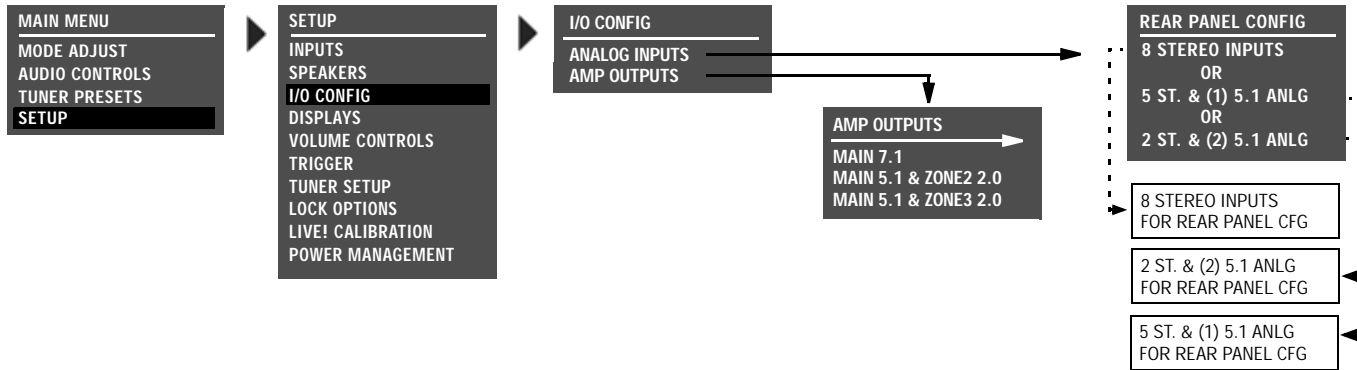

SETUP MENU: DISPLAYS

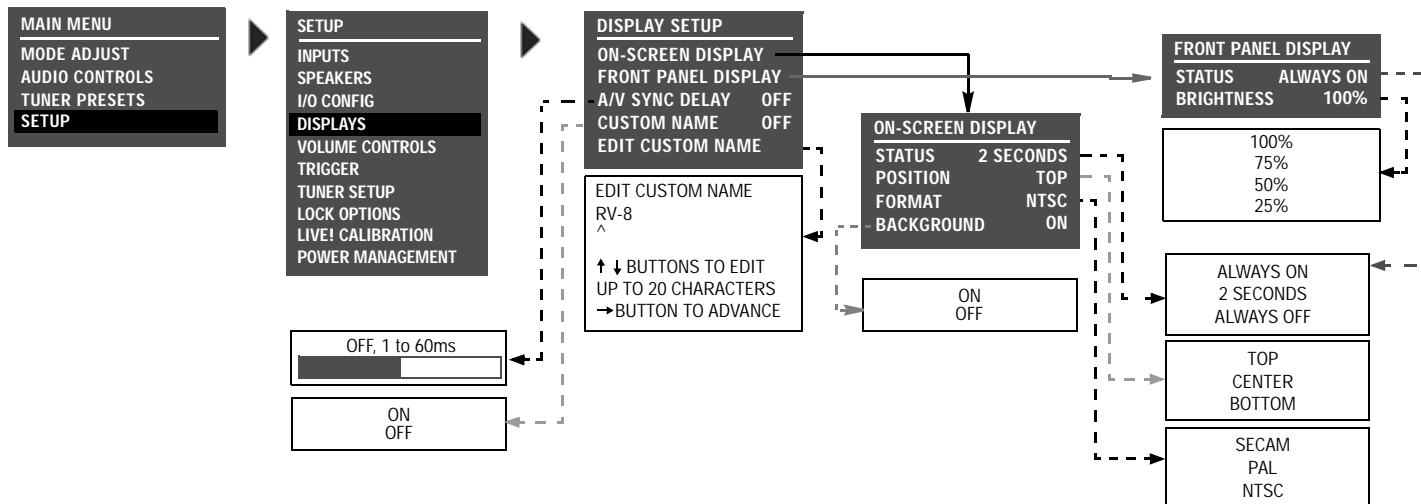

SETUP MENU: TUNER SETUP

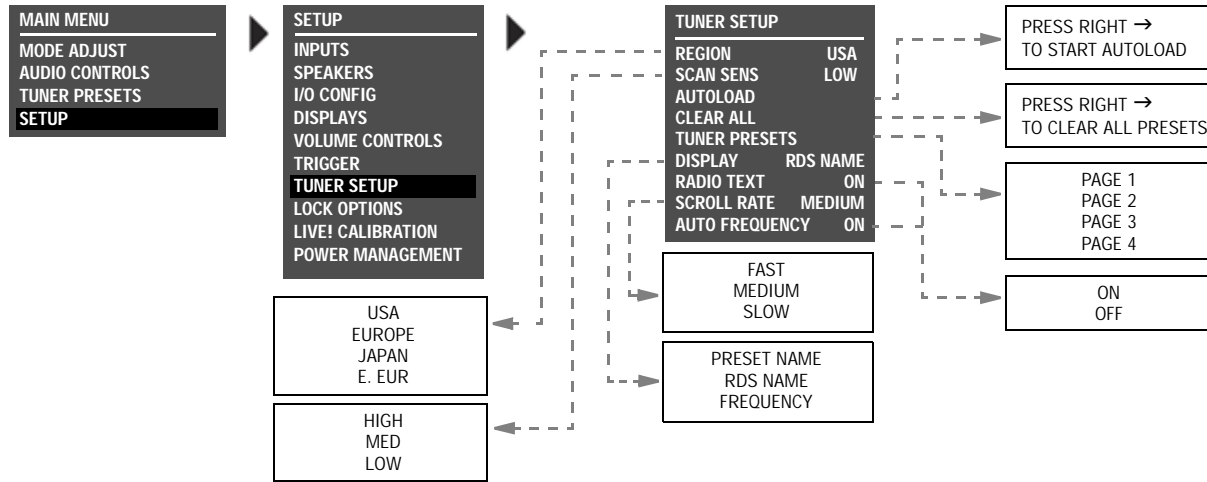

SETUP MENU: LIVE! CALIBRATION

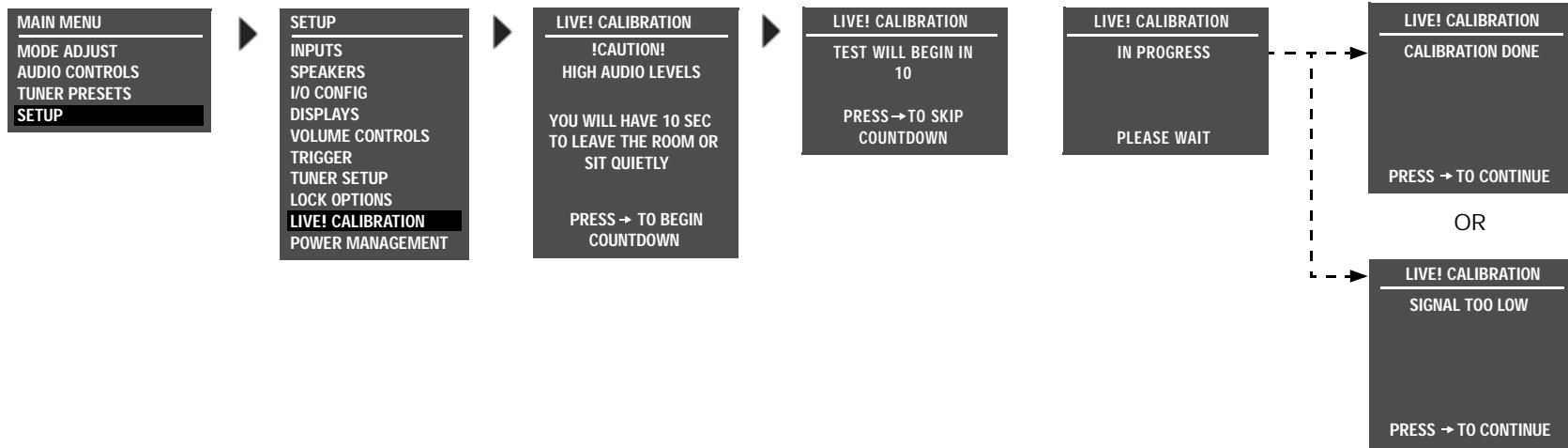

MAIN MENU: TUNER PRESETS

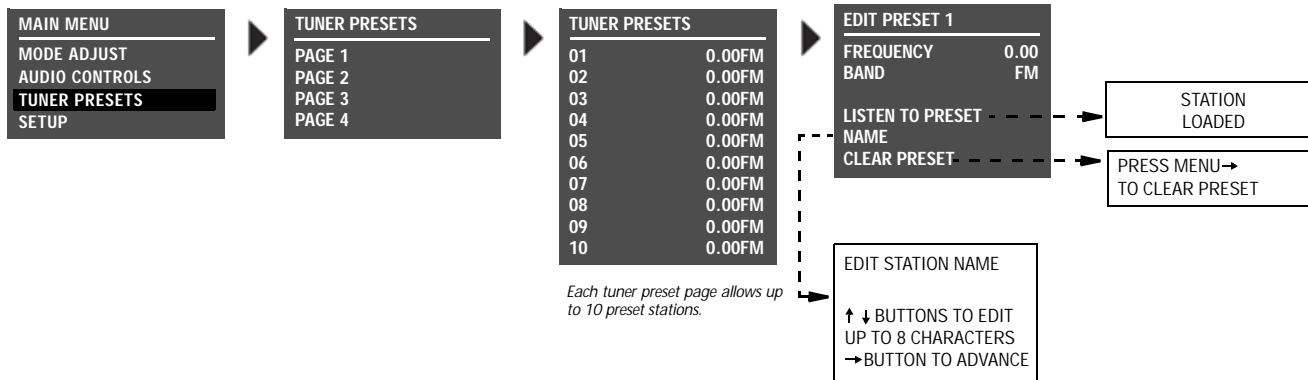

MAIN MENU: AUDIO CONTROLS

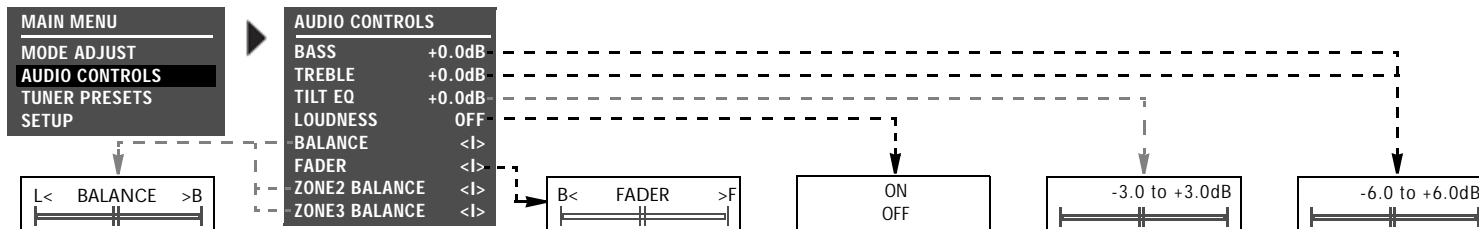

MAIN MENU: MODE ADJUST

MAIN MENU
MODE ADJUST
 AUDIO CONTROLS
 TUNER PRESETS
 SETUP

- MODE ADJUST
- FILM OFF
- TV OFF
- MUSIC OFF
- MUSIC SURR OFF
- PLIix + **TEX** * OFF
- PLIix MOV* OFF
- PLIix MUS* OFF
- PLIi+ **TEX** OFF
- PLII MOVIE OFF
- PLII MUSIC OFF
- PL + **TEX** OFF
- PRO LOGIC OFF
- TEX** + **TEX** OFF
- CIN OFF
- MUSIC OFF
- NIGHTCLUB OFF
- CONCERT HHALL OFF
- CHURCH OFF
- CATHEDRAL OFF
- PANORAMA OFF
- 2-CH SURROUND OFF
- 2-CHANNEL OFF
- MONO LOGIC OFF
- MONO SURROUND OFF
- MONO OFF
- 5.1 **TEX** FILM OFF
- 5.1 **TEX** TV OFF
- 5.1 **TEX** MUSIC OFF
- TEX** * OFF
- TEX** MUSIC OFF
- 5.1 PLIix MOV* OFF
- 5.1 PLIix MUS* OFF
- DIGITAL EX* OFF
- 5.1 2-CHANNEL OFF
- 5.1 MONO LOGIC OFF
- 5.1 MONO SURR OFF
- 5.1 MONO OFF
- TEX** **TEX** FILM* OFF
- TEX** **TEX** MUSIC* OFF
- TEX** * OFF
- TEX** **TEX** MUSIC* OFF
- TEX** * OFF
- TEX** 2-CHAN* OFF
- 5.1a **TEX** FILM OFF
- 5.1a **TEX** MUSIC OFF
- 5.1a **TEX** * OFF
- 5.1a **TEX** MUSIC OFF
- 5.1a STANDARD OFF
- 5.1a 2-CHANNEL OFF

* These listening mode names differ depending on the current input source, speaker setup and parameter settings. Refer to the Listening Mode Descriptions for more information.

MODE ADJUST

- 5.1a BYPASS OFF
- 2CH BYPASS OFF
- HEADPHONE **TEX** OFF
- HEADPHONE 5.1 OFF
- HEADPHONE **TEX** OFF
- HEADPHONE 5.1a OFF
- LIVE! SMALL OFF
- LIVE! MED OFF
- LIVE! LARGE OFF

FILM

- AUTO AZIMUTH ON
- VOCAL ENHANCE +0.0dB
- RE-EQUALIZER ON
- SOUND STAGE REAR
- 5 SPKR ENHANCE ON
- BASS ENHANCE OFF
- SURR ROLLOFF 7.0kHz
- REAR DLY OFFSET 15ms
- OUTPUT LEVELS CUSTOM

TV

- AUTO AZIMUTH ON
- VOCAL ENHANCE +0.0dB
- FRONT STEERING FILM
- RE-EQUALIZER OFF
- SOUND STAGE REAR
- 5 SPKR ENHANCE ON
- BASS ENHANCE OFF
- SURR ROLLOFF 7.0kHz
- REAR DLY OFFSET 15ms
- OUTPUT LEVELS CUSTOM

MUSIC

- VOCAL ENHANCE +0.0dB
- FRONT STEERING MUSIC
- SOUND STAGE NEUTRAL
- 5 SPKR ENHANCE ON
- BASS ENHANCE OFF
- SURR ROLLOFF 7.0kHz
- REAR DLY OFFSET 15ms
- OUTPUT LEVELS CUSTOM

MUSIC SURR

- VOCAL ENHANCE +0.0dB
- FRONT STEERING MSURR
- SOUND STAGE NEUTRAL
- 5 SPKR ENHANCE ON
- BASS ENHANCE OFF
- SURR ROLLOFF 7.0kHz
- REAR DLY OFFSET 15ms
- OUTPUT LEVELS CUSTOM

PLIix + **TEX**

- RE-EQUALIZER ON
- OUTPUT LEVELS CUSTOM

PLIix MOV

- OUTPUT LEVELS CUSTOM

PLIix MUS

- PANORAMA OFF
- CTR WIDTH 3
- DIMENSION NEUTRAL
- SURROUND DLY 10ms
- OUTPUT LEVELS CUSTOM

PLIi + **TEX**

- RE-EQUALIZER ON
- OUTPUT LEVELS CUSTOM

PLII MOVIE

- OUTPUT LEVELS CUSTOM

PLII MUSIC

- PANORAMA OFF
- CTR WIDTH 3
- DIMENSION NEUTRAL
- SURROUND DLY 10ms
- OUTPUT LEVELS CUSTOM

PL + **TEX**

- RE-EQUALIZER ON
- OUTPUT LEVELS CUSTOM

PRO LOGIC

- OUTPUT LEVELS CUSTOM

TEX + **TEX**

- RE-EQUALIZER ON
- OUTPUT LEVELS CUSTOM

CIN

- OUTPUT LEVELS CUSTOM

MUSIC

- OUTPUT LEVELS CUSTOM

NIGHTCLUB

- CENTER DEPTH 11
- SPEECH DETECT ON
- SIZE 5m
- LIVENESS 196ms
- PRE-DELAY 5ms
- ROLLOFF 9.0kHz
- EFFECT LVL +3dB
- OUTPUT LEVELS CUSTOM

CONCERT HALL

- CENTER DEPTH 12
- SPEECH DETECT ON
- SIZE 20m
- LIVENESS 1.72ms
- PRE-DELAY OFF
- ROLLOFF 2.4kHz
- EFFECT LVL -2dB
- OUTPUT LEVELS CUSTOM

CHURCH

- CENTER DEPTH 5
- SPEECH DETECT ON
- SIZE 20m
- MID RT 1.56s
- BASS RT 1.87s
- PRE-DELAY 24ms
- ROLLOFF 2.4kHz
- EFFECT LVL -3dB
- OUTPUT LEVELS CUSTOM

CATHEDRAL

- CENTER DEPTH 12
- SPEECH DETECT ON
- SIZE 30m
- MID RT 3.72s
- BASS RT 4.47s
- PRE-DELAY 23ms
- ROLLOFF 3.1kHz
- EFFECT LVL -8dB
- OUTPUT LEVELS CUSTOM

PANORAMA

- EFFECT LVL +4dB
- BASS CONTENT STEREO
- LOW FREQ WIDTH +0
- SURR ROLLOFF 3.1kHz
- REAR DLY OFFSET 15ms
- INPUT BALANCE <I>
- CALIBRATION
- OUTPUT LEVELS CUSTOM

2-CH SURROUND

- OUTPUT LEVELS CUSTOM

2-CHANNEL

- SUB LEVEL +0dB
- CUSTOM

MONO LOGIC

- EFFECT LVL -9dB
- ACADMY FILTER ON
- SURR ROLLOFF 3.1kHz
- OUTPUT LEVELS CUSTOM

MONO SURROUND

- OUTPUT LEVELS CUSTOM

MONO

- SUB LVL +0dB
- CUSTOM

ON
OFF

MAIN MENU: MODE ADJUST (continued)

5.1 FILM

VOCAL ENHANCE	+0.0dB
RE-EQUALIZER	ON
SOUND STAGE	REAR
5 SPKR ENHANCE	ON
BASS ENHANCE	OFF
SURR ROLLOFF	7.0kHz
REAR DLY OFFSET	15ms
COMPRESSION	OFF
LFE MIX	+0.0dB
OUTPUT LEVELS	CUSTOM

5.1 TV

VOCAL ENHANCE	+0.0dB
FRONT STEERING	FILM
RE-EQUALIZER	OFF
SOUND STAGE	REAR
5 SPKR ENHANCE	ON
BASS ENHANCE	OFF
SURR ROLLOFF	7.0kHz
REAR DLY OFFSET	15ms
COMPRESSION	OFF
LFE MIX	+0.0dB
OUTPUT LEVELS	CUSTOM

5.1 MUSIC

VOCAL ENHANCE	+0.0dB
FRONT STEERING	MUSIC
RE-EQUALIZER	OFF
SOUND STAGE	NEUTRAL
5 SPKR ENHANCE	ON
BASS ENHANCE	OFF
SURR ROLLOFF	7.0kHz
REAR DLY OFFSET	15ms
COMPRESSION	OFF
LFE MIX	+0.0dB
OUTPUT LEVELS	CUSTOM

THX

RE-EQUALIZER	ON
SURROUND EX	AUTO
COMPRESSION	OFF
LFE MIX	+0.0dB
OUTPUT LEVELS	CUSTOM

THX MUSIC

COMPRESSION	OFF
LFE MIX	+0.0dB
OUTPUT LEVELS	CUSTOM

5.1 PLIIx MOV

EX DECODING	AUTO
COMPRESSION	OFF
LFE MIX	+0.0dB
OUTPUT LEVELS	CUSTOM

5.1 PLIIx MUS

EX DECODING	AUTO
COMPRESSION	OFF
LFE MIX	+0.0dB
OUTPUT LEVELS	CUSTOM

DIGITAL EX

EX DECODING	AUTO
COMPRESSION	OFF
LFE MIX	+0.0dB
OUTPUT LEVELS	CUSTOM

5.1 2-CHANNEL

CENTER MIX	+0dB
SURROUND MIX	+0dB
CNTR DLY SAMPLES	+0
MASTER LEVEL	+0dB
COMPRESSION	OFF
LFE MIX	+0.0dB
SUB LEVEL	+0dB
CUSTOM	

5.1 MONO LOGIC

EFFECT LVL	-9dB
ACADEMY F1LTER	+0N
SURR ROLLOFF	3.1kHz
OUTPUT LEVELS	CUSTOM

5.1 MONO SURR

OUTPUT LEVELS	CUSTOM
---------------	--------

5.1 MONO

SUB LEVEL	+0dB
CUSTOM	

FILM

VOCAL ENHANCE	+0.0dB
RE-EQUALIZER	ON
SOUND STAGE	REAR
5 SPKR ENHANCE	ON
BASS ENHANCE	OFF
SURR ROLLOFF	7.0kHz
REAR DLY OFFSET	15ms
LFE MIX	+0.0dB
DECODING	AUTO
OUTPUT LEVELS	CUSTOM

MUSIC

VOCAL ENHANCE	+0.0dB
FRONT STEERING	MUSIC
RE-EQUALIZER	OFF
SOUND STAGE	NEUTRAL
5 SPKR ENHANCE	ON
BASS ENHANCE	OFF
SURR ROLLOFF	7.0kHz
REAR DLY OFFSET	15ms
LFE MIX	+0.0dB
DECODING	AUTO
OUTPUT LEVELS	CUSTOM

THX

RE-EQUALIZER	ON
LFE MIX	+0.0dB
DECODING	AUTO
OUTPUT LEVELS	CUSTOM

THX MUSIC

LFE MIX	+0.0dB
OUTPUT LEVELS	CUSTOM

THX

LFE MIX	+0.0dB
DECODING	AUTO
OUTPUT LEVELS	CUSTOM

2-CHAN

CENTER MIX	+0dB
SURROUND MIX	+0dB
CNTR DLY SAMPLES	+0
MASTER LEVEL	+0dB
LFE MIX	+0.0dB
DECODING	AUTO
SUB L/R LVL	+0dB
CUSTOM	

5.1a FILM

VOCAL ENHANCE	+0.0dB
RE-EQUALIZER	ON
SOUND STAGE	REAR
5 SPKR ENHANCE	ON
BASS ENHANCE	OFF
SURR ROLLOFF	7.0kHz
REAR DLY OFFSET	15ms
LFE MIX	+0.0dB
OUTPUT LEVELS	CUSTOM

5.1a MUSIC

VOCAL ENHANCE	+0.0dB
FRONT STEERING	MUSIC
RE-EQUALIZER	OFF
SOUND STAGE	NEUTRAL
5 SPKR ENHANCE	ON
BASS ENHANCE	OFF
SURR ROLLOFF	7.0kHz
REAR DLY OFFSET	15ms
LFE MIX	+0.0dB
OUTPUT LEVELS	CUSTOM

5.1a THX

RE-EQUALIZER	ON
SURROUND EX	OFF
LFE MIX	+0.0dB
OUTPUT LEVELS	CUSTOM

5.1a THX MUSIC

LFE MIX	+0.0dB
OUTPUT LEVELS	CUSTOM

5.1a STANDARD

OUTPUT LEVELS	CUSTOM
---------------	--------

5.1a 2-CHANNEL

CENTER MIX	+0dB
SURROUND MIX	+0dB
CNTR DLY SAMPLES	+0
MASTER LEVEL	+0dB
LFE MIX	+0.0dB
SUB LEVEL	+0dB
CUSTOM	

5.1a BYPASS

OUTPUT LEVELS	CUSTOM
---------------	--------

2CH BYPASS

NO PARAMETERS	
---------------	--

HEADPHONES

NO PARAMETERS	
---------------	--

HEADPHONES 5.1

NO PARAMETERS	
---------------	--

HEADPHONES

NO PARAMETERS	
---------------	--

HEADPHONES 5.1a

NO PARAMETERS	
---------------	--

LIVE! SMALL

MID RT	597ms
BASS RT	597ms
ROLLOFF	3.1kHz
TREB CUT RT	3.1kHz
PRE DELAY	10ms
ADVANCED	CUSTOM

LIVE! SMALL ADVANCED

REVERB LVL	+0dB
EARLY RFLX LVL	-13dB
BASS XOVER	156Hz
SHAPE	0
SPREAD	0%
SIZE	19m

LIVE! MED

MID RT	1.84s
BASS RT	2.76s
ROLLOFF	2.4kHz
TREB CUT RT	3.1kHz
PRE DELAY	18ms
ADVANCED	CUSTOM

LIVE! MED ADVANCED

REVERB LVL	-4dB
EARLY RFLX LVL	-14dB
BASS XOVER	156Hz
SHAPE	2
SPREAD	25%
SIZE	30m

LIVE! LARGE

MID RT	4.71s
BASS RT	4.71s
ROLLOFF	3.1kHz
TREB CUT RT	2.4kHz
PRE DELAY	20ms
ADVANCED	CUSTOM

LIVE! LARGE ADVANCED

REVERB LVL	-6dB
EARLY RFLX LVL	-17dB
BASS XOVER	156Hz
SHAPE	2
SPREAD	28%
SIZE	38m

Selecting the listening mode menu CALIBRATION, OUTPUT LEVELS or CUSTOM option opens the corresponding menu path shown below. The CALIBRATION option is available for the PANORAMA listening mode. The OUTPUT LEVELS and CUSTOM options are available for most listening modes. These menus are identical regardless of which listening mode is selected. Listening mode menu parameter drop-down menus are shown below and on the next page.

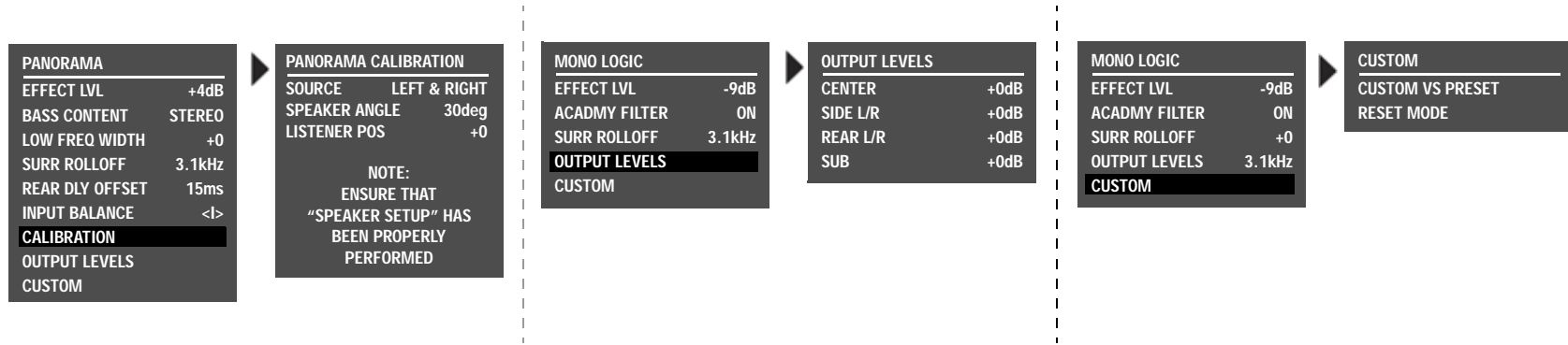

Selecting a listening mode menu parameter opens the corresponding parameter drop-down menu shown below and on the next page. These drop-down menus are identical regardless of which listening mode is selected. However, certain parameter ranges differ from listening mode to listening mode.

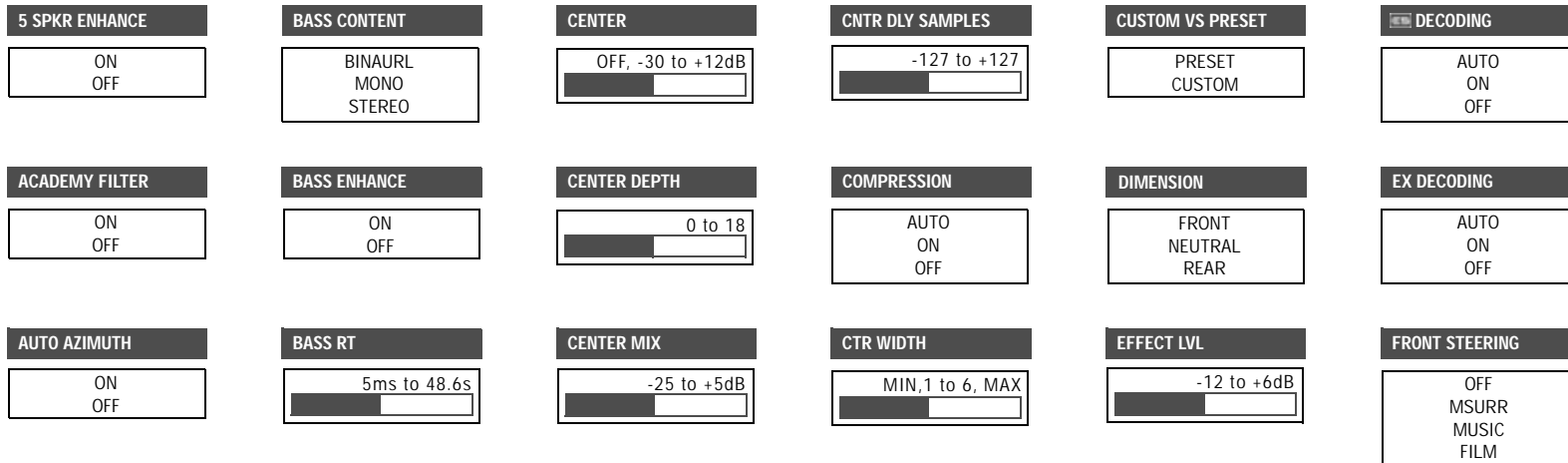

MAIN MENU: MODE ADJUST (continued)

INPUT BALANCE

L< <|> >R

MASTER LEVEL

-5 to +5dB

REAR DLY OFFSET

OFF, 1 to 30ms

SIZE

4 to 20 or 30ms

SPEECH DETECT

ON
OFF

SURROUND DLY

0 to 15ms

LFE MIX

-20.0 or -10.0 to +0.0dB

MID RT

24ms to 48.6s

REAR L/R

OFF, -30 to 12dB

SOUND STAGE

FRONT
NEUTRAL
REAR

SUB LEVEL

OFF, -30 to 12dB

SURROUND EX

AUTO
ON
OFF

CENTER MIX

-127 +0 +127

PANORAMA

ON
OFF

RESET MODE

PRESS RIGHT →
TO RESTORE MODE

SOURCE

RIGHT
LEFT & RIGHT
LEFT

SUB L/R LVL

OFF, -30 to 12dB

SURROUND MIX

+5 to +5dB

LIVENESS

30ms to 20.2s

PRE-DELAY

10 to 100ms

ROLLOFF

500Hz to 20.0kHz, OFF

SPEAKER ANGLE

10 to 90deg

SURR ROLLOFF

500Hz to 20.0kHz, OFF

VOCAL ENHANCE

+6.0dB
+3.0dB
+0.0dB

LOW FREQ WIDTH

-25 to +25

RE-EQUALIZER

ON
OFF

SIDE L/R

OFF, -30 to 12dB

MAIN MENU: RESTORE DEFAULTS



Refer to the Restoring Factory-Default Settings section that begins on page 7-4 for more information.

STATUS MENUS

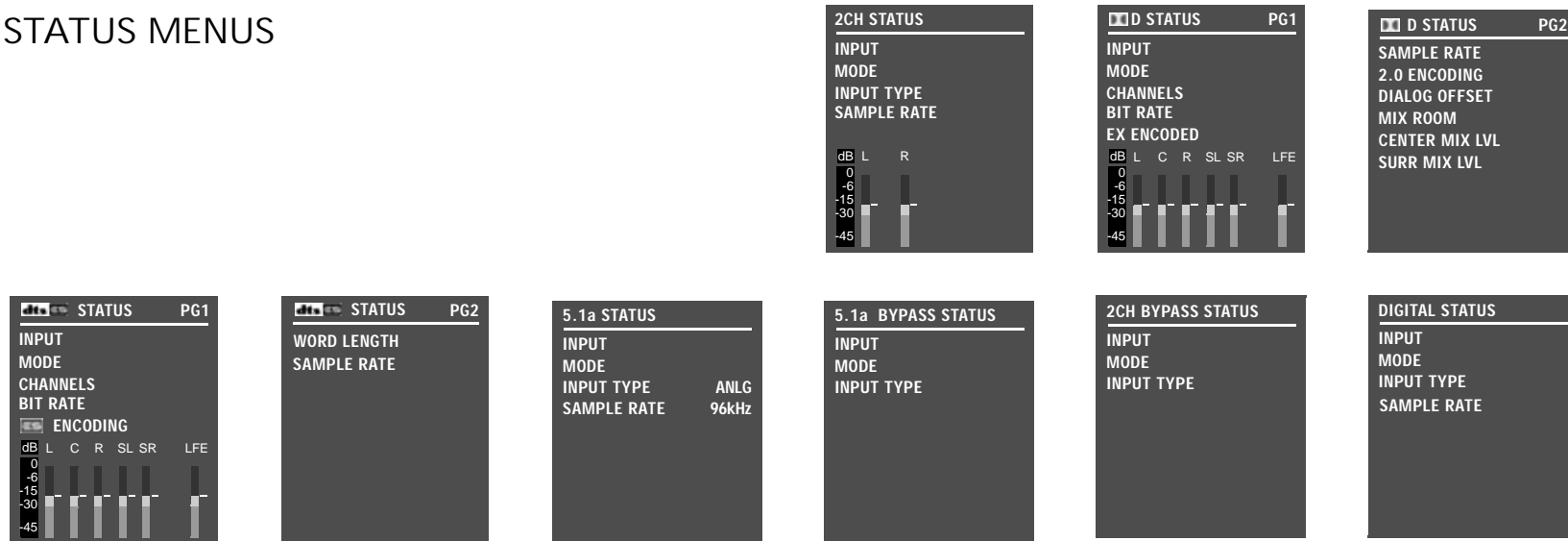

Refer to the Status Menus section that begins on page 2-29 for more information.

C

Appendix

Remote Control Programming	C-2
Three-Digit Preprogrammed Codes	C-18

REMOTE CONTROL PROGRAMMING

The RV-8 remote control has been designed to provide a new standard in remote control technology offering a very powerful and flexible preprogrammed and learning product.

The RV-8 remote control can operate up to 10 home entertainment and home automation components by using the preprogrammed code library in the remote control, by teaching up to 530 commands into the RV-8 remote from your original remote controls, or a combination of both. The RV-8 remote has many additional operating features to add convenience and enjoyment to the operation of any home entertainment system. You can create your own button labels on the LCD screen; program 50 favorite channel buttons; operate the volume, channel and transport buttons from one device when you are in another device; and perform multiple tasks with the press of a single button.

The RV-8 remote control features extensive preprogrammed IR codes for practically all major audio and video equipment. It can set up and operate various components by simply entering a threedigit code number assigned to the brand of component. The code numbers for the various brands of components are listed beginning on page C-18. Refer to the programming instructions on page C-5 for additional information.

DEVICE ACTIVATION

In addition to controlling the RV-8, the remote is designed to operate up to seven components including Satellite Boxes, TV, DVD (LD), VCR, CD and Phono. Remote control buttons perform different commands depending on whether the Main Zone, Zone 2, Zone 3 or another device is activated.

However, each of the device buttons and corresponding functions can be changed to meet individual requirements.

The Phono function could be used to operate lighting controls; the second DVD (DVD2) could be changed to operate a second TV, etc. Each device button on the main screen contains two subpages of commands and the name of any LCD button can be changed, using up to five alphabet characters, numbers and symbols to customize the unit to fit your audio/video devices. Refer to "Edit Text on Function/Device Buttons" on page 13 for more information.

MACRO OPERATIONS

A "macro" is a series of commands that can be sent out with the push of a single button. Any function available on an original remote control or in the preprogrammed database can be added to a macro to completely automate what would normally be done by pushing buttons one at a time. A macro can be configured to power on a TV or projector, RV-8, and RT-10 Disc Player, change to the appropriate inputs and outputs, dim lights and start a movie. It can be as simple or as comprehensive as desired. There are two types of buttons that can be used for macro operations: M1, M2, M3; POWER and SYSTEM OFF Buttons, as well as the programmable device buttons.

The M1, M2 and M3 are called "system-wide" buttons because they send out the same signal no matter what device is currently controlled. The POWER and SYSTEM OFF buttons can be made "system-wide" if they are programmed with macros.

Note:

Programming the POWER or SYSTEM OFF buttons with a macro overrides the preprogrammed or learned code on the button.

See page C-10 for further information. Each of these five buttons is designed to be able to send out a series of up to 20 commands that are programmed into the buttons. One common use is to turn on and turn off all A/V components with one button press. Device buttons can be programmed with any macro sequence desired.

The remote has 10 device buttons which can send out a series of up to 20 programmed commands when pressed for more than one second. These buttons are commonly used in sending audio input codes when you press the button to go to a device. The audio receiver would make an automatic input switch according to the device button pressed. However, these buttons can be programmed with any desired macro.

Up to 50 favorite channel buttons can be programmed into the RV-8 remote. Each of these buttons can send out up to 10 commands. Refer to "Programming Favorite Channels" on page 9 for more information.

Note:

The last Device selected will remain active when on the HOME page and will be shown at the bottom of the LCD screen. For example, if you are using "TV" and then return to the HOME page, the hard buttons remain in TV mode. The LCD buttons only change when another device is selected.

The remote can be set up to operate audio component volume control buttons (UP, DOWN and MUTE) while all the other buttons control other equipment. The remote can also be set up to operate channel control and transport functions (PLAY, STOP, REWIND, FAST FORWARD, SKIP-, SKIP+, PAUSE and RECORD buttons) from VCR, DVD, LD, CD or any other mode while all other buttons in the remote control are controlling other components. See page C-12 for more information.

REMOTE PROGRAMMING OVERVIEW

The first task is to get all original remote controls together. You may have one or more components that do not have original remote controls. These can still be controlled by the RV-8. The preprogrammed method must be used for those devices. For the rest, you can program the RV-8 to make it compatible with all components by following the preprogrammed method instructions, by using the original remote controls to teach the RV-8, or through both methods. Next, it is recommended that you decide whether a "device-based," or an "activity-based" configuration is desired.

A "device-based" configuration centers on each device with its two LCD pages controlling one component. All of the functions that the original remote control has programmed in it would be put onto one device. The RV-8 remote comes with the labels and preprogrammed codes in a "device-based" setup.

When a preprogrammed code is chosen for a component from the Three-Digit Preprogrammed Codes tables which start on page C-18, that code will be applied to one device only.

An "activity-based" configuration centers on what you are doing at the time. If you are watching a DVD on your TV, and are using the RV-8 to control the sound, you may want to start by setting up the DVD device using the preprogrammed method described in the next column, and then add functions from the other devices you will be using while watching your DVD video to the DVD device.

For example, while playing a DVD, to adjust the volume of the RV-8, use the "Punch Through" method described on page C-12 to put the RV-8's volume control into the DVD device. To adjust other functions of

the RV-8 while staying in the DVD device, use the learning method described on page C-7 to add those functions to the DVD device, such as surround sound controls, the receiver's

DVD input code, the TV's power code, etc. In that instance, everything that is needed for watching a DVD on your TV without having to switch back and forth from device to device is available.

All programming is done by first entering the SETUP mode in the remote control. Press both the HOME and ENT (enter) buttons, simultaneously for three seconds to access the SETUP mode shown below. "SETUP" will be displayed at the top of the LCD screen. Specific programming instructions begin on the next page.

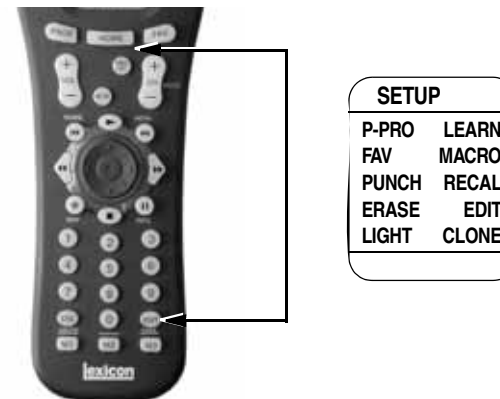

USING PREPROGRAMMED CODES

To program the remote to make it compatible with other components:

1. Manually power on the device to be operated.
2. Go to the SETUP mode by pressing both the HOME and ENT buttons simultaneously for three seconds until SETUP appears at the top of the LCD screen.
3. Press the P-PRO button next to the LCD screen.
4. The remote will be flashing "SELECT BUTTON" at the bottom of the LCD screen. Press the button for the device you wish to program. For example, to program a TV, press the TV button.
5. The remote will be flashing "FROM TABLE" at the bottom of the LCD screen. Select the device from which to access the code table.



Note:

When using the Preprogramming method, always use the appropriate button as shown in the column when asked "FROM TABLE." The labels of the buttons may have been changed, but the codes are in the positions as shown to the left. For example, the AUDIO Code table will always be the top left button. The CD Code table will always be the fourth button down on the right side of the LCD screen, etc.

Use DVD2, not DVD1, to access the DVD code library. DVD1 has been preprogrammed to control the Lexicon RT-10 Disc Player.

6. The remote will be flashing "ENTER NUMBER." Refer to the tables starting on page C-18 and find the manufacturer/brand of your device. (If programming the remote for the TV device, find the TV's device code table, and so on.)
7. Point the remote control toward the device and enter the first three-digit code number selected for your device. There is no way of knowing which code is the one that will have the functions that more closely match your device than the others, so it is wise to try them all. See step 9 on the next page. (Enter the code number within 20 seconds of beginning the programming; otherwise the remote will revert to the SETUP menu, and then after a period of time, it will go back to the MAIN device page.) If there is more than one code number assigned to your brand, try one code number at a time until the right code number is found (the number that turns off the device). If the device turns off when the three-digit code is entered, make note of the code. It will have at least some of the functions in it that are needed to control the device.
8. Confirm that it is the right code by pressing the Power button. The device should turn on. After it is confirmed that the right code is entered, save the code by pressing the SAVE button on the LCD.
9. At this point try ALL of the buttons on the remote, and see which ones work with the device. The majority of the buttons should

work with the device. Make note of the code if it seems to be the right one, and try the next one. You are trying to find the one that has the most functions to operate your equipment. If there are any functions missing, you will learn them from your original remote in the "Using Learning Method" section on page C-7.

10. Continue to program other components by repeating from Step 1 above.
11. Press EXIT at any time to stop the procedure.
12. When you are finished programming the remote, exit from the preprogramming mode by pressing the HOME button and then exit from the SETUP mode by pressing the HOME button once again.

Note:

A programmed code for each device can be changed at any time by using the preprogrammed method which starts on the previous page. A new code will override an old code. For example, this would be done if a TV is replaced with a new TV. The code table for Laserdisc is stored under DVD2. The code table for cable box is stored under Zone 2. The code table for cassette player is stored under Zone 3.

AUTO SCAN WITH THREE-DIGIT NUMBER

You can also program the remote control by sending out a series of Power Off commands for different brands stored in the library by using the following steps. This is similar to the first method, except it is easier to move through all of the device codes for your device and make note of each one that turns your device OFF.

To program the remote to make it compatible with other components:

1. Manually turn on the device you plan to operate.
2. Go to the SETUP mode by pressing both the HOME and ENT buttons simultaneously for three seconds.
3. Press the P-PRO button next to the LCD screen.
4. The remote will be flashing "SELECT BUTTON." Press the device you wish to program. (For example, to program TV, press the TV button.)
5. The remote will be flashing "FROM TABLE." Select the device from which the scanned code will be selected. (Important: If you have already relabeled your device keys, the LCD screen will not look like the illustration on page C-5. Select the appropriate LCD button for the "FROM TABLE" using the labels as shown in the illustration on page C-4. For example, if you have relabeled PHONO as LIGHTS, you would still push the bottom right button to access the AUX Code Table.)
6. Point the remote control toward the component and press either the UP or DOWN button on the LCD. (It will send out a series of Power Off codes when the button is kept pressed and the code numbers that are being sent are shown on the LCD.) If the right code number is sent, the component will turn off right after the code number is transmitted.
7. Release the UP or DOWN button as soon as the device is turned off. If you passed the one that turned off the device, manually turn the device back on, and reverse your UP or DOWN one press at a time, until the unit turns off. There is no way of knowing which

code is the one that will have the functions that more closely match the device than the others, so it is advised to try them all. See Step 9 below. (Press the UP or DOWN button within 20 seconds of beginning programming; otherwise the remote will revert to the SETUP menu, and then after a period of time, it will go back to the MAIN device page.) If there is more than one code number assigned to your brand, try one code number at a time until the correct code number is found (the number that turns off the device). If the device turns off when you enter the three-digit code, make note of the code. It will have at least some of the functions in it that are needed to control the device.

8. Confirm that it is the right code by pressing the Power button. After ensuring that the right code is entered, save the code by pressing the SAVE button on the LCD.
9. Confirm that the right code number that matches the component was entered by pressing other functional buttons. If any of the buttons do not operate as they should, repeat from step 1.
10. Continue to program other components by repeating from step 1 (previous page).
11. Press EXIT at any time if you do not wish to proceed.
12. Exit from Preprogrammed mode by pressing the HOME button and then exit from the SETUP mode by pressing the HOME button once again.

USING LEARNING METHOD

The RV-8 remote can be programmed to operate a device by "teaching" the correct commands to the device buttons on the main screen menu; to the two sub-pages within each device button; to the 31 buttons and the joystick located in the middle of the remote control. The RV-8 remote learns these commands by receiving infrared signals directly from your existing remote controls. The RV-8 remote receives these signals through its learning eye, located at the top of the unit.

Apart from the PAGE, HOME and FAV buttons, which cannot be taught, the RV-8 remote has the capability of learning up to 530 commands.

Note:

Function buttons are buttons that can be assigned a command to control a particular action for a device. Commonly used function buttons include the 2 pages of sub-commands within each of the 10 devices: channel up/down, volume up/down, menu, guide, exit, info, digits 0-9 and the center of the joystick (thumbpad).

CAUTION! Do not edit the Main, Zone 2 or Zone 3 buttons. Doing so will remove RV-8 control.

IMPORTANT POINTS TO REMEMBER

If the remote control fails to learn a function after a first attempt:

- Keep the remotes stable by placing them on a flat surface.
- Make sure the original remote is pointed at the learning eye at the top end of the case and is not at an angle.
- Make sure both remotes' batteries aren't low.
- Avoid programming the RV-8 remote under bright lights, which can interfere with the infrared signals.
- Some buttons require a single, short push of the original remote's button; other "repeating" buttons, such as the VOL button, require that you "press and hold" the original remote's button until "Good" flashes twice on the LCD screen.
- Try varying the distance between the remotes to find an optimal distance at which the codes are learned on the first or second try.

PROGRAMMING THE FUNCTION BUTTONS

To program the Function Buttons:

1. Go to the SETUP mode by pressing both the HOME and ENT buttons simultaneously for three seconds.
2. Press the LEARN button next to the LCD screen.
3. Select the DEVICE that contains the function button you wish to program.
4. Press the PAGE button to go to page 2 of the device if necessary.
5. Place the original remote control head to head with the RV-8 remote about 2 inches apart on a flat surface.
6. Press the button on the RV-8 remote you wish to program. Only the three HOME, PAGE and FAV buttons cannot be programmed. It is not recommended that you re-program the Main, Zone 2 or Zone 3 buttons.
7. Press the button on the original remote control that you wish to program onto the RV-8 remote. Once the RV-8 remote has received the signal, the RV-8 remote will flash "GOOD" on the LCD screen, indicating it learned the code correctly. (Perform Step 6 within 20 seconds of step 5; otherwise the remote will revert to the SETUP menu, and then after a period of time, it will go back to the MAIN device page.) If it flashes "Fail," repeat from step 4 until it learns successfully.
8. Repeat from step 3 until you have programmed all of the buttons that are required.
9. Once you complete the programming and wish to exit the LEARNING mode, press the HOME button. Exit from the SETUP mode by pressing the HOME button again.

If you are having problems learning to the Volume, Channel and Transport buttons, it may be because you have previously assigned a "Punch Through" from another device to that device. To remove a Punch Through, just "punch through" the device to itself. For

example, to erase a punch through from a TV to a SAT device, just "punch" through the TV to the TV.

See "Programming "Punch Through" Functions" on page 12 for more information.

PROGRAMMING THE TEN DEVICE BUTTONS

This procedure will program ONE learned code onto the Device button, so that when that Device is selected, it will send out the learned signal as it changes to that Device's function pages.

To program the one learned code onto the Device button:

1. Go to the SETUP mode by pressing both the HOME and ENT buttons simultaneously for three seconds.
2. Press the LEARN button next to the LCD screen.
3. Important: Press the PAGE button.
4. Place the original remote control head-to-head with the RV-8 remote about 2 inches apart on a flat surface.
5. Select any of the 10 device buttons to program onto the RV-8 remote. Press the button on the original remote control to program into the Device button chosen on the RV-8 remote. Once the RV-8 remote has received the signal, the RV-8 remote will flash "GOOD" on the LCD screen, indicating it learned the code correctly. If it flashes "FAIL," repeat from step 4 until it learns successfully. (Make sure to enter the code signal within 20 seconds of programming.)
6. Return to step 5 until all Device buttons have been programmed.
7. When done programming, press the HOME button to exit the Learning mode. Exit from the SETUP mode by pressing the HOME button once again.

Note:

Follow these instructions only if you actually want a code sent when changing devices. It may not be desired to send out codes when changing to a device. For example, you program the RV-8's TV input code on the TV device, and are currently in the DVD device pages. The RV-8's input is set to DVD. Now you want to quickly adjust the picture on the TV. If the TV device button is pushed, it will change the input on the RV-8 to TV and you will not be able to adjust the picture for the DVD. In this case, it would be better to not program a code to the TV device.

PROGRAMMING FAVORITE CHANNELS

Up to 50 Favorite Channel buttons can be programmed and saved. Each favorite channel button can send up to 10 commands with one button press.

To program Favorite Channel Buttons:

1. Go to the SETUP mode by pressing both the HOME and ENT buttons simultaneously for three seconds.
2. Press the FAV button next to the LCD screen.
3. Press the device button that corresponds to the component that the FAV channel will control. For example, pressing the TV device will only send the type of code to which that the TV responds to. Pressing the SAT device will only control the satellite box.
4. Press the LCD button you will be assigning to the favorite channel and enter the channel number you wish to store in the FAV channel button. Up to 10 digits can be stored.
5. Press the favorite channel button selected in step 4 again to store the programmed channel.

Note:

If a wrong channel number is pushed, move the cursor by using the left or right button of the joystick and then reassign the correct channel number.

6. Repeat from Step 3 until all the desired FAV channel buttons have been programmed.
7. Once programming is completed, press the HOME button to exit from the Favorite Channel mode. Exit from the SETUP mode by pressing the HOME button once again.

There are five pages of LCD screens for favorite channel programming. Scroll to other pages by pressing the PAGE or FAV button. In the Favorite Channels macro, the following buttons can be used: 0-9, ENTER, DISPLAY, POWER, SYSTEM OFF and INFO/PAUSE.

Note:

To make even more powerful FAV macros, codes can be learned from original remote(s) to the 0-9, ENTER, DISPLAY, POWER, SYSTEM OFF and INFO/PAUSE buttons in any device, and used in your FAV macros. (This will not work if a preprogrammed device code has been applied to those buttons.) For example, some TVs require a code be sent after the digits other than the ENTER code in order to change channels. In this case, you could learn the proper code to the ENTER button from your original TV remote, and use that in your FAV macro.

PROGRAMMING MACRO BUTTONS

A “macro” is a series of commands that can be sent with the push of a single button. There are two types of macro functions that can be programmed: functions involving the M1, M2 and M3 buttons; or functions involving the POWER and SYSTEM OFF buttons. Each of these buttons is designed to send up to 20 commands. The 10 device buttons can also send a macro of up to 20 commands when the device button is pressed for more than one second while on the HOME page of the remote control.

Note:

If the POWER or SYSTEM OFF buttons are programmed with a macro, they will no longer function as ON and OFF buttons for components. To restore their original on and off function, erase any macros programmed onto them.

PROGRAMMING MACRO FUNCTIONS TO M1, M2, M3, POWER AND SYSTEM OFF BUTTONS

To program macro functions to the M1, M2, M3, Power, System Off buttons:

1. Go to the SETUP mode by pressing the HOME and ENT button simultaneously for three seconds.
2. Press the MACRO button next to the LCD screen.
3. Press the macro button (M1, M2, M3, Power or System Off) being programmed.
4. Press the functional buttons you wish to store in the device macro button you selected, in the order you want them stored. Up to 20 commands can be stored.
5. Be sure to end a macro on the Device page that you would like it to remain on when the macro is sent in normal use.
6. Store the commands programmed into the macro button by pressing the CH UP button.

7. Repeat from step 3 until you have programmed all of the Macros that you require.
8. When programming is complete, press the HOME button. Exit from the SETUP mode by pressing the HOME button once again.

Note:

Do not press the HOME button at the beginning of a macro, or it will not work. The HOME button can be used at any other step in a macro. The M1, M2, M3, POWER and SYSTEM OFF macros are system-wide, which means they will function the same no matter what device is being used when they are programmed.

PROGRAMMING MACRO FUNCTIONS TO THE TEN DEVICE BUTTONS

To program Macro function to the 10 device buttons:

1. Go to the SETUP mode by pressing the HOME and ENTER buttons simultaneously for three seconds.
2. Press the MACRO button next to the LCD screen.
3. Important: Press the PAGE button.
4. Press one of the 10 device buttons.
5. Press the functional buttons you wish to store in the device macro button you selected in the order you want them stored. Up to 20 commands can be stored.

Note:

Do not press the HOME button at the beginning of a macro, or it will not work. The HOME button can be used at any other step in a macro.

6. Be sure to end your macro on the Device page that you would like to remain on when the macro is sent in normal use.

7. Return to step 4 until all desired commands are programmed.
8. Save the commands selected to the macro button by pressing the CH UP button.
9. Once you complete the programming and wish to exit from this mode, press the HOME button. Exit from the SET UP mode by pressing the HOME button once again. Tip: Remember that a single push of a Device Button that has a macro connected to it will take you to that device's function pages. Hold the Device Button down for one second in order to send the macro that you have created for that Device Button.

Note:

Pressing the PAUSE button (bottom right of cursor pad) during the macro programming will add a time delay of 0.2 seconds between the commands. For example, pressing the PAUSE button three times will create a pause of 0.6 seconds between the commands where the delay was inserted. Pressing PAUSE does not count as a macro step.

When using a macro, remember to keep the remote pointed toward the components until the macro is finished being transmitted. A "Sending" icon will flash in the upper right corner of the LCD screen as the macro is sending each command. It will not appear when a series of PAUSE commands are being executed. Wait until the icon finishes flashing before using other functions or putting down the remote.

SAMPLE MACRO SEQUENCE

The following is a sample macro which demonstrates what a macro can accomplish. This example assumes the names of the devices have not been changed and that the "punch through" technique was used to assign the VOL to the RV-8. If the labels have been changed, insert the changed names into the example.

In this example, the M1 button will be used to power on the TV, the RV-8 and the cable box; choose the appropriate inputs; and tune in a favorite TV channel.

1. Press HOME and ENT simultaneously for three seconds.
2. Press MACRO.
3. Press M1.
4. Press MAIN. (Opens the remote control MAIN device page.)
5. Press POWER.
6. Press TV. (Opens the TV device page.)
7. Press POWER.
8. Press HOME.
9. Press SAT. (Opens the SAT device page.)
10. Press POWER.
11. Press HOME.
12. Press MAIN
13. Press PAUSE three times. Pressing the PAUSE button three times allows for an extra .6 seconds of wait time (3 x .2 seconds per push = .6 seconds). This step is included in this example because most receivers and amps take time to "cycle up" and cannot receive any commands, such as input, until the device is ready. This example enabled the other steps of the macro to run while the Audio device is "cycling up."
14. Press SAT. (This selects the "SAT" input on the RV-8.)
15. Press HOME.
16. Press SAT. (Back to this device to enter the appropriate channel.)
17. Press 1, then 3, then 5. (Then press the ENT button if the cable device requires it.)
18. Press CH UP to save the macro.
19. Press HOME twice. Press M1 to test the macro. It should turn on the RV-8, then the TV, then the satellite box, then change the input to SAT on the RV-8, then change the channel to 135.

Note:

A macro can end on any page, including the HOME page. In the previous example, the macro was ended on the SAT page before saving it, as this was the desired endpoint.

PROGRAMMING “PUNCH THROUGH” FUNCTIONS

The RV-8 volume control can be used in a different mode using the volume “punch through” feature. You can also have channel “punch through” (Channel Up, Channel Down) as well as eight VCR (or DVD) transport buttons (Play, Stop, Fast Forward and Rewind, Skip-, Skip+, Pause, Record) operate in another mode such as SAT, CD and RV-8 MAIN modes.

To program “punch through” functions:

1. Go to the SETUP mode by pressing the HOME and ENT buttons simultaneously for three seconds.
2. Press the PUNCH button next to the LCD screen.

Note:

When using “Punch Through,” think of the first device selected as the device that now controls the functions, and think of the second device as the device you want to control those functions. You are taking the controls of the second device and “punching them through” to the first device.

3. Press the VOL button on the LCD for Volume Punch Through, the PLAY button for Transport Punch Through and the CH button for Channel Punch Through.
4. Select the device you wish to “punch through” to (first device example - television or satellite receiver).
5. Select the device you wish to “punch through” from (second device example - RV-8 MAIN).

You are punching through the controls of the second device to the device that is currently being controlled by any other buttons. For example, for VOL you are “punching through” the controls of the RV-8 MAIN VOL to the TV or SAT, enabling you to control the RV-8 MAIN VOL when in the TV or SAT screen.

6. Punch Through is saved when the second device is pressed.
7. Repeat from step 2 to program Punch Through for other devices.
8. Once you complete the programming and wish to exit from this mode, press the HOME button. Exit from the SETUP mode by pressing the HOME button once again.
9. Repeat from step 5 to “punch through” any other devices or learned buttons.
10. Press the HOME button to exit to main Punch Through mode. Press the HOME button once again to exit the SETUP mode.

ERASING MACRO FUNCTIONS**To erase M1, M2, M3, Power, System Off buttons:**

1. Go to the SETUP mode by pressing both the HOME and ENT buttons simultaneously for three seconds.
2. Press the ERASE button next to the LCD screen.
3. Press the MACRO button.
4. To erase all of the macro buttons in the RV-8 remote, press the ALL button and then press the SURE? button at the next LCD screen.
5. To erase just one of the macros, press the KEY button at step 4 and then one of the M1, M2, M3, POWER or SYSTEM OFF buttons to erase the macro functions from that button.
6. Press the HOME button to exit to main Erase mode.
7. Press the HOME button once again to exit the SETUP mode.

ERASING FAVORITE CHANNEL BUTTONS

To erase favorite channel buttons:

1. Go to the SETUP mode by pressing both the HOME and ENT buttons simultaneously for three seconds.
2. Press the ERASE button next to the LCD screen.
3. Press the FAV button.
4. To erase all the favorite channel buttons in the RV-8 remote, press the ALL button and then press the SURE? button at the next LCD screen.
5. To erase one button, press the KEY button. Press the individual button you want to erase and continue with any other individual buttons you want to erase.
6. Repeat from Step 5 to erase any favorite channel buttons.
7. Press the HOME button to exit to main Erase mode.
8. Press the HOME button once again to exit the SETUP mode.

ERASE MACRO FUNCTIONS FROM DEVICE BUTTONS

To erase macro function from device buttons:

1. Go to the SETUP mode by pressing the HOME and ENT buttons simultaneously for three seconds.
2. Press the ERASE button next to the LCD screen.
3. Press the MACRO button.
4. Press the KEY button.
5. Press one of the 10 DEVICE buttons from which you wish to erase the macro function. Once the device button has been pushed the macro has been erased. The LCD will flash "ERASED!"
6. Exit from Macro mode by pressing the HOME button and then exit from SETUP mode by pressing the HOME button once again.

ERASING PUNCH THROUGH FUNCTIONS

To erase "punch through" functions:

1. Go to the SETUP mode by pressing the HOME and ENT buttons simultaneously for three seconds.
2. Press the PUNCH button next to the LCD screen.
3. Press the VOL button for Volume Punch Through, the PLA button for Transport Punch Through or the CH button for Channel Punch Through.
4. Press the device button from which you wish to erase Punch Through.
5. Press the same device button again.
6. Punch through is erased when the same device button is pressed the second time.
7. Repeat from step 2 to erase the Punch Through for other devices.
8. Exit from Punch Through mode by pressing the HOME button and then exit from the SETUP mode by pressing the HOME button once again.

EDIT TEXT ON FUNCTION/DEVICE BUTTONS

To edit text on function or device buttons:

1. Enter the SETUP mode by pressing the HOME and ENT buttons simultaneously for three seconds.
2. Press the EDIT button next to the LCD screen.
3. Press the DEVICE button to display the function buttons for that device.
4. Press the function button on which you wish to write or edit text. You can also go to the second page of the device by pressing the PAGE button.

5. To edit DEVICE button text, skip Steps 3 and 4 and press the PAGE button before selecting the Device button.
6. The character to be changed will blink. To change the character use the number pad buttons on the remote control. The characters assigned to each number pad button are shown below. It will cycle to a different character each time the same number pad button is pressed.

Note:

Move the cursor left or right using the joystick. Delete a current character by using the cursor down on the joystick. Using the "cursor down" technique is a quick way to delete all of the text on a label.

1. A B C	2. D E F	3. G H I	4. J K L
5. M N O	6. P Q R	7. S T U	8. V W X
9. Y Z (Blank)	0. + - <>, etc		

7. Save the text by pressing the button you were writing on (the same function button selected in step 3 or device button in step 4).
8. Exit from Edit mode by pressing the HOME button and then exit from the SETUP mode by pressing the HOME button again.

EDIT TEXT FOR FAVORITE CHANNEL BUTTONS

To edit text for favorite channel buttons:

1. Go to the SETUP mode by pressing the HOME and ENT buttons simultaneously for three seconds.
2. Press the EDIT button next to the LCD screen.
3. Press the FAV button and then the favorite channel button on which you wish to write text. There are five LCD pages of favorite channels. Select the page you wish to write on by pressing the PAGE button.

4. The character to be changed on the button you selected will blink and you can change the character using the number pad buttons on the remote control. The characters assigned to each number pad button are shown in the previous column. It will cycle to a different character each time the same number pad button is pressed.
5. Save the edited text by pressing the same function button selected in step 4.
6. Exit from Edit mode by pressing the HOME button and then exit from the SETUP mode by pressing the HOME button once again.

RECALLING THE PREPROGRAMMED THREE-DIGIT NUMBER

1. Go to the SETUP mode by pressing the HOME and ENT buttons simultaneously for three seconds.
2. Press the RECAL button next to the LCD screen.
3. The LCD display will alternately flash device names and the three-digit code number assigned to the device for 10 seconds and then exit to the SETUP mode.
4. Before the 10 seconds are up, pressing the HOME button on the remote will stop the flashing and exit to the SETUP mode.
5. Exit from SETUP mode by pressing the HOME button once again.

ERASING LEARNED BUTTONS

To erase learned buttons:

1. Go to the SETUP mode by pressing both the HOME and ENT buttons simultaneously for three seconds.
2. Press the ERASE button next to the LCD screen.
3. Press the LEARN button.

4. If you wish to erase all the learned functions in the RV-8 remote, press the ALL button and then press the SURE? button at the next LCD screen.
5. To erase all the buttons in a single device or an individual button in the device, press the DEVICE button.
6. Press the device button (TV, VCR, MAIN, etc.) to erase the button(s) from the device.

Note:

Press the PAGE button and then press the DEVICE button (TV, VCR, etc.) to erase the learned function in the device button itself.

7. Press the ALL button to erase all the learned buttons in the device and press the SURE? button at the next LCD screen.
8. Press a single button to erase individual buttons one at a time. This will show all the functions in the device. Press the button you wish to erase.

PROGRAMMING THE BACKLIGHT TO TURN OFF

The backlight can be toggled On and Off by pushing the LIGHT button on the top right side of the remote. It can also be set to turn off at a predetermined time.

To program the backlight:

1. Go to the SETUP mode by pressing the HOME and ENT buttons simultaneously for three seconds.
2. Press the LIGHT button next to the LCD screen.
3. Using the number pad buttons, enter the desired backlight time (in seconds). It can go up to 99 seconds. Save the time by pressing the button to the right of the time just assigned.
4. Exit from the SETUP mode by pressing the HOME button.

Note:

The time entered in SETUP for the backlight to go off is extended each time a button is pushed. The light will turn off at the predetermined interval after the last button has been pushed.

CLONING THE RV-8 REMOTE CONTROL**To clone the remote from another remote:**

1. Go to the SETUP mode by pressing the HOME and ENT buttons simultaneously for three seconds.
2. Press the CLONE button next to the LCD screen.
3. Press either the SEND or RECV button depending upon the role of the remote control. If the RV-8 remote is to be copied from, press the SEND button. If it is to be copied to, press the RECV button.
4. To clone the entire remote, press the ALL button. To clone only one device at a time, press the DEVICE button.
5. Press the DEVICE button to show all of the devices. Press the device button you wish to clone.
6. Set the RV-8 remote head-to-head with another RV-8 remote. Each unit should be in either cloning from or cloning to mode, based on the above steps.
7. Press the START button on both units to begin cloning. It will take about 40 seconds to complete the cloning. The LCD will flash "GOOD" upon completion.
8. Exit from the Cloning mode by pressing the HOME button and then exit from the SETUP mode by pressing the HOME button again.

ADJUSTING THE LCD CONTRAST

To adjust the LCD contrast:

Pressing the HOME button and Up on the joystick simultaneously will make the LCD contrast darker. Pressing the HOME button and Down on the joystick simultaneously will make the LCD contrast brighter.

BATTERY LIFE

Under normal operating conditions, the batteries will last approximately six months. If the batteries are running low, there will be reduced range from the remote, commands that are not sent properly, or are not sent at all. The backlighting of the LCD screen and the buttons may be diminished. Should any of these occur, replace the batteries immediately. To ensure proper performance of the remote, use four new AAA alkaline batteries. However, the worn batteries should be replaced with a fresh set as soon as possible. Do not mix new and used batteries.

Note:

If the batteries are running low, the LCD displays "LOW BATTERY" when the POWER button is pressed, or when the HOME and ENT buttons are pressed simultaneously.

The remote has an internal memory lock system that retains all of the programs and learned functions for an extended period of time in the event of battery loss or replacement.

CAUTION!

The LCD screen is breakable glass. Do not tap the LCD screen to activate devices. Use the rubber buttons beside the labels on the screen.

The RV-8 remote control is not waterproof. Never immerse it in water. Keep the LCD screen dry. Immediately wipe off any spilled liquid.

Do not expose the RV-8 remote to extreme temperatures. Keep it away from any heat sources.

Avoid dropping the remote control.

Clean the LCD screen with a soft cloth. Never use abrasives or cleaning solutions on the soft cloth.

RECALLING THE ZONE AUDIO CODES FOR THE RV-8

To recall the RV-8 zone audio codes:

1. Simultaneously press MAIN and ENT buttons to access SETUP mode.
2. Press the RECAL button next to the LCD screen.
3. The LCD display will alternatively flash device names and the three-digit code number assigned to the device for 10 seconds and then exit to the SETUP mode. Make sure that the audio code has the correct (default) number.
4. The MAIN zone default audio code should be 001. The ZONE 2 default audio code is 302, and the ZONE 3 default audio code is 303. If one of these codes has inadvertently been changed, reprogram the codes as described below.

REPROGRAMMING THE ZONE AUDIO CODES TO DEFAULT CODES

To reprogram the RV-8 zone audio codes:

1. Simultaneously press MAIN and ENT buttons to access SETUP mode.
2. Press the P-PRO button next to the LCD screen.
3. The remote should flash SELECT BUTTON at the bottom of the LCD screen. Press the button for the zone you wish to reprogram.
4. The remote should flash FROM TABLE at the bottom of the LCD screen. Select the MAIN zone button.
5. The remote should flash ENTER NUMBER. The correct (default) audio codes for the RV-8 zones are as follows: MAIN zone is 001, ZONE 2 is 302 and ZONE 3 is 303.
6. Enter the correct code.
7. Press SAVE on the right of the LCD screen to enter and save the audio code for the zone.
8. Exit from Preprogrammed mode by pressing the HOME button and then exit from the SETUP mode by pressing the HOME button once again.

THREE-DIGIT PREPROGRAMMED CODES

AUDIO

Manufacturer	Codes
ADC	007
ADCOM	082 092 225 161 269
AIWA	018 104 170 202 203 213 211 188
AKAI	138 189
AMC	125 126 127 128 258 281 282
AMEND	054
AMX	196
ANGSTROM	142
ARCAM	141
AUDIO ACCESS	147
AUDIO ALCHEMY	135
AUDIO DESIGN	194 221 011
AUDIO EASE	021 196 207
AUDIO FILE	071
AUDIO MATRIX	167
AUDIO SOURCE	273
AUDIO TECHNICA	134
B & K	096 097
BOSE	070 170 224
BRYSTON	023
CARVER	006 028 061 071 201 214 226 180 185 022 029 077 284
CASIO	076
CHIRO	140
CINEMA SOUND	034 134
CITATION	148 272
CLARION	026
CURTIS MATHES	076
DENON	002 034 109 215 229 230 027 037 234 259
EIGER	149
ELAN	057
ENLIGHTENED AUDIO	099 098

AUDIO

Manufacturer	Codes
FISHER	047 214 180 182
FOSGATE	062 231
GE	056 260
GOLDSTAR	008
HAFLER	174
HARMAN KARDON	231 233 254 153 154 118 121 227 277
INKEL	197
JBL	263
JCPENNY	076 216
JEFF ROWLAND	206
JENSEN	058
JVC	240 163 191 114 266 279
KENWOOD	026 066 145 146 181 190 197 192 182 199 151 222 180 005 280
KINERGETICS	220 140
KOSS	216
KRELL	150 072
KYOCERA	007
LEXICON	120 235 236 237
LINN	124
LUXMAN	137 139 052 165 115 004 009
LXI	076 056
MAGNAVOX	038 164 152 208
MARANTZ	006 028 031 040 063 185 186 251 265
MCINTOSH	238
MCS	076
MERIDIAN	100 012 013
MINIBISHI	242 243 204
MONDIAL	157 158 042 043 081 112
MYRYAD	276
NAD	186 113 283
NAKAMICHI	111 244 245 172 183
NEC	176
ONKYO	017 046 064 107 108 187 079 080 090 179 209 270 275
OPTIMUS	026 041 138

AUDIO

Manufacturer	Codes
PANASONIC	032 195 219 177
PARASOUND	129 130 132 261
PHAST	196
PHILIPS	249 250 251 063
PIONEER	014 033 039 044 045 050 069 159 168 116 035 078 198
PROCEED	144 268
RCA	010 048 117 156 067
REALISTIC	019 056 073 075 095
REVOX	162
ROTEL	074 083 085
SAMSUNG	016
SANSUI	040 048 110 119 065 228
SANYO	047 059
SCOTT	019 091
SEARS	076
SHARP	026 094 131 175 181
SHERWOOD	024 038 055 102 103 105 106 051 030
SONY	018 093 223 247 248 160 166 015 101 184 218 271
SOUNDESIGN	036
SOUNDSTREAM	084 088
SSI	068
SUMO	171
TAEKWANG	138
TEAC	005 019 049 111 212 217
TECHNICS	122 176 193 219 178 177 200 257 262
THETA DIGITAL	136
TOSHIBA	060 087 198 278
WARDS	180
YAMAHA	026 253 169 067 173 205 264 232 089 264 274 285
ZENITH	143 210

DVD

Manufacturer	Codes
APEX DIGITAL	087
DENON 007	080
GE	026 027
HARMAN KARDON	084
JVC	012
LG	091 057 074
MAGNAVOX	066
MARANTZ	083
MITSUBISHI	017
NAD	088
ONKYO	076 035
PANASONIC	021 042
PHILIPS	066
PIONEER	023 092 107 108
PROCEED	086
PROSCAN	026 027
RCA	026 027
SAMSUNG	056 070
SHARP	094
SONY	033
THETA DIGITAL	032
THOMPSON	026 027
TOSHIBA	035 034
YAMAHA	042 089
ZENITH	057 074 091

SAT

Manufacturer	Codes
ALPHASTAR	123
AMPLICA	050
BIRDVIEW	129 113 051 126
BSR	053
CAPETRONICS	053
CHANNEL MASTER	013 014 015 018 036 055
CHAPARRAL	008 009 012 077
CITOH	054
CURTIS MATHES	050
DRAKE	005 006 007 010 011 112 116 141 052
DX ANTENNA	024 046 056 076
ECHOSTAR	038 040 057 058 093 094 095 096 097 098 099 100 122
ELECTROHOME	089
EUROSAT	114
FUJITSU	017 021 022 027 133 134
GENERAL ELECTRIC	151 106 150
GENERAL INSTRUMENT	003 004 016 029 031 059 101 148
HITACHI	139 140
HOME CABLE	080 044 029
HOUSTON TRACKER	033 037 039 104 057 051
HUGHES	068 154
HYTEK	053
HYUNDAI	149
ICR	023
JANIEL	060 147
KATHREIN	108
LEGEND	057
LUTRON	132
LUXOR	144 062
MACOM	010 059 063 064 065
MEMOREX	057
NEXTWAVE	028 124 125
NORSAT	069 070
PACE	143
PANASONIC	142 060
PANSAT	121
PERSONAL CABLE	117

SAT

Manufacturer	Codes
PHILIPS	071 152 153
PL	023 026
PRESIDENT	019 102
PRIMESTAR	110 030
PROSAT	072
PROSCAN	151 106 150
RCA	151 106 150
REALISTIC	043 074
SAMSUNG	123
SATELLITE SERVICE	028 035 047 085
SONY	103
STARCAST	041
SUPERGUIDE	020 124 125
TEECOM	023 026 075 087 088 090 107 130 137
TOSHIBA	002 127
TOWN & COUNTRY	023 026
UNIDEN	016 025 042 043 044 045 048 049 078 079 080 086 101 135 136
VIEWSTAR	115
WINEGARD	128 146
ZENITH 081	082 083 084 091 120

VCR

Manufacturer	Codes
AIWA	034 161
AKAI	016 043 046 124 125 146
AMPRO	072
ANAM	031
AUDIO DYNAMICS	012 023 039 043
BROOKSONIC	035 037 129
CANON	028 031
CAPEHART	108
CRAIG	003 040 135
CURTIS MATHES	031 041
DAEWOO	005 007 010 065 108 110 111 112 116 117 119
DAYTRON	108
DBX	012 023 039 043
DYNATECH	034 053
ELECTROHOME	059
EMERSON'	006 017 025 027 029 031 034 035 036 037 046 101 129 131 138 153 162 116
FISHER	003 008 009 010
FUNAI	034
GE	031 063 072 107 109 144 147
GO VIDEO	132 136 155 040 115
GOLDSTAR	012 013 020 101 106 114 123
HARMAN KARDON	012 045
HITACHI	004 018 026 034 043 063 137 150 160 013
INSTANTREPLAY	031
JCL	031
JCPENNY	012 013 015 040 066 101
JENSEN	043
JVC	012 031 043 048 050 055 060 130 150 152
KENWOOD	014 048 034 047
LLOYD	034
LXI	003 009 017 034 106
MAGIN	040

VCR

Manufacturer	Codes
MAGNAVOX	031 034 041 067 068 156 164
MARANTZ	012 031 067 069
MARTA	101
MATSUI	027 030
MEI	031
MEMOREX	003 010 014 031 034 053 072 101 102 134 139
MGA	045 046 059
MINOLTA	013 020
MITSUBISHI	013 020 045 046 051 059 061 142 151 049
MTC	034 040
MULTITECH	024 034
NEC	012 023 039 043 048
NORDMENDE	043
OPTONICA	053 054
ORION	025
PANASONIC	066 070 083 133 140 145 157 163 074
PENTAX	013 020 031 063
PHILCO	031 034 067
PHILIPS	031 034 054 067 071 101
PILOT	101
PIONEER	013 021 048
PORTLAND	108
PULSAR	072
QUARTZ	002 014
QUASAR	066 145 075
RADIO SHACK	123
RCA	013 020 041 107 109 140 144 145 147 034 040 158
REALISTIC	003 008 010 014 031 040 053 054 101
RICO	058
RUNCO	148
SALORA	014
SAMSUNG	032 040 066 102 104 107 109 112 113 115 120 122 125
SANSUI	022 043 048 135

VCR

Manufacturer	Codes
SANYO	003 007 010 014 134 102
SCOTT	017 037 112 129 131
SEARS	003 008 009 010 013 014 081 101 017 073 112
SHARP	031 054 149 159 165
SHINTOM	024
SIGNATURE	034
SONY	003 031 052 056 057 058 076 077 078 149 154
SOUNDESIGN	034
STS	013
SYLVANIA	031 034 059 067
SYMPHONIC	034
TANDY	010 034
TATUNG	039 043
TEAC	034 039 043
TECHNICS	031 070
TEKNIKA	019 031 034 101
THOMAS	034
TMK	006
TOSHIBA	008 013 042 047 059 079 082 112 131 081
TOTEVISION	040 101
UNITECH	040
VECTOR RESEARCH	012
VICTOR	048
VIDEO CONCEPTS	012 034 046 141
VIDEOSONIC	040
WARDS	003 013 017 024 031 034 040 053 054 131
YAMAHA	012 034 039 043
ZENITH	034 048 056 058 072 080 101

TV

Manufacturer	Codes
ADMIRAL	072 081 161 160
AKAL	197 146
AMARK	112 143
AMPRO	073 167 157 183
AMSTRAD	052
ANAM	043 054 056 080 112 131
AOC	197 004 112 058
AUDIOVOX	076
BLAUPUNKT	088
CAIRN	201
CANDLE	197 002 003 004
CAPEHART	058
CETRONIC	043
CITIZEN	197 002 003 004 043 101 103 143
CLASSIC	043
CONCERTO	004
CONTEC	043 050 051
CORONADO	143
CRAIG	043 054
CROWN	043 143
CURTIS MATHES	197 101 004 143
CXC	043
DAEWOO	004 016 043 044 076 103 114 125 127 143
DAYTRON	004 143
DWIN	177
DYNASTY	043
DYNATECH	062
EIKI	187
ELECTROHOME	024 076 143 196
EMERSON	197 004 005 028 043 047 048 050 051 076 096 143 151 153 154 155
FISHER	007 057

TV

Manufacturer	Codes
FUJITSU	198
FUNAI	028 043
FUTURETECH	043
GE	197 008 009 034 056 073 074 130 144 155 160 161 165 004 091 157 183
GOLDSTAR	004 102 106 112 113 116 119 127 143
HALL MARK	004
HITACHI	004 009 010 011 012 023 075 143 158 163 166 072
INFINITY	164
JBL	164
JCPENNY	197 004 008 009 024 030 065 101 143 156 160
JENSEN	013
JVC	034 038 070 083 145 199
KEC	043
KENWOOD	197 070
KLOSS	002 059
KMC	143
KTV	197 043 143 154
LODGENET	072
LOGIK	072
LUXMAN	004
LXI	166 007 015 052 081 160 164
MAGNAVOX	197 003 004 022 059 060 061 063 064 127 160 164 094
MARANTZ	197 164
MATSUI	164
MEMOREX	007 072 004
METZ	088
MGA	197 004 024 028 042
MINERVA	088
mitsubishi	004 024 028 040 042 109 124 146 191
MTC	197 004 062 101
NAD	015 025

TV

Manufacturer	Codes
NEC	132 130 134 197 040 016 024 056 019
NIKEI	043
ONKING	043
ONWA	043
OPTONICA	019 081
ORION	096
PANASONIC	034 056 080 092 164
PHILCO	197 003 024 056 059 060 063 064 164 004
PHILIPS	197 003 004 005 038 059 093 164 127
PIONEER	197 018 023 025 116 135 190 203 204
PORTLAND	004 143
PROSCAN	144 160 161 165 167
PROTON	004 058 131 143 171 173 193
QUASAR	034 056 092
RADIO SHACK	019 043 143 004 127
RCA	160 161 165 065 156 144 197 004 023 024 056 074 152
REALISTIC	007 019 043 047
ROCTEC	186
RUNCO	168 169 178 179 180 181 182 183 073 157
SAMPO	197 058 004 202
SAMSUNG	004 050 089 101 105 127 143 160
SANYO	166 007 020 053 057 082 187
SCOTT	004 028 043 048 143
SEARS	015 030 004 007 028 057 143 094 160 082 165 166
SELECO	189 200
SHARP	170 081 019 028 029 014 004 022 143 175
SIEMENS	088
SIGNATURE	072
SONY	070 085 139 147 126 185 194
SOUNDESIGN	004 028 003 043
SPECTRICON	112
SSS	004 043

TV

Manufacturer	Codes
SUPRE MACY	002
SYLVANIA	197 003 059 060 063 064 164 044 160 127
TANDY	081
TATUNG	056 062
TECHNICS	034 080
TECHWOOD	004
TEKNIKA	002 003 004 024 028 043 072 101 143
TELEFUNKEN	037 046 086 087
TELERENT	072
TERA	172
TMK	004
TOSHIBA	007 015 030 040 062 101 138
TOTEVISION	143
UNIVERSAL	008 009
VIDEO CONCEPTS	146
VIDIKRON	174 184 188 192
VIDTECH	004
WARDS	004 008 009 019 028 060 061 063 064 072 074 143 164 034
WESTING HOUSE	076
YAMAHA	197 004
YORK	004
YUPITERU	043
ZENITH	072 073 095 103 157 183
ZONDA	112

CD

Manufacturer	Codes
ADCOM	062 042
AIWA	059 065 088 089 105 122 170 187
AKAI	085 195 202
AMC	231 232
AMEND	118
ARCAM	238
AUDIO ACCESS	119 147
AUDIO EASE	165
AUDIO TECHNICA	046
BSR	037 057
CALIFORNIA AUDIO	103 008
CAPETRONIC	063
CARRERA	057 080
CARVER	185 041 044 050 086 107 130 134 135 138 139 203 204 167
CASIO	111 182
CLARINETTE	182
CREEK	159
CROWN	035
DENON	002 123
EMERSON	042 069 102
FISHER	050 185 134 008
FRABA	111
GENEXXA	010 069 102
GOLDSTAR	080
HAITAI	093
HARMAN KARDON	018 033 047 208
HITACHI	042 175
INKEL	130 143 144
JC PENNEY	014 061 092 141
JENSEN	158
JVC	004 022 136 163 213 214 242 243

CD

Manufacturer	Codes
KENWOOD	185 007 023 055 071 072 142 137
KOSS	061
KRELL	241
KYOCERA	005
LOTTE	102
LUXMAN	011 028 070 076
LXI	059
MAGNAVOX	044 107
MARANTZ	027 041 044 051 077 107 209
MCINTOSH	212
MCS	014 073 092
MEMOREX	010
MISSION	044 107
mitsubishi	179
MITSUMI	153
MODULAIRE	182
MONDIAL	147
MYRYAD	244
NAD	006 005 067 178
KAKAMICHI	217 218 219 095
NEC	014 062
NIKKO	046
NSM	044 107
ONKYO	030 038 039 168 169
OPTIMUS	010 050 057 058 081 082 083 085 093 195
PANASONIC	103 201 172 008 068
PARASOUND	233
PHILIPS	041 044
PIONEER	010 020 025 056 174 175 176
PROCEED	239
PROTON	044 107 228
QUASAR	103 008

CD

Manufacturer	Codes
RADIO SHACK	182
RCA	017 042 150
REALISTIC	042 050 051 102 181 182 187
ROTEL	044 107 161 178 250
SAE	044 107
SANSUI	044 069 107 128 171 190 125
SANYO	050
SCOTT	069 102
SHARP	026 031 051 066
SHERWOOD	003 019 051 096 112 115 119 166
SIGNATURE	033
SONY	048 081 097 126 133 177 225 226 164
SOUNDESIGN	251
SUMO	155
SYLVANIA	044 107
SYMPHONIC	052 181
TAEKWANG	195 085
TANDY	010
TEAC	015 034 036 051 052 101 131 140 079
TECHNICS	060 103 200 172 184 008 068
TECHWOOD	076
THETA DIGITAL	234 235
TOSHIBA	006 067 091 160 148
VECTOR RESEARCH	080
VICTOR	004 022 114 124
WARDS	185 033
YAMAHA	024 046 054 186 183 245
YORX	182

LD

Manufacturer	Codes
DENON	206 207
FUNAI	120
KENWOOD	152 013
MAGNAVOX	032 121
MARANTZ	211
mitsubishi	121
NAD	121
OPTIMUS	049 013
PANASONIC	113
PHILIPS	032
PIONEER	106 117 121
RADIO SHACK	120
RCA	002
REALISTIC	049
RUNCO	127
SANYO	075
SHARP	152 013
SONY	053 110
TECHNICS	113
THETA DIGITAL	032
TOSHIBA	152 106
YAMAHA	043 129

Note:

The LD codes are stored in DVD.

PHONO

Manufacturer	Codes
3M	152
AIWA	164
ARCHER	155
AUTON	191
DMX	156
DRAPER SCREEN	204
DWIN	080
EVERQUEST	206
EXTRON	151
FAROUDJA	184
FUJI	209
JERROLD	153
JVC	185
KENWOOD	185
LITE-TOUCH	208
LUTRON	077 158 159
MAKITA	186 201
MINDPATH	205
NILES	160 187
NSM	161
PIANO DISC PLUS	085
PHILIPS	090
POLK AUDIO	162
REPLAY	075
RUSSOUND	081
SCIENTIFIC ATLANTA	156 163
SIMA	082
SOLO ELECTRONICS	207
SOMFY	078 079
SONY	104 164 165 166
STARCOM	153
TURBOSCAN	167
VELODYNE	203
X-10	093 183
XANTECH	168 169 170 171 172 188 189

CABLE

Manufacturer	Codes
ABC	103 003 004 039 042 046 053
AMERICAST	099
ANTRONIX	014
ARCHER	005 007 014
BELL SOUTH	099
CENTURION	092
CENTURY	007
CITIZEN	007
COMBANO	080 081
COMSAT	074
COMTRONICS	030
DIGICABLE	101
EAGLE	020 030 040
EASTERN	057 066
ECHOSTAR	106
ELECTRICORD	032
GEMINI	008 054
GENERAL ELECTRIC	072
GENERAL INSTRUMENT	103 074 104
GNC	099
GOLDEN CHANNEL	030
HAMLIN	049 050 055
HITACHI	103 055
JERROLD	103 002 003 004 008 009 010 069 074
MAGNAVOX	010 012 064 079 095 094
MEDIA ONE	107
MEMOREX	052
MITSUBISHI	102
M-NET	037
MOVIE TIME	028 032
NOVAPLEX	092
NSC	015 028 038 071

CABLE

Manufacturer	Codes
OAK	031 037 053
PANASONIC	044 047
PARAGON	052
PHILIPS	006 012 013 020 085 095
PIONEER	103 034 051 063 076 105
PRUCER	059
RCA	047
RECOTON	098
REGAL	049 050
REGENCY	057
SAMSUNG	030
SCIENTIFIC ATLANTA	003 011 041 042 043 045 046
SIGNAL	030
SIGNATURE	103
SL MARX	030
SONY	096
SPRUCER	047 078
STARCOM	002 004 008 009
STARGATE	008 030 097 104
TADIRAN	030
TIME WARNER	043
TOCOM	039 040 056
TOSHIBA	052
UNIKA	007 014
UNITED CABLE	004 053
UNIVERSAL	005 007 014 032 035
VIEWSTAR	012 015 018 086 087 088 089
ZENITH	052 060 093 100

TAPE

Manufacturer	Codes
AIWA	015 071 100 114
CARVER	006 008 027 024 036
DENON	105 227 229
FISHER	064
GOLDSTAR	011
HARMAN KARDON	233
JVC	106 116 239 240
KENWOOD	005 013 023 026 064 145 146 181 190
LINN	124
LUXMAN	035 137 139
MAGNAVOX	027
MARANTZ	014 027 056 065 087
MCINTOSH	238
MITSUBISHI	242 243
NAD	029 048
NAKAMICHI	244 245 025
ONKYO	002 012 016 017 018 019 115
OPTIMUS	026 054 055
PANASONIC	007 010 032 088 195
PHILIPS	027 087
PIONEER	003 039 047 050 066 098 222
QUASAR	007 088
SANSUI	027 113 119 224
SHARP	026 057 131 175 181
SHERWOOD	038 004 028 030 033 034
SONY	020 022 052 084 089
TEAC	009 059 212
TECHNICS	007 010 076 088 109 122 199
TOSHIBA	112
VICTOR	106
YAMAHA	021 026 031 067 040

D

Appendix

Installation Worksheet D-2

INSTALLATION WORKSHEET

INPUT SETUP	DVD1	DVD2	SAT	VCR	TV	CD	TUNER	PHONO
NAME								
DIGITAL IN								
ANALOG IN								
ANLG IN LVL								
VIDEO IN								
COMPONENT IN								
2-CH								
								
								
5.1a								
MIC								
MAIN ADVANCED								
INPUT SELECT								
ANLG BYP								
S-VIDEO 16:9								
S-VIDEO 4:3 OSD								
COMPONENT OSD								
LEGACY VIDEO								
ZONE2 IN								
ZONE2 ADVANCED								
ANLG IN LVL								
DIGITAL BYPASS								
DIG OUT RATE								
RECORD								

SPEAKER SETUP	CUSTOM SETUP	THX SETUP	SPEAKER DISTANCES	LEVELS CALIBRATION
FRONT LEFT/RIGHT		THX 80Hz		
CENTER		THX 80Hz		
SIDE LEFT/RIGHT		THX 80Hz		
REAR LEFT/RIGHT				
SUBWOOFER		THX 80Hz		
THX ULTRA2SUB				
BGC				
ASA				
UNITS				
BASS PEAK LIMITERS				
CAL NOISE				
SUB LIMITER				
LIMIT ADJ				
I/O CONFIG	SETTINGS			
Analog Inputs	8 STEREO INPUTS		5 ST. & (1) 5.1 ANLG	2 ST. & (2) 5.1 ANLG
Amplifier Outputs	MAIN 7.1		MAIN 5.1 & ZONE2 2.0	MAIN 5.1 & ZONE3 2.0

INSTALLATION WORKSHEET (continued)

DISPLAY SETUP		TRIGGER SETUP		TUNER SETUP	
ON-SCREEN DISPLAY		Circle all parameters set to ON.		REGION	
STATUS		REMOTE ONLY	MONO	SCAN SENS	
POSITION		DVD1	5.1 FILM		
FORMAT		DVD2	5.1 TV		
BACKGROUND		SAT	5.1 MUSIC	LOCK OPTIONS	
FRONT-PANEL DISPLAY		VCR		MODES	
STATUS		TV	MUSIC	AUDIO CNTRL	
BRIGHTNESS		CD	5.1 PLIIX MOV	SETUP	
A/V SYNC DELAY		TUNER	5.1 PLIIX MUS		
CUSTOM NAME		PHONO	DIGITAL EX	AUDIO CONTROLS	
EDIT CUSTOM NAME		ZONE2 INPUTS	5.1 2-CHANNEL	BASS	
		ZONE3 INPUTS	5.1 MONO LOGIC	TREBLE	
VOLUME CONTROL SETUP		FILM	5.1 MONO Surr	TILT EQ	
MAIN PWR ON		TV	5.1 MONO	LOUDNESS	
MUTE LEVEL		MUSIC	FILM	BALANCE	
ZONE 2 PWR ON		MUSIC Surr	MUSIC	FADER	
ZONE 3 PWR ON		PLIIX +		ZONE2 BALANCE	
HEADPHONE		PLIIX MOV	MUSIC	ZONE3 BALANCE	
MAX VOLUME		PLIIX MUS			
		PLII +	2-CHAN		
		PLII MOVIE	5.1a FILM		
		PLII MUSIC	5.1a MUSIC		
		PL +	5.1a SurEX		
		PRO LOGIC	5.1a MUSIC		
		+	5.1a STANDARD		
		CIN	5.1a 2-CHANNEL		
		MUSIC	5.1a BYPASS		
		NIGHTCLUB	2CH BYPASS		
		CONCERT HALL	HEADPHONE		
		CHURCH	HEADPHONE 5.1		
		CATHEDRAL	HEADPHONE		
		PANORAMA	HEADPHONE 5.1a		
		2-CH SURROUND	LIVE! SMALL		
		2-CHANNEL	LIVE! MED		
		MONO LOGIC	LIVE! LARGE		
		MONO SURROUND			

3-DIGIT PREPROGRAMMED CODES WORKSHEET

COMPONENT	MANUFACTURER	CODE(S) USED
DVD1		
DVD2		
SAT		
VCR		
TV		
CD		
PHONO		

PREPROGRAMMED LCD TEXT FOR OTHER DEVICES

DVD1		DVD2	
PROG	MENU	RANDO	ANGLE
DISPL	SETUP	RETUR	S-ON
CLEAR	MEMO	AUDIO	S-CHA
REPEA	TITLE	TIME	SLOW+
A-B	SHUFF	SOUND	SLOW-
PAGE 1		PAGE 2	

SAT		SAT	
FAUCH	ACTIO	FETCH	HELP
ALPHA	REC	A	E
NEXT	SERVI	B	F
VIEW	BACK	C	G
ALT	HOP	D	H
PAGE 1		PAGE 2	

VCR		VCR	
V/T	INPUT	PROG	T-SPE
DISP	SLOW	COUNT	A-TRK
VCR-P	SLOW+	RESET	A-CH
F.ADV	SLOW-	CLEAR	ADD
XPLA	EJECT	T-REC	DELET
PAGE 1		PAGE 2	

SYSTEM-OFF	OFF
POWER	ON/OFF
VOL UP	
VOL DN	
CH UP	SKIP+
CH DN	SKIP-
MUTE	
PRE-CH	SEARCH
UP	UP
DOWN	DN
LEFT	LEFT
RIGHT	
SELECT	
PLAY	
STOP	
REW	
FF	
⏪, MENU	⏪
⏩, GUIDE	⏩
O, EXIT	EJECT
II, INFO	PAUSE
1	1
2	2
3	3
4	4
5	5
6	6
7	7
8	8
9	9
0	0
DISPLAY	DISPLAY
ENTER	ENTER

SYSTEM-OFF	OFF
POWER	ON/OFF
VOL UP	VOL UP
VOL DN	VOL DN
CH UP	SKIP+
CH DN	SKIP-
MUTE	MUTE
PRE-CH	SEARCH
UP	UP
DOWN	DN
LEFT	LEFT
RIGHT	RIGHT
SELECT	SELECT
PLAY	
STOP	
REW	
FF	
⏪, MENU	MENU
⏩, GUIDE	GUIDE
O, EXIT	EXIT
II, INFO	INFO
1	1
2	2
3	3
4	4
5	5
6	6
7	7
8	8
9	9
0	0
DISPLAY	DISPLAY
ENTER	ENTER

SYSTEM-OFF	OFF
POWER	ON/OFF
VOL UP	VOL UP
VOL DN	VOL DN
CH UP	SKIP+
CH DN	SKIP-
MUTE	MUTE
PRE-CH	SEARCH
UP	UP
DOWN	DN
LEFT	LEFT
RIGHT	RIGHT
SELECT	SELECT
PLAY	PLAY
STOP	STOP
REW	REW
FF	FF
⏪, MENU	⏪
⏩, GUIDE	⏩
O, EXIT	RECORD
II, INFO	PAUSE
1	1
2	2
3	3
4	4
5	5
6	6
7	7
8	8
9	9
0	0
DISPLAY	DISPLAY
ENTER	ENTER

TV		TV	
T/V	INPUT	P-ON	P-OFF
SLEEP	A-CH	SWAP	STILL
CC	ADD	SOURC	LOCAT
CC-SN	DELET	POSI	FREEZ
RESET	ANT		
PAGE 1		PAGE 2	

CD		CD	
PROG	INTRO	DISK 1	DISK 6
DISPL	TIME	DISK 2	
CLEAR	FADER	DISK 3	
REPEA	EDIT	DISK 4	
A-B		DISK 5	
PAGE 1		PAGE 2	

PHONO		PHONO	
A	F	A	F
B	G	B	G
C	H	C	H
D	I	D	I
E	J	E	J
PAGE 1		PAGE 2	

SYSTEM-OFF	OFF
POWER	ON/OFF
VOL UP	VOL UP
VOL DN	VOL DN
CH UP	SKIP+
CH DN	SKIP-
MUTE	MUTE
PRE-CH	PRE CH
UP	UP
DOWN	DN
LEFT	LEFT
RIGHT	RIGHT
SELECT	SELECT
PLAY	
STOP	
REW	
FF	
⏪, MENU	MENU
⏩, GUIDE	GUIDE
O, EXIT	EXIT
II, INFO	INFO
1	1
2	2
3	3
4	4
5	5
6	6
7	7
8	8
9	9
0	0
DISPLAY	DISPLAY
ENTER	ENTER

SYSTEM-OFF	OFF
POWER	ON/OFF
VOL UP	
VOL DN	
CH UP	TRACK+
CH DN	TRACK-
MUTE	
PRE-CH	RANDOM
UP	
DOWN	
LEFT	SKIP-
RIGHT	SKIP+
SELECT	
PLAY	PLAY
STOP	STOP
REW	REW
FF	FF
⏪, MENU	⏪
⏩, GUIDE	⏩
O, EXIT	EJECT
II, INFO	PAUSE
1	1
2	2
3	3
4	4
5	5
6	6
7	7
8	8
9	9
0	0
DISPLAY	DISPLAY
ENTER	DISC

SYSTEM-OFF	OFF
POWER	ON/OFF
VOL UP	VOL UP
VOL DN	VOL DN
CH UP	CH UP
CH DN	CH DN
MUTE	MUTE
PRE-CH	PRE CH
UP	UP
DOWN	DN
LEFT	LEFT
RIGHT	RIGHT
SELECT	SELECT
PLAY	PLAY
STOP	STOP
REW	REW
FF	FF
⏪, MENU	⏪
⏩, GUIDE	⏩
O, EXIT	RECORD
II, INFO	PAUSE
1	1
2	2
3	3
4	4
5	5
6	6
7	7
8	8
9	9
0	0
DISPLAY	DISPLAY
ENTER	ENTER

Index

Numerics

- 2 ST. & (2) 5.1 ANLG option, 3-61
- 2.0 ENCODING parameter, 2-34
- 2CH BYPASS listening mode, 6-34
- 2CH BYPASS STATUS menu, 2-32
- 2-CH MODE menu, 3-15
- 2-CH Parameter, D-2
- 2-CH parameter, 3-12
- 2CH STATUS menu, 2-30
- 2-CH SURROUND listening mode, 6-15
- 2-CHANNEL listening mode, 6-15
 - 5, 6-26
- 5 SPKR ENHANCE parameter, 6-4, 6-5, 6-16, 6-17, 6-26, 6-29, 6-30, 6-39
- 5 ST. & 5.1 ANLG option, 3-61
- 5.1 2-CHANNEL listening mode, 6-23
- 5.1 ANALOG STATUS menu, 2-33
- 5.1 L7 FILM listening mode, 6-16
- 5.1 L7 MUSIC listening mode, 6-17
- 5.1 L7 TV listening mode, 6-17
- 5.1 MAIN & ZONE2 2.0 parameter, 3-62
- 5.1 MONO listening mode, 6-24
- 5.1 MONO LOGIC listening mode, 6-23
- 5.1 MONO SURR listening mode, 6-24
- 5.1 PLIIx MOV listening mode, 6-20
- 5.1 PLIIx MUS listening mode, 6-21
- 5.1a 2-CHANNEL listening mode, 6-33
- 5.1a BYPASS listening mode, 6-33
- 5.1a BYPASS STATUS menu, 2-31
- 5.1a L7 FILM listening mode, 6-29
- 5.1a L7 MUSIC listening mode, 6-30
- 5.1a MODE menu, 3-16
- 5.1a parameter, 3-12
- 5.1a STANDARD listening mode, 6-32
- 5.1a THX listening mode, 6-30
- 5.1a THX MUSIC listening mode, 6-32
- 5.1a THX SurEX listening mode, 6-30

- 5.1a THX UL2Cin listening mode, 6-30
- 5.1-channel connectors, 2-7
- 8 STEREO INPUTS option, 3-60

A

- A/V SYNC DELAY parameter, 3-63, 3-67, D-4
- about the RV-8, 1-2
- AC input connector, 2-9
- ACADEMY FILTER parameter, 6-15, 6-23, 6-39
- adjusting the LCD contrast, C-16
- advanced speaker array, 3-35
- amplifier channel status, 2-13
- amplifier output connectors, 2-13
- amplifier outputs, 2-7
- amplifier overview, 2-13
- analog audio input connectors, 2-7
- ANALOG BYPASS parameter, 3-18
- ANALOG IN parameter, 3-7, 3-8, D-2
- anamorphic trigger signals, 3-18
- ANLG IN LVL parameter, 3-7, 3-9, 3-23
- ANLOG BYPASS parameter, 3-17
- arrow buttons, 2-15
- ASA parameter, 3-29, 3-35
- assigning input connectors, 3-7
- audio controls
 - BALANCE parameter, 4-6
 - BASS parameter, 4-2
 - CLEAR PRESET parameter, 5-3
 - FADER parameter, 4-6
 - LISTEN TO PRESET parameter, 5-3
 - LOUDNESS parameter, 4-4
 - NAME parameter, 5-3
 - TILT EQ parameter, 4-4
 - TREBLE parameter, 4-2
 - ZONE2 BALANCE parameter, 4-6
- AUDIO CONTROLS menu, 4-2, D-4
- audio output connectors, 2-8, 2-9

- AUTO, 6-4
- AUTO AZIMUTH parameter, 6-4, 6-39
- AUTO FREQUENCY parameter, 3-78
- AUTO GAIN parameter, 3-9, 3-10
- AUTO parameter, 3-9, 3-10
- AUTO SPEAKER SETUP screens, 3-48
- Autoload, 2-12
- AUTOLOAD parameter, 3-74
- Automatic Calibration, 3-36
- Automatic calibration using microphones, 3-37

B

- BACKGROUND parameter, 3-20, D-4
- BALANCE parameter, 4-2, D-4
- BASS CONTENT parameter, 6-13, 6-39
- BASS ENHANCE parameter, 6-4, 6-5, 6-16, 6-17, 6-26, 6-29, 6-30, 6-39
- BASS parameter, 4-2, D-4
 - frequency response graph, 4-3
- BASS PEAK LIMITERS, 3-53
- BASS PEAK LIMITERS menu, 3-58, D-3
- BASS RT parameter, 6-12, 6-39
- BASS XOVER parameter, 6-39
- battery installation, 1-6
- battery life, C-16
- BGC parameter, 3-29, 3-35
- BIT RATE parameter, 2-34
- boundary gain compensation, 3-35
- BRIGHTNESS parameter, D-4

C

- CAL NOISE parameter, 3-58, D-3
- Calibration
 - automatic, 3-36
 - manual, 3-53
- CALIBRATION parameter, 6-13, 6-39

CATHEDRAL listening mode, 6-12
 CENTER DEPTH parameter, 6-11, 6-12, 6-40
 CENTER MIX LVL parameter, 2-34
 CENTER MIX parameter, 6-23, 6-29, 6-33, 6-40
 Center output connector, 2-7
 CENTER parameter, 3-29, 3-31, 6-37, 6-40
 changing input names, 3-5
 CHANNELS parameter, 2-34
 checking microphones, 3-41
 CHURCH listening mode, 6-12
 CLEAR ALL parameter, 3-75
 CNTR DLY SAMPLES parameter, 6-23, 6-29, 6-33, 6-40
 COMPONENT IN parameter, 3-7, 3-11
 COMPONENT OSD parameter, 3-17, 3-20, 3-21, D-2
 component video input connectors, 2-7
 Composite video connectors, 2-8
 COMPRESSION parameter, 6-16, 6-17, 6-19, 6-20, 6-21, 6-22, 6-23, 6-40
 CONCERT HALL listening mode, 6-11
 CROSSOVER SETUP menu, 3-26
 CTR WIDTH parameter, 6-8, 6-40
 CUSTOM menu, 6-37, 6-40
 CUSTOM NAME parameter, 3-63, 3-67
 CUSTOM parameter, 6-4, 6-5, 6-6, 6-7, 6-8, 6-9, 6-10, 6-11, 6-12, 6-13, 6-15, 6-16, 6-17, 6-19, 6-20, 6-21, 6-22, 6-23, 6-24, 6-40
 CUSTOM SETUP Menu, 3-29
 CUSTOM SETUP menu, 3-26, D-3
 custom speaker setups, 3-26
 CUSTOM vs PRESET listening modes, 6-37, 6-40

D

Declaration of Conformity, A-4
 DIALOG OFFSET parameter, 2-34
 DIG OUT RATE parameter, 3-23, 3-24
 digital audio input connectors, 2-8
 digital audio output connectors, 2-9
 DIGITAL BYPASS parameter, 3-23, 3-24
 DIGITAL IN parameter, 3-7
 DIGITAL STATUS menu, 2-32
 DIMENSION parameter, 6-8, 6-40
 direct station access, 2-10

DISPLAY parameter, 3-76
 DISPLAY SETUP menu, 3-2, 3-63
 DISTANCES & LEVELS option, 3-36, 3-48
 DISTANCES option, 3-36, 3-48
 documentation conventions, 1-ii
 DOLBY DIGITAL EX listening mode, 6-22
 DOLBY DIGITAL listening mode, 6-22
 DOLBY DIGITAL MODE menu, 3-15
 Dolby DIGITAL parameter, 3-12
 DOLBY PL + THX listening mode, 6-9
 DOLBY PLII MOV listening mode, 6-7
 DOLBY PLII MOVIE listening mode, 6-7
 DOLBY PLII MUSIC listening mode, 6-8
 DOLBY PLIIX MOV listening mode, 6-20
 DOLBY PLIIX MUS listening mode, 6-8
 DOLBY PRO LOGIC listening mode, 6-9, 6-9
 DOLBY STATUS menu, 2-30
 DTS 2-CHAN listening mode, 6-29
 DTS L7 FILM listening mode, 6-26
 DTS listening mode, 6-28
 DTS Neo
 6 + THX listening mode, 6-10
 6 CIN listening mode, 6-10
 6 MUSIC listening mode, 6-10
 DTS STATUS menu, 2-31
 DTS THX MUSIC listening mode, 6-28
 DTS THX UL2 Cin listening mode, 6-27
 DTS-ES 2-CHAN listening mode, 6-29
 DTS-ES DECODING parameter, 6-25
 DTS-ES DISCR listening mode, 6-28
 DTS-ES L7 FILM listening mode, 6-26
 DTS-ES L7 MUSIC listening mode, 6-26
 DTS-ES listening mode, 6-28
 DTS-ES MODE menu, 3-16
 DTS-ES parameter, 3-12
 DTS-ES STATUS menu, 2-31
 DTS-ES THX listening mode, 6-27
 Dynamic listening modes, 3-13, 6-3

E

EARLY RFLX LVL parameter, 6-41
 EDIT CUSTOM NAME parameter, 3-63, 3-67, D-4

EDIT INPUT NAME menu, 3-5
 editing presets, 2-12
 EFFECT LVL parameter, 6-11, 6-12, 6-13, 6-15, 6-23, 6-41
 ES DECODING parameter, 6-25, 6-27, 6-28, 6-29, 6-40, 6-42, 6-44, 6-46
 ES ENCODING parameter, 2-34
 EX DECODING parameter, 6-20, 6-21, 6-22, 6-41
 EX ENCODING parameter, 2-34
 EXTERNAL NOISE TEST, 3-53, 3-57

F

factory-default settings, restoring, 7-4
 FADER parameter, 4-2, D-4
 FORMAT DETECT parameter, 3-21
 FORMAT parameter, D-4
 FREQUENCY option, 3-76
 Front L/R output connector, 2-7, 2-7
 FRONT L/R parameter, 3-29, 3-31
 FRONT PANEL DISPLAY menu, 3-66
 FRONT PANEL DISPLAY parameter, 3-63
 FRONT STEERING parameter, 6-4, 6-5, 6-17, 6-42
 front-panel
 BRIGHTNESS parameter, 3-66
 display, 2-3
 overview, 2-2, 2-4
 RV-8, 2-2
 STATUS parameter, 3-66

H

HEADPHONE 5.1 listening mode, 6-34
 HEADPHONE 5.1a listening mode, 6-35
 HEADPHONE DTS listening mode, 6-35
 HEADPHONE L7 listening mode, 6-34
 headphone output, 2-5
 headphone overview, 2-14
 HEADPHONE parameter, 3-69
 highlights, RV-8, 1-4
 high-pass filter, 3-28, 3-28
 horizontal bar graphs, 2-16

I

I/O CONFIG SETUP menu, 3-2
 INPUT BALANCE parameter, 6-13, 6-42
 input connectors, 2-7
 microphone, 2-8
 INPUT NAME menu, 3-5
 INPUT parameter, 2-35
 INPUT SELECT parameter, 3-17, 3-19, D-2
 input selection buttons, 2-4
 remote control, 2-18
 INPUT SETUP menu, 3-2, 3-4, D-2
 INPUT TYPE parameter, 2-35
 INPUTS
 Advanced, 3-17
 changing names, 3-5
 Main Zone, 2-28, 3-2
 installation considerations, 1-5
 INTERNAL NOISE TEST, 3-53, 3-56
 IR IN connector, 2-9
 IR receiver, 2-3

L

L7 FILM listening mode, 3-13, 6-4
 L7 MUSIC listening mode, 6-5
 L7 MUSIC SURR listening mode, 6-5
 L7 TV listening mode, 6-4
 LEDs, IR receiver, 2-3
 LEGACY VIDEO parameter, 3-21
 level meters, 3-10
 LEVELS CALIBRATION menu, 3-55
 LEVELS CALIBRATIONS menu, D-3
 LEVELS option, 3-36, 3-48
 LFE MIX parameter, 6-16, 6-17, 6-19, 6-20, 6-21, 6-22, 6-23, 6-26, 6-27, 6-28, 6-29, 6-29, 6-30, 6-31, 6-32, 6-33, 6-42
 LIMIT ADJ parameter, 3-59
 LIMITER parameter, 3-58, 3-59
 LISTENER POS parameter, 6-42
 listening mode
 activating, 6-2
 descriptions, 6-4
 parameter descriptions, 6-39

 preferred, 6-3
 selection buttons, 6-3
 listening modes, preferred, 3-12, 3-14
 LIVE! CALIBRATION
 menu, 3-3
 parameter, 3-80
 performing, 3-83
 LIVE! listening mode, 6-35
 LIVE! STATUS menu, 2-33
 LIVENESS parameter, 6-11, 6-42
 loading presets, 2-11
 LOCK OPTIONS, 3-79
 AUDIO CNTRL parameter, 3-79
 menu, 3-3
 MODES parameter, 3-79
 SETUP parameter, 3-79
 LOUDNESS parameter, 4-2
 frequency response graph, 4-5
 LOW FREQ WIDTH parameter, 6-13, 6-42
 low-pass filter, 3-28, 3-28

M

MAIN 5.1 & ZONE3 2.0 parameter, 3-62
 MAIN 7.1 parameter, 3-62
 MAIN ADVANCED option, 3-17
 MAIN menu, 2-15
 MAIN PWR ON parameter, 3-68
 Main Zone Off button, 2-5
 Main Zone selection buttons, 2-4
 maintenance, 7-4
 manual analog audio adjustments, 3-10
 manual calibration, 3-53
 MANUAL parameter, 3-9, 3-10
 manual speaker distance calibration, 3-54
 MANUAL SPEAKER SETUP menu, 3-53
 MASTER LEVEL parameter, 6-23, 6-29, 6-33, 6-43
 MAX VOLUME parameter, 3-69
 menu arrow buttons, 2-15
 menu item selection, 2-15
 menu navigation, 2-15
 menu options, 2-16
 Menu tree, B-2

MIC MODE menu, 3-16
 MIC parameter, 3-12
 MICROPHONE CHECK option, 3-36
 microphone input connectors, 2-8
 microphones
 automatic calibration, 3-42, 3-48
 checking, 3-40
 connecting, 3-37, 3-80
 improper positioning, 3-39, 3-46, 3-47, 3-82
 placement, 3-42
 proper positioning, 3-38, 3-43, 3-44, 3-45, 3-81
 MID RT parameter, 6-12, 6-43
 MIX ROOM parameter, 2-35
 MODE ADJUST menu, 6-2
 mode buttons, 2-4
 MODE parameter, 2-35
 MONO listening mode, 6-16
 MONO LOGIC listening mode, 6-15
 MONO SURROUND listening mode, 6-16
 Mute button, 2-5
 MUTE LEVEL parameter, 3-68

N

NAME parameter, 3-5
 naming presets, 2-11
 NIGHTCLUB listening mode, 6-11

O

Off buttons, 2-5, 2-5
 on-screen display
 BACKGROUND parameter, 3-65
 FORMAT parameter, 3-65
 POSITION parameter, 3-65
 STATUS parameter, 3-64
 ON-SCREEN DISPLAY menu, 3-64, D-4
 ON-SCREEN DISPLAY parameter, 3-63
 output connectors
 audio, 2-8, 2-9
 trigger, 2-8
 video, 2-7
 OUTPUT LEVELS menu, 6-37
 OUTPUT LEVELS parameter, 6-4, 6-5, 6-6, 6-7, 6-8, 6-9,

- 6-10, 6-11, 6-12, 6-13, 6-15, 6-16, 6-17, 6-19, 6-20, 6-21, 6-22, 6-23, 6-26, 6-27, 6-28, 6-29, 6-30, 6-31, 6-32, 6-33, 6-43
- Output levels, calibrating
 automatic, 3-36
 Bass Peak Limiters, 3-58
 manual, 3-55
- P**
- PANORAMA listening mode, 6-13
 PANORAMA parameter, 6-8, 6-43
 parameter drop-down menus, 2-16
 parameter relationships, 6-47
 parameters
 listening mode menu, 6-39
 STATUS menu, 2-34
 parameters, preferred listening mode selection, 3-12
 phono input connectors, 2-8
 POWER MANAGEMENT menu, 3-3
 power switch, 2-9
 PRE-DELAY parameter, 6-11, 6-12, 6-43
 preferred listening mode selection, 3-14
 Preferred listening modes, 3-12
 PRESET NAME option, 3-76
 product registration, 1-5
 program operation parameters, 3-71
 programming macro buttons, C-10
 cloning the remote control, C-15
 editing text on buttons, C-13
 erasing favorite channel, C-13
 erasing learned buttons, C-14
 erasing macro functions, C-12, C-13
 erasing punch through functions, C-13
 programming backlight, C-15
 punch through functions, C-12
 recalling preprogrammed numbers, C-14
 sample sequence, C-11
- R**
- RADIO TEXT parameter, 3-77
 RDS NAME option, 3-76
 REAR DLY OFFSET parameter, 6-4, 6-5, 6-13, 6-16, 6-17, 6-26, 6-29, 6-30, 6-43
 Rear L/R output connector, 2-7
 REAR L/R parameter, 3-29, 3-32, 6-37, 6-44
 rear-panel
 overview, 2-6
 RV-8, 2-6
 recalling zone audio codes, C-16
 RECORD parameter, 3-23, 3-24
 RE-EQUALIZER parameter, 6-4, 6-6, 6-9, 6-10, 6-16, 6-17, 6-19, 6-26, 6-27, 6-29, 6-30, 6-31, 6-43
 REGION parameter, 3-72
 remote control
 battery installation, 1-6
 buttons, 2-17
 command matrix, 2-18, 2-18
 operation considerations, 2-14
 remote control buttons, 2-17
 remote control overview, 2-14
 remote control programming, C-2
 auto scan with three-digit number, C-6
 device activation, C-2
 macro operations, C-3
 overview, C-4
 programming device buttons, C-8
 programming favorite channels, C-9
 programming function buttons, C-8
 using learning method, C-7
 using programmed codes, C-5
 REMOTE ONLY parameter, 3-70
 reprogramming zone audio codes, C-17
 RESET MODE parameter, 6-38, 6-44
 RESTORE DEFAULT NAME menu, 3-6
 restoring factory-default settings, 7-4
 REVERB LVL parameter, 6-40, 6-42, 6-44, 6-44, 6-46
 ROLLOFF parameter, 6-11, 6-12, 6-44
 routine maintenance, 7-4
 RS-232 connectors, 2-9
 RV-8
 about, 1-2
 highlights, 1-4
 product registration, 1-5
- S**
- safety instructions, 1-ii
 SAMPLE RATE parameter, 2-35
 saving presets, 2-11
 Scan Mode, 2-11
 SCAN SENS parameter, 3-73
 SCROLL RATE parameter, 3-77
 selecting a station, 2-10
 SET CROSSOVERS option, 3-25
 SET DISTANCES menu, 3-51
 SET LEVELS menu, 3-51
 SETTING DISTANCES menu, 3-49
 SETTING LEVELS menu, 3-49
 SETUP menu, 2-16, 3-2
 SHAPE parameter, 6-44
 SIDE L/R parameter, 3-29, 3-32, 6-37, 6-44
 SIZE parameter, 6-11, 6-12, 6-44
 SOUND STAGE parameter, 6-4, 6-5, 6-16, 6-17, 6-44
 SOURCE parameter, 6-46
 SPEAKER ANGLE parameter, 6-45
 SPEAKER DISTANCES, 3-53
 SPEAKER DISTANCES menu, 3-54
 SPEAKER SETUP menu, 3-2, 3-25
 speaker setup parameters, 3-29
 SPEECH DETECT parameter, 6-11, 6-12, 6-45
 SPREAD parameter, 6-45
 Standby button, 2-4
 STATUS menu
 level meters, 2-35
 parameters, 2-34
 STATUS menus, 2-29
 SUB & SUB LVL parameter, 6-45
 SUB L/R LVL parameter, 6-33
 SUB LEVEL parameter, 6-15, 6-16, 6-23, 6-24, 6-29
 SUB parameter, 6-37
 SUBWOOFER parameter, 3-29, 3-33
 SURR MIX LVL parameter, 2-35
 SURR ROLLOFF parameter, 6-4, 6-5, 6-13, 6-15, 6-16, 6-17, 6-23
 SURROUND DLY parameter, 6-8, 6-45
 SURROUND EX parameter, 6-19, 6-31, 6-45
 SURROUND MIX parameter, 6-23, 6-29, 6-33, 6-46
 S-VIDEO 16

9 parameter, 3-17, 3-18
S-VIDEO OSD 4
3 parameter, 3-17, 3-20
S-Video output connectors, 2-8

T

three-digit preprogrammed codes, C-18
THX listening mode, 6-18
THX MUSIC listening mode, 6-19
THX SETUP Menu, 3-29
THX SPEAKER SETUP screen, 3-28, 3-28
THX SurEX listening mode, 6-18
THX UL2Cin listening mode, 6-18
THX ULTRA2 SUB parameter, 3-29, 3-34
TILT EQ parameter, 4-2
frequency response graph, 4-5
TREB CUT RT parameter, 6-46
TREBLE parameter, 4-2
frequency response graph, 4-3
trigger output connectors, 2-8
TRIGGER SETUP, 3-70
TRIGGER SETUP menu, 3-2
troubleshooting, 7-2
Troubleshooting automatic calibration, 3-52
Tune/Seek access, 2-10
TUNE/SEEK Buttons, 2-5, 2-5
tuner antenna connectors, 2-8
tuner overview, 2-10
TUNER PRESETS menu, 5-2
TUNER PRESETS parameter, 3-75
Tuner Regions, 3-73
TUNER SETUP menu, 3-3
TUNER SETUP option, 3-72
Tuner status, 2-29
Two-line Status, 2-28, 2-29

U

Ultra2-certified, 3-34
understanding the zones, 2-28
USE LAST parameter, 3-14

V

VIDEO IN parameter, 3-11
video input connectors, 2-7
video output connectors, 2-7
VOCAL ENHANCE parameter, 6-4, 6-5, 6-16, 6-17, 6-26,
6-29, 6-30, 6-46
VOLUME CONTROL SETUP menu, 3-2, 3-68
volume knob, 2-3

W

WORD LENGTH parameter, 2-35

Z

Z2 PWR ON parameter, 3-68
Z3 PWR ON parameter, 3-69
Zone 2 Off button, 2-5
Zone 2 selection buttons, 2-4
Zone 3 Off button, 2-5
Zone 3 selection buttons, 2-4
ZONE2 ADVANCED inputs, 3-23
ZONE2 BALANCE parameter, 4-2, 4-2
ZONE2 IN parameter, 3-21
ZONE2 IN parameter settings, 3-22
Zones, understanding, 2-28

LIMITED WARRANTY

Harman Specialty Group offers the following warranty on this product:

What is the Duration of this Warranty?

This warranty will remain in effect for three (3) years from the original date of purchase.

Who is Covered?

This warranty may be enforced by the original purchaser and subsequent owners during the warranty period, provided the original dated sales receipt or other proof of warranty coverage is presented at time of service.

What is Covered?

This warranty covers all defects in material and workmanship on this product, except as specified below. The following are not covered:

1. Damage resulting from
 - A. Accident, misuse, abuse, or neglect.
 - B. Failure to follow instructions contained in the user guide.
 - C. Repair or attempted repair unauthorized by Harman Specialty Group.
 - D. Failure to perform recommended periodic maintenance.
2. Causes other than product defects, including lack of skill, competence, or experience on the part of the owner.
3. Damage occurring during any shipment of this product. Claims for shipping damages must be made with the carrier.
4. Damage to a unit that has been altered, or on which the serial number has been defaced, modified, or removed.

What Expenses will Harman Specialty Group Assume?

Harman Specialty Group will pay all labor and material expenses for covered items. Payment of shipping charges is discussed in the next section of the warranty.

How is Service Obtained?

When this product needs service, write, telephone, or fax Harman Specialty Group to request information about where the unit should be taken or sent. When making a written request, please include your name, complete address, and daytime telephone number; the product model and serial numbers; and a description of the problem. Do not return the unit to Harman Specialty Group without prior authorization.

When Shipping a Product for Service . . .

1. Pay any initial shipping charges, which are the responsibility of the owner. If necessary repairs are covered by this warranty, Harman Specialty Group will pay return shipping charges to any destination in the United States using the carrier of our choice.
2. Pack the unit securely. Package insurance is strongly recommended.
3. Include a copy of the original dated sales receipt. (A copy of the original dated sales receipt must be presented whenever warranty service is required.)
4. Do not include accessories such as power cords or user guides unless instructed to do so.

What are the Limitations of Implied Warranties?

Any implied warranties, including warranties of merchantability and fitness for a particular purpose, are limited in duration to the length of this warranty.

What Certain Damages are Excluded?

Harman Specialty Group's liability for a defective product is limited to repair or replacement of that product, at our option. Harman Specialty Group shall not be liable for damages based on inconvenience; loss of use of the product; loss of time; interrupted operation; commercial loss; or any other damages, whether incidental, consequential, or otherwise.

How do State Laws Relate to this Warranty?

Some states do not allow limitations on the duration of implied warranties and/or the exclusion or limitation of incidental or consequential damages. As such, the above limitations may not apply.

This warranty is not enforceable outside of North America. This warranty provides specific legal rights. Additional rights may be provided by some states.



PRODUCT REGISTRATION
Please register this product within 15 days of purchase. To do so, complete and return this card or register online at www.lexicon.com. Retain the sales receipt for proof of coverage.

Mr. Mrs. Ms. Miss
 Single Married Divorced Widowed

First Name _____ Last Name _____

Company _____ Title _____

Mailing Address _____

City _____ State _____ Zip _____

Telephone Number _____ Fax Number _____

Email Address _____

Product Model _____ Purchase Date _____

Version _____ Serial Number _____

Where did you purchase this product?

Age	Education	Household Income
<input type="radio"/> Under 18	<input type="radio"/> High School	<input type="radio"/> Under \$20,000
<input type="radio"/> 18-24	<input type="radio"/> College	<input type="radio"/> \$20,000 to \$34,999
<input type="radio"/> 25-34	<input type="radio"/> Graduate School	<input type="radio"/> \$35,000 to \$49,000
<input type="radio"/> 35-49	<input type="radio"/> Certificate:	<input type="radio"/> \$50,000 to \$74,999
<input type="radio"/> 50-64		<input type="radio"/> \$75,000 to \$99,000
<input type="radio"/> 65+		<input type="radio"/> \$100,000+

How did you learn about this product? Choose one:

Friend Store salesperson Advertisement
 Colleague Store display Magazine Article
 Teacher Received as a gift Own other Lexicon products

Which of the following were most important in the selection of this product?

Sound Quality Value for price Durability
 Features Brandname Other:

What are your three favorite magazines?

1. _____ 2. _____ 3. _____

What are your three favorite websites?

1. _____ 2. _____ 3. _____

What features would you like to see added to this product in the future?

RV-8 01/06



Harman Specialty Group
3 Oak Park
Bedford, MA 01730-1413
USA

Tel 781-280-0300
Fax 781-280-0490
www.lexicon.com

Customer Service
Tel 781-280-0300
Fax 781-280-0495 (Sales)
Fax 781-280-0499 (Service)



BUSINESS REPLY MAIL
FIRST-CLASS MAIL PERMIT NO. 67 BEDFORD MA

POSTAGE WILL BE PAID BY ADDRESSEE

PRODUCT REGISTRATION
HARMAN SPECIALTY GROUP
3 OAK PARK
BEDFORD MA 01730-9863

NO POSTAGE
NECESSARY
IF MAILED
IN THE
UNITED STATES

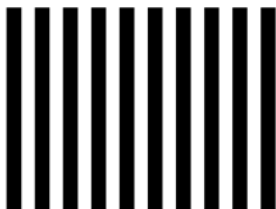

Lexicon[®]

H A Harman International Company

3 Oak Park Drive
Bedford, MA 01730-1413 USA
Tel 781-280-0300
Fax 781-280-0490
www.harmanspecialtygroup.com

Customer Service
Telephone: 781-280-0300
Sales Fax: 781-280-0495
Service Fax: 781-280-0499

Product Shipments
16 Progress Road
Billerica, MA 01821-5730 USA

Part No. 070-15838 | Rev 1 | 01/06

Free Manuals Download Website

<http://myh66.com>

<http://usermanuals.us>

<http://www.somanuals.com>

<http://www.4manuals.cc>

<http://www.manual-lib.com>

<http://www.404manual.com>

<http://www.luxmanual.com>

<http://aubethermostatmanual.com>

Golf course search by state

<http://golfingnear.com>

Email search by domain

<http://emailbydomain.com>

Auto manuals search

<http://auto.somanuals.com>

TV manuals search

<http://tv.somanuals.com>