

# MPX G2

Guitar Effects Processor

User Guide

**lexicon**

## Unpacking and Inspection

After unpacking the unit, save all packing materials in case you ever need to ship the unit. Thoroughly inspect the unit and packing materials for signs of damage. Report any shipment damage to the carrier at once; report equipment malfunction to your dealer.

## Precautions

Save these instructions for later use.

Follow all instructions and warnings marked on the unit.

Always use with the correct line voltage. Refer to the manufacturer's operating instructions for power requirements. Be advised that different operating voltages may require the use of a different line cord and/or attachment plug.

Do not install the unit in an unventilated rack, or directly above heat producing equipment such as power amplifiers. Observe the maximum ambient operating temperature listed in the product specification.

Slots and openings on the case are provided for ventilation; to ensure reliable operation and prevent it from overheating, these openings must not be blocked or covered. Never push objects of any kind through any of the ventilation slots. Never spill a liquid of any kind on the unit.

This product is equipped with a 3-wire grounding type plug. This is a safety feature and should not be defeated.

Never attach audio power amplifier outputs directly to any of the unit's connectors.

To prevent shock or fire hazard, do not expose the unit to rain or moisture, or operate it where it will be exposed to water.

Do not attempt to operate the unit if it has been dropped, damaged, exposed to liquids, or if it exhibits a distinct change in performance indicating the need for service.

This unit should only be opened by qualified service personnel. Removing covers will expose you to hazardous voltages.

This triangle, which appears on your component, alerts you to the presence of uninsulated, dangerous voltage inside the enclosure... voltage that may be sufficient to constitute a risk of shock.



This triangle, which appears on your component, alerts you to important operating and maintenance instructions in this accompanying literature.

## Notice

This equipment generates and uses radio frequency energy and if not installed and used properly, that is, in strict accordance with the manufacturer's instructions, may cause interference to radio and television reception. It has been type tested and found to comply with the limits for a Class B computing device in accordance with the specifications in Subpart J of Part 15 of FCC Rules, which are designated to provide reasonable protection against such interference in a residential installation. However, there is no guarantee that interference will not occur in a particular installation. If this equipment does cause interference to radio or television reception, which can be determined by turning the equipment OFF and ON, the user is encouraged to try to correct the interference by one or more of the following measures:

- Reorient the receiving antenna
- Relocate the computer with respect to the receiver
- Move the computer away from the receiver
- Plug the computer into a different outlet so that the computer and receiver are on different branch circuits.

If necessary, the user should consult the dealer or an experienced radio/television technician for additional suggestions. The user may find the following booklet prepared by the Federal Communications Commission helpful:

"How to identify and Resolve Radio/TV Interference Problems."

This booklet is available from the U.S. Government Printing Office, Washington, DC 20402, Stock No. 004-000-00345-4.

Le présent appareil numérique n'émet pas de bruits radioélectriques dépassant les limites applicables aux appareils numériques de la class B prescrites dans le Règlement sur le brouillage radioélectrique édicté par le ministère des Communications du Canada.

Boss CS-3, Cordovox, Crybaby, DynaComp, Leslie, Maestro, Mu-tron, Octavia, Phase 90, Space Echo, Tube Screamer, Univibe, Vibro Tone and Vox are trademarked by their respective manufacturers.  
JamMan is a trademark of Lexicon, Inc

Copyright ©1998 Lexicon Inc.  
All Rights Reserved.

Lexicon Inc. • 3 Oak Park • Bedford MA 01730-1441 USA • Telephone 781-280-0300 • Fax 781-280-0490

Lexicon Part # 070-11542



Dansk

### Vigtig information om sikkerhed

Gem denne vejledning til senere brug.

Følg alle anvisninger og advarsler på apparatet.

Apparatet skal altid tilsluttes den korrekte spænding. Der henvises til brugsanvisningen, der indeholder specifikationer for strømforsyning. Der gøres opmærksom på, at ved varierende driftsspændinger kan det blive nødvendigt at bruge andre lednings- og/eller stiktyper.

Apparatet må ikke monteres i et kabinet uden ventilation eller lige over andet udstyr, der udvikler varme, f.eks. forstærkere. Den maksimale omgivelsestemperatur ved drift, der står opført i specifikationerne, skal overholdes.

Der er ventilationsåbninger i kabinettet. For at sikre apparatets drift og hindre overophedning må disse åbninger ikke blokeres eller tildækkes. Stik aldrig noget ind igennem ventilationsåbningerne, og pas på aldrig at spilde nogen form for væske på apparatet.

Dette apparat er forsynet med et stik med jordforbindelse. Denne sikkerhedsforanstaltning må aldrig omgås.

Udgangsstik fra audioforstærkere må aldrig sættes direkte i apparatet.

Apparatet må ikke udsættes for regn eller fugt og må ikke bruges i nærheden af vand for at undgå risiko for elektrisk stød og brand.

Apparatet må aldrig bruges, hvis det er blevet stødt, beskadiget eller vådt, eller hvis ændringer i ydelsen tyder på, at det trænger til eftersyn.

Dette apparat må kun åbnes af fagfolk. Hvis dækslet tages af, udsættes man for livsfarlig højspænding.



Denne mærkat på komponenten advarer om uisoleret, farlig spænding i apparatet ... høj nok til at give elektrisk stød.



Denne mærkat på komponenten advarer om vigtig drifts- og vedligeholdelsesinformation i den tilhørende litteratur.

Suomi

### Tärkeitä turvallisuusohjeita

Säilytä nämä ohjeet tulevaa käyttöä varten.

Seuraa kaikkia yksikköön merkittyjä ohjeita ja varoituksia.

Käytä aina oikeaa verkkojännitettä. Tehovaatimukset selviävät valmistajan käyttöohjeista. Huomaa, että eri käyttöjännitteet saattavat vaatia toisenlaisen verkkojohdon ja/tai -pistokkeen käytön.

Älä asenna yksikköä telineeseen jossa ei ole tuuletusta, tai välittömästi lämpöä tuottavien laitteiden, esim. tehovahvistimien, yläpuolelle. Ympäristön lämpötila käytössä ei saa ylittää tuotespesifikaation maksimilämpötilaa.

Kotelo on varustettu tuuletusreiillä ja -aukoilla. Luotettavan toiminnan varmistamiseksi ja ylläpennemisen välttämiseksi näitä aukkoja ei saa sulkea tai peittää. Mitään esineitä ei saa työntää tuuletusaukoihin. Mitään nesteitä ei saa kaataa yksikköön.

Tuote on varustettu 3-johtimisella maadoitetulla verkkopistokkeella. Tämä on turvallisuustoiminne eikä sitä saa poistaa.

Älä kytkä audiotehovahvistimen lähtöjä suoraan mihinkään yksikön liittimeen.

Sähköiskun ja palovaaran välttämiseksi yksikkö ei saa olla sateessa tai kosteassa, eikä sitä saa käyttää märässä ympäristössä.

Älä käytä yksikköä jos se on pudonnut, vaurioitunut, kostunut, tai jos sen suorituskyky on huomattavasti muuttunut, mikä vaatii huoltoa.

Yksikön saa avata vain laitteeseen perehtynyt huoltohenkilö. Kansien poisto altistaa sinut vaarallisille jännitteille.



Tämä kolmio, joka esiintyy komponentissasi, varoittaa sinua eristämättömän vaarallisen jännitteen esiintymisestä yksikön sisällä. Tämä jännite saattaa olla riittävän korkea aiheuttamaan sähköiskuvaaran.



Tämä kolmio, joka esiintyy komponentissasi, kertoo sinulle, että tässä tuotedokumentoinnissa esiintyy tärkeitä käyttö- ja ylläpito-ohjeita.

Norsk

### Viktig informasjon om sikkerhet

Ta vare på denne veiledningen for senere bruk.

Følg alle anvisningene og advarslene som er angitt på apparatet.

Apparatet skal alltid anvendes med korrekt spenning. Produktbeskrivelsen inneholder spesifikasjoner for strømkrav. Vær oppmerksom på at det ved ulike driftsspenninger kan være nødvendig å bruke en annen ledning- og/eller støpseltype.

Apparatet skal ikke monteres i skap uten ventilasjon, eller direkte over varmeproduerende utstyr, som for eksempel kraftforstærkere. Den maksimale romtemperaturen som står oppgitt i produktbeskrivelsen, skal overholdes.

Apparatet er utstyrt med ventilasjonsåpninger. For at apparatet skal være pålitelig i bruk og ikke overopphetes, må disse åpningene ikke blokeres eller tildekkes. Stikk aldri noe inn i ventilasjonsåpningene, og pass på at det aldri søles noen form for væske på apparatet.

Dette apparatet er utstyrt med et jordet støpsel. Dette er en sikkerhetsforanstaltning som ikke må forandres.

Utgangsplugg fra audioforstærkere skal aldri koples direkte til apparatet.

Unngå brannfare og elektrisk stød ved å sørge for at apparatet ikke utsettes for regn eller fuktighet og ikke anvendes i nærheten av vann.

Apparatet skal ikke brukes hvis det har blitt utsatt for støt, er skadet eller blitt vått, eller hvis endringer i ytelsen tyder på at det trenger service.

Dette apparatet skal kun åpnes av fagfolk. Hvis dekslet fjernes, utsettes man for livsfarlig høyspenning.



Komponenten er merket med denne trekanten, som er en advarsel om at det finnes uisolert, farlig spenning inne i kabinettet ... høy nok til å utgjøre en fare for elektrisk stød.



Komponenten er merket med denne trekanten, som betyr at den tilhørende litteraturen inneholder viktige opplysninger om drift og vedlikehold.

Svenska

### Viktiga säkerhetsföreskrifter

Spara dessa föreskrifter för framtida bruk.

Följ alla anvisningar och varningar som anges på enheten.

Använd alltid rätt nätspänning. Se tillverkarens bruksanvisningar för information om effektkrav. Märkväl, att andra matningsspänningar eventuellt kräver att en annan typs nätsladd och/eller kontakt används.

Installera inte enheten i ett oventilerat stativ, eller direkt ovanför utrustningar som avger värme, t ex effektförstärkare. Se till att omgivningens temperatur vid drift inte överskrider det angivna värdet i produktspecifikationen.

Behållaren är försedd med hål och öppningar för ventilering. För att garantera tillförlitlig funktion och förhindra överhettning får dessa öppningar inte blockeras eller täckas. Inga föremål får skuffas in genom ventilationshålen. Inga vätskor får spillas på enheten.

Produkten är försedd med en jordad 3-trådskontakt. Detta är en säkerhetsfunktion som inte får tas ur bruk.

Anslut aldrig audioeffektförstärkarutgångar direkt till någon av enhetens kontakter.

För att undvika elstöt eller brandfara får enheten inte utsättas för regn eller fukt, eller användas på ställen där den blir våt.

Använd inte enheten om den har fallit i golvet, skadats, blivit våt, eller om dess prestanda förändrats märkbart, vilket kräver service.

Enheten får öppnas endast av behörig servicepersonal. Farliga spänningar blir tillgängliga när locken tas bort.



Denna triangel, som visas på din komponent, varnar dig om en isolerad farlig spänning inne i enheten. Denna spänning är eventuellt så hög att fara för elstöt föreligger.



Denna triangel, som visas på din komponent, anger att viktiga bruksanvisningar och serviceanvisningar ingår i dokumentationen i fråga.

Deutsch  
**Wichtige Sicherheitsanweisungen**

Heben Sie sich diese Sicherheitsanweisungen auch für später auf. Befolgen Sie alle auf der Vorrichtung stehenden Anweisungen und Warnungen. Immer nur mit der richtigen Spannung verwenden! Die Gebrauchsanweisungen des Herstellers informieren Sie über die elektrischen Anforderungen. Vergessen Sie nicht daß bei verschiedenen Betriebsspannungen ggf. auch verschiedene Leitungskabel und/oder Verbindungsstecker zu verwenden sind.

Stellen Sie die Vorrichtung nicht in ein unbelüftetes Gestell oder unmittelbar über wärmeerzeugende Geräte wie z.B. Tonverstärker. Halten Sie die in den Produktspezifikationen angegebene maximale Umgebungstemperatur bei Betrieb ein.

Schlitze und Öffnungen im Gehäuse dienen der Belüftung; um verlässlichen Betrieb sicherzustellen und Überheizen zu vermeiden dürfen diese Öffnungen nicht verstopft oder abgedeckt werden. Stecken Sie nie irgend einen Gegenstand durch die Belüftungsschlitze. Vergießen Sie keine Flüssigkeiten auf den Apparat.

Dieses Produkt ist mit einem 3-drahtigen Erdungsstecker ausgerüstet. Diese Sicherheitsmaßnahme darf nicht unwirksam gemacht werden.

Schließen Sie nie Tonverstärker unmittelbar an einen Anschluß des Apparates an.

Um elektrischen Schlag oder Feuer zu vermeiden, setzen Sie den Apparat weder Regen noch Feuchtigkeit aus und betreiben Sie ihn nicht dort wo Wasser eindringen könnte.

Versuchen Sie nicht den Apparat zu betreiben falls er fallen gelassen, beschädigt, oder Flüssigkeiten ausgesetzt wurde, oder falls sich seine Arbeitsweise derart ändert daß daraus ein Bedarf nach Reparatur zu schließen ist.

Dieser Apparat sollte nur von qualifizierten Fachleuten geöffnet werden. Das Abnehmen von Abdeckungen setzt Sie gefährlichen Spannungen aus.



Dieses Dreieck auf Ihrem Apparat warnt Sie vor nicht-isolierter, gefährlicher Spannung im Gehäuse ... stark genug um eine Berührungsfahrgefahr darzustellen.



Dieses Dreieck auf Ihrem Apparat bedeutet daß wichtige Betriebs- und Wartungsanweisungen in der mitgelieferten Dokumentation zu finden sind.

Español

**Instrucciones importantes de seguridad**

Guarde estas instrucciones para uso posterior.

Utilice siempre el voltaje correcto. Dirijase a las instrucciones de operación del fabricante para obtener las especificaciones de potencia. Esté al tanto de que voltajes de operación distintos requieren el uso de cables y/o enchufes distintos.

No instale esta unidad en un estante sin ventilación, ni tampoco directamente encima de equipos que generen calor tales como amplificadores de potencia. Fíjese en las temperaturas ambientales máximas de operación que se mencionan en las especificaciones del producto.

Las aperturas y ranuras del chasis sirven para proveer la ventilación necesaria para operar la unidad con seguridad y para prevenir sobrecalentamiento, y por lo tanto no pueden ser obstruidas o cubiertas. No introduzca objetos de ningún tipo a través de las ranuras de ventilación, y nunca deje caer ningún líquido sobre la unidad.

Este producto está equipado con un enchufe de 3 clavijas con conexión a tierra. Éste es un elemento de seguridad que no debe ser eliminado.

Nunca conecte ningún tipo de salida de amplificadores de sonido directamente a los conectores de la unidad.

Para prevenir descargas eléctricas o incendios, mantenga la unidad alejada de la lluvia, humedad o cualquier lugar en el que pueda entrar en contacto con agua.

No trate de hacer funcionar la unidad si se ha caído, está dañada, ha entrado en contacto con líquidos, o si nota cualquier cambio brusco en su funcionamiento que indique la necesidad de hacerle un servicio de mantenimiento.

Esta unidad deberá ser abierta únicamente por personal calificado. Si usted quita las coberturas se expondrá a voltajes peligrosos.



Este triángulo que aparece en su componente le advierte sobre la existencia dentro del chasis de voltajes peligrosos sin aislantes ... voltajes que son lo suficientemente grandes como para causar electrocución.



Este triángulo que aparece en su componente lo alerta sobre las instrucciones de operación y mantenimiento importantes que están en los materiales de lectura que se incluyen.

Français  
**Instructions de Sûreté Importantes**

Gardez ces instructions pour référence future.

Observez toutes les instructions et tous les avertissements marqués sur l'appareil.

Branchez uniquement sur un réseau de tension indiquée. Consultez le manuel d'instruction du fabricant pour les spécifications de courant. N'oubliez pas que différentes tensions peuvent nécessiter l'utilisation de câbles et/ou de fiches de connexion différents.

N'installez pas l'appareil en un compartiment non-aéré ou directement au-dessus d'équipements générateurs de chaleur, tels qu'amplificateurs de courants, etc. Ne dépassez pas la température ambiante maximale de fonctionnement indiquée dans les spécifications du produit.

Des fentes et ouvertures sont prévues dans le boîtier pour l'aération; Pour assurer le bon fonctionnement et pour prévenir l'échauffement, ces ouvertures ne doivent pas être couvertes ou bloquées. N'insérez pas d'objets dans les fentes d'aération. Empêchez tout liquide de se répandre sur l'appareil.

Ce produit est muni d'une fiche à trois fils pour la mise à terre. Ceci est une mesure de sécurité et ne doit pas être contrariée.

Ne connectez jamais d'amplificateurs audio directement aux connecteurs de l'appareil.

Pour empêcher les chocs électriques et le danger d'incendie, évitez d'exposer l'appareil à la pluie ou à l'humidité, et ne le mettez pas en marche en un endroit où il serait exposé aux éclaboussures d'eau.

N'essayez pas de faire fonctionner l'appareil s'il est tombé à terre, a été endommagé, exposé à un liquide, ou si vous observez des différences nettes dans son fonctionnement, indiquant la nécessité de réparations.

Cet appareil ne doit être ouvert que par un personnel de service qualifié. En enlevant les couvercles vous vous exposez à des tensions électriques dangereuses.



Ce triangle, sur votre appareil vous avertit de la présence de tension dangereuse, non-isolée à l'intérieur du boîtier...une tension suffisante pour représenter un danger d'électrocution.



Ce triangle sur sur votre appareil vous invite de suivre d'importantes instructions d'utilisation et d'entretien dans la documentation livrée avec le produit.

Italiano

**Importanti norme di sicurezza**

Conservare le presenti norme per l'utilizzo futuro.

Osservare tutte le istruzioni e le avvertenze apposte sull'unità.

Utilizzare esclusivamente con la tensione di rete corretta. Consultare le istruzioni operative fornite dal fabbricante per i dati riguardanti la tensione e l'assorbimento di corrente. Potrebbe essere necessario l'uso di cavi di rete e/o di spine diverse a seconda della tensione utilizzata.

Non installare l'unità in uno scaffale privo di ventilazione oppure direttamente sopra una fonte di calore, come, ad esempio, un amplificatore. Non superare la temperatura ambientale massima di funzionamento riportata nei dati tecnici del prodotto.

Le fessure e le altre aperture nella scatola servono alla ventilazione. Per un funzionamento affidabile, e per evitare un eventuale surriscaldamento, queste aperture non vanno ostruite o coperte in nessun modo. Evitare in tutti i casi di inserire oggetti di qualsiasi genere attraverso le fessure di ventilazione. Non versare mai del liquido di nessun tipo sull'unità.

Questo prodotto viene fornito con una spina a 3 fili con massa. Tale dispositivo di sicurezza non va eliminato.

Evitare sempre di collegare le uscite dell'amplificatore audio direttamente ai connettori dell'unità.

Per prevenire il pericolo di folgorazione e di incendio non esporre l'unità alla pioggia o ad un'umidità eccessiva; evitare di adoperare l'unità dove potrebbe entrare in contatto con acqua.

Evitare di adoperare l'unità se la stessa è stata urtata violentemente, se ha subito un danno, se è stata esposta ad un liquido o in caso di un evidente cambiamento delle prestazioni che indichi la necessità di un intervento di assistenza tecnica.

Ogni intervento sull'unità va eseguito esclusivamente da personale qualificato. La rimozione della copertura comporta l'esposizione al pericolo di folgorazione.



Il presente triangolo impresso sul componente avverte della presenza di tensioni pericolose non isolate all'interno della copertura... tali tensioni rappresentano un pericolo di folgorazione



Il presente triangolo impresso sul componente avverte l'utente della presenza nella documentazione allegata di importanti istruzioni relative al funzionamento ed alla manutenzione.

# Contents

---

## Introduction

### 1. Product Overview

The Front Panel .....	1-1
The Rear Panel .....	1-2
Installation Notes .....	1-3
Mounting .....	1-3
Power Requirements .....	1-3
Quick Start .....	1-3
Stand alone .....	1-4
Amp Input Only .....	1-5
Amp Input & FX Loop .....	1-6
Connecting Other Equipment .....	1-8
Signal Flow .....	1-10
Digital Audio Paths .....	1-11
Internal Grounding .....	1-11
Unbalanced Connections .....	1-11
Guitar Input .....	1-11
Main Outputs .....	1-11
Insert Send .....	1-12
Insert Returns .....	1-12
Automatic Insert Return Signal Routing .....	1-12
Right (Mono) Only .....	1-12
Stereo .....	1-12
Left Only .....	1-12
Connecting the main Outputs to Mono Input .....	1-13
Setting Audio Levels .....	1-13
Using Soft Sat .....	1-13
Input Level and Clip Indicators .....	1-13
Aux In and Clip Indicators .....	1-13

Look here for connector information and Quick Start configurations

### 2. Basic Operation

MPX G2 Menus .....	2-1
Loading and Playing with Programs .....	2-2
Program Load .....	2-2
Effect Bypass .....	2-3
Insert Bypass .....	2-3
Dedicated Analog Controllers .....	2-3
Programmable Bypass Modes .....	2-4
Tuner .....	2-4
Tap .....	2-4
A/B .....	2-5
Soft Row Editing .....	2-5
Using the DataBase .....	2-6
Program Store .....	2-7

Easy operation of the MPX G2 — loading, playing with, and storing programs.

**Contents, cont'd. 3. Editing**

Check here for information  
on editing Effects and  
programs. 

- Effect Editing ..... 3-1
- The MPX G2 Edit Menus ..... 3-3
  - Mix ..... 3-4
    - Adjusting Pre-Gain and Post-Gain Level ..... 3-4
  - Speaker Sim ..... 3-5
    - Automatic Speaker Sim Routing ..... 3-6
  - Noise Gate ..... 3-7
  - Meters ..... 3-8
  - Effect Order ..... 3-9
  - Routing Map ..... 3-10
    - How to Change Routing Connections ..... 3-12
    - How to Change Routing Options ..... 3-12
    - Routing Examples ..... 3-13
    - Notes and Tips on Routing ..... 3-16
  - Patching (See Chapter 4) ..... 3-16
  - Controllers (Knob, LFO 1 and 2, Random, A/B and Env ) ..... 3-17
  - Tempo ..... 3-18
    - Rate ..... 3-18
    - Source ..... 3-18
    - Beat Value ..... 3-19
    - Tap Source ..... 3-19
  - Compare ..... 3-19
  - Soft Row Parameter Assignment ..... 3-20
  - DataBase Assignmments ..... 3-20
  - Copy Effect ..... 3-22

**4. Patching**

All about the MPX G2  
Patch System 

- Selecting a Source and Destination ..... 4-2
- Changing the Range of the Source Controller ..... 4-3
  - Viewing Source Controller Activity ..... 4-3
  - MIDI Learn — Automatic Controller Assignment ..... 4-4
- Copying Patches ..... 4-4
- Changing the Range of the Destination Parameter ..... 4-5
  - Linear or Nonlinear Control ..... 4-6
- Suspending and Clearing Patches ..... 4-7
- Multiple Patches with the Same Destination ..... 4-7

**5. System Controls**

Complete details on all  
of the MPX G2 System  
parameters 

- The System Menus ..... 5-1
- Audio Controls ..... 5-1
  - Soft Sat ..... 5-1
  - Output Mode ..... 5-1
- Modes ..... 5-2
  - Pgm Load ..... 5-2
  - Mix ..... 5-2
  - Send Bypass ..... 5-2
  - Pgm Bypass ..... 5-2
  - Tempo Mode ..... 5-3
  - Memory Protect ..... 5-3
  - Brightness ..... 5-3
  - Sleep ..... 5-3
  - Post Bypass ..... 5-4

**Contents, cont'd.**

- Insert ..... 5-4
  - FX Loop ..... 5-4
  - Mix ..... 5-4
  - Parallel ..... 5-4
- Setup Load and Setup Store ..... 5-5
- MIDI ..... 5-7
  - Program Change/Options: Pgm# Offset, Pgm+ and Pgm- ..... 5-7
  - Receive ..... 5-7
  - Transmit ..... 5-7
  - Ctl Send/Options: MIDI Reset ..... 5-8
  - Ctl Smooth ..... 5-8
  - Clock Send ..... 5-8
  - Automation/Options: Xmit Device ID ..... 5-9
  - SysEx/Options: Receive Device ID ..... 5-8
  - Soft Thru ..... 5-9
  - Dump/Options: Xmit Speed ..... 5-9
- MIDI Maps ..... 5-10
- Program Chains ..... 5-11
- Initialize ..... 5-12
- Clear Programs ..... 5-13
- Copy Programs ..... 5-14
- Global Patches/Options: MIDI Learn and Dst Edit ..... 5-15
- Calibrate Pedal ..... 5-16
- Bypass Patches ..... 5-16
- Tuner Mode ..... 5-17
- Global Effects ..... 5-17
  - Speaker Sim Mode ..... 5-18
  - Noise Gate Mode ..... 5-18
  - Reverb Mode ..... 5-18
  - Bypass Mode ..... 5-18

**6. MIDI Operation**

- Selecting a MIDI Channel ..... 6-1
- Accessing Programs ..... 6-1
- Controlling MPX G2 Tempo Rate with MIDI Clock ..... 6-2
  - MIDI Tempo Control ..... 6-2
  - Using the MPX G2 as a MIDI Clock Source ..... 6-2
  - Slaving two or more MPX G2s ..... 6-3
- Controller Quirks ..... 6-4
- The Knob, Footpedal and Footswitch as MIDI Controllers ..... 6-4
- Program Change Messages ..... 6-5
- Automation ..... 6-6
  - SysEx Automation ..... 6-6
  - Controller Automation ..... 6-6
  - Reset All Controllers ..... 6-6
  - MIDI Clock and Clock Commands ..... 6-6
  - Dynamic MIDI ..... 6-7
- Bulk Data Dumps ..... 6-7
- MIDI Implementation Chart ..... 6-8

 **Information on working with MIDI**



## Contents, cont'd. 7. The Effects and Parameters

Complete details on all  
of the MPX G2 Effects 

Notes on Combining Effects .....	7-2
Notes on Controlling Effect Parameters .....	7-2
Notes on the Effect Descriptions .....	7-2
Gain Effects .....	7-3
Tone .....	7-3
Crunch .....	7-3
Screamer .....	7-4
Overdrive .....	7-5
Distortion .....	7-6
Preamp and SplitPreamp .....	7-6
Effect1 and Effect2 .....	7-8
Detune (M), Detune (S) and Detune (D) – Effect1 only .....	7-8
Shift (M), Shift (S) and Shift (D) – Effect1 only .....	7-9
DiatonicHmy – Effect1 only .....	7-10
Panner .....	7-11
Auto Pan .....	7-11
Tremolo (M) and Tremolo (S) .....	7-12
UniVybe .....	7-12
CustomVybe .....	7-13
Phaser .....	7-13
OrangePhase .....	7-14
Red Comp .....	7-14
Blue Comp .....	7-15
DigiDrive1 and DigiDrive2 .....	7-15
OctaBuzz .....	7-16
SweepFilter .....	7-17
1-Band (M) .....	7-17
Wah 1, Wah 2 and PedalWah1, PedalWah2 .....	7-18
Volume (M), Volume (S) and Volume (D) .....	7-19
PedalVol and ExtPedalVol .....	7-19
Test Tone .....	7-20
Click .....	7-20
Chorus Effects .....	7-21
Chorus .....	7-21
Detune (M) .....	7-22
Flanger (M), Flanger24 (M) and Flanger (S) .....	7-23
Rotary Cab .....	7-24
Aerosol .....	7-24
Orbits .....	7-25
Centrifuge1 and Centrifuge2 .....	7-26
Comb 1 and Comb 2 .....	7-27
Volume (M), Volume (S) and Volume (D) .....	7-28
PedalVol and ExtPedalVol .....	7-28
Delay Effects .....	7-29
Delay (M), Delay (S) and Delay (D) .....	7-30
Echo (M), Echo (S) and Echo (D) .....	7-31
Looper .....	7-32
JamMan .....	7-33
Ducker .....	7-34

Reverb Effects .....	7-35
Chamber .....	7-35
Hall .....	7-35
Plate .....	7-36
Ambience .....	7-36
Gate .....	7-37
EQ Effects .....	7-38
1-Band (M), 2-Band (M), 3-Band (M) and 4-Band (M) .....	7-40
1-Band (S) and 2-Band (S) .....	7-40
1-Band (D) and 2-Band (D) .....	7-41
Fc Splitter .....	7-41
Crossover .....	7-42
Volume (M), Volume (S) and Volume (D) .....	7-42
PedalVol and ExtPedalVol .....	7-43

## Contents, cont'd.

### 8. MPX G2 Internal Controllers

Knob .....	8-1
LFO1 and LFO2 .....	8-1
Random Generator .....	8-2
A/B Glide .....	8-2
Env .....	8-3
Footswitch Controllers .....	8-3

 Complete descriptions of the MPX G2 Internal controllers

### 9. Program Descriptions

1-99: Amp Input + FX Loop .....	9-1
100-149: Amp Input Only .....	9-15
150-248: Stand Alone .....	9-20
249-250: Utility (All configurations: Unity Gain and Clean Slate) .....	9-30

 Complete descriptions of the MPX G2 programs

### 10. Troubleshooting

Low Voltage .....	10-1
Overheating .....	10-1
Common MIDI Problems .....	10-1
Power On Behavior .....	10-2

 Check here for solutions to common problems

### 11. Specifications

## Foreword

When we started development on the MPX G2 Guitar Effects Processor and the MPX R1 MIDI Remote Controller, we knew we were designing for the most discriminating guitarists — players whose tonal foundation is based on this no-compromise equation:

great guitar + great amp = great tone

Our challenge was to put together a guitar effects system that could mesh with your favorite gear and not get in the way of your signature sound. Since we had no intention of trying to duplicate the “great amp” portion of the equation inside of our effects processor, we needed to make the MPX G2 capable of putting effects in two places at the same time — between the guitar and your amp (like stomp boxes) or in your amp’s effects loop (like rack effects). Add to that the challenge of getting the sounds right, and combining analog and digital effects in a roadworthy package, and you’re definitely into something totally new.

So, here it is. A lot of people have put a lot of sweat into this box so you could do what you do best — so get out there and play.

Throughout the development process of our Custom Shop products, we’ve had the help of a team of artist advisors. Time and again their input had a major impact on both the MPX G2 Guitar Effects Processor and MPX R1 MIDI Remote Controller. Some were with us at the beginning, when these products were just concepts on paper, others joined us as various prototypes came roaring to life.

Jon Finn, Dave Friedman of Rack Systems Ltd., Michael James, Eddie Kramer, Peter McCabe of Tone King Studio, John McIntyre, Bobby Owsinski, John Petrucci, Blues Saraceno, Alex Saraceno, David Torn and Carl Verheyen — each made significant contributions, including:

putting their reputations on the line by working with experimental gear in front of large paying audiences — or in critical sessions with the clock ticking, so that we could evaluate under real-world conditions.

sharing secrets, tips and tricks — “How did you get that sound on (insert hit tune from platinum record)?”

spending hours and hours of critical listening time to help us evaluate our work as it progressed, and letting us know when we had to go back to the drawing board.

Thanks to each of you for applying your consummate skills to this project. Your faith, encouragement, enthusiasm and patience helped us get it right.



## Introduction

Thank you for your purchase of the MPX G2 Guitar Effects Processor. The MPX G2 works with any amp, from combo to stack, allowing you to place authentic effects anywhere in the signal chain without altering the amp's basic tone. Two separate signal paths allow you to place effects where you want them. For example, compression, wah and analog overdrive can be placed in front of the amp, while other effects, like delay, chorus and reverb might be placed in the amp's effect loop.

Dynamic Gain™, Lexicon's new analog distortion technology provides screaming overdrive and warm distortion tones which can be used as an analog stomp box in front of your amp or as a stand alone preamp for direct recording or live performance.

Seven primary effect types: Gain, Effect 1, Effect 2, Chorus, Delay, EQ and, Reverb give you push button access to 76 effects, including extraordinary recreations of classics like the Uni-Vibe®, Dyna-Comp®, Phase 90®, Vox® and Cry Baby® wah, intelligent pitch shift, a JamMan™ style looper with 20-second full bandwidth delays, Chorus, Flanger, Sweepfilter, Detuner, Rotary Speaker, Parametric EQ and Tremolo.

The preset library is organized under database control to allow you to quickly find programs designed for specific styles such as Rock, or Blues, to find all of the programs using certain effects such as Overdrive, or to find only programs suitable for Stand Alone operation.

Visual feedback is available every step of the way when you're using the MPX G2, with lighted buttons indicating the state of the unit and alerting you to extra features available from the front panel. A large numeric display shows program (and patch) numbers. A second alphanumeric display shows you program and parameter names and settings.

Like all Lexicon processors, the MPX G2 gives you as much depth of control as you're ever likely to want, while keeping the details out of your way. Surface control of the MPX G2 is straightforward and intuitive, with the most useful parameters of every program available from a dedicated Soft Row button on the front panel.

The MPX G2 gives you tap tempo control when you want it. You can assign tempo control to modulation rates, delay times or any effect parameter, ensuring that your effects are in tempo with your music. Tempos can be tapped in with the front panel **Tap** button (or an assigned controller) or "dialed-in", in BPM (beats per minute) on the display. The MPX G2 also lets you generate MIDI clock from your tempo, as well as receive MIDI tempo from an external sequencer or drum machine. Many presets have delay times assigned to Tap tempo. When you load a tempo driven program, the front panel **Tempo** LED will flash at the current tempo to let you know the **Tap** button is active. Press **Tap** twice in rhythm to change tempo.

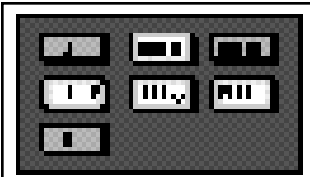

Effect buttons light to show you which are active in any program. Push any lighted effect button to instantly bypass the effect. Press it again to turn the effect back on.

### Database Sorting Options

Sort selections by:

name

number

Guitar Style:

Bass

Blues

Clean

Country

Jazz

Rock

Effect type:

Chorus

Delay

Distortion

EQ

Flanger

Gain

Mod

Overdrive

Phaser

Pitch

Reverb

SpkrSim

Wah

All

App type:

StdAlne

Amp In

FX Loop

members of MIDI maps

members of pgm chains

last 10 programs loaded



The Tempo light will flash in tempo whenever the **Tap** button is active. Press **Tap** twice in rhythm to match the tempo of effects to your music.

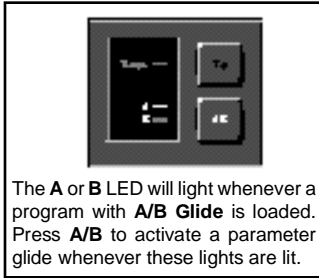

An A/B glide function is also available from the front panel — and of course we've designed presets to show this function off to its fullest. Whenever the **A** or **B** LED is lit, press the A/B button to activate the glide.

When you want to create your own versions, you'll find A/B available as an internal controller in Edit mode along with two LFOs, an Envelope, and more.

Complete editing control is provided under the Edit button, where you can customize presets or make new ones from scratch, design your own soft row parameters, copy effects into new programs, and put effects in any sequence or routing configuration you want. Easy access to all of the parameters of any effect is just a button push away.

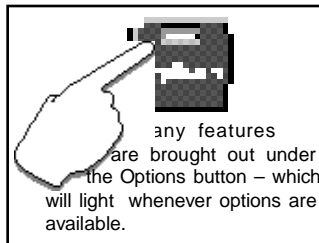

All of the front panel functions (Tap, A/B, Effect selection, etc.) can easily be connected to MIDI controllers, footswitches, or footpedals, letting you set up all of the functions the way *you* want them.

#### **About the manual**

To get the most out of the MPX G2, we suggest that you invest the time to explore this manual. We think you'll agree that the time spent investigating will reward you with enjoyment of its full capabilities.

To get off to a quick start, turn directly to Chapter 1 *Product Overview* and Chapter 2 *Basic Operation*. The first section provides button definitions and necessary information for setting audio levels and connecting to other equipment. The second will tell you everything you need to know about loading and playing with programs.

When you want to know more, check out the Table of Contents. We've divided topics into many easy to read (or skip) chapters so that you can find what you need without wading through what you don't.

## Product Overview

### The Front Panel

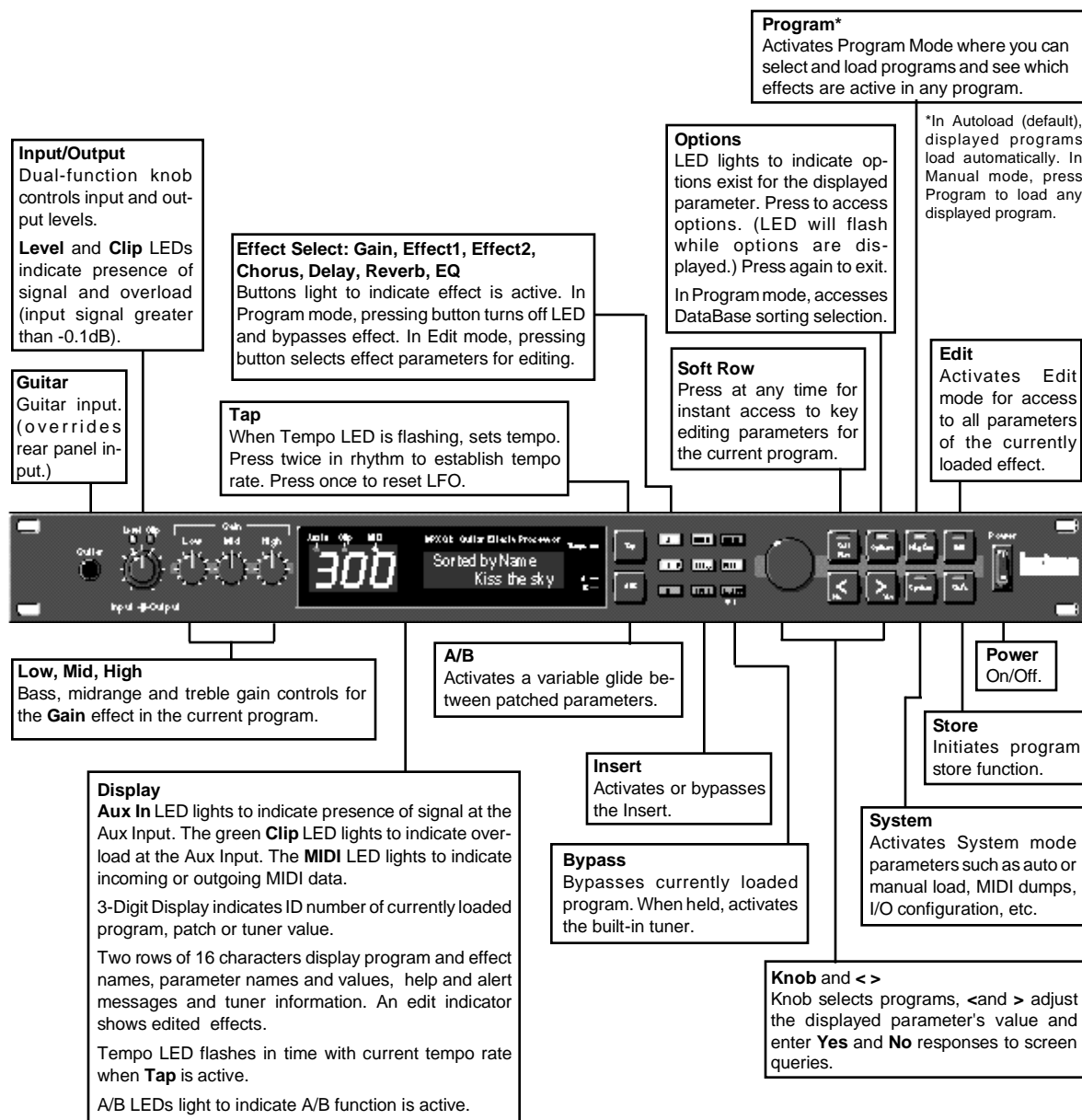

## The Rear Panel

**MIDI IN**  
7-pin DIN connector for MIDI IN or powered bidirectional MIDI remote.

**THRU**  
5-pin DIN connector passes any MIDI data received without change.

**OUT**  
5-pin DIN connector transmits MIDI data to other equipment.

**Insert Returns (from Preamp)**  
When connected, external audio will be inserted after the **Gain** block.

**Insert Returns Level**  
Controls the input level of the Insert Returns.

**Insert Send (to Preamp)**  
When the Insert Returns are connected, all effects before (and including) the **Gain** block will be passed to this connector.

**Guitar Input**  
Guitar input (overridden by front panel input.)



**REMOTE POWER IN**  
2.5mm connector for 9 VAC MIDI remote power.

**Foot Pedal**  
1/4" Tip/Ring/Sleeve phone jack provided for footpedal with 10kΩ to 100kΩ impedance.

**Phones**  
Headphone input.

**Main Outputs (to Power Amp or Console)**  
XLR and 1/4" TRS: Output impedance is 600Ω, each side, balanced, and levels up to +18dBu maximum full scale.  
Unbalanced output levels up to +21dBu into 100kΩ.

**AC Power**  
Standard 3-pin IEC power connector. 100-240V, 50-60Hz automatic switching to correct voltage range.

**Foot Switch**  
1/4" Tip/Ring/Sleeve phone jack for three independent footswitches.

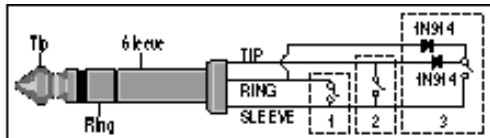

For control voltage input, use a 1/4" stereo plug with Sleeve connected to ground, Tip connected to the control voltage, and Ring unconnected.

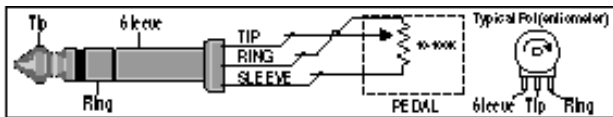

Typical Pedal (with resistor)

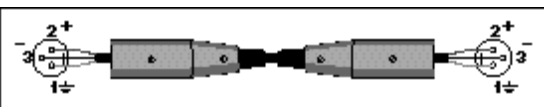

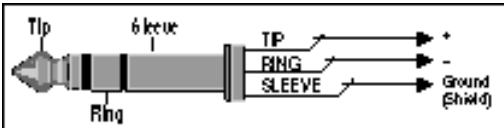

## Installation Notes

The MPX G2 uses one EIA-standard rack space, and can be mounted on any level surface or in a standard 19 inch (483 mm) rack. If the unit is mounted in a rack or road case, support the rear of the chassis to prevent possible damage from mechanical shock and vibration.

The maximum ambient operating temperature is 104°F (40°C). Provide adequate ventilation if the unit is mounted in a closed rack with heat-producing equipment such as power amplifiers.

The MPX G2 is equipped with a 3-pin IEC power connector and detachable cord. The unit will operate with power sources from 100 to 240 volts AC, 50-60Hz. Power switching to actual line voltage is automatic.

## Mounting

## Power Requirements

You're here because you want to play with the MPX G2 RIGHT NOW. Plenty of time to read the manual later right?

OK. First things first. If the MPX G2 isn't fresh out of the box, let's make sure that all of the internal parameters are set to their original factory settings. (This won't affect any user programs.)

1. Press System twice.
2. Use the knob to select **Initialize**.
3. Press > to display **All**.
4. Use the knob to select **System Only**.
5. Press **Store**.
6. The display will show: **Are you sure?/Yes or No**.
7. Press **Yes**.

What happens next depends on how you want to connect and use the MPX G2. Setups for of the three basic configurations is covered in the following pages.

- Stand Alone: connected directly to headphones, mixer or power amp
- Amp Input Only: connected to a guitar amp that does not have an effects loop
- Amp Input & FX Loop: connected to a guitar amp that has a mono or stereo effects loop

Each application has its own set of programs — so be sure to listen to the programs that match the application.

## Quick Start

**Reset the MPX G2 to its factory settings**  
(User programs are not affected.)

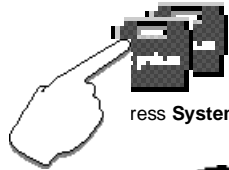

Press **System** twice.

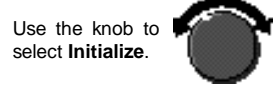

Use the knob to select **Initialize**.

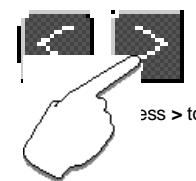

Press > to select **All**.

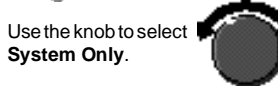

Use the knob to select **System Only**.

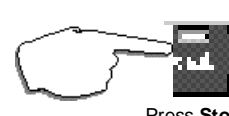

Press **Store**.



Press **Yes** in response to the display prompt.



**Stand Alone:  
Direct connection to  
headphones, mixer or  
power amp**

**Use with  
Programs 150-250**

1. Turn the front panel Output control all the way down
  2. Connect the Left and Right outputs to two input channels of your mixer or power amp
- OR
- Connect a pair of stereo headphones to the rear panel Phones jack
3. Connect your guitar to the MPX G2 front panel Guitar input
  4. Set the MPX G2 front panel Input knob to 2 o'clock.
  5. Select your guitar's most powerful pickup, turn the guitar volume control up all the way and play your loudest.
  6. Watch the **Level** and **Clip** LEDs above the MPX G2 Input/Output knob. If the red **Clip** LED comes on more than just occasionally during your very loudest playing, back off the Input knob a bit. (With some guitars, the red LED may never come on — that's OK.) Now that you've got the Input knob set for your loudest playing, feel free to change the controls of your guitar to any settings you like as you audition the MPX G2.
  7. While playing, slowly turn up the front panel Output knob until you reach a comfortable listening level. (You will hear a slight ticking as this knob is adjusted — this is normal.)

Now you're ready to start listening to the Stand Alone programs (150-250).

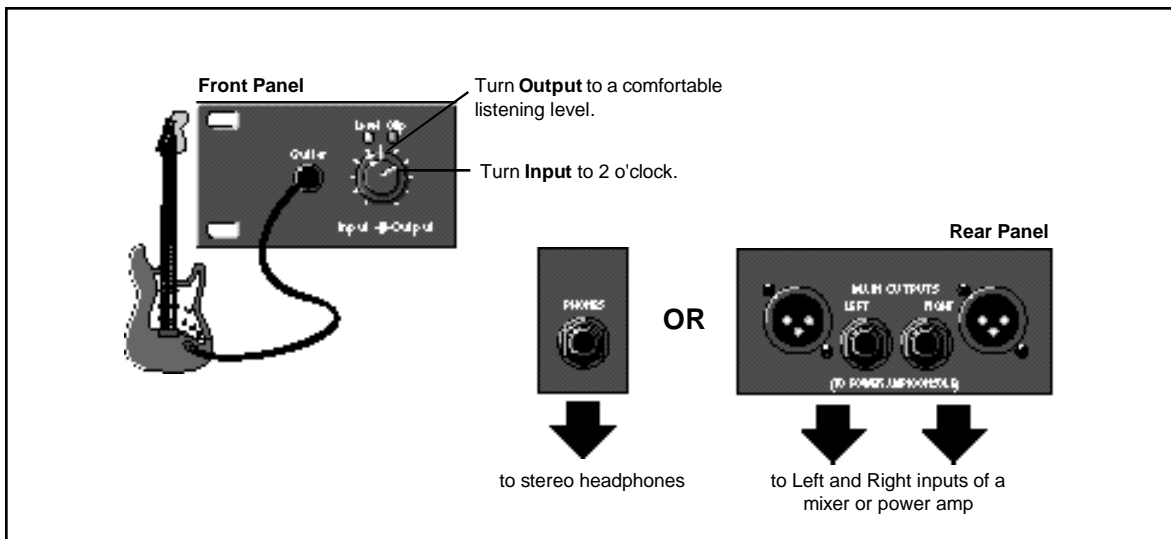

1. Load MPX G2 program **249 Unity Gain**.
2. Plug your guitar directly into your amp and set the guitar volume to a comfortable listening level.
3. Put your amp on standby — or turn it off.
4. Unplug your guitar from the amp and connect the MPX G2 rear panel Send jack to the input of your guitar amp.
5. Connect your guitar to the MPX G2 front panel Guitar input.
6. Set the MPX G2 front panel Input knob to 2 o'clock.
7. Select your guitar's most powerful pickup, turn the guitar volume control up all the way and play your loudest.
8. Watch the **Level** and **Clip** LEDs above the MPX G2 Input/Output knob. If the red **Clip** LED comes on more than just occasionally during your very loudest playing, back off the Input knob a bit. (With some guitars, the red LED may never come on — that's OK.) Now that you've got the Input knob set for your loudest playing, feel free to change the controls of your guitar to any settings you like as you audition the MPX G2.
9. Press **Bypass** to bypass the program. (The **Bypass** LED will turn on.)
10. Take your amp out of standby (or turn it on) and play. The volume and tone of the guitar should be the same as when you were plugged directly into the amp, thanks to the MPX G2 built-in relay bypass.
11. Press **Bypass** again to make the program active. (The **Bypass** LED will turn off). Play and compare this level with the bypassed level — they should be very close.
12. With the program active, adjust the position of the MPX G2 Input knob to match the bypassed loudness.

**Amp Input Only:  
Connection to a guitar  
amp that doesn't have an  
effects loop**

**Use with  
Programs 100-149**

Now you're ready to start listening to the Amp Input Only programs (**100-149**).

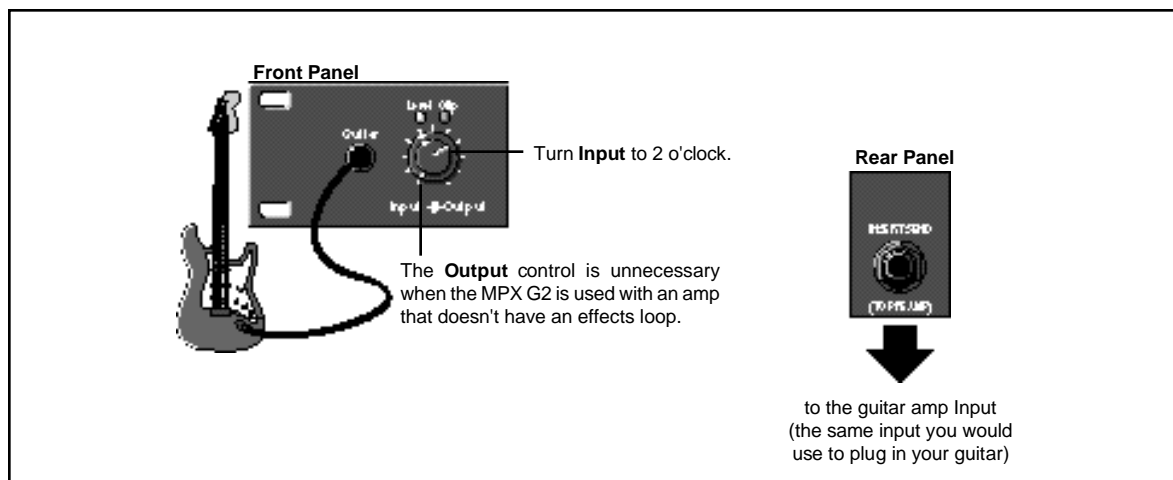

### Amp Input & FX Loop: Connection to a guitar amp with a mono or stereo effects loop

Use with  
Programs 1-99

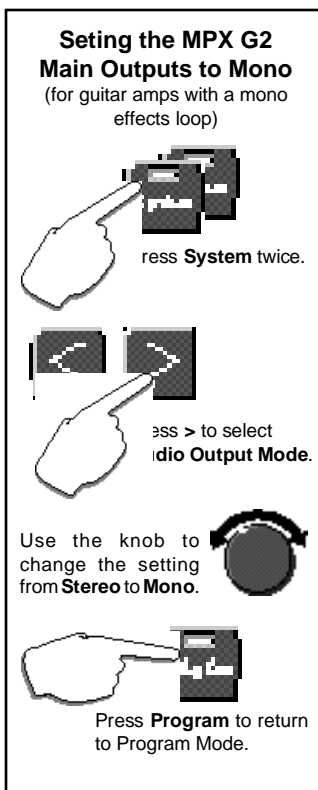

This is a bit more detailed than Stand alone or Amp Input Only setup — you'll be connecting the MPX G2 to both sides of your guitar amp's preamp section. Care must be taken to match levels on both sides of the preamp properly so the tone of your amp is not affected. By the way, as this setup involves making connections and changing controls on both the front and rear of the MPX G2 and your amp, as well as playing, it might be helpful to have someone help you out with this.

If your guitar amp has a **stereo effects loop**, skip ahead to Part 1. If your guitar amp has a **mono effects loop**, set the MPX G2 Main Outputs for mono as follows:

1. Press **System** twice to display **System select: Audio**.
2. Press **>** to select **Audio Output Mode**.
3. Turn the knob to change the setting from **Stereo** to **Mono**.
4. That's it! Press **Program** to return to Program mode

#### Part 1: Setting up the Pre Gain Path (connecting to the amp input)

1. Load MPX G2 program **249 Unity Gain**.
2. Plug your guitar directly into your amp and set the guitar volume to a comfortable listening level.
3. Put your amp on standby — or turn it off.
4. Unplug your guitar from the amp and connect the MPX G2 rear panel Send jack to the input of your guitar amp.
5. Connect your guitar to the MPX G2 front panel Guitar input.
6. Set the MPX G2 front panel Input knob to 2 o'clock.
7. Select your guitar's most powerful pickup, turn the guitar volume control up all the way and play your loudest.
8. Watch the **Level** and **Clip** LEDs above the MPX G2 Input/Output knob. If the red **Clip** LED comes on more than just occasionally during your very loudest playing, back off the Input knob a bit. (With some guitars, the red LED may never come on — that's OK.)  
Now that you've got the Input knob set for your loudest playing, feel free to change the controls of your guitar to any settings you like as you audition the MPX G2.
9. Press **Bypass** to bypass the program. (The **Bypass** LED will turn on.)
10. Take your amp out of standby (or turn it on) and play. The volume and tone of the guitar should be the same as when you were plugged directly into the amp, thanks to the MPX G2 built-in relay bypass.
11. Press **Bypass** again to make the program active. (The **Bypass** LED will turn off). Play and compare this level with the bypassed level — they should be very close.
12. With the program active, adjust the position of the MPX G2 Input knob to match the bypassed loudness.

#### Part 2: Setting up the Post Gain Path (connecting to the amp effects loop)

1. Put your amp on standby — or turn it off.
2. Turn the MPX G2 front panel Output knob down all the way.

3. Connect the amp's effects loop send to the MPX G2 rear panel Insert Returns jacks. (Note that when you make this connection, the MPX G2 front panel **Insert** button lights up to indicate something is connected to the Insert Returns.)
4. If your amp has a **mono effects loop**...  
connect the amp's loop send to the MPX G2 rear panel **Right (Mono) Insert Return** jack.  
If your amp has a **stereo effects loop**...  
connect the amp's left and right effects loop sends to the MPX G2 rear panel **Left and Right Insert Returns**.
5. Connect the MPX G2 rear panel **Main Outputs** to the effects loop returns of your amp. (If your amp has a **mono effects loop**, you can connect to either the MPX G2 Left or Right Main Output jack.)
6. Set the MPX G2 rear panel **Insert Level** knob to **0**.
7. Take your amp out of standby (or turn it on).
8. With program **249 Unity Gain** still loaded, play your guitar. (You won't hear anything yet.) Slowly turn up the MPX G2 rear panel **Level** knob. (The MPX G2 front panel **Aux In** LED should light to show that you have signal coming into the Insert Returns.) Continue increasing **Level** until the MPX G2 front panel **Clip** LED only lights occasionally during your very loudest playing.
9. Slowly turn up the MPX G2 front panel Output knob until the amp is back at its original loudness. (For most amps, this will be at about the 2 o'clock position.) You will hear a slight ticking as this knob is adjusted — this is normal.  
  
Note the positions of the MPX G2 front panel Output knob as well as the position of the rear panel Level knob. These should be the same whenever you connect to this particular amp.

**NOTE:** To get the output level exactly right, you need to compare the volume of the amp with its effects loop *disconnected*, to its volume with its effect loop *connected*. Here's where an extra pair of hands can be very helpful. Load Program 249 Unity Gain. While you play, have someone else unplug the effects loop connections from the amp. Listen to the loudness of the sound, then have the loop plugged back in.

If the amp is louder with the loop connected, turn down the MPX G2 front panel Output knob.

If the amp is softer with the loop connected, turn up the Output knob. Repeat this until you can't hear any volume difference with the loop connected or not.

OK, that's it! Now you're ready to start listening to the Amp Input & FX Loop programs (1-99).

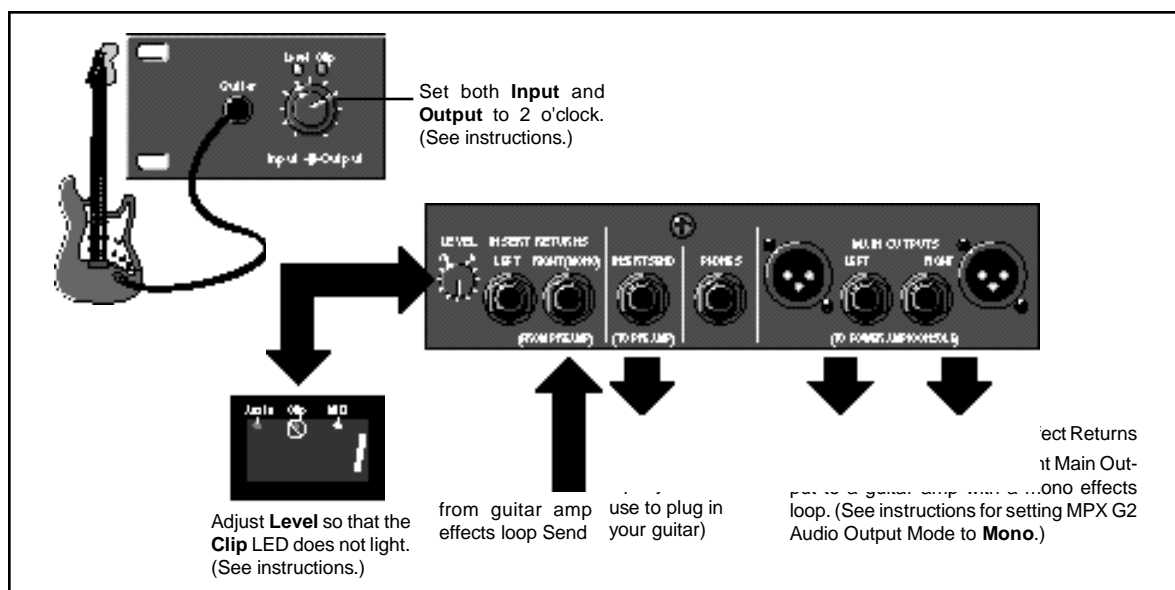

### Connecting Other Equipment

#### Footswitch/Footpedal

One 1/4 inch T/R/S phone jack is provided for 3 momentary footswitches. Another 1/4 inch T/R/S phone jack is provided for a footpedal (minimum 10k to maximum 100k impedance). Normally open or normally closed momentary switches are suitable. At power on, the MPX G2 assumes the switch is off. Use shielded, twisted-pair cable with shield connected to sleeve. See diagram on previous page. See also Chapter 5: *System Controls* for information on pedal calibration.

#### MIDI

5-pin DIN connectors are provided for MIDI THRU and OUT. A 7-pin DIN connector is provided for MIDI IN or a powered remote. Use standard MIDI cable assemblies, available from your local dealer.

#### Connecting to an MPX R1

When an MPX R1 is connected to an MPX G2, two-way communication is accomplished via MIDI System Exclusive messages. This allows immediate response by both units to actions on either front panel.

Connect the power adapter provided with the MPX R1 to the MPX G2 REMOTE POWER input jack and to a wall outlet.

Power up the MPX G2 and connect the 7-pin DIN cable provided with the MPX R1 between the MPX G2 rear panel IN/REMOTE jack and the MPX R1 MIDI OUT/REMOTE.

The MPX R1 will cycle through a power-up routine, lighting various LEDs, and then display **Con**. The MPX G2 will display **Remote Detected**. These messages indicate that proper bidirectional control has been established.

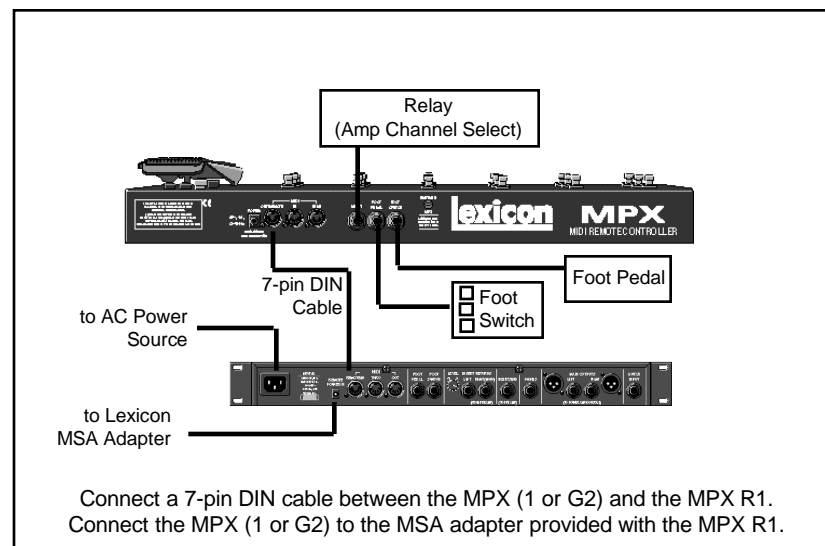

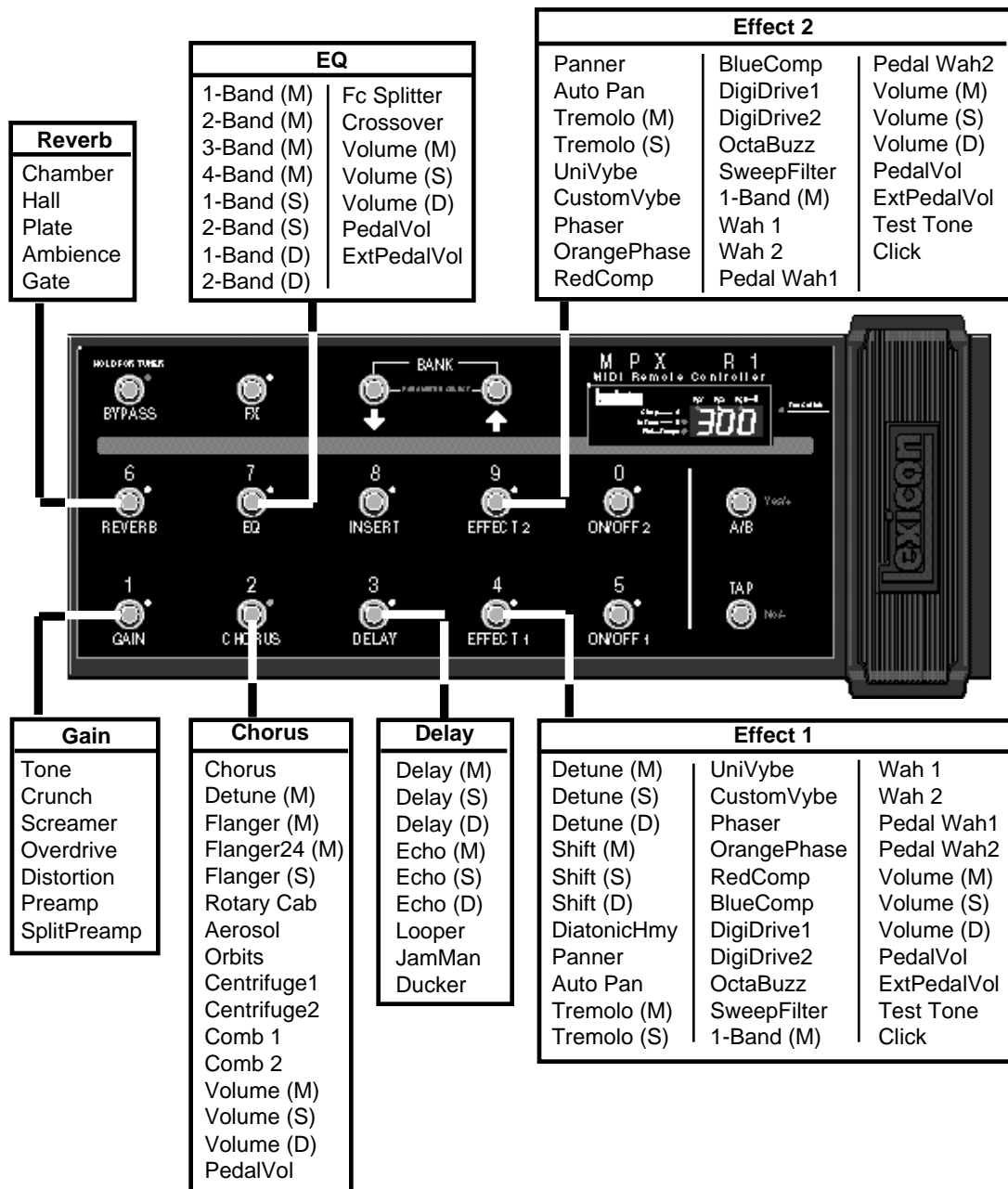

Connecting an MPX R1 to the MPX G2 gives you stomp-box control of all of the MPX G2 effects.

**Signal Flow** Following are diagrams showing signal flow in the MPX G2 Pre-Gain and Post-Gain paths. When combined, these two diagrams show the entire signal path between your guitar and the Main Outputs when the MPX G2 is used as a standalone processor. Depending on which effects are active in a given program (and where they are placed), the MPX G2 will automatically route around unnecessary analog circuits as well as A/D and D/A converters. This allows signal-to-noise and dynamic range to be optimized for every program.

Effect 1, Effect 2, Chorus, Delay, Reverb and EQ can be placed in any combination on either, or both, pre gain and post gain paths.

**Pre-Gain Path**

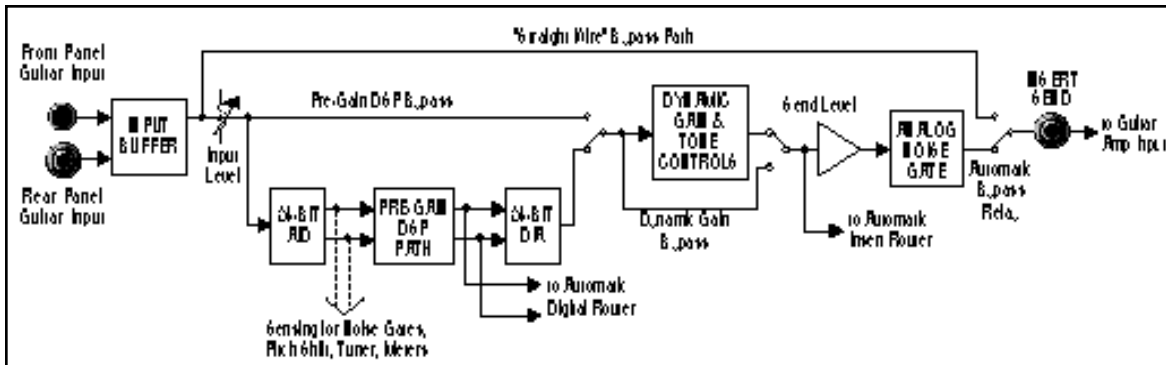

This is the signal flow between your guitar and amp when Insert Send is connected to the input of the guitar amp (pre gain path). The “straight-wire” bypass path and automatic bypass relay function as an effect loop switcher. The analog noise gate will help keep noise under control when you use effects in front of your amp’s high-gain channel.

**Post-Gain Path**

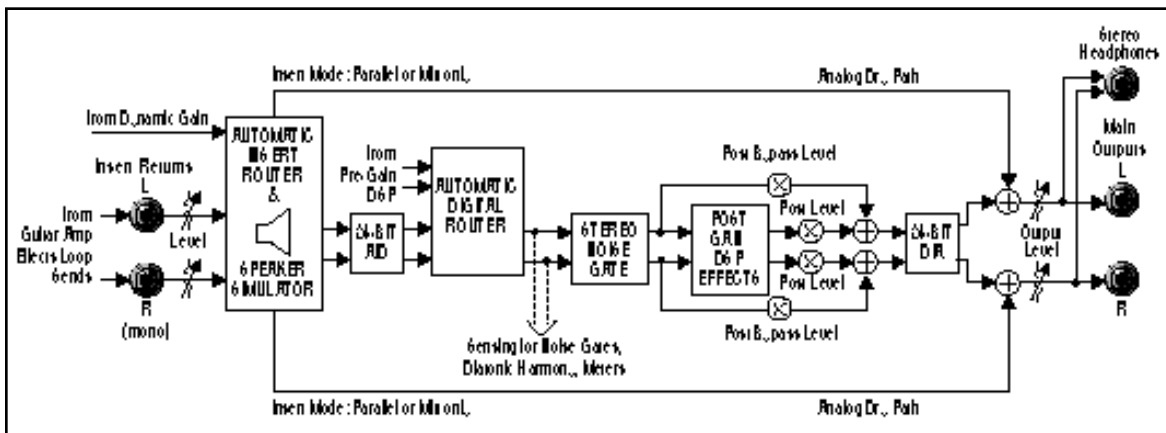

This is the effects loop processing path when the Insert Returns are connected to your amp’s effects loop sends (post gain path). The built-in Insert Router and Digital Router automatically configure the signal flow based on which connections and settings you’re using. The stereo noise gate can reduce stage levels to near silence when you stop playing - without muting the tails of post gain effects like delays or reverbs.

The MPX G2 is a complete guitar processing system. As such it has two independent audio paths: one for effects that go directly between the guitar and the input to the amp (pre-gain path), the other for effects that are inserted in the amp's effects loop (post-gain path). Analog Dynamic Gain effects (Tone, Crunch, Screamer, Distortion, and Preamp) are dedicated to the pre-gain path. The other 70 effects can be placed anywhere on either path and each one of the 300 MPX G2 programs can have its own unique combination of effects, distributed on either path.

## Dual Audio Paths

When different pieces of audio gear are connected together, care must be taken to avoid ground loops (which can cause noise and hum problems). The MPX G2 uses a special grounding scheme to safely minimize grounding-related problems. All circuits are internally connected to a common ground plane. (This is the same approach used to ground racks of gear in studio installations and touring rigs.) The chassis is isolated from the printed circuit board to prevent ground loops through the ground pin of the AC cord. No special cables are required when connecting the MPX G2 to other equipment.

## Internal Grounding

Note that the G2 must always be properly grounded via the ground pin in its AC line cord.

With the exception of the Main Outputs and the stereo Headphone connectors, all of the 1/4" connectors are unbalanced mono jacks. For best performance use high-quality, shielded instrument cables.

## Unbalanced Connections

The MPX G2 has two high impedance guitar inputs: one on the front panel and another on the rear panel. Connecting to the front panel input will override a connection made at the rear panel input.

## Guitar Input

For best performance, maintain balanced connections, and use high-quality, low-capacitance, shielded twisted-pair cable. Use shielded instrument cables for unbalanced connections.

## Main Outputs

When connecting the MPX G2 XLR outputs to single-ended, unbalanced devices, leave the low side floating and connect the grounds between the units.



**Insert Send** The MPX G2 Insert Send is always active. When Gain is on, its signal is from the Gain block output. When Gain is bypassed, or when no Gain effect is in the program, its signal is from the Gain block input. Note that this signal passes through a programmable level control (**Edit mode: Mix: Send Level**) and analog noise gate before leaving the unit via the Insert Send jack. Note also that whenever there are no active effects between the guitar input and the Insert Send, a relay automatically switches in a “straight-wire” bypass path. This ensures that there is nothing between your guitar and your amp unless one or more pre-gain effects are active. (Until the MPX G2, the only way to get this same kind of analog purity when using effects was to install a dedicated effects loop switching unit.)

**Insert Returns** Inserting a jack into either (or both) Insert Return connectors breaks the normalised connections between pre-gain and post-gain paths, allowing you to insert an external device (guitar preamp, effects processor, etc.) into the MPX G2 signal path. When an external device is inserted, the front panel Insert button LED will light.

The external device can be bypassed by pressing Insert (its LED will go out). When the MPX G2 is connected to an amp’s effects loop, you can use the Insert button to bypass the amp’s preamp and send MPX G2 signals directly into the amp’s power amp. This feature allows you, for example, to switch between your amp’s high-gain channel and an MPX G2 Gain effect clean channel.

**Automatic Insert Return Signal Routing** The Insert Return jacks have software-controlled sensing and switching circuitry to automatically route signals depending on which jacks are used and the MPX G2 bypass state.

**Right (Mono) Only** When only the Right Insert Return is connected, its signal is split and sent into both the left and right channels of the post-gain path. When the unit is bypassed, the dry Insert signal will be present at both outputs.

**Stereo** When both Left and Right Insert Returns are connected, their signals are sent in stereo to the left and right channels of the post-gain path. When the unit is bypassed, the dry stereo signal is present at the outputs.

**Left Only** When only the Left Insert Return is connected, its signal is sent only to the left channel of the post-gain path. The right channel of the post gain path is “normalised” to the right channel of the pre gain path. When the unit is bypassed, the dry Insert signal is present on the left output and the Guitar Input signal is present on the right output.

The MPX G2 Main Outputs are set to stereo at the factory. When connecting the MPX G2 to an external device with a mono input (such as a mono effects loop return), set the Main Outputs for mono as follows:

1. Press **System** twice. The display will show **System select: Audio**.
2. Press **>** to select **Audio OutputMode**.
3. Turn the knob to change the setting from **Stereo** to **Mono**.
4. Press **Program** to return to Program mode.

### Connecting the Main Outputs to Mono Input

The MPX G2 is factory set to produce unity gain when the front panel Input and Output controls are set to 2 o'clock, and the Input Clip and Aux In Clip LEDs only come on briefly during your very loudest playing (if at all). (See *Quick Start* earlier in this chapter for detailed instructions on setting levels.)

### Setting Audio Levels

**Soft Sat** is a built-in analog limiter that precedes the A/D converters in the MPX G2. If the source to the MPX G2 is "hot", you can use **Soft Sat** to reduce the harshness caused by overloading the A/D converters. Press **System**, select the **Audio** menu, then select **Soft Sat** to turn the limiter **On** or **Off**.

### Using Soft Sat

The green **Level** LED indicates signal presence (above -30dB) at either the front or rear panel guitar inputs. The red **Clip** LED indicates overload at either of these inputs, or overload of any effect in the pre-gain path.

### Input Level and Clip Indicators

The **Aux In** LED indicates signal presence at either of the two Insert Return jacks. The **Aux In — Clip** LED indicates overload of either of the Insert Returns, or overload of any effect in the post-gain path.

### Aux In and Clip Indicators



Beginning with a menu tree to guide you through the major areas of the MPX G2, this chapter focuses on the basics that you want to get to first — finding, loading, tweaking and storing programs.

## Basic Operation

### MPX G2 Menus

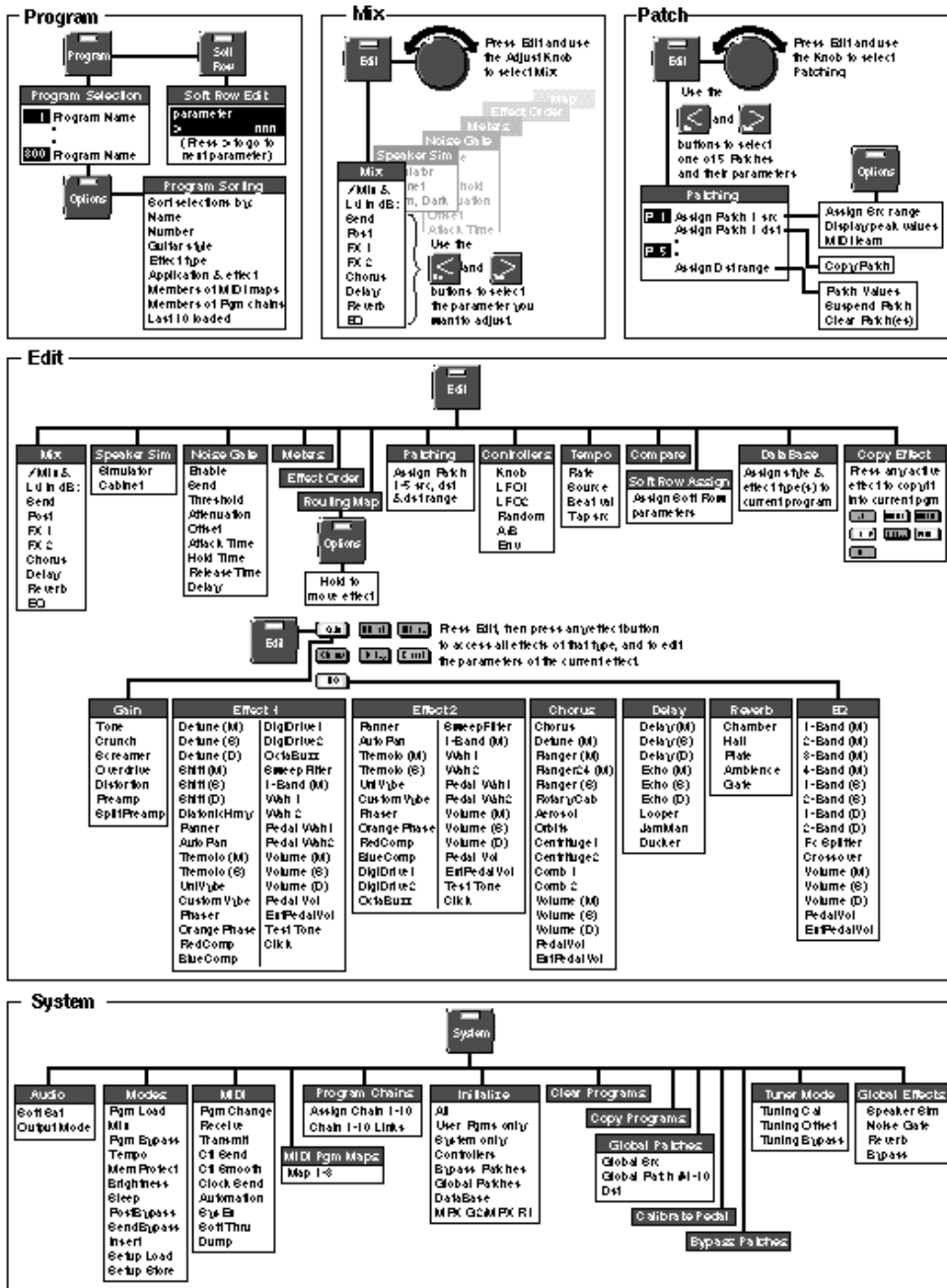

### Loading and Playing with Programs

Pressing the front panel **Program** button accesses the MPX G2 library of 300 presets and user programs. In this mode, you can select and load programs, select database sorting criteria and access the "Soft Row" — a selected set of the most useful parameters for each program. You can also access Tap, A/B, Mix and Patch functions, as well as selecting and bypassing effects in the program. Each of these is described in this section.

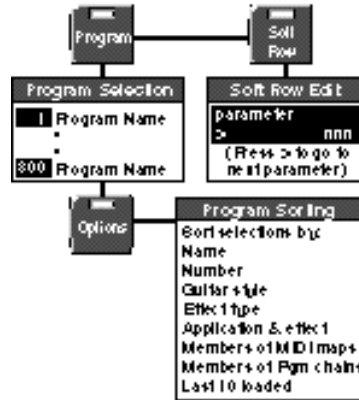
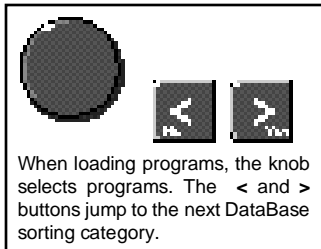

#### Program Load

When you press the **Program** button, its LED will light to let you know you're in Program mode.

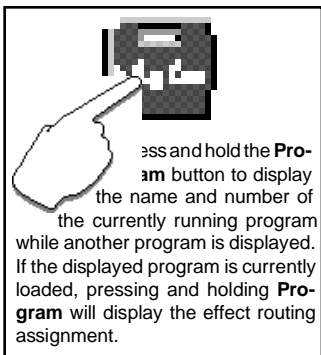

#### Auto Load

When first shipped, the MPX G2 will default to automatic program load, with all of the programs available in numerical order from 1 to 300. The top line of the display will show the DataBase sorting option "Sorted by number". The bottom line of the display will show a program name. The large numeric display will show the ID number of the displayed program.

Turn the knob to display and load other programs. An asterisk (\*) will appear briefly before each program name before it loads.

#### Manual Load

To switch to manual program load, press **System**. Use the knob to select **Modes**, then use the < and > buttons to display:

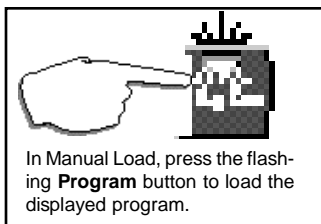
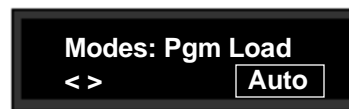

Turn the knob to select **Manual**. In this mode, an asterisk (\*) before the program name indicates that the displayed program is not loaded, and the flashing **Program** button LED indicates that the program is cued for loading when **Program** is pressed. (When the currently loaded program is selected, the **Program** button LED will light steadily, and there will be no asterisk in the display.)

The front panel Effect buttons light to show you which effect blocks are active. — When you're scrolling through programs, they'll change to show you the effects in any displayed program. Once you stop scrolling, they'll return to display of the effects that are active in the currently loaded program.

To bypass any active effect, press its button. The light will turn off and the effect will be bypassed. Press the button again to make the effect active again.

Press and hold down any effect button to display the name of the effect and information about its status in the program (on or off).

### Effect Bypass

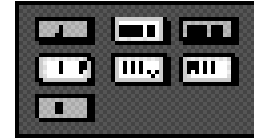

The active effects of the currently loaded program are lighted. Press any lighted button to turn the effect off. Press it again to make the effect active again.

External audio gear (guitar preamp, CD player, etc) can be inserted into the MPX G2 audio path via the rear panel Insert Return jacks. The front panel **Insert** button will light to show you when this connection is active.

To bypass this external connection, press **Insert**. The LED will turn off and the inserted gear will be bypassed. Press **Insert** again to make the inserted gear active again.

When the MPX G2 leaves the factory, Insert connections are routed in series between the pre-gain and post-gain paths. (This is the best routing to use when connecting to amplifier effects loops.) You can alter this routing by changing the setting of the Insert parameter in the **System: Modes** menu. Be sure to read about the three different Insert Modes (FX Loop, Mix and Parallel) in Chapter 5: *System Controls*.

**NOTE:** When the MPX G2 is connected to a guitar amp with an effects loop, the **Insert** button allows you to switch the guitar amp's preamp in and out of the audio path. When it is out of the path, the guitar signal flows through the pre- and post-gain paths and then directly into the power amp. This allows you to switch between dramatically different tones with a single button push.

### Insert Bypass



Press the lighted **Insert** button to bypass devices connected at the MPX G2 Insert Return jacks.

The MPX G2 has three dedicated front panel tone controls which allow instant modification of the Low, Mid and High settings of the Dynamic Gain effect in the current program. These controls are analog pots. Changes made with these knobs take place immediately (You don't have to pass-through the current value- once you move the knob, it "owns" the parameter.)

When any of these controls is moved, the display will briefly show the current values of all three controls, then return to the previous screen. Changed settings can be stored by pressing **Store** to initiate the Store procedure.

Be aware that in many of the Dynamic Gain effects, these tone controls interact with the analog distortion circuitry, increasing or decreasing the amount of distortion in Low, Mid and High frequency bands.

### Dedicated Analog Tone Controls

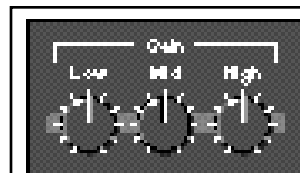

Dedicated front panel tone controls allow instant modification of the Dynamic Gain effect in the current program.

## Programmable Bypass Modes

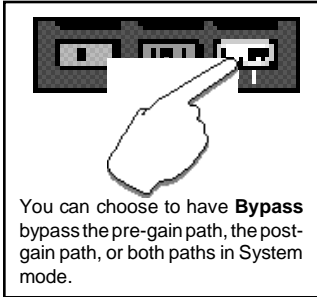

As the MPX G2 is designed with separate pre-gain and post-gain effects paths, the master **Bypass** button can be programmed to function in a variety of useful ways. The factory setting is for both paths to be bypassed when **Bypass** is activated. You can choose, however, to have this button bypass only the pre-gain path, only the post-gain path or both paths.

Bypass behavior for each path can be independently programmed as well. The pre-gain path can be set to **Disabled** or to provide an analog "straight wire" **Bypass**.

The post-gain path can be set to **Input Mute** (delays and reverbs will "ring out" when bypassed), **All Mute** (no output when bypassed) or **Bypass**. When set to **Bypass**, the post-gain path has an optional **Bypass Level** parameter that allows you to set an independent level for when the post-gain path is bypassed.

(Be sure to read about SendBypass and PostBypass under **System: Modes** in Chapter 5: *System Controls*.)

## Tuner

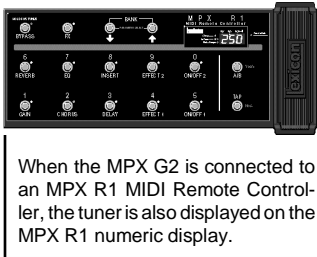

The MPX G2 has a built-in chromatic tuner. To activate the tuner, press and hold **Bypass**. When the tuning displays appear, release the button and play a note. The displays will show the name of the note you played, and also indicate how flat or sharp it is.



The note you play is shown on the display along with indicators to show whether the note is sharp, flat, or in tune.

When you're finished tuning, press **Bypass** again to return to normal operation.

When the Tuner is activated, the Insert Send and Main Outputs are automatically muted. You can change this behavior by changing the setting of the Tuning Bypass parameter in the **System: Tuner Mode** menu. (See Chapter 5: *System Controls*.)

## Tap

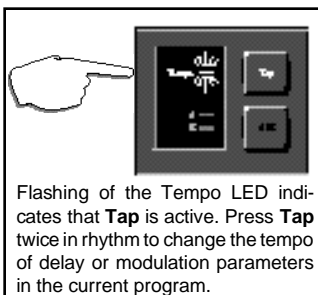

MPX G2 tempo controls are available right on the front panel through the Tempo LED and the **Tap** button. Many preset programs are designed with their own tempo rate settings which are stored with the programs. The front panel **Tempo** LED will flash in tempo whenever you load a program with tempo control. This flashing indicates that the **Tap** button is active, allowing you to change tempo on the fly. Whenever you see the **Tempo** light flashing, simply press **Tap** twice in rhythm to establish the rate you want.

You can override these individual tempo rates with a global tempo rate in the System Setup menu. Tempo is also available as an independent patch source which can control any effect parameter. (See Chapter 4: *Patching* and Chapter 5: *System Controls*.)

A/B is a unique glide function which allows you to "morph" between selected parameters. Most effect parameters (or groups of parameters) can be patched to the A/B controller. Once a parameter is patched, the A/B controls in Edit mode allow you to select the rate at which you want to glide from A to B and from B to A when the front panel **A/B** button is pressed. You can also assign the glide function to be triggered by any internal source, such as input level, or by an internal or external controller.

Many of the presets are designed with A/B patches that allow you to morph between two effects, glide from slow to fast rotary speakers, start and stop loop delays, etc. Loading any program with A/B control assigned, will cause the front panel **A** LED to light, indicating that the A/B function is active. Press **A/B** to activate a glide from the parameter values assigned to **A** to the parameter values assigned to **B**. Press **A/B** again to glide back to the **A** parameter values. (When you want to change the A/B parameters, control A/B remotely, assign a trigger source, or alter the rate of glide, refer to Chapter 4: *Patching* and Chapter 8: *MPX G2 Internal Controllers*.)

## A/B

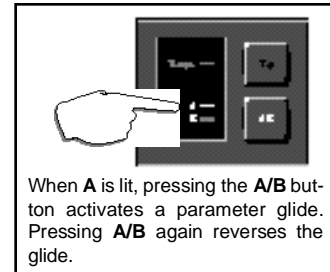

The MPX G2 offers access to the most useful parameters of any program *without* having to enter a separate Edit mode. These parameters are available at any time by pressing **Soft Row**.

The upper line of the display will show the Effect type, the parameter name and the current parameter value. The lower line of the display will show the name of the program. Use the knob to change the parameter value. Use the **<** and **>** buttons to move back and forth between the available parameters. A scroll indicator in the lower left corner of the display tells you whether or not there are more parameters in either direction.

## Soft Row Editing

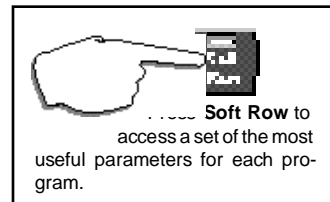

Changes you make to parameters in the Soft Row will be saved only until you load another program unless you store your modified version of the program. See *Program Store* later in this section.

Press **Soft Row** to access Soft Row parameters. The Effect type and the parameter name will appear on the upper line.



Scroll indicators (**<** and **>**) on the bottom of the screen point you in the direction of additional screens.

The parameter value will flash in the lower right. Use the knob to change the parameter value, use **<** and **>** to select another parameter screen.



## Using the DataBase

The MPX G2 has a database sorting function which allows you to sort and search for programs in various categories. This is a great timesaver when you're looking specifically for guitar effects, or EQ effects, or for EQ effects for guitar. When shipped, the DataBase sorting option is set to "Sort by number", allowing you to use the knob to scroll through all of the 300 programs in numerical order in Program mode. (The < and > buttons will jump you forward and back ten programs at a time. Simultaneously pressing < and > jumps from 1 to 251 or from 251 to 1.)

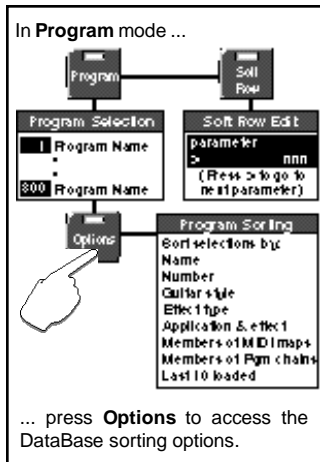

You can select other sorting criteria in Program mode by pressing **Options**. The **Options** LED will blink and the display will show:

**Sort programs  
by number**

Use the knob or the < and > buttons to select any of the main sorting options listed below:

- name
- number
- guitar style  
(Acoustic, Bass, Blues, Clean, Country, Jazz, Rock)
- effect type  
(Chorus, Delay, Distortion, EQ, Flanger, Gain, Mod, Overdrive, Phaser, Pitch, Reverb, SpkrSim, Wah, All)
- application type  
(StdAlne, Amp In, FX Loop)
- members of MIDI maps
- members of pgm chains
- last 10 programs loaded

Press **Options** again to return to Program mode with the database sorted to show only those programs that fit the criteria you've selected. If you select "name", the knob will scroll you through all 250 programs in alphabetical order (The < and > buttons will jump you forward and back through letters of the alphabet.)

If you select any sorting option other than sort by name or number, the displayed selection of programs will be limited to those which fit the category. — We've made sure that all 250 of the factory programs are tagged for a variety of appropriate sorting options, so you'll find plenty to play with in each category.

**NOTE: MPX G2 programs have been designed for specific applications. Stand alone programs may not sound right if listened to through a guitar amp and vice versa.**

When you select guitar style, effect type or app type as an option and return to Program mode, the knob will scroll through the programs in the first of the categories listed in parenthesis above. The < and > buttons will jump to the next sorting category.

Assigning guitar style, effect and app types to programs is done in a database menu in Edit Mode.

Once you've made changes to a program, such as turning an effect off, or modifying any of the soft row parameters, an edit indicator in the display (\*) will appear in front of the program name. This identifies the program as having been altered since the last store procedure. This edit indicator, along with all of your changes, will disappear when you load another program.

To save your changes, press **Store**. The LED in the **Store** button will flash to let you know you are in the middle of a store procedure and the display will show:

**Program Name**  
**251 available**

The upper line of the display shows the name of the currently running program. The lower line shows a user program number (251-300) and the name of the program currently stored there. (When the MPX G2 is shipped, the user programs are all "available".)

The < and > buttons move an underbar cursor in the display from the program number to each letter of the current name. Turning the knob will select another program number, or will select alphanumeric characters when the cursor is in the upper line of the display.

Once you've made changes to the program name or selected a new location for it, press **Store** again. The display will show:

**Are you sure?**  
**Yes or No**

The numeric display will flash the user program number you have selected while you decide to press > **Yes** or < **No**. Once you have stored your program, it will automatically be added to the database and you will return to Program Load mode.

The following are stored with the program\*:

- All effects and their settings
- Effect Order and Routing Map
- Bypass state of each effect
- Insert state (if jack(s) are plugged into Insert Return(s) when the program is stored)
- Master Bypass state of the program when it was stored
- Toe Switch setting (Option)
- Speaker Sim On/Off and Cabinet
- Noise Gate settings
- Tempo settings

\* This assumes that **Reverb**, **Speaker Sim**, **Noise Gate**, **Tempo** and/or **Bypass** modes are set to **Program**. Any of these that are set to **Global**, will *not* be stored.

NOTE: If the stored program no longer meets the DataBase sorting criteria of the original version, the MPX G2 will automatically switch the DataBase setting to "Sort by number".

## Program Store

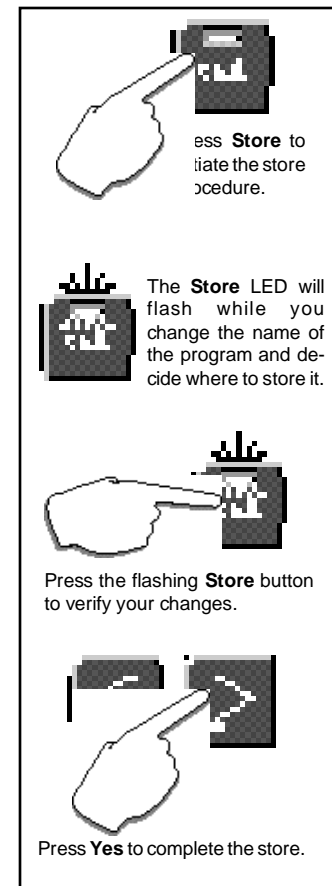



This chapter describes all of the MPX G2 edit functions. As the first thing you are likely to want to modify in a program are its effects, this section starts there and then moves on to all of the functions available in Edit mode.

## Editing

### Effect Editing

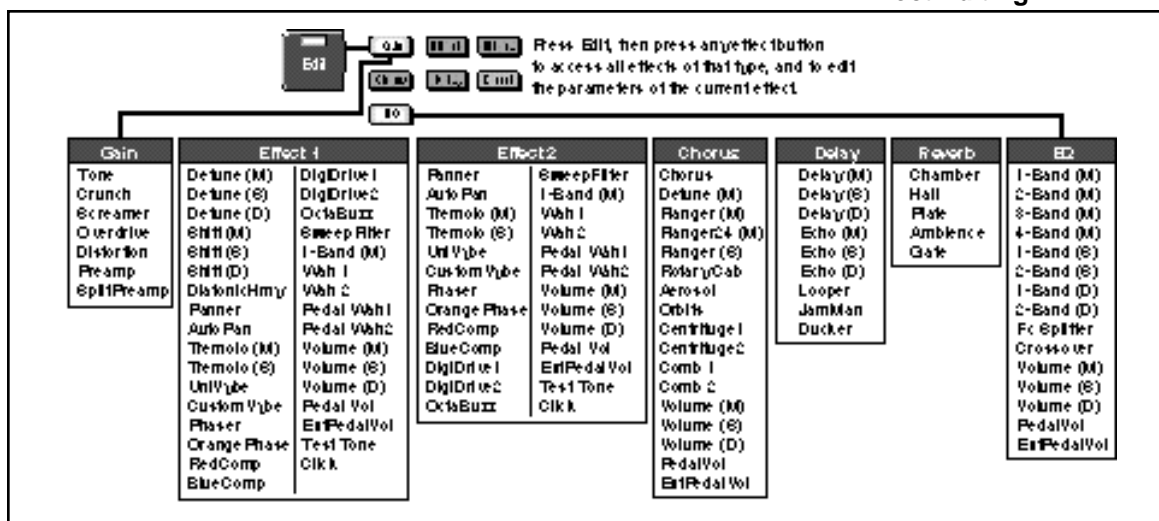

To edit any effect, press **Edit**, then press an Effect button to view all of the Effects of that type, and to edit the parameters of the current Effect. The display will show the Effect type and the name of the currently loaded Effect. Turn the knob to view other Effects of the displayed type.

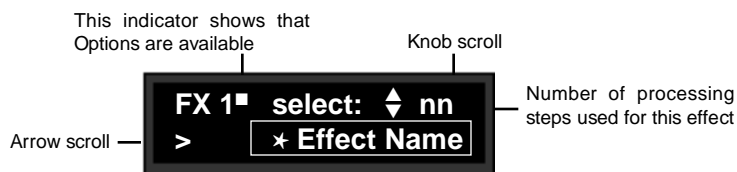

The Effect name will be marked with an asterisk (\*) and the Effect button light will blink rapidly if the displayed effect can be loaded in the current program. (Press and hold the Effect button to display the name of the Effect currently in use.)

An **X** appears in place of the asterisk if there are not enough DSP resources to load the effect. Two seconds after an algorithm is selected with the knob, the following screen will appear briefly, showing the number of resources available:

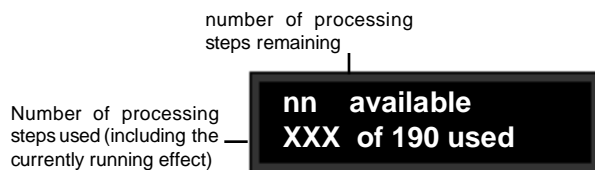

**Coarse and Fine Editing of ms and Hz values**

Parameters whose values are displayed in ms or Hz have overall ranges of more than 1000 units. When you select one of these parameters for editing, you'll notice that either the left or right portions of the value can be selected for editing. For quick, coarse adjustments, select the left portion of the value. For fine adjustments, select the right portion of the value. The fine and coarse increments for each type of parameter are:

**ms (delay times)**

coarse increments=100 ms  
fine increments=1ms

**Hz (LFO rates)**

coarse increments=1 Hz  
fine increments=.01Hz

**Hz (EQ Fc)**

coarse increments=100 Hz  
fine increments=1Hz

If there are not enough resources available to load the effect you want, another effect must be removed from the program to make resources available.

To load any available Effect, press the Effect button again. The asterisk will disappear from the displayed name and the button light will return to its normal slow blinking edit state. An edit indicator is displayed to indicate that the active program has been modified.

To edit the parameters of the current effect, press > . The display will show one or more parameters as shown below.

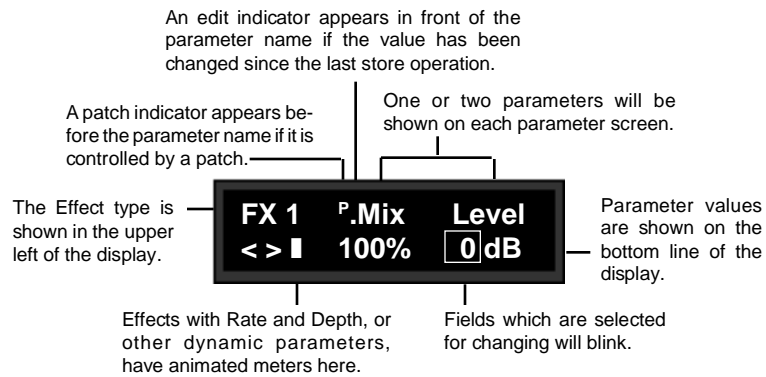

The item on the lower line of the display which is selected for adjustment will flash. Turn the knob to scroll through the entire range of parameter values. Use the < and > buttons to select another parameter value field and to move to another parameter screen.

Detailed information on each Effect and its parameters is provided in Chapter 7.

Press **Edit** to return to the main Edit menu.



Press **Options** to set the MPX R1 Toe Switch to control Bypass of the effect, or to disable the Toe Switch.

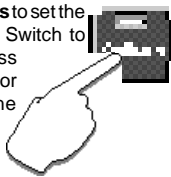

**Effect Select Option: Toe Switch (when an MPX R1 is connected)**

When an MPX R1 MIDI Remote Controller is connected to the MPX G2, the Toe Switch option allows you to use the R1 Toe Switch to turn the effect you are editing on, to bypass it, or to specify that the Toe Switch have no effect.

This powerful feature allows you to group different effects to be turned on or off whenever the MPX R1 Toe Switch is pressed. For example, set **Wah** for **Off=Bypass** and set **Chorus** for **On=Bypass** to switch between a Wah and Chorus whenever the Toe Switch is pressed.

To assign a Toe Switch function to an effect you are editing, press **Options** from the **FX select:** display. Use the knob to select **On = Bypass**, **Off = Bypass** or **disabled**. Once you have made your selection, press **Options** again to return to Effect Edit mode.

The MPX G2 Edit menus give you access to all of the controls you need to create your own programs. Whether you want to view the meter display, re-route the effects in a program, or create an entirely new sound, you will find the tools you need in this section.

## The MPX G2 Edit Menus

The complete Edit mode menu structure is shown below, followed by detailed explanations of each main menu selection.

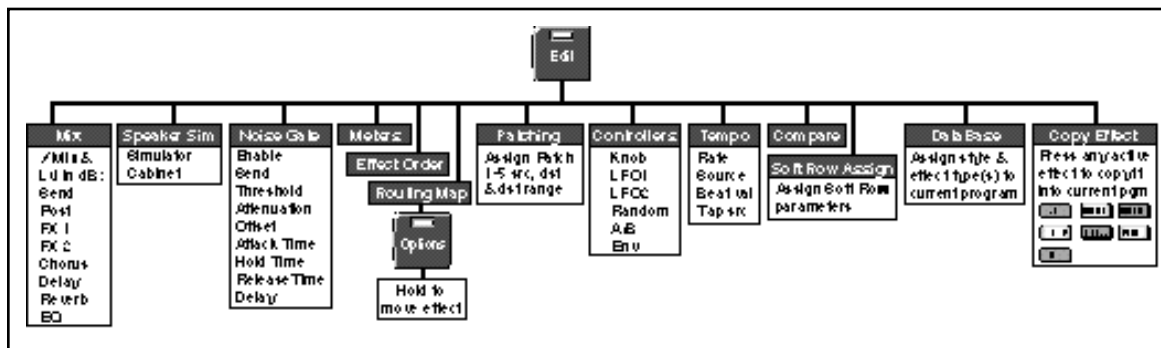

Press **Edit** to enter the main **Edit** menu. Use the knob to select the particular submenu you want (**Mix**, **Speaker Sim**, etc.).



Use the < and > buttons to enter the submenu and select parameters, and the knob to adjust parameter values. Press **Edit** again to return to the main **Edit** menu.

Each of the Edit submenus is discussed in the following pages, in the order they appear in the Edit menu.

**Mix** Press **Edit** to enter the main **Edit** menu and use the knob to select **Mix**.



The display will show Mix and Level labels on the upper line, and the current settings on the lower line. One of the values on the lower line will be flashing to let you know which is selected for adjustment. Use the < and > buttons to select Send Level, Post Mix and Level, or to step to the Mix and Level controls for any active effect in the currently running program. Use the knob to adjust the flashing parameter value.

Use > to step to the **Level** parameter, or to step forward to the next screen of **Mix** and **Level** parameters.

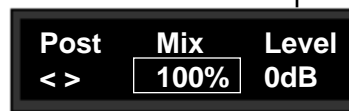

The knob will adjust the flashing parameter value.

**Adjusting Pre-Gain and Post-Gain Level**

In the MPX G2, both the pre-gain and post-gain paths have independent programmable level controls. Be sure to read about MPX G2 signal flow in Chapter 1.

The Send parameter controls the level of the Pre-Gain signal leaving through the rear panel **Send** jack. When the front panel **Input** knob is set correctly (with the **Clip** LED lighting only occasionally during your loudest playing), a Send Level of 0dB will match the level of the Unity Gain Relay Bypass.

The main purpose of this control is to allow you to match the overall Pre-Gain effects level with the level when the Pre-Gain path is bypassed. It can also be used to provide clean boost to add additional punch to kick a clean amp into overdrive.

**Send Options: Send Byp Level**

This parameter controls the Send output level during the transition between two programs when a new program is loaded — to allow you to smooth out any volume differences that might occur during program load. For most programs this level should be set to 0dB.

The Post-Gain path also has programmable effects and bypass levels. The Post Level parameter sets the overall level of wet (effects only) signal. It can add as much as 6dB of additional gain.

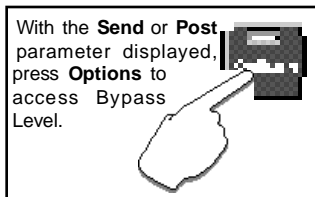

**Post Options: Post Byp Level**

This parameter sets the output level of the Post Gain path when it is bypassed. A setting of 0dB corresponds to unity gain.

These parameters allow you to match Post-Gain effects and bypass levels so that transitions between bypass states and program loads will be smooth. For most programs the Post Byp Level should be set to 0dB and the Post Level parameter should be changed to match the bypass level.

The MPX G2 has a programmable analog speaker simulator which is located between the pre- and post-gain paths. When used as a stand alone processor, the speaker simulator is connected to the output of the MPX G2 analog preamp.

The speaker simulator can be set to **Global** or **Program** mode. When set to **Global**, the current speaker simulator settings will be active for all programs when they load. (This is a quick way to turn the speaker sim on or off for all programs.) When set to **Program**, each program will load with its own Speaker Sim settings.

When the speaker simulator is active, a small speaker icon appears in the Program display.

Be aware that the factory programs that use the speaker simulator were designed to sound best when the MPX G2 is used as a stand alone processor. These will sound overly dark if used through a guitar amp and speaker cabinet. (Just turn Speaker Sim off if you want listen to them through a guitar amp.)

Likewise, factory programs that don't use the speaker simulator will sound best through a guitar amp. Programs that use a gain effect and don't use the speaker simulator will sound harsh when you listen to them directly through headphones or at a console. (Turn Speaker Sim on to listen to these programs direct.)

There are 4 cabinet designs to choose from: Combo1, Combo2, Stack 1 and Stack 2.

- Combo 1 is an open-back cabinet with 10" speakers.
- Combo 2 is an open back cabinet with 12" speakers.
- Stack 1 is closed back with 12" speakers.
- Stack 2 is closed back with 10" speakers.

Each cabinet can loaded with one of four speaker types: Bright, Normal, Warm, and Dark.

## Speaker Sim

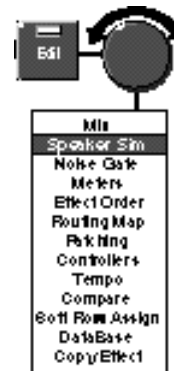

NOTE: You can use the simulator to process the output of an external preamp by simply connecting the external preamp to the MPX G2 Return jack(s). The speaker simulator is a mono circuit. When both returns are used, they are summed to mono within the speaker simulator.

See diagrams on the following page.



### Automatic Speaker Sim Routing

All routing to and from the Speaker Simulator is automatic, based on which Insert Return jacks are used and whether or not Split Preamp is loaded into the Gain effect block.

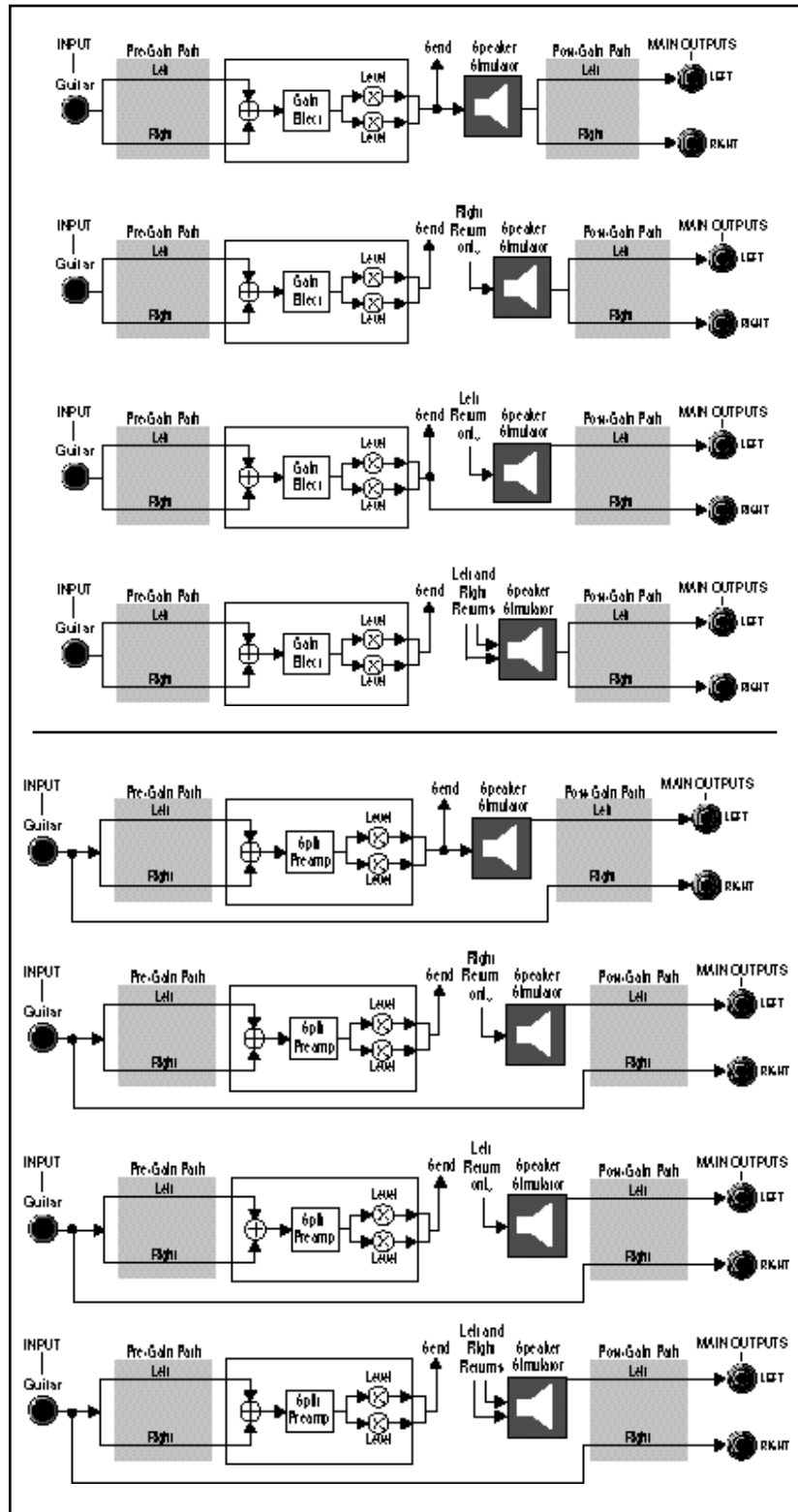

The MPX G2 has two integrated noise gates, one analog and one digital. Both are driven by the direct signal. The gates share a common set of parameters and can be used independently, or combined to create a “super gate”.

The analog gate is the final output stage of the MPX G2 pre-gain Insert Send path. This allows you to gate the analog signal connected to your guitar amp. The attack and release times of the analog gate are fixed (both are preset to be very fast).

The digital gate is located on the post-gain path, immediately after the Insert Returns. This stereo gate allows you to gate the effects Send signal coming from an external guitar preamp before it is processed by any post-gain effects such as reverb or delay. (This means that reverb and decay tails will ring out naturally when the gate shuts down.) The digital gate is driven by the same pure guitar signal as the analog gate, so both gates have the same sensitivity to light touch — no matter how many effects the guitar is going through.

When the MPX G2 is connected in front of an amp and/or in the effects loop, these two gates form an integrated noise reduction system that provides more than 120dB of attenuation. When the G2 is used with amp input only, the analog gate provides 40dB of attenuation. When the MPX G2 is used as a stand alone processor, the digital gate provides 90dB of attenuation.

### Noise Gate

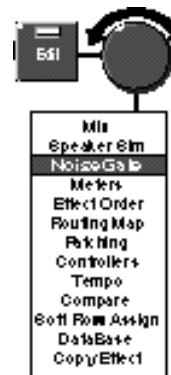

Given a choice, many players prefer not to use gates of any kind as they can affect tone and playing style dynamics. In live and recording situations where high-powered amps are pushed hard, however, the use of a gate is sometimes unavoidable. (If a player uses stomp-box effects in front of the amp, and rack effects in the effects loop, two gates are required: one between the amp input and the last stomp box in the effect chain, and another on the amp's effects send to gate noise before it hits the rack processors.)

In a component system, the gate is driven by the *processed* guitar audio — which means that the threshold must be set quite high to compensate for all of the noise added by the pre-gain effects (wah, compressor, overdrive, etc.). You have to play pretty hard to get the gate to open up, and sustained notes are noticeably chopped off.

As the MPX G2's analog gate is driven by the *unprocessed* guitar, the threshold can be set much lower, creating a sensitive gate that opens up with a very light touch and which remains open considerably longer during sustaining notes and chords. It also makes it possible to use the guitar's volume control to control the gate directly.

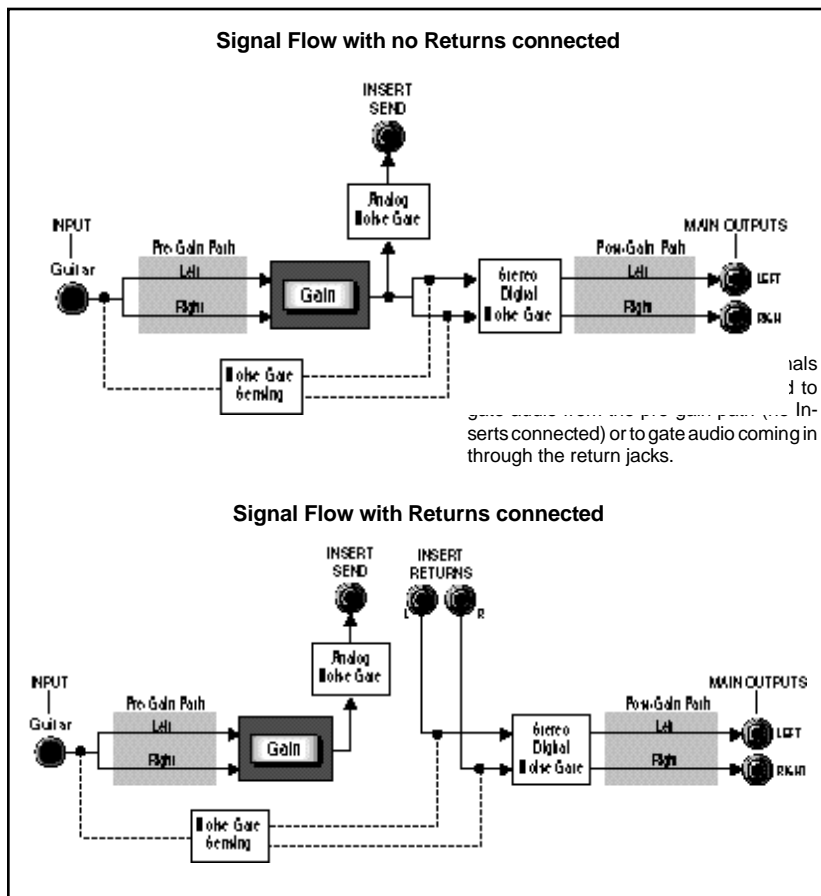

Both the analog and digital noise gates share the same sensing — which can be set to either **Guitar Input** or **Return Only**.

**Meters**

The G2 has a built-in meter array that allows you to simultaneously view guitar input level, main output levels as well as the levels of all individual effects blocks, except Gain.

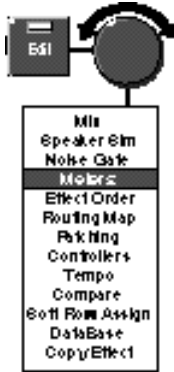

The meters are displayed in fixed order: Input, Effect 1, Effect 2, Chorus, Delay, Reverb, EQ, Output.

Effect blocks are indicated by their number or initial letter.

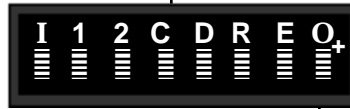

Each effect block has a 7-segment with an overload indicator (A + at the top of the meter block).

Each block's output level is shown with a 7-segment meter. Overload is indicated by displaying a plus sign on the top right side of the individual meter.

Use the meter display to check levels throughout the effect chain, or to track down overload in an individual effect.

Selecting **Effect Order** from the Edit menu allows you to put the seven MPX G2 Effect blocks in any order you wish. Press > to display the current ordering and routing configuration. An ordering display such as the one shown below will appear.

An underscore identifies the Effect block which is selected for moving to a new location.

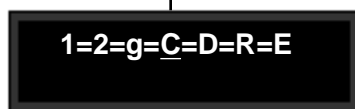

Effect types are represented by their initial letters or numbers. Upper case letters and large numbers indicate that the Effect is active in the current program. Lower case letters and small numbers indicate that the Effect is inactive.

### Effect Order

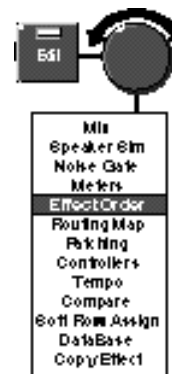

Each Effect block is represented by a single letter or number, an upper case letter or large number if the Effect is active in the current program, a lower case letter or small number if it is not. The symbols between each letter indicate the current routing connection options. An underscore identifies the Effect block that is currently selected for repositioning. (In the example shown above, the Chorus block is selected.) To move the selected block to a new position, simply turn the knob. Use the < and > buttons to select (underscore) a different Effect block for repositioning.

Using the same example, turn the knob two clicks to the right to move the Chorus block and alter the Effect Order as shown below.

The Chorus block is selected for repositioning.

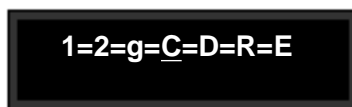

Turn the knob one click to the right to swap the Chorus block with the Delay block.

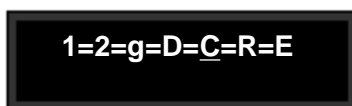

Turn the knob one more click to the right to move the Chorus block another step to the right.

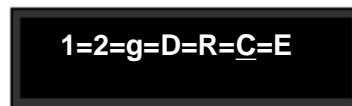

Press **Edit** to return to the main **Edit** menu.

### Routing Map



The MPX G2 allows you to reconfigure the effect blocks along audio paths of your own design. The Routing Map is a graphic display that shows routing and connections between the MPX G2 effect blocks. Use the Routing Map to change connections between individual effects and also to change the overall routing configuration of all seven effect blocks as a group. All of the routing controls available in the Routing Map menu are explained in this section, along with examples of the selections you can make. Remember that you can change the *order* of the effect blocks as well. (See *Effect Ordering* on the previous page.) In these examples, we'll use the default effect order to keep things simple.

Before going into the details of the Routing Map, it's worthwhile to review basic signal flow through the MPX G2.

The overall signal flow through the MPX G2 is divided into two paths: a pre-gain path and a post-gain path. The six DSP effect blocks (Effect 1, Effect 2, Chorus, Delay, Reverb and EQ) can be placed in any combination on either the pre-gain or post-gain portions of the audio path.

The position of the Gain effect block in the Routing Map determines the boundary between the two paths. The pre-gain path is made up of the Gain effect block and all effects on the path that connect to the inputs of the Gain effect. The post-gain path consists of all effects on the path connected to the outputs of the Gain effect block.

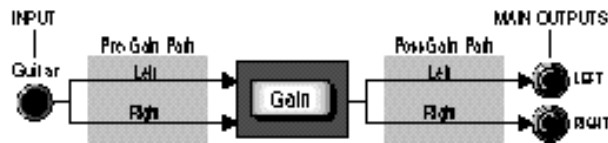

When you want to connect the G2 to external guitar amp or other gear, it is important to understand where the Send and Insert Returns are in relation to the Routing Map display. The Send jack is permanently connected to the path at a point immediately following the Gain block outputs. The Insert Return jacks are permanently connected to the path at a point immediately following the Send.

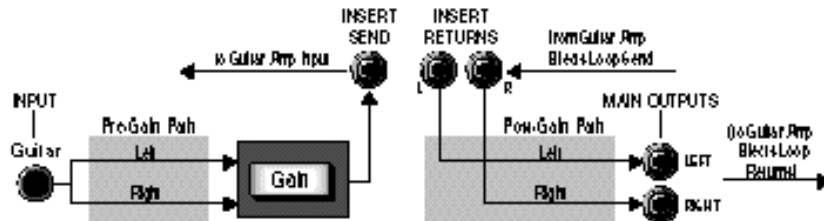

The path through an MPX G2 DSP effect block looks like this:

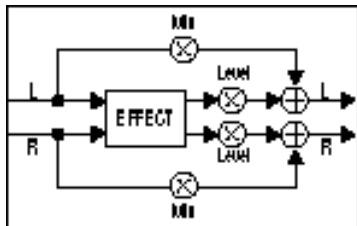

Note that the dry path through the effect is stereo, and a variable wet/dry mix is included for each DSP effect. The wet path through the effect can be stereo or mono in, and stereo or mono out, depending on the particular effect.

The path through an MPX G2 analog Gain effect is slightly different:

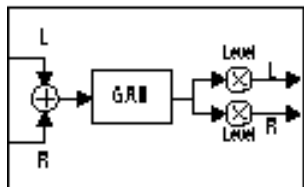

Note that there is no wet/dry mix path for the analog effects and that these effects are mono in and mono out.

Each of the Effect blocks (Effect1, Effect2, Gain, Chorus, Delay, Reverb and EQ) is represented in the following discussion as a simple box identified by its first initial (1, 2, G, C, D, R and E). This is also the way each block is represented in the MPX G2 Routing Map display. MPX G2 inputs and outputs are represented by the letters I and O.

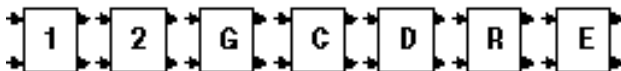

Active Effects are represented (here and in the Routing Map) by upper case letters and numbers.

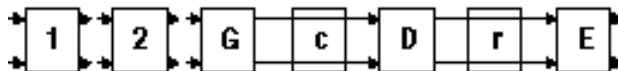

Inactive Effects are represented (here and in the Routing Map) by lower case letters and small nup).

Insert Sends and Returns are not shown in the Routing Map, but they are always located between the Gain block and any blocks that follow it.

### How to Change Routing Connections

The routing page lets you alter the connections between the inputs of the selected block and the outputs of the blocks in front of it. It is easy to think of these connections as patch cords connecting the different blocks. There are five possible connections for the inputs of any block.

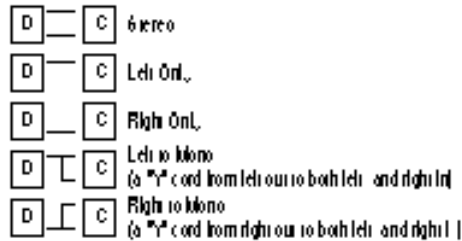

On the Routing Map, use the < and > buttons to select any upper case letter. (Lower case letters indicate inactive effects, which cannot be edited.) Use the knob to set your connection choice.

### How to Change Routing Options

The signal path within the MPX G2 can be split into two parallel stereo paths, and once split, the split paths can be merged together again. The split paths are referred to as Upper and Lower. The Routing Map options allow you to choose where to split and merge the path and to place effect blocks on either the upper or lower paths. The following examples show four general configurations: a path with no split, a split pre-gain path, a split post-gain path, and a parallel path around the pre and post paths.

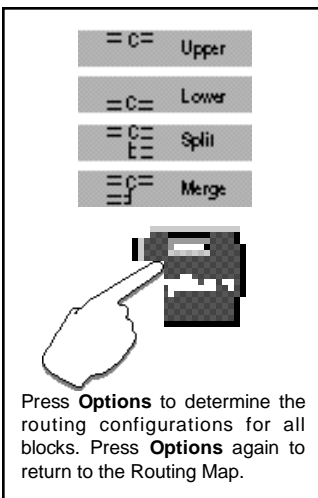

All seven effects are on the upper path.

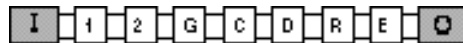

The pre-gain path is split at the input and merged at the Gain effect.

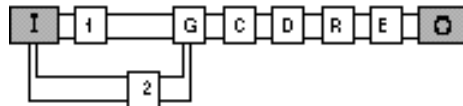

The post-gain path is split at the Chorus effect and merged at the EQ effect.

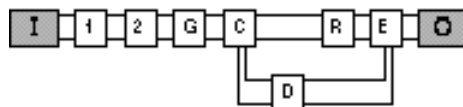

Splitting the path at the input and merging it at the outputs creates a separate path in parallel with the pre-gain and post-gain paths.



To change the routing, from the **Routing Map**, press **Options**. Use the < and > buttons to select individual blocks. Use the knob to change the configuration.

Note that the MPX G2 will only display the routing options that are available in the current configuration. For example, if all seven blocks are on the upper path, the only available option will be **Split**. The next block downstream from a Split will have **Upper**, **Lower**, and **Merge** available as options.

In the following examples we've selected three presets that demonstrate creative applications of the routing and connection capabilities of the MPX G2.

### Routing Examples

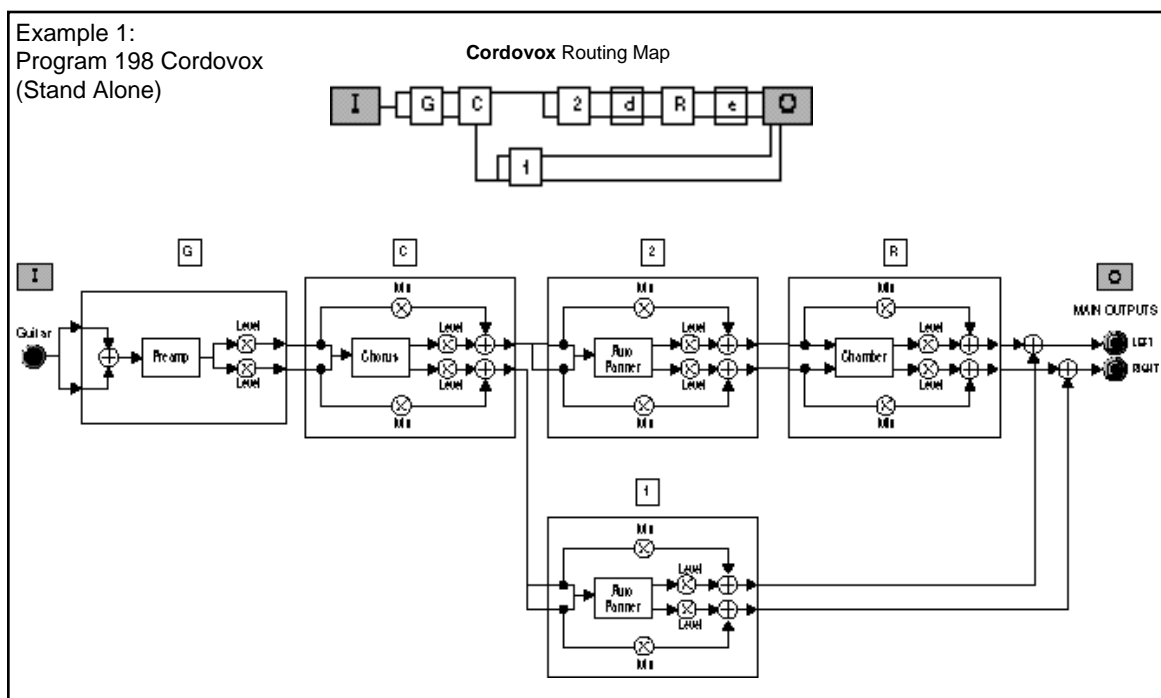

This program produces the sound of a vintage Cordovox rotary speaker. The Cordovox is a speaker cabinet containing a fixed 8-inch speaker mounted behind a rotating baffle. It projects sound out of the sides and top of the cabinet, not the front. The baffle can rotate at either fast or slow speeds. The transition time between the different rates is quite long. The characteristic swirling sound it produces is the result of doppler and panning effects combined with the limited bandwidth of the small, easy-to-distort speaker and the tone qualities of the amplifier used to drive the Cordovox cabinet.

In this program, the guitar is first routed through the Gain block, which uses the Preamp to mimic the amp and speaker characteristics. The output of the Preamp is connected to the Chorus block. The Stereo Chorus produces the doppler portions of the overall sound. The Chorus block option is set to Split, creating two parallel audio paths. Effect 1 and Effect 2 are placed on these lower and upper paths, and each is loaded with an Auto Panner effect.

Effect 2 is connected to the left output of the Chorus block and Effect 1 is connected to the right output. Each Auto Panner "sees" a different input signal and, together they produce the complex panning dynamics required to simulate the complex stereo image created by miking the cabinet with left and right microphones. The stereo output of Effect 2 is connected to the Reverb block. The Reverb outputs are summed with the outputs of the Auto Panner in Effect 1 and sent to the Main Outputs.

The A/B controller is patched to the Chorus and Auto Panner rates to allow you to choose between slow and fast speeds.



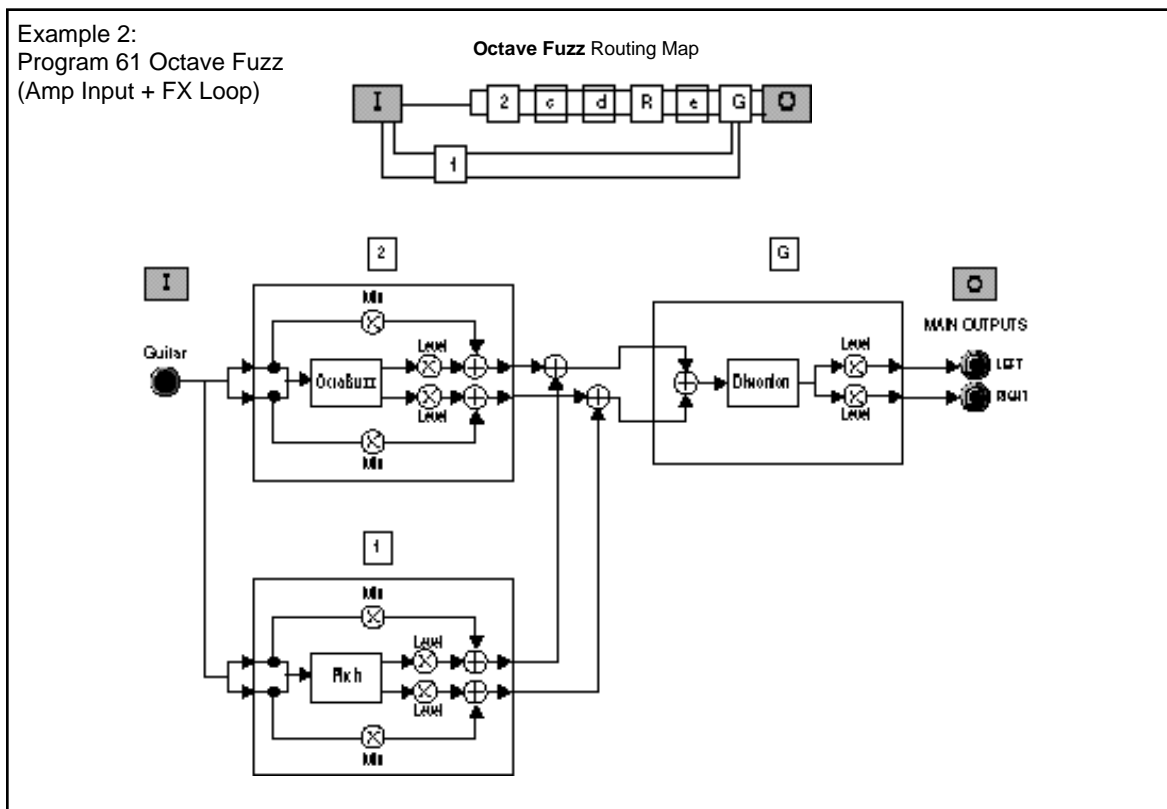

The Octave Fuzz program combines sub-octave and Octavia-style effects with analog distortion. When connected to the high gain input of a guitar amp, many classic Octave Fuzz effects can be produced.

The Input block option is set to Split, to create two parallel paths. The paths are joined together at the input of the Gain block by setting its option to Merge.

Effect 1 is placed on the lower path and Effect 2 is placed on the upper path. Effect 1 is loaded with Shift(M) and set to produce a fixed pitch shift of one octave down. Effect 2 is loaded with Octabuzz to create the Octavia sound. The use of the split path here allows each effect to be fed into the Gain block without interacting with each other.

In the Gain block, the Distortion effect is set to produce moderate-gain fuzz. A/B is set to turn the output of the sub octave on and off.

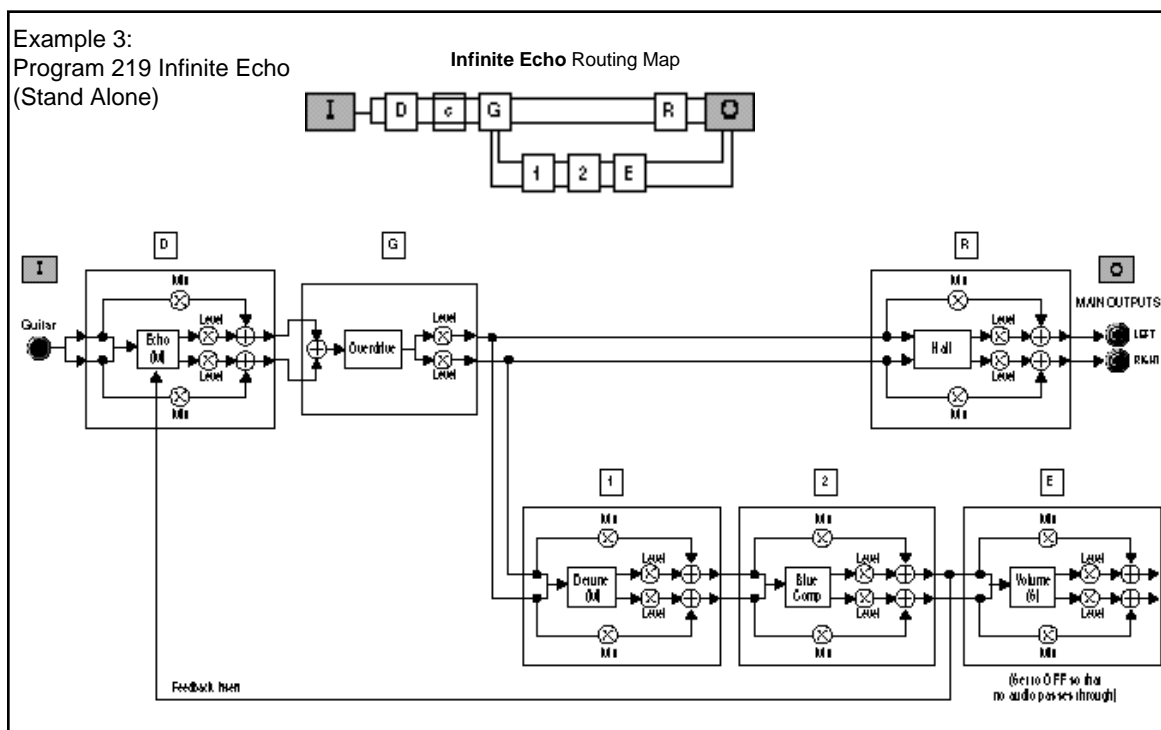

The Infinite Echo program is an analog tape delay effect with auto ducking and infinite feedback. It demonstrates the routing techniques used to create an *analog feedback path*. This unique feature of the MPX G2 makes it possible to recreate the sound of classic analog delay, chorus and flanger effects.

The guitar signal is routed through the Delay block, which is loaded with Echo(M). The Delay block output is connected to the Gain block. Here the Overdrive effect is used to impart the tone and distortion characteristics of the preamp in a vintage analog echo effect. The Gain block option is set to Split. The upper path is used as the “normal” path to the Main Outputs. The Reverb block is placed on this upper path to add some Hall reverb to the overall sound.

The lower path is used as a *feedback path to the Delay block*. It consists of a detuner, compressor and volume control, in series. The feedback path is created by setting the Delay effect Fbk Insert parameter to Effect 2. (Be sure to read about this option of the Fbk parameter in the Delay Effects portion of *Chapter 7: The Effects and Parameters*.) This creates a feedback path that flows from the output of Effect 2 back into the Echo(M) effect. The master level of the signal is controlled by the Echo(M) Fbk parameter. All of the blocks between the Delay and Effect 2 blocks are also in the feedback path. Every time the Echo repeats, the signal recirculates through the analog Gain block as well as the Detuner and Compressor.

The volume control is set to Off, so no audio from this path is passed to the Main Outputs. Also, the program is stored with the Insert bypassed to keep the guitar amp preamp out of the feedback loop in Amp Input and FX Loop applications. These tricks allows the program to be used whether connected for Stand Alone, Amp Input Only or Amp Input & FX Loop applications.

The Overdrive effect produces the analog tone and saturation of tape echo electronics. The Detuner is patched to the Random controller to add pitch fluctuations caused by the wow and flutter typical of tape delay mechanical systems. The Compressor limits the feedback signal so that it never goes completely out of control. As new notes are played, the compressor lowers the feedback level. When the playing stops, the echo repeats begin to swell in volume, but the compressor keeps the swell from going into overload. This allows feedback settings to produce infinite repeat — with the sound evolving on each repeat. A/B is patched to clear the delay.

### Notes and Tips on Routing

1. The number of configurations you can create is huge. The best approach to take is to think about what you want before changing anything.
2. When changing the routing options, work from left to right — from the input block to the output block.
3. The MPX G2 will only display the routing options that are available in the current configuration. For example, if all seven blocks are on the upper path, the only available option will be **Split**. The next block downstream from a Split will have **Upper**, **Lower**, and **Merge** available as options.
4. The MPX G2 automatically updates the routing options downstream from the selected block as necessary. For example, if you change a **Split** path to **Upper**, all of the following blocks will be set to **Upper** as well.
5. You can also move effects while the Routing Map is displayed:

Press and hold **Options**. After about two seconds, the display will show **Move effect**. Continue to hold down the **Options** button and select the effect block you want to move with the < and > buttons. Turn the knob to drag the selected effect to a new position.

### Patching

The Edit mode Patching menu allows you to control effect parameters in real-time from a variety of external, MIDI and internal controllers. This important topic deserves its own chapter and is covered in Chapter 4.

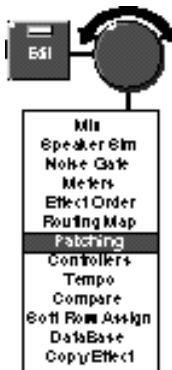

This Edit menu selection provides controls for making individual adjustments and assignments for each of the MPX G2 internal controllers: **Knob**, **LFO 1**, **LFO 2**, **Random**, **A/B** and **Env**. This section describes controller editing. For detailed information on the controllers themselves, see Chapter 8.

### Controllers



Making controller adjustments is straightforward. The first of the controller selections (**Knob**) is shown here as an example. (Although each controller has a different set of parameters, the method for selecting and adjusting them is identical.)



Use the < and > buttons to step through the available parameters of the selected controller and the knob to adjust controller settings.

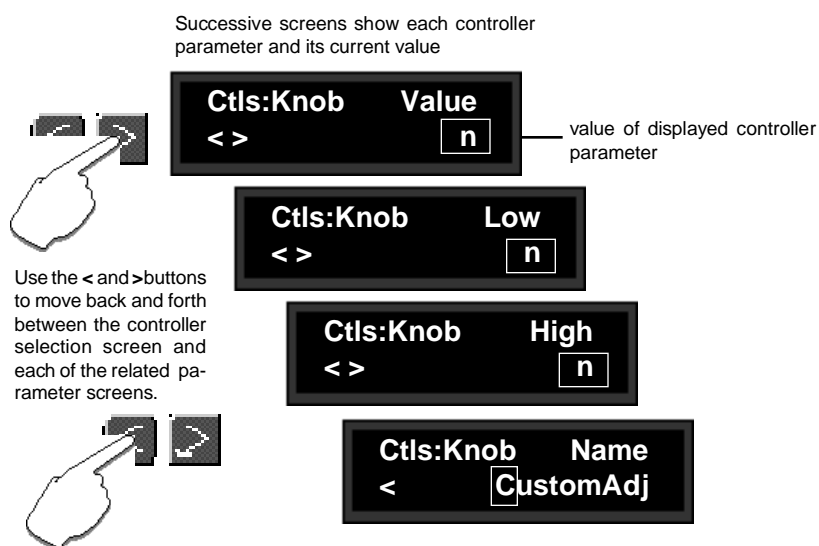

Once you have adjusted the selected controller to your satisfaction, you can step back through the parameter screens, or press **Edit** to return to the main Edit menu.



**Tempo** The parameters in the **Tempo** menu: Rate, Source, Beat Value, Tap Average, Tap Source and Source Level, allow you to select the way in which the actual tempo in BPM is determined for each effect.

The MPX G2 gives you unique control over tempo. In the MPX G2, any delay parameter and any time-based modulator (LFO, etc.) can be individually assigned to an absolute time value, or assigned to a tempo value.

For example, a delay time can be set to a specific number of milliseconds, and you will always get a delay of that number of milliseconds, regardless of tempo changes. Alternatively, a delay time can be set to a specific ratio of echoes to beats. Now, if you create a rhythmic echo pattern, delay times will be linked to tempo. When you change tempo, the delay time will change to maintain the same rhythm at the new tempo.

With the LFOs, the rate of change can be an absolute value (such as once per second), or it can be linked to tempo (for example, once every four beats). Any delay parameter or LFO rate can be set to its own individual rhythm, allowing you to set up an effect which will change in a rhythmically interesting way — evolving over time, for example, as opposed to being a mere series of repetitions. Once delays and LFO rates are assigned, tempo rate can be easily changed in a variety of useful ways.

Tempo **Rate** can be set internally or via MIDI Clock. If Tempo **Source** is set to **Internal**, you can dial in any tempo from 41-400 BPM, or you can press the front panel **Tap** button twice in rhythm to establish the rate you want (allowing you to change tempo on the fly from any mode). You can also have the value of a patch source act as a tap trigger (See Chapter 4: *Patching*.) or choose to have your tempo transmitted as a MIDI Clock signal to control the tempo of connected MIDI devices. (See Chapter 5: *System Controls* or Chapter 6: *MIDI Operation*.) If **Source** is set to **MIDI Clock**, MPX G2 tempo will sync to incoming MIDI Clock. Whether tempo is set internally or via MIDI, the front panel **Tempo** LED will flash at the current rate whenever any delay or LFO rate is set for tempo control.

MPX G2 programs can have their own tempo rate settings which are stored with the program. You can override these individual tempo rates with a global tempo rate in the System Setup menu. Tempo is also available as an independent patch source which can control any program parameter. (See Chapter 4: *Patching* and Chapter 5: *System Controls*.)

**Rate** This is the current tempo (in beats per minute). When **Source** is set to **Internal**, you can select any rate here from 41 to 400 BPM. The **Tempo** LED will flash at the new rate. Fractional tempos can be tapped in, but the display will always show the nearest whole number value.

**Source** You can choose to have tempo determined by the MPX G2 **Tap** and **Rate** controls (**Internal**), or by MIDI Clock (**MIDI**). **Tap** also acts as a reset, setting the downbeat of the LFOs.

Tempo is expressed in BPM. This control allows you to specify the value of the beat (Eighth, DottedEighth, Quarter, DottedQuarter, 2-126 Beats). If, for example, you select **EighthNote** here, each **Tap** will be interpreted as an eighth-note. If you select **QuarterNote** here, each **Tap** will be interpreted as a quarter-note. (The factory default is **QuarterNote**.)

**Beat Value Option: Tap Average**

Press **Options** to access the **Tap Average** control which allows you to average the last 2-8 Taps. Higher numbers mean that the response to incoming Taps will be more gradual, as the tempo will be updated on each Tap with an averaged value.

**Beat Value**



Assign the **Tap** function to any of the MPX G2 Internal, MIDI or MIDI controllers (None, Off, On, Knob, Puls1, Tri1, Sine1, Cos1, Puls2, Tri2, Sine2, Cos2, Rand, Env, A/B, ATrg, BTrg, ABTrg, Pedal, Tog1, Tog2, Tog3, Sw1, Sw2, Sw3, CC1-31, CC33-119, Bend, Touch, Vel, Last Note, Low Note, High Note, Tempo, Cmnds, Gate, Trig, LGate, Toe).

**Tap Source Option: Tap Source Level**

Press **Options** to access the **Tap Source Level** control which allows you to set the level (0-127) at which the Tap function is triggered.

**Tap Source**

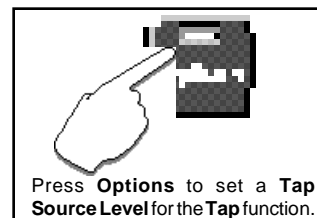

Whenever you edit an MPX G2 program, an edit indicator will appear in Program mode, in front of the program name on the display to let you know that the program has been changed since the last store operation.

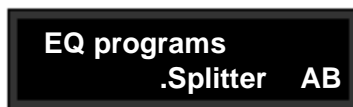

In Program mode an edit indicator appears before the program name if the program has been changed since the last store operation.

To hear the original version, press **Edit** to show the **Edit select** screen. Turn the knob to display **Compare**.

Press the **>** button. If the program has not been edited, the message **Pgm is unchanged** will be displayed. If the program has been edited, the display will change to show:

**Compare**

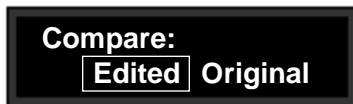

Use the **<** and **>** buttons to select and hear your edited version, or the original. To exit, press **Edit** to return to the main **Edit** menu.

**NOTE:** If you exit with **Original** selected, you can view the original program parameters, but cannot edit them. To continue editing, exit with **Edited** selected.

### Soft Row Parameter Assignment



Parameters that you want to assign to the Soft Row for easy access are selected from the Edit mode **Soft Row Assign** menu. Use the < and > buttons to select any of the ten Soft Row positions. Turn the knob to scroll through and assign parameters to the selected position. (All parameters in the current program are available for assignment. The example below shows the FX 1 Level parameter assigned to the first position in the Soft Row.)

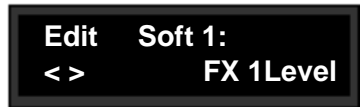

Your selections are immediately available for quick editing whenever the front panel **Soft Row** button is pressed.

### DataBase Assignments



The MPX G2 allows you to individually tag all 250 programs for easy sorting by Style and/or Effect and Application type. The **DataBase** controls in the **Edit** menu let you assign your programs to any (or all) of the categories shown below.

- Guitar Style: Acoustic
- Bass
- Blues
- Clean
- Country
- Jazz
- Rock
- Effect type: Chorus
- Delay
- Distortion
- EQ
- Flanger
- Gain
- Mod
- Overdrive
- Phaser
- Pitch
- Reverb
- SpkrSim
- Wah
- All
- App type: StdAlne
- Amp In
- FX Loop

When you select **DataBase**, the display will show a selection like the one below.

The upper line identifies the selection category  
(guitar style, effect type or application type).

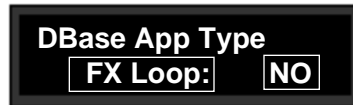

The lower line shows the Style, Effect or Application type and the current DataBase selection (YES or NO). The selected field will flash to let you know which is selected for changing.

The item on the lower line of the display which is selected for adjustment will flash. Use the < and > buttons to move between the display fields. Use the knob to scroll through all of the Source and Effect types in the left field, and to select **YES** or **NO** in the right field.

If you make changes in the **DataBase** menu, when you exit, the **Store** LED will



flash and the following message will be displayed.

Press **Store** to save your changes to the DataBase. Press any other button to exit with the DataBase unchanged.

Press **Edit** to return to the main **Edit** menu.



### Copy Effect

Copy Effect lets you take an Effect from any program in the MPX G2 and copy it into the current program. To use this function, select **Copy Effect** from the Edit menu. Press the > button and use the knob to display any of the MPX G2 programs. The front panel Effect buttons light to show you which effect blocks are active in the displayed program. Press any lit button to display:



The name of the effect from the displayed program appears on the upper line.

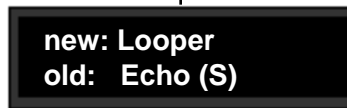

The name of the effect you will be replacing in the current program appears on the lower line.

The effect button will flash to show that it is selected for copying. Press it to copy the effect you selected into the current program. If the copy procedure is successful, a confirmation message will be displayed briefly, and the display will revert to showing the Copy Effect selections.

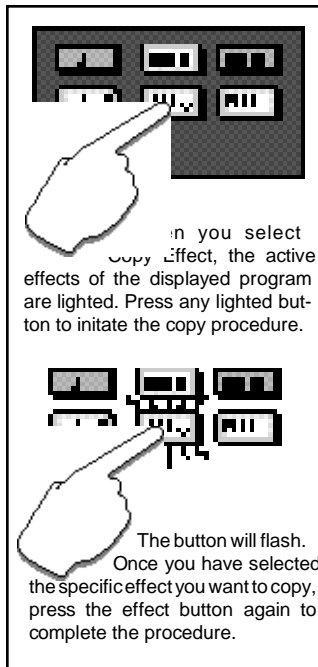

As different effects vary widely in the amount of processing they require, not all combinations of effects are possible. If the current program is already using many effects, or if it is using a combination which requires maximum processing power, a message will be displayed informing you that there are not enough resources to run the effect you have selected. If this happens, you can try copying another effect, or you can copy an inactive effect (by pressing an unlit button running "No Effect") to reduce the processing requirements.

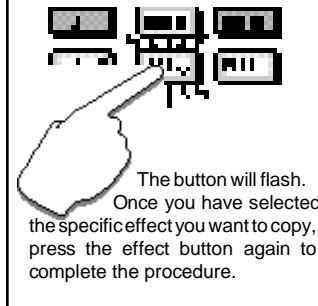

Note that patches are not copied along with effects.

Press **Edit** to exit to the main **Edit** menu.

# 4

## Patching

Patching is the ability to assign a control (Source) to a parameter (Destination). This allows you to alter the value of the parameter by manipulating the control Source. For example, you can select the front panel knob as a Source and an effect's Mix parameter as a Destination. This simple patch will allow you to dynamically alter the mix of the effect whenever you turn the knob.

You can create as many as five patches. You can patch multiple parameters to a single Destination. This chapter contains all the information you need to use the MPX G2 program patching system. Global Patching is described in Chapter 5: *System Controls*.

MPX G2 Patch controls are accessed in **Edit** mode.

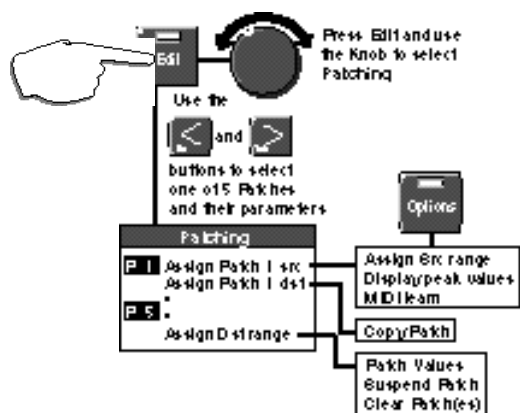

In the **Edit** menu, select **Patching** to access the patch assigned to a displayed parameter, or to create or alter a patch.

When a Patch is selected, the display will show:



The numeric display will show the Patch number you have selected.

The Patch number you select in the alphanumeric display will be displayed on the large numeric display as well. This display will remain on as long as you are in the Patching System to identify the currently selected patch.

### Selecting a Source and Destination

From the patch number display, press > to step to the patch Source and Destination assignment screen. The display will show the current Source assignment on the top line, and the current Destination assignment on the bottom line. One of the assignments will be flashing to let you know which is selected for adjustment. Use the < and > buttons to select the Source assignment field, and the knob to select a Source from the available list.

**Patch Sources**

All Sources are the same in the sense that each generates an output value in the range of 0-127. The output value is used to increase or decrease the setting of a Destination parameter value. Some generate values continuously (they're always "on" ); some generate output based on the position of a particular external MIDI controller, or a footpedal, or footswitch. Some Sources generate output based on aspects of physical performance such as how loud, how fast, or how hard you play. The MPX G2 allows you to choose a Source for each Destination from the following list.

Patch Sources	
Ctls: Off	MIDI: CC 1
On	•
Knob	•
Puls1	•
LFO1 { Tri1	CC31
Sine1	CC33
Cos1	•
Puls2	•
LFO2 { Tri2	•
Sine2	CC119
Cos2	Bend
Rand	Touch
Env	Vel
InLvl	Last Note
RnLvl	Low Note
A/B	High Note
ATrg	Tempo
BTrg	Cmnds
ABTrg	Gate
Pedal	Trig
Tog 1-3	LGate
Sw 1-3	Tsw
	Toe

Sources are displayed with the prefix **Ctls** or **MIDI**. **Ctls** are internal MPX G2 controllers and rear panel switches and pedal inputs. **MIDI** sources are all designated MIDI controllers.

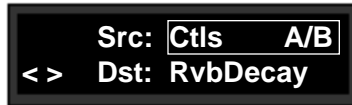

In this example, the Source assignment field is selected. The knob will scroll through all of the available Source selections.

From the same screen, use the < and > buttons to select the Destination assignment field, and the knob to select a Destination from the list of parameters of the currently loaded program.

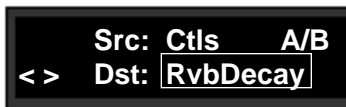

With the Destination assignment field selected, the knob will scroll through all of the parameters of the currently loaded program.

For most applications, that's all there is to setting up a patch. The default patch values will set the controller to match the full range of its travel to the full range of the Destination parameter. To customize your patches, the MPX G2 provides a full set of additional controls. Each of these is described in the following sections.

With **Src** selected, pressing **Options** will allow you to specify range limits for the controller you have selected. With the following screen displayed, use the **<** and **>** buttons to select the **Min**, **Mid** or **Max** field, and the knob to set the value from 0-127. The default settings of Min=0 and Max=127, cause the parameter to be controlled linearly by the controller. Reversing these values (Min=127 and Max=0) will establish inverse control over the parameter. Adding a Mid value allows you to put a pivot point in the patch. All patches have default settings of Min=0, Max=127, with no Mid values assigned.

### Changing the Range of the Source Controller



In this example, the underscore indicates that the Min value field is selected. The knob will select values from 0-127. Press **>** once to select the Mid field, once again to select the Max field.

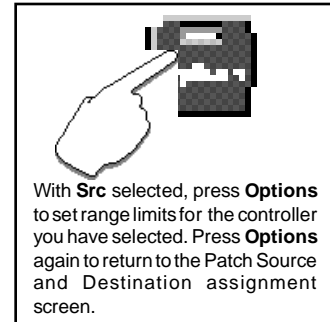

From the Src Value screen pressing the **>** button beyond the Max value field selects a reference screen where you can view the actual behavior of the controller you've selected.

### Viewing Source Controller Activity

With the Max value field selected, pressing **>** will forward you to the Source Activity screen.

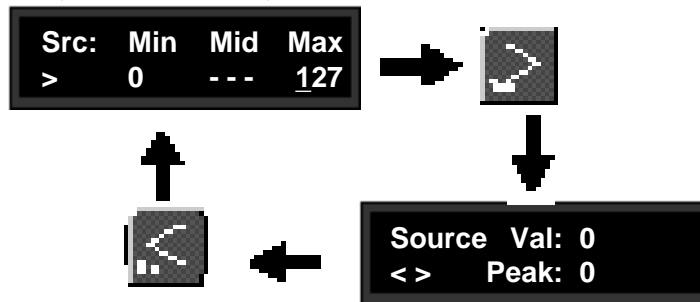

Press **<** to return to the Source Value screen.

The Source Activity screen lets you reference actual controller values to help you determine the most useful range.

The Source Activity screen displays the actual activity of the controller you have designated as the Patch Source. Moving the controller will allow you to view the actual controller value in real time (**Val**). The peak controller value is referenced on the lower line (**Peak**). This lets you quickly determine the most useful range settings for the controller.

For example, if you have selected Input Level as the Source, and you notice from the Activity screen that the actual level never rises above 100, you can quickly back up to the Src Value screen (press **<** once) and set the Max value to 100.

### MIDI Learn — Automatic Controller Assignment

You can have the MPX G2 automatically recognize a MIDI controller as a patch Source, as well as assigning its MIDI Receive channel to match any controller with the **MIDI Learn** function.

From the Source Activity screen, press **>** to access the **MIDI Learn** screen. With this screen displayed, simply move any active MIDI controller to automatically assign it as the Source for the current patch. The MPX G2 will also recognize the MIDI channel of the controller and reset to that channel for receipt of all incoming MIDI messages.

From the Source Activity screen, press **>** to access **MIDI Learn**.

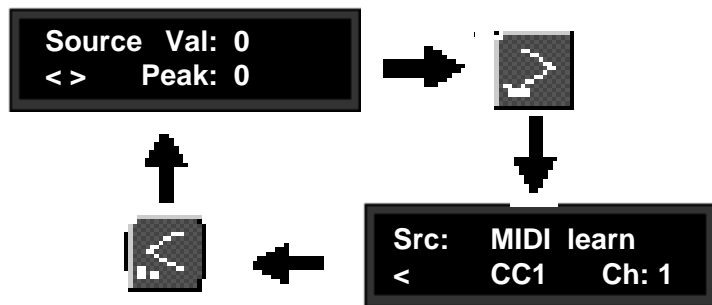

Press **<** to return to the Source Activity screen.

Simply move any attached MIDI controller to have the MPX G2 recognize it as the patch Source and switch to its MIDI channel. This example shows the result of moving a Mod Wheel (CC1) on a connected MIDI device transmitting on Channel 1.

From the **MIDI Learn** screen, press **<** repeatedly to step back through the Patch Source Options. Press **Options** to return to the Source and Destination assignment screen.

### Copying Patches

From the Source and Destination assignment screen, selecting **Dst** and pressing **Options** will allow you to copy any other patch to the patch you are working on. With the following screen displayed, use the knob to select patch 1-5, or **—** to leave the current patch unchanged.

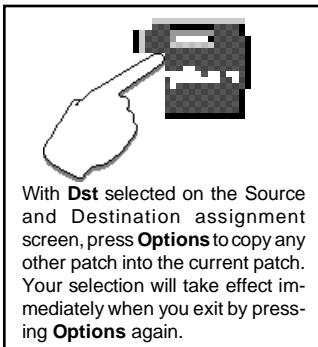

In this example, **—** indicates no patch information is to be copied. Other selections (1-5) will automatically copy information from the indicated patch to the current patch when you exit **Options**.

## Changing the Range of the Destination Parameter

For most applications, the default full-range Destination values are all you will want, as these allow your selected Source to exert direct control over the full range of parameter values. In other cases, you may want to adjust the Destination values to a more limited range, or establish a nonlinear relationship between the controller and the parameter values.

With a Destination assigned, and the Destination field selected, press > to display the first of two Patch Value screens where you can set Min and Max limits for the selected parameter. With **Max** selected, press > again to display a Mid Point selection screen where you can set a pivot point within the Destination parameter range to allow nonlinear control. (Note, that a Mid point must be assigned to the Source range, before a Destination Mid point is recognized. See Page 4-3.)

With the Destination assignment field selected, press > to display the Destination value screen.

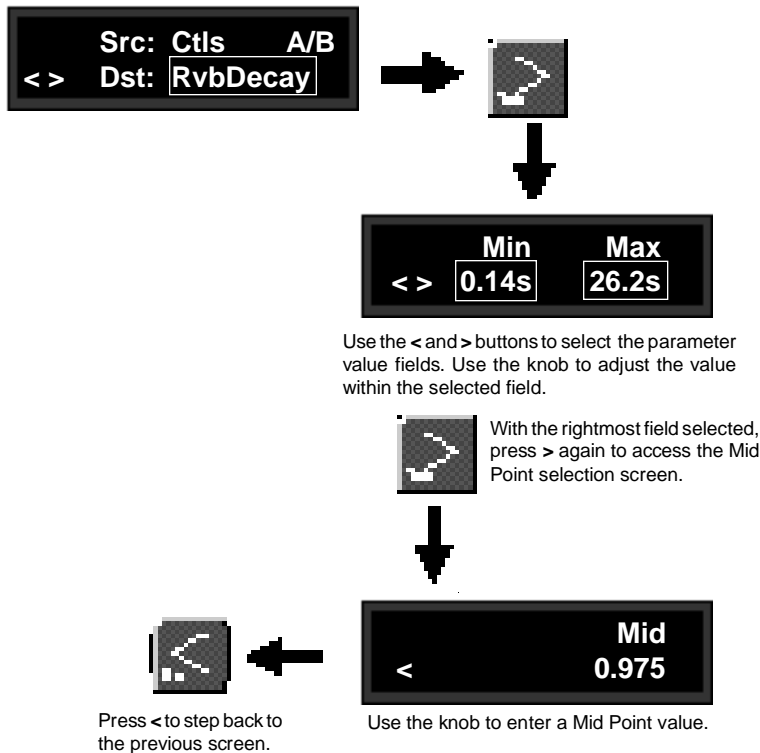

**Linear or Nonlinear Control**

From either of the Destination Values screens, pressing **Options** will allow you to set the control relationship between your Source and Destination, temporarily suspend the current patch, or to clear one or more patches entirely.

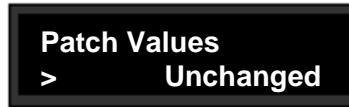
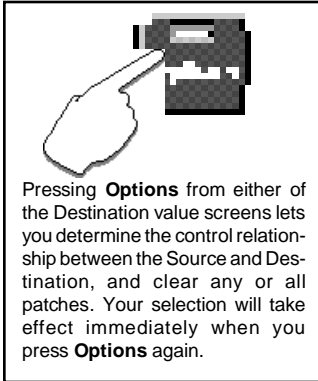

"Unchanged" is provided as a selection to allow you to exit **Options** without altering or erasing any patches. Pressing > will step you forward through the other options.

As selections made in **Options** will take effect immediately when you press **Options** to exit, the first screen, "Unchanged", gives you the choice of exiting without altering or erasing any patches.

Press > to step through the other control selections: **Normal**, **Inverted**, **Mid Peak**, and **Mid Dip**. These let you set the control relationship between the controller and the parameter as described below.

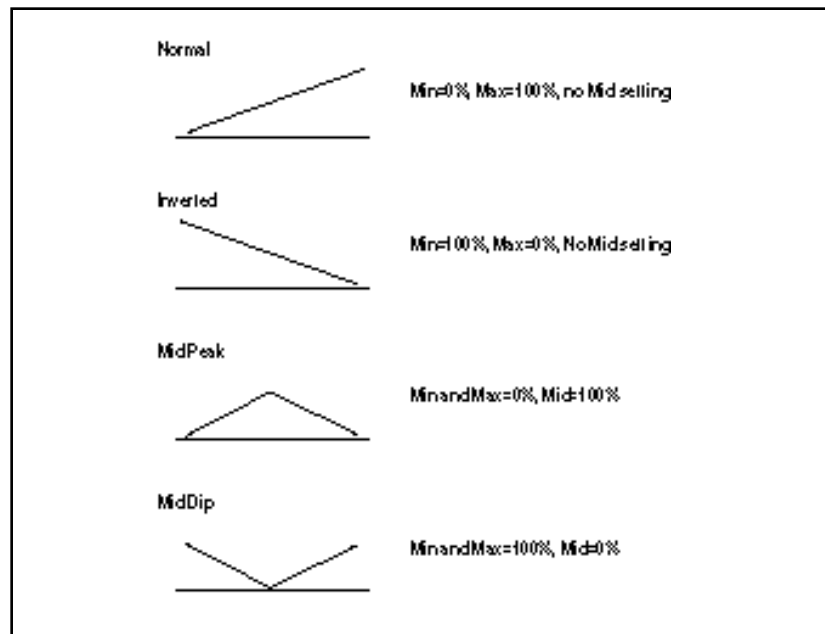

Continuing to press > will step you to the **Suspend** option. Selecting **Suspend** temporarily suspends the patch until such time as you return to the Patch System Destination Option and select **Unsuspend**.

## Suspending and Clearing Patches

Continuing to press > will step you to the options: **Clear 1-5**, and **Clear All**. These allow you to select any or all patches to be cleared.

Once you have made any selection, press **Options** to have your choice take effect and to return to the Source and Destination Assignment screen.

If you create two or more patches with the same Destination, the Destination value will be the sum of all patches assigned to it.

## Multiple Patches with the Same Destination

For example, if a Footpedal, and the knob are both assigned to Mstr Mix, the Mix value will be the sum of the patch Destination values for those two patches. When creating multiple patches to the same Destination, you should set the individual Destinations to values which, when added together, are less than or equal to the maximum value for each parameter. The Footpedal and the knob, for example, could each have a maximum value of 50%, or they could be assigned values of 25% and 75%, 60% and 40%, etc.

When the sum of multiple patched parameter Destination values is greater than the maximum value of the parameter, the parameter value will remain at maximum until the sum of the patches falls below it.





## System Controls

The System menus shown below provide access to all of the controls which affect overall operation of the MPX G2, such as Bypass state, MIDI transmit and receive channels, as well as some unique options that make the MPX G2 adapt to your personal requirements. These controls are each explained in detail in this chapter, in the order in which they are displayed in System mode.

### The System Menus

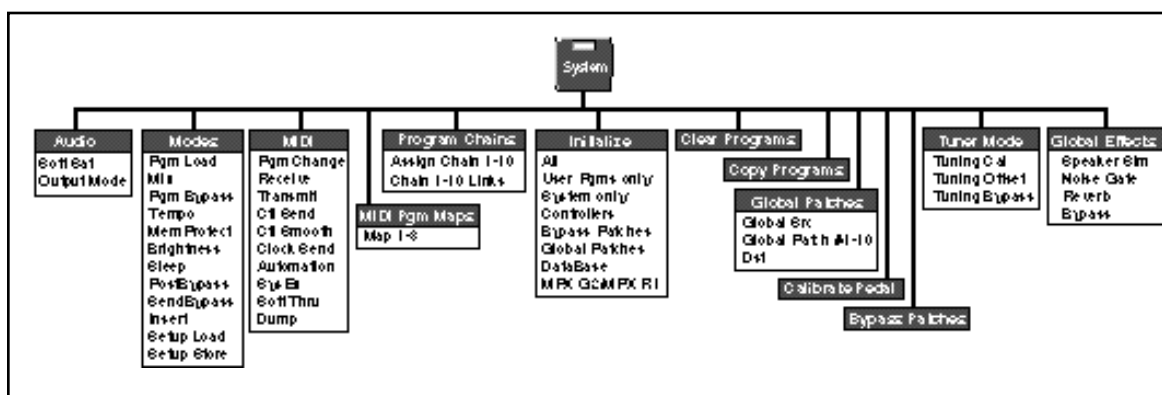

Press **System** to enter the **System** menu, and use the knob to select the particular menu you want. With the menu of your choice displayed (**Audio**, **Modes**, etc.), use the < and > buttons to enter the submenu and select parameters, and the knob to adjust parameter values. When you're finished making adjustments within any menu, press **System** to return to the main **System** menu, or press the < and > buttons to select another control from the same menu.

The Audio menu allows you to change the settings of controls which affect the MPX G2 audio output characteristics.

### Audio Controls

The **Soft Sat** control puts an analog soft-knee limiter in front of the input of the MPX G2 A/D converters. This control essentially allows you to trade the harshness of digital distortion for a softer, analog version. The harshness associated with A/D overload at signal levels above -3dBfs is reduced. Increased analog distortion will occur in the range of -3dBfs to 0dBfs. The available settings are **On** and **Off**.

### Soft Sat

In **Output Mode**, select **Stereo** or **Mono** as the output mode of the MPX G2.

### Output Mode

**Modes** The MPX G2 **Modes** menu allows you to specify certain system-wide parameters and modes of operation for convenience. Each of these is described in this section.

**Pgm Load** **Pgm Load** allows you to choose whether programs will be loaded manually or automatically.

Selecting **Manual** allows you to scroll through programs in Program mode, viewing them according to the DataBase criteria you've selected. Programs which are *not* loaded are identified by an asterisk (★) preceding the displayed name, and flashing of the **Program** button LED. Press **Program** to load the displayed program.

Selecting **Auto** (the default setting) will cause programs to be loaded automatically following a brief timeout whenever they are selected in **Program** mode.

**Mix** Each MPX G2 program has its own Post Mix and Level parameters, as well as individual mix and level settings for each Effect. These settings are stored as integral parts of the program. The **Mix** parameter allows you to select **Program**, to have each program load with its own Mix setting, or **Global** which allows any program Mix setting to become the global setting for all subsequently loaded programs.

**Pgm Bypass** **Pgm Bypass** allows you to determine the behavior of the MPX G2 during the transition when a new program is loaded. The choices available are: **All Mute** or **Bypass**.

**Tempo Mode** The MPX G2 gives you an exciting approach to working with delay times and modulation parameters. You can set these parameters in *beats*, allowing you to control your programs in a completely musical way. Each MPX G2 program has its own Tempo parameters, with tempo settings stored as an integral part of the program. These include Tempo Rate, Tempo Source (Internal or MIDI), Beat Value and Tap Source. The **Global** setting here allows you to override individual Tempo Rate settings with a global value which can then be changed on the fly.

When shipped, the MPX G2 has the Tempo Mode set to **Program**, with each program driven by its own stored tempo rate. To change to a global tempo rate, select **Global** here.

Whether **Tempo Mode** is set to **Global** or **Program**, you can set a new tempo rate by pressing the front panel **Tap** button twice. Alternatively, you can choose to have tempo set automatically from incoming MIDI clock. The rate you tap, or the MIDI tempo, will become the global setting.

For more information about working with the tempo parameters, see Chapter 3: *Editing*.

The MPX G2 provides a memory protection feature to prevent accidental overwriting of your stored programs. When this control is set to **On**, attempting to store a program will cause the Store process to abort, and an error message to be displayed. To enable the Store function, select **Off**. (This is the default setting.)

#### Option: StorePrompt

To have the MPX G2 warn you whenever loading a new program would erase changes you have made but have not saved, press **Options** and set **StorePrompt** to **On**.

### Memory Protect



This control allows you to adjust the brightness of the alphanumeric display along a range of 0-15.

### Brightness

The setting of **Sleep** mode determines the behavior of the MPX G2 when it is left idle. When it is on, a set of messages is cycled across the display. Like a computer screen saver, any activity on any panel control will automatically return the MPX G2 to normal operation. When shipped, **Sleep** is set to **Off**. You can change this mode to display general **Help** messages.

### Sleep

The **Post Bypass** parameter allows you to determine the behavior of the MPX G2's post gain effects when the front panel **Bypass** button is pressed. When the **Bypass** button is pressed, it will light and a message will be briefly displayed to indicate that Bypass is on. Pressing **Bypass** again will briefly display the message that Bypass is off, and turn the button light off.

### Post Bypass

The choices available from the **Post Bypass Mode** menu are:

- Bypass:** Completely bypasses the post gain effects, passing unprocessed audio directly through to the outputs. (This is the default setting.)
- All Mute:** Mutes both the input and the output signal, giving complete silence.
- Input Mute:** Mutes the input to the post gain effects, allowing the tail of the effect to ring out.
- Disabled:** Post gain effects are not changed when **Bypass** is pressed.

**Send Bypass** The SendBypass parameter allows you to set the bypass behavior of the pre-gain path (everything between the Guitar Input and the Insert Send jack) when the front panel **Bypass** button is pressed. The choices are:

**Disabled:** **Bypass** has no effect on the pre-gain path.

**Bypass:** An internal relay bypasses the pre-gain path with an analog "straight wire" between the Guitar Input and the Send jack. (This is the default setting.)

**Insert Mute:** **Bypass** bypasses the pre-gain path with an analog "straight wire" between the Guitar Input and the Send jack.

**Insert Mute** mutes the pre-gain path after the Send and bypasses the Insert Return jacks. This allows the **Insert** button to be used as a preamp bypass when the MPX G2 is connected to a guitar amp input and its effects loop.

**Insert** For maximum flexibility when connecting other gear to the G2 via the Insert Send and Return jacks, three Insert Modes are provided: **FX Loop**, **Mix** and **Parallel**.

**FX Loop** allows gear to be connected in series between the pre-gain and post-gain paths. This is the most useful setting when the MPX G2 is used with a guitar amp that has an effects loop, when an external processor is connected to the MPX G2, or when the MPX G2 is used as a stand alone preamp with effects. This is the default setting.

In this mode, signals inserted into the MPX G2 rear panel Return jack(s) are passed through a level control, a selectable analog speaker simulator, and then routed (via 24-bit A/D converters) into the post-gain DSP path. In the MPX G2 **Effect Order** or **Routing Map** display (Edit mode), the return signal is inserted immediately after the Gain block (**G** in the display).

**Mix** mode allows the return jacks to be used as an analog line mixer. This mode is provided for applications when you want to have additional, unprocessed audio mixed with the outputs of the MPX G2. For example, you would use this mode to Insert the output of a CD or DAT player so you can play along with headphones. Signals inserted into the MPX G2 rear panel Return jack(s) pass through the level control and are mixed with the main and headphone outputs of the MPX G2. Note that when this mode is selected, the Return signals are *not* processed by the MPX G2.

**Parallel** mode allows gear to be connected in parallel between the pre- and post-gain paths. Use this mode if you want to convert a serial guitar amp effects loop into a parallel loop. The parallel signal path provided by this mode allows the dry analog guitar signal to pass directly to the power amp without running through any converters. Note that when using a parallel effects loop, the **Post: Mix** parameter (Edit mode) should be set to 100% wet. Signals inserted into the MPX G2 rear panel Return jack(s) are passed through the level control and selectable speaker simulator, then split in parallel — through the post-gain DSP path and mixed with the main and headphone outputs.

## Setup Load and Setup Store

A set of parameters from System mode, including audio parameters, Modes, MIDI parameters and your current DataBase sorting method are collectively called a "Setup". Five Setups can be stored in the unit, allowing you to quickly reconfigure the MPX G2 at any time. The **Setup Load** and **Setup Store** controls allow you to save your current configuration as **Setup 1-5** and to reconfigure the MPX G2 to any of these stored states.

When the MPX G2 is shipped (or when you reinitialize the unit) default values are assigned to the Setup parameters. The following table shows these parameters and the factory default setting of each.

Menu	Parameter	Default Setting
<b>Program</b>	Database Sort	by Number
<b>System</b> Audio	Output Mode	Analog
	Soft Sat	Off
Modes	Pgm Load	Auto
	Mix	Program
	Pgm Bypass	Bypass
	Tempo	Program
	MemProtect	Off
	StorePrompt	Off
	Brightness	9
	Sleep	Off
	Post Bypass	Bypass
	Send Bypass	Bypass
	Insert	FX Loop
MIDI	Pgm Change	On
	Pgm# Offset	1
	Pgm+	Off
	Pgm-	Off
	Receive Channel	1
	Transmit Channel	1
	Pgm Change Mode	On
	Ctl Send	None
	Ctl Smooth	0
	MIDI Clock	Off
	Automation	Off
	Xmit ID	0
	SysEx	On
	Receive ID	0
	Soft Thru	Off
	Xmit Speed	Fast
Initialize	Bypass Patches	R1
Tuner	Tuner Cal	440.00HzA
	Tuner Offset	0 Cents
	Tuner Bypass Mode	Mute
Global Effects	Speaker Sim	Program
	Noise Gate	Program
	Reverb	Program
	Bypass	Global

To load a Setup, select **Setup Load** from the **System Modes** menu.

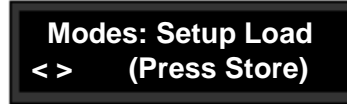

Modes: Setup Load  
< > (Press Store)

The LED in the **Store** button will flash. When you press **Store** the display will show:



Load #n: Setup1  
(Press Store)

The upper line of the display shows the Setup number currently selected for loading. Turn the knob to select any Setup number 1-5. Press **Store** again. The display will show:

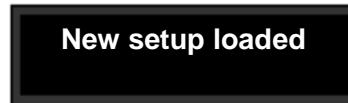

New setup loaded

Then the MPX G2 will return to normal operation with the new Setup parameters in effect.

The procedure for storing a new Setup is almost identical, but includes the option of assigning a name to your Setup. Select **Setup Store** from the **System Modes** menu.



Modes: Setup Store  
< (Press Store)

The LED in the **Store** button will flash. When you press **Store** the display will show:



Setup 1  
#1 Setup 1

Use the < and > buttons to move an underbar cursor to anyone of 9 characters available in the upper line for naming, or to the Setup # in the lower line.

The upper line shows a default Setup name (**Setup 1** in our example). The lower line shows a Setup number (1-5) and the current name of that Setup. The < and > buttons move an underbar cursor in the display from each one of the nine characters available for the name, to the # on the bottom line. The knob selects alphanumeric characters at each cursor location.

Once you've made changes to the Setup name or selected a new number for it, press **Store** again. The display will show:

**Are you sure?  
Yes or No**

To store your new Setup, press **Yes**. To return to the **Setup Store** display without saving the Setup, press **No**.

This menu contains all of the MPX G2 **MIDI** controls. The operation of each of these controls is described here. More information on working with MIDI is presented in Chapter 6.

## MIDI

The **Pgm Change** control allows you to enable or disable the Reception of MIDI Program Change messages. The manner in which the MPX G2 interprets these messages is determined by your selection here.

## Program Change

- Off** All Program Change and Bank Select messages are ignored. **Pgm +** and **Pgm -** will load the next higher or lower program.
- On** Program Change messages are recognized.

### Options: Pgm# Offset, Pgm+ and Pgm-

Pressing **Options** from the **Pgm Change** display allows you to offset MPX G2 program numbers to match another MIDI device.

From **Options** you can also map **Pgm+** and **Pgm-** controls to load the next higher or lower program. The following sources can be selected to activate these controls:

- None
- Tog 1-3
- Sw 1-3
- CC 1-119

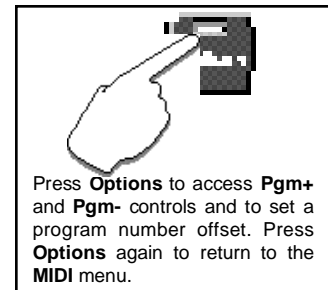

Select MIDI Channel **1-16**, **OMNI** or **Off** for receipt of MIDI messages.

## Receive

Select MIDI Channel **1-16**, or **Off** for transmission of MIDI messages.

## Transmit



**Ctl Send**

If **Transmit** is active (set to any channel), you can select any of the controllers shown to the side to transmit MIDI controller messages if they are used in a patch.

Ctl Send Selections	
None	ABTrg
Off	Pedal
On	Tog 1-3
Knob	Sw 1-3
Puls1	CC 1-31
Tri1	CC33-119
Sine1	Bend
Cos1	Touch
Puls2	Vel
Tri2	Last Note
Sine2	Low Note
Cos2	High Note
Rand	Tempo
Env	Cmnds
InLvl	Gate
RnLvl	Trig
A/B	LGate
ATrg	TSW
BTrg	Toe

The display presents two selection fields for mapping the controllers as shown below.



Two fields are available for mapping MPX G2 controls to MIDI controllers.

Press **Options** to access **MIDI Reset**. Press **Yes** in response to the display prompt to reset all patched parameters to their stored values. Press **Options** again to return to the **MIDI Ctl Send** menu.

**Options: MIDI Reset**

The MPX G2 recognizes the “Reset All Controllers” MIDI message. When received, all patched parameters are reset to their stored values. Patched parameters may also be reset from the MPX G2 front panel—in **System** mode select **Ctl Send** from the **MIDI** menu and press **Options**, then press **Yes**. (The message will be transmitted from the MPX G2 as well). If you do not want to perform the reset, press **Options** to exit.

**Ctl Smooth**

The **Ctl Smooth** parameter is an intelligent filter that provides a smoothing function for incoming MIDI data. At 100, the filter is essentially bypassed. With decreasing values, the filter becomes more sluggish in its response to small MIDI controller value changes while maintaining a fast response to large changes. This is useful for smoothly interpolating sparse MIDI controller data. As the value is lowered, the filter’s response slows for both large and small MIDI controller value changes.

**Clock Send**

You can choose to have the MPX G2 transmit MIDI Clock at the current tempo rate by setting this control to **On** and **Tempo Source** (in the **Edit** menu) to **Internal**. If this control is set to **Off**, MIDI Clock will not be transmitted.

This control is provided for recording changes in a sequence, or for control of one or more additional MPX G2s. Select **On** to have values resulting from front panel operations sent out as System Exclusive messages.

**Options: Automation Xmit ID**

Press **Options** to access the **Automation Xmit ID** screen where you can select **0-126** to identify the target MPX G2s.

### Automation

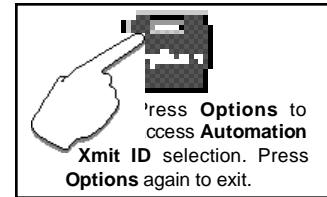

This control is provided for communication with one or more additional MPX G2s, or computer editor software. **On** (the default setting) allows System Exclusive messages to be received by the MPX G2.

**Options: SysEx Receive Device ID**

Press **Options** to access the **SysEx Receive Device ID** screen where you can select **0-126** or **All** to identify the MPX G2.

### SysEx

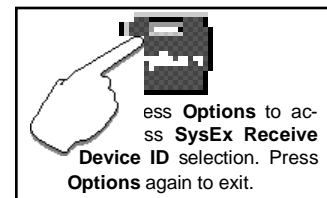

Setting this parameter to **On** will merge data (Program Change, Continuous Controllers and Note messages) received via the MPX G2 MIDI IN port with the messages transmitted through the MIDI OUT port. The default for this parameter is **Off**.

### Soft Thru

This control allows you to perform MIDI dumps of **Current Pgm**, **All Programs**, **Map 1-3**, **Chain 1-10**, **Setup 1-5**. Select whichever of these categories you want, and press **Store**.

**Options: Xmit Speed**

Press **Options** to select one of four MIDI transmission speeds (**Slow**, **Medium**, **Slow Fast** and **Fast**.)

NOTE: The Device ID used in dumps is the current **Receive Device ID**.

### Dump

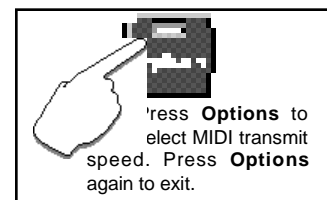

### MIDI Maps

Program Change 0-127 can be mapped to any MPX G2 program. Three 128-element maps are available. When you select **MIDI Maps** from the System menu, you can select any one of the three maps and make your selections from screens like the ones shown below.

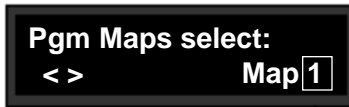

With the map number you want to work with displayed in the lower right of the display, use the < and > buttons to scroll to the mapping screen.



MIDI Assign mode lets you select **Learn** or **Manual**.

**Learn** will automatically assign MIDI Program Change messages to any MPX G2 programs. (This is great for mapping programs to buttons on a MIDI foot controller.)

**Manual** allows you to "dial in" MIDI Program Change assignments. (This lets you set up MIDI Maps with no MIDI gear connected.)

You can map JamMan controls or the MPX G2 front panel buttons listed, as well as any MPX G2 program to MIDI Program Change messages.

**MPX G2 Programs:**

- Program 1
- 
- 
- 
- Program 300

**JamMan Controls:**

- Clear Loop
- Layer
- Replace
- Delay
- Start/Stop

**MPX G2 Controls:**

- Tap
- Bypass
- Gain Bypass
- FX1 Bypass
- FX2 Bypass
- Chorus Bypass
- Delay Bypass
- Reverb Bypass
- EQ Bypass
- Insert Bypass
- Toggle A/B

Select this field to display an MPX G2 program, JamMan or front panel controls.

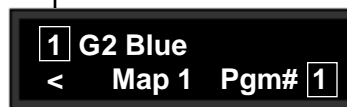

Select this field to select the MIDI Program Change number you want the displayed program mapped to.

The MIDI Program number will be learned automatically when **MIDI Assign Mode** is **Learn**. — Just send a Program Change message from a MIDI controller.

If **MIDI Assign Mode** is **Manual**, dial in the MIDI Program number with the knob.

Once you've created maps, you can make them active by setting the DataBase sorting option to **Show Members of MIDI Maps**. (Press **Program**, then press **Options**.)

**Options: Unchanged, Start at n, Clear Map, and Clear n-n**

Press **Options** from either of the Map screens to access an additional set of controls which allow you to quickly alter map assignments.

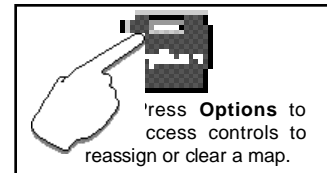

- Unchanged:** Selections made in **Options** take effect immediately on returning to the Map menu. This selection allows you to enter and exit **Options** without effecting any change.
- Start at n:** This control allows you to completely reassign a map, starting with the program number selected here, and including the next consecutive 127 program numbers.
- Clear Map:** This control allows you to completely clear all assignments for the active map.
- Clear n-n:** This control allows you to completely clear only a specified section of assignments for the active map.

The MPX G2 has 10 internal program chains, each made up of ten "links". You can assign any program to any link in the chain with the controls in this menu. A chain can be loaded with a MIDI Program Change message when **Members of Pgm Chains** is the Program mode DataBase sorting option. When the **Members of Pgm Chains** is selected as a DataBase sorting option, use the < and > buttons (or MIDI Program Change numbers) to select a chain. Use the knob ( or **Pgm+/Pgm-**) to load programs assigned to the selected chain.

## Program Chains

Once a chain is loaded, the source assigned to **Pgm+** and **Pgm-** will load the next higher or lower program in the chain. The screens in the **Program Chains** menu allow you to select chains, and make chain and link assignments as shown below.

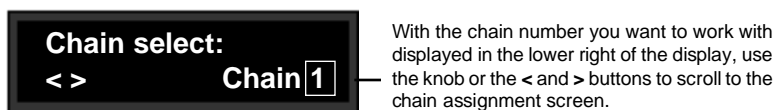

Select either of these two fields to display any MPX G2 program number (and the corresponding program name) on the top line, and the position you want the displayed program to occupy in the chain (Link 1-10) on the bottom line.



**Options: Unchanged, Start at n, and Clear chain**

Press **Options** from any of the Chain screens to access an additional set of controls which allow you to quickly alter chain assignments.

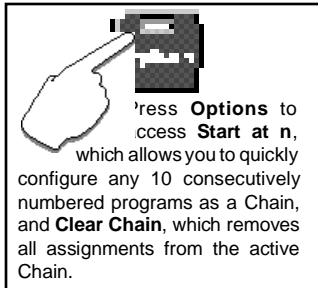

**Unchanged:** Selections made in **Options** take effect immediately on returning to the Chain menu. This selection allows you to enter and exit **Options** without effecting any change.

**Start at n:** This control allows you to completely reassign a chain, starting with the program number selected here, and including the next consecutive nine program numbers. This is particularly useful for creating chains from your own programs.

**Clear Chain:** This control allows you to completely clear all assignments for the active chain.

**Initialize** Selecting any item in the **Initialize** menu will restore portions of the MPX G2 to their factory default settings. These controls allow you to perform a complete reset of the unit to its factory defaults, or to reset only selected functions.

For any displayed selection, the initialization procedure is the same. When a selection is displayed, as in the **Initialize All** example shown below, the **Store** button LED will flash, indicating that the MPX G2 is armed to perform the reset procedure.

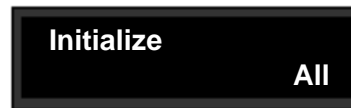

Select the initialization option you want.



The **Store** button will flash. Pressing it will display the following message ...

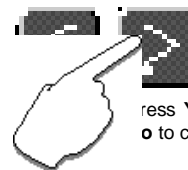
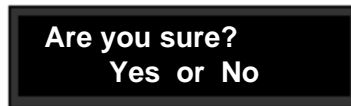

Press **Yes** to initialize. Press **No** to cancel the operation.

Press **Store**. The display query "Are you sure?" prompts you to select **Yes** or **No** as a response. If you don't want to perform the initialization, press **No** to cancel the operation. If you press the front panel **Yes** button in response to this message, the procedure will be performed immediately. The message **Init Complete** indicates that the procedure has been performed.

Note that the time for reinitialization will vary, with selections including DataBase reset taking more time.

The selections in this menu are as follows:

- All:** Resets all MPX G2 parameters to their original factory settings.  
**This will erase all User programs and Setups.**
- User pgms only:** Erases all User programs (program #s 251-300).
- System only:** Resets all MPX G2 parameters *except* User programs.
- Controllers:** Resets the MPX G2 internal controllers (Knob, LFOs, etc.) to their default settings.
- Bypass Patches:** Removes any patches made between **Bypass** buttons and external controllers.
- Global Patches:** Clears all global patches.
- DataBase:** Resets DataBase assignments for all programs.  
**This will remove DataBase assignments from programs 251-300.**
- MPXG2/R1:** Resets the MPX G2 and any connected MPX R1 to the original factory settings of all remote parameters such as Bypass Patches, Continuous Controller assignments, etc.

This control allows you to clear a single User program, or any number of consecutively numbered User programs.

## Clear Programs

From the **Clear Programs** screen, press > to display the following screen.

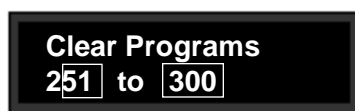

Two fields are available for selecting any number of User programs between 251 and 300.



The **Store** button will flash. Pressing it will display the following message ...

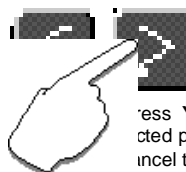
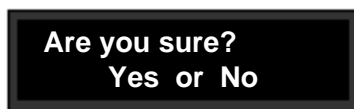

Press **Yes** to clear the selected programs. Press **No** to cancel the operation.

The **Store** button LED will flash, indicating that the MPX G2 is armed to perform the clear procedure. Press **Yes** to execute the clear operation. Note that this will override the Memory Protect function if it is on.

A displayed message indicates that the clear operation is complete. Press **System** to return to the main **System** menu.

Note that if you clear the active program, you can still use it and make modifications to it (including restoring it) until you load another program, at which time the clear action will take effect.

**Copy Programs** This control allows you to copy a single program, or any number of consecutively numbered programs into a new location in User memory (program #s 251-300). Selections you make here will overwrite programs currently at the location(s) you designate.

From the **Copy Programs** screen, press > to display the following screen.

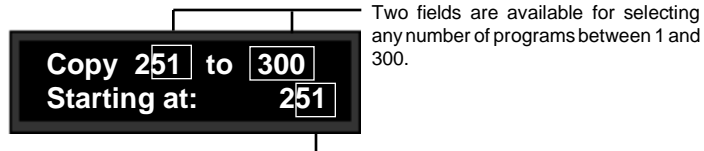

Select the location where you want the first of your selected programs to be placed. The remainder of the programs you have selected will be placed consecutively after this point.



The **Store** button will flash. Pressing it will display the following message ...

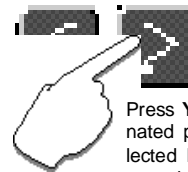
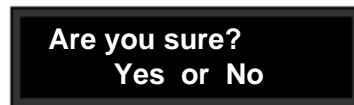

Press **Yes** to copy the designated programs into the selected location. Press **No** to cancel the operation.

The **Store** button LED will flash, indicating that the MPX G2 is armed to perform the copy procedure. Press **Yes** to execute the copy operation. Note that this will override the Memory Protect function if it is on.

A displayed message indicates that the copy operation is complete. Press **System** to return to the main **System** menu.

Ten global patch assignments are available which allow you to assign an external controller to the MPX G2 Post Mix or Send and Post Level controls, or to individually control any one of the MPX G2 Effect Mix or Level controls. Global patches override, but do not clear, program patches with the same parameter Destination.

## Global Patches

From the **Global Patches** screen, press > to display the following screen.

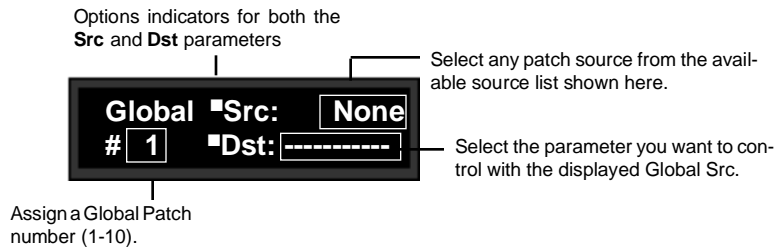

Use the < and > buttons to select one of the display fields shown above. Use the knob to assign a source, a destination parameter and a patch number.

When you've completed your selections, press **System** to return to the main **System** menu.

Options: **MIDI Learn** and **Dst Edit**

When **Global Source** is selected, pressing **Options** accesses a MIDI Learn function which automatically assigns any connected MIDI controller as the Source as soon as the controller is moved. Once you have moved the controller, press **Options** again to return to the **Global Patches** display.

When **Dst** is selected, pressing **Options** accesses a set of controls which allow you to edit all assigned Destinations.

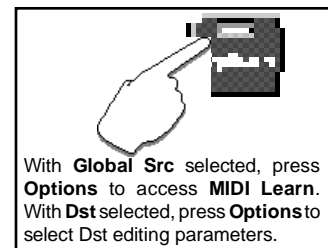

With **Global Src** selected, press **Options** to access **MIDI Learn**.  
With **Dst** selected, press **Options** to select Dst editing parameters.

**Unchanged:** Selections made in **Options** take effect immediately on returning to the Global Patches menu. This selection allows you to enter and exit **Options** without effecting any change.

**Clear All:** This control allows you clear all Destination assignments.

**Mix Params:** This control allows you to assign Mix parameters to all Destinations.

**Level Params:** This control allows you to assign Level parameters to all Destinations.

Press **Options** again to return to the **Global Patches** display.

### JamMan Note

Clear Loop  
Layer  
Replace  
Delay  
Start/Stop

Controls for the JamMan Delay effect can also be assigned as Global Patch Destinations.



**Calibrate Pedal** This control allows you to achieve full range output of any connected 10k-100k continuously variable footpedal.

From the main **System** menu, select **Calibrate Pedal** and press **Yes**. A display prompt will allow you to choose to continue the calibration procedure, overwriting any pre-existing pedal settings, or to discontinue the procedure.

Pressing **Yes** in response to the display prompt displays:

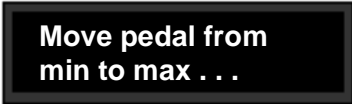

Move pedal from  
min to max . . .

Move your footpedal from its minimum to its maximum position. **127** should be displayed when you reach the maximum point of footpedal travel.

Press **Yes** to save the calibrated settings and to return to the **System** menu. Your settings will be stored as part of the current Setup.

To restrict the active range of a pedal, position the pedal within the desired range, then select **Calibrate Pedal** and press **Yes**. When the display prompts you to move the pedal, move it only within the restricted range, then press **Yes**. Once calibrated, any pedal positions below the range will produce pedal controller values of 0. Positions above the range will produce values of 127.

The pedal jack will also work with control voltages as high as 0-10V, or as low as 0-1V. When prompted to move the pedal, move the control voltage between its minimum and maximum values, then press **Yes**. Refer to Chapter 1: *Product Overview* for pedal wiring information.

**Bypass Patches** You can assign external controllers to activate Master Bypass and or Bypass for any of the seven effect blocks (Gain, Effect1, Effect2, Chorus, Delay, Reverb or EQ) and Insert.

Use the < and > buttons to select the bypass function: Mstr, Pitch, etc. Use the knob to assign the control you want to have activate the selected function. The choice of controllers is:

**None (the default setting)**  
**Tog 1-3**  
**Sw 1-3**  
**CC 1-31**  
**CC 33-119**

Three controls are available here for customizing the MPX G2 Tuner settings: **Tuner Mode**, **Cal**, **Offset** and **Bypass**.

**Cal** Use this parameter to set the Tuner's "A" pitch. The factory setting is A=A. If you change this, for example, to A=G, you can tune your guitar down a whole step — but the open strings will still be displayed as E A D G B and E.

Note: If you change this setting, this will also be used for reference in the Diatonic Hmy effect.

**Offset** You can fine tune the Tuner's "A" pitch over a range of  $\pm 50$  cents to match a recording or a non-A440 tuning reference.

**Bypass** The factory setting of this parameter is **Mute** which turns off the Send and Main Outputs while you're tuning. **Post Mute** mutes only the Main Outputs — dry guitar is sent out the Send while the Tuner is active. **All Bypass** sends dry guitar out both the Send and Main Outputs while the Tuner is active.

The Global Effects modes provide quick and useful ways of changing the overall behavior of the G2 to fit specific applications. They allow you to choose to make the Speaker Simulator, Noise Gate, Reverb, and Master bypass functions universal or program specific.

## Global Effects

In each case, setting the mode to **Global** lets the current settings override the individual settings stored with each program — a very handy feature if you want to turn the Speaker Simulator off for all programs because you're playing through a guitar amp and speakers, or if you want to make the Noise Gate active to tame a 200watt amp cranked to 10.

When the Speaker Sim, Noise Gate, Reverb and Bypass modes are set to **Program**, each program will load with its own settings. To audition the programs as they were intended to be heard:

1. Connect the G2 for Stand Alone, Amp Input & Effects Loop or Amp Input Only application.
2. Set Speaker Sim, Noise Gate, Reverb and Bypass modes to **Program**.
3. Load and listen to the presets for the appropriate application (Amp Input & Effects Loop or Amp Input Only).

**Speaker Sim Mode** When Speaker Sim mode is set to **Global**, the current settings of the speaker simulator override the settings stored with each program.

If you're connected to a guitar amp and playing through guitar speakers - you'll want the Speaker Sim turned off in all programs.

If you're playing or recording directly into a mixer, you'll want the Speaker Sim turned on (at least for any programs that use Gain Effects).

When Speaker Sim mode is Global, its settings are not saved with a program when it is stored. To save the settings with a program, the mode must be set to **Program**.

**Noise Gate Mode** Setting Noise Gate mode to **Global** applies the current settings of the Noise Gate to all programs in the MPX G2. In this mode, you can edit the Noise Gate parameters as usual. Note, however, that to save the settings with a program, the mode must be set to **Program**.

**Reverb Mode** When Reverb mode is set to **Global**, the reverb settings in the current program override the individual reverb settings stored with each program. This allows you to keep the same reverb while you load different programs. (So, for example, when you get the perfect reverb settings with your amp in a particular club - you don't have to edit and store the reverb for every program you plan to use that night.)

With Reverb mode set to **Global**, you can edit reverb parameters as usual — even change algorithms. Note, however, that your reverb settings will not be saved when you store the program. To save reverb settings with a program, the Reverb mode must be set to **Program**.

With Reverb mode set to **Global**, the reverb bypass state also becomes global. If you bypass the reverb, it will stay bypassed — even when you load new programs — until you make it active again.

**Bypass Mode** When Bypass mode is set to **Global**, the current Master bypass state is not changed when a new program is loaded. Once bypassed, the MPX G2 will stay bypassed until you press **Bypass** again (even when you load new programs). In this mode, the bypass state is not saved with a program when it is stored. To save the state with a program, this mode must be set to **Program**.

When Bypass mode is set to **Program**, the Master bypass state stored with a program becomes active when the program is loaded. (Just like the individual effects bypass states, the Master bypass state can be stored with a program.)

## MIDI Operation

Most MPX G2 parameters and all programs can be accessed by MIDI. All MIDI applications require the MPX G2 to be connected with one or more MIDI devices with standard MIDI cables via the rear panel MIDI jacks.

### Selecting a MIDI Channel

MIDI controls, such as Transmit and Receive Channel selection are available in the **System** mode **MIDI** menu. All of these controls are described in Chapter 5: *System Controls*. Several are repeated here for your convenience.

Before using the MPX G2 with other MIDI devices, all devices must be set to the same MIDI channel. To set the MPX G2 to receive MIDI:

1. Set the controller you will be using (keyboard, sequencer, other MPX G2, etc.) to transmit on any MIDI channel (1-16).
2. On the MPX G2, press **System**. Use the knob to scroll to the **MIDI** menu. Use the < and > buttons to select **MIDI Receive**.
3. Use the knob to select **OFF**, **1-16**, or **OMNI** for receipt of MIDI messages.

### Accessing Programs

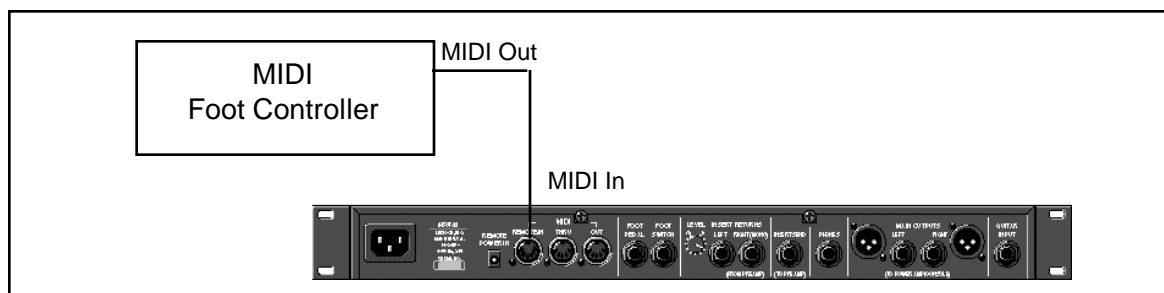

Some extremely useful effects can be created by controlling MPX G2 parameters remotely in real time. Almost all of the controllers found on a MIDI keyboard or MIDI foot controller (pitch benders, mod wheels, sliders, switches, breath controllers, foot pedals and footswitches) can be used to adjust MPX G2 parameters. We refer to this real time remote control capability as Dynamic MIDI.®

Sending a MIDI Program Change message from the controller will load an MPX G2 register. If any MIDI sources are active as global or general purpose patches, moving the appropriate control on the controller will cause the patched destination parameter to change. (See Chapter 4: *Patching*.) If you want to use Dynamic MIDI, but don't want the MPX G2 to load new registers when you change programs on your controller, set your controller so that it doesn't transmit Program Change messages, or set MPX G2 **Pgm Change** to **Off** in the **System** mode **MIDI** menu.

#### JamMan NOTE

When the JamMan effect is loaded (Delay block) and the **MIDI Clock Output** parameter (in the **System: MIDI** menu) is enabled, a MIDI Start message is sent at the end of the loop definition. A MIDI Stop message is sent when the loop is reset or the **MuteS** (Start/Stop) parameter is used. (MIDI Stop on mute and MIDI Start on de-mute.)

## Controlling MPX G2 Tempo Rate with MIDI Clock

### MIDI Tempo Control

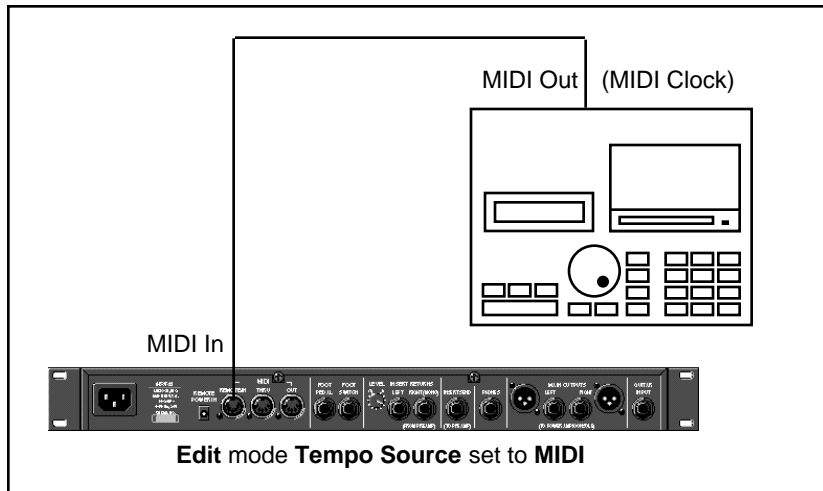

### Using the MPX G2 as a MIDI Clock Source

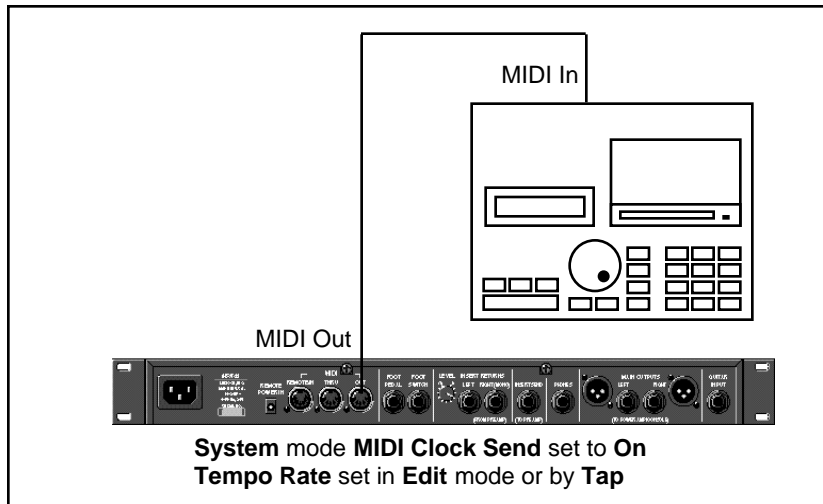

The configuration below shows the MIDI connections for controlling the MPX G2 simultaneously with MIDI Clocks from a sequencer, and messages from another MIDI controller. Note that the controller is set to "local control off" and the sequencer is set to "echo input".

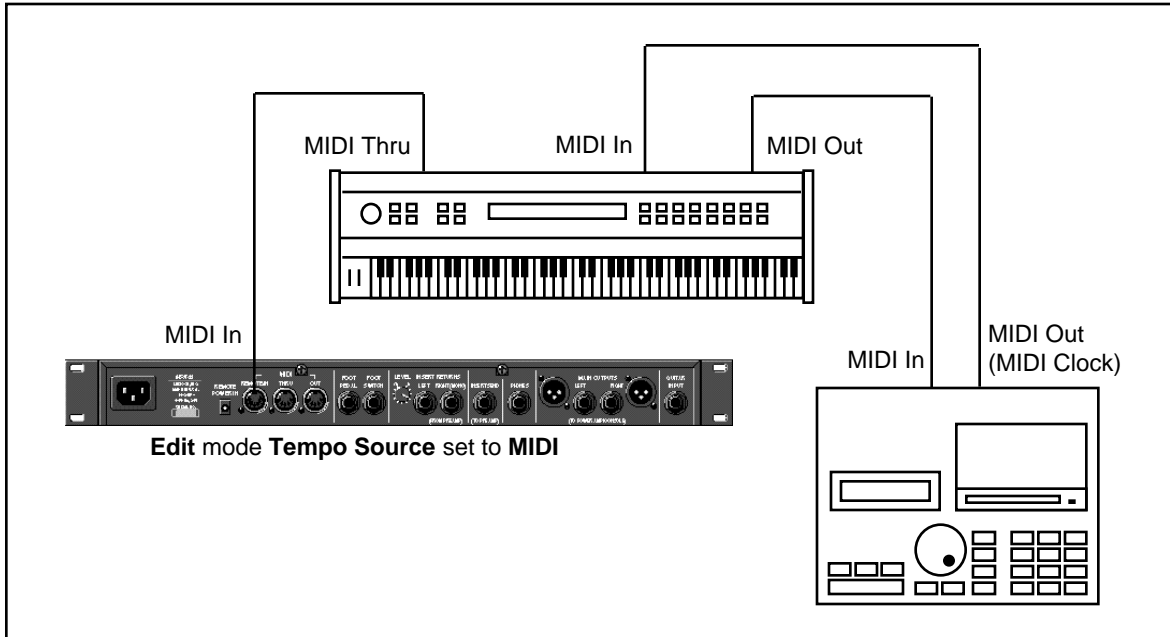

Two MPX G2s can be slaved together by connecting a cable from the MIDI OUT jack of the master to the MIDI IN jack of the slave. Additional MPX G2s can be slaved to the master by connecting a cable from the MIDI THRU port of one slave unit to the MIDI IN port of the next unit.

**Slaving two or more MPX G2s**

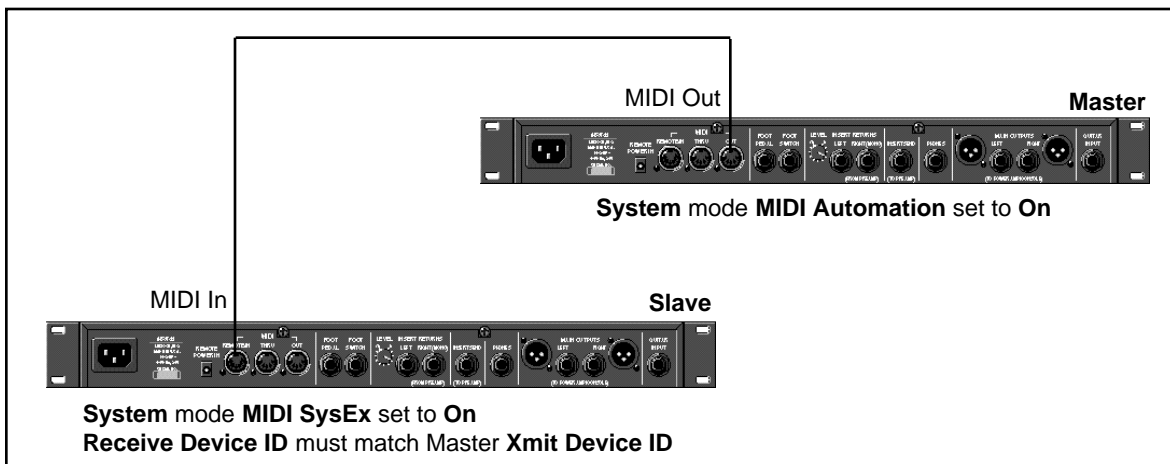

## Controller Quirks

Some synthesizers and controllers cannot send the full range of MIDI program change messages (1-128). Others may appear to be able to send only 32, but actually have a bank mode that *does* let you send all 128 program change messages. Also, be aware that some MIDI devices use a program numbering system that uses 0-127 instead of 1-128. If in doubt, see the manual for your controller. See also MIDI Pgm Offset on the following page.

## The Knob, Footpedal and Footswitch as MIDI Controllers

If the Knob, footpedal, or footswitch is active in the current program, you can choose to have the MPX G2 send MIDI Controller messages whenever you adjust it. This makes it possible to record real-time control of MPX G2 effects with a MIDI sequencer — a simple but quite powerful way to automate effects.

To send MIDI data from a controller, first create a patch using the controller, then set **System** mode **MIDI Xmit** to the desired MIDI Channel. (The default is Channel 1.)

Once a transmit channel has been set, go to **System** mode **MIDI Ctl Send** to assign MIDI Controllers. The display will show MPX G2 controllers and parameters in one field, and MIDI controller output selections in another field. (The default assignments are **None**.)



The MIDI Controller messages transmitted by MPX G2 controllers can be recorded in any MIDI sequencer. Once recorded, they can be played back to control the MPX G2 (and other MIDI devices) in real time. To control the MPX G2 from recorded controller messages, reassign the patch sources to the controller value that was assigned to **Ctl Send** in the **System MIDI** menu.

The procedures for recording footpedal movements on a MIDI sequencer, then using the sequencer to control the MPX G2, are given below as an example:

To transmit pedal moves to the sequencer:

- Create a patch that uses **Pedal** as a source to control the desired parameter.
- In the **System MIDI** menu, select **Ctl Send** and assign **Pedal** to any controller (for this example, use **CC4**.)

To automate the MPX G2 from the sequencer:

- Change the patch source from **Pedal** to **CC4**.

Reception of MIDI Program Change and Bank Select messages can be selectively enabled/disabled from the **System** mode **MIDI** menu. The manner in which the MPX G2 interprets these messages is determined by the value of this parameter as follows:

## Program Change Messages

### **Pgm Change: Off**

All Program Change and Bank select messages are ignored. Pgm+ and Pgm- controllers will load the next higher or lower program in the current bank.

### **Pgm Change : On**

Program Change messages 0-99 are recognized. Program Change messages 100—127 are ignored except when MIDI maps or chains are active.

Pressing **Options** from the **Pgm Change** display allows you to select a **Pgm# Offset** (to allow matching of MPX1 program numbers to another MIDI device) or to map **Pgm+** and **Pgm-** controls to load the next higher or lower program in the current bank.

Controller 32 is used to select Banks.

Program memory is organized into three banks as follows:

Program Bank 1	Preset programs 1-100
Program Bank 2	Preset programs 101-200
Program Bank 3	User programs 201-250

Three 128 element MIDI maps are stored internally. Program Change 0-127 can be mapped to any MPX G2 program. When first shipped, the MPX G2 has each map load with the following defaults:

<b>Map 1, 2 or 3</b>
MIDI 1 = Program 1
MIDI 128 = Program 128

Pgm+ and Pgm- will load the next higher or lower program in the map.

Any Program Change number can be selected to load any one of ten customized effect "chains." Once a chain is loaded, effects in the chain are accessed by the controller patched to Pgm + and Pgm - (program increment and program decrement).



## Automation

### SysEx Automation

The MPX G2 will transmit SysEx automation messages when the **System** mode **MIDI Automation** parameter is set to **On**. Virtually all changes made by front panel operations are transmitted as MPX G2 SysEx messages. This is intended primarily for use by editor programs and in configurations where it is desirable for one or more MPX G2s to be slaved to a single MPX G2 acting as a master. The current mode (Program, Edit or System) of the slave does not follow the master, but the actual parameter values do. (SysEx automation can also be stored on a sequencer and replayed in real-time. As a general rule, automating more than two or three SysEx parameter changes at once is not recommended.)

To set up the MPX G2 to receive SysEx automation messages from another MPX G2, or from a computer editor/sequencer, the transmitting and receiving MPX G2s should be set up as follows:

Transmitting MPX G2: **System** mode **MIDI Automation** set to **On**  
(Default=Off)

Receiving MPX G2: **System** mode **MIDI SysEx Receive** set to **On**  
(Default=On)

The **Receive Device ID** of the receiving MPX G2, and the **Xmit Device ID** of the transmitting MPX G2 must match. The **Receive Device ID** is an Option of the **MIDI SysEx Receive** parameter. The **Xmit Device ID** is an Option of the **MIDI Automation** parameter.

### Controller Automation

For applications where it is desirable to "automate" changes made to MPX G2 effects with its own controls ( the Knob, Footpedal or Footswitch), we recommend assigning the controllers to MIDI destinations (see Chapter 5: *System Controls MIDI Send*) and recording the MPX G2 MIDI output with a MIDI sequencer.

### Reset All Controllers

The MPX G2 recognizes the "Reset All Controllers" message. When received, all patched parameters are reset to their stored values, or to the last front panel-edited values. Patched parameters may also be reset from the MPX G2 front panel—in **System** mode select **Ctl Send** from the **MIDI** menu and press **Options**. (The message will be transmitted from the MPX G2 as well).

### MIDI Clock and Clock Commands

The MPX G2 recognizes incoming MIDI clock messages when the **Edit** mode **Tempo Source** parameter is set to **MIDI**. Any Delay parameter set to echoes:beat, or any LFO parameter set to cycles:beat, will be synchronized to the tempo of the incoming MIDI clock.

#### JamMan NOTE

When the JamMan effect is loaded (Delay block) the loop size will be determined by the **Beat Value** (number of beats) and the tempo of the incoming MIDI Clock. Like the original JamMan device, only one **Tap** is required.

MIDI Clock and Clock Commands (Start, Stop, Continue) are also available as Dynamic MIDI patch sources. The value of MIDI Clock when used as a patch source is a linear scaling of 0 to 127 (0 = 41 BPM and 127 = 400 BPM). The value of Clock Commands when used as a Dynamic MIDI patch source is 1 for START and CONTINUE and 0 for STOP.

The following MIDI controllers are available as Dynamic MIDI patch sources:

### Dynamic MIDI

MIDI Controllers	
1-31, 33-119	Continuous or switches: 0–127
Pitch Bend	0=max flat, 64=no bend, 127=max sharp
After Touch	Channel pressure: 0–127
Velocity	Note On velocity value of last received note: 1-127
Last Note	Note Number value of last received note: 0-127
High Note	Note Number value of highest note when more than one note is on: 0-127. (Same value as Last Note when only one note is on.)
Low Note	Note Number value of lowest note when more than one note is on: 0–127. (Same value as Last Note when only one note is on.)
Tempo	MIDI or internal tempo ranging from 41–400 BPM converted to a continuous range of 0–127.
Clock Commands	MIDI Clock commands received as a switch: Start and Continue=127, Stop=0
Gate	Generates 127 when any note is on and 0 when all notes are released.
Trigger	Generates a pulse (0, 127, 0) everytime a Note On is received.
Legato Gate	Generates 127 whenever two or more notes are on and 0 whenever fewer than two notes are on.
Touch Switch	Toggles between 0 and 127 whenever After Touch rises above 32 (allowing After Touch to be used as a latching switch).

These MIDI controllers are also available as threshold sources for several modulation parameters such as LFO1 and 2. They may also be used as a tap source for controlling Tempo.

The **System** mode **MIDI** menu provides a **Dump** control which allows selection of the following types of bulk data to be dumped directly from the MPX G2 to another MPX G2, or to editor/librarian software. **Options** allows you to select MIDI transmit speeds of Slow, Medium Slow, Medium Fast or Fast.

### Bulk Data Dumps

Displayed Name	Description
CurrentPgm	Currently running effect
All Programs	
Map 1-3	Internal Program Change Maps
Chain 1-10	Internal Program Chains
Setup 1-5	Internal Setups

With the dump type you want displayed, press **Store** to transmit the data .

## MIDI Implementation Chart

Lexicon MPX G2  
Digital Effects System

Function		Transmitted	Recognized	Remarks
Basic Channel	Default Changed	1 1-16	1 1-16, OMNI	
Mode	Default Messages Altered	Mode 1 X	Mode 1, 3 X X	
Note Number		0-127	0-127	Last Note, Low Note, High Note, LGate, Gate, Trig used as controllers
Velocity	Note ON Note OFF	O X (Off-9n v=0)	O	used as controller
After Touch	Keys Channel	X X	X O	TSW and Touch used as continuous controllers
Pitch Bend		X	O	used as controller
Control Change	1-119	OX	OX	1-119 for MIDI transmit <b>0, 32 for Bank Select</b>
Program Change	Bank Select	O O	0-99=1-100 O	100-127 ignored in Program mode 0-127 recognized for MIDI maps MIDI maps selectable via Bank Select
System Exclusive	Lexicon Real-time non Real-time	OX X Device ID	OX X Device Inquiry	product ID=15 Device ID
System Common	:Song Pos :Song Sel :Tune	X X X	X X X	
System Real Time	:Clock :Commands	OX X	OX OX	START, STOP and CONTINUE are patchable as a switch: START/CONTINUE=127; STOP=0
Aux Messages	:Local ON/OFF :All Notes OFF :Active Sense :Reset All Controllers	X X X OX	X O X OX	
Notes				

Mode 1: OMNI ON, POLY  
Mode 3: OMNI OFF, POLY

Mode 2: OMNI ON, MONO  
Mode 4: OMNI OFF, MONO

**O : Yes**    **OX: Selectable**  
**X : No**

## The Effects and Parameters

The MPX G2 contains a library of 76 effects, each of which is described in detail in this section.

The effects are organized into seven effect types corresponding to the Effect Selector buttons on the front panel (Gain, Effect1, Effect2, Chorus, Delay, Reverb and EQ). All of the effects available in each category are listed below.

Gain	Effect 1		Effect 2		Chorus	Delay	Reverb	EQ
Tone	Detune (M)	DigiDrive1	Panner	SweepFilter	Chorus	Delay (M)	Chamber	1-Band (M)
Crunch	Detune (S)	DigiDrive2	Auto Pan	1-Band (M)	Detune (M)	Delay (S)	Hall	2-Band (M)
Screamer	Detune (D)	OctaBuzz	Tremolo (M)	Wah 1	Flanger (M)	Delay (D)	Plate	3-Band (M)
Overdrive	Shift (M)	SweepFilter	Tremolo (S)	Wah 2	Flanger24 (M)	Echo (M)	Ambience	4-Band (M)
Distortion	Shift (S)	1-Band (M)	UniVybe	Pedal Wah1	Flanger (S)	Echo (S)	Gate	1-Band (S)
Preamp	Shift (D)	Wah 1	CustomVybe	Pedal Wah2	Rotary Cab	Echo (D)		2-Band (S)
SplitPreamp	DiatonicHmy	Wah 2	Phaser	Volume (M)	Aerosol	Looper		1-Band (D)
	Panner	Pedal Wah1	OrangePhase	Volume (S)	Orbits	JamMan		2-Band (D)
	Auto Pan	Pedal Wah2	RedComp	Volume (D)	Centrifuge1	Ducker		Fc Splitter
	Tremolo (M)	Volume (M)	BlueComp	PedalVol	Centrifuge2			Crossover
	Tremolo (S)	Volume (S)	DigiDrive1	ExtPedalVol	Comb 1			Volume (M)
	UniVybe	Volume (D)	DigiDrive2	Test Tone	Comb 2			Volume (S)
	CustomVybe	PedalVol	OctaBuzz	Click	Volume (M)			Volume (D)
	Phaser	ExtPedalVol			Volume (S)			PedalVol
	OrangePhase	Test Tone			Volume (D)			ExtPedalVol
	RedComp	Click			PedalVol			
	BlueComp				ExtPedalVol			

Lighted effect buttons indicate which effect blocks are active and turned on in the currently loaded program. (Effects can be active, i.e. available for use in a program, but bypassed and, therefore, "off".) To identify the particular effect which is running, press and hold any of the effect buttons. A message informs you if the effect block is active, or not. The name of the particular effect in use in an active block is identified by name.

To access the edit parameters of any active effect, press **Edit**, then select the effect by pressing the appropriate button. Use the knob and the < and > buttons to select and modify the effect parameters. Press **Edit** again to return to the Edit menu. See Chapter 3: *Editing* for more information.

### **Notes on Combining Effects**

Different effects require different amounts of MPX G2 processing. The following notes should be kept in mind when creating new combinations of effects in a program.

All Reverb and Gain effects have dedicated processing and can be used in combination with any other effect. (You can always add these to any MPX G2 program.) In addition, the Noise Gate and Speaker Simulator don't share resources with the effects and are, therefore, always available.

The other effects (**Effect1, Effect2, Chorus, Delay** and **EQ**) share processing "steps". The total number of available steps is **190**. This means that some combinations of these effects may not be possible—depending on which effects are already loaded.

When you scroll through the effects for a given block, the size (in steps) of each effect is shown in the upper right hand corner of the display. If the effect will fit in the current program, an asterisk (\*) is displayed next to its name and the Effect button will flash rapidly. If the effect will not fit, an "x" is displayed, and the Effect button light will turn off.

When you stop scrolling, a resource usage message is displayed briefly showing how many steps are available and how many steps have been used.

### **Notes on Controlling Effect Parameters**

Any effect parameter in the MPX G2 can be patched for real time control. In some cases, audible artifacts may be produced, depending on the particular parameter and the rate and range of control. In many effects, we've added additional processing power to parameters that are obvious candidates for drastic dynamic control. These parameters are "interpolated" to produce extremely smooth, noise free control.

It is often possible to compensate for a non-interpolated parameter, such as Effect 1 Detune Level, by combining the effect block with one with an interpolated Level parameter, such as Effect 2 Volume.

### **Notes on the Effect Descriptions**

In the following effect descriptions, a bar showing the processing requirements, in steps, of each effect in relation to the total possible number of steps (190) is shown at the end of each description.

Interpolated parameters are indicated by an asterisk (\*) following the parameter name.

### Gain Effects



#### Gain **Tone**



<b>Lo</b>	± 25dB	Clean low frequency boost/cut
<b>Mid</b>	+12/-25dB	Clean mid frequency boost/cut
<b>Hi</b>	± 25dB	Clean high frequency boost/cut
<b>InLvl</b>	-64 to 0dB	Input level (headroom)
<b>Level</b>	0dB to 64dB	Output level

Tone is a set of analog Tone controls which can be used as a clean-boost stomp box in front of your amp, or as a simple clean preamp when the MPX G2 is used without an external guitar amp. When used as a stomp box, Tone can radically alter the sonic character of your guitar amp, providing an alternative channel. When used without an external amp, Tone can sculpt some dramatic clean sounds. Try boosting Lo and Hi while cutting Mid to produce acoustic-like timbres from a single coil neck pickup.

0 190  
**NO PROCESSING STEPS USED**

#### Gain **Crunch**



<b>Lo</b>	±25dB	Low frequency Drive
<b>Mid</b>	±25dB	Mid frequency Drive
<b>Hi</b>	0-50dB	High frequency Drive
<b>InLvl</b>	-64 to 0dB	Input level (Drive sensitivity)
<b>Level</b>	0dB to 64dB	Output level

Crunch is an overdrive effect with separate drive controls for low, mid and high frequencies. Designed to be used like a stomp box (in front of your amp), Crunch works well in combination with other pre-gain effects like wah, phase shift, compression, and octave fuzz.

0 190  
**NO PROCESSING STEPS USED**

\* = Interpolated; ( ) = Option of preceding parameter

Gain

## Screamer

Screamer is an analog model of a vintage Tube Screamer overdrive (powered by a fresh carbon-zinc battery). Care has been taken to make the behavior of this effect accurate both sonically and electronically. The ranges of Drive and Tone match those of the vintage effect and it will push your amp into high gear just like the original. We've also added Lo, Mid and Hi tone controls. For truly authentic sounds, leave them set flat (zero), but feel free to dial in some additional colors unobtainable with the original.

```

graph LR
    In(( )) --> TS[Tube Screamer Pedal]
    TS --> Drive[Drive]
    Drive --> Tone[Tone]
    Tone --> Level[Level]
    Level --> Out(( ))
            
```

<b>Lo</b>	± 5dB	Low frequency boost/cut
<b>Mid</b>	±5dB	Mid frequency boost/cut
<b>Hi</b>	0-5dB	High frequency boost
<b>Drive</b>	0-40	Amount of overdrive
<b>Tone</b>	0-25	High frequency roll-off
<b>Level</b>	0dB to 64dB	Output level

0

190

NO PROCESSING STEPS USED

\* = Interpolated; ( ) = Option of preceding parameter

Gain
**Overdrive**

<b>Lo</b>	± 15dB	Low frequency boost/cut
<b>Mid</b>	±15dB	Mid frequency boost/cut
<b>Hi</b>	0-15dB	High frequency boost
<b>InLvl</b>	-64 to 0dB	Input level (Drive sensitivity)
<b>LoCut</b>	0-20	Pre-Drive low frequency roll off
<b>Feel</b>	0-64	Overdrive dynamics
<b>Drive</b>	0-40	Amount of overdrive
<b>Tone</b>	0-25	High frequency roll-off (Post-Overdrive)
<b>Level</b>	0dB to 64dB	Output level

A more aggressive overdrive effect than Screamer, Overdrive is designed to be used as a stomp box — to push a clean amp channel into bluesy overdrive, or to take a high-gain amp channel over the top. Lo, Mid and Hi controls provide a considerable amount of gain.

InLvl determines overall Drive sensitivity. When cranked up, Lo, Mid and Hi behave like individual distortion controls. When throttled back to -15dB or so, Lo, Mid and Hi behave more like traditional EQ controls.

LoCut rolls off low frequencies before they hit the overdrive circuit (and your amp). This can be very useful if your stage sound is muddy and you need to cut through the band.

The Feel parameter is a unique feature of Lexicon's Dynamic Gain analog algorithms. In this effect, it mimics the subtle changes in distortion dynamics caused by different power supplies. When set to 0, the amount of compression/distortion produced during the attack of notes is relatively constant. As this value is increased, you'll notice a difference in the feel of the attack when using overdrive and moderate amounts of distortion. The first attack of a phrase of rapid picking is a bit cleaner and has more bite than those that follow. This mimics the different "power sag" envelopes characteristic of different stomp box power sources. 0 corresponds to the uniform response of an AC adapter (9V). Values 1-32 approximate the increasingly dynamic responses produced by various batteries — from a fresh alkaline battery (9.3V), to a fresh carbon-zinc battery (9.8V). Values above 32 mimic tube-rectified power supplies.

Tone provides high frequency roll-off after the overdrive stage. Level should be used to compensate for gain added by InLvl, the Tone controls and Drive.

0 190

NO PROCESSING STEPS USED

\* = Interpolated; ( ) = Option of preceding parameter



**Gain Distortion**

Need more than just Overdrive? Distortion provides more than 100dB of analog gain — and it has an additional set of Bass and Treble controls following the distortion stage. Although not based on any particular pedal, this effect has a sonic kinship with several classic distortion pedals and fuzz boxes.

<b>Lo</b>	-25dB to +18dB	Low frequency Drive
<b>Mid</b>	-25dB to +18dB	Mid frequency Drive
<b>Hi</b>	0-18dB	High frequency Drive
<b>Drive</b>	0-50	Amount of distortion
<b>Tone</b>	0-25	High frequency roll-off
<b>Bass</b>	± 25dB	Post-Drive bass control
<b>Trebl</b>	± 25dB	Post-Drive treble control
<b>Level</b>	0dB to 64dB	Output level

0 190

NO PROCESSING STEPS USED

\* = Interpolated; ( ) = Option of preceding parameter

**Gain Preamp and SplitPreamp**

<b>Lo</b>	± 25dB	Low frequency boost/cut
<b>Mid</b>	±25dB	Mid frequency boost/cut
<b>Hi</b>	0-50dB	High frequency boost
<b>InLvl</b>	-64 to 0dB	Input level (Drive sensitivity)
<b>LoCut</b>	0-20	Pre-Drive low frequency roll off
<b>Feel</b>	0-64	Overdrive dynamics
<b>Drive</b>	0-60	Amount of overdrive
<b>Tone</b>	0-35	High frequency roll-off
<b>Bass</b>	± 25dB	Post-Drive bass control
<b>Trebl</b>	± 25dB	Post-Drive treble control
<b>Level</b>	0dB to 64dB	Output level

\* = Interpolated; ( ) = Option of preceding parameter

Unlike the other MPX G2 Gain effects, Preamp was not designed to function as a stomp box to use in front of your amplifier. It is a fully featured, programmable analog guitar preamp. Use Preamp for stand-alone applications (direct recording without an amp, or to drive a power amp and cabs). When using Preamp for direct recording, be sure to turn on the Speaker Simulator (Edit Select, Speaker Sim, Simulator: On).

InLvl (Input Level) determines the amount of clean headroom the preamp has. The setting of this single control will have a great impact on the overall behavior and sound of the preamp. At higher values, the preamp will distort very easily — for example, with a Mid tone control boost of only 5dB. At lower levels, the tone controls behave more like EQ controls — making low, mid and high guitar frequencies louder (or softer) without adding distortion.

As a general guideline, set InLvl to approximately -15dB when working on clean or crunch sounds. Use higher values when you're going for more over-the-top distortion.

**Be aware that this preamp can produce well over 120dB of analog gain.**

Depending on the settings of InLvl and Drive, the three tone controls will behave like EQs or distortion controls. Unlike many preamps, these controls are active — meaning that they can boost the signal (add gain) as well as cut it. Each control can add up to 25dB of gain boost. Pay attention to the total amount of boost — in most cases, a little goes a long way.

The LoCut control is used to roll-off low end before hitting the drive section of the preamp. The higher the value, the fewer low frequencies in the distortion. This control can be helpful in removing “mud” from high gain sounds, allowing them to stand out in a mix.

The Feel parameter is a unique feature of Lexicon's Dynamic Gain analog algorithms. In the Preamp effect, Feel is used to model the subtle changes in distortion dynamics caused by different types of power-amp rectifier circuits. When set to zero, the amount of compression/distortion produced during the attack of notes is relatively constant. As this value is increased, you'll notice a difference in the feel of the attack of notes and chords when using overdrive and moderate amounts of distortion. The first attack of a phrase of rapid picking is a bit cleaner and has more bite than those that follow. This mimics the different “power sag” envelopes that are characteristic of different power amp rectifier circuits. A setting of 0 corresponds to the uniform response of a tight, solid state rectifier circuit. Values between 1 and 32 produce increasingly dynamic responses - but are generally within the realm of those produced by power amps with solid-state rectifiers. Values above 32 are more in keeping with the dynamic feel produced by tube -rectified power amps.

Drive sets the amount of overall gain in the preamp. The cleanest sounds are produced with Drive set to 0. Distortion increases as the value of Drive is increased.

Tone is a post-distortion high frequency rolloff control. Use it to control the high frequency harmonics generated by the distortion. As Bass and Treble are also post-distortion, they can further shape the sound by cutting or boosting top and bottom without affecting the distortion.

Level is the master volume for the entire preamp. Use it to compensate for gain cut or boost added by the combination of InLvl, the Tone controls and Drive. When going for high gain sounds, lower the Level control to compensate for increases in InLvl and Drive. A good way to set the Level control is to press the **Gain** button to bypass the preamp so you can match the Preamp level with the bypass level.

Split Preamp is the same analog effect as Preamp, except that it has a built-in parallel path that feeds the direct, clean guitar to the MPX G2's post-gain section. This allows you to create programs that have preamp and right channel direct guitar sounds simultaneously.

As with any preamp, a little time taken to learn how the controls interact with one another will pay off when you're searching for “the sound”.

One of the fundamental distinctions between different types of preamps is how clean or dirty it is. This distinction is generally determined by the preamp's input sensitivity — which roughly translates to “How hard do I have to hit this thing to make it break up?” In most preamps this attribute is fixed for each channel. (The clean channel is less sensitive than the lead channel.)

The tone controls of a preamp's clean channel generally behave like EQ controls on a mixer. They make changes in what we hear as bright, dark and warm without adding distortion. It's a different story when you adjust the tone controls of many preamps' lead channel. On these, the tone controls interact with the gain section and changing the tone settings will often make significant changes to the distortion characteristics of the sound. In the lead channel of many preamps, the Mid control can be used as a distortion control. Turn it up to add more distortion — down to make the sound cleaner.

The analog Preamp effect in the MPX G2 has all of these attributes. Because it is completely programmable, it is not limited to clean or lead channels with fixed input sensitivity. Careful adjustment of its parameters can yield many tonal variations from clean and slinky, to blues overdrive and beyond, to a high gain roar.

0 190  
**NO PROCESSING STEPS USED**

**Effect1 and Effect2**

Effect descriptions for all of the effects contained in Effect1 and Effect2 are combined in this section.



Effect1 and Effect2 contain identical effects, except for the first seven effects in Effect1. These are Pitch effects: Detune (M), (S) and (D), Shift (M), (S) and (D) and Diatonic Hmy. In these effects, Tune controls the amount of pitch shift. The Optimize parameter (an option of Tune) allows balancing of any artifacts vs. the amount of delay through the effect. Higher settings of Optimize are good for chords and low notes, lower settings minimize the delay through the effect.

**Effect1 Detune (M), Detune (S) and Detune (D)**

Detune effects are useful for thickening up sounds by adding delayed/pitch shifted versions of the original source. They can be particularly effective when used to simulate double-tracking. They are also great alternatives to chorus effects as a detuner can add the richness of a chorus effect without the audible sweep caused by the chorus rate. Detuners are also traditionally used to turn a six-string guitar into a twelve-string, or an in-tune piano into a honky-tonk. The MPX G2 detuners are optimized to provide very fine amounts of pitch shift.

**Detune (M)** is a single-channel detuner that creates a pair of signals, pitch-shifted up and down from the input. The pair is always mixed together, and presented equally to the outputs.

**Detune (S)** creates a pair of signals, pitch-shifted up and down from the inputs. The left and right channels are separate.

**Detune (D)** sums left and right inputs to mono, then creates two pairs of signals, pitch-shifted up and down from the inputs by Tune1 and Tune 2. The first pair goes out the left, the second pair out the right.

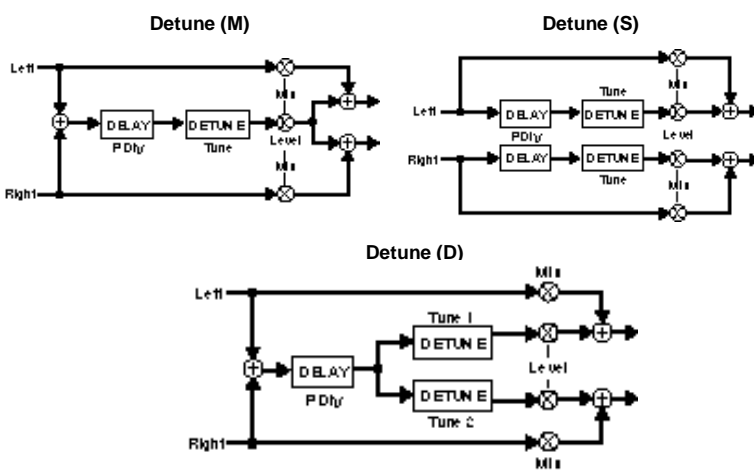

<b>Mix</b>	0-100%	Dry/Wet ratio
<b>Level</b>	Off, -89 to +6dB	Amount of effect in the processed signal
<b>Tune, Tune1, 2</b>	0-100	Pitch shift
<b>(Optimize)</b>	10-60ms (M), (D) 10-40ms (S)	An option of Tune 1 — Adjusts the amount of delay in the tuner
<b>P Dly</b>	0-70ms (M), (D) 0-25ms (S)	Amount of delay before the onset of the effect

As the detune effects use up relatively few processing resources, they can be combined with reverb and many other effects. When creating effects that don't require pitch shifting by large intervals (semitones) the detuners are the most efficient choice.



Detune (M)

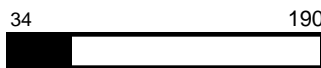

Detune (S)



Detune (D)

\* = Interpolated; ( ) = Option of preceding parameter

**Block 11 Shift (M), Shift (S) and Shift (D)**

<b>Mix</b>	0-100%	Dry/Wet ratio
<b>Level</b>	Off, -89 to +6dB	Amount of effect in the processed signal
<b>Tune</b>	-4800 to +1900 cents	Pitch shift
<b>(Optimize)</b>	0-100	Adjusts the amount of delay in the pitch shifter
<b>Glide</b>	Off, On	Coarse, fine resolution of pitch shift

These effects use more processing resources than the detuners. Shift (S) and Shift (D) are among the largest effects in the MPX G2.

The pitch shift effects are designed to provide both fine (1 cent resolution) and coarse (semitone resolution) pitch shift effects. Use them to create harmonizations, detuning, or special effects. The Tune parameters can be glided smoothly across their entire range. Try controlling Tune with a foot pedal or MIDI controller for "whammy-bar" and pedal steel effects.

Shift (M) is a single-channel pitch shifter.

Shift (S) is a stereo version of Shift (M) with synchronized crossfades.

Shift (D) provides mono input to two independent pitch shifters controlled by Tune1 and Tune 2. The first shifter goes to the left output, the second to the right output.



Shift (M)



Shift (S)



Shift (D)

\* = Interpolated; ( ) = Option of preceding parameter

**Block 11 Diatonic Hmy**

DiatonicHmy is an “intelligent” pitch shifter. The effect will automatically shift the pitch of an incoming monophonic notes to the correct harmony note in the selected key and scale. You select the key and scale — (E major, A minor, etc.) and harmony interval (up a 3rd, down a 6th, etc.). When an out of key note is detected, it will be shifted by the same interval amount as the last in-key note. Note the pitch detector can use either the Guitar Input or Return Inputs as the source for pitch detection. The default is Guitar Input, which allows the detector to analyze a clean, unprocessed guitar signal — even if you want to shift the guitar audio after it has been processed by one or more effects.

96

190

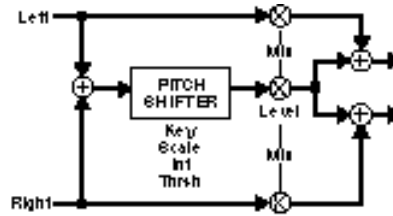

<b>Mix</b>	0-100%	Dry/Wet ratio
<b>Level*</b>	Off, -89dB to +6dB	Amount of effect in processed signal
<b>Key</b>	C to B	Pitch root of scale
<b>Scale</b>	Major, Dorian, Phrygian, Lydian, Mixolydian, Minor, Locrian	Type of scale
<b>Int</b>	-2Oct to Oct+ 5th	Harmony Interval
<b>(Optimize)</b>	0-100	Sets the amount of delay in the pitch shifter
<b>Thresh</b>	-83dB to 0dB	Sets the level above which the pitch detector tracks
<b>(Src)</b>	Guitar In, Returns Input	Selects the audio input used for pitch analysis.

\* = Interpolated; ( ) = Option of preceding parameter

Block 11
Block 12
**Panner**

<b>Mix*</b>	0-100%	Dry/Wet ratio
<b>Level*</b>	Off, -89 to +6dB	Amount of effect in the processed signal
<b>Pan 1*</b>	50L to C to 50R	Left input panner
<b>Pan 2*</b>	50L to C to 50R	Right input panner

25
190

The Panner effect has the left input panned to outputs with Pan 1, right input with Pan 2. Because all the parameters of this effect are interpolated, this can be used to add interpolated outputs to effects which have non-interpolated output levels.

Block 11
Block 12
**Auto Pan**

<b>Mix*</b>	0-100%	Dry/Wet ratio
<b>Level*</b>	Off, -89 to +6dB	Amount of effect in the processed signal
<b>Rate*</b>	0-50Hz or 1:24-24:1 cycles/beat	Pan rate or period ratio
<b>(Rate Units)</b>		Selects frequency or cycles/beat
<b>PW*</b>	0-100%	Pan pulse width
<b>Depth*</b>	0-100%	Pan depth
<b>Phase</b>	0°-270°	Phase difference between right and left pan

25
190

Auto Pan is a version of Panner with the pans controlled by a local LFO. The left input is panned by the LFO's sine output. The right input is panned by the cosine output, which is offset by 0°, 90°, 180° or 270° by the Phase parameter.

\* = Interpolated; ( ) = Option of preceding parameter

**Tremolo (M) and Tremolo (S)**

In Tremolo (M), the left and right inputs are mixed together, then a local sinewave generator modulates the volume.

In Tremolo (S) the left input is modulated by a local sinewave generator before going to the left output. The right input is modulated by sin, cos, -sin, or -cos, depending on the Phase parameter.

These are the smallest mono and stereo effects with interpolated output level controls. You can use them (with the tremolo turned off) to add smooth output level control to a stereo effect that doesn't have output level interpolation.

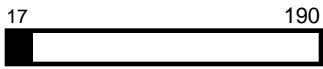

Tremolo (M)

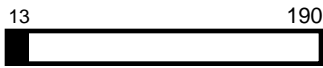

Tremolo (S)

**Tremolo (M)**

**Tremolo (S)**

<b>Mix*</b>	0-100%	Dry/Wet ratio
<b>Level*</b>	Off, -89 to +6dB	Amount of effect in the processed signal
<b>Rate*</b>	0-50Hz 1:24-24:1 cycles/beat	Tremolo rate or period ratio
<b>(Rate Units)</b>		Selects frequency or cycles/beat
<b>PW*</b>	0-100%	Tremolo pulse width
<b>Depth*</b>	0-100%	Tremolo depth
<b>Phase</b>	0°-270°	In Tremolo (S), controls the phase difference between the right and left tremolo

NOTE: Mix is interpolated in Tremolo (S) only.

**UniVybe**

Univybe is a recreation of a vintage Uni-Vibe. The Uni-Vibe, originally intended for use with electronic organs (as a replacement for rotating speakers), became an essential effect for many guitarists. Its dreamy swirling sound has become a defining element of many Hendrix live and studio recordings (also used by Robin Trower, David Gilmore, Audley Freed and many others).

Our version is modeled on a vintage Uni-Vibe set to "chorus" with depth turned up all the way. The Rate control matches the range, and slightly wobbly shape of the original speed control. To get the classic effect, put a slow UniVybe in front of your guitar amp, set the amp for a moderate amount of gain and play the opening chords to "Little Wing". You'll find that the effect is more pronounced when you play clean and that it fades into the background as your tone gets more distorted.



<b>Mix</b>	0-100%	Dry/Wet ratio
<b>Level</b>	Off, -89dB to +6dB	Amount of effect in processed signal
<b>Rate</b>	0-100	Univybe rate

\* = Interpolated; ( ) = Option of preceding parameter

Block 11
Block 11
CustomVybe

<b>Mix</b>	0-100%	Dry/Wet ratio
<b>Level</b>	Off, -89dB to +6dB	Amount of effect in processed signal
<b>Rate</b>	0-50Hz or 1:24-24:1 cycles/beat	Custom Vybe rate or period ratio
<b>PW</b>	0-100%	Custom Vybe pulse width
<b>Depth*</b>	0-100%	Custom Vybe depth

70
190

This custom version of Univybe has additional parameters with extended ranges. The Rate can be set to any speed from 0-50Hz. It can also be set in cycles/beat, allowing you to tap in the sweep rate. When Depth is set to 100%, the effect is about twice as pronounced as the original. PW allows adjustment of the sweep waveshape between sine (50%), sawtooth (0%) and ramp (100%)

Block 11
Block 11
Phaser

<b>Mix</b>	0-100%	Dry/Wet ratio
<b>Level</b>	Off, -89 to +6dB	Amount of effect in the processed signal
<b>Rate</b>	0-50Hz or 1:24-24:1 cycles/beat	Phaser rate or period ratio
<b>(Rate Units)</b>		Selects frequency or cycles/beat
<b>PW</b>	0-100%	Phaser pulse width
<b>Depth*</b>	0-100%	Phaser depth
<b>Res</b>	-100 to +100%	Amount of feedback from output of filters to inputs

77
190

The Phaser effect is a simulated Mutron phaser.

\* = Interpolated; ( ) = Option of preceding parameter



Block 11
Block 11
OrangePhase

The sound and rate of this phase shifter are modeled on a vintage MXR Phase 90 stomp box — a signature component of the early Van Halen sound.

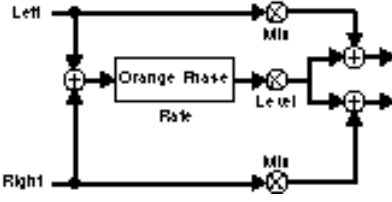

<b>Mix</b>	0-100%	Dry/Wet ratio
<b>Level</b>	Off, -89dB to +6dB	Amount of effect in processed signal
<b>Rate*</b>	0-100	OrangePhase rate

77 190

Block 11
Block 11
Red Comp

Red Comp is our take on the classic Dyna Comp stomp box. It is a simple compressor with fixed ratio, threshold and time constants (each matched to the original). The amount of compression is set with the Sense control. The higher the value of Sense, the more the signal is “squashed.”

Red Comp has lots of uses. It is generally used in front of the amp. With clean sounds, it can add extra attack and sustain. Use it in front of an overdriven preamp to keep notes in the sweet spot without spilling over into too much distortion when you play hard.

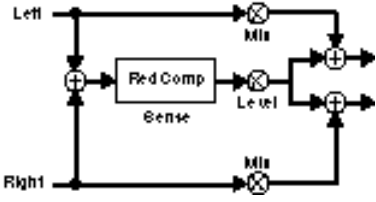

<b>Mix</b>	0-100%	Dry/Wet ratio
<b>Level</b>	Off, -89dB to +6dB	Amount of effect in processed signal
<b>Sense</b>	0-100	Sensitivity (Pre-Compressor level)

61 190

\* = Interpolated; ( ) = Option of preceding parameter

7-14

Download from Wwww.Somanuals.com. All Manuals Search And Download.

Block 11
Block 11
**Blue Comp**

<b>Mix</b>	0-100%	Dry/Wet ratio
<b>Level</b>	Off, -89dB to +6dB	Amount of effect in processed signal
<b>Sense</b>	-72dB to +24dB	Sensitivity (Pre-Compressor level)
<b>Thrsh</b>	-83dB to 0dB	Gain reduction threshold
<b>Gain</b>	-72dB to +24dB	Post-Compressor level
<b>ATime</b>	0-2000 ms	Attack time
<b>RTime</b>	0-2000 ms	Release time

Blue Comp is a recreation of another popular compression pedal, the CS-3. Like the CS-3 it has variable Sustain (Sense), Threshold (Thrsh), Gain, Attack (ATime) and Release (RTime) parameters. These versatile controls make it flexible enough to be used with many different styles and any type of guitar (including acoustic and bass). Blue Comp is useful in front of an amp or in the effects loop. Follow a Chorus or Detune effect with Blue Comp to produce a "chime-like" effect ala Andy Summers with Police. In fact, you can use two at once. For example, connect two in series in front of an overdrive for super smooth sustain that's perfect for slide playing.

49 190

Block 11
Block 11
**DigiDrive1 and DigiDrive2**

**DigiDrive1**

**DigiDrive2**

<b>Mix</b>	0-100%	Dry/Wet ratio
<b>Level</b>	Off, -89dB to +6dB	Amount of effect in processed signal
<b>Drive</b>	0-100	Amount of digital distortion
<b>Low</b>	-72dB to +24dB	Pre-Drive low frequency cut/boost
<b>Mid</b>	-72dB to +24dB	Pre-Drive mid frequency cut/boost
<b>High</b>	-72dB to +24dB	Pre-Drive high frequency cut/boost

The DigiDrive 1 and 2 effects combine digital distortion with 3-band tone controls. In DigiDrive1, the tone controls are in front of the distortion. In DigiDrive 2, the tone controls follow the distortion. The distortion produced by these effects is not meant to mimic analog distortion, but to provide an alternative sound. (Think "digital fuzz box."). The next time you're looking for an in-your-face fuzz effect, pump one of these into your amp. You might be surprised at what comes out.

56 190

DigiDrive1

53 190

DigiDrive2

\* = Interpolated; ( ) = Option of preceding parameter

Block 11
Block 12

## OctaBuzz

OctaBuzz is a very simple effect that mimics the “full wave rectifier” circuit used in many octave fuzz pedals, like the Octavia. Another signature Hendrix effect, (Purple Haze, Who knows, etc.) it is not a pretty sound, and requires a little effort to make it sing.

Play single notes above the 12th fret to get a screaming tone an octave higher. Single bass notes can produce ring modulator-like sounds. Double-stops and chords produce wierd electronic hash. Like the original, the effect is quite dynamic — you can get a wide variety of sounds just by changing your pick attack.

In general, the effect is more prominent with lighter playing. OctaBuzz is most effective in front of other distortion effects and the guitar amp. In many of the recorded classic octave fuzz performances, the distortion controls of the stomp box were turned down. (Distortion was added by the guitar amp, or by an additional distortion pedal after the octave fuzz pedal.) Try inserting the Screamer or Distortion gain effects between OctaBuzz and your amp to get the full bore sound. Hendrix sometimes put a wah between the octave fuzz and the distortion — you can too.

<b>Mix</b>	0-100%	Dry/Wet ratio
<b>Level</b>	0ff, -89dB to +6dB	Amount of effect in processed signal

15 190

\* = Interpolated; ( ) = Option of preceding parameter

Block 11
Block 11
**SweepFilter**

<b>Mix</b>	0-100%	Dry/Wet ratio
<b>Level*</b>	Off, -89 to +6dB	Amount of effect in the processed signal
<b>Fc*</b>	20-20000Hz	Corner frequency offset of filter
<b>FRes*</b>	1-100	Filter resonance: 7=a maximally flat filter
<b>Mod*</b>	20-20000Hz	added to corner frequency offset to produce corner frequency
<b>Scale*</b>	-100 to +100%	scales Mod
<b>Pan*</b>	50L to C to 50R	Left/right pan control

SweepFilter simulates a Moog-type resonant low-pass filter. Cut-off frequency and output level are interpolated, and can be swept. The performance of this filter is high enough that it can be used as a lowpass filter for hiss reduction.

The parameters were designed to allow synthesizer-like control of the filter. For example: Use FC like the manual "cutoff" knob of an analog synth – set it to the filter frequency desired when all modulation sources are at minimum.

Use Mod as the patch destination for as many as five modulation sources (LFO, Rand, Env, LastNote, etc.).

Use Scale as a master depth control for all modulation sources.

92 190

Block 11
Block 11
**1-Band (M)**

<b>Mix</b>	0-100%	Dry/Wet ratio
<b>Level</b>	Off, -89 to +6dB	Amount of effect in the processed signal
<b>Gain</b>	-72 to +24dB	Boost/cut gain of filter
<b>Fc</b>	20-20000Hz	Center or corner frequency of filter
<b>Q</b>	0.1-10.0	Q of filter
<b>Mode</b>	LShlf, Band, HShlf	Determines EQ type

The 1-Band (M) effect provides a single band of double-precision parametric EQ with adjustable center frequency, Q, boost/cut and filter type (low shelf, band, high shelf).

50 190

\* = Interpolated; ( ) = Option of preceding parameter

**Block Block Wah 1, Wah 2 and PedalWah1, PedalWah2**

Wah is a mono wah filter modeled after two classic wah-wah pedals. With Sweep selected, press **Options** to select Model C (CryBaby) or Model V (Vox). These models capture both the characteristic signature and non-linear pedal response of the original pedals. Bass allows you to change the wah from a band-pass type to a low-pass type effect by progressively adding more low end. (Try it with bass and keyboards.) Resp controls how quickly the wah responds to changes of Sweep. (100 is very fast, 0 is very, very slow).

To make a Mutron-like envelope filter, patch sweep to Env. Use Resp to control the effect's responsiveness to changing dynamics.

To make an Auto Wah effect, try patching Sweep to an LFO sine or triangle wave.

Wah 2 uses the same vintage wabs as Wah 1 with a built-in compressor following the wah. (All of the compression parameters are fixed and, therefore, invisible.) The compressor smooths out some of the peakiness that can occur in different portions of the sweep, while at the same time adding some sustain and punch to the overall effect. The end result is a wah that cuts through when you kick it on.

The Pedal Wah effects are identical to Wah 1 and Wah 2 except the Sweep parameter is hard-wired to the Foot Pedal input on the MPX G2 rear panel. If you are using the MPX R1 MIDI Remote Controller, these effects will be automatically connected to the control pedal — you don't have to make any patches — just load the effect and start playing.

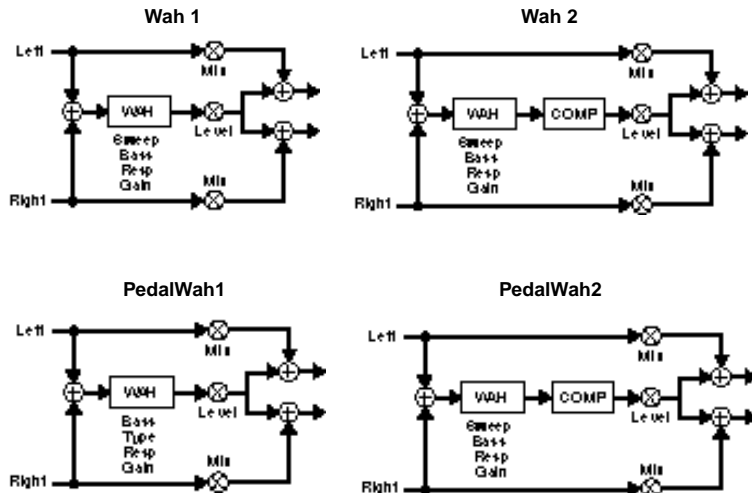

<b>Mix</b>	0-100%	Dry/Wet ratio
<b>Level</b>	Off, -89 to +6dB	Amount of effect in processed signal
<b>Sweep</b>	0-100	Wah center frequency (available only in Wah 1 & Wah 2)
<b>(Type)</b>	C, V	C= Crybaby, V = Vox
<b>Bass</b>	0-100	Adds low frequency boost to the wah
<b>Resp</b>	0-100	Responsiveness to changes in sweep
<b>Gain</b>	-72dB to +24dB	Post-Wah cut/boost

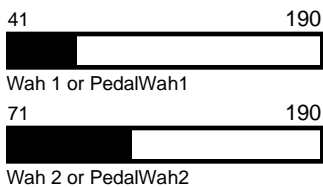

\* = Interpolated; ( ) = Option of preceding parameter

**Block 1 Block 2 Volume (M), Volume (S) and Volume (D)**

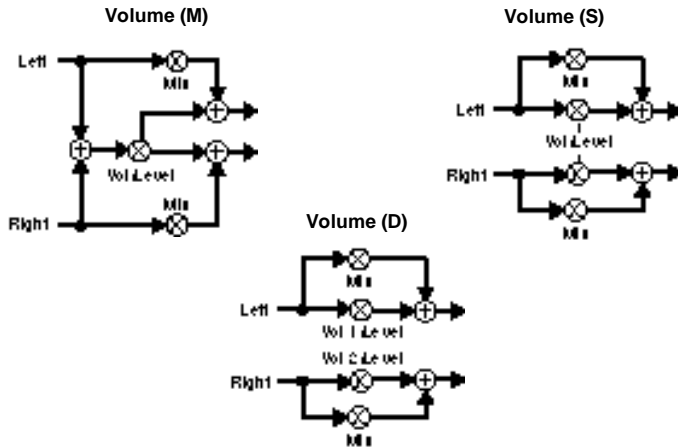

Mix	0-100%	Dry/Wet ratio
Level*	Off, -89 to +6dB	Amount of effect in the processed signal
Vol*	0-100%	Amount of effect in the processed signal

The Volume effects can be placed in front of, or behind, other effect blocks to provide smooth level control through a 95dB range. You can use them for dynamic input or output control, EQ input trim (helpful when adding large amounts of gain with an EQ effect), stereo to mono mixer, cross fade controls, volume pedal, etc.

In **Volume(M)** the left and right inputs are mixed together, then sent to both outputs through a volume control.

In **Volume (S)** the left and right inputs are sent through a ganged pair of volume controls.

In **Volume (D)** the left and right inputs are sent through independent volume controls.

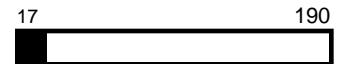

Volume (M)

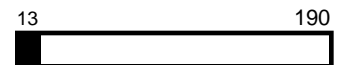

Volume (S)

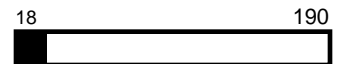

Volume (D)

**Block 1 Block 2 PedalVol and ExtPedalVol**

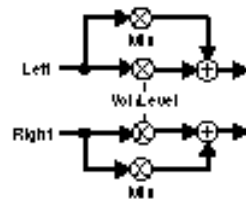

Mix	0-100%	Dry/Wet ratio
Level*	Off, -89dB to +6dB	Amount of effect in processed signal

PedalVol is the same as Volume (S), except the Vol parameter is hardwired to the Foot Pedal input on the MPX G2. When using the MPX R1 MIDI Remote Controller, this parameter is automatically connected to the R1's built-in pedal. This means that no patching is required to create a volume pedal effect.

ExtPedalVol is hardwired to the External Pedal input of the MPX R1, allowing you to easily create programs with both a Volume and Wah pedal available simultaneously.

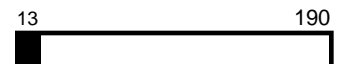

PedalVol and ExtPedalVol

\* = Interpolated; ( ) = Option of preceding parameter

**Effect Effect Test Tone**

Test Tone is an audio sine wave generator with its output quantized to correspond with the pitches of a chromatic scale (A = 440 Hz) over a nine-and-one-half octave range. It is provided primarily as a convenient way of generating test tones and tuning references.

Bal controls the relative level of left and right output attenuation. When Bal=-50, the left output has no attenuation, and the right output is fully attenuated. When Bal=0, neither output is attenuated. When Bal=+50, the left output is fully attenuated and the right output has no attenuation. Level and Bal can be patched to a global LFO to get tone bursts, etc. Pitch accuracy is better than 1/4 cent.

<b>Mix</b>	0-100%	Dry/Wet ratio
<b>Level*</b>	Off, -89 to +6dB	Amount of effect in the processed signal
<b>Note</b>	C0-G10	Sine wave pitch, expressed as MIDI notes (0=C0, 127=G10)
<b>Bal*</b>	-50 to +50	Relative level of left and right output attenuation

Handy pitches:  
 D#0=19.445Hz    A4=440Hz    B5=987.77Hz    D#8=4978Hz    D#9=9956Hz

33 190

**Effect Effect Click**

This effect is a simple metronome which is automatically connected to **Tap**. Press **Tap** twice to set the tempo.

This effect can be used as an input source for auditioning reverbs and delays. It is also a convenient timing reference for the JamMan effect, where the click is automatically muted until the loop is tapped.

<b>Mix</b>	0-100%	Dry/Click ratio
<b>Level</b>	Off, -89dB to +6dB	Amount of Click in processed signal

14 190

\* = Interpolated; ( ) = Option of preceding parameter

The chorus effects are generally used to enhance a sound by modulating delay times and/or frequency content in various ways. Of course, the classic effects of this type : Chorus, Flanger and Phaser are all here – along with several other variations such as: Rotary Cab, Aerosol, Orbits, Centrifuge, Comb 1 and Comb 2.

### Chorus Effects



All of the Chorus effects have one or two resonance parameters. These parameters control the level and phase of the effect output signal that is recirculated into the effect inputs. Use care when adjusting these parameters, as they can cause overload (or feedback-like howls) if they are set too high — even with little or no input signal present. As a general rule, the combined value of any resonance parameters should always be less than 100 — but pay close attention to levels whenever the total resonance is above 50. If you use high resonance values (to produce a deep flange effect, for example) and the clip LEDs light, try turning down the level of the effect that precedes the Chorus block.

Chorus+
Chorus

<b>Mix</b>	0-100%	Dry/Wet ratio
<b>Level</b>	Off, -89 to +6dB	Amount of effect in the processed signal
<b>Rate1</b>	0-50Hz or 1:24-24:1 cycles/beat	Left and right A rate
<b>(Rate1 Units)</b>	Selects frequency or cycles/beat	
<b>PW 1</b>	0-100%	Left and right A pulse width
<b>Dpth1*</b>	0-100%	Left and right A depth
<b>Rate2</b>	0-50Hz or 1:24-24:1 cycles/beat	Left and right B rate
<b>(Rate 2 Units)</b>	Selects frequency or cycles/beat	
<b>PW 2</b>	0-100%	Left and right B pulse width
<b>Dpth2*</b>	0-100%	Left and right B depth
<b>Res 1</b>	-100 to +100	Left to right resonance
<b>Res 2</b>	-100 to +100	Right to left resonance

60
190

This is a true stereo, multi-voice chorus. Use it to enrich guitars, keyboards, etc. It has Dual 2-tap modulators with cross resonance. The Pulse Width controls allow independent adjustment of the waveshape. (At 0, the sinewave becomes a sawtooth with a fast rise and slow fall.) The Depth controls provide adjustment of the chorus from 0-100%.

\* = Interpolated; ( ) = Option of preceding parameter



**Chorus** **Detune (M)**

Detune effects are useful for thickening up sounds by adding delayed/pitch shifted versions of the original source. They can be particularly effective when used to simulate double-tracking. They are also great alternatives to chorus effects as a detuner can add the richness of a chorus effect without the audible sweep caused by the chorus rate. Detuners are also traditionally used to turn a six-string guitar into a twelve-string, or an in-tune piano into a honky-tonk. The MPX G2 detuner is optimized to provide very fine amounts of pitch shift.

Detune (M) is a single-channel detuner that creates a pair of signals, pitch-shifted up and down from the input. The pair is always mixed together, and presented equally to the outputs.

29 190

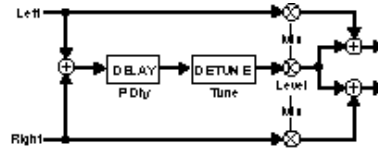

<b>Mix</b>	0-100%	Dry/Wet ratio
<b>Level</b>	Off, -89 to +6dB	Amount of effect in the processed signal
<b>Tune</b>	0-100	Pitch shift
<b>(Optimize)</b>	10-35ms	An option of Tune — Adjusts the amount of delay in the tuner
<b>P Dly</b>	0-35ms	Amount of delay before the onset of the effect

As the detune effects use up relatively few processing resources, they can be combined with reverb and many other effects. When creating effects that don't require pitch shifting by large intervals (semitones) the detuners are the most efficient choice.

\* = Interpolated; ( ) = Option of preceding parameter

**Chorus Flanger (M), Flanger24 (M) and Flanger (S)**

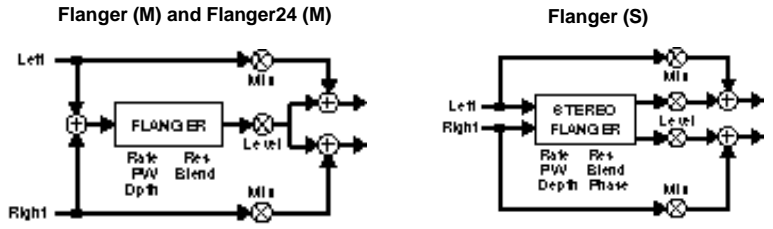

<b>Mix</b>	0-100%	Dry/Wet ratio
<b>Level*</b>	Off, -89 to +6dB	Amount of effect in the processed signal
<b>Rate</b>	0-50Hz or 1:24-24:1 cycles/beat	Flange rate or period ratio
<b>(Rate Units)</b>		Selects frequency or cycles/beat
<b>PW</b>	0-100%	Flange pulse width
<b>Depth*</b>	0-100%	Flange depth
<b>Phase</b>	0°-270°	In Flanger (S) sets the phase difference between the right and left flangers
<b>Res</b>	-100 to +100	Resonance
<b>Blend</b>	0-100%	Amount of fixed tape mixed with moving tape

Originally, flanging effects were created by simultaneously playing two identical programs on two tape recorders, then using hand pressure against the flange of the tape reels to slow down first one machine, then the other. The result was a series of changing phase cancellations and reinforcements, providing a comb filter and a characteristic swishing, tunneling and fading sound.

In the MPX G2, the Flanger effects are two-tap delays. The first tap is fixed, and the second sweeps past it. Mixing the two taps together creates a flanging effect. In Flanger (M), the moving tap is swept with an internal LFO.

In the stereo version, Flanger (S), the delays are modulated by two sine waves from the same LFO. The phase relation between the two waves is set by the Phase parameter.

Flanger24 (M) is a higher precision (32-bit) flanger with identical parameters to Flanger (M).

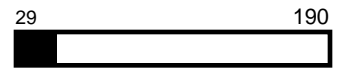

Flanger (M)

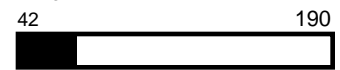

Flanger24 (M)

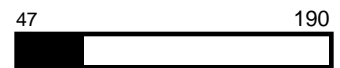

Flanger (S)

\* = Interpolated; ( ) = Option of preceding parameter

**Chorus Rotary Cab**

This effect simulates a Leslie speaker with one pair of stereo mics on the rotating low-frequency drum, and another pair on the rotating high-frequency horn. Bal sets the relative mix of Drum and Horn mics. Width controls the stereo spread of both pairs of mics. Rate and Depth 1 control the speed and depth of the rotating low-frequency drum. Rate 2 and Depth 2 control the speed and depth of the rotating high-frequency horn. The preset, **Rotary Cab**, is set up so that A/B switches the speed from fast to slow. Different A and B rates are used to simulate the inertia of the mechanical system.

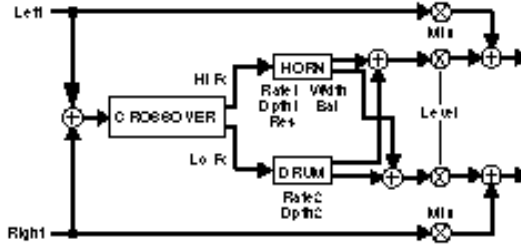

<b>Mix</b>	0-100%	Dry/Wet ratio
<b>Level*</b>	Off, -89 to +6dB	Amount of effect in the processed signal
<b>Rate1</b>	0-50Hz or 1:24-24:1 cycles/beat	Drum rate or period ratio
<b>(Rate1 Units)</b>		Selects frequency or cycles/beat of drum
<b>Dpth1*</b>	0-100%	Drum depth (tremolo)
<b>Rate2</b>	0-50Hz or 1:24-24:1 cycles/beat	Horn rate or period ratio
<b>(Rate2 Units)</b>		Selects frequency or cycles/beat of horn
<b>Dpth2*</b>	0-100%	Horn depth (tremolo)
<b>Res</b>	-100 to +100	Resonance
<b>Width*</b>	0-100%	Panning width for horn and drum
<b>Bal</b>	-50 to +50	Relative level of horn and drum

**Chorus Aerosol**

Aerosol is a true stereo chorus/flanger with dual rate, depth and resonance controls. It can produce very deep resonant flange sweeps, subtle multi-vibrato, stereo image enhancement and a wide variety of other chorus and flanger-like effects.

A pair of single-tap modulated delays is each modulated by a separate LFO. Pulse Width allows independent adjustment of left and right LFOs from full left to full right skew. (At 0, the sinewave becomes a sawtooth with a fast rise and slow fall.) Depth controls provide adjustment of modulated depth from 0-100%.

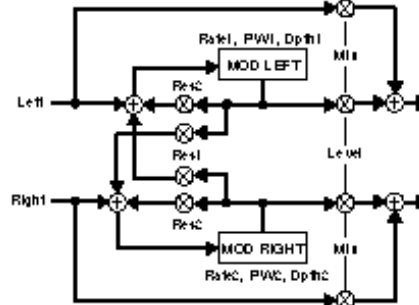
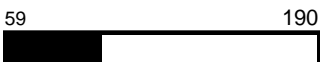

<b>Mix</b>	0-100%	Dry/Wet ratio
<b>Level</b>	Off, -89 to +6dB	Amount of effect in the processed signal
<b>Rate1</b>	0-50Hz or 1:24-24:1 cycles/beat	Left Mod rate or period ratio.
<b>(Rate 1 Units)</b>		Selects frequency or cycles/beat
<b>PW 1</b>	0-100%	Left Mod pulse width
<b>Dpth1*</b>	0-100%	Left Mod depth (tremolo)
<b>Rate2</b>	0-50Hz or 1:24-24:1 cycles/beat	Right Mod rate or period ratio.
<b>(Rate 2 Units)</b>		Selects frequency or cycles/beat
<b>PW 2</b>	0-100%	Right Mod pulse width
<b>Dpth2*</b>	0-100%	Right Mod depth (tremolo)
<b>Res1</b>	-100 to +100	Cross resonance
<b>Res2</b>	-100 to +100	Resonance

\* = Interpolated; ( ) = Option of preceding parameter

Chorus
Orbits

<b>Mix</b>	0-100%	Dry/Wet ratio
<b>Level*</b>	Off, -89 to +6dB	Amount of effect in the processed signal
<b>Rate1</b>	0-50Hz or 1:24-24:1 cycles/beat	Left Mod and Pan rate or period ratio
<b>(Rate 1 Units)</b>		Selects frequency or cycles/beat
<b>PW 1</b>	0-100%	Left Mod and Pan pulse width
<b>Sync1</b>	-120° to +120°	Phase difference between left LFO Mod and Pan
<b>Dpth1*</b>	0-100%	Left Mod and Pan depth
<b>Rate2</b>	0-50Hz or 1:24-24:1 cycles/beat	Right Mod and Pan rate or period ratio
<b>(Rate 2 Units)</b>		Selects frequency or cycles/beat
<b>PW 2</b>	0-100%	Right Mod and Pan pulse width
<b>Sync2</b>	-120° to +120°	Phase difference between right LFO Mod and Pan
<b>Dpth2*</b>	0-100%	Right Mod and Pan depth
<b>Res</b>	-100 to +100	Resonance
<b>Width*</b>	0-100%	Panning width

Orbits processes the left and right inputs independently with a pair of modulated delay/auto panners. This effect can be used to create spatial effects via a combination of Doppler and level panning.

In the Orbits effect, Pulse Width controls allow independent adjustment of left and right LFOs from full left to full right skew. (At 0, the sinewave becomes a sawtooth with a fast rise and slow fall.) Depth controls provide adjustment of Mod and Pan depth from 0-100%. Width allows adjustment of the panning depth from 0 (mono) to 100 (maximum stereo spread).

\* = Interpolated; ( ) = Option of preceding parameter

**Chorus Centrifuge1 and Centrifuge2**

The Centrifuge effects have a pair of modulated left and right delays routed into a single auto panner. In these effects, mod and pan rate and depth (Rate1, Depth1) are modulated by an additional set of rate and depth controls (Rate2, Depth2). These can create unique chorus and flanger effects with complex, undulating modulation rhythms.

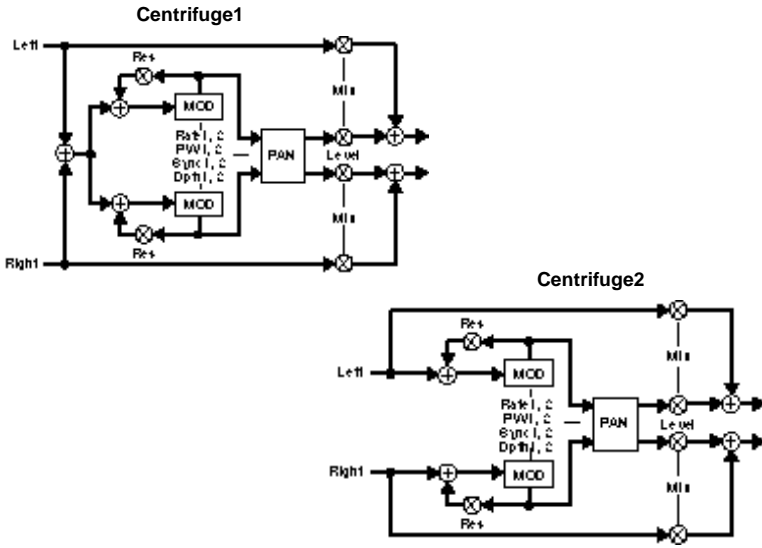

<b>Mix</b>	0-100%	Dry/Wet ratio
<b>Level*</b>	Off, -89 to +6dB	Amount of effect in the processed signal
<b>Rate1</b>	0-50Hz or 1:24-24:1 cycles/beat	Left Mod and Pan rate or period ratio
<b>(Rate 1 Units)</b>		Selects frequency or cycles/beat
<b>PW 1</b>	0-100%	Left Mod and Pan pulse width
<b>Sync1</b>	-120 to +120	Phase difference between left LFO Mod and Pan
<b>Dpth1*</b>	0-100%	Left Mod and Pan depth
<b>Rate2</b>	0-50Hz or 1:24-24:1 cycles/beat	Right Mod and Pan rate or period ratio
<b>(Rate 2 Units)</b>		Selects frequency or cycles/beat.
<b>PW 2</b>	0-100%	Right Mod and Pan pulse width
<b>Sync2</b>	-120 to +120	Phase difference between right LFO Mod and Pan
<b>Dpth2*</b>	0-100%	Right Mod and Pan depth
<b>Res</b>	-100 to +100	Resonance

35 190



Centrifuge1

43 190



Centrifuge2

\* = Interpolated; ( ) = Option of preceding parameter

**Chorus Comb 1 and Comb 2**

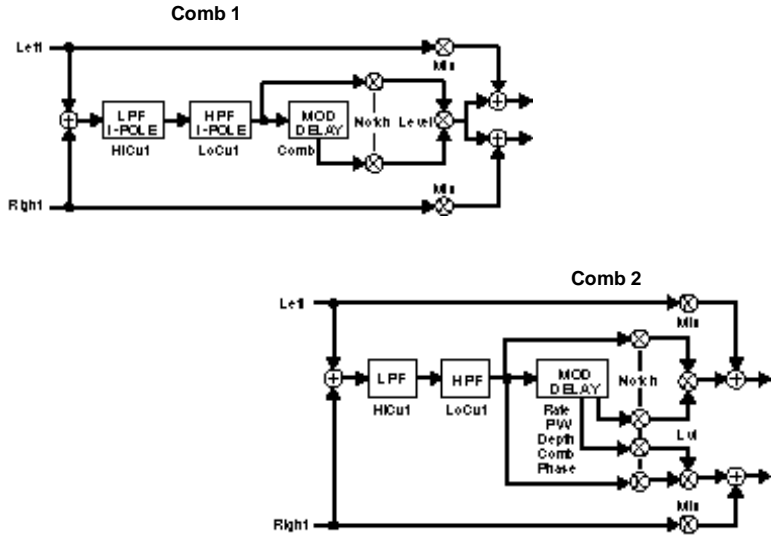

<b>Mix</b>	0-100%	Dry/Wet ratio
<b>Level</b>	Off, -89 to +6dB	Amount of effect in the processed signal
<b>LoCut</b>	100-10000Hz	Corner frequency of the low cut filter
<b>HiCut</b>	100-10000Hz	Corner frequency of the high cut filter
<b>Comb</b>	0-100	A microdelay which positions the notch
<b>Notch</b>	-100 to +100	Increases the audibility of the notch Ratio of filter and delay output levels: Notch      Filter Output      Mod Delay Output -100      0%      -100% -50      100%      -100% 0      100%      0% 50      100%      100% 100      0%      100%
<b>Rate</b>	0-50Hz or 1:24-24:1 cycles/beat	Mod rate or period ratio (Comb 2 only)
<b>(Rate Units)</b>		Selects frequency or cycles/beat (Comb 2 only)
<b>PW</b>	0-100%	Mod pulse width (Comb 2 only)
<b>Depth*</b>	0-100%	Mod depth (Comb 2 only)
<b>Res</b>	-100 to +100	Resonance (Comb 2 only)
<b>Phase</b>	0°-270°	Phase difference between the right and left Mod (Comb 2 only)

The Comb effects work by combining the original input signal with a micro-delayed version. The tiny delay difference between the two signals causes certain frequencies to be cancelled or reinforced when the two are combined. The result is a highly colored version of the original source. The coloration can be "tuned" with the Comb (Comb 1) or Depth (Comb 2). Low and High pass filters are included so you can limit the frequency band in which the combing occurs.

Comb 1 is a mono comb with single-pole low and high cut filters. There are two ways to get the comb effect. The first is to set mix to 100% (wet), then set Notch to 50 or -50. This essentially creates a band-limited signal (limited by LoCut and HiCut) which is then run through a comb. You can also set mix= 50%, Lvl = 0dB, and Notch= ±100. In this case, the band-limiter is part of the comb. In this version, the effect produces shallower notch depths outside the band-limit region.

Comb 2 is a dual mono comb with a second tap, controlled by a single LFO with adjustable phase. The phase relation between the two waves can be adjusted between 0-270°.

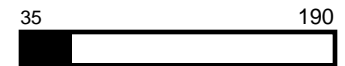

Comb1

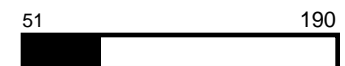

Comb2

\* = Interpolated; ( ) = Option of preceding parameter

**Chorus** Volume (M), Volume (S) and Volume (D)

The Volume effects can be placed in front of, or behind, other effect blocks to provide smooth level control through a 95dB range. You can use them for dynamic input or output control, EQ input trim (helpful when adding large amounts of gain with an EQ effect), stereo to mono mixer, cross fade controls, volume pedal, etc.

In **Volume(M)** the left and right inputs are mixed together, then sent to both outputs through a volume control.

In **Volume (S)** the left and right inputs are sent through a ganged pair of volume controls.

In **Volume (D)** the left and right inputs are sent through independent volume controls.

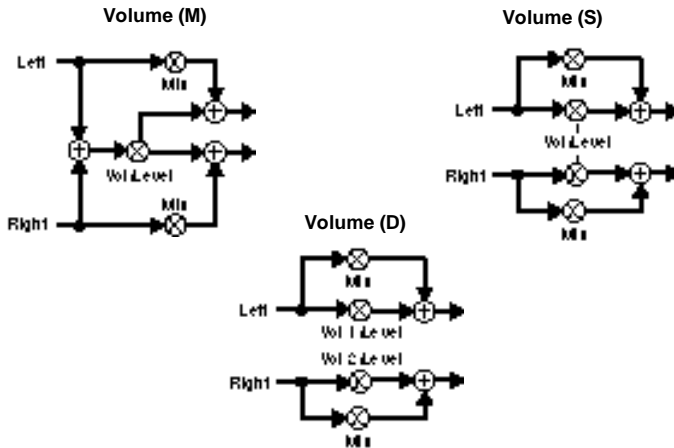

Mix	0-100%	Dry/Wet ratio
Level*	Off, -89 to +6dB	Amount of effect in the processed signal
Vol*	0-100%	Amount of effect in the processed signal

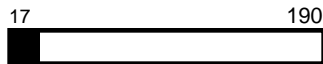

Volume (M)

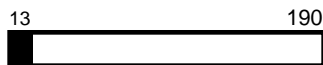

Volume (S)

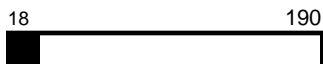

Volume (D)

**Chorus** PedalVol and ExtPedalVol

PedalVol is the same as Volume (S), except the Vol parameter is hardwired to the Foot Pedal input on the MPX G2. When using the MPX R1 MIDI Remote Controller, this parameter is automatically connected to the R1's built-in pedal. This means that no patching is required to create a volume pedal effect.

ExtPedalVol is hardwired to the External Pedal input of the MPX R1, allowing you to easily create programs with both a Volume and Wah pedal available simultaneously.

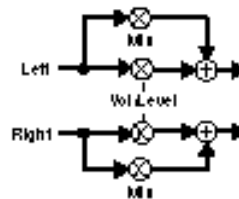

Mix	0-100%	Dry/Wet ratio
Level*	Off, -89dB to +6dB	Amount of effect in processed signal



PedalVol and ExtPedalVol

\* = Interpolated; ( ) = Option of preceding parameter

The Delay effects include delay, echo, looping and ducking effects. Delays are high quality digital delays. Echoes are similar to delays, but low-pass filters have been added to simulate the high-frequency rolloff that occurs naturally in acoustic echoes and in echoes created with analog tape.

All MPX G2 Delay effects allow you to choose how delay times will be displayed. Select any Time parameter and press **Options**. The following choices are available for each Time parameter:

- ms: time is displayed as milliseconds (delay time is fixed)
- feet: time is displayed as feet – the equivalent distance from a sound source required to produce the delay (delay time is fixed)
- meters: time is displayed as meters – the equivalent distance from a sound source required to produce the delay (delay time is fixed)
- echoes/beat: time is displayed as a rhythmic ratio of echoes per beat (delay time varies with Tempo and can be changed at any time by pressing TAP twice.)
- TAP ms: time is displayed as milliseconds (new delay value can be “tapped in” when this Time value is displayed for editing).

Another feature shared by all MPX G2 Delay effects is Fbk Insert. This option of the feedback parameter allows you to route the outputs of another effect block to the delay’s feedback input. If the other block is after the delay block, Fbk Insert will place it inside the delay/echo feedback loop. This powerful feature is the key to obtaining many classic effects.

## Delay Effects





**Delay (M), Delay (S) and Delay (D)**

Delay (M) is a simple mono delay with feedback.

Delay (S) is a simple stereo delay with feedback.

Delay (D) is a dual delay with feedback, crossfeedback, independent output level adjusts, and panners.

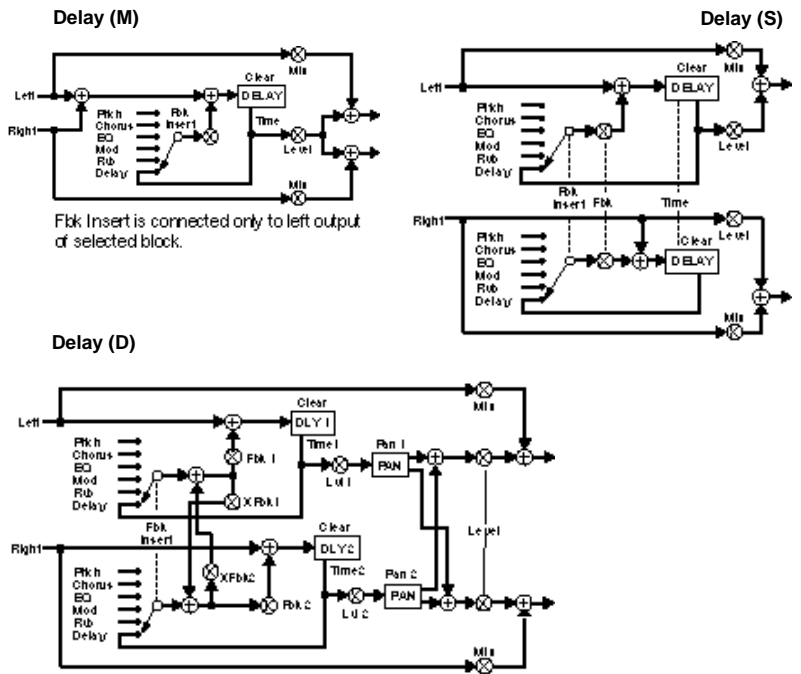

Fbk Insert is connected only to left output of selected block.

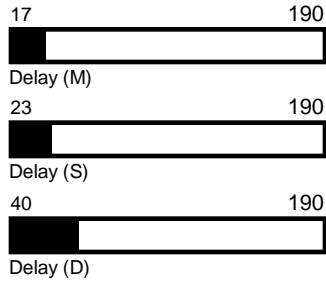

<b>Mix</b>	0-100%	Dry/Wet ratio
<b>Level</b>	Off, -89 to +6dB	Amount of effect in the processed signal
<b>Time</b>	0-20000ms (M) 1:24-24:1echo/beat, 0-22600 ft, 0-6880 M	Delay time (in stereo and dual versions, 0-10,000ms, 0-11300ft, 0-3440 M)
<b>(Time Units)</b>		Selects ms, note, feet, meters, or Tap ms
<b>Lvl 1*</b>	Off, -95 to 0dB	In Delay (D), controls left delay output level
<b>Lvl 2*</b>	Off, -95 to 0dB	In Delay (D), controls right delay output level
<b>Pan 1*</b>	50L to C to 50R	In Delay (D), controls left delay output panner
<b>Pan 2*</b>	50L to C to 50R	In Delay (D), controls right delay output panner
<b>Fbk 1</b>	-100 to +100%	Left feedback level
<b>(Fbk insert)</b>	Effect1, Effect2, Chorus, Delay, Reverb, EQ	The outputs of the selected source are scaled by Fbk
<b>Fbk 2</b>	-100 to +100%	Right feedback level
<b>XFbk1</b>	-100 to +100%	In Delay (D), controls level from left feedback source to right delay in
<b>XFbk2</b>	-100 to +100%	In Delay (D), controls level from right feedback source to left delay in
<b>Clear</b>	Off, On	When On, mutes and resets the delay

\* = Interpolated; ( ) = Option of preceding parameter

**Delay Echo (M), Echo (S) and Echo (D)**

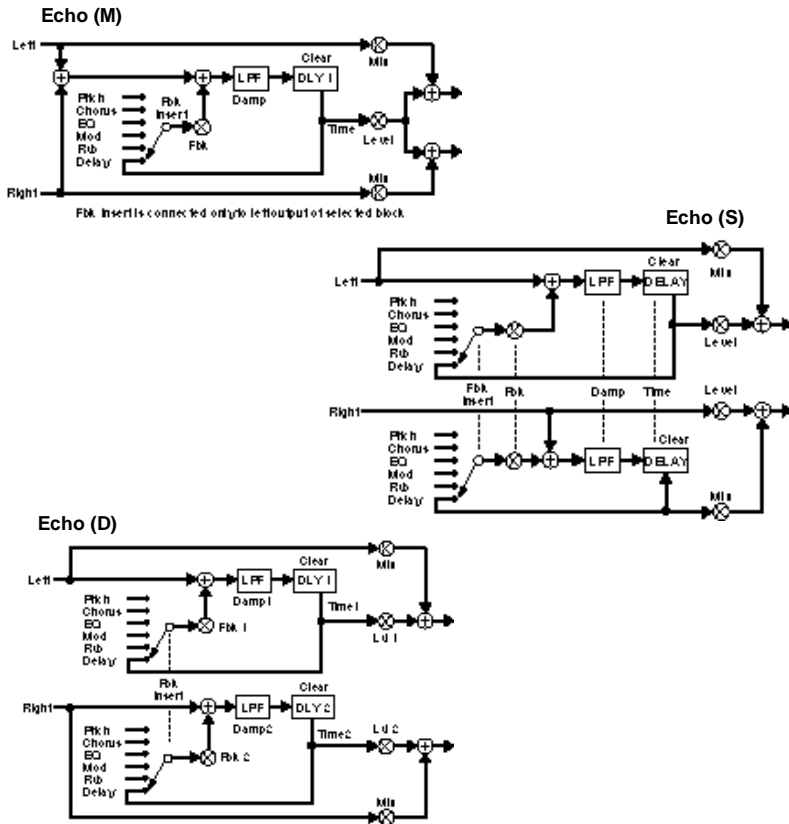

The Echo effects are similar to the Delay effects, except the feedback inputs are sent through 1-pole low-pass filters.

Damp provides control over the cutoff frequency of the filter. (Increasing Damp lowers cutoff frequency.)

<b>Mix</b>	0-100%	Dry/Wet ratio
<b>Level</b>	Off, -89 to +6dB	Amount of effect in the processed signal
<b>Time</b>	0-20000ms 1:24-24:1echo/beat, 0-22600 ft, 0-6880 M	Delay time in mono version
<b>(Time Units)</b>		Selects ms, note, feet, meters, or Tap ms
<b>Time1</b>	0-10,000ms 1:24-24:1echo/beat, 0-11,300 ft, 0-3440 M	Left delay time
<b>(Time1 Units)</b>		Selects ms, note, feet, meters, or Tap ms
<b>Time2</b>	0-10,000ms, 1:24-24:1echo/beat 0-11,300 ft, 0-3440 M	Right delay time
<b>(Time2 Units)</b>		Selects ms, note, feet, meters, or Tap ms
<b>Lvl 1*</b>	Off, -95 to 0dB	In Echo (D) controls left delay output level
<b>Lvl 2*</b>	Off, -95 to 0dB	In Echo (D) controls right delay output level
<b>Fbk 1</b>	-100 to +100%	Left feedback level
<b>(Fbk insert)</b>	Effect1, Effect2, Chorus, Delay, Reverb, EQ	The outputs of the selected source are scaled by Fbk
<b>Fbk 2</b>	-100 to +100%	Right feedback level
<b>Damp1</b>	0 to +100%	Cutoff frequency of low-pass filter in left feedback path
<b>Damp2</b>	0 to +100%	Cutoff frequency of low-pass filter in right feedback path
<b>Clear</b>	Off, On	When On, mutes and resets the delay

21	190
Echo (M)	
31	190
Echo (S)	
40	190
Echo (D)	

\* = Interpolated; ( ) = Option of preceding parameter



Delay
JamMan

Fbk Insert is connected only to left output of selected block.

<b>Mix</b>	0-100%	Dry/Wet ratio
<b>Level</b>	Off, -89dB to +6dB	Amount of effect in processed signal
<b>Size</b>	0-20,000ms	Loop size in ms (display only, this is set by pressing Tap)
<b>Fbk</b>	-100 to +100%	Feedback level (defaults to 100% while looping)
<b>Clear</b>	Off, On	Mutes and resets the loop when On
<b>Layer</b>	Off, On	Adds new material on top of loop while On
<b>Replc</b>	Off, On	Replaces existing loop with new material while On
<b>Delay</b>	Off, On	Turns looper into mono delay while On
<b>MuteS</b>	Off, On	Mutes loop while On, restarts from beginning when Off

**JAM MAN** is an automatic phrasesampler that incorporates many of the features of the original Lexicon JamMan.

To create a simple loop, press **Tap** once when you want to start recording. (You can record up to 20 seconds — while recording, a meter showing the remaining memory is displayed automatically.) Press **Tap** a second time to stop recording and begin playback of the loop.

The JamMan effect can synchronize to an external MIDI Clock as well as to the MPX G2 internal clock. This makes it possible to synchronize your loops with any MIDI drum machine or sequencer.

To synchronize the JamMan loop with effects that use rates set for cycles/beat, set the Tempo Beat Value (in the **Edit** menu) to the number of beats you want to loop.

The JamMan effect has several special parameters that allow you to stop, restart and modify the loop in real time: **Clear**, **Layer**, **Replc**, **Delay**, and **Mute**. Each of these has only two values, On or Off - so they can easily be controlled via external footswitches or MIDI.

We've created some example presets to demonstrate how these features work. See Amp Input & FX Loop programs 95-99, Amp Input Only programs 145-149 and Stand Alone programs 245-248.

JamMan parameters can also be controlled with MIDI Program Change messages when MPX G2 Program mode: **Option** is set to **Show members of MIDI Maps**. (See **MIDI Pgm Maps** in Chapter 5: *System Controls*.)

\* = Interpolated; ( ) = Option of preceding parameter

**Ducker**

Similar to Looper, with the wet output getting quieter as the input gets louder. When Sense is at 0, no ducking will occur. At 100 the input will be ducked by even the lowest input levels.

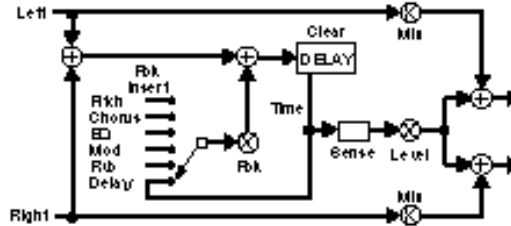

<b>Mix</b>	0-100%	Dry/Wet ratio
<b>Level</b>	Off, -89 to +6dB	Amount of effect in the processed signal
<b>Time</b>	0 -20,000ms 1:24-24:1 echo/beat 0-22,600 ft, 0-6880 M	Delay time
<b>(Time Units)</b>		Selects ms, note, feet, meters, or Tap ms
<b>Fbk</b>	-100 to +100%	Feedback level
<b>(Fbk insert)</b>	Effect1, Effect2, Chorus, Delay, Reverb, EQ	The left output of the selected source is scaled by Fbk
<b>Sense</b>	0-100	Amount of ducking
<b>RLs</b>	0-100	Envelope release time constant
<b>Clear</b>	Off, On	When On, mutes and resets the delay

28 190

\* = Interpolated; ( ) = Option of preceding parameter

### Reverb Effects



The MPX G2 Reverb effects provide a full suite of reverberation and ambience algorithms. All of the reverbs are true stereo in that different processing is applied to the left and right input signals. Dedicated processing resources are allocated to the reverb effects so that you can always load any reverb into any program, regardless of what other effects are loaded. The MPX G2's **Global Reverb** function allows reverb tails to ring out through program changes. (See **Global Effects** in Chapter 5: *System Controls*.)

Reverb
**Chamber**

Mix	0-100%	Dry/Wet ratio
Level	Off, -89 to +6dB	Amount of effect in the processed signal
Size	4.0-35.0 meters	Length of Chamber
Link	Off, On	Scales Decay and Spred with Size
Diff	0-100%	Increase of initial echo density over time
P Dly	0-250ms	Delay inserted before the onset of reverberation
Bass	0.2-4.0x	Reverb time for low frequency signals
Decay	0.07-65.4s	Reverb time for mid frequency signals
Xover	30Hz to 24.7kHz, Full	Frequency of transition from Decay to Bass
Rt HC	525Hz-24.7kHz, Flat	High frequency content of Decay
Shape	0-255	Contour of the reverberation envelope
Spred	0-255	Sustain of reverberation after initial build up

0
190

NO PROCESSING STEPS USED

The Chamber effect produces an even, relatively dimensionless reverberation, with little change in color as the sound decays. The initial diffusion is similar to the Hall effect, but the sense of space and size is much less obvious. This characteristic, along with the low color of the decay tail makes Chamber useful on a wide range of material. It is especially useful on spoken voice, giving a noticeable increase in loudness with very low color.

Reverb
**Hall**

Mix	0-100%	Dry/Wet ratio
Level	Off, -89 to +6dB	Amount of effect in the processed signal
Size	20-76.0 meters	Length of Hall
Link	Off, On	Scales Decay and Spred with Size
Diff	0-100%	Increase of initial echo density over time
P Dly	0-250ms	Delay inserted before the onset of reverberation
Bass	0.2-4.0x	Reverb time for low frequency signals
Decay	0.12-65.4s	Length of the reverb tail
Xover	30Hz to 24.7kHz, Full	Frequency of transition from Decay to Bass
Rt HC	525Hz-24.7kHz, Flat	High frequency content of Decay
Shape	0-255	Contour of the reverberation envelope
Spred	0-255	Sustain of reverberation after initial build up

0
190

NO PROCESSING STEPS USED

The Hall effect emulates a real concert hall. The reverberation is very clean, and designed to remain behind the direct sound — adding ambience, but leaving the source unchanged. This effect has a relatively low initial density which builds up gradually over time.

\* = Interpolated; ( ) = Option of preceding parameter

**Reverb Plate**

Plate effects were originally generated by large, thin sheets of metal suspended upright under tension on springs. Transducers attached to the plate would transmit a signal which would, in turn, vibrate the plate. Because the plate provided a denser medium than air, sounds broadcast through it would seem to be occurring in a large open space.

The Plate effect synthesizes the sound of metal plates, with high initial diffusion and a relatively bright, colored sound. This effect is designed to be heard as part of the music, mellowing and thickening the initial sound. It is a popular choice for enhancing popular music, particularly percussion.

0 190  
 NO PROCESSING STEPS USED

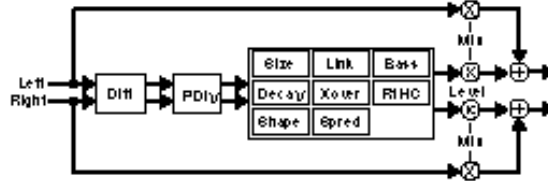

<b>Mix</b>	0-100%	Dry/Wet ratio
<b>Level</b>	Off, -89 to +6dB	Amount of effect in the processed signal
<b>Size</b>	4.0-76.0 meters	Length of room
<b>Link</b>	Off, On	Scales Decay and Spred with Size
<b>Diff</b>	0-100%	Increase of initial echo density over time
<b>P Dly</b>	0-250ms	Delay inserted before the onset of reverberation
<b>Bass</b>	0.2-4.0x	Reverb time for low frequency signals
<b>Decay</b>	0.07-65.4s	Length of the reverb tail
<b>Xover</b>	30Hz to 24.7kHz, Full	Frequency of transition from Decay to Bass
<b>Rt HC</b>	525Hz-24.7kHz, Flat	High frequency content of Decay
<b>Shape</b>	0-255	Contour of the reverberation envelope
<b>Spred</b>	0-255	Sustain of reverberation after initial build up

**Reverb Ambience**

The Ambience effect gives warmth, spaciousness and depth to a performance without coloring the direct sound, and is commonly used to add a room sound to recorded music or speech. The effect simulates reflections from room surfaces, with random reflections, a gradual decay of overall level, and a gradual narrowing of the bandwidth. DTime settings can be varied to create larger or smaller spaces while variations of D Lvl and Rt HC correspond to the hardness of the imaginary reflecting surfaces and the effects of air absorption on the high end of the sonic spectrum.

0 190  
 NO PROCESSING STEPS USED

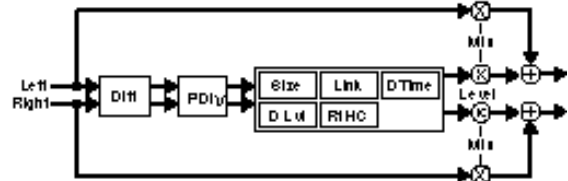

<b>Mix</b>	0-100%	Dry/Wet ratio
<b>Level</b>	Off, -89 to +6dB	Amount of effect in the processed signal
<b>Size</b>	4.0-76.0 meters	Length of room
<b>Link</b>	Off, On	Scales DTime with Size
<b>Diff</b>	0-100%	Increase of initial echo density over time
<b>P Dly</b>	0-250ms	Delay inserted before the onset of reverberation
<b>DTime</b>	0.07-65.4s	Length of the ambience tail
<b>D Lvl</b>	Off, -48dB to Full	Level of the ambience tail
<b>Rt HC</b>	0.5-21.2kHz	High frequency content of DTime

\* = Interpolated; ( ) = Option of preceding parameter

Reverb
Gate

<b>Mix</b>	0-100%	Dry/Wet ratio
<b>Level</b>	Off, -89 to +6dB	Amount of effect in the processed signal
<b>Time</b>	140-700ms	Reverb time for mid and low frequency signals
<b>Link</b>	Off, On	Scales Spred with Size
<b>Diff</b>	0-100%	Increase of initial echo density over time
<b>P Dly</b>	0-250ms	Delay inserted before the onset of reverberation
<b>LoSlp</b>	-16 to +16	Determines low frequency envelope shape
<b>HiSlp</b>	-16 to +16	Determines mid and high frequency envelope shape
<b>Xover</b>	30Hz to 24.7kHz, Full	Frequency of transition from LoSlp to Slope
<b>Rt HC</b>	525Hz-24.7kHz, Flat	High frequency content of Slope
<b>Shape</b>	0-255	Contour of the reverberation envelope
<b>Spred</b>	0-255	Sustain of reverberation after initial build up

0
190

NO PROCESSING STEPS USED

Gate is a reverb effect with a fairly constant sound and no decay until the reverb is cut off abruptly. This effect works well on percussion—particularly on snare and toms, but be sure to experiment with other sound sources as well.

The Mix, P Dly and Rt HC parameters are very important in this effect, allowing you to create anything from an enhancement or subtle thickening, to a solid wall of reverb.

\* = Interpolated; ( ) = Option of preceding parameter



**EQ Effects**



At its simplest, equalization is the process of cutting and boosting certain frequencies to make portions of program material more or less audible. This is generally accomplished by combining filters which affect a specific “band” of frequencies together with gain controls. The three types of filters commonly used to perform basic EQ functions are: High Cut, Low Cut and Bandpass/Notch.

High cut filters remove frequencies above a fixed level. As this allows frequencies below the threshold to pass through unchanged, high cut filters are also commonly referred to as “lowpass” filters.

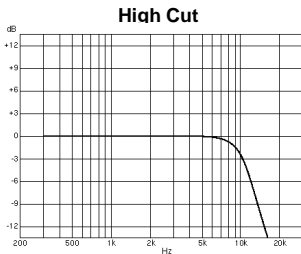

Low cut filters, which remove frequencies below a fixed level and allow higher frequencies to pass through are also known as “highpass” filters.

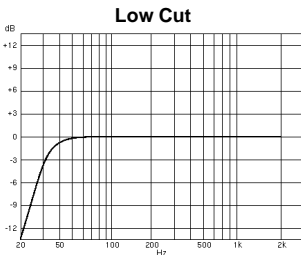

Bandpass/Notch filters allow only a certain range of frequencies to pass through without attenuation. They are plotted as curves, with a peak (or dip in the case of notch filters) at the center frequency.

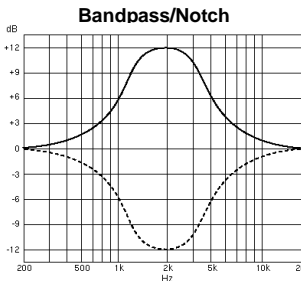

**Shelf filters**

When a specific frequency value is selected for cutting or boosting, and compensating gain controls are provided, a shelving filter is created, with gradual build up of the boost or cut to the selected frequency, followed by a leveling off beyond the selected frequency. When the effect of the filter is plotted, it resembles a shelf, with constant levels of boost or cut preceding and following the “knee” or “corner point” at the selected frequency.

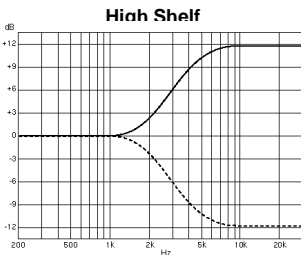

A typical application of these filters uses 2-band equalization with two shelf filters, one low and one high, to provide bass and treble tone control. These two filters affect only the high and low frequency signals, leaving the center frequencies unaltered. Adding a third or fourth band of equalization in the form of midrange bandpass filters provides more control over those frequencies where hearing is most sensitive, and where most of the energy in music exists. (500Hz-4kHz). These midrange bands peak, or dip, at a center frequency which can be varied to provide much greater control over different aspects of the sound, allowing for bass or treble rolloff to decrease boominess, thicken sounds, reduce noise, or increase brightness.

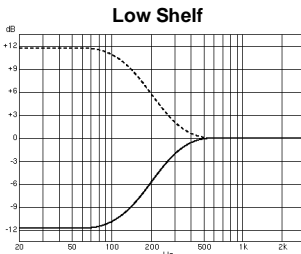

**Parametric EQ**

Parametric equalizers provide boost and cut controls, sweepable center frequencies, and adjustment of “Q”, or the broadness or sharpness of the EQ curve — all of the parameters of equalization. This ability to broaden or narrow the peak at certain frequencies allows specific sounds to be accented or diminished with minimal effect on adjacent frequencies. As all equalization has potentially adverse side effects on program material, this ability to precisely adjust only specific frequencies has the advantage of minimizing the amount of EQ applied to program material. It also allows the creation of specific effects such as sharply narrowed EQ curves (notches) which are useful for feedback control or removal of specific noise artifacts.

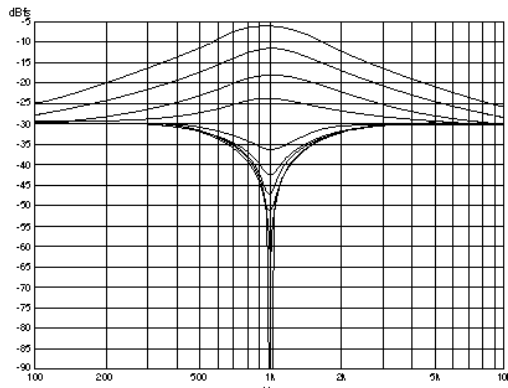

**MPX G2 Parametric EQ: Gain**

Fc=1000Hz Q=1.0 Gain=+24dB, +18dB, +12dB, +6dB, 0dB, -6dB, -18dB, -24dB, -36dB, -72dB

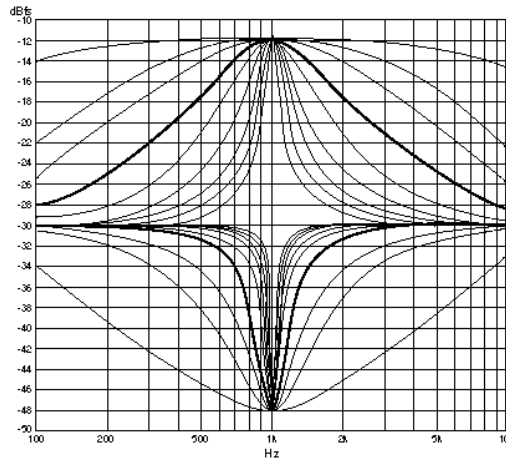

**MPX G2 Parametric EQ: Q**

Fc=1000Hz Gain=±18dB Q=0.1, 0.3, 0.5, 1.0, 2.0, 4.0, 6.0, 8.0, 10.0

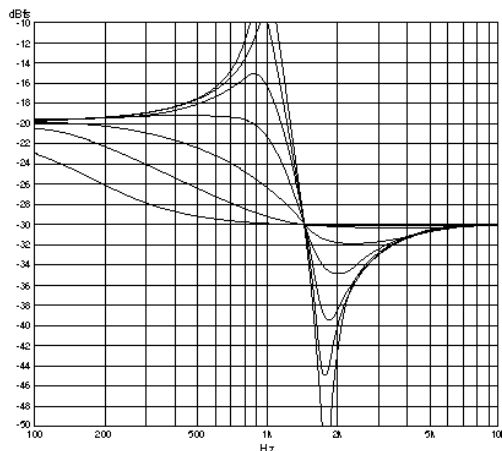

**MPX G2 Parametric EQ: Shelf**

Fc=1000Hz Gain=+10dB Q=0.1, 0.2, 0.5, 1.0, 2.0, 4.0, 10.0

**EQ Tips (for tweakers only)**

**About "Q"**

Q is a measure of the sharpness of an EQ curve. The larger the Q value, the sharper the curve. In some situations it is convenient to think of Q in terms of bandwidth in octaves. Some examples:

Q	Bandwidth
0.1	approximately 6 1/2 octaves
0.4	approximately 3 octaves
0.7	approximately 2 octaves
1.4	approximately 1 octave
2.9	approximately 1/2 octave
4.3	approximately 1/3 octave
5.8	approximately 1/4 octave
7.2	approximately 1/5 octave
8.7	approximately 1/6 octave
10.0	approximately 1/7 octave

There are mathematical limits to how small the Q value can be in MPX G2 EQ effects. For any given frequency, the Q must be greater or equal to the frequency divided by 10,000. For example if the frequency is 5kHz, the actual Q value won't go below 0.5. (The MPX G2 will allow you to dial in lower values, but the actual Q will not go below the mathematical limit.)

For most shelving applications, Q should be set very low (Around 0.2). As you increase the Q, the filter becomes peaky, but a dip also develops just outside the passband. For many applications, a bandpass or band cut filter with a moderate Q and a low (or high) center freq will prove sonically superior to the shelving filter.

**Making a Low Pass Filter**

To make a two-pole low-pass filter, start with a high shelf, and set Gain to -72 (effectively off). This creates a low pass filter with a corner frequency at Fc. A Q of 0.7 makes a flat passband. Higher Q settings produce a peak at Fc, and lower Q settings produce a droop.

**EQ 1-Band (M), 2-Band (M), 3-Band (M) and 4-Band (M)**

The 1-Band (M) effect provides a single band of double-precision parametric EQ.

2-Band (M), 3-Band (M) and 4-Band (M) have two, three and four bands, respectively, of double-precision parametric EQ. Each effect has adjustable center frequency, Q, boost/cut and filter type (low shelf, band, high shelf).

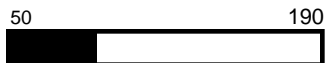

1-Band (M)



2-Band (M)



3-Band (M)



4-Band (M)

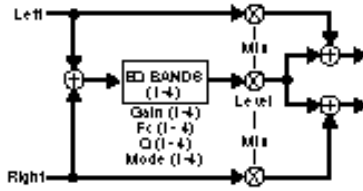

<b>Mix</b>	0-100%	Dry/Wet ratio
<b>Level</b>	Off, -89 to +6dB	Amount of effect in the processed signal
<b>Gain (1-4)</b>	-72 to +24dB	Boost/cut gain of filter(s)
<b>Fc (1-4)</b>	20-20000Hz	Center or corner frequency of filter(s)
<b>Q (1-4)</b>	0.1-10.0	Q of filter(s)
<b>Mode (1-4)</b>	LShlf, Band, HShlf	Determines EQ type(s)

**EQ 1-Band (S), and 2-Band (S)**

1-Band (S) has two bands of double-precision parametric EQ, one on each channel. 2-Band (S) has four bands of double-precision parametric EQ, two on each channel.

The two channels share the filter controls. Center frequency, Q, boost/cut and filter type (low shelf, band, high shelf) are adjustable.

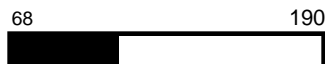

1-Band (S)



2-Band (S)

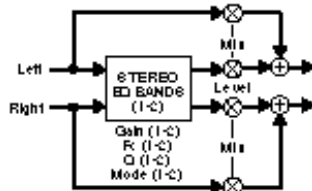

<b>Mix</b>	0-100%	Dry/Wet ratio
<b>Level</b>	Off, -89 to +6dB	Amount of effect in the processed signal
<b>Gain (1-2)</b>	-72 to +24dB	Boost/cut gain of filter(s)
<b>Fc (1-2)</b>	20-20000Hz	Center or corner frequency of filter(s)
<b>Q (1-2)</b>	0.1-10.0	Q of filter(s)
<b>Mode (1-2)</b>	LShlf, Band, HShlf	Determines EQ type(s)

\* = Interpolated; ( ) = Option of preceding parameter

E
**1-Band (D) and 2-Band (D)**

<b>Mix</b>	0-100%	Dry/Wet ratio
<b>Level</b>	Off, -89 to +6dB	Amount of effect in the processed signal
<b>G-L, G-L1, G-L2</b>	-72 to +24dB	Boost/cut gain of left filter(s)
<b>Fc-L, Fc-L1, Fc-L2</b>	20-20000Hz	Center or corner frequency of left filter(s)
<b>Q-L, Q-L1, Q-L2</b>	0.1-10.0	Q of left filter(s)
<b>M-L, M-L1, M-L2</b>	LShlf, Band, HShlf	Determines EQ type(s)
<b>G-R, G-R1, G-R2</b>	-72 to +24dB	Boost/cut gain of right filter(s)
<b>Fc-R, Fc-R1, Fc-R2</b>	20-20000Hz	Center or corner frequency of right filter(s)
<b>Q-R, Q-R1, Q-R2</b>	0.1-10.0	Q of right filter(s)
<b>M-R, M-R1, M-R2</b>	LShlf, Band, HShlf	Determines EQ type(s)

68
190

1-Band (D)

109
190

2-Band (D)

1-Band (D) has two bands of double-precision parametric EQ, one on each channel. 2-Band (D) has four bands of double-precision parametric EQ, two on each channel.

Center frequency, Q, boost/cut and filter type (low shelf, band, high shelf) are adjustable.

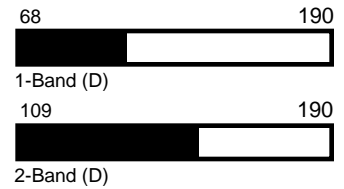

E
**Fc Splitter**

<b>Mix</b>	0-100%	Dry/Wet ratio
<b>Level*</b>	Off, -89 to +6dB	Amount of effect in the processed signal
<b>LoCut</b>	100-10000Hz	Corner frequency for the low cut (highpass)band
<b>HiCut</b>	100-10000Hz	Corner frequency for the high cut (lowpass) band
<b>Bal*</b>	-50 to +50	Relative level of the low and high band

55
190

The Fc Splitter effect splits a mono input into a low-passed output on the left channel and a high-passed output on the right, with independent control of the corner frequencies of both filters. If the corner frequencies are the same, and the balance is set to 0, the frequency response will be flat when the two outputs are summed. Bal controls the relative level of left and right outputs. When Bal=0, the left and right outputs are not attenuated. Negative values attenuate the right output (highs). Positive values attenuate the left (lows).

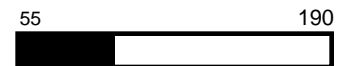

\* = Interpolated; ( ) = Option of preceding parameter

**Crossover**

The Crossover effect is similar to Fc Splitter, but with only one crossover frequency, shared by low and high. In this effect, Level and Bal are not interpolated.

29 190

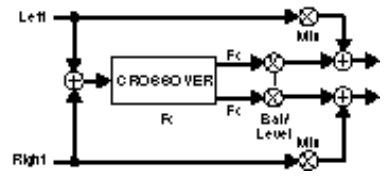

<b>Mix</b>	0-100%	Dry/Wet ratio
<b>Level</b>	Off, -89 to +6dB	Amount of effect in the processed signal
<b>Fc</b>	100-10000Hz	Crossover frequency
<b>Bal</b>	-50 to +50	Relative level of the low and high band

**Volume (M), Volume (S) and Volume (D)**

The Volume effects can be placed in front of, or behind, other effect blocks to provide smooth level control through a 95dB range. You can use them for dynamic input or output control, EQ input trim (helpful when adding large amounts of gain with an EQ effect), stereo to mono mixer, cross fade controls, volume pedal, etc.

In **Volume(M)** the left and right inputs are mixed together, then sent to both outputs through a volume control.

In **Volume (S)** the left and right inputs are sent through a ganged pair of volume controls.

In **Volume (D)** the left and right inputs are sent through independent volume controls.

17 190

Volume (M)

13 190

Volume (S)

18 190

Volume (D)

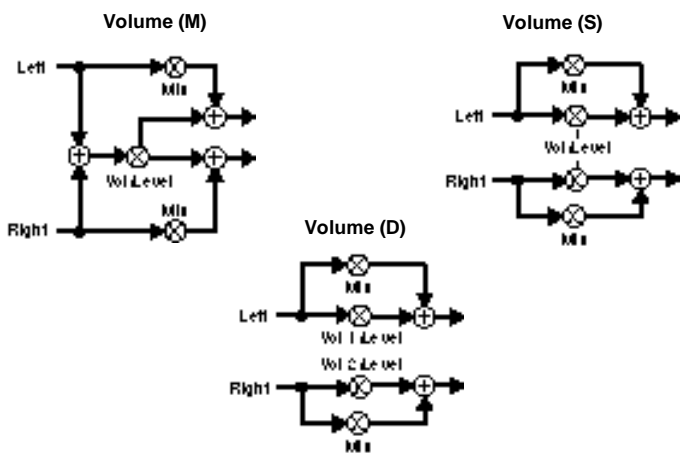

<b>Mix</b>	0-100%	Dry/Wet ratio
<b>Level*</b>	Off, -89 to +6dB	Amount of effect in the processed signal
<b>Vol*</b>	0-100%	Amount of effect in the processed signal

\* = Interpolated; ( ) = Option of preceding parameter

ED

## PedalVol and ExtPedalVol

<b>Mix</b>	0-100%	Dry/Wet ratio
<b>Level*</b>	Off, -89dB to +6dB	Amount of effect in processed signal

PedalVol is the same as Volume (S), except the Vol parameter is hardwired to the Foot Pedal input on the MPX G2. When using the MPX R1 MIDI Remote Controller, this parameter is automatically connected to the R1's built-in pedal. This means that no patching is required to create a volume pedal effect.

ExtPedalVol is hardwired to the External Pedal input of the MPX R1, allowing you to easily create programs with both a Volume and Wah pedal available simultaneously.

13 190

PedalVol and ExtPedalVol

\* = Interpolated; ( ) = Option of preceding parameter



This chapter describes all of the MPX G2 internal controllers. Examples of presets which make use of a controller are noted to the side of each description. The controls for making individual adjustments and assignments to the controllers are available in the **Edit** menu and are described in Chapter 3: *Editing*.

## MPX G2 Internal Controllers

The Knob controller allows you to define your own custom patch controller. Once defined, you can place it in the Soft Row with its own label. You can even define the upper and lower limits of the control. Use **Knob** when you want to manually adjust the values of more than one parameter simultaneously, or when you want to limit the range of control over a single parameter.

### Knob

#### Knob (Soft knob assignment for front panel parameter control)

Parameter	Range	Description
Value	0-127	initial setting
Low	0-127	Low point of range
High	0-127	High point of range
Name	9 characters	Custom name

In general an LFO is a source whose output cycles constantly between 0, 127 and 0. Each LFO produces four simultaneous output waveforms: Sine, Cosine, Triangle and Pulse. Rate controls how fast the output cycles — you can set the rate as either a frequency (such as 3Hz) or as a rhythmic value (such as 2:3 cycles per beat). A Depth parameter scales the output range. Several additional parameters make the MPX G2 LFOs very flexible. Mode, OnSrc and OnLvl allow you to turn the LFOs on and off in different ways based on the output levels of other MPX G2 controllers. PW allows you to dynamically modify the shape of LFO waveforms. Phase lets you change the phase of the Cosine relative to the other waveforms (Sine, Triangle, and Pulse).

### LFO1 and LFO2

**NOTE:** In all modes, the LFO completes its current cycle before stopping. The first press of **Tap** resets the LFOs.

#### LFO (1 or 2)

Parameter	Range	Description
Mode	Off, On, Latch, Gate, Once, Reset, RTrig	Controls behavior of Source when OnLvl is reached
Rate	0-50.00/1:24-24:1	LFO speed
(Rate units)		Option of Rate: Hz or Cycles per Beat
PW	0-100%	Varies the pulse width of all shapes
Phase	-120° to +120°	Relative phase difference between Sine and Cosine
Depth	0-100%	Controls the amplitude of all shapes
OnLvl	0-127	Start/Stop level for Latch, Gate, Once, Reset and RTrig modes
OnSrc	Off, On, any internal or MIDI controller	Determines which control source is used to turn LFO on and off in Latch, Gate, Once, Reset and RTrig modes.

#### LFO Modes

**Off:** LFO is disabled (OnSrc and OnLvl are ignored)

**On:** LFO is always on (OnSrc and OnLvl are ignored)

In the remaining modes, when the value of OnSrc rises above or falls below the value of OnLvl the LFO is switched on and off as follows:

**Latch:** LFO toggles on and off whenever OnSrc value rises above OnLvl

**Gate:** LFO stays on while OnSrc value is greater than OnLvl

**Once:** LFO sweeps through one complete cycle when OnSrc value rises above OnLvl. (During the sweep, further changes of OnSrc value are ignored.)

**Reset:** LFO is always on, but its phase resets to 0° whenever OnSrc value rises above OnLvl.

**RTrig:** LFO completes one cycle when OnSrc value rises above OnLvl. (The phase of the LFO can be reset to 0° if OnSrc value rises above OnLvl during the sweep.)



### Random Generator

This controller produces a random stream of numbers whose maximum range is 0-127. You can limit both the lowest and highest values and control the rate at which the numbers are generated.

#### Random (Random Number Generator)

Parameter	Range	Description
RndLo	0-127	Low limit
RndHi	0-127	High Limit
Rate	0-50.00	Speed
(Rate Units)		Option of Rate: Hz or Cycles per Beat

### A/B Glide

The A/B Glide controller is linked to the front panel **A/B** button and LEDs. Pressing the button toggles the state of the controller between A and B, as indicated by the LEDs.

**A/B Glide Modes**

**Trig:** Toggles between A and B whenever **A/B** button is pressed or OnSrc value rises above OnLvl.

**Gate:** Glide from A to B when OnSrc value rises above OnLvl. Glides from B to A whenever OnSrc value falls below OnLvl. The **A/B** button is ignored.

Like the LFOs, A/B Glide has several simultaneous outputs that can be used as patch sources:

**A/B:** The A/B Glide controller is linked to the front panel **A/B** button and LEDs. Pressing the button toggles the state of the controller between A and B, as indicated by the LEDs.

**ATrg:** This value changes from 0 to 127 and back to 0 again whenever A/B changes from B to A.

**BTrg:** This value changes from 0 to 127 and back to 0 again whenever A/B changes from A to B.

**ABTrg :** This value changes from 0 to 127 and back to 0 again whenever A/B changes from A to B or B to A.

When the controller is at A, its output is 0. When it is at B, its output is 127. Controls are provided to allow you to determine the rate at which it glides from A to B and from B to A.

Of the many presets in the MPX G2 that use this controller, the most straightforward example is Program **47 Rotary Cab**. In this preset, **A/B** is used to glide between the fast and slow rates of a rotary speaker effect. Different A and B rates are used to simulate the mechanical inertia of the real thing. Note that you can use the OnSrc parameter to select other controllers to initiate the glide.

#### A/B

Parameter	Range	Description
Mode	Trig, Gate	See notes.
ARate	0-100	Time to go from A to B
BRate	0-100	Time to go from B to A
OnLvl	0-127	Threshold
OnSrc	Off, On, any internal or MIDI controller	Selected trigger

Env is an envelope follower which creates an output that varies with the level of the Src parameter. You can choose any two audio level as sources. To follow the levels on both Returns, set **Src1 to Ret L** and **Src 2 to Ret R**. Use Resp and ATrim to customize the response to level changes. **Resp** values below 50 take many seconds to “catch up” with audio level changes. For most situations, you’ll find values above 50 to be the most useful.

#### Env

Parameter	Range	Description
Src (1 or 2)	Off, In, Ret L, Ret R, FX1L, FX1R, FX2L, FX2R, ChrsL, ChrsR, EQL, EQR, RvbL, RvbR, DlyL, DlyR, PreOut, MainL, MainR	
Atrim	0-100	Allows attack time to be shortened relative to overall response. 0=same as Resp, larger numbers shorten response.
Resp	0-100	Responsiveness

The rear panel Foot Switch jack can be connected to as many as three independent analog switches. Each switch appears as two simultaneous patch sources.

#### Footswitch Controllers

- Tog1: Value toggles between 0 and 127 at each off/on transition of foot switch 1.
- Tog2: Value toggles between 0 and 127 at each off/on transition of foot switch 2.
- Tog3: Value toggles between 0 and 127 at each off/on transition of foot switch 3.
- Sw1: Value is 0 when foot switch 1 is off, 127 when foot switch 1 is on.
- Sw2: Value is 0 when foot switch 2 is off, 127 when foot switch 2 is on.
- Sw3: Value is 0 when foot switch 3 is off, 127 when foot switch 3 is on.



## Program Descriptions

Most of the MPX G2 programs are already set up to take advantage of a connected MPX R1 MIDI Remote Controller. You'll find references throughout to special controls assigned to the MPX R1 pedal and its Toe Switch. Other pedals can be used but you will not be able to take advantage of the effects switching made possible with the MPX R1 Toe Switch.

The 250 MPX G2 programs are organized into three major groups:

**1-99: Amp Input + FX Loop** programs designed to be used with the MPX G2 connected to a guitar amp with an effects loop

**100-149: Amp Input Only** programs designed to be used with the MPX G2 connected to an amp with no effects loop

**150-248: Stand Alone** programs designed to be used with the MPX G2 connected directly to a mixer or power amp

Each group is broken down into smaller sections which we've titled to make it easier for you to find just what you're looking for.

**Programs 1-99 are designed to be used with the MPX G2 connected to a guitar amp with an effects loop.**

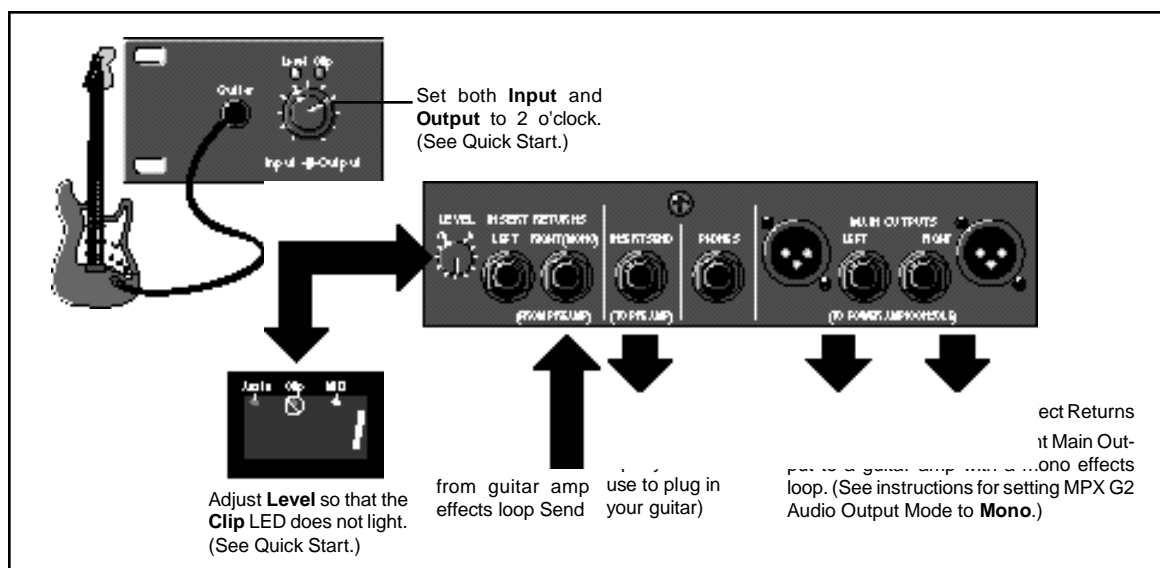

These programs are designed to work in the high-gain channel of your guitar amp, set for moderate gain. The Screamer and Wah effects are programmed to have high output levels to increase sustain when they're pumped into an amp that's already being pushed pretty hard. If you want to use this rig with a clean amp channel, you may want to decrease the **Gain** (Screamer) and **Effect 2** (Wah) levels a bit.

## Top Nineteen (Amp Input + FX Loop)

### 1 G2 Blue

This is one heck of a rig — our take on the Cry Baby wah, Uni Vibe and Tube Screamer — all tweaked up to drive a guitar amp running with lots of gain. Use the MPX R1 Toe Switch to swap the Wah with the UniVibe. While the UniVibe is active, the pedal is a power amp volume control. The Screamer overdrive is bypassed when the program loads — press **Gain** to turn it on. **A/B** turns up the echo level and feedback. (A is dry, B is wet). **Tap** sets the echo rhythm.

## 2 Guitar Solo

Analog Screamer with detuning delay and classic plate reverb. The MPX R1 pedal controls volume so you can swell your chords into the reverb. **A/B** controls delay damping. **Tap** sets the echo time. The Toe Switch turns the pedal On and Off.

## 3 Cordovox

This program simulates the sound of a Cordovox cabinet — a single speaker with a rotating baffle that produces a swirling stereo vibe. The Gain effect is clean analog Tone that will boost your amp a bit so when you dig in you get some grit but, as you play lighter, or switch to less powerful pickups, you get cleaner sounds. **A/B** controls fast and slow speeds of the rotating baffle. **Tap** sets the echo time. The MPX R1 pedal controls volume, the Toe Switch turns the pedal On and Off.

## 4 Power Chords

A 2-voice pitch shifter with one voice set for an octave down. **A/B** toggles the second voice between a fourth down and unison. Press **Gain** for high-gain distortion. **Tap** sets the delay time. The MPX R1 pedal controls the pitch shift mix, its Toe Switch turns pitch On and Off.

## 5 Vybe/Flange

Here's a rig that lets you jump between vintage and modern sounds by using the MPX R1 Toe Switch to swap the UniVybe with a Stereo Flanger. The UniVybe is in front of the amp and the Flanger is in the effects loop. The pedal is a power amp volume pedal. **A/B** pumps up the echo level and repeats when set to B. The Screamer analog overdrive loads bypassed — press **Gain** to light things up.

## 6 AnotherBrick

This echo/chorus program was inspired by Pink Floyd. "Hey! Leave those kids alone!" Press **A/B** to split delay times in half. **Tap** sets delay times. The MPX R1 pedal controls volume, so you can swell your chords into the reverb. The Toe Switch turns the pedal on and off.

## 7 EnvFilter LP

A very funky, synth-like effect, reminiscent of a Mu-tron III set to "LP". The dynamics of your playing opens and closes a resonant filter. **A/B** brings in some stereo echoes. The MPX R1 pedal controls the effects sensitivity to your playing dynamics. The Toe Switch turns the effect on and off.

## 8 TremoWah

An LFO/tempo-controlled wah before guitar amp input followed by an LFO/tempo-controlled tremolo which flows into a tempo-controlled delay and then a stereo panner. Listen to the results! **A/B** changes the mix value of the wah and tremolo. The MPX R1 pedal controls volume, the Toe Switch turns the pedal on and off.

## 9 JamMan

It's baaaack!!!!!! A medium-gain preamp with a chorus, reverb and a 20-second single loop JamMan! The MPX G2 front panel buttons or the MPX R1 control:

**Tap** = Record Loop

**A/B** = Layer

**Delay** = Clear Loop

The MPX R1 Toe Switch lets the pedal control volume (Toe Switch off) or wah (Toe Switch on).

## 10 VH Rig

A classic VH stomp rig. This programs loads with OrangePhase and delay for the original sound. Press **Chorus**, **Effect 1** and **Reverb** to add a classic gray flange and a Dual Detuner for the new Eddie Sound. **A/B** adds delay and delay feedback. **Tap** sets delay times. The MPX R1 pedal controls volume, the Toe Switch turns the pedal on and off.

**11 Rotary Cab**

A Leslie with a bit of chamber to fatten up the sound. Press **Gain** to add a little grit, so when you dig in you get some distortion. **A/B** controls fast and slow speeds of the rotary speaker. The MPX R1 Toe Switch activates pedal control of volume or wah.

**12 Little Wing**

A vintage plate reverb with our classic Univibe. Press **Gain** for fuzz. **A/B** changes the reverb mix level. The MPX R1 pedal controls the wah. The Toe Switch turns the wah on and off.

**13 TechnoChords**

Play a chord and let it ring out. Random tones ring out into delay and reverb. **A/B** changes the mix of the effect so that more of the original signal can be heard. **Tap** changes delay time and LFO speeds controlling a sweep filter. The MPX R1 Toe Switch gives you pedal control of volume or of volume with a sweep filter scale.

**14 Pedal Swell**

Compression with chorus and delay that go into a panner. A truly stereo effect. **A/B** changes delay feedback time from 20 to 80%. **Tap** sets delay time. The MPX R1 pedal controls volume to let you create ethereal volume swells. The Toe Switch turns the pedal on and off.

**15 Slide Comp**

A gritty preamp and two compressors in series. This trick allows slide players to use a light touch and still get singing sustain.

**16 Kiss the Sky**

Hendrix-style fuzz with an Octabuzz. **A/B** turns off the Octabuzz and switches between two different echo times. **Tap** sets echo time. The MPX R1 pedal controls the wah. The Toe Switch turns the wah on and off.

**17 Unchained**

The classic Gray Flange with the mix toned down a bit, and some delay. Press **A/B** to toggle the flange on and off like the real riff. **Tap** sets delay time. This program works best into a high-gain amp. The MPX R1 pedal controls volume, the Toe Switch turns the pedal on and off.

**18 Stomp!**

A collection of classic stomp boxes just waiting to be activated. Press **Gain** for a Screamer, **Effect 1** for a Univibe, **Effect 2** for a Wah, **Chorus** for a Flanger, **Delay** for Echo and **Reverb** for a vintage plate. **A/B** increases the delay and reverb mix. **Tap** changes delay time. The MPX R1 Toe Switch activates pedal control of volume or wah.

**19 OctaWah**

This rig lets you switch from a standard vintage echo and plate reverb to a full-on Screamer with Octabuzz and Wah. The MPX R1 Toe Switch simultaneously adds gain, EQ, Wah and Octabuzz for a classic Hendrix sound. When the pedal is not controlling the wah, it acts as a power amp volume pedal. **A/B** adds more delay and reverb. **Tap** sets the echo time.

### Vintage Rig (Amp Input + FX Loop)

Programs 20-29 are organized to work as a custom effects rig when used with the MPX R1 MIDI Remote Controller. All of the programs feature vintage wah and analog overdrive in combination with a volume pedal and a modulation effect (UniVybe, OrangePhase, Flanger, Chorus). **Tap** echo and plate reverbs are also built-in.

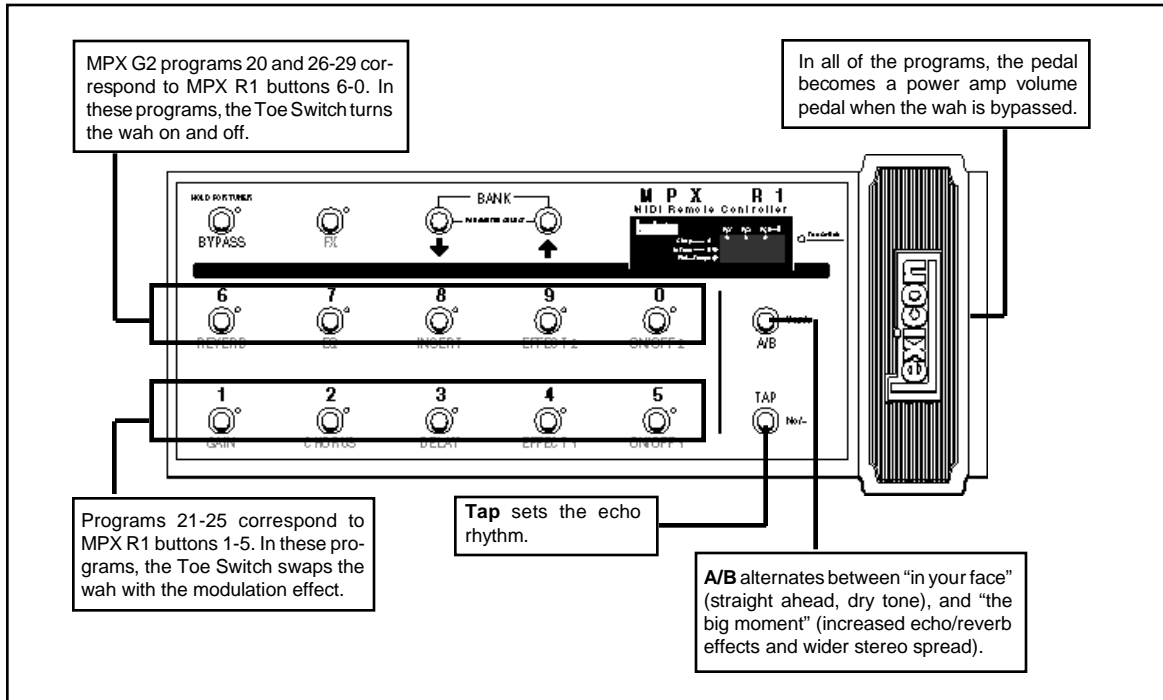

These programs are designed to work in the high-gain channel of your guitar amp, set for moderate gain. The Screamer and Wah effects are programmed to have high output levels to increase sustain when they're pumped into an amp that's already being pushed pretty hard. If you want to use this rig with a clean amp channel, you may want to decrease the **Gain** (Screamer) and **Effect 2** (Wah) levels a bit.

#### 21 ToeWah/Flng

Alternate between amp input wah and effects loop stereo flanger by pressing the MPX R1 Toe Switch.

#### 22 ToeWah/Phas

This variation swaps the wah with OrangePhase. Both effects are in front of your amp.

#### 23 ToeWah/Chorus

Chorus effects sound different when they go in front of an overdriven amp. Press the MPX R1 Toe Switch to hear for yourself.

#### 24 ToeWah/Aero

Swap between the amp input wah and a stereo flange in the effects loop.

#### 25 ToeWah/Uni

While it's almost impossible to play through these effects and not think of Hendrix, the vintage power trio of Wah, Screamer and UniVybe has become the tonal foundation of many other players. These effects are all in front of your amp — where they belong. Echo and Plate are in the effects loop.

Programs 20 and 26-29 are variations of 21-25. Each offers the same combination of Wah, Screamer and modulation effects with the MPX R1 Toe Switch turning the wah on and off. This makes it possible to have the wah and modulation effects on at the same time.

**20 Wah & Uni**

**26 Wah & Flange**

**27 Wah & Phaser**

**28 Wah & Chorus**

**29 Wah & Aero**



### Chorus Delay Rig (Amp Input + FX Loop)

Programs 30-39 are based on combinations of Screamer, Compressor, Wah, Volume Pedal, Chorus, Delay and Hall Reverb. In all of these programs, the MPX R1 Toe Switch activates pedal control of volume or wah. **Tap** set delay time and **A/B** increases the delay feedback time.

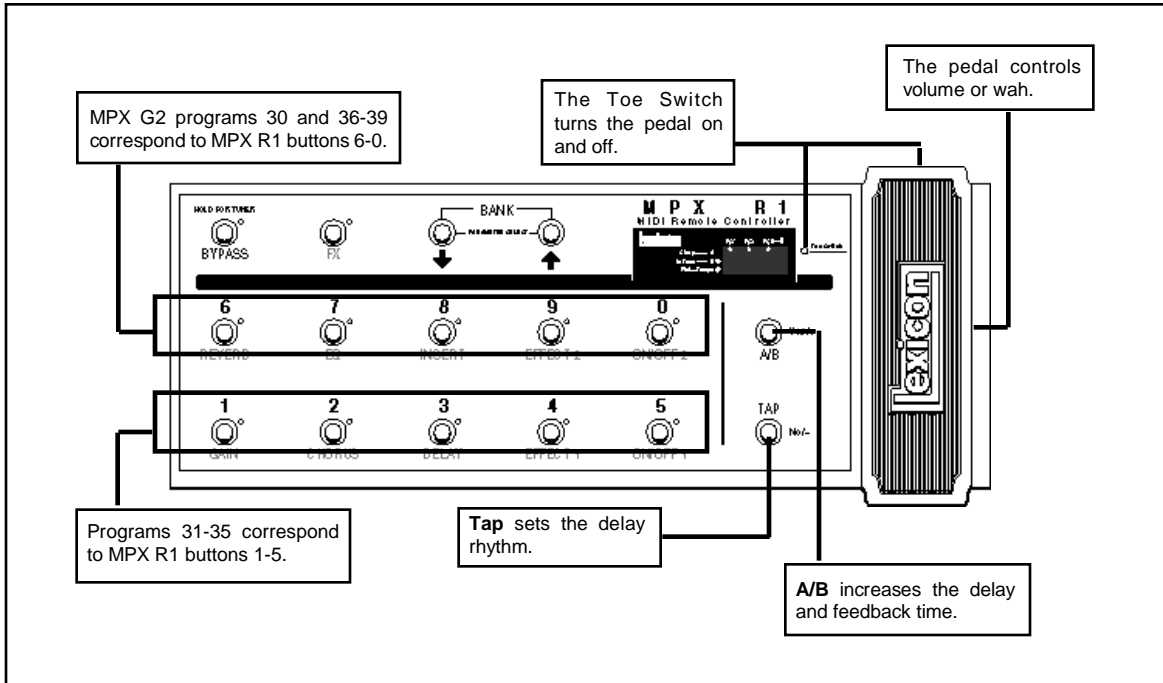

#### 30 ChrsDlyRvb+

Screamer for a bit of boost with compression, chorus, delay and reverb.

#### 31 TS Chorus+

Screamer and Chorus. Press **Effect 1** to add a compressor, **Chorus**, **Delay** or **Reverb** for additional effects.

#### 32 TS Delay+

Screamer and Delay. Press **Effect 1** to add a compressor, **Chorus**, or **Reverb** for additional effects.

#### 33 TS ChrsDly+

Screamer with Chorus and Delay. Press **Effect 1** to add a compressor, or **Reverb** for additional effects.

#### 34 TS Reverb+

Screamer and Reverb. Press **Effect 1** to add a compressor, **Chorus**, or **Reverb** for additional effects.

#### 35 TSChrsRvb+

Screamer with Chorus and Reverb. Press **Effect 1** to add a compressor, or **Delay** for additional effects.

**36 CompChorus+**

A cleaner version of **TS Chorus+** with BlueComp in place of the Screamer for cleaner tone.

**37 CompDelay+**

A cleaner variation TS Delay+ with BlueComp in place of the Screamer for cleaner tone.

**38 CmpChsDly+**

Cleaner version of **TS ChorsDly+** with BlueComp in place of the Screamer for cleaner tone.

**39 CmpChsRvb+**

A cleaner version of **TS ChrsRvb+** with BlueComp in place of the Screamer for cleaner tone.

### Pitch Rig (Amp Input + FX Loop)

Programs 40-49 are organized as a custom effects rig when used with the MPX R1 MIDI Remote Controller.

All of the programs feature pitch bending or harmony. Analog overdrive, stereo delay, chorus/detune and reverb are included as well, but most of the programs load with them bypassed. They're ready to go, if you want to add them to the mix.

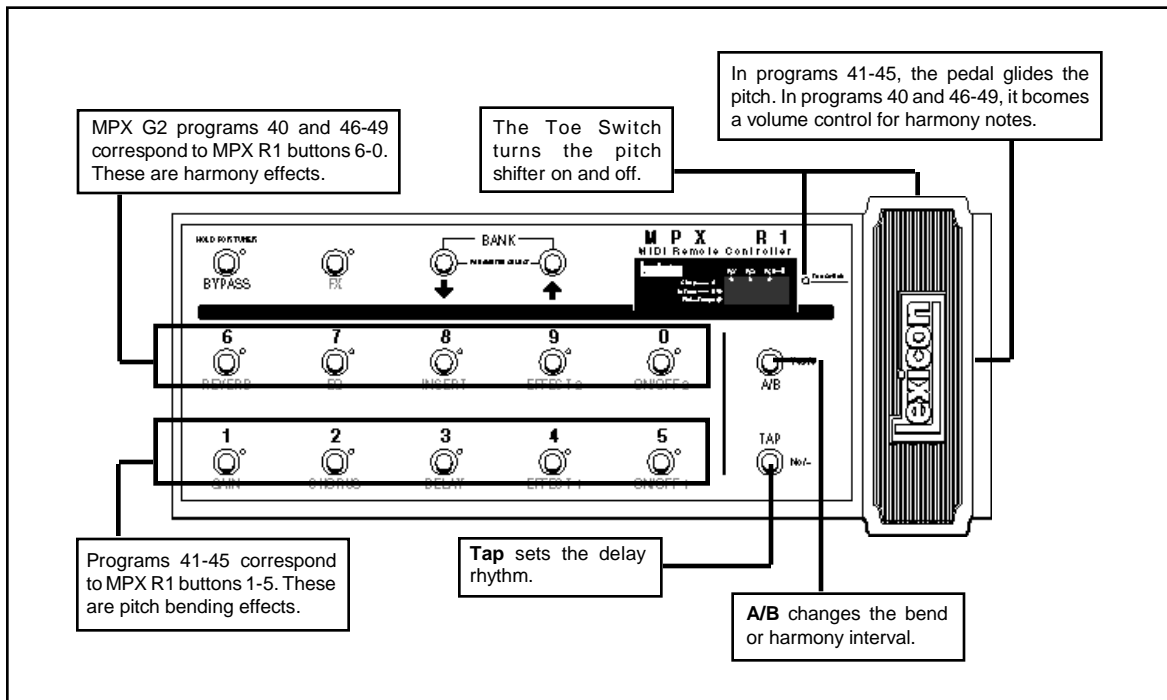

Programs 41-45 are set up as pitch pedals for dive bomb and bend effects. In each of these, the pitch shifter is in front of the amp.

#### 41 Pdl Octaves

Use the pedal to create outrageous octave sweeps. **A/B** changes the direction of the sweep (A=octave up, B=octave down). Chorus, delay and reverb are in the effects loop. Check out the Glide parameter in the Soft Row. When it's Off, the pedal produces a chromatic glissando instead of a continuous glide.

#### 42 Pdl 2nds

The pedal gives you whole-step bends. A=bend up. B=bend down.

#### 43 Pdl 2->3 b3->3

The shifted signal is mixed with the dry signal to produce 2-voice harmony. The pedal lets you bend the shifted harmony voice. Use **A/B** to alternate the basic tuning. A=whole-step bend from major second to major third. B=half-step bend from minor third to major third.

#### 44 Pdl 2->3 3->4

Use **A/B** to alternate the basic tuning. A=whole-step bend from major second to major third. B=whole-step bend from major third to a fourth.

#### 45 Pdl 4->5 5->6

Use **A/B** to alternate the basic tuning. A=whole-step bend from a fourth to a fifth. B=whole-step bend from fifth to a sixth.

Programs 40 and 46-49 use the pitch shifter to produce harmony effects. All of the effects except Overdrive are in the effects loop. (Because the pitch effects are first, you can use the pedal to "float" notes into the delay and reverb.) **A/B** alternates between two harmony settings. **Tap** sets the delay rhythm.

#### **40 PitchCascade**

This special effect is created by putting a dual pitch shifter in the feedback loop of a dual delay. **Tap** sets the delay rhythm. After going through the delay, the notes are pitch shifted. (**A/B** selects between up a fifth/down an octave and down a fourth/up an octave.) Then the pitch-shifted notes are recirculated through the delay and pitch-shifted again. The recirculation is controlled by the XFbk1 and XFbk2 parameters. (They're in the Soft Row along with delay time and other goodies.)

#### **46 Octaves**

Use the pedal to fade two additional harmony voices in and out. **A/B** alternates between tunings. A=one octave up (doubled). B=one octave down and two octaves down.

#### **47 4ths & 5ths**

Play power chords from single notes — with your note on the top or bottom of the chord. **A/B** alternates between tunings. A=up a fifth and up an octave. B=down a fourth and down an octave.

#### **48 E Maj/Min 3**

Tune up and play melodies in the Key of E. The DiatonicHmy effect automatically harmonizes your notes in thirds. Use **A/B** to alternate between E Major and E Minor (Aeolian). You can change to any other key by adjusting the value of the Key parameter — you'll find it in the Soft Row.

#### **49 E Dor/Mix 3**

In this program the DiatonicHmy effect is set to produce 3rds in E Dorian (same as E major with b3 and b7) or E Mixolydian (same as E major with b7). Change keys with the Key parameter in the Soft Row.

### Tremolo and Filter Effects (Amp Input + FX Loop)

Programs 50-59 are organized as a custom effects rig when used with the MPX R1 MIDI Remote Controller. All of the programs feature tremolo, auto pan and auto wah filter effects. In programs in which the pedal controls rate, **Tap** sets the delay rhythm. In programs that have depth controlled by the pedal, **Tap** sets the rate of the effect. **A/B** is patched so that B is wetter (more reverb or delay) than A.

These programs will work well with your guitar amp's clean or high-gain channels.

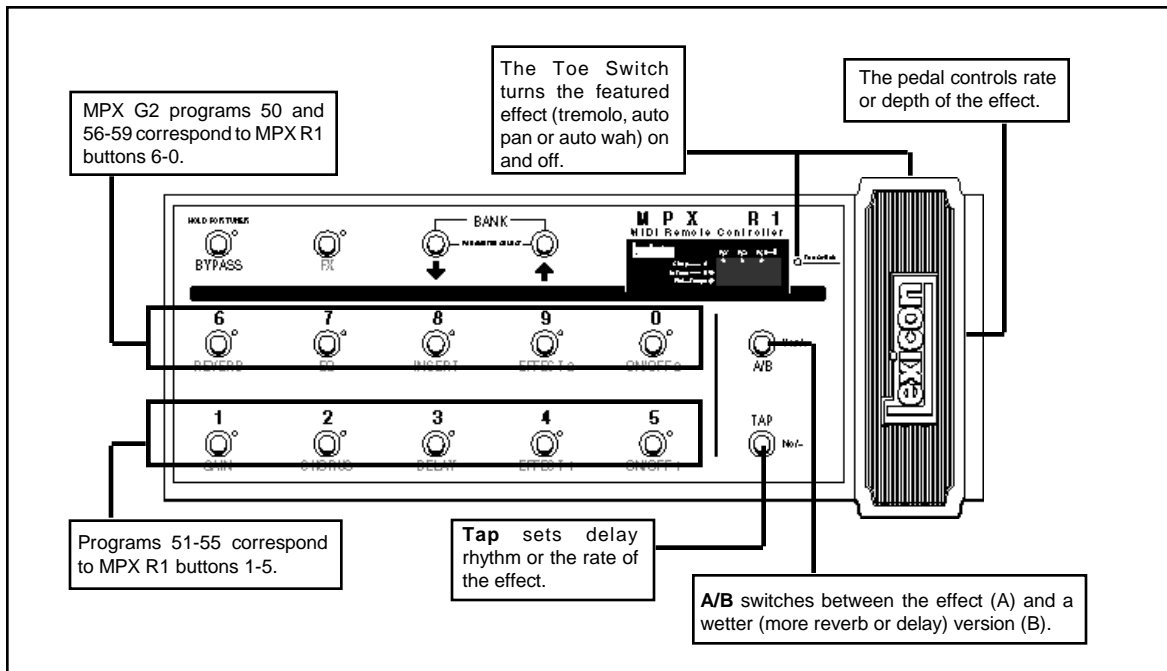

#### 50 Detune Trem

This one delivers the big throb with a tempo-controlled tremolo in front of your amp, dual pitch shift, delay and reverb in the effects loop. Tremolo depth is pedal-controlled.

#### 51 Square Trem

A square wave LFO gives this tremolo a hard edge before it hits your amp. (Be sure to check out the PW parameter in the Soft Row.) **Tap** the tempo and set depth with the pedal.

#### 52 Trem>AutoWah

This stereo program combines an auto panner and dual auto wahs to create an unusual, but totally musical result. The rates of all three effects are synchronized with **Tap**. The pedal controls the depths of the wahs.

#### 53 Env Trem

RedComp pumps up the signal before it gets to your amp. From there, it runs through reverb auto pan, chorus and delay. The twist here is that the panner rate is envelope-controlled. Play a big chord and listen to it ring out. The pedal controls panning depth. **Tap** sets the delay rhythm.

#### 54 Env AutoWahs

An alternative take on standard tremolo effects. Dual auto wahs in your amp's effects loop are controlled by your playing dynamics. The pedal controls the depth of both wahs.

**55 Chaos Dance**

This techno rhythm effect is produced by hitting the amp input with a randomized envelope filter and adding some delay and reverb in the effects loop. The pedal controls the filter's overall brightness. **Tap** sets the pattern rate. Make the pattern dance with Rand Rate and LFO2 Rate in the Soft Row.

**56 Round Trem**

A classic combination of vintage and modern effects. In front of the amp there's a tempo-controlled tremolo with a vintage vibe. Delay and reverb are in the effects loop. If you want even more shimmer, turn on **Effect 1**. (It's running a dual pitch shifter, tweaked for fat detune). The pedal controls the depth of the tremolo.

**57 Tap AutoWah**

Give your foot a rest. **Tap** in the tempo and let the stereo auto wah do the work. The pedal controls the overall depth of both wahs.

**58 Verbolo**

Some vintage amps placed the tremolo circuit after the reverb tank so you could crank up the reverb without washing out the tremolo. Guess what? This program lets your amp do the same thing — and there's a little dual pitch shift in there to make your sound way huge. Tremolo rate is controlled by the pedal.

**59 DynaChrsTrem**

Another combination of old and new. First, there's a RedComp compressor in front of the preamp for stomp box style sustain. Then we've added a reverb followed by tremolo plus stereo chorus and delay in the effects loop. Use the pedal to find just the right tremolo rate.

## Effects Collection (Amp Input + FX Loop)

Programs 60-79 each contain a single effect. Use them alone, or as building blocks to create your own multi-effects programs from scratch. Use **Copy Effect** in Edit mode to copy different combinations into a single program.

### 60 Univybe

Our recreation of a vintage Uni Vibe, a signature Hendrix sound.

### 61 Octave Fuzz

This program combines a sub octave with Octavia-style effects with analog distortion. The sub octave comes in when **A/B** is toggled to B. Turn **Gain** on and off to control the fuzz distortion. **Effect 2** is the OctaBuzz. To get that Hendrix sound, turn off the sub octave and play single notes above the 12th fret using your neck pickup. The MPX R1 Toe Switch simultaneously turns the shifter, Octabuzz and distortion on and off. The pedal is a power amp booster that provides an additional 6dB of volume to kick a solo out over the edge.

### 62 Phaser

A recreation of the classic Mu-tron Phaser

### 63 EnvFilter

A recreation of the Mu-tron autowah. Look out Bootsy!

### 64 C-Wah:

Our recreation of the classic Crybaby Wah. The MPX R1 pedal controls the wah sweep while the MPX R1 Toe Switch turns the wah on and off like the original.

### 65 Blue Comp

A recreation of the Boss CS-2 Compressor — a staple of many country players.

### 66 Vintage Trem

A classic vintage tremolo.

### 67 IPS TapeSlap

Press **A/B** to select delays that simulate 7.5 or 15ips tape slaps.

### 68 Space Echo

A simple but tasty delay effect. The sound changes with each repeat. For the sound of the more expensive version, press **Chorus**, which is bypassed when the program loads.

### 69 Octabuzz

Another classic Octavia effect — best known from Purple Haze.

### 70 OrangePhase

A recreation of the Phase 90 effect made famous by Eddie Van Halen.

### 71 Gray Flange

The flanger that created the signature sound on Van Halen's "Unchained".

### 72 RedComp

A recreation of the popular Dyna Comp compressor.

### 73 S/H Pedal

A recreation of the Maestro pedal used by Frank Zappa in the 70's.

### 74 V-Wah

Our recreation of the classic Vox Wah. The MPX R1 pedal controls the wah sweep. The Toe Switch turns the wah on and off like the original.

### 75 Modern Trem

A modern (alternative style) tremolo with a sharper, square wave type feel than a vintage tremolo.

**76 Tap Echo**

**Tap** sets the echo rhythm. **A/B** turns the input to the echo on and off (so that the repeats ring out when you turn it off). The MPX R1 pedal sets the loudness of the echoes. Press **Soft Row** for instant access to all of the delay parameters. The program loads with delay time set to 2 echoes/beat (8th note). Be sure to experiment with different values.

**77 Env Wah**

The sweep of this wah is dynamically controlled by your playing. Similar to the sound of a Mu-tron III set to BP.

**78 StereoChorus**

A lush Lexicon stereo chorus.

**79 ClassicDetune**

A simple but gorgeous effect. The dual pitch shifter is used to independently detune the left and right sides of the stereo field. The classic settings are  $\pm 8$  cents, but feel free to modify these default settings.

Programs 80-89 are examples of dry sounds from the analog gain section. These are designed to be used as stomp boxes before your amp. There are no effects in these programs.

### Analog Gain (Amp Input + FX Loop)

**80 Tone Boost**

A set of analog tone controls that can be used as a clean boost in front of your amp or as a variation of clean analog EQ. Great in front of your amp for tone shaping or as a clean analog gain boost to give your amp a kick.

**81 Crunch Boost**

Overdrive with separate drive controls for low, mid and high frequencies. Gives kick to basic blues sounds.

**82 TS Lead**

Our recreation of the classic TS-9. Great for virtually any application — blues, jazz, rock, metal etc.

**83 TS Boost**

A variation of TS Lead with less overall distortion and more level boost.

**84 OD Lead**

A more aggressive effect than Screamer but it still produces the classic overdrive.

**85 OD Boost**

A variation of OD Lead with less overall distortion and more level boost.

**86 Dist Lead**

Need more than Overdrive? Distortion provides more than 100dB of analog gain.

**87 Dist Boost**

A variation of Dist Lead with less overall distortion and more level boost.

**88 Fuzz 1**

Analog fuzz.

**89 Fuzz 2**

A more aggressive variation of Fuzz 1



**JamMan**  
**(Amp Input + FX Loop)**

Programs 90-94 are set up to have the MPX G2 front panel buttons or the MPX R1 control:

**Tap** = Record Loop  
**A/B** = Layer  
**Delay** = Clear Loop

**90 Jam1 Chrs+**

Loads with Chorus and Hall Reverb. Press **Gain** for boost. The MPX R1 Toe Switch activates pedal control of volume or wah.

**91 Jam1 Uni+**

Loads with Univibe and Plate Reverb. Press **Gain** for overdrive. The MPX R1 Toe Switch turns the pedal on or off.

**92 Jam 1 S&H+**

Loads with a Sample & Hold style effect into a large hall Reverb. The MPX R1 Toe Switch activates pedal control of volume.

**93 Jam1 Env+**

Loads with an envelope filter and a plate reverb. Press **Gain** for overdrive, and **Effect 1** for tremolo. The MPX R1 Toe Switch activates pedal control of volume.

**94 Jam1Cordovox**

A Cordovox effect with reverb. The MPX R1 Toe Switch turns the Cordovox effect on and off, the pedal controls the Cordovox speed.

Programs 95-99 are set up to have the MPX G2 front panel buttons or the MPX R1 control:

**Tap** = Record Loop  
**A/B** = Replace  
**Delay** = Start/Stop Loop

**95 Jam 2 Flange**

Loads with Jet Flange and Hall Reverb. Press **Gain** for distortion. The MPX R1 Toe Switch activates pedal control of volume or wah.

**96 Jam 2 Phase**

Loads with OrangePhase and Plate Reverb. Press **Gain** for Distortion. The MPX R1 Toe Switch activates pedal control of volume or wah.

**97 Jam 2 Pitch+**

Loads with Distortion, Pitch and Ambience. The MPX R1 Toe Switch swaps pedal controls between volume (Toe Switch off) and pitch (Toe Switch on).

**98 Jam 2 Trem**

Loads with an envelope filter and Plate Reverb. Press **Gain** for overdrive, and **Effect 1** for tremolo. The MPX R1 Toe Switch activates pedal control of volume or wah.

**99 Jam2AutoWah**

Auto wah with analog tone and Chamber Reverb. The MPX R1 Toe Switch activates pedal control of volume or wah.

**Programs 100-149 are designed to be used with the MPX G2 connected to a guitar amp with no effects loop.**

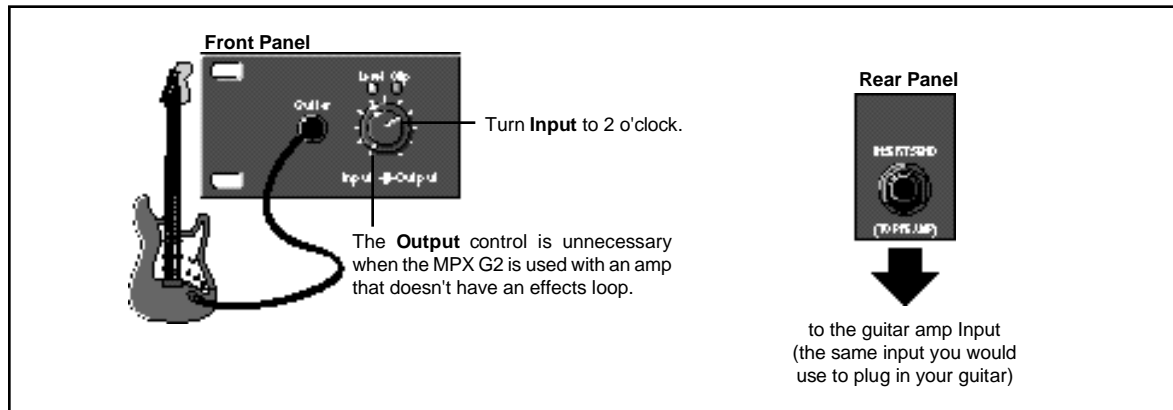

#### 100 Vintage Rig

A collection of classic stomp boxes just waiting to be activated. Press **Gain** for a Screamer, **Effect 1** for a UniVybe, **Effect 2** for a Wah and **Chorus** for a Flanger. The MPX R1 Toe Switch activates pedal control of volume or wah.

#### Top Ten (Amp Input Only)

#### 101 Pdl Octaves

Use a pedal to create outrageous octave sweeps. **A/B** changes the direction of the sweep. A=octave up, B=octave down. Check out the Glide parameter in the Soft Row. When it's set to Off, the pedal produces a chromatic glissando instead of a continuous glide.

#### 102 TechnoChords

Play a chord and let it ring out. Random tones ring out into delay and reverb. **A/B** changes the mix of the effect so that more of the original signal can be heard. The MPX R1 Toe Switch gives you pedal control of volume or of volume with a sweep filter scale.

#### 103 Cordovox

This program simulates the sound of a Cordovox cabinet — a single speaker with a rotating baffle that produces a swirling stereo vibe. The Gain effect is clean analog Tone that will boost your amp a bit so when you dig in you get some grit but, as you play lighter, or switch to less powerful pickups, you get cleaner sounds. **A/B** controls fast and slow speeds of the rotating baffle. The MPX R1 pedal controls volume, the Toe Switch turns the pedal On and Off.

#### 104 Analog Echo

This program produces sounds with many of the characteristics of vintage analog echo effects — including the tendency to “run away” if you push the feedback too hard. If you've ever played around with an old tape echo, you'll recognize this sound. This key to this effect is putting the analog Gain block inside the delay feedback loop. The signal is recirculated through the analog section every time the delay repeats. The result is a literal analog echo. A chorus is inserted in the feedback loop as well.

#### 105 Wah & Uni

A great rig with Wah, UniVybe and Screamer tweaked to drive a guitar amp running with lots of gain. Use the MPX R1 Toe Switch to swap the Wah with the UniVybe. While the UniVybe is active, the pedal is an amp input volume control. The Screamer overdrive is bypassed when the program loads — press **Gain** to give your amp a kick. **Tap** sets the echo rhythm.

**106 EnvFilter LP**

A very funky, synth-like effect, reminiscent of a Mu-tron III set to "LP". The dynamics of your playing opens and closes a resonant filter. Change the Scale parameter in the Soft Row to adjust to the output differences of different guitars and basses.

**107 InfiniteEcho**

A variation of **Analog Echo** that adds the BlueComp compressor and Detune(M) to the analog feedback path. The compressor limits the feedback signal so that the effect never runs away. You can increase the number of repeats by turning up the front panel tone controls as well as altering the Delay Fbk parameter in the Soft Row.

**108 FuzzWah+**

Loads with a compressor on and a fuzz wah just waiting to be activated by the MPX R1 Toe Switch. The MPX R1 pedal controls the wah; the Toe Switch simultaneously turns gain and wah on or off. **A/B** adds chorus and echo.

**109 JamMan**

It's baaaack!!!!!! A medium-gain preamp with a chorus, reverb and a 20-second single loop JamMan! The MPX G2 front panel buttons or the MPX R1 control:

**Tap** = Record Loop

**A/B** = Layer

**Delay** = Clear Loop

The MPX R1 Toe Switch lets the pedal control volume (Toe Switch off) or wah (Toe Switch on).

**Analog Gain  
(Amp Input Only)**

Programs 110-119 are examples of dry sounds from the analog gain section. These are designed to be used as stomp boxes before your amp. There are no effects in these programs.

**110 Tone Boost**

A set of analog tone controls that can be used as a clean boost in front of your amp or as a variation of clean analog EQ. Great in front of your amp for tone shaping or as a clean analog gain boost to give your amp a kick.

**111 Crunch Boost**

Overdrive with separate drive controls for low, mid and high frequencies. Gives kick to basic blues sounds.

**112 TS Lead**

Our recreation of the classic TS-9. Great for virtually any application — blues, rock jazz, metal etc.

**113 TS Boost**

A variation of TS Lead with less overall distortion and more level boost.

**114 OD Lead**

A more aggressive effect than Screamer but it still produces the classic overdrive.

**115 OD Boost**

A variation of OD Lead with less overall distortion and more level boost.

**116 Dist Lead**

Need more than Overdrive? Distortion provides more than 100dB of analog gain.

**117 Dist Boost**

A variation of Dist Lead with less overall distortion and more level boost.

**118 Fuzz 1**

Analog fuzz.

**119 Fuzz 2**

A more aggressive variation of Fuzz 1.

Programs 120-139 each contain a single effect. Use them alone, or as building blocks to create your own multi-effects programs from scratch. Use **Copy Effect** in Edit mode to copy different combinations into a single program.

## Effects Collection (Amp Input Only)

**120 Univibe**

Our recreation of a vintage Uni Vibe, a signature Hendrix sound.

**121 Octave Fuzz**

This program combines a sub octave with Octavia-style effects with analog distortion. The sub octave comes in when **A/B** is toggled to B. Turn **Gain** on and off to control the fuzz distortion. **Effect 2** is the OctaBuzz. To get that Hendrix sound, turn off the sub octave and play single notes above the 12th fret using your neck pickup. The MPX R1 Toe Switch simultaneously turns the shifter, Octabuzz and distortion on and off. The pedal is a power amp booster that provides an additional 6dB of volume to kick a solo out over the edge.

**122 Phaser**

A recreation of the classic Mu-tron Phaser

**123 EnvFilter**

A recreation of the Mu-tron autowah. Look out Bootsy!

**124 C-Wah:**

Our recreation of the classic Crybaby Wah. The MPX R1 pedal controls the wah sweep while the MPX R1 Toe Switch turns the wah on and off like the original.

**125 Blue Comp**

A recreation of the Boss CS-2 Compressor — a staple of many country players.

**126 Vintage Trem**

A classic vintage tremolo.

**127 IPS TapeSlap**

Press **A/B** to select delays that simulate 7.5 or 15ips tape slaps. Modified to be used before your amp's input.

**128 Space Echo**

A simple but tasty delay effect. The sound changes with each repeat. For the sound of the more expensive version, press **Chorus**, which is bypassed when the program loads.

**129 Octabuzz**

Another classic Octavia effect — best known from Purple Haze.

**130 OrangePhase**

A recreation of the Phase 90 effect made famous by Eddie Van Halen.

**131 Gray Flange**

The flanger that created the signature sound on Van Halen's "Unchained".

**132 RedComp**

A recreation of the popular Dyna Comp compressor.

**133 S/H Pedal**

A recreation of the Maestro pedal used by Frank Zappa in the 70's.

**134 V-Wah**

Our recreation of the classic Vox Wah. The MPX R1 pedal controls the wah sweep. The Toe Switch turns the wah on and off like the original.

**135 Modern Trem**

A modern (alternative style) tremolo with a sharper, square wave type feel than a vintage tremolo.

**136 Tap Echo**

**Tap** sets the echo rhythm. **A/B** turns the input to the echo on and off (so that the repeats ring out when you turn it off). The MPX R1 pedal sets the loudness of the echoes. Press **Soft Row** for instant access to all of the delay parameters. The program loads with delay time set to 2 echoes/beat (8th note). Be sure to experiment with different values.

**137 Env Wah**

The sweep of this wah is dynamically controlled by your playing. Similar to the sound of a Mu-tron III set to BP.

**138 StereoChorus**

A lush Lexicon stereo chorus designed to be used before your amp's input.

**139 Classic Detune**

This program puts a dual pitch shifter in front of your amp. It loads set to the classic  $\pm 8$  cent values — but feel free to tweak these.

**Bass Effects  
(Amp Input Only)**

Programs 140-145 are optimized for bass sounds.

**140 BassComp1**

A preamp and compressor.

**141 BassCompChrs**

A preamp compressor and chorus.

**142 Bass Fuzz**

A preamp with distortion.

**143 BassPitchPdl**

A preamp with a pedal controlling the pitch up and octave. Press **A/B** to go up or down an octave.

**144 BootsyBass**

Bass preamp with a Bootsy-style auto wah.

Programs 145-149 are set up to have the MPX G2 front panel buttons or the MPX R1 control:

**Tap** = Record Loop  
**A/B** = Layer  
**Delay** = Clear Loop

**JamMan**  
**(Amp Input Only)**

**145 Jam 1 S&H+**

Loads with a Sample & Hold style effect. The MPX R1 Toe Switch activates pedal control of volume.

**146 Jam1Cordovox**

The MPX R1 Toe Switch turns the Cordovox effect on and off, the pedal controls the Cordovox speed. Press **Gain** for Overdrive.

**147 Jam1 Uni+**

Loads with Univybe. Press **Gain** for overdrive. The MPX R1 Toe Switch activates pedal control of volume or wah.

Programs 148-149 are set up to have the MPX G2 front panel buttons or the MPX R1 control:

**Tap** = Record Loop  
**A/B** = Replace  
**Delay** = Start/Stop Loop

**148 Jam 2 Pitch+**

Loads with Distortion and Pitch. The MPX R1 Toe Switch swaps pedal controls between volume (Toe Switch off) and pitch (Toe Switch on).

**149 Jam 2 Flange+**

Loads with a Jet Flange. Press **Gain** for Screamer. The MPX R1 Toe Switch activates pedal control of volume or wah.

**Programs 150-248 are designed to be used with the MPX G2 connected directly to a mixer or power amp**

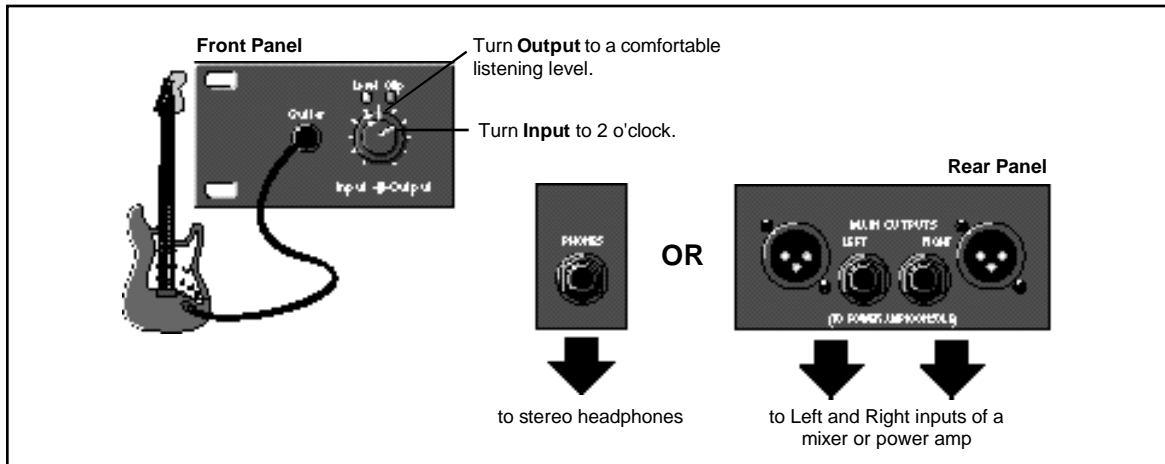

**Top Ten  
(Stand Alone)**

**150 Big Blue**

A smooth and creamy high-gain analog preamp with a classic RedComp before the preamp to add super sustain. After the preamp section is a lush wet chorus which enters a dual delay with **Tap** tempo control. The entire signal then goes through a classic Lexicon Large Hall. **A/B** switches gain from high-gain to bluesy clean. Great for leads! The MPX R1 pedal controls volume, which is the first effect in the chain so that you can create ethereal textural sounds. The MPX R1 Toe Switch turns volume on and off.

**151 Blues Club**

A creamy blues sound with just a hint of compression in a medium room to create the feeling of playing in an actual Blues Club. Can I buy you a beer? **A/B** shuts reverb off and turns on a **Tap** tempo delay. The MPX R1 Toe Switch activates pedal control of volume or wah.

**152 Acoustifier**

Acoustify your electric guitar! Acoustic sound with Detuning and Reverb works especially well on the neck pickup. **A/B** shuts reverb off and turns on a **Tap** tempo delay. The MPX R1 pedal controls volume to let you swell your chords into the Reverb.

**153 British Stack**

Classic British style gain with a hint of ambience to fatten up the sound. Play your favorite classic riffs with this sound. **A/B** adds a gain boost. The MPX R1 Toe Switch activates pedal wah.

**154 PedalSwell**

Smooth gain and compression with chorus and delay that go into a panner. A truly stereo effect. **A/B** controls delay feedback time from 20-80%. The MPX R1 pedal lets you create ethereal volume swells, the Toe Switch controls pedal on and off. **Tap** sets delay times.

**155 Clean Jimi**

This program lets you use **A/B** to alternate between two clean sounds inspired by the double-stop rhythm riffing in tunes like "The Wind Cries Mary" and "Little Wing". The A sound is clean guitar into a plate reverb with 15 ips pre-delay. The B sound adds pre-gain Univibe and gain boost for a little grit. A Model C Wah is waiting to be kicked on with the MPX R1 Toe Switch.

**156 Metal Stack**

Get out your heaviest chops and burn. Super high gain setting with lots of tone and just a hint of ambience. **A/B** changes the sound from dirty to clean and adds more reverb. The MPX R1 Toe Switch activates pedal wah.

**157. Pdl Octaves**

Use a pedal to create outrageous octave sweeps. **A/B** changes the direction of the sweep (A=octave up, B=octave down). Chorus, delay and reverb are in the effects loop. Check out the Glide parameter in the Soft Row. When it's set to Off, the pedal produces a chromatic glissando instead of a continuous glide.

**158 Guitar Solo**

Fat spongy dynamic distortion with detuning delay and classic plate reverb. A sound very reminiscent of Eric Johnson. **A/B** controls delay damping. The MPX R1 pedal lets you swell your chords into the reverb, the Toe Switch controls pedal on and off. **Tap** sets echo times.

**159 JamMan**

It's baaaack!!!!!! A medium-gain preamp with a chorus, reverb and a 20-second single loop JamMan! The MPX G2 front panel buttons or the MPX R1 control:

**Tap** = Record Loop

**A/B** = Layer

**Delay** = Clear Loop

The MPX R1 Toe Switch lets the pedal control volume (Toe Switch off) or wah (Toe Switch on).

Programs 160-179 give you signature sounds from artists and from specific songs.

**Artist/Song  
(Stand Alone)****160 Jimmy P...**

Classic Zep tone with a vintage plate reverb. Try the intro to "Whole Lotta Love". The MPX R1 Toe Switch activates pedal wah.

**161 Satch...**

Try "Summer Song" with this one. Press **A/B** to switch from Satch dirty to Satch clean with more chorus. The MPX R1 Toe Switch activates pedal wah.

**162 Kiss the Sky**

Hendrix-style preamp with an Octabuzz. **A/B** turns off the Octabuzz and switches between two different echo times. The MPX R1 Toe Switch activates pedal control of volume.

**163 Angus...**

"Back in Black" anyone?

**164 The Edge...**

Takes you to "Where the Streets have no Name". A syncopated delay with **Tap** control of delay times. The MPX R1 pedal controls pre-gain volume, the Toe Switch turns the pedal on and off.

**165 Sandman**

**A/B** controls channel switching from Hammett Dirty to Hammett clean. The MPX R1 Toe Switch activates pedal wah.

**166 Brian M...**

Medium gain with a slight bit of detuning. The MPX R1 Toe Switch activates pedal wah.



**167 Blow By...**

Play any riff from this album. A simple, moderately clean sound. The MPX R1 Toe Switch activates pedal wah.

**168 Old Eddie**

Classic VH tone from the first couple of albums — with the reverb hard-panned to the right. **A/B** swaps between an OrangePhase or a Flanger inspired by “Unchained”. Press **Delay** for a single repeat echo before the preamp. The MPX R1 pedal controls pre-gain volume, the Toe Switch turns the pedal on and off.

**169 New Eddie**

A bit of detune and it's 5150 time. **A/B** adds a stereo delay and a bit more reverb. The MPX R1 Toe Switch activates pedal wah.

**170 LiveJimi**

Classic Hendrix tone with a Univibe and a plate reverb. Press **A/B** to shut off the reverb and add an Octabuzz effect and a slapback echo for some classic Hendrix tones. The MPX R1 pedal controls volume, the Toe Switch turns the pedal on and off.

**171 Cliffs of...**

A fat overdriven tone with pregain inspired by Eric Johnson. RedComp for compression, detuning, delays and vintage plate reverb. **A/B** makes the overall sound of the effects wetter. The MPX R1 Toe Switch activates pedal wah.

**172 Cold Shot**

Classic Stevie Ray tone with a Vibro Tone rotary speaker effect. **A/B** controls the slow and fast rotary settings. The MPX R1 Toe Switch activates pedal wah.

**173 Carlos S...**

A fat California sound with lots of highs rolled off, and a bit of reverb.

**174 Jazzman**

A classic jazz sound reminiscent of Pat Metheny. Warm clean tone with compression, chorus, stereo delays and a lush reverb. The MPX R1 pedal controls volume, the Toe Switch turns the pedal on and off.

**175 Boston**

The mid range over-compressed chorused distortion sound that sold millions. Press **A/B** for Boston-style dual delays. The MPX R1 pedal controls volume, the Toe Switch turns the pedal on and off.

**176 Purple Reign**

“The Artist” at his best. Clean tone, lush chorus and reverb. MPX R1 Toe Switch swaps the pedal controls from a volume to wah pedal. The MPX R1 pedal controls the volume or wah depending on the state of the Toe Switch.

**177 Another Brick**

This echo/chorus program was inspired by Pink Floyd. “Hey! Leave those kids alone!” Press **A/B** to split delay times in half. The MPX R1 pedal controls volume, so you can swell your chords into the reverb. The Toe Switch turns the pedal On and Off.

**178 China Grove**

Medium gain with a single echo creates the sound. It's that simple. The MPX R1 Toe Switch activates pedal wah.

**179 Tush**

I've been up, I've been down... Check out this ZZ Top inspired sound. The MPX R1 Toe Switch activates pedal wah.

Programs 180-199 give you a collection of guitar amp tones from vintage to modern and everything in between.

## **Amp Collection (Stand Alone)**

### **180 AmericanClean**

Super clean American round clean sound with lots of headroom. Plenty of lows and highs. Great for clean chords or country leads.

### **181 AmericanOD**

Adds a bit of Overdrive to **American Clean** to simulate the amp being cranked up. Great for country rock.

### **182 AmericanGain**

An American amp overdriven with a hint of ambience. Responds well to dynamics — use this for a straight-ahead rock sound.

### **183 Roadhouse**

Straight-ahead bluesy preamp with just enough grit and some tasty reverb.

### **184 Taxmania**

Use this sound with classic 60's pop riffs.

### **185 British 60's**

The medium overdriven sound of a British amplifier. Think Hendrix.

### **186 British 70's**

A moderately overdriven sound based on **British 60's** with more overall gain. Think Zeppelin.

### **187 British 80's**

Classic British style high-gain amp with a touch of ambience to open up the sound. Great for leads or chunky rhythms. Think Van Halen.

### **188 AmericanMod**

A hot rodded American style amp with lots of bottom end and sustain. Think Eric Johnson.

### **189 ModernHiGain**

Super high gain with tons of sustain and a bit of ambience. Great for metal leads and rhythms. Think Metallica.

### **190 TransChorus1**

A popular solid-state twin with built-in chorus.

### **191 TransChorus2**

The same solid-state twin as **TransChorus1** with different chorus and tone settings.

### **192 Jazz Bright**

Tight, articulate and bright. This amp will really bring out those clean fluid lines. It has a built-in chorus and silky reverb too.

### **193 Jazz Dark**

This amp is set for a darker tone to give some weight to comping and chord melodies. Push it hard to put an edge on your bop — Imagine an organ trio in a smoke-filled club.

### **194 Acoustic**

A preamp sound which can make your clean electric guitar sound almost acoustic. Works especially well on the neck pickup.

**195 Little Amp**

A tiny “hog-style” amp with a 6 inch speaker.

**196 Phone Filter**

Overcompressed and drastically EQ'd, this is an effective way to accent a part or phrase within a mix.

**197 Vibro Cab**

The original Vibro Tone guitar cabinet had a rotating baffle in front of a 12 inch guitar speaker. It produced a swirling sound by spraying the speaker output through the top and sides of the cabinet as the baffle rotated. A built-in crossover sent high frequencies back to the original guitar amp so that the top end sound didn't swirl. We use a crossover, stereo chorus and auto panners to create the effect. **A/B** toggles between slow and fast rotary speeds

**198 Cordovox**

The original Cordovox had a rotating baffle cabinet. It had an 8 inch speaker which had pretty limited bass and treble frequency response and distorted quite easily. Sound was projected out of the top and sides of the cabinet. Our version uses the preamp to recreate the amp and speaker characteristics. The sound is gritty, so when you dig in you get a lot of distortion but, as you play lighter or switch to less powerful pickups, you get cleaner sounds. Stereo chorus and auto panners are used to create the swirl. **A/B** toggles between slow and fast rotary speeds.

**199 Rotary Cab**

A Leslie speaker has separate rotating elements for treble and bass. Our version adds Chamber reverb to put the cab in in a small room. The preamp sound is clean with a little bit of grit, so when you dig in you get some distortion. **A/B** button controls fast and slow speeds of the rotary speaker.

**Studio Spaces  
(Stand Alone)**

Programs 200-209 are designed to give you a suite of realistic reverberation and ambience treatments for electric and acoustic guitar tracks. Think of this as adding several different live-tracking rooms plus some classic Lexicon reverb processors to your studio.

Each program can be used stand alone for tracking — just plug in your guitar and record direct through the MPX G2 built-in preamp. (You can easily change the preamp by using **Copy Effect** in Edit mode to copy the preamp from any other program.

These programs can also be used for tracking with an external preamp as well as for processing pre-recorded tracks during mixdown.

When using an external preamp, connect its outputs to the MPX G2 Insert Return jacks. Use the MPX G2 Speaker Simulator to fine tune the raw preamp sound.

To process pre-recorded tracks, connect the MPX G2 Insert Returns to your console's sends as you would any stereo processor. Turn off the MPX G2 Speaker Simulator and Noise Gate, and set Post Mix (in Edit: Mix mode) to 100% wet.

**200 TrackingRoom**

This program features the Ambience effect. Use it to add room sound without adding the decay associated with reverberation. This is a great way to add “air” to when you're tracking direct. Stereo EQ (in the Soft Row) lets you fine tune the sparkle and boom (high and low frequencies).

**201 Acoustic Room**

This program is designed for acoustic guitar. The reverb blooms nicely behind the notes thanks to a compressor on the reverb inputs.

**202 Jazz Club**

A moderate, but dense, reverb that fattens up cleanly articulated melodies and chords. Be sure to experiment with reverb predelay (P Dly in the Soft Row). Use it to allow the attack of notes to stay "in your face"

Programs 203-205 can be used individually or in any combination. Each is made up of a medium-sized, live room hung with near and far microphone pairs. Rvb Mix controls the overall direct-to-room sound mix. The Far Mics parameter provides an independent control for the level of the distant microphones. You'll find these parameters, as well as PDly and the other important reverb tweaks in the Soft Row.

**203 Solo Room**

A high-gain amp in a live room with a direct feed, as well as near and far microphones. Both sets of mics are stereo pairs. The overall image is balanced in the stereo field.

**204 RhythmRoom L**

A clean amp in the same live room as **Solo Room**, but with the near mics panned left of center and the far mics panned right of center. The stereo image is left-heavy on rhythmic attacks, and shifts to the right as the notes fade.

**205 RhythmRoom R**

Similar to **RhythmRoom L**, with the panning of the mics reversed. Initial attacks are heard on the right side, then shift to the left as the notes fade.

**206 MicPlacement**

This program lets you vary the position of a close microphone in front of high-gain amp. (Use the Placement parameter in the Soft Row.) Altering the position will create phase differences that change the overall timbre of the sound.

**207 Tape->Plate**

This combination of tape predelay in front of a plate reverb can be heard on most of the classic rock recordings from the 60's and 70's. **A/B** changes the tape delay from 15ips to 7.5ips.

**208 PCM 60 Room**

This program recreates the settings of a Lexicon PCM 60, tweaked for guitar.

**209 Gated Verb**

More of an effect than a natural space, gated reverb can be quite useful to thicken up rhythmic parts without spilling over into the rest of the mix.

## Studio Effects (Stand Alone)

Programs 210-219 are designed to give you a collection of classic studio effects for recording guitar tracks. Each program can be used stand alone for tracking — just plug in your guitar and record direct through the MPX G2 built-in preamp. (You can easily change the preamp by using the Copy Effect function in Edit mode to copy the preamp from any other program.)

These programs can also be used for tracking with an external preamp as well as for processing pre-recorded tracks during mixdown.

When using an external preamp, connect its outputs to the MPX G2 Insert Return jacks. Use the MPX G2 Speaker Simulator to fine tune the raw preamp sound.

To process pre-recorded tracks, connect the MPX G2 Insert Returns to your console's sends as you would any stereo processor. Turn off the MPX G2 Speaker Simulator and Noise Gate, and set Post Mix (in Edit: Mix mode) to 100% wet.

Note: Program **218 Analog Echo** and **219 InfiniteEcho** are designed to get input from the MPX G2 Guitar Input jack. When using these MPX G2 programs with a console, connect the console send to the MPX G2 Guitar input.

### 210 Classic Detune

A simple but gorgeous effect. The dual pitch shifter is used to independently detune the left and right sides of the stereo field. The classic settings are  $\pm 8$  cents, but feel free modify these default settings.

### 211 Comp + Chrs

Compressor and stereo chorus combined for a chiming effect. Stereo delays are tuned up too, but are bypassed when the program loads. Press **Delay** to bring them in.

### 212 Stereo Phaser

Two separate OrangePhaser effects independently process left and right channels.

### 213 Env AutoPan

RedComp pumps up the signal before it gets to Preamp. From there, it runs through reverb auto pan, chorus and delay. The twist here is that the panner rate is envelope-controlled. Play a big chord and listen to what happens as it rings out. The MPX R1 pedal controls the depth of the panning. **Tap** sets the delay rhythm.

### 214 Env AutoWahs

An alternative take on standard tremolo effects. Dual auto wahs are controlled by your playing dynamics. The MPX R1 pedal controls the depth of both wahs.

### 215 EnvFilter LP

A very funky, synth-like effect, reminiscent of a Mu-tron III set to "LP". The dynamics of your playing opens and closes a resonant filter. **A/B** brings in some stereo echoes. The MPX R1 pedal controls the effects sensitivity to your playing dynamics. The Toe Switch turns the effect on and off.

### 216 Dual Delay

Basic, but essential. Left and right channel delays — each with independent delay time (up to 10 seconds), level, pan and feedback controls. Everything is in the Soft Row for instant access. You can make one or both of these delays tempo-controlled. Just press **Options** with the Time parameter displayed, select "echoes:beat" and press **Options** again.

**217 EQ Delay**

A mono 20-second delay with 2-band parameteric EQ in the feedback path. In this program the EQ is set to simulate the frequency roll-offs associated with analog tape, but you can create all sorts of unusual echo effects by varying the EQ parameters. Everything you need is in the Soft Row. (Be careful with EQ Gain settings when using delay feedback — in general, it's best to cut EQ Gain rather than boost it.)

**218 Analog Echo**

This program produces sounds with many of the characteristics of vintage analog echo effects — including the tendency to “run away” if you push the feedback too hard. If you've ever played around with an old tape echo, you'll recognize this sound. This key to this effect is putting the analog Gain block inside the delay feedback loop. The signal is recirculated through the analog section every time the delay repeats. The result is a literal analog echo. A stereo chorus is inserted in the feedback loop as well. Note that, as Insert Returns are also in the feedback loop, the Insert path is bypassed when this program is loaded.

**219 InfiniteEcho**

A variation of **Analog Echo** that adds the BlueComp compressor and Detune(M) to the analog feedback path. The compressor limits the feedback signal so that the effect never runs away. You can increase the number of repeats by turning up the front panel tone controls as well as altering the Delay Fbk parameter in the Soft Row. Note that, as Insert Returns are also in the feedback loop, the Insert path is bypassed when this program is loaded.

Programs 220-229 give you playing styles from Surf to Techno.

## Styles (Stand Alone)

**220 Surf's Up!**

A surf sound that would make even Dick Dale envious. Press **Tap** to change the tremolo rate.

**221 Slide Comp**

A gritty preamp and two compressors in series. This is a slide players' secret that enables them to get singing sustain when playing with a light touch.

**222 Funk+FX**

Ultra-clean, super compressed sound with chorus and a little bit of ambience to add some depth. The MPX R1 Toe Switch activates pedal wah.

**223 Ballad Lead**

Perfect lead sound for a rock ballad. Warm high-gain preamp with a hint of chorus and **Tap** tempo delay. All this flows into a lush plate reverb. The MPX R1 pedal controls volume. The Toe Switch turns the pedal on and off.

**224 De DaDaDa**

A great overall clean sound inspired by Andy Summers. **A/B** adds delay and more flange depth. **Tap** controls the rhythm of the delay times. The MPX R1 pedal controls volume. The Toe Switch turns the pedal on and off.

**225 Rockabilly**

Country chops — a clean preamp with some slap back echo and a little ambience. **A/B** changes from one slap back time delay time to another. The MPX R1 pedal controls volume. The Toe Switch turns the pedal on and off.

**226 Country Rock**

Similar to **Rockabilly** with a hotter, more overdriven preamp sound. Useful for a lot of current country sounds. **A/B** changes from one slap back time delay time to another. The MPX R1 pedal controls volume. The Toe Switch turns the pedal on and off.

**227 Ultra Clean**

An Alex Lifeson type clean sound with a triplet delay.

**228 Acoustic&FX**

An acoustic style preamp with compression and a chamber reverb. The MPX R1 pedal controls volume. The Toe Switch turns the pedal on and off.

**229 TechnoChords**

Play a chord and let it ring out. Random tones ring out into delay and reverb. **A/B** changes the mix of the effect so that more of the original signal can be heard. **Tap** changes delay time. The MPX R1 Toe Switch gives you pedal control of volume or of volume with a sweep filter scale.

**Live Rigs  
(Stand Alone)**

Programs 230-232 are rigs in which the MPX G2 **A/B** button changes the program from a lead sound with various effects to a rhythm sound with different effects.

**230 Modern A/B**

Super saturated high-gain lead sound with **Tap** tempo delay control. **A/B** replaces the delay with reverb, and changes the preamp from lead to rhythm. The MPX R1 pedal controls volume. The Toe Switch turns the pedal on and off.

**231 British A/B**

The lead sound is classic British style gain with delay. **A/B** switches from dirty with delay to clean with chorus and reverb. The MPX R1 Toe Switch activates pedal wah.

**232 American A/B**

The lead sound combines overdriven American gain with compression, and echo. **A/B** switches from compression and echo to Uni/Vybe with reverb. The MPX R1 pedal controls volume. The Toe Switch turns the pedal on and off.

**Tremolo/Pitch  
(Stand Alone)**

Programs 233-239 give you a variety of tremolo-based and pitch effects.

**233 Detune Trem**

This one delivers the big throb with a tempo-controlled tremolo in front of your amp, dual pitch shift, delay and reverb in the effects loop. Tremolo depth is pedal-controlled. **A/B** goes from dry to wet.

**234 DualAutoWahs**

Dual auto wahs are controlled by your playing dynamics. The pedal controls the depth of the stereo wahs. **A/B** goes from dry to wet.

**235 TremoWah**

An LFO/tempo-controlled wah before a high-gain preamp, followed by an LFO/tempo-controlled tremolo which flows into a tempo-controlled delay and then a stereo panner. Listen to the results! **A/B** changes the mix value of the wah and tremolo. The MPX R1 pedal controls volume, the Toe Switch turns the pedal on and off.

**236 Pitch Cascade**

This special effect is created by putting a dual pitch shifter in the feedback loop of a dual delay. **Tap** sets the delay rhythm. After going through the delay, the notes are pitch shifted. (**A/B** selects between up a fifth/down an octave and down a fourth/up an octave/.) Then the pitch-shifted notes are recirculated through the delay and pitch-shifted again. The recirculation is controlled by the XFbk1 and XFbk2 parameters. (They're in the Soft Row along with delay time and other goodies.)

**237 Octaves**

Use a pedal to fade two additional harmony voices in and out. **A/B** alternates between tunings. A=one octave up (doubled). B=one octave down and two octaves down.

**238 Pdl 2nds**

A pedal gives you whole step bends. A=bend up. B=bend down.

**239 E Maj/Min 3**

Tune up and play melodies in the Key of E. The DiatonicHmy effect automatically harmonizes your notes in thirds. Use **A/B** to alternate between E Major and E Minor (Aeolian). You can change to any other key by adjusting the value of the Key parameter — you'll find it in the Soft Row.

Programs 240-244 are designed for bass.

**Bass Effects  
(Stand Alone)****240 BassComp1**

A preamp and compressor.

**241 BassCompChrs**

A preamp compressor and chorus.

**242 Bass Fuzz**

A preamp with distortion.

**243 BassPitchPdl**

A preamp with a pedal controlling the pitch up and octave. Press **A/B** to go up or down an octave.

**244 BootsyBass**

Bass preamp with a Bootsy-style auto wah.



**JamMan  
(Stand Alone)**

Programs 245-248 are set up to have the MPX G2 front panel buttons or the MPX R1 control:

**Tap** = Record Loop  
**A/B** = Layer  
**Delay** = Clear Loop

**245 Jam 1 S&H+**

Loads with moderately clean preamp and a Sample & Hold style effect into a large hall Reverb. The MPX R1 pedal controls the volume, or volume with sweep filter scale, depending on the state of the Toe Switch.

**246 Jam1Cordovox**

Loads with a creamy overdriven preamp and a Cordovox effect with reverb. The MPX R1 Toe Switch turns the Cordovox effect on and off, the pedal controls the Cordovox speed.

Programs 247 and 248 are set up to have the MPX G2 front panel buttons or the MPX R1 control:

**Tap** = Record Loop  
**A/B** = Replace  
**Delay** = Start/Stop Loop

**247 Jam 2 Pitch+**

Loads with high-gain preamp, Pitch and Ambience. The MPX R1 Toe Switch swaps pedal controls between volume (Toe Switch off) and pitch (Toe Switch on).

**248 Jam2AutoWah**

Clean style preamp with auto wah. The MPX R1 Toe Switch determines whether the pedal controls volume or wah.

**Utility  
(All Configurations)**

**249 Unity Gain**

This program is set up for testing a unity gain signal in all configurations.

**250 Clean Slate**

Want to start from scratch? This one's as empty as they get.

## Troubleshooting

This chapter is intended primarily to help you recognize some common error states which can be corrected from the MPX G2 front panel, or by simple means such as cable replacement. Any error states which are not covered here should be referred to your local dealer or Lexicon Customer Service.

Technical support is also available at:  
<http://www.lexicon.com/support/homeframe.htm>  
<http://www.lexicon.com/kbase/kbase.asp>

In a low-voltage, or "brown-out" condition (less than 40VAC), the MPX G2 will freeze in its current state. None of the controls will have any effect. When power returns to a normal level, the unit will reset itself as though it had just been powered on. If the unit does not reset itself, turn the power OFF, then ON to resume normal operation.

### Low Voltage

Temperature extremes may cause the MPX G2 to exhibit unpredictable behavior. If the unit has been subjected to temperatures below 32°F (0°C) or above 95°F (35°C), it should be turned off and allowed to return to normal temperature before use. The unit may be damaged by exposure to temperatures below -22°F (-30°C) or above 167°F (75°C), or by exposure to humidity in excess of 95%. If a unit exposed to such conditions fails to operate after it returns to a normal operating temperature, contact your local service representative.

### Overheating

#### **The MPX G2 doesn't respond to MIDI Program Changes.**

The MPX G2 and connected devices must be set to matching MIDI Channels, or the MPX G2 must have OMNI selected for receipt of MIDI messages. In the **System** mode **MIDI** menu, check the **Receive** control for the MIDI Channel selected, as well as the MIDI Channel of the transmitting device.

### Common MIDI Problems

Make sure that **Pgm Change** in the System mode **MIDI** menu is set to **On**. See Chapter 6: *MIDI Operation* for Program Change messages which may be ignored by the MPX G2.

Check MIDI In/Out connections between the units.

#### **MIDI Program Change numbers are off by 1.**

The MPX G2 transmits and recognizes ProgramChange messages 0-127. MIDI devices which transmit 1-128 rather than 0-127, will be off by 1.

**The MPX G2 doesn't respond to SysEx commands.**

Check the **SysEx** setting (and the **Receive Device ID** selection) in the **System** mode **MIDI** menu.

**The MPX G2 does not transmit SysEx Automation commands.**

Check the **Automation** setting (and the **Xmit Device ID** selection) in the **System** mode **MIDI** menu.

**Power On Behavior** The MPX G2 performs a series of self tests each time it is powered on, then displays the MPX G2 copyright notice. This should be followed by the display and loading of the last loaded effect. If this sequence does not occur, contact Lexicon Customer Service.

## MPX G2 Specifications

### I/O

<b>Instrument input:</b>	mono 1/4 inch 1meg $\Omega$ unbalanced, with analog soft clipping circuit and front panel input level control
<b>Levels:</b>	minimum +2.2dBu for full scale, maximum +10dBu max
<b>A/D:</b>	24-bit
<b>Return Inputs:</b>	stereo, 1/4 inch, 50k $\Omega$ unbalanced, with analog soft clipping circuit and ganged level control on rear panel
<b>Levels:</b>	minimum -10dBu for full scale maximum +18dBu max (for +4 nominal inputs) +18 dBu with rear level pot at minimum
<b>A/D:</b>	24-bit
<b>Main L and R Outputs:</b>	1/4 inch TRS balanced (2), XLR 3-wire balanced (2)
<b>Nominal Level:</b>	front panel adjustable to +4dBu
<b>Maximum Output Level:</b>	balanced: +18dBu into 600 $\Omega$ unbalanced: +21dBu into 100k $\Omega$
<b>D/A:</b>	24-bit
<b>Send Output:</b>	mono, 1/4 inch unbalanced
<b>Nominal Level:</b>	software adjustable to +4dBu
<b>Maximum Output Level:</b>	+18dBu into 100k $\Omega$
<b>D/A:</b>	24-bit

### Audio performance

<b>Frequency response:</b>	20Hz to 20kHz; +1 to -1.5dB for input to send +1 to -1.5dB for return to output
<b>THD+N:</b>	<0.01%, at 1kHz nominal output level .01% at 1kHz insert returns to main output .01% at 1kHz input to main outputs
<b>Dynamic Range:</b>	Instrument input to send: -110dB (unweighted) minimum Input to Send with Relay Bypass on -120dB (unweighted) Input to Send with Noise Gate on -97dB (unweighted) typical instrument to main outputs in Bypass
<b>Sample rate:</b>	44.1kHz
<b>Return Mix:</b>	When the Return Mix option is selected, MPX G2 will mix the analog Aux inputs with the post converter output signal from the DSP.
<b>Throughput delay without send/return loop:</b>	Input to Main Output <3ms, nominal

**Internal Audio Data Paths**

**Conversion:** 24-bit A/D, 24-bit D/A  
**DSP:** 32 bits

**Control Interface**

**MIDI:** 7-pin DIN connector for MIDI IN/powerd bidirectional remote  
5-pin DIN connectors for MIDI THRU and OUT  
**Footswitch:** 1/4 inch T/R/S phone jack for 3 independent footswitches  
**Foot pedal:** 1/4 inch T/R/S phone jack (10k $\Omega$  min, 100k $\Omega$  max impedance)  
**Remote Power In:** 2.5mm barrel for 9VAC remote power

**General**

**Dimensions:** 19.0"W x 1.75"H x 13"D (483 x 45 x 330mm)  
19 inch rack mount standard, 1U high  
**Weight:** Net: 7.2lbs (3.2kg)  
Shipping: 11lbs (4.98kg)  
**Power Requirements:** 100-240VAC, 50-60Hz, 25W, 3-pin IEC power connector  
**Environment:** Operating temperature: 32° to 104°F (0° to 40°C)  
Storage temperature: -20° to 170°F (-30° to 75°C)  
Humidity: maximum 95% without condensation

**Electrical Approvals**

**Safety Compliance:** UL1419 and CSA 22.2 No. 1-94 (UL and C-UL marks)  
EN60065 (TUV-GS and CE marking per Directive 73/23/EEC)  
**EMC Compliance:** FCC Class B  
EN55022 Class B and EN50082-1  
(CE marking per Directive 89/336/EEC)

*Specifications subject to change without notice.*

## Free Manuals Download Website

<http://myh66.com>

<http://usermanuals.us>

<http://www.somanuals.com>

<http://www.4manuals.cc>

<http://www.manual-lib.com>

<http://www.404manual.com>

<http://www.luxmanual.com>

<http://aubethermostatmanual.com>

Golf course search by state

<http://golfingnear.com>

Email search by domain

<http://emailbydomain.com>

Auto manuals search

<http://auto.somanuals.com>

TV manuals search

<http://tv.somanuals.com>