

Owner's Manual

***DC-2***

---

***Digital Controller***

**lexicon**

## Important Safety Instructions

Save these instructions for later use.

Follow all instructions and warnings marked on the unit.

Always use with the correct line voltage. Refer to the manufacturer's operating instructions for power requirements. Be advised that different operating voltages may require the use of a different line cord and/or attachment plug.

Do not install the unit in an unventilated rack, or directly above heat producing equipment such as power amplifiers. Observe the maximum ambient operating temperature listed in the product specification.

Slots and opening on the case are provided for ventilation; to ensure reliable operation and prevent it from overheating, these openings must not be blocked or covered. Never push objects of any kind through any of the ventilation slots. Never spill a liquid of any kind on the unit.

Never attach audio power amplifier outputs directly to any of the unit's connectors.

To prevent shock or fire hazard, do not expose the unit to rain or moisture, or operate it where it will be exposed to water.

Do not attempt to operate the unit if it has been dropped, damaged, exposed to liquids, or if it exhibits a distinct change in performance indicating the need for service.

This unit should only be opened by qualified service personnel. Removing covers will expose you to hazardous voltages.

This triangle, which appears on your component, alerts you to the presence of uninsulated, dangerous voltage inside the enclosure... voltage that may be sufficient to constitute a risk of shock.



This triangle, which appears on your component, alerts you to important operating and maintenance instructions in this accompanying literature.

Adhere to all warnings on the unit and in the operating instructions.

Take precautions not to defeat the grounding or polarization of the unit's power cord.

Do not overload wall outlet, extension cords or integral convenience receptacles, as this can result in a risk of fire or electrical shock.

Route power supply cords so that they are not likely to be walked on or pinched by items placed on or against them, paying particular attention to cords at plugs, convenience receptacles, and the point at which they exit from the unit.

The unit should be cleaned only as recommended by the manufacturer.

## Communications Notice

This equipment generates and uses radio frequency energy and if not installed and used properly, that is, in strict accordance with the manufacturer's instructions, may cause interference to radio and television reception. It has been type tested and found to comply with the limits for a Class B computing device in accordance with the specifications in Subpart B of Part 15 of FCC Rules, which are designated to provide reasonable protection against such interference in a residential installation. However, there is no guarantee that interference will not occur in a particular installation. If this equipment does cause interference to radio or television reception, which can be determined by turning the equipment OFF and ON, the user is encouraged to try to correct the interference by one or more of the following measures:

- Reorient the receiving antenna
- Relocate the computer with respect to the receiver
- Move the computer away from the receiver
- Plug the computer into a different outlet so that the computer and receiver are on different branch circuits.

If necessary, the user should consult the dealer or an experienced radio/television technician for additional suggestions. The user may find the following booklet prepared by the Federal Communications Commission helpful: "How to identify and Resolve Radio/TV Interference Problems." This booklet is available from the U.S. Government Printing Office, Washington, DC 20402, Stock No. 004-000-00345-4.

Le présent appareil numérique n'émet pas de bruits radioélectriques dépassant les limites applicables aux appareils numériques de la class B prescrites dans le Règlement sur le brouillage radioélectrique édicté par le ministère des Communications du Canada.

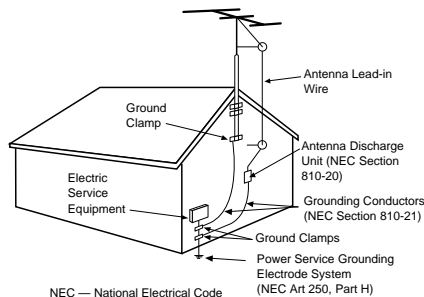

### Outdoor Antenna Grounding

If an outside antenna is connected to the receiver, be sure the antenna system is grounded so as to provide some protection against voltage surges and built-up static charges. Section 810 of the National Electrical Code, ANSI/NFPA No. 70-1984, provides information with respect to proper grounding of the mast and supporting structure, grounding of the lead-in wire to an antenna-discharge unit, size of grounding conductors, location of antenna-discharge unit, connection to grounding electrodes, and requirements for the grounding electrode. See figure below.

**Power Lines** An outside antenna should be located away from power lines.

## Acknowledgements

Manufactured under license from Dolby Laboratories. "Dolby", "Pro Logic", "AC-3", and the double-D symbol are trademarks of Dolby Laboratories Confidential Unpublished Works. ©1992-1997 Dolby Laboratories, Inc. All rights reserved.

Manufactured under license from Lucasfilm Ltd. U.S. patent numbers 5,043,970; 5,189,703; and 5,222,059. Foreign patents pending. "Lucasfilm" and "THX" are trademarks of Lucasfilm Ltd.

Manufactured under license from Digital Theatre Systems, Inc. U.S. Patent number 5,451,942 and other world-wide patents issued and pending. "DTS" and "DTS Digital Surround" are trademarks of Digital Theatre Systems, Inc. ©1996 Digital Theatre Systems, Inc. All rights reserved.

©Lucasfilm Ltd. & TM. All Rights Reserved. Surround EX is a jointly developed technology of THX and Dolby Labs, Inc., and is a trademark of Dolby. Used under authorization.

"Logic 7" and "Auto-Azimuth" are trademarks of Lexicon, Inc.

Copyright ©1999 Lexicon, Inc. All Rights Reserved. U.S. Patent numbers 4,862,502; 5,136,650 and 5,796,844; other patents pending on the DC-2.

Lexicon, Inc. • 3 Oak Park • Bedford MA • 01730-1441 USA • Tel: 781-280-0300 • Fax: 781-280-0490  
e-mail: info@lexicon.com • www.lexicon.com

Dansk

### Viktig information om sikkerhed

Gem denne vejledning til senere brug.

Følg alle anvisninger og advarsler på apparatet.

Apparatet skal altid tilsluttes den korrekte spænding. Der henvises til brugsanvisningen, der indeholder specifikationer for strømforsyning. Der gøres opmærksom på, at ved varierende driftsspændinger kan det blive nødvendigt at bruge andre lednings- og/eller stiktyper.

Apparatet må ikke monteres i et kabinet uden ventilation eller lige over andet udstyr, der udvikler varme, f.eks. forstærkere. Den maksimale omgivelsestemperatur ved drift, der står opført i specifikationerne, skal overholdes.

Der er ventilationsåbninger i kabinettet. For at sikre apparatets drift og hindre overophedning må disse åbninger ikke blokeres eller tildækkes. Stik aldrig noget ind igennem ventilationsåbningerne, og pas på aldrig at spilde nogen form for væske på apparatet.

Udgangsstik fra audioforstærkere må aldrig sættes direkte i apparatet.

Apparatet må ikke udsættes for regn eller fugt og må ikke bruges i nærheden af vand for at undgå risiko for elektrisk stød og brand.

Apparatet må aldrig bruges, hvis det er blevet stødt, beskadiget eller vådt, eller hvis ændringer i ydelsen tyder på, at det trænger til eftersyn.

Dette apparat må kun åbnes af fagfolk. Hvis dækslet tages af, udsættes man for livsfarlig højspænding.



Denne mærkat på komponenten advarer om uisoleret, farlig spænding i apparatet ... høj nok til at give elektrisk stød.



Denne mærkat på komponenten advarer om vigtig drifts- og vedligeholdelsesinformation i den tilhørende litteratur.

Suomi

### Tärkeitä turvallisuusohjeita

Säilytä nämä ohjeet tulevaa käyttöä varten.

Seuraa kaikkia yksikköön merkittyjä ohjeita ja varoituksia.

Käytä aina oikeaa verkkojännitettä. Tehovaatimukset selviävät valmistajan käyttöohjeista. Huomaa, että eri käyttöjännitteet saattavat vaatia toisenlaisen verkkojohdon ja/tai -pistokkeen käytön.

Älä asenna yksikköä telineeseen jossa ei ole tuuletusta, tai välittömästi lämpöä tuottavien laitteiden, esim. tehovahvistimien, yläpuolelle. Ympäristön lämpötila käytössä ei saa ylittää tuotespesifikaation maksimilämpötilaa.

Kotelo on varustettu tuuletusreillä ja -aukoilla. Luotettavan toiminnan varmistamiseksi ja ylläpitämisen välttämiseksi näitä aukkoja ei saa sulkea tai peittää. Mitään esineitä ei saa työntää tuuletusaukkoihin. Mitään nesteitä ei saa kaataa yksikköön.

Älä kytke audiotehovahvistimen lähtöjä suoraan mihinkään yksikön liittimeen.

Sähköiskun ja palovaaran välttämiseksi yksikkö ei saa olla sateessa tai kosteassa, eikä sitä saa käyttää märässä ympäristössä.

Älä käytä yksikköä jos se on pudonnut, vaurioitunut, kostunut, tai jos sen suorituskyky on huomattavasti muuttunut, mikä vaatii huoltoa.

Yksikön saa avata vain laitteeseen perehtynyt huoltohenkilö. Kansien poisto altistaa sinut vaarallisille jännitteille.



Tämä kolmio, joka esiintyy komponentissasi, varoittaa sinua eristämättömän vaarallisen jännitteen esiintymisestä yksikön sisällä. Tämä jännite saattaa olla riittävän korkea aiheuttamaan sähköiskuvaaran.



Tämä kolmio, joka esiintyy komponentissasi, kertoo sinulle, että tässä tuotedokumentoinnissa esiintyy tärkeitä käyttö- ja ylläpito-ohjeita.

Norsk

### Viktig informasjon om sikkerhet

Ta vare på denne veiledningen for senere bruk.

Følg alle anvisningene og advarslene som er angitt på apparatet.

Apparatet skal alltid anvendes med korrekt spenning. Produktbeskrivelsen inneholder spesifikasjoner for strømkrav. Vær oppmerksom på at det ved ulike driftsspenninger kan være nødvendig å bruke en annen ledning- og/eller støpseltype.

Apparatet skal ikke monteres i skap uten ventilasjon, eller direkte over varmeproduserende utstyr, som for eksempel kraftforstærkere. Den maksimale romtemperaturen som står oppgitt i produktbeskrivelsen, skal overholdes.

Apparatet er styrt med ventilasjonsåpninger. For at apparatet skal være pålitelig i bruk og ikke overopphetes, må disse åpningene ikke blokeres eller tildekkes. Stikk aldri noe inn i ventilasjonsåpningene, og pass på at det aldri søles noen form for væske på apparatet.

Utgangspluggene fra audioforstærkere skal aldri koples direkte til apparatet.

Unngå brannfare og elektrisk støt ved å sørge for at apparatet ikke utsettes for regn eller fuktighet og ikke anvendes i nærheten av vann.

Apparatet skal ikke brukes hvis det har blitt utsatt for støt, er skadet eller blitt vått, eller hvis endringer i ytelsen tyder på at det trenger service.

Dette apparatet skal kun åpnes av fagfolk. Hvis dekelet fjernes, utsettes man for livsfarlig høyspenning.



Komponenten er merket med denne trekanten, som er en advarsel om at det finnes uisolert, farlig spenning inne i kabinettet ... høy nok til å utgjøre en fare for elektrisk støt.



Komponenten er merket med denne trekanten, som betyr at den tilhørende litteraturen inneholder viktige opplysninger om drift og vedlikehold.

Svenska

### Viktiga säkerhetsföreskrifter

Spara dessa föreskrifter för framtida bruk.

Följ alla anvisningar och varningar som anges på enheten.

Använd alltid rätt nätspänning. Se tillverkarens bruksanvisningar för information om effektkrav. Märkväl, att andra matningsspänningar eventuellt kräver att en annan typs nätsladd och/eller kontakt används.

Installera inte enheten i ett oventilerat stativ, eller direkt ovanför utrustningar som avger värme, t ex effektförstärkare. Se till att omgivningens temperatur vid drift inte överskrider det angivna värdet i produktspecifikationen.

Behållaren är försedd med hål och öppningar för ventilering. För att garantera tillförlitlig funktion och förhindra överhettning får dessa öppningar inte blockeras eller täckas. Inga föremål får skuffas in genom ventilationshålen. Inga vätskor får spillas på enheten.

Anslut aldrig audioeffektförstärkarutgångar direkt till någon av enhetens kontakter.

För att undvika elstöt eller brandfara får enheten inte utsättas för regn eller fukt, eller användas på ställen där den blir våt.

Använd inte enheten om den har fallit i golvet, skadats, blivit våt, eller om dess prestanda förändrats märkbart, vilket kräver service.

Enheten får öppnas endast av behörig servicepersonal. Farliga spänningar blir tillgängliga när locken tas bort.



Denna triangel, som visas på din komponent, varnar dig om en oisolerad farlig spänning inne i enheten. Denna spänning är eventuellt så hög att fara för elstöt föreligger.



Denna triangel, som visas på din komponent, anger att viktiga bruksanvisningar och serviceanvisningar ingår i dokumentationen i fråga.

Deutsch  
**Wichtige Sicherheitsanweisungen**

Heben Sie sich diese Sicherheitsanweisungen auch für später auf.  
Befolgen Sie alle auf der Vorrichtung stehenden Anweisungen und Warnungen.  
Immer nur mit der richtigen Spannung verwenden! Die Gebrauchsanweisungen des Herstellers informieren Sie über die elektrischen Anforderungen.  
Vergessen Sie nicht daß bei verschiedenen Betriebsspannungen ggf. auch verschiedene Leitungskabel und/oder Verbindungsstecker zu verwenden sind.  
Stellen Sie die Vorrichtung nicht in ein unbelüftetes Gestell oder unmittelbar über wärmeerzeugende Geräte wie z.B. Tonverstärker. Halten Sie die in den Produktspezifikationen angegebene maximale Umgebungstemperatur bei Betrieb ein.  
Schlitze und Öffnungen im Gehäuse dienen der Belüftung; um verlässlichen Betrieb sicherzustellen und Überheizen zu vermeiden dürfen diese Öffnungen nicht verstopft oder abgedeckt werden. Stecken Sie nie irgend einen Gegenstand durch die Belüftungsschlitze. Vergießen Sie keine Flüssigkeiten auf den Apparat.  
Schließen Sie nie Tonverstärker unmittelbar an einen Anschluß des Apparates an.  
Um elektrischen Schlag oder Feuer zu vermeiden, setzen Sie den Apparat weder Regen noch Feuchtigkeit aus und betreiben Sie ihn nicht dort wo Wasser eindringen könnte.  
Versuchen Sie nicht den Apparat zu betreiben falls er fallen gelassen, beschädigt, oder Flüssigkeiten ausgesetzt wurde, oder falls sich seine Arbeitsweise derart ändert daß daraus ein Bedarf nach Reparatur zu schließen ist.  
Dieser Apparat sollte nur von qualifizierten Fachleuten geöffnet werden. Das Abnehmen von Abdeckungen setzt Sie gefährlichen Spannungen aus.



Dieses Dreieck auf Ihrem Apparat warnt Sie vor nicht-isolierter, gefährlicher Spannung im Gehäuse ... stark genug um eine Berühungsgefahr darzustellen.



Dieses Dreieck auf Ihrem Apparat bedeutet daß wichtige Betriebs- und Wartungsanweisungen in der mitgelieferten Dokumentation zu finden sind.

Español  
**Instrucciones importantes de seguridad**

Guarde esta instrucciones para uso posterior.  
Utilice siempre el voltaje correcto. Dirijase a las instrucciones de operación del fabricante para obtener las especificaciones de potencia. Esté al tanto de que voltajes de operación distintos requieren el uso de cables y/o enchufes distintos.  
No instale esta unidad en un estante sin ventilación, ni tampoco directamente encima de equipos que generen calor tales como amplificadores de potencia. Fijese en las temperaturas ambientales máximas de operación que se mencionan en las especificaciones del producto.  
Las aperturas y ranuras del chasis sirven para proveer la ventilación necesaria para operar la unidad con seguridad y para prevenir sobrecalentamiento, y por lo tanto no pueden ser obstruidas o cubiertas. No introduzca objetos de ningún tipo a través de las ranuras de ventilación, y nunca deje caer ningún líquido sobre la unidad.  
Nunca conecte ningún tipo de salida de amplificadores de sonido directamente a los conectores de la unidad.  
Para prevenir descargas eléctricas o incendios, mantenga la unidad alejada de la lluvia, humedad o cualquier lugar en el que pueda entrar en contacto con agua.  
No trate de hacer funcionar la unidad si se ha caído, está dañada, ha entrado en contacto con líquidos, o si nota cualquier cambio brusco en su funcionamiento que indique la necesidad de hacerle un servicio de mantenimiento.  
Esta unidad deberá ser abierta únicamente por personal calificado. Si usted quita las coberturas se expondrá a voltajes peligrosos.



Este triángulo que aparece en su componente le advierte sobre la existencia dentro del chasis de voltajes peligrosos sin aislantes ... voltajes que son lo suficientemente grandes como para causar electrocución.



Este triángulo que aparece en su componente lo alerta sobre las instrucciones de operación y mantenimiento importantes que están en los materiales de lectura que se incluyen.

Français  
**Instructions de Sûreté Importantes**

Gardez ces instructions pour référence future.  
Observez toutes les instructions et tous les avertissements marqués sur l'appareil.  
Branchez uniquement sur un réseau de tension indiquée. Consultez le manuel d'instruction du fabricant pour les spécifications de courant. N'oubliez pas que différentes tensions peuvent nécessiter l'utilisation de câbles et/ou de fiches de connexion différents.  
N'installez pas l'appareil en un compartiment non-aéré ou directement au-dessus d'équipements générateurs de chaleur, tels qu'amplificateurs de courants, etc. Ne dépassez pas la température ambiante maximale de fonctionnement indiquée dans les spécifications du produit.  
Des fentes et ouvertures sont prévues dans le boîtier pour l'aération; Pour assurer le bon fonctionnement et pour prévenir l'échauffement, ces ouvertures ne doivent pas être couvertes ou bloquées. N'insérez pas d'objets dans les fentes d'aération. Empêchez tout liquide de se répandre sur l'appareil.  
Ne connectez jamais d'amplificateurs audio directement aux connecteurs de l'appareil.  
Pour empêcher les chocs électriques et le danger d'incendie, évitez d'exposer l'appareil à la pluie ou à l'humidité, et ne le mettez pas en marche en un endroit où il serait exposé aux éclaboussures d'eau.  
N'essayez pas de faire fonctionner l'appareil s'il est tombé à terre, a été endommagé, exposé à un liquide, ou si vous observez des différences nettes dans son fonctionnement, indiquant la nécessité de réparations.  
Cet appareil ne doit être ouvert que par un personnel de service qualifié. En enlevant les couvercles vous vous exposez à des tensions électriques dangereuses.



Ce triangle, sur votre appareil vous avertit de la présence de tension dangereuse, non-isolée à l'intérieur du boîtier...une tension suffisante pour représenter un danger d'électrocution.



Ce triangle sur sur votre appareil vous invite de suivre d'importantes instructions d'utilisation et d'entretien dans la documentation livrée avec le produit.

Italiano  
**Importanti norme di sicurezza**

Conservare le presenti norme per l'utilizzo futuro.  
Osservare tutte le istruzioni e le avvertenze apposte sull'unità.  
Utilizzare esclusivamente con la tensione di rete corretta. Consultare le istruzioni operative fornite dal fabbricante per i dati riguardanti la tensione e l'assorbimento di corrente. Potrebbe essere necessario l'uso di cavi di rete e/o di spine diverse a seconda della tensione utilizzata.  
Non installare l'unità in uno scaffale privo di ventilazione oppure direttamente sopra una fonte di calore, come, ad esempio, un amplificatore. Non superare la temperatura ambientale massima di funzionamento riportata nei dati tecnici del prodotto.  
Le fessure e le altre aperture nella scatola servono alla ventilazione. Per un funzionamento affidabile, e per evitare un eventuale surriscaldamento, queste aperture non vanno ostruite o coperte in nessun modo. Evitare in tutti i casi di inserire oggetti di qualsiasi genere attraverso le fessure di ventilazione. Non versare mai del liquido di nessun tipo sull'unità.  
Evitare sempre di collegare le uscite dell'amplificatore audio direttamente ai connettori dell'unità.  
Per prevenire il pericolo di folgorazione e di incendio non esporre l'unità alla pioggia o ad un'umidità eccessiva; evitare di adoperare l'unità dove potrebbe entrare in contatto con acqua.  
Evitare di adoperare l'unità se la stessa è stata urtata violentemente, se ha subito un danno, se è stata esposta ad un liquido o in caso di un evidente cambiamento delle prestazioni che indichi la necessità di un intervento di assistenza tecnica.  
Ogni intervento sull'unità va eseguito esclusivamente da personale qualificato. La rimozione della copertura comporta l'esposizione al pericolo di folgorazione.



Il presente triangolo impresso sul componente avverte della presenza di tensioni pericolose non isolate all'interno della copertura... tali tensioni rappresentano un pericolo di folgorazione



Il presente triangolo impresso sul componente avverte l'utente della presenza nella documentazione allegata di importanti istruzioni relative al funzionamento ed alla manutenzione.

---

# Contents

## Introduction

### 1 Installation

Controls and Indicators .....	1
The Front Panel .....	1
The Rear Panel .....	2
The Remote Control .....	3
Alternate Remote Control Functions Using the Shift and Record/Zone 2 buttons .....	6
Conection .....	6
Location Considerations .....	6
AC Connections .....	6
Wiring Considerations .....	7
Audio/Video Cables • Speaker Connctions Audio/Video Connections .....	8
DC-2 Connections .....	8
Video Connections • Digital Audio Connections "AC-3 Ready" Laser Disc and LD/DVD Players .....	

### 2 System Configuration

Restore Factory Defaults .....	11
Equalization .....	11
Bass and Treble Level • Tilt • Loudness .....	
Display Adjustment .....	13
The Video On-Screen Display .....	
Input Configuration .....	15
Input Gain (Analog Inputs Only) • Input Level Meters Input Name • Input Effect "FX" Assignment .....	
FX Format .....	17
Automatic • PCM Only • AC-3 Only • DTS Only .....	
Audio In .....	20
Analog • Coax-1-5 and Optical-1-3 (Digital Audio Inputs) .....	
Video In .....	20
Record/Zone 2 .....	21
Record/Zone 2 Controls • PGM Trigger Assignment .....	
Speaker Configuration .....	23
Custom Configuration • THX Configuration Surround EX Configuration .....	
Setting Output Levels .....	25
Note on External Noise Calibration • Subwoofer Peak Limiter • Mute Level • Power On Volume Zone 2 Power On Volume .....	
Setting Listener Position .....	28
Speaker Distance • A/V Sync Delay • Calibrate Panorama • L/R Balance • Zone 2 Balance .....	
Customization .....	32
Locking Settings • Assign Custom Name .....	

---

Using DC-2 Effects .....	33
Restoring the original parameter values of an Effect	
Naming your custom Effect • Restoring the original	
Effect Name • Listening to only the DC-2 Effect	
Front/Back Fader	
<b>3 PCM Effects and Parameters</b>	
Panorama .....	35
Nightclub .....	35
Concert Hall .....	36
Church .....	36
Cathedral .....	36
Party .....	37
2-Channel .....	37
Music Surround .....	37
Music Logic .....	38
Logic 7 .....	38
TV Matrix .....	39
Pro Logic .....	39
THX Cinema .....	39
Mono Logic .....	40
PCM Effect Parameters .....	40
<b>4 AC-3 Effects and Parameters</b>	
AC-3 Status Display .....	45
5.1 2-Channel .....	46
5.1 Music .....	46
5.1 Logic 7 .....	47
Dolby Digital .....	47
THX 5.1 (Including Surround EX) .....	48
AC-3 Effect Parameters .....	48
<b>5 DTS Effects and Parameters</b>	
DTS 2-Channel .....	51
DTS Music .....	51
DTS Logic 7 .....	52
DTS Film .....	52
DTS THX (Including Surround EX) .....	53
DTS Effect Parameters .....	53
<b>6 Troubleshooting</b>	
Problems and Solutions .....	55
Routine Maintenance .....	57
Restoring Defaults .....	57
<b>7 Specifications</b>	
<b>Installation Worksheet</b>	

---

---

## Introduction

---

The DC-2 can be thought of as four units in one. At its heart is a reference-quality 8-channel music and film digital audio computer capable of creating or recreating a limitless amount of listening environments. This digital audio computer is mated to an 8-channel, 24-bit Digital-to-Analog converter that rivals the most exotic and costly stand-alone devices. To harness all of this digital audio power, the DC-2 also includes a built-in line-level preamplifier with 8 analog audio inputs and 8 digital audio inputs for easy integration with multiple source components. Since many of these source components are also capable of outputting high quality video signals, the DC-2 includes a high-quality composite and S-video switcher. The DC-2 also includes provisions for adding a digital output, and a second RS-232 port as well as three expansion ports for future enhancements. The back panel includes a bare wire block terminal for trigger outputs for easy connection to associated equipment.

The DC-2 is designed to satisfy the most rigorous demands, while retaining simplicity for casual use as well. Using the system can be as simple as pressing an input key and turning the volume up and down. Less-used functions are organized into a simple on-screen menu system and "hidden" buttons on the remote control. Controls are provided to accommodate virtually any system configuration and to allow for varying recording, mixing, and transmission styles, as well as for system control from a second zone, and for control by sophisticated automation systems.

Three versions of the DC-2 are available: THX, Dolby Digital, and DTS. The unit is internally-configurable so upgrades can be progressively added to include all the features of the DTS version.

All versions of the DC-2 include NIGHTCLUB, CONCERT HALL, CHURCH, and CATHEDRAL effects for creating an ideal custom listening environment as well as MUSIC LOGIC and MUSIC SURROUND which offer ambience extraction. As these programs use the same Lexicon technology used by the overwhelming majority of professionals for adding ambience to their recordings, you will find playback greatly enhanced by the DC-2, transporting you more deeply into the performance.

The DC-2 also recreates 5.1 channel soundtracks with stunning accuracy, and takes them to a new level of realism with Lexicon's proprietary Logic 7 technology. These effects allow you to expand 5.1 channel as well as two channel soundtracks for 7.1 and virtual 7.1 channel playback for an increased sense of spaciousness and envelopment.

The AC-3 and DTS versions of the DC-2 provide separate effects for listening to 5.1 channel music and down-mixing 5.1 channels to two channels, allowing you to fine-tune the DC-2 for listening to 5.1 channel music or music videos.

---

The DC-2 can be easily integrated with the various types of loudspeaker systems currently available, including those that are THX certified. By adhering to the rigorous THX Ultra specification, the DC-2 includes THX enhancements for optimizing playback of matrix-encoded film soundtracks as well as Surround EX for those recorded in the Dolby Digital and DTS discrete formats. These enhancements ensure that film soundtracks, which are typically mixed for the acoustics of large theaters, sound as the filmmakers intended when played back in the relatively small environment of a home theater.

### Using the Documentation

Because the DC-2 is designed to be customized for your system and your listening space, the information required for installation is extensive.

The Owner's Manual is designed to assist you in installing, calibrating and operating the DC-2. It should be used in conjunction with the remote control when configuring the system to perform optimally in your environment. This manual was written with the underlying assumption that the installer is familiar with audio/video system installation. An Installation Worksheet is provided at the end of this manual for documentation of the settings arrived at during the calibration procedure.

### Glossary of Terms

Although the DC-2 performs very complex signal processing, a great deal of effort has gone into making the technology behind the effects as transparent as possible to the user. To understand the overall organization of the unit, it is helpful to define those few terms which are unique to the DC-2.

**AC-3 FX** The term AC-3 FX (Dolby Digital Effects) is used to describe all of the effects which are compatible with Dolby Digital input signals. Any AC-3-capable software and/or source components should be labeled with a badge, similar to the one on the DC-2 front panel (AC-3 and DTS versions).

**DTS FX** The term DTS FX (Digital Surround Effects) is used to describe all of the effects which are compatible with DTS Digital Surround input signals. Any DTS-capable software and/or source components should be labeled with a badge, similar to the one on the DC-2 front panel (AC-3 and DTS versions).

**Downmix** describes the process of creating a two-channel output from a multichannel (>2) signal. Downmixing is necessary to maintain compatibility between multichannel formats and devices such as Dolby Digital and DTS, and two-channel formats and devices, such as stereo tape decks and VCRs.



---

**Effect** An *effect* is a configuration that determines how the DC-2 will process an input signal. The DC-2 can contain as many as 24 effects: *Panorama, Nightclub, Concert Hall, Church, Cathedral, Party, 2-Channel, Music Surround, Music Logic, Logic 7, TV Matrix, Pro Logic, THX Cinema, Mono Logic, 5.1 2-Channel, 5.1 Music, 5.1 Logic 7, Dolby Digital, THX 5.1, DTS 2-Channel, DTS Music, DTS Logic 7, DTS Film and DTS THX 5.1.*

**Parameter** Each Effect has a set of *parameters* (controls) that characterize it. Parameter settings can be changed to customize each Effect for your room and listening taste.

*Effect Parameter* values are stored / recalled with each Effect. Some examples are: Subwoofer Level and Vocal Enhance

*System parameter* values are not associated with a particular Effect and their values do not change when a new Effect is loaded. An example is: Speaker Configuration.

**PCM FX** The term PCM FX (Pulse Code Modulation Effects) is used to describe all of the effects which are compatible with two-channel input signals (analog or digital).

**Two-Channel** We use the term two-channel rather than "stereo" because a two-channel input can contain monaural, stereo or matrix-encoded stereo sound depending on how it was mixed.

## Controls and Indicators

### The Front Panel

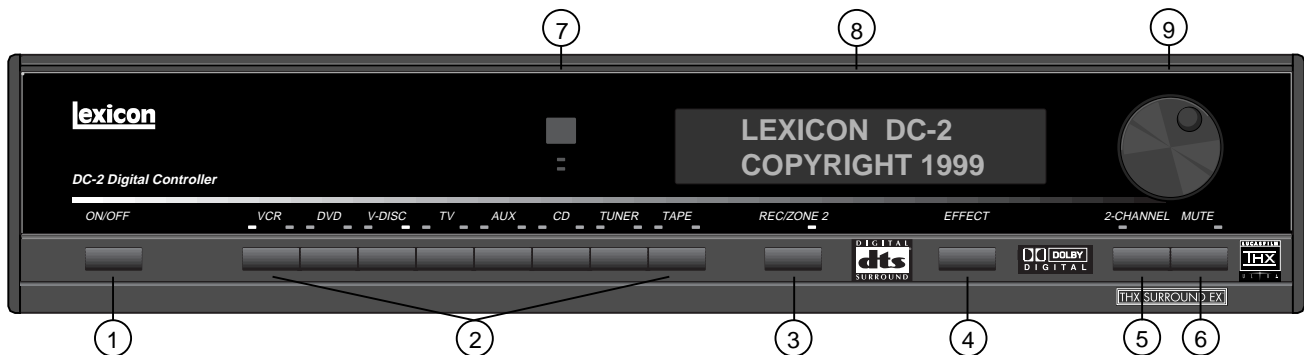

#### 1. ON/OFF

ON/OFF alternately puts the DC-2 into and out of standby. Turning the DC-2 off with this button (or with the remote) deactivates the unit while leaving power to the signal processing circuitry to keep it at optimum operating temperature. Turning the DC-2 on with this button (or the remote) will restore the previous operating state.

#### 2. Input Selection

Pressing any of these buttons (VCR, DVD, V-DISC, TV, AUX, CD, TUNER, TAPE) selects the input for the main zone, and lights a green LED.

#### 3. REC/ZONE 2

Press and hold to activate Zone 2 control with the On/Off, Input Selector, Volume and Mute buttons..

Some sources are blocked because of the potential for feedback loops. By default these are TAPE and VCR. If a blocked source is selected, a message is displayed. This source blocking can be changed in the INPUT CONFIG menu.

#### 4. EFFECT

Displays the current effect, then steps through the available effects.

#### 5. 2-CHANNEL

Engages the appropriate 2-Channel effect, and lights the amber front panel LED.

#### 6. MUTE

Attenuates the main audio outputs, lights a red LED, and displays a screen message to indicate mute is engaged. The attenuation level can be set in the Setup: Output Levels menu.

#### 7. IR Receiver and LED

The IR receiver has an associated activity LED that lights green when valid IR signals are received, and an LED that lights red to indicate clipping at the inputs. An IR input jack is available on the rear panel for receipt of hard-wired signals. The red LED remains illuminated when the unit is placed in standby.

#### 8. Display

A 2x20 backlit LCD displays the result of user action and the current status. This display can be turned off with the remote control.

#### 9. VOLUME

Provides volume adjustment of the main outputs. Screen displays show a volume bar and level in dB unless the front panel display is turned off with the remote control.

## The Rear Panel

**CAUTION:** Never make or break any connections to the DC-2 with the rear-panel power ON. Make sure any associated amplifiers are turned off before turning this master power switch on or off.

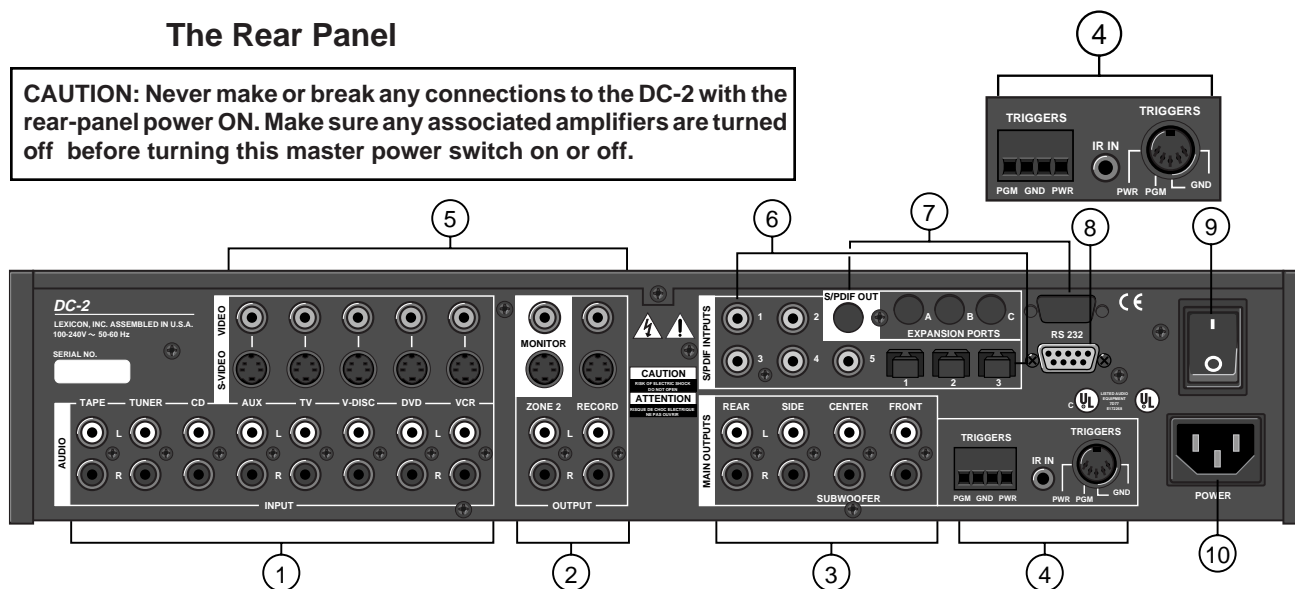

### 1 AUDIO INPUTS

Eight stereo analog audio inputs are switched with corresponding video inputs and fed to the Monitor outputs. Inputs are nominally labeled as originating from an audio tape player, tuner, CD player, an unspecified auxiliary source, a TV tuner, a Laser or Video Disc player, a DVD player, and a VCR.

### 2 ZONE2 and RECORD

Each pair of stereo audio outputs supplies the same signal according to the Record/Zone 2 input selection. Zone 2 output levels can be controlled independently for use with amplifiers and speakers in another room. Record can be expanded to two outputs using standard Y-connectors. Both outputs are muted in Standby.

### 3 MAIN OUTPUTS

Three stereo amplifier outputs are provided for front, side and rear speakers. Single monaural outputs are provided for the center speaker and the subwoofer. The audio outputs are muted in Standby.

### 4 IR Input, PWR and PGM TRIGGERS

The IR input is an 1/8" mono phone jack connector for input of IR data from any industry-standard IR source. Data is retransmitted by an IR LED mounted near the front panel IR receiver.

Two trigger outputs are provided on 4-pin removable screw terminals, and a 5-pin DIN connector, as shown in the expanded illustration above. The PWR trigger is high when the DC-2 is on, low in standby or when the unit is off. The PGM trigger can be enabled (high) or disabled (low) for specific input selections in the Input Configuration menu. High is indicated by either +12VDC or +5VDC, selectable via an internal jumper. (Factory configuration is +12V.)

### 5 VIDEO INPUTS and OUTPUTS

Five video input sources are provided. Video inputs are selected based on selections made in the INPUT CONFIG menu and fed to the selected monitor output jack. Record output jacks can be selected independently.

RCA (composite) and S-video connectors are provided for monitor and record. If an S-video input is used, both S-video and composite are available at each output. If the video input is composite, only composite is available at each output. The monitor output incorporates the on-screen video overlay. Unless RECORD is enabled, the record output follows the monitor output selection without the on-screen display feature. Both outputs are off in Standby.

### 6 S/PDIF INPUTS

Five coaxial RCA connectors and three optical connectors are provided for digital audio inputs.

### 7 EXPANSION PORTS

Reserved for future upgrades.

### 8 RS 232

Serial port connector for automation and control systems.

### 9 Power On/Off

Master power switch disconnects the AC Mains. This switch is intended to be left On during regular use. Whenever cables are connected or disconnected, or when the unit is not going to be used for an extended period of time, this switch should be set to Off.

### 10 POWER

AC power connector: 3-wire, 10 Amp, IEC 320.

## The Remote Control

### 1 ON, FP and OSD

ON turns the DC-2 on and selects the input last used with main and Zone 2 volume levels set to the levels chosen in the OUTPUT LEVELS menu.

FP (ON) turns on the front panel display backlight and the Lexicon logo.

OSD (ON) activates the DC-2 on-screen display.

### 2 OFF, FP and OSD

OFF puts the unit into standby and mutes all of the outputs. OSD (OFF) turns off the on-screen display.

FP (OFF) turns off the front panel display backlight and the Lexicon logo.

### 3 SELECT, ▲, ▼ and DONE

Allow access to and adjustment of all displayed menu items. ▲ and ▼ step a display cursor through listed menu items. SELECT displays submenus, or chooses a menu item for adjustment. The ▲ and ▼ buttons alter the settings of selected parameters. DONE saves the current changes and exits the menu.

### 4 Shift

When pushed in conjunction with other remote buttons, activates a set of less-used, but convenient, functions.

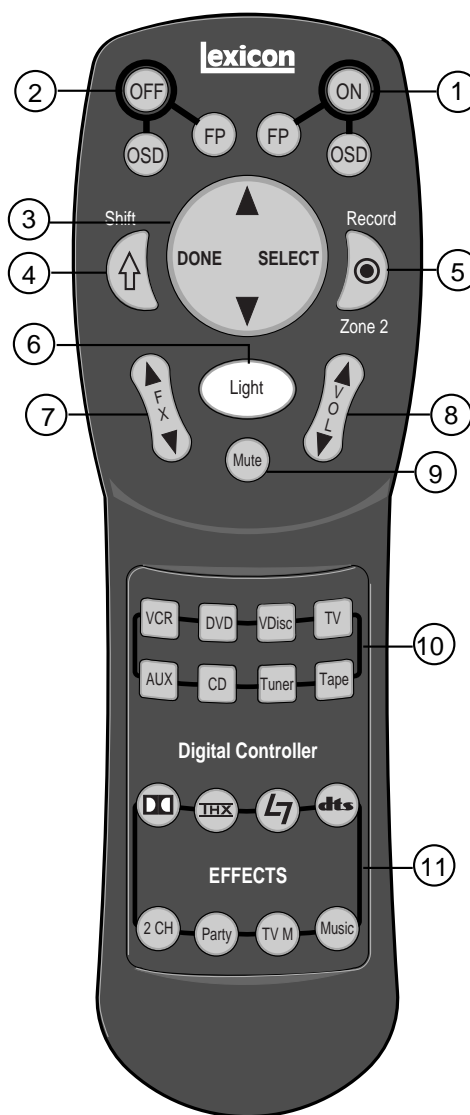

### 5 Record/Zone 2

When pushed in conjunction with other remote buttons, activates a set of Record/Zone 2 control functions.

### 6 Light

Toggles the remote control backlight on and off. (Note: after seven seconds, the backlight is automatically turned off.)

### 7 FX ▲ and ▼

These controls display, then change the current effect. The activated displays (FP or OSD) will show the effect name.

### 8 VOL ▲ and ▼

These controls display, then adjust the current master volume level. The activated displays (FP or OSD) will show the volume level and a visual gauge.

When Mute is engaged, these controls display, then adjust the volume from the mute level. When full mute is engaged (↑Mute), these controls increase or decrease the selected volume level without disengaging full mute.

### 9 Mute

Engages Mute and reduces the volume by the amount selected in the OUTPUT LEVELS menu. The red Mute LED on the front panel will light and the activated displays (FP or OSD) will show MUTE ON. Pressing again restores the volume to its pre-Mute level, turns off the front panel Mute LED, and displays MUTE OFF on the active displays.

### 10 Input Selection

Individual buttons select from 8 inputs and activate a corresponding green LED on the front panel. Depending on the Setup configuration, selection may also load a new effect.

### 11 EFFECTS

These controls select Dolby, THX, Logic 7, dts, 2-Channel, Party, TV Matrix or Music playback. The actual effect is determined by the format of the input signal.

Note: When 2-Channel is engaged, pressing the button again will turn it off.

**Alternate Remote Control Functions Using the Shift and Record/Zone 2 buttons**

You can access an additional set of controls with the DC-2 remote control by using the Shift key.

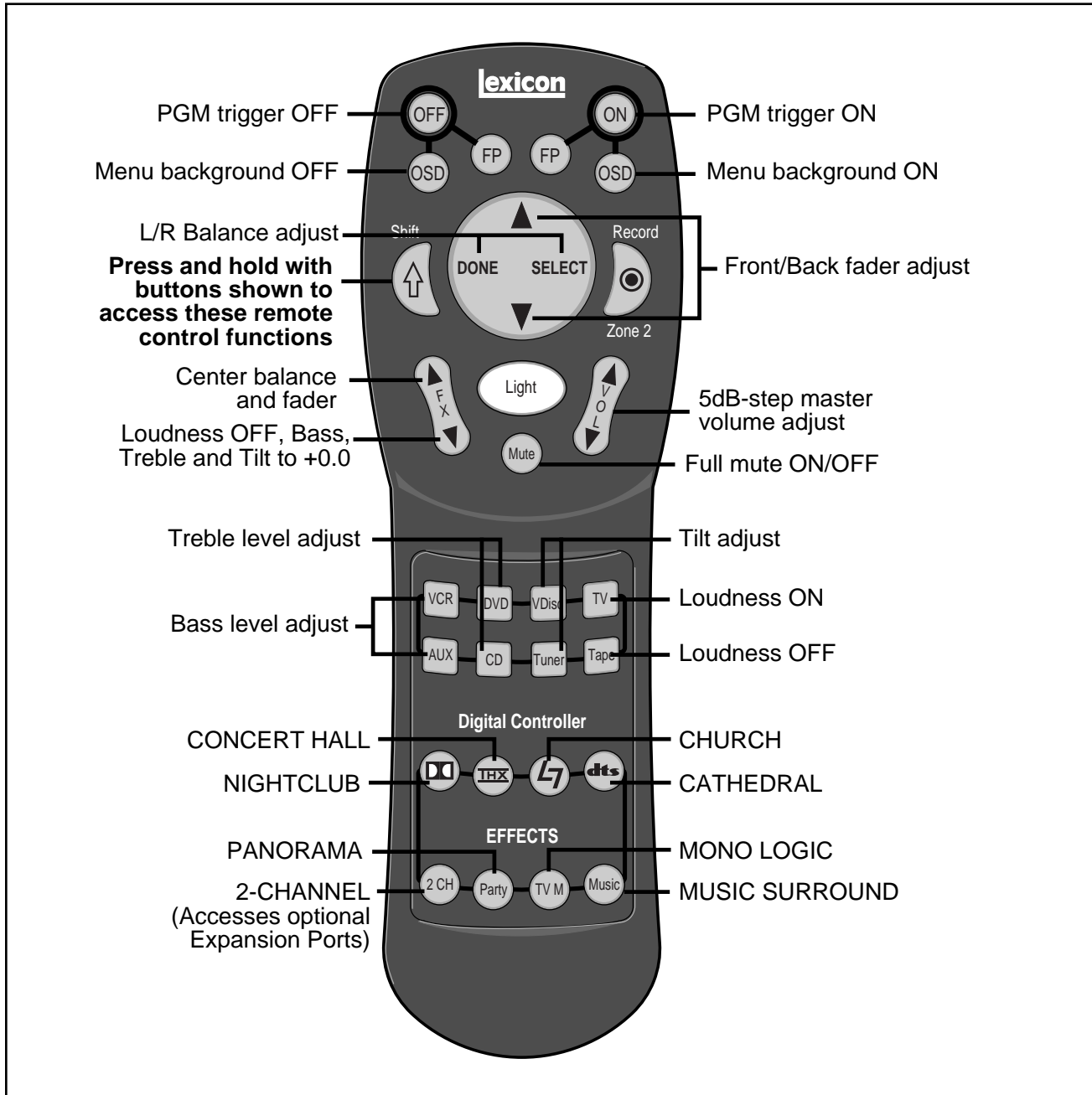

Zone 2 controls are accessed by holding down the **Record/Zone 2** button.

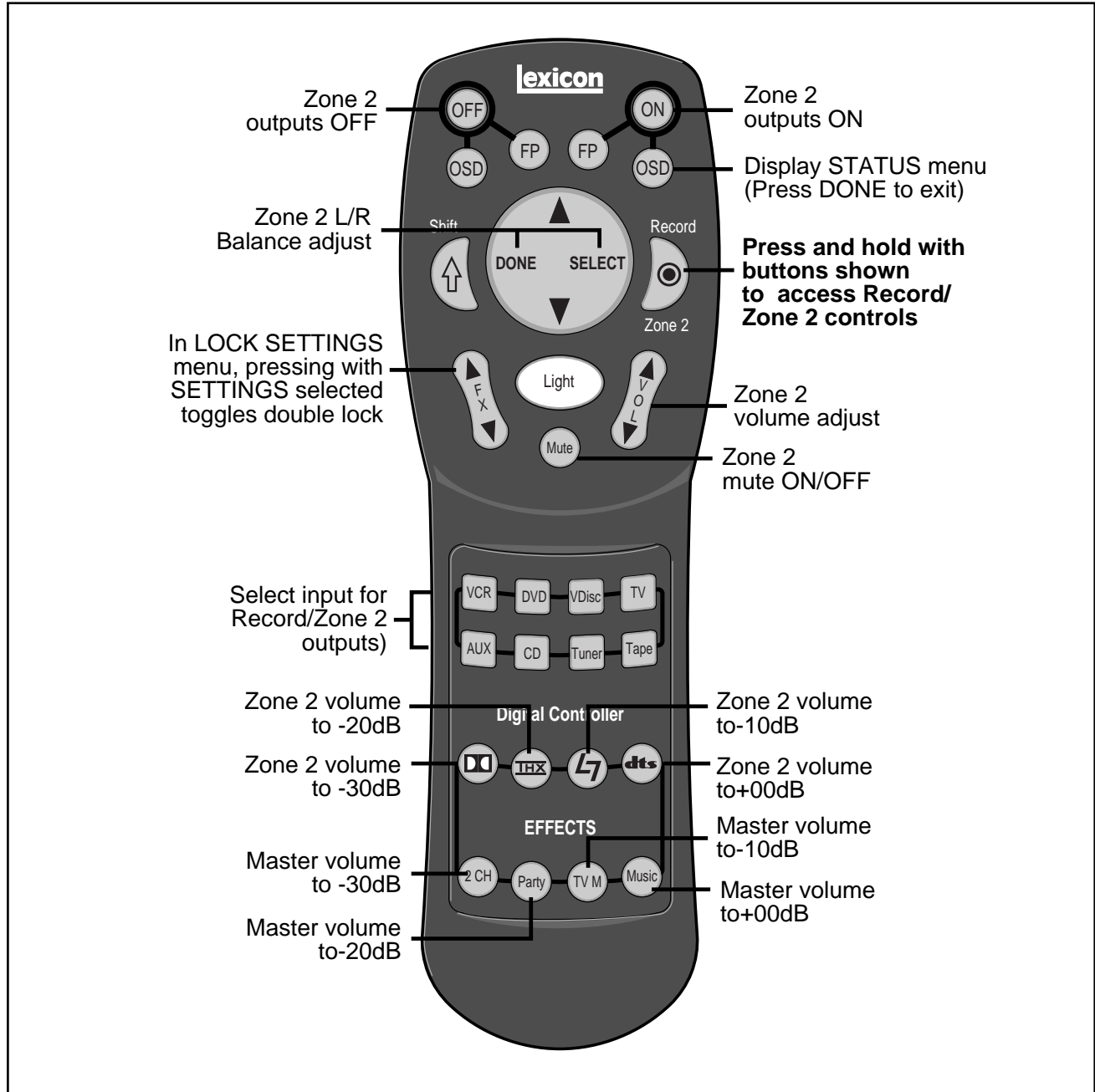

---

## Connection

---

### Location Considerations

The DC-2 is a highly specialized signal processing computer and requires special care during installation to ensure optimum performance.

The DC-2 may be installed on a shelf or in a standard 19" equipment rack, using an optional rack-mount kit available from Lexicon dealers. Observe the following precautions:

- Select a dry, well-ventilated location out of direct sunlight.
- Do not stack the DC-2 directly above heat-producing equipment such as power amplifiers.
- Avoid placing the DC-2 near unshielded TV or FM antennas, cable TV decoders, or other receivers. The DC-2 may interfere with some FM tuners if it is placed immediately above or below them. Some products, particularly power amplifiers, may cause hum if they are in close proximity.
- Make sure the DC-2 front panel IR receiver window is unobstructed. The remote control must be in line-of-sight to this receiver for proper operation. If line-of-sight is impractical, an infrared remote repeater can be used with the rear panel IR connector. The DC-2 may be placed in a glass-doored cabinet but smoked glass will make the front panel Liquid Crystal Display (LCD) difficult to read and will reduce the sensitivity of the IR receiver.

### AC Connections

The DC-2 is designed to be connected to an uninterrupted AC power line in the same manner as a VCR or a television. We recommend the use of an AC line filter to protect against line surges, or the installation of a line conditioner to protect against under voltage (brownouts) as well as overvoltage conditions.

The DC-2 has a master power switch on the rear panel above the IEC standard AC power receptacle. This switch may be left ON continuously when the unit is in regular use. When the DC-2 will not be used for an extended period of time, or whenever you are connecting or disconnecting any cables to the unit, this switch should be turned OFF.

Connect the power cable to the DC-2, then plug the power cord into a wall outlet or into an unswitched outlet on a surge protector. Be sure that the power cord is firmly seated in the connector on the rear panel of the DC-2.

There is debate over the audible effects of different types of interconnects. Good engineering practices have minimized the effect that cables might have on the inputs and outputs of the DC-2 — but feel free to evaluate different interconnects in your system. Be conscious, however, of the mechanical stress from repeated insertion and overly tight connectors, and the possibly corrosive nature of some contact-enhancing fluids.

Note that the use of standard audio cables for video or digital audio applications may cause signal degradation, and is not recommended. For these connections, please use only cables that are designed for the application — these have different impedance characteristics than cables designed for analog audio applications. Consult your dealer for recommendations.

All cables should be kept as short as possible.

In general, speaker cables should be kept short, and low-impedance wire should be used throughout to assure efficient power transmission and avoid audible distortion. Recommended wire lengths are given in the table below. Although these examples can be used as a general guide, your system manuals should provide detailed information specific to your components.

Wire Lengths	
Length	AWG Size
up to 12 feet	16 gauge
up to 18 feet	14 gauge
up to 29 feet	12 gauge
up to 51 feet	10 gauge

Before making any connections, turn off ALL audio and video components, including individual power amplifiers. (Unplug any preamps and power amps that don't have power switches.)

The DC-2 is designed to function as the control center of the system, selecting inputs and controlling the volume of all speakers in the system. The following diagram shows a system with a tape deck, an AM/FM tuner, a CD player with a coaxial digital audio output, a satellite receiver with an optical digital output, a DVD player and a VHS VCR. This example shows the tape deck and VCR set up for recording and dual-zone audio.

Actual system connections will vary widely depending on the components used. Consult your dealer for details on your particular requirements.

## Wiring Considerations

### Audio/Video Cables

### Speaker Connections

### Audio/Video Connections



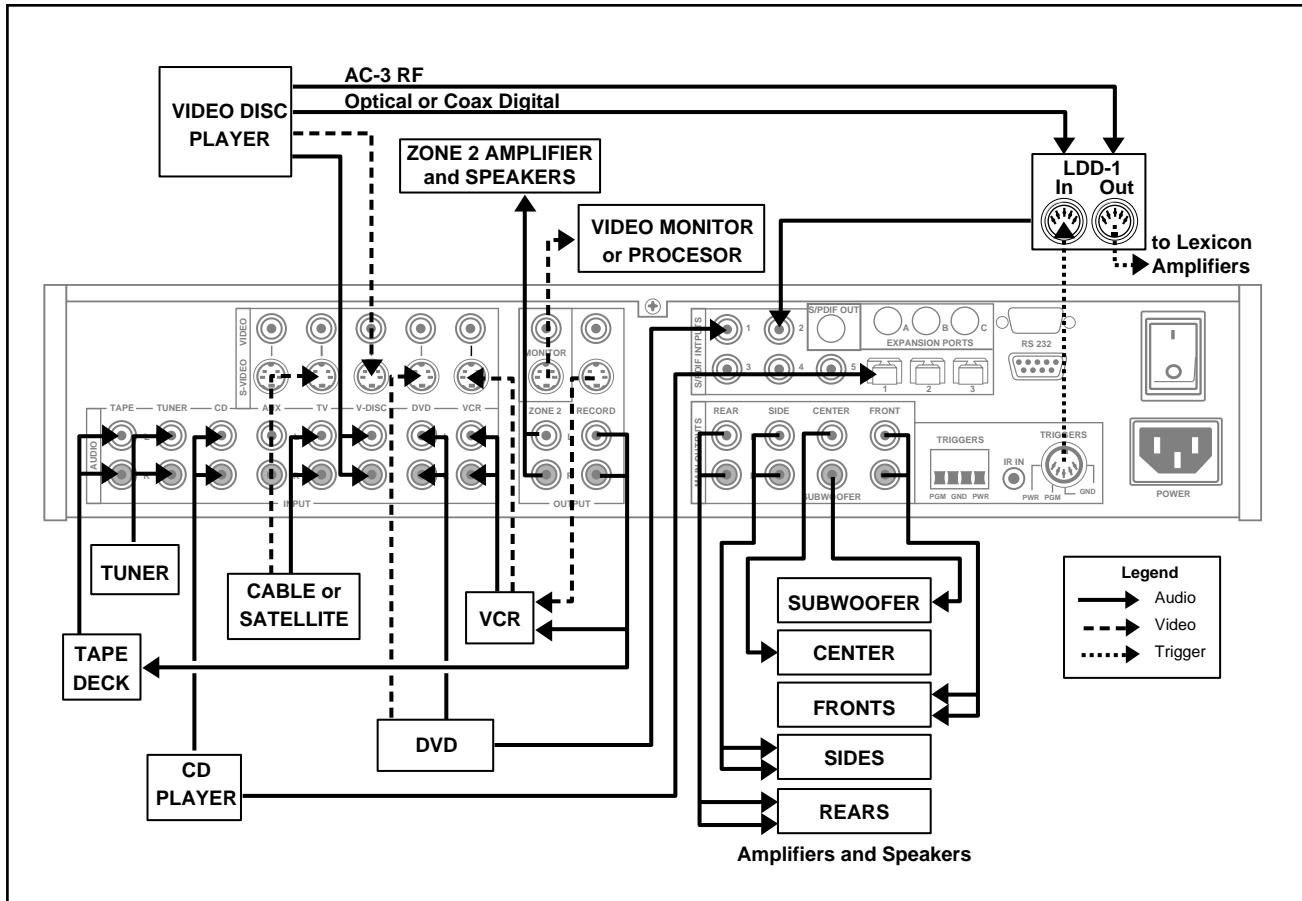

**DC-2 Connections**

Input sources should be connected directly to the DC-2 inputs. Since TAPE, TUNER and CD are audio only, the video output will default to the video signal from VCR. This allows TV or other video source viewing while different audio is playing, but can be changed in the INPUT CONFIG menu.

Connect your main stereo amplifier to the DC-2 FRONT outputs. Connect any additional amplifiers to the remaining outputs on the DC-2: side amplifiers to the SIDE outputs, rear amplifiers to the REAR outputs, center-channel amplifier to the CENTER output and the subwoofer amp to the SUBWOOFER output. If you are using THX-type di-pole surround speakers, the amplifier driving them should be connected to the DC-2 SIDE outputs.

Whenever possible, connect both analog and digital outputs of digital sources. This enables use of a digital input for the main zone, and the corresponding analog input for the Record/Zone 2 outputs.

Note the use of Y-connectors to feed the DC-2 Record output to both the VCR and the tape deck.

The DC-2 has five composite and S-Video inputs. Connection to an S-Video input will override the composite signal connected via the RCA-type connector. Note that an S-Video input will be output on both the composite and S-Video outputs. Composite input signals will *not* be output as S-Video.

You can assign any video source to any (or all) of the eight DC-2 inputs via the Input Configuration submenu of the Setup menu. This can be very useful in systems which use a VCR as the tuner for TV viewing, as the video feed from the VCR can be assigned to both the VCR and TV inputs. The VCR's audio signals can be fed to both inputs with Y-connectors. (Do not use Y-connectors on video signals.) This allows the audio and video signals from the VCR to be used for both TV and VCR viewing.

You can also assign any video source to audio-only sources such as an AM/FM tuner, to enjoy music from another source while viewing a video source.

It is important to remember that the impedance characteristics of composite video and digital audio are different from analog audio. You should only use cables specifically designed for video and digital audio. Consult your dealer for recommendations.

The DC-2 has eight digital audio inputs: five coax via RCA and three optical via TOSLINK™. The digital inputs can be set up to be selected with any (or all) of the eight inputs via the Input Configuration menu. Using the digital inputs will always provide superior performance.

Note that "AC-3 ready" laser disc and LD/DVD players output Dolby Digital (AC-3) data from laser discs on a separate RCA jack in Radio Frequency (RF) form. To maintain the exceptional performance of the DC-2, an outboard demodulator is required to turn this RF signal back into a digital bitstream. By performing the necessary demodulation outside the DC-2, the potential for RF interference is eliminated. The Lexicon LDD-1 is an excellent example of one such device.

## Video Connections

## Digital Audio Connections

### "AC-3 Ready" Laser Disc and LD/DVD Players

## Restore Factory Defaults

Although the DC-2 memory is cleared before it leaves the factory, it is good practice to restore the factory defaults with the following procedure before system configuration.

Turn the DC-2 OFF with the remote control. Turn the unit back ON and immediately press and hold the MUTE button on the remote. (Make sure you do not block the infrared receiver on the DC-2 front panel.) The display will read:



Press ▼ to highlight RESTORE DEFAULTS, then press SELECT. This will clear and reload all preset effects and all factory settings of Volume, Balance, Contrast, Configuration, etc. When the message FACTORY DEFAULTS RESTORED is displayed, press DONE to return to normal operation.

In the main menu, press SELECT to open the Equalization menu which contains Bass, Treble and Tilt controls, and a Loudness parameter.

EQUALIZATION MENU		Adjust with ▲ or ▼
BASS LEVEL	+0.0dB	-6.0 to +6.0dB
TREBLE LEVEL	+0.0dB	-6.0 to +6.0dB
TILT	+0.0dB	-3.0dB to +3.0dB
LOUDNESS	ON	ON, OFF

Bass and Treble level controls are provided to compensate for inconsistencies in source material, rather than variations in room conditions. The BASS LEVEL control allows a boost or cut of as much as 6dB below 250Hz. The TREBLE LEVEL control allows a boost or cut of 6dB above 1.5kHz. To select either control for adjustment, use ▲ or ▼ to select the control, press SELECT, and use ▲ or ▼ to adjust the setting.

These controls do not affect the sound of rear or side speakers.

## Equalization

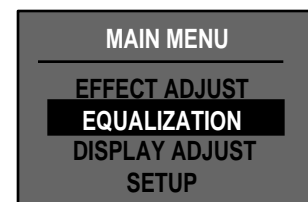

### Bass and Treble Level

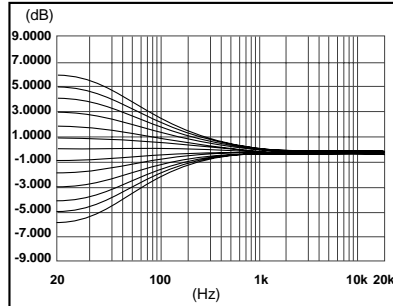

*Bass Tone Control Frequency Response*

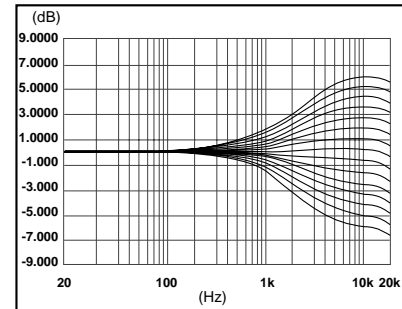

*Treble Tone Control Frequency Response*

### Tilt

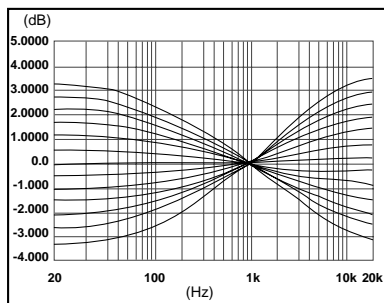

*Tilt Control Frequency Response*

The Tilt parameter can be thought of as a straight line that pivots on a fulcrum at 1kHz to correct the overall tonal balance of source material. The range is -3.0dB to +3.0dB, referenced to the Treble level. This control, adjustable in 0.2dB increments, is useful on many older recordings, or when the desired tonal balance cannot be achieved at the listening position. The Tilt control does not alter the tonal balance of the rear or side speakers.

### Loudness

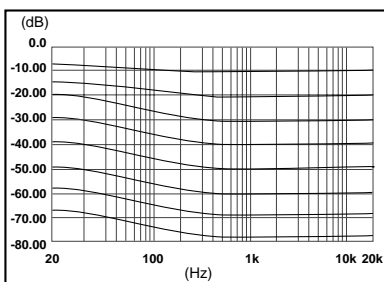

*Loudness vs DC-2 Volume control (front left)*

A Loudness Contour parameter which boosts bass information, provides more balanced reproduction at low volume listening conditions. Once you have calibrated DC-2 output levels, set the LOUDNESS parameter ON to provide the ideal amount of boost for any given volume setting. This parameter does not affect the sound of the rear or side speakers.

Depending on the location of the DC-2 in your room, you may need to adjust the contrast of the front panel display for optimum viewing. To adjust this display, press the ▲, ▼ or SELECT buttons on the Remote to enter the Main Menu. Press ▼ twice to select DISPLAY ADJUST.

Press SELECT to highlight the Display Adjust Menu. Press ▼ to select FRONT PANEL DISPLAY.

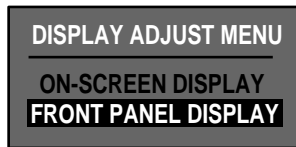

To adjust contrast, use SELECT to highlight CONTRAST ADJUSTMENT, and ▲ or ▼ to set the contrast of the display to its maximum as seen from your listening position. Press DONE twice to return to the main menu.

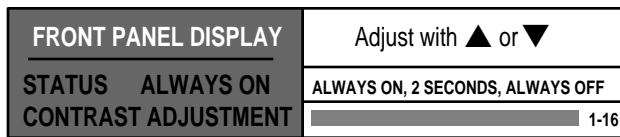

If you want to turn the front panel display off, use SELECT to highlight STATUS, then use ▲ or ▼ to select ALWAYS OFF. With software Version 4, you can select 2 SECONDS which will cause the display to shut off automatically two seconds after a command is received.

Press DONE twice to return to the main menu.

In addition to the front-panel display, the DC-2 contains a character generator for a video overlay display on monitors. Since the on-screen display is capable of showing the full menu of options available at any point, calibration of the system is faster and easier if the DC-2-video output is connected to a video monitor.

Adjustments to the on-screen display are made from the Display Adjust menu. To display this menu, press the ▲, ▼ or SELECT buttons on the Remote to enter the Main Menu. Press ▼ twice to select DISPLAY ADJUST.

Press SELECT to enter the Display Adjust menu. Press SELECT to open the On-Screen Display menu.

## Display Adjustment

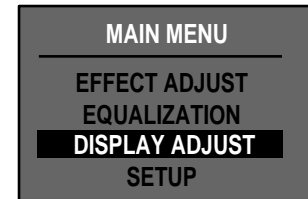

## The Video On-Screen Display

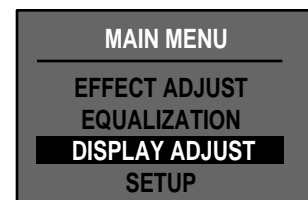

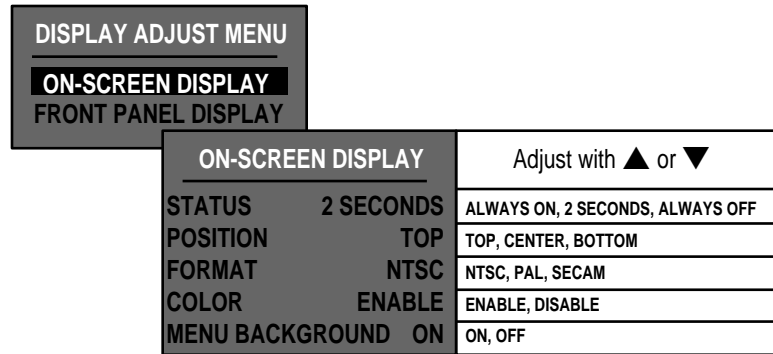

This menu allows you to choose the position and duration of items displayed on-screen during normal operation, as well as the options of color or black and white display and conformance to local video format.

Adjusting the position allows you to move the DC-2 display items to a location where they will not interfere with any other video overlays or signals your system may generate.

The STATUS option allows you to choose to have the on-screen display always off, always on, or on for a two-second duration. Note that if you choose to have the display "time out", this will not affect the display of the main menu. Note also that parameter changes will still be performed when you make adjustments with ▲ or ▼, even if the display is inactive. If you choose ALWAYS OFF, you will not be able to use the video overlay, and even setup will have to be done using the front-panel display.

COLOR allows you to have the on-screen display presented in monochrome or color. FORMAT allows you to select NTSC, PAL or SECAM formats. (Note that SECAM format is available only in monochrome).

MENU BACKGROUND allows you to have on-screen controls displayed on a solid color background (ON) or directly superimposed on your video image (OFF).

Press DONE twice to return to the main menu.

**Video Input Selection and the On-Screen Display**

When using the Video Monitor output with the On-Screen Display, the DC-2 automatically puts up a blue or grey background when no video signal is present.

Occasionally, an incoming video signal may be so weak that it is recognized as essentially no signal, triggering the background overlay. If this occurs, reselect the input to view the weak signal.

The DC-2 has eight inputs, each of which can be associated with any of the five video and eight digital audio inputs. Selecting Input Configuration from the Setup menu displays a sub-menu which lists these inputs and allows you to select them individually for adjustment. Each input has an identical parameter sub-menu. V-DISC is shown below as an example.

INPUT CONFIG	V-DISC	Adjust with ▲ or ▼
GAIN	OFF	AUTO On/Off or MANUAL -18 to +12dB
NAME	V-DISC	RESTORE DEFAULT or EDIT NAME
PCM FX	LOGIC 7	USE LAST EFFECT or any PCM Effect
AC-3 FX	5.1 LOGIC 7	USE LAST EFFECT or any AC-3 Effect
DTS FX	DTS LOGIC 7	USE LAST EFFECT or any DTS Effect
FX FORMAT	AUTOMATIC	AUTO, PCM ONLY, AC-3 ONLY, DTS ONLY
AUDIO IN	COAX-2	Sources: ANALOG, COAX 1-2, OPTICAL 1-2
VIDEO IN	V-DISC	Sources: NONE, VCR, DVD, V-DISC, TV, AUX
REC/ZONE2	ANALOG	Rec/Zone 2 Output: ANALOG, DIGITAL, BLOCKED
TRIGGER	ENABLE	PGM Trigger Output: ENABLE/DISABLE

## Input Configuration

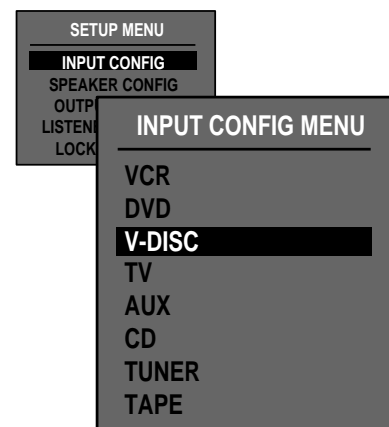

For optimal performance when using analog inputs, the unit must be driven to its full input level without clipping. Despite industry attempts at standardization, different analog sources have a wide range of output levels. To compensate for this, each of the eight DC-2 analog inputs can be assigned a different input gain, assuring optimum performance regardless of the source. For use with a calibration tone, the Dolby reference point is indicated by an enlarged tick mark on the Input Level meters.

The DC-2 GAIN function can be set to AUTOMATIC to monitor the analog input level and automatically optimizes the input gain. If the signal level is too high, input gain is automatically decreased to a point which does not cause clipping. When the signal level remains low (>12dB below clipping for 2.5 minutes), the input gain is increased in 1dB steps to maximize dynamic range.

When MANUAL is selected, the display shows the last auto level setting. (If the auto level feature has not been used, the display shows the last manually entered level.) The auto level setting indicates the optimum input level value as determined by the unit. The ▲ and ▼ buttons increase or decrease the input gain in 1dB increments for the selected input over a range of -18dB to +12 dB. The setting is displayed in dB along with horizontal bargraph meters on the on-screen display to indicate incoming signal level.

Note that if a level is set manually, then AUTOMATIC is engaged, the level will not go above the last value entered manually.

## Input Gain (Analog Inputs Only)

The GAIN control is only available for analog inputs. Whenever a digital input is selected under **AUDIO IN**, this control is automatically set to OFF.

### Input Level Meters

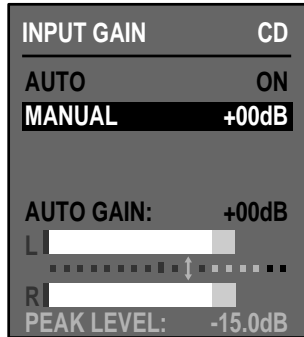

The input level meters are displayed when you select the GAIN parameter for an active input which has been selected in the Setup menu.

When GAIN is selected, two on-screen horizontal bar meters display peak incoming signal level. The highest peak level is shown in dB in a separate text line, and as an arrow in the the meter display. White, yellow and red sections of the bar meter show increasing levels. The white portion is shown in 3dB increments, the yellow and red portions are shown in 1.5dB increments. An enlarged block at -21dB indicates the reference level used with a Dolby calibration tone source.

The peak level display can be refreshed by pressing DONE to exit, then pressing SELECT to return to the display.

### Input Name

Each input has an associated name which is displayed during normal operation whenever the input is selected. The default names correspond to the labels on the DC-2 remote control and the front and rear panels. These names can be customized to more accurately reflect your system configuration.

To assign a new name (up to 8 characters) for an input, select NAME from the Input Configuration menu, and EDIT INPUT NAME from the sub-menu. The display will show the current name with a cursor marking the character position to be modified. Use the ▲ and ▼ buttons to select a new character for that position, and SELECT to move the cursor to another position. Press DONE twice to return to the Input Configuration menu.

### Restore Input Name

This control allows you to restore the factory name for the currently selected input. Pressing SELECT displays the message PRESS SELECT TO RESTORE INPUT NAME. Pressing SELECT again restores the name and exits to the Input Configuration menu.

### Input Effect "FX" Assignment

The DC-2 has the ability to automatically load an effect whenever an input is chosen. For example, if you primarily listen to CD's with the CONCERT HALL effect, the DC-2 can be set to load this effect when the CD input is chosen. (You can listen to any similar type of effect using the EFFECT button on the front panel or FX button on the remote control.) If you select USE LAST, the DC-2 will load the last effect used for the selected input. Any effect can be assigned to any or all of the eight inputs.



The DC-2 can also be set up to automatically switch to an appropriate effect whenever PCM, AC-3 or DTS encoded material is detected at the input. This allows one input to be used for different formats. For example, in the factory default state, the V-DISC input will automatically load the appropriate version of Logic 7 when an AC-3, DTS, or PCM signal is present. The default selections for input effect assignment are shown below. More information is provided in the following **FX Format** section.

Input	PCM Effect	AC-3 Effect	DTS Effect
VCR	LOGIC 7	5.1 LOGIC 7	DTS LOGIC 7
DVD	LOGIC 7	5.1 LOGIC 7	DTS LOGIC 7
V-DISC	LOGIC 7	5.1 LOGIC 7	DTS LOGIC 7
TV	TV MATRIX	5.1 LOGIC 7	DTS LOGIC 7
AUX	LOGIC 7	5.1 LOGIC 7	DTS LOGIC 7
CD	MUSIC LOGIC	5.1 MUSIC	DTS MUSIC
TUNER	MUSIC LOGIC	5.1 MUSIC	DTS MUSIC
TAPE	MUSIC LOGIC	5.1 MUSIC	DTS MUSIC

The FX FORMAT parameter in the Input Configuration menu allows the DC-2's format switching option to be individually adjusted for each input. Many "multi-format" source components, such as laser disc players, are capable of outputting different signals depending on the software being used. The DC-2 automatically identifies the format of incoming audio signals, and selects an appropriate effect. The four selections available for FX FORMAT on each input are: AUTOMATIC, PCM ONLY, AC-3 ONLY and DTS ONLY. Each of these selections is described below.

## FX Format

When AUTOMATIC is selected, the DC-2 automatically identifies the format of the incoming signal and selects an appropriate effect. Effects can be chosen for each individual input and for each format in the INPUT CONFIG menu. To illustrate how AUTOMATIC would operate with a laser disc player used in conjunction with the Lexicon LDD-1 AC-3/RF Demodulator. This example assumes the V-DISC input has the factory preset configuration shown below, and that the LDD-1 is connected to COAX 2 on the DC-2.

## Automatic

INPUT CONFIG MENU	INPUT CONFIG	V-DISC
VCR	GAIN	OFF
DVD	NAME	V-DISC
V-DISC	PCM FX	LOGIC 7
TV	AC-3 FX	5.1 LOGIC 7
AUX	DTS FX	DTS LOGIC 7
CD	FX FORMAT	AUTO
TUNER	AUDIO IN	COAX-2
TAPE	VIDEO IN	V-DISC
	REC/ZONE2	ANALOG
	TRIGGER	ENABLE

NOTE: When AUTOMATIC is selected for an input, and DTS software is being used, there may be a brief burst of noise before playback begins. This is inherent in DTS software and does not represent a problem with your DC-2. To avoid this, set up an input as DTS only, and use it exclusively for playback of DTS software.

The DC-2 V-DISC input is selected. A movie encoded in Dolby Surround is put in the laser disc player and starts to play. The LDD-1 recognizes that the movie is *not* AC-3 encoded, and automatically routes the laser disc player's PCM (2-channel digital) signal to the DC-2. The DC-2 identifies the signal as PCM and automatically loads the LOGIC 7 effect (as specified in the INPUT CONFIG menu).

Now, assume the movie is replaced with one that is encoded in Dolby Digital (AC-3). When it begins to play, the LDD-1 recognizes the signal as being AC-3 encoded and demodulates it for the DC-2. The DC-2 automatically loads the 5.1 Logic 7 effect.

The FX ▲ and ▼ buttons are used to audition the other available AC-3 effects and DOLBY DIGITAL is selected. At some point during the movie, the PAUSE button on the laser disc player is pressed. This causes the laser disc player to temporarily replace the AC-3 output signal with a PCM signal. This change is recognized by the DC-2, which automatically loads the Logic 7 effect (because in this example, AUTOMATIC is selected as the setting of FX FORMAT and LOGIC 7 is selected as the PCM FX in the INPUT CONFIG menu). Because the laser disc is paused, there is no audio. When PAUSE is released, playback is resumed and the DC-2 automatically reselects the DOLBY DIGITAL effect because it was the last effect selected before the audio was paused. To go back to the default effect, simply press the input button.

Now, the movie is replaced with a 5" music disc that is encoded in DTS. When the disc begins to play, the LDD-1 recognizes that it is *not* AC-3 encoded, and automatically routes the signal to the DC-2. The DC-2 recognizes the DTS signal and automatically loads the DTS LOGIC 7 effect\*. The FX ▲ and ▼ buttons are used to audition the other available DTS effects and DTS MUSIC is selected. At some point, the skip button on the laser disc player is pressed several times to advance to a different track. This causes the laser disc player to temporarily replace the DTS output signal with a PCM signal while it searches for the selected track. This change is recognized by the DC-2, which automatically loads the Logic 7 effect (because in this example, AUTOMATIC is selected as the setting of FX FORMAT and Logic 7 is selected as the PCM FX in the INPUT CONFIG menu). Because the disc player is searching, there is no audio. When playback is resumed, the DC-2 automatically reselects the DTS MUSIC effect. To go back to the effect selected as a default, simply press the input button.

---

\* As the DC-2 is in AUTOMATIC mode, there may be a brief burst of noise before normal playback begins.

If PCM ONLY is selected as the FX FORMAT for a given input, only PCM effects in the DC-2 can be used. When the DC-2 receives a signal which is *not* PCM encoded, it will mute and display "NO PCM AUDIO."

In the previous example, if PCM ONLY had been selected, rather than AUTOMATIC, the DC-2 would have muted and displayed "NO PCM AUDIO" when the AC-3 movie and the DTS music disc were being played.

When AC-3 ONLY is selected as the FX FORMAT, only AC-3 effects can be used on that input. Any other type of signal received on that input will cause the DC-2 to mute and display "NO AC-3 AUDIO." The FX ▲ and ▼ buttons will select only AC-3 effects. This is recommended for any input which will be used only for AC-3 playback.

In our example, selecting AC-3 as the FX Format setting, would have caused the DC-2 to mute and display "NO AC-3 AUDIO" when the Dolby Surround movie and the DTS music disc were played. When the laser disc was paused, the DC-2 would have muted rather than automatically selecting the PCM effect Logic 7.

When DTS ONLY is selected as the FX FORMAT, only DTS effects can be used on that input. Any other type of signal received on that input will cause the DC-2 to mute and display "NO DTS AUDIO." The FX ▲ and ▼ buttons will select only DTS effects.

In our example, selecting DTS as the FX Format setting, would have caused the DC-2 to mute and display "NO DTS AUDIO" when the Dolby Surround and AC-3 movies were played. When the DTS music disc was advanced, the DC-2 would have muted briefly rather than automatically selecting the PCM effect Logic 7.

### PCM Only

NOTE: PCM ONLY is automatically selected for an input whenever ANALOG is selected as the AUDIO IN setting, as AC-3 and DTS effects are incompatible with analog inputs.

### AC-3 Only

NOTE: As AC-3 is a digital format, you *must* have a digital input selected for AUDIO IN in the INPUT CONFIG menu.

### DTS Only

NOTE: As DTS is a digital format, you *must* have a digital input selected for AUDIO IN in the INPUT CONFIG menu.

---

## Audio In

This option in the INPUT CONFIG menu determines which audio input connector on the DC-2 rear panel will be used for the MAIN zone. Using the digital inputs will always yield better performance, and these should be used whenever a source component has a digital audio output. The options available for AUDIO IN are: ANALOG, COAX (1-5) and OPTICAL (1-3).

### Analog

When ANALOG is selected for a given input, the DC-2 will use the *corresponding* analog stereo audio input to generate the MAIN OUTPUTS. Note that selecting ANALOG will automatically select PCM ONLY as the FX FORMAT as the AC-3 and DTS effects are only compatible with digital inputs.

### COAX 1-5 and OPTICAL 1-3 (Digital Audio Inputs)

When one of these eight digital inputs is selected, the DC-2 will use it to derive the signal for the MAIN OUTPUTS. Note that all eight digital inputs can be used for various DC-2 inputs. This is particularly useful when using source components such as a laser disc or a DVD player to drive multiple DC-2 inputs.

When using a PCM digital audio source sampled at 48kHz, the following effects will operate: PARTY, 2-CHANNEL, MUSIC SURROUND, MUSIC LOGIC, LOGIC 7, TV MATRIX, PRO LOGIC and THX CINEMA.

---

## Video In

NOTE: S-Video input signals will be output on both the composite and S-Video jacks. However, if you are only connecting to the monitor via the S-Video output, composite video input sources will not be displayed.

The inputs labeled VCR, DVD, V-DISC, TV and AUX normally have corresponding video inputs. The inputs labeled CD, TUNER, and TAPE do not have associated video inputs, and default to the VCR video input. For maximum configuration flexibility, each of the five video inputs can be assigned to a different input, or to multiple inputs. If the assigned video input has both S-Video and composite jacks, the S-video signal takes priority whenever a cable is plugged into the appropriate S-video connector.

The DC-2 is designed to be the control center of any system. As such, there are separate outputs for easy integration of external recording devices as well as an additional "zone" in multi-room installations.

The Record and Zone 2 outputs on the DC-2 are wired in parallel so that the input selection will always be the same for both. For example, if the CD input is selected for Record, the CD input is also output to Zone 2. The primary difference between the Record and Zone 2 outputs is that Zone 2 has its own volume control, while the Record output level is fixed.

As protection against feedback, the TAPE and VCR inputs are normally blocked from being used as sources for the Record and Zone 2 outputs. This default condition can be changed in the Input Configuration menu as follows.

Use ▲ and ▼ to select REC/ZONE 2, then press SELECT. The ▲ and ▼ buttons will select ANALOG, DIGITAL, or BLOCKED as the state of the Zone 2 output.

ANALOG allows maximum flexibility from digital sources by utilizing both the digital and analog outputs of a digital source component (provided both are connected). The DC-2 processes the digital input signal for the main zone, and simultaneously routes the analog input signal to the Record and Zone 2 outputs. Since no D/A converters are necessary for the analog input signal, the functionality in the Main zone is not compromised.

DIGITAL routes the digital signal, assigned to the input, to the DC-2's 24-bit Digital to Analog (D/A) converters. After conversion, the signal is sent to the Record and Zone 2 outputs. As this setup bypasses the D/A converters in the source component, and utilizes the 24-bit D/A converters in the DC-2, sound quality can be dramatically improved when recording or listening in Zone 2. Note, however, that this setup automatically loads the appropriate 2-Channel effect in the main zone.

BLOCKED simply blocks the input from being sent to the Record and Zone 2 outputs. This prevents feedback from occurring with devices that have both an input and output attached to the DC-2 (Tape deck, VCR, etc.).

Record/Zone 2 functions can be accessed from the DC-2 front panel or the remote control. In either case, press and hold Record/Zone 2 while pressing one of the following buttons.

#### ON

Turns on the Zone 2 outputs, lights the red Record/Zone 2 front panel LED and redirects the current main zone input to the record/zone 2 outputs. From Standby, turns the unit on, selects the last used Zone 2 input, turns

## Record/Zone 2

NOTE: When listening to DTS material from a source component, DTS digital data is also sent out of the analog outputs. DTS data, which sounds like loud pink noise, may cause damage to a system.

NOTE: Removing the block from any input which has both an input and output attached to the DC-2 may cause damaging feedback.

## Record/Zone 2 Controls

Zone 2 volume on to the value selected in the OUTPUT LEVELS menu and engages full mute in the main zone.

**OFF**

Turns off the Zone 2 outputs, and the associated front panel LEDs.

**OSD (ON)**

Displays a STATUS menu for the current input. Press Done to exit.

**VOL ▲ and ▼**

Displays, then adjusts the current Zone 2 volume level. Activated displays (FP or OSD) will show level and a bar guage. When Zone 2 mute is engaged, these controls adjust volume without disengaging Zone 2 mute.

**Mute**

Engages Zone 2 mute and reduces the Zone 2 volume level to -80db. Pressing again restores volume to its previous level.

**SELECT and DONE (remote control only)**

Displays, then adjusts Zone 2 left/right balance. Activated displays (FP or OSD) will show bar guage.

**VCR, DVD, V Disc, TV, AUX, CD, Tuner, and Tape**

Selects the Record/Zone 2 input and lights the corresponding front panel input LED (unless the input is blocked). From Standby, the input is selected with full mute engaged in the main zone.

**Dolby, THX, Logic 7, and DTS**

These controls sets the Zone 2 volume level to the following levels.

Dolby	-30dB
THX	-20dB
Logic 7	-10dB
DTS	+00dB

**2 CH, Party, TV M, and Music**

These controls sets the master volume level to the following levels. When Zone 2 mute is engaged, these controls set the Zone 2 volume level without disengaging mute.

2CH	-30dB
Party	-20dB
TV M	-10dB
Music	+00dB

This menu item assigns the status for the programmable (PGM) trigger on the DC-2 rear panel. +12VDC is provided for controlling ancillary equipment or functions. Selections are ENABLE or DISABLE for the selected input. The factory default is ENABLE (high) for A/V inputs and DISABLE (low) for audio only inputs. (+5VDC is available via internal jumper. Contact your dealer or Lexicon Customer Service to perform this change.)

### PGM Trigger Assignment

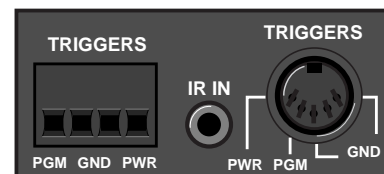

The Speaker Configuration menu allows a wide range of choices in speaker type and room setups to provide optimal performance in almost any room. An adjustable lowpass filter is available for the subwoofer, as well as a highpass filter for all other speakers. The three selections are for CUSTOM, THX or SURROUND EX configuration.

### Speaker Configuration

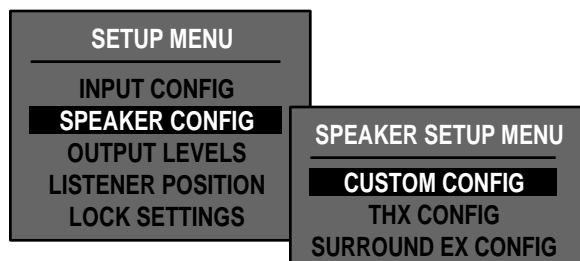

Press SELECT to open the CUSTOM CONFIG menu. Press SELECT to access the selections for any highlighted menu item.

### Custom Configuration

CUSTOM CONFIG MENU		Adjust with ▲ or ▼
FRONT L/R	SMALL	LARGE, SMALL
CENTER	SMALL	LARGE, SMALL, NONE
SIDES	DIPOLE SMALL	LG or SM STD, LG or SM DIPOLE, NONE
REARS	SMALL	LARGE, SMALL, NONE
SUBWFR	YES	YES, NO

Select LARGE for full-range front speakers to deliver full frequency response to the front left and right outputs. Selecting SMALL activates a 12dB per octave highpass filter and automatically routes low frequency information to the subwoofer output. Choices of 40, 80 and 120 Hz are available for the -3dB point. The SMALL setting is recommended unless your speakers are capable of handling full audio signals, or are equipped with their own crossovers.

### Front L/R

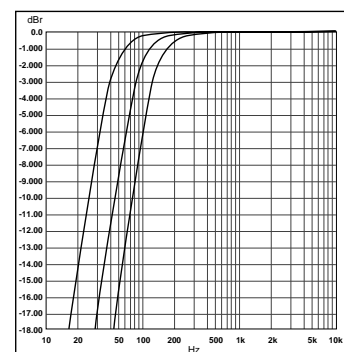

The high pass filter attenuates low frequencies at 12dB per octave. The values given are for the -3dB point.

## Center

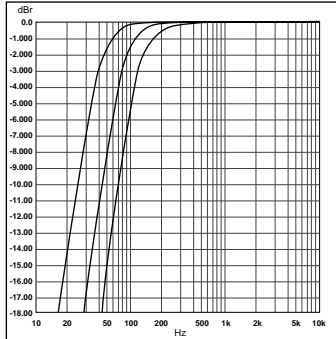

Bass Split rolls off frequencies at 12dB per octave. The values given are at the -3dB point of attenuation from the center speaker.

Systems that utilize a full-range center speaker should select LARGE to direct center information to the center output with a full frequency response. Select SMALL for installations where the center speaker is smaller than the left and right front speakers. This will automatically engage the Bass Split feature which takes the low frequency content from the center, and distributes it to the left and right front speakers, reducing the risk of damage to a small center speaker without loss of bass information. When SMALL is highlighted, press SELECT to display and adjust the crossover point for the low frequency redistribution. Available crossover points are: 40, 80 and 120Hz. Press DONE to return to the Speaker Configuration menu.

## Sides

NOTE: When STANDARD SIDE and REAR speakers are selected, the output level of the side channels is decreased slightly while the output level of the rear channels is increased slightly. This helps prevent the side speakers from overpowering the rear speakers.

This menu sets the system for your particular side speaker configuration. Systems with side speakers should be designated as STANDARD (LARGE or SMALL) or DIPOLE (LARGE or SMALL). When STANDARD SMALL or DIPOLE SMALL is highlighted, press SELECT to display and adjust the highpass filter for the side outputs. Choices are: 40, 80 or 120Hz. For any 5.1 channel inputs, selecting SMALL routes the low frequency information to the subwoofer output.

Selecting NONE mutes the side outputs and directs all surround information to the rear outputs.

## Rears

NOTE: In software Version 4, when SIDE and REAR speakers are selected, the following changes are automatically made to THX 5.1 and DTS THX effects:

- SURROUND EX is set to ON
- "EX" is added to the effect name (for example, "THX 5.1 EX")

The active selections are LARGE and SMALL. Systems that utilize full-range rear speakers should select LARGE to direct a full-range signal to them. SMALL should be selected when filtering is desired. (40, 80 and 120Hz are available as settings for the -3dB point). For any 5.1 channel inputs, selecting SMALL routes the low frequency information to the subwoofer output.

Selecting NONE mutes the rear outputs and directs all surround information to the side outputs.



Use of the subwoofer output is specified here. Selecting YES, then pressing SELECT allows you to display and adjust the crossover frequency for the subwoofer output. All summing and filtering is performed in the digital domain. You can select four different crossover points (OFF, 40, 80 or 120Hz) for the subwoofer. Although you can bypass the crossover and run a full range output if your subwoofer has an internal crossover, it is generally best to use the crossover in the DC-2.

NO mutes the subwoofer output and disables the Subwoofer Level parameter. For any 5.1 channel input, selecting NO routes the LFE (.1 channel) to any front speaker set to LARGE.

Selecting THX CONFIG from the SPEAKER SETUP menu automatically sets the speaker selections to the traditional configuration for THX listening. This configuration automatically sets REARS to NONE and all of the filters to 80Hz. This configuration is not adjustable.

Selecting SURROUND EX from the SPEAKER SETUP menu (available only in software Version 4) automatically sets the speaker selections for a THX SURROUND EX setup with two side and two rear speakers, and with all filters set to 80Hz. These settings are not adjustable.

When DC-2 input and output levels are set properly, the entire system will be calibrated to play films at the level intended by the director. Setting the output levels is easy with a Sound Pressure Level (SPL) meter. Using the DC-2's internally generated calibration signal, adjust the level of each output to the same relative level (75dB).

OUTPUT LEVELS MENU	Adjust with ▲ or ▼
INTERNAL NOISE TEST	Noise signal sent sequentially to all speakers
EXTERNAL NOISE TEST	Pro Logic effect w/current input as source
SUB PEAK LIMIT +15dB	-5 to +35dB
MUTE LEVEL -30dB	-10dB, -20dB, -30dB, -40dB, FULL MUTE
PWR-ON VOL -30dB	LAST LVL, -80 to +12dB
Z-2 PWR-ON -30dB	LAST LVL, -80 to +12dB

### Subwoofer Output

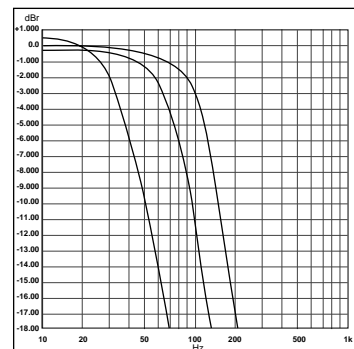

*Subwoofer Frequency Response*  
The low pass filter attenuates high frequencies at 24dB per octave. The values given are for the 6dB point.

### THX Configuration

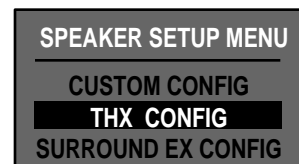

### SURROUND EX Configuration

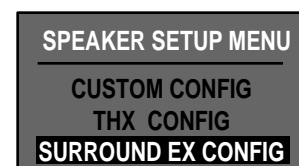

### Setting Output Levels

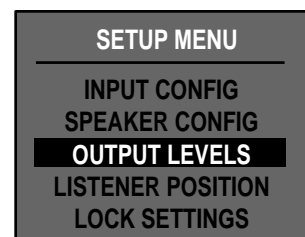

Select INTERNAL NOISE TEST or EXTERNAL NOISE TEST from the Output Levels menu.

The INTERNAL NOISE TEST automatically disconnects all audio and video inputs, disables any EQ functions, centers the Balance controls, and sets the system volume to +00dB. The test signal circles the room according to the speaker configuration you have defined in the Speaker Configuration menu. For a full complement of speakers, the order is: Left Front, Center, Right Front, Right Side, Left Side, Subwoofer, Right Rear, Left Rear.

The EXTERNAL NOISE TEST loads the Pro Logic, Dolby Digital or DTS Music effect and uses the signal from the currently selected input for calibration.

**NOTE:** If any of the amplifiers in your system have output level controls, their settings will affect the balance of the DC-2 outputs. Generally, the gain controls of these amps should be set prior to DC-2 Output Level calibration. You should record the values of these controls for later reference.

Once a test source is selected, a sub-menu showing each output level is displayed. Use the ▲ and ▼ buttons to highlight an output for adjustment. Press SELECT to stop the cycling of the noise signal, then use ▲ and ▼ to adjust the selected output level in precise 0.5dB increments from -10dB to +10dB.

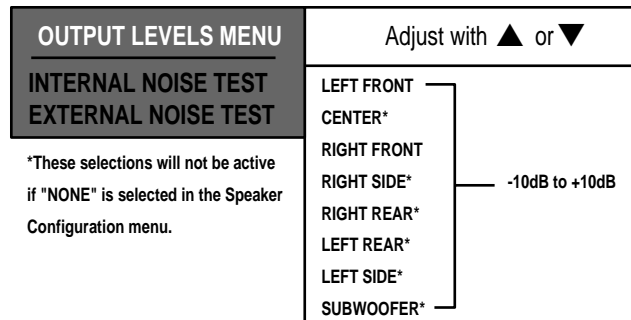

Using a Sound Pressure Level Meter such as Radio Shack model 33-2050 or 33-2055, set the weighting to *C* and the response to *Slow*. Adjust all output levels to achieve 75dB at the listening position.

In the absence of an SPL meter, it is possible to set the output level by ear. Use the internal noise generator in the DC-2 to adjust all volumes to be the same as they cycle around the various speakers. Depending on timbre variations between your speakers, this may be difficult to judge — get as close as you can. The system should be reasonably well balanced, although not actually calibrated for precise playback and level matching. With the system volume at 0dB, the internal noise source should be at the same level at which film dialog sounds comfortable.

### Note on External Noise Calibration

When using the external noise calibration, the DC-2 will load the factory default effect for the format of the incoming signal. In other words, if a PCM signal is coming into the DC-2 when external noise is engaged, the DC-2 will load the PRO LOGIC effect with the factory preset settings. If a Dolby Digital AC-3 signal is coming in, the DC-2 will load the DOLBY DIGITAL

effect with the factory preset settings. If a DTS signal is coming in, the DC-2 will load the DTS FILM effect with the factory preset settings.

Note that the Volume control is active when utilizing external noise.

Dolby Digital (AC-3) and DTS encoded sources can produce low frequency peaks that are much louder than those in matrixed Dolby Surround decoding. These higher levels may be troublesome in the home listening environment, either because they disturb non-listeners in nearby rooms, or because of the inability of the subwoofer and its associated amplifier to reproduce these levels without clipping.

## Subwoofer Peak Limiter

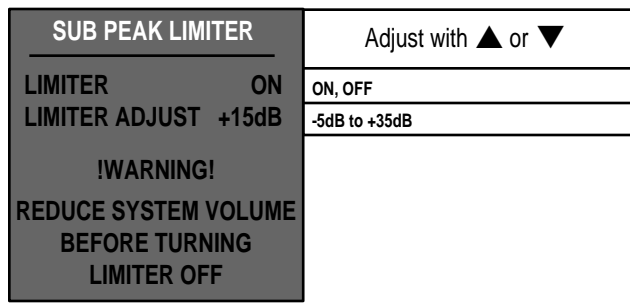

Note that +00dB=85dB, and +15dB=100dB in a properly calibrated system.

The DC-2 provides a Subwoofer Peak Limiter that prevents the subwoofer signal level from exceeding a preset value. The limit is factory preset to a level of +15dB. This setting can be changed within the limiter's operating range of -5dB to +35dB, with -5dB providing maximum limiting.

To turn off the limiter or to change its setting, select the SUB PK LIMITER parameter in the Output Levels menu.

If you want to turn the limiter off, first turn the system volume down in order to prevent the subwoofer from overloading.

Press ▼ to select LIMITER, then press SELECT. Press ▼ to select OFF. Press DONE twice to return to the Output Levels menu. While readjusting the system volume back to a comfortable listening level, check to be sure the subwoofer or its amplifier is not overloading on passages with loud low frequency peaks.

Selecting LIMITER ADJUST in the Sub Peak Limiter menu invokes a calibration routine for setting the optimal peak level for your installation. Pressing SELECT routes low frequency calibration noise to the subwoofer output of the DC-2. A two-line display indicates the LIMITER LEVEL setting in dB on the top line with a bar at the bottom to indicate relative noise level. Press ▲ and ▼ to adjust the noise level to the highest level that your equipment can reproduce without overload.

Note that the Sub Peak Limiter is separate from the Subwoofer level control in the Effect Adjust menus— one setting does not affect the other.

Be sure the limiter is set to ON before exiting. Press DONE to exit and automatically set the limiter to the level you have selected.

**Mute Level** This menu allows you to set the level of attenuation used whenever the DC-2 MUTE function is engaged. In the Output Levels menu, attenuation levels of -10dB, -20dB, -30dB, -40dB, and FULL are available.

**Power On Volume** This control in the Output Levels menu allows you to select the volume at which the DC-2 will power on. You can choose from a range of -80 to +12dB, or elect to have the system power on at the last level used (LAST LVL).

**Zone 2 Power On Volume** This control in the Output Levels menu allows you to select the initial volume level for Zone 2. You can choose from a range of -80 to +12dB, or elect to have Zone 2 power on at the last level used (LAST LVL).

## Setting Listener Position

The Listener Position menu is used for setting the surround and center delays and calibrating the Panorama effect.

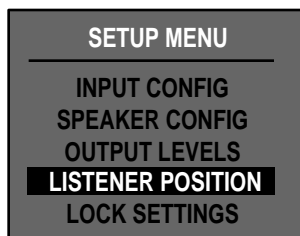

LISTENER POSITION		Adjust with ▲ or ▼
SPEAKER DISTANCE		based on speaker distance
A/V SYNC DLY	OFF	Off, 1 to 60ms (30ms in software Version 3)
CALIBRATE PANORAMA		CAL NOISE, SPEAKER ANGLE, LISTENER POS
L/R BALANCE	<   >	[ L _ _     _ _ R ]
ZONE 2 BALANCE	<   >	[ L _ _     _ _ R ]

**Speaker Distance** The Speaker Distance control automatically sets the appropriate time delays for all of the loudspeakers in a system. Although this adjustment is not a substitute for proper speaker placement, it will help to ensure accurate signal arrival times from all channels at the listening position.

To set up Speaker Distance, you must physically measure the distance from the primary listening position to the front baffle of each individual speaker in your system. An easy and accurate way to accomplish this is to have a person sit in the primary listening position, holding the end of a measuring tape, while a second person extends the tape measure to the front baffle of each speaker in turn.

To enter these values, select SPEAKER DISTANCE in the Listener Position menu and press SELECT. Use ▲ and ▼ to highlight feet or meters and press SELECT. Press SELECT again to highlight NEAREST SPKR. Use ▲ and ▼ to enter the actual distance, then press DONE.

Once you have entered the distance to the nearest speaker, the DC-2 will automatically calculate the maximum allowable distance. The display will show all of the speakers, each with a default distance setting equal to your nearest speaker. Use SELECT and ▲ and ▼ to highlight and enter actual distances for each speaker. The DC-2 rounds off distance settings into discrete steps – choose the closest step to the actual distance in these cases. If a speaker distance is further than the DC-2 can accommodate, set it to the maximum allowable distance. (This will vary, depending on your initial entry for NEAREST SPKR.)

A/V Sync Delay compensates for the delay that occurs when a video processor, such as a scan converter, is used with the DC-2. Most of these processors alter the original audio/video timing relationship by adding delay to the video signal as it is processed. A/V Sync Delay applies a corresponding delay to the audio signal to restore the original audio/video timing relationship. It can also be used to compensate for poorly mastered source material.

### **A/V Sync Delay**

If your video material appears to be out of sync, engage A/V Sync Delay in the LISTENER POSITION menu. With a video source running, adjust the delay along its range with ▲ and ▼.

Note that it is best to use a non-film source when setting A/V Sync Delay, as film dialog added in post production may have poor timing relationships.

Panorama works by canceling the sound going from each speaker to the opposite ear. Its effectiveness is highly dependent on the geometry of your front loudspeakers, the room and your listening position. The correct timing of the canceling signal varies with the relative angle between your main speakers.

### **Calibrate Panorama**

Find a mono source, such as an announcer on FM radio or a mono film, and listen for a tightly focused center image of speech or singing. If the image is off-center, adjust the DC-2's input balance controls. (The more centered the monaural image, the better Panorama will work.)

Select CALIBRATE PANORAMA from the Listener Position menu to display a sub-menu that allows you to turn on a calibration noise source, configure the speaker angle, and adjust the listener position.

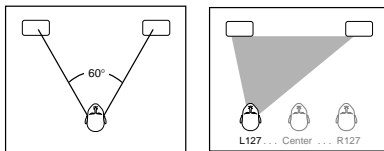

**SPEAKER ANGLE** is the angle between the main speakers as seen from the listening position — here it is about 60°. **LISTENER POS** allows you to adjust for an offset listening position.

<b>LISTENER POSITION</b>	
<b>SPEAKER DISTANCE</b>	
<b>A/V SYNC DLY</b>	OFF
<b>CALIBRATE PANORAMA</b>	
<b>L/R BALANCE</b>	<   >
<b>ZONE 2 BALANCE</b>	<   >
Adjust with ▲ or ▼	
<b>CAL NOISE</b>	OFF, LEFT ONLY, LEFT AND RIGHT, RIGHT ONLY
<b>SPEAKER ANGLE</b>	10° - 118°
<b>LISTENER POS</b>	L127...CNTR...R127

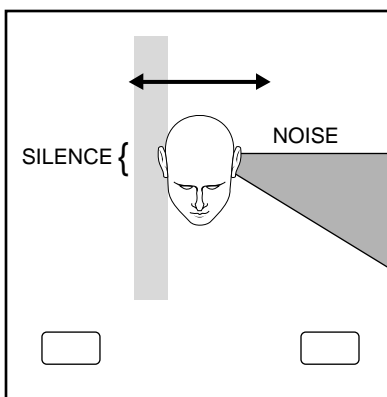

Move your head from side to side to find the position where the noise is full left, and the right ear hears near total silence.

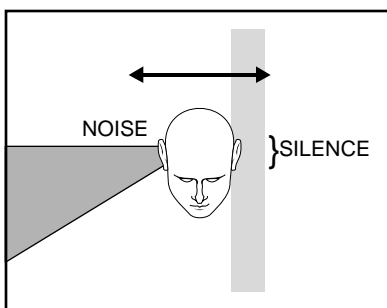

When calibrating right, if your left ear is in the silent band, the speaker angle is correct.

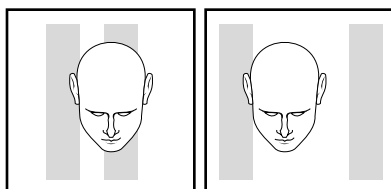

If the two silent bands are too close, lower the Speaker Angle; if they are too far apart, raise the Speaker Angle.

**CAL NOISE** is a special digitally generated signal to aid in calibrating the Speaker Angle and Listener Position parameters. Note that in all cases, sound will actually be produced by both front loudspeakers. The adjustments affect the *perceived* directionality of the sound.

The **SPEAKER ANGLE**, displayed in degrees, adjusts for wide or narrow speaker spacing (relative to the listening position). For the two canceling signals to arrive at both ears at the same time you must be centered precisely between the speakers. It will be easiest to calibrate this parameter if you start equidistant from the two front speakers, even if this is not your normal listening position. Once you have heard the effect and set the speaker angle, the Listener Position parameter will allow you to "move" the effect to your customary listening position.

To set the Speaker Angle, center yourself symmetrically between the two front speakers. Turn **CAL NOISE** on and select **LEFT ONLY**. The test signal should sound as though it is coming from off to your left side, well beyond the left speaker, with near-total silence in your right ear. Still facing forward, move your head from side to side until the effect is strongest. When you have found this *sweet spot* you will notice an almost physical sensation of silence in your right ear.

Now, select **RIGHT ONLY**. Again, shift your head from side to side to find the sweet spot, this time looking for the point where the sound is strongest in your *right* ear. Select **LEFT AND RIGHT** to determine if the sweet spots from the left and right tests coincide. If they do not coincide, return to the **SPEAKER ANGLE** display. If the first sweet spot is to the *left* of the second, press ▲; if it is to the *right*, press ▼.

If your normal listening position is not centered between your two front speakers, once you have corrected the speaker angle setting, you can "move" the sweet spot to that position. To do this, select **LISTENER POS** and use ▲ and ▼ to move the effect. As you adjust the position, the display will indicate motion to the left of center (L001,L002,L003...L127), **CENTER**, or to the right of center (R001,R002,R003...R127). The numbers represent approximately 1/3", but are provided primarily as a general reference.

Panorama is now calibrated. Press **DONE** repeatedly to step back to the main setup menu.

This control allows you to adjust the left/right balance of the front, side and rear main outputs. This control can also be accessed on the remote by pressing and holding the Shift button and using DONE to move to the left, and SELECT to move to the right.

### **L/R Balance**

This control allows you to adjust the left/right balance of the Zone 2 outputs. This control can also be accessed on the remote by pressing and holding the Record / Zone 2 button and using DONE to move to the left, and SELECT to move to the right.

### **Zone 2 Balance**

---

## Customization

---

After you have calibrated and customized the DC-2, there are two additional steps recommended to safeguard the settings. First, document your adjustments using the table found at the end of this manual. Second, consider locking the settings so that they cannot be inadvertently changed. The last item in the Setup menu allows you to lock the DC-2 settings, as well as to change the name displayed during power up.

### Locking Settings

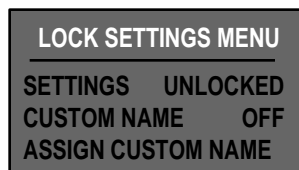

Locking the settings allows full operation of the unit but prohibits the ability to change effect parameters or setup values. Specifically, with the settings locked, the unit will allow any Parameter or Setup menu to be displayed, but attempting to select any item for adjustment will display the message: SETTINGS ARE LOCKED.

In order to prevent accidental changes, select the SETTINGS parameter and use ▲ to select LOCKED. A higher level of security can be achieved by simultaneously pressing **Record/Zone 2** on the remote, then pressing FX ▼ (with SETTINGS selected). Repeat to release lock.

### Assign Custom Name

When the DC-2 is first turned on, it displays a copyright notice with the current software version. You can choose to have it display CUSTOMIZED FOR DEMONSTRATION with the word DEMONSTRATION scrolled in from right to left, or you can replace the word DEMONSTRATION with a custom name of as many as 20 characters. To assign a new name, use ▲ and ▼ to highlight CUSTOM NAME. Press SELECT and press ▲ to turn this function ON, then press DONE.

You will return to the Lock Settings menu with ASSIGN CUSTOM NAME highlighted. Pressing SELECT will display the current name with a cursor indicating which character position can be modified. Use ▲ and ▼ to select a new character. Use SELECT to move the cursor to a new position. Press DONE to save the new name.



When EFFECT ADJUST is selected from the Main menu, the on-screen display shows a list of parameters specific to the current effect, as well as the current value of each parameter. (The front panel display shows one parameter at a time). Use the ▲ and ▼ buttons to move through the displayed list. Press SELECT to activate a two-line display which allows you to use ▲ and ▼ to alter the selected parameter's value. Press DONE to confirm the change and move on to the next menu item. Each DC-2 Effect and its parameter menu is described in the following sections.

Although the list of available parameters will vary with different effects, the last item in each menu is always CUSTOM. Selecting CUSTOM calls up a sub-menu which allows you to name your custom effects, to compare your version with the original preset, or to restore the preset versions of the Effect name and parameter values.

When first shipped, the DC-2 has a set of default values assigned to each Effect. These values have been determined to be suitable for initial listening. As every installation has its own unique characteristics, and listeners have distinctly different preferences, you may want to tailor the Effects to suit your own requirements. To allow easy customization, any parameter changes you make take effect instantly, and automatically become part of the Effect. You can even change the name that appears on-screen. Once you have made the changes you want, the Effect will remain as you have set it unless you alter it again, or deliberately restore the factory preset parameter values.

Selecting CUSTOM from any Effect Adjust menu will give you access to the controls listed to the side and described below. Use ▲ and ▼ to highlight any menu item, then press SELECT to open the submenu.

LISTEN CUSTOM/PRESET lets you compare your edited version of an Effect with the original version as set at the factory. When this control is selected, ▲ and ▼ allow you to alternate between the "preset" and your modified version ("custom"). The display will confirm whether you are LISTENING TO CUSTOM or PRESET.

Note that this function is available, even if you have not made any changes to an Effect. Until you make parameter changes to create a custom version of a preset, the LISTEN TO CUSTOM option will contain an exact duplicate of the preset Effect.

Exiting this menu restores the CUSTOM version.

## Using DC-2 Effects

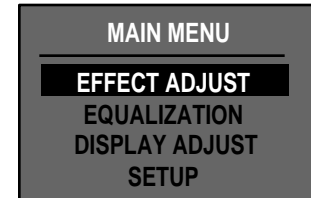

## Customizing Effects

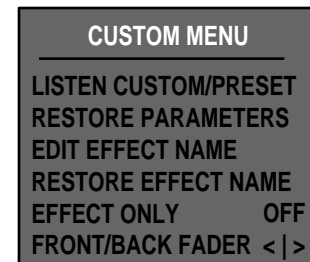

## Comparing a modified Effect to the factory preset version

---

**Restoring the original  
parameter values  
of an Effect**

The RESTORE PARAMETERS function allows you restore the currently selected Effect to its factory preset state.

When you select this function, you will be prompted to reconsider erasing your changes. — If you *don't* want to erase your versions, press DONE to exit the menu. Pressing SELECT in response to the displayed query will restore all of the factory preset values to the Effect.

**Naming your  
custom Effect**

EDIT EFFECT NAME allows you to assign a new name, of as many as 13 characters, to your Effect. With EDIT EFFECT NAME highlighted, press SELECT to display the current name with a cursor indicating which character position can be modified. SELECT moves the cursor to a new position. ▲ and ▼ scroll through the available character set. Press DONE to save the new name.

Note that the following effects do not allow custom names: PRO LOGIC, THX CINEMA, LOGIC 7, DOLBY DIGITAL, THX 5.1, 5.1 LOGIC 7, DTS FILM, DTS THX and DTS LOGIC 7.

**Restoring the  
original Effect name**

RESTORE EFFECT NAME allows you to restore the original factory name of an Effect, without changing any of your modified parameter settings. When you select this function, the message PRESS SELECT TO RESTORE EFFECT NAME allows you to reconsider erasing your custom name. — If you *don't* want to erase your version, press DONE to exit the menu. Pressing SELECT in response to the displayed query will restore the factory preset name.

**Listening to only  
the DC-2 Effect**

Selecting EFFECT ONLY allows you to listen to only the effects added by the DC-2 to the currently loaded program. With this function selected, use ▲ and ▼ to turn this function on or off.

**Front/Back Fader**

This control allows you to adjust the front/rear balance for the current effect. This control can also be accessed on the remote by pressing and holding the Shift button and using ▲ to move the balance point forward, and ▼ to move it backward.

The PCM Effects are compatible with two-channel input signals (analog or digital). These effects are included in all three versions of the DC-2.

Panorama extracts the natural ambience from recorded music and moves it outward from the speakers, producing greater width and depth of image and a feeling of enhanced spaciousness. This mode adds no additional sound but expands the existing stereo image. Panorama also works well with Dolby Stereo movies, bringing the surround track outward into the room.

The location of the front speakers and the listening position are crucial to Panorama's effectiveness and for best results your system and the DC-2 together should be set up and calibrated according to the procedure in Chapter 2. The strength of the Panorama effect drops off as you move away from the prime listening position, especially to the sides. Video systems with the L/R main speakers spaced closely on either side of a TV screen will produce a usable effect over a somewhat wider area than set-ups with a large angle between the L/R main speakers.

## Panorama

Parameter	Initial Value	Range
INPUT BALANCE	(Centered)	Full Left-Full Right
CENTER LEVEL	4	0-15
REAR ROLLOFF	4.9kHz	453Hz-20.0kHz
REAR DELAY	10ms	0-32ms
SURROUND LEVEL	12	0-32
BASS CONTENT	MONO	STEREO, MONO, BINAURAL
LOW FREQ WIDTH	0	-25 to +25
SUBWOOFER LVL	+00dB	OFF, -30dB to +05dB
EFFECT LEVEL	62	0-62
CUSTOM		

The Nightclub Effect generates the appropriate early reflections for simulation of many different intimate spaces, and sends the reflections to the front, side and rear speakers.

## Nightclub

Parameter	Initial Value	Range
CENTER LEVEL	9	0-15
SPEECH DETECT	OFF	ON/OFF
HALL SIZE	4 Meters	4-17 Meters
LIVENESS	4	0-6
ROLLOFF	9.7kHz	453Hz-20.0kHz
SUBWOOFER LVL	+00dB	OFF, -30dB to +05dB
EFFECT LEVEL	+02dB	-30 to +05dB
CUSTOM		

## Concert Hall

The Concert Hall Effect generates the appropriate early reflections for simulation of many different halls, and sends the reflections to all channels in addition to the direct signal in the main speaker. This Effect is not appropriate for highly percussive music.

Parameter	Initial Value	Range
CENTER LEVEL	8	0-15
SPEECH DETECT	ON	ON/OFF
HALL SIZE	30 Meters	20-30 Meters
LIVENESS	4	0-6
ROLLOFF	3.3kHz	453Hz-20.0kHz
SUBWOOFER LVL	+00dB	OFF, -30dB to +05dB
EFFECT LEVEL	-01dB	-30 to +05dB
CUSTOM		

## Church

The Church Effect uses a reverberation algorithm, which differs from ambience in that it does not simulate the reflections of specific halls, but emphasizes rich, smooth reverberant decay in small and medium spaces. It works well for simulating a space with a long reverberation time relative to its size, such as a reverberant chamber, or a church.

Parameter	Initial Value	Range
CENTER LEVEL	7	0-15
SPEECH DETECT	ON	ON/OFF
MID RT	1.89 sec	.89-13.42 sec
BASS RT	2.36 sec	0.7, 1.0, 1.25xMID RT
HALL SIZE	30 Meters	4-30 Meters
PRE-DELAY	24ms	0-88ms
ROLLOFF	2.6kHz	453Hz-20.0kHz
SUBWOOFER LVL	+00dB	OFF, -30dB to +05dB
EFFECT LEVEL	-01dB	-30 to +05dB
CUSTOM		

## Cathedral

The Cathedral Effect uses a reverberation algorithm which emphasizes rich, smooth reverberant decay in large spaces. As its name indicates, it works well for simulating a space with a long reverberation time relative to its size, such as a cathedral.

Parameter	Initial Value	Range
CENTER LEVEL	7	0-15
SPEECH DETECT	ON	ON/OFF
MID RT	3.90 sec	1.14-17.04 sec
BASS RT	4.87 sec	0.7, 1.0, 1.25xMID RT
HALL SIZE	38 Meters	20-38 Meters
PRE-DELAY	40ms	0-88ms
ROLLOFF	2.6kHz	453Hz-20.0kHz
SUBWOOFER LVL	+00dB	OFF, -30dB to +05dB
EFFECT LEVEL	-01dB	-30 to +05dB
CUSTOM		

The Party effect allows unprocessed stereo signals to be played over all speakers for background music or for maximum acoustical output of the system.

## Party

---

Parameter	Initial Value	Range
CENTER LEVEL	15	0-15
SIDE LEVEL	+00dB	OFF, -30dB to +05dB
REAR LEVEL	+00dB	OFF, -30dB to +05dB
SUBWOOFER LVL	+00dB	OFF, -30dB to +05dB
CUSTOM		

The 2- Channel effect allows you to use your system for traditional two channel playback.

## 2-Channel

---

Parameter	Initial Value	Range
SUBWOOFER LVL	+00dB	OFF, -30dB to +05dB
CUSTOM		

Music Surround is a surround effect developed specifically for classical music listening. It makes full use of additional loudspeakers placed at the center, sides and rear of the room. This effect uses ambience extraction for the side and rear speakers.

## Music Surround

---

Parameter	Initial Value	Range
CENTER LEVEL	16	0-30
SOUNDSTAGE	NEUTRAL	FRONT, NEUTRAL, REAR
5 SPEAKER ENHANCE	ON	ON, OFF
BASS ENHANCE	OFF	ON, OFF
SURROUND ROLLOFF	4.0kHz	453Hz-20.0kHz
REAR DELAY OFFSET	15ms	0-20ms
SIDE LEVEL	+00dB	OFF, -30dB to +05dB
REAR LEVEL	+00dB	OFF, -30dB to +05dB
SUBWOOFER LVL	+00dB	OFF, -30dB to +05dB
EFFECT LEVEL	+00dB	-30 to +05dB
CUSTOM		

## Music Logic

Music Logic is a surround effect developed specifically for music listening. It makes full use of additional loudspeakers placed at the center, sides and rear of the room and provides a slight amount of steering for the front channels.

Parameter	Initial Value	Range
CENTER LEVEL	16	0-30
VOCAL ENHANCE	+3.0dB	+0.0dB, +3.0dB, +6.0dB
FRONT STEERING	MUSIC	OFF, 1/2, FILM, MUSIC
SOUNDSTAGE	NEUTRAL	FRONT, NEUTRAL, REAR
5 SPEAKER ENHANCE	ON	ON, OFF
BASS ENHANCE	OFF	ON, OFF
SURROUND ROLLOFF	6.9kHz	453Hz-20.0kHz
REAR DELAY OFFSET	5ms	0-20ms
SIDE LEVEL	+00dB	OFF, -30dB to +05dB
REAR LEVEL	+00dB	OFF, -30dB to +05dB
SUBWOOFER LVL	+00dB	OFF, -30dB to +05dB
CUSTOM		

## Logic 7

This film sound mode reproduces musical material with maximum separation at all times, whether or not directional material is being steered. In addition, Logic 7 uses intelligent steering to extract wide bandwidth stereo surround channels. If both side and rear speaker pairs are available, signals may be steered between the left side and left rear, or between the right side and right rear. It is also possible for a signal to be steered fully to the rear speakers, with the side surround speakers 6dB lower than the rears to provide subjective rear imaging.

Logic 7 contains the re-equalizer feature of the THX Cinema effect, as well as Lexicon's proprietary vocal enhancement feature. The combination of stereo surround information during music and decorrelated effects, with discrete steering to the sides and rears, gives Logic 7 unrivaled performance on matrix encoded films.

Parameter	Initial Value	Range
AUTO AZIMUTH	ON	ON/OFF
VOCAL ENHANCE	+0.0dB	0.0dB, +3.0dB, +6.0dB
RE-EQUALIZER	ON	ON/OFF
SOUNDSTAGE	REAR	FRONT, NEUTRAL, REAR
5 SPEAKER ENHANCE	ON	ON, OFF
BASS ENHANCE	OFF	ON, OFF
SURROUND ROLLOFF	6.9kHz	453Hz-20.0kHz
REAR DELAY OFFSET	5ms	0-20ms
SIDE LEVEL	+00dB	OFF, -30dB to +05dB
REAR LEVEL	+00dB	OFF, -30dB to +05dB
SUBWOOFER LVL	+00dB	OFF, -30dB to +05dB
CUSTOM		

The TV Matrix effect provides surround effects for television viewing of monaural, stereo, and stereo synthesized programs.

## TV Matrix

Parameter	Initial Value	Range
AUTO AZIMUTH	ON	ON/OFF
VOCAL ENHANCE	+3.0dB	0.0dB, +3.0dB, +6.0dB
FRONT STEERING	1/2	OFF, 1/2, FILM, MUSIC
RE-EQUALIZER	OFF	ON/OFF
SOUNDSTAGE	REAR	FRONT, NEUTRAL, REAR
5 SPEAKER ENHANCE	ON	ON, OFF
BASS ENHANCE	OFF	ON, OFF
SURROUND ROLLOFF	6.9kHz	453Hz-20.0kHz
SIDE LEVEL	+00dB	OFF, -30dB to +05dB
REAR LEVEL	+00dB	OFF, -30dB to +05dB
SUBWOOFER LVL	+00dB	OFF, -30dB to +05dB
CUSTOM		

This Effect provides Dolby Pro Logic Surround decoding designed for any Dolby Surround encoded movies, music, television programs or games. Lexicon's proprietary Auto Azimuth correction makes it one of the most accurate Pro Logic decoders available.

## Pro Logic

Parameter	Initial Value	Range
AUTO AZIMUTH	ON	ON/OFF
VOCAL ENHANCE	0.0dB	0.0dB, +3.0dB, +6.0dB
SUBWOOFER LVL	+00dB	OFF, -30dB to +05dB
CUSTOM		

This Effect, provides Home THX Cinema surround decoding for any Dolby surround encoded movies, music or television programs. The effect is similar to Pro Logic, but includes the features of re-equalization, timbre matching and decorrelation. The surround channels are monaural, but can be decorrelated. This effect can also be set to use the Logic7 stereo surrounds with the STEREO setting of SURROUNDS, although full separation between the sides and the rear speakers is not available.

## THX Cinema

Parameter	Initial Value	Range
AUTO AZIMUTH	ON	ON/OFF
RE-EQUALIZER	ON	ON/OFF
SURROUNDS	DECORR	STEREO, DECORR
SUBWOOFER LVL	+00dB	OFF, -30dB to +05dB
CUSTOM		

## Mono Logic

Mono Logic takes a monaural soundtrack and sends music and sound effects to the sides and rear through a room simulator mode while keeping the dialog in the center.

Parameter	Initial Value	Range
MAIN LEVEL	8	0-16
ACADEMY FILTER	ON	ON/OFF
ROLLOFF	3.3kHz	453Hz to 20.0kHz
SUBWOOFER LVL	+00dB	OFF, -30dB to +05dB
EFFECT LEVEL	-04dB	-30 to +05dB
CUSTOM		

## PCM Effect Parameters

5 SPEAKER ENHANCE simulates 7 speaker playback through a 5 speaker system, providing a heightened sense of spaciousness and envelopment without extra speakers. This enhancement is most noticeable if the surround speakers are positioned directly to the side of the listening position, or if the listening position is located against the rear wall.

Note that, although this provides very convincing improvement to a 5 speaker system, it is not a substitute for a properly set up and calibrated 7 speaker system. The difference is most noticeable when the listener is seated to one side of the calibration position.

ACADEMY FILTER is provided to recreate the proper tonal balance of older monaural films that were recorded with much narrower and duller frequency response than current films.

AUTO AZIMUTH is short for auto azimuth error correction/automatic input balance. Auto Azimuth should be set to ON for films, and OFF for music. When ON, special patented algorithms continually monitor the input signal and adjust both the relative level and time offset of the two channels to keep the dialog properly centered and special effects properly localized. This automatic feature is the reason the unit does not need an input balance control for Dolby Surround decoding.

BASS CONTENT allows you to modify the bass content for Mono, Stereo or Binaural recordings. The BINAURAL setting turns the rear level parameter off and activates special low-frequency compensation. This feature is offered specifically for true binaural recordings made with a dummy head.

BASS ENHANCE derives stereo bass to provide low frequencies that are noticeably less localizable and more spacious in the playback room.



Note that results will vary depending on room acoustics and the low frequency capacity of the surround speakers. As side and/or rear speakers are used for bass enhancement, the effectiveness is improved with speakers capable of reproducing low frequencies (LARGE). Using speakers that are not capable of producing low frequencies (<80Hz) may cause damage to them.

BASS RT (low frequency reverberation time) depends on MID RT and is expressed as a multiplier. BASS RT should be set to 1.0 x MID RT for a more natural effect in smaller spaces.

CENTER LEVEL adjusts the output level from the center speaker.

EFFECT LEVEL adjusts the loudness of the side and rear speakers. When there are no side speakers, it adjusts the amount of ambient signal mixed into the main loudspeakers. In Panorama, this control changes the apparent width of the front soundstage. 0 = ordinary stereo, 62 provides the widest image.

FRONT STEERING provides four basic settings which have been developed specifically to optimize center channel signal strength for film and music. The MUSIC setting is designed for classical and popular music. It preserves nearly the full width of the front image, even in complex material with a high vocal level. At the same time, it reproduces film with plausible separation between the center speaker and the front speakers during dialog.

The FILM setting has excellent frontal image stability through the whole room during dialog and vocals, while preserving the full width of the front image in the spaces between dialog, and for music without vocals. The front image during vocals is noticeably narrower than with the MUSIC setting, but highly satisfactory nonetheless.

1/2 is similar to the MUSIC setting under most conditions, but will reproduce sound in all three front speakers when a strongly centered, or mono signal is present. This is an excellent choice for heavily centered pop music such as metal and sounds more natural for broadcast material with a single announcer. OFF sets the center channel level to 4.5dB less than the front left and right speakers, and then leaves the level unchanged as the steering varies. This setting is equivalent to conventional stereo with a slight center fill.

HALL SIZE allows you to select room sizes of lengths ranging from 4-38 meters, depending on the effect selected.

INPUT BALANCE allows you to compensate for the occasional source with audible channel imbalance. When selected, screen graphics indicate the relative left/ right position.

LIVENESS adjusts the amount of recirculation within the effect. Higher values mimic more reflective surfaces in the simulated space and increase the amount of time it takes the sound to decay. At very high values, the decay is audibly less smooth than in the Church and Cathedral Effects, which are more effective at simulating very live spaces.

LOW FREQ WIDTH allows you to apply low-frequency spatial correction to the signal. Positive values of LOW FREQ Width indicate that the *difference* signal (L-R) has additional energy below 500Hz, while the *sum* (L+R) has correspondingly less. Negative settings of LOW FREQ WIDTH can compensate for recordings with too much of this property. This control can add needed spaciousness and warmth to classical recordings made with coincident or near-coincident microphones.

MAIN LEVEL controls the level of the mono signal that is reproduced by the main speakers. When a center speaker is part of the configuration many films may sound better when this control is set between 6-12. This spreads the film sound out around the screen and can be more pleasant than restricting the dialog and much of the other film sound to the center speaker.

MID RT (midrange reverberation time) is the time required for midrange sounds to decay 60dB in level.

PRE-DELAY increases the delay between the direct sound and the onset of reverberation. Because some pre-delay is inherent in the program material, a value of 0 is usually a good starting point. Increasing the pre-delay value will make the hall sound larger.

RE-EQUALIZER equalizes the left, center, and right channel outputs to match the overall frequency balance of the original recording. Without this re-equalization, many films and some television programs will sound too bright.

REAR DELAY adjusts the amount of time between the appearance of a signal in the front channels and its emergence from the rear. Generally, the correct delay is about 16 milliseconds, but the setting depends on speaker set-up and source material. In general, the delay should be low enough so that the rear sound does not become identifiable as a distinct source. The settings also affect the side outputs.

REAR DELAY OFFSET is an additional delay added to the rear channels. This delay increases the apparent size of the listening space by increasing the rear delay time. Feel free to experiment to find the setting that works best.

REAR LEVEL controls the volume level of the rear speakers. Although we have selected a default value, the correct setting will vary with each recording, the room, and your personal taste.

REAR ROLLOFF sets the frequency above which the rear-channel sound is attenuated. The appropriate setting will vary with the program material. It should be set high enough to give presence and airiness to the rear sound without placing distracting instrumental overtones or other sounds behind you. The settings also affect the side outputs.

ROLLOFF mimics the absorption of the air in the hall and, typically, should begin with a low frequency to simulate large spaces.

SIDE LEVEL controls the volume level of the side speakers. Although we have selected a default value, the correct setting will vary with each recording, the room, and your personal taste.

SIDE ROLLOFF provides a high frequency cutoff for the side speakers. The optimal setting for this control will vary widely with the source material.

SOUNDSTAGE controls the level of the surround speakers relative to the front speakers in a dynamic way. The DC-2 attempts to detect whether or not the sound source was originally encoded from a surround source by looking for occasional bursts of rear-steered material, and by identifying the directional orientation of the background sound between strong sounds. Whenever there is an indication that the source was originally surround encoded, the Soundstage control automatically reverts to the REAR setting — which gives the rear speakers full level. The NEUTRAL position attenuates the rear speakers 3dB. The FRONT position attenuates the rear speakers 6dB. The effect is to move the listening position forward in the listening space.

SPEECH DETECT activates a circuit that distinguishes monaural speech from other inputs. Essentially, this control turns down the effect to make speech clearer. Whenever stereo signals are present, the right and left input channels are used independently as inputs to the ambience synthesis. If there is a strong monaural speaking voice present at the same time, this

component of the input to the effect is reduced while the stereo component is increased.

If the input signal is pure monaural speech the reverb is almost entirely attenuated. SPEECH DETECT is a real benefit to some popular music (where spoken voice, such as rap, occurs along with the music), stereo television and early stereo movies. Any stereo material which was not carefully mixed for Surround is a good candidate for playing through the Nightclub, Concert Hall, Church or Cathedral Effect with speech detect on.

SUBWOOFERLVL boosts or cuts the subwoofer output level. Although the normal subwoofer level is set during the calibration procedure, with some recordings it may be desirable to increase or decrease this deep bass level.

SURROUND LEVEL adjusts the loudness of the signals sent to the rear channels. This control should be set so that the rear is audible without calling attention to itself. Numerical values and screen graphics are displayed during adjustment. The settings also affect the level of the side outputs.

SURROUND ROLLOFF allows the high frequencies of the surround channels to be attenuated with the same detection circuitry as that described for the Soundstage control. The attenuation is quite attractive on many music and broadcast sources which were not mixed for surround. When a surround source is detected, these filters are removed, so the rear speakers can reproduce surround events with full bandwidth. This control should be set high enough to give presence and airiness to the rear sound without placing distracting instrumental overtones or other sounds behind you. The settings also affect the side outputs.

SURROUNDS selects the type of surround decoding used by the DC-2. STEREO provides extraction of five channels of surround information from a standard 4-2-4 matrix-encoded soundtrack (Dolby Surround, Ultra\*Stereo, etc.) The drama of this effect is dependent on the source material and is most noticeable with strong stereo music soundtracks. The DECORRELATED setting electronically scrambles the monaural surround channel to provide added spaciousness and envelopment.

VOCAL ENHANCE boosts vocals in the center channel. By targeting specific frequencies, it can boost only vocals, without raising the entire center channel level (which would alter the output balance achieved during calibration).

**AC-3 Effects** are compatible with Dolby Digital input signals. These effects, along with the PCM Effects described in Chapter 3, are included in the AC-3 and DTS versions of the DC-2. Any AC-3-capable software and /or source components should be labeled with a badge, similar to the one on the DC-2 front panel (AC-3 and DTS versions).

In the AC-3 effects, an AC-3 Status Display is available in the parameter menu with the following information.

**MATRIX ENCODED:** YES indicates a 2.0 Dolby Digital input is matrix encoded; No indicates it is not.

**DOWNMIX:** YES indicates a Dolby Digital input is being downmixed for the selected speaker configuration. NO indicates no downmixing is taking place, except in the 5.1 2-Channel Effect, which is designed to create a two-channel downmix from Dolby Digital 5.1 channel signals.

**DATA RATE:** 32-640kb, depending on the data rate of the incoming Dolby Digital signal.

**SAMPLE RATE:** 44.1kHz or 48kHz depending on the incoming Dolby Digital signal.

**PGM CONTENT:** shows you the actual spatial characteristics of the incoming soundtrack. The information appears as **F/S.LFE** where **F**=the number of front channels and **S**=the number of surround channels. **LFE=.1** if the LFE channel is on.

For example, a given source may display **3/2.1**, indicating that the source was mixed with 3 front channels, 2 surround channels, and the LFE channel. When the designation **.1** indicates that the LFE channel is on, as in our example, a level meter at the bottom of the display will show LFE channel activity. (Note, that there may be instances where the LFE channel is on, but no activity shows in the meter display.)

**REF OFFSET** indicates the Dialog Normalization value that is present in AC-3 bitstreams. In AC-3, dialog is reproduced at -31dBFS (31dB below full scale). If the program material was mixed so that dialog is at -31dBFS, then **REF OFFSET=0dB**. If the dialog was mixed at a "hotter" level, for example, -27dBFS, then **REF OFFSET = -4dB** and the DC-2 would adjust the levels down 4dB to bring dialog back to -31dBFS.

## AC-3 Status Display

AC-3 STATUS	
<b>MATRIX ENCODED</b>	<b>NO</b>
<b>DOWNMIX</b>	<b>NO</b>
<b>SAMPLE RATE</b>	48kHz
<b>DATA RATE</b>	384 kb/sec
<b>PGM CONTENT</b>	3/2.1
<b>REF OFFSET</b>	-4dB
<b>LFE</b>	

## 5.1 2-Channel

This Effect mixes Dolby Digital 5.1 information for two-channel playback. These soundtracks can be recorded onto two-channel formats, or played back through left and right front speakers. The mix is designed to play back with full surround when decoded through Logic 7. In mixing a film with very heavy use of the Low Frequency Effects Channel, it may be desirable to lower LFE MIX LEVEL.

Parameter	Initial Value	Range
AC-3 STATUS (display only — not user adjustable)		
COMPRESSION	OFF	AUTO, ON, OFF
CENTER MIX	16	0-30
SURROUND MIX	+2dB	-5 to +5dB
CENTER DLY SAMPLES	+0	-127 to +127
MASTER LEVEL	+5dB	-5dB to +5dB
LFE MIX LEVEL	+0.0dB	-20.0dB to +0.0dB
SUBWOOFER LVL	+00dB	OFF, -30dB to +05dB
CUSTOM		

## 5.1 Music

This Effect enhances playback of Dolby Digital music recordings, or Dolby Digital film soundtracks with strong musical content. This effect contains many of the features found in 5.1 LOGIC 7, with settings that are more appropriate for music.

Parameter	Initial Value	Range
AC-3 STATUS (display only — not user adjustable)		
COMPRESSION	OFF	AUTO, ON, OFF
RE-EQUALIZER	OFF	ON, OFF
BASS ENHANCE	OFF	ON, OFF
REAR DLY OFFSET	5ms	0-20ms
SIDE LEVEL	+00dB	OFF, -30dB to +05dB
REAR LEVEL	+00dB	OFF, -30dB to +05dB
LFE MIX LEVEL	+0.0dB	-10.0dB to +0.0dB
SUBWOOFER LVL	+00dB	OFF, -30dB to +05dB
CUSTOM		

5.1 Logic 7 combines all the features of Dolby Digital AC-3 with enhancements by Lexicon and LucasFilm. This effect uses Logic 7 matrix technology to enhance the steering between the side speakers and the rear speakers, so sounds intended to come from behind the listener actually do come from behind. This effect also includes the adaptive decorrelation and re-equalizer features of THX 5.1.

5.1 Logic 7 provides the ultimate in film reproduction. It brings out all the increased excitement and spaciousness a 7 channel speaker system can produce.

## 5.1 Logic 7

Parameter	Initial Value	Range
AC-3 STATUS (display only — not user adjustable)		
COMPRESSION	OFF	AUTO, ON, OFF
VOCAL ENHANCE	+0.0dB	+0.0dB, +3.0dB, +6.0dB
RE-EQUALIZER	ON	ON, OFF
BASS ENHANCE	OFF	ON, OFF
REAR DELAY OFFSET	5ms	0-20ms
SIDE LEVEL	+00dB	OFF, -30dB to +05dB
REAR LEVEL	+00dB	OFF, -30dB to +05dB
LFE MIX LEVEL	+0.0dB	-10.0dB to +0.0dB
SUBWOOFER LVL	+00dB	OFF, -30dB to +05dB
CUSTOM		

The Dolby Digital effect decodes Dolby AC-3 encoded soundtracks. Unlike analog Dolby surround decoding, Dolby Digital uses five discrete full-range channels and a sixth dedicated, Low Frequency Effect (LFE) channel. In this effect, any rear speakers present are connected in parallel with the side speakers. This is the standard Dolby Digital decoder. It does not include the enhancements by Lexicon or LucasFilm which are available with other AC-3 effects in the DC-2.

## Dolby Digital

Parameter	Initial Value	Range
AC-3 STATUS (display only — not user adjustable)		
COMPRESSION	OFF	AUTO, ON, OFF
VOCAL ENHANCE	+0.0dB	+0.0dB, +3.0dB, +6.0dB
BASS ENHANCE	OFF	ON, OFF
SIDE LEVEL	+00dB	OFF, -30dB to +05dB
REAR LEVEL	+00dB	OFF, -30dB to +05dB
LFE MIX LEVEL	+0.0dB	-10.0dB to +0.0dB
SUBWOOFER LVL	+00dB	OFF, -30dB to +05dB
CUSTOM		

## THX 5.1 (Including Surround EX)

This Effect provides THX 5.1 Cinema enhancements for film soundtracks recorded in the Dolby Digital format. This processing compensates for the acoustical differences between large mixing theaters and the typically smaller home environment. When SIDE and REAR speakers are selected in the SPEAKER CONFIG menu, SURROUND EX is automatically set to ON for proper decoding of Surround EX soundtracks.

Parameter	Initial Value	Range
AC-3 STATUS (display only — not user adjustable)		
SURROUND EX	ON	ON, OFF
COMPRESSION	OFF	AUTO, ON, OFF
RE-EQUALIZER	ON	ON, OFF
LFE MIX LEVEL	+0.0dB	-10.0dB to 0.0dB
SUBWOOFER LVL	+00dB	OFF, -30dB to +05dB
CUSTOM		

## AC-3 Effect Parameters

AC-3 STATUS displays the current status of incoming AC-3 data. The displayed items are not user adjustable.

BASS ENHANCE derives stereo bass to provide low frequencies that are noticeably less localizable and more spacious in the playback room.

Note that results will vary depending on room acoustics and the low frequency capacity of the surround speakers. As side and /or rear speakers are used for bass enhancement, the effectiveness is improved with speakers capable of reproducing reproducing low frequencies (LARGE). Using speakers that are not capable of producing low frequencies (<80Hz) may cause damage to them.

CENTER DLY SAMPLES adjusts the time offset of the center channel. The appropriate value is +0 unless you know that the center channel is not properly timed, as well as the amount by which it is off.

CENTER MIX adjusts the level of the center channel applied to the two-channel downmix. The appropriate value for film is 16. The appropriate value for music is 11.

COMPRESSION enhances the intelligibility of Dolby Digital material at low volume levels (-6dB or lower). When set to AUTO, this control automatically limits peak signals and boosts low level signals. The amount of compression increases proportionately as volume is decreased. This is quite useful when listening to Dolby Digital soundtracks at low output levels. When set to ON, full compression is applied, regardless of volume.



LFE MIX LEVEL allows separate level attenuation of the LFE channel, which is ultimately mixed to the subwoofer output. As the bass from as many as five other channels is added to the LFE, it can significantly raise subwoofer output levels — and create the risk of damage to a system. Careful adjustment of this parameter will allow you to achieve proper tonal balance and reduce the risk of damage.

MASTERLEVEL adjusts the output level of the two-channel downmix. This control should be set to +5dB unless the LFE is very heavy, in which case the level should be reduced.

RE-EQUALIZER equalizes the left, center, and right channel outputs to match the overall frequency balance of the original recording. Without this re-equalization, many films and some television programs will sound too bright.

REAR DELAY OFFSET is an additional delay added to the rear channels when listening to LOGIC 7 and MUSIC SURROUND. This delay increases the apparent size of the listening space by increasing the rear delay time. Feel free to experiment to find the setting that works best.

REAR LEVEL controls the volume level of the rear speakers. Although we have selected a default value, the correct setting will vary with each recording, the room, and your personal taste.

SIDE LEVEL controls the output level of the side speakers. Use this control in conjunction with SURROUND LEVEL to achieve the optimum balance between the side and rear speakers.

SUBWOOFER LVL boosts or cuts the subwoofer output level. Although the normal subwoofer level is set during the calibration procedure, with some recordings it may be desirable to increase or decrease this deep bass level.

SURROUND EX (available as of software version 4) extracts and reproduces the additional rear channel mixed into SURROUND EX encoded soundtracks. This parameter is automatically set to ON when both SIDE and REAR speakers are selected in the SPEAKER CONFIGURATION menu, and will not operate unless SIDE and REAR speakers are selected. SURROUND EX decoding can be engaged during playback of non-SURROUND EX encoded 5.1 material, however, the information delivered to the rear channels may not be pleasing.

SURROUND MIX allows independent adjustment of the level of the surround channels. Many AC-3 encoded soundtracks sound better when down-mixed to two channels with the surround level increased by approximately 2-3dB.

VOCAL ENHANCE boosts dialog in the center channel. By targeting specific frequencies, it can boost only dialog, without raising the entire center channel level (which would alter the output balance achieved during calibration).

**DTS** Effects are compatible with DTS Digital Surround input signals. These effects, along with the PCM Effects described in Chapter 3, and the AC-3 Effects described in Chapter 4, are included in the DTS version of the DC-2. Any DTS-capable software and/or source components should be labeled with a badge, similar to the one on the DC-2 front panel (AC-3 and DTS versions).

This Effect mixes DTS Digital 5.1 information for two-channel playback. These soundtracks can be recorded onto two-channel formats, or played back through left and right front speakers. The mix is designed to play back with full surround when decoded through Logic 7. In mixing a film with very heavy use of the Low Frequency Effects Channel, it may be desirable to lower LFE MIX LEVEL.

## DTS 2-Channel

---

Parameter	Initial Value	Range
CENTER MIX	16	0-30
SURROUND MIX	+2dB	-5 to +5dB
CENTER DLY SAMPLES	+0	-127 to +127
MASTER LEVEL	+5dB	-5dB to +5dB
LFE MIX LEVEL	+0.0dB	-20.0dB to +0.0dB
SUBWOOFER LVL	+00dB	OFF, -30dB to +05dB
CUSTOM		

This Effect enhances playback of DTS music recordings, or DTS film soundtracks with strong musical content. This effect contains many of the features found in DTS LOGIC 7, with settings that are more appropriate for music.

## DTS Music

---

Parameter	Initial Value	Range
RE-EQUALIZER	OFF	ON, OFF
BASS ENHANCE	OFF	ON, OFF
REAR DLY OFFSET	+5ms	0-20ms
SIDE LEVEL	+00dB	OFF, -30dB to +05dB
REAR LEVEL	+00dB	OFF, -30dB to +05dB
LFE MIX LEVEL	-10.0dB	-20.0dB to +0.0dB
SUBWOOFER LVL	+00dB	OFF, -30dB to +05dB
CUSTOM		

## DTS Logic 7

DTS Logic7 combines all the features of DTS Digital with enhancements by Lexicon and LucasFilm. This effect uses Logic 7 matrix technology to enhance the steering between the side speakers and the rear speakers, so sounds intended to come from behind the listener actually do come from behind. This effect also includes the adaptive decorrelation and re-equalizer features of DTS THX.

DTS Logic7 provides the ultimate in film reproduction. It brings out all the increased excitement and spaciousness a 7 channel speaker system can produce.

Parameter	Initial Value	Range
VOCAL ENHANCE	+0.0dB	+0.0dB, +3.0dB, +6.0dB
RE-EQUALIZER	ON	ON, OFF
BASS ENHANCE	OFF	ON, OFF
REAR DELAY OFFSET	5ms	0-20ms
SIDE LEVEL	+00dB	OFF, -30dB to +05dB
REAR LEVEL	+00dB	OFF, -30dB to +05dB
LFE MIX LEVEL	+0.0dB	-20.0dB to +0.0dB
SUBWOOFER LVL	+00dB	OFF, -30dB to +05dB
CUSTOM		

## DTS Film

The DTS Film effect decodes DTS-encoded soundtracks. It uses five discrete full-range channels and a sixth dedicated, Low Frequency Effect (LFE) channel. In this effect, any rear speakers present are connected in parallel with the side speakers. This is the basic DTS effect. It does not include the enhancements by Lexicon or LucasFilm which are available with other AC-3 effects in the DC-2.

Parameter	Initial Value	Range
VOCAL ENHANCE	+0.0dB	+0.0dB, +3.0dB, +6.0dB
RE-EQUALIZER	ON	ON, OFF
BASS ENHANCE	OFF	ON, OFF
SIDE LEVEL	+00dB	OFF, -30dB to +05dB
REAR LEVEL	+00dB	OFF, -30dB to +05dB
LFE MIX LEVEL	+0.0dB	-20.0dB to +0.0dB
SUBWOOFER LVL	+00dB	OFF, -30dB to +05dB
CUSTOM		

This Effect provides THX 5.1 Cinema enhancements for film soundtracks recorded in the DTS format. This processing compensates for the acoustical differences between large mixing theaters and the typically smaller home environment. When SIDE and REAR speakers are selected in the SPEAKER CONFIG menu, SURROUND EX is automatically set to ON for proper decoding of Surround EX soundtracks.

## DTS THX (Including Surround EX)

Parameter	Initial Value	Range
SURROUND EX	ON	ON, OFF
RE-EQUALIZER	ON	ON, OFF
LFE MIX LEVEL	+0.0dB	-20.0dB to 0.0dB
SUBWOOFER LVL	+00dB	OFF, -30dB to +5dB
CUSTOM		

BASS ENHANCE derives stereo bass to provide low frequencies that are noticeably less localizable and more spacious in the playback room.

Note that results will vary depending on room acoustics and the low frequency capacity of the surround speakers. As side and/or rear speakers are used for bass enhancement, the effectiveness is improved with speakers capable of reproducing reproducing low frequencies (LARGE). Using speakers that are not capable of producing low frequencies (<80Hz) may cause damage to them.

## DTS Effect Parameters

CENTER MIX adjusts the level of the center channel applied to the two-annel downmix. The appropriate value for film is 16. The appropriate value for music is 11.

CENTER DLY SAMPLES adjusts the time offset of the center channel. The appropriate value is +0 unless you know that the center channel is not properly timed, as well as the amount by which it is off.

MASTER LEVEL adjusts the output level of the downmix. This control should be set to +5dB unless the LFE is very heavy, in which case the level should be reduced.

LFE MIX LEVEL allows separate level attenuation of the LFE channel, which is ultimately mixed to the subwoofer output. As the bass from as many as five other channels is added to the LFE, it can significantly raise subwoofer output levels — and create the risk of damage to a system. Careful adjustment of this parameter will allow you to achieve proper tonal balance and reduce the risk of damage.

RE-EQUALIZER equalizes the left, center, and right channel outputs to match the overall frequency balance of the original recording. Without this re-equalization, many films and some television programs will sound too bright.

REAR DELAY OFFSET is an additional delay added to the rear channels when listening to LOGIC 7 and MUSIC SURROUND. This delay increases the apparent size of the listening space by increasing the rear delay time. Feel free to experiment to find the setting that works best. SUBWOOFER LVL boosts or cuts the subwoofer output level. Although the normal subwoofer level is set during the calibration procedure, with some recordings it may be desirable to increase or decrease this deep bass level.

REAR LEVEL controls the volume level of the rear speakers. Although we have selected a default value, the correct setting will vary with each recording, the room, and your personal taste.

SIDE LEVEL controls the volume level of the side speakers. Although we have selected a default value, the correct setting will vary with each recording, the room, and your personal taste.

SUBWOOFER LVL boosts or cuts the subwoofer output level. Although the normal subwoofer level is set during the calibration procedure, with some recordings it may be desirable to increase or decrease this deep bass level.

SURROUND EX (available as of software version 4) extracts and reproduces the additional rear channel mixed into SURROUND EX encoded soundtracks. This parameter is automatically set to ON when both SIDE and REAR speakers are selected in the SPEAKER CONFIGURATION menu, and will not operate unless SIDE and REAR speakers are selected. SURROUND EX decoding can be engaged during playback of non-SURROUND EX encoded 5.1 material, however, the information delivered to the rear channels may not be pleasing.

SURROUND MIX allows independent adjustment of the level of the surround channels. Many multichannel-encoded soundtracks sound better when down-mixed to two channels with the surround level increased by approximately 2-3dB.

VOCAL ENHANCE boosts dialog in the center channel. By targeting specific frequencies, it can boost only dialog, without raising the entire center channel level (which would alter the output balance achieved during calibration).

If you encounter a problem, please review the items in the following checklist. Also be sure to thoroughly check all other connected components such as speakers, receiver/amplifier/preamp, VCR, TV, CD player, etc.

## Troubleshooting

Problem	Possible Cause and Solution
Power does not come on	Check line cord to ensure good connection to the AC outlet and to the receptacle on the DC-2 rear panel. Check to make sure that the DC-2 rear panel power switch is ON.
No audio	Check the Status menu (under DISPLAY ADJUST: ON-SCREEN or FRONT PANEL menu — or press and hold Record/Zone 2 on the remote and press OSD ON) to verify that audio is being received.
Remote control not working	Check batteries to be certain that they are inserted correctly with proper polarity. Make sure that the infrared sensor on the DC-2 front panel is not obstructed. See "If all else fails..." on the following page.
No output	<p>Make sure that signal is coming into the DC-2. (Check the Status menu by pressing and holding Record/Zone 2 on the remote, then pressing OSD ON. This menu will display input level meters and sample rate, if applicable.)</p> <p>Increase VOLUME using the remote control and check Front/Back and Left/Right BALANCE.</p> <p>Check the DC-2-MUTE controls to make sure they are not engaged.</p> <p>Check all other equipment settings and connections and verify that the amplifiers being fed by the DC-2 are operational.</p> <p>Remember that the DC-2 mutes the output to any speakers which are not configured in the Setup menu. If speakers are added to (or removed from) your system, the Speaker Configuration menu must be altered accordingly.</p>
Center Channel only plays	Check to see if your HiFi VCR has dropped out of tracking — readjust. Your VCR Stereo/Mono/L-R switch may be in the wrong position — set it to Stereo.
Muffled sound in L&R channels	When no center channel is used, CENTER must be configured for NONE in the Setup Speaker Configuration menu.
Center channel sound muffled	The center channel amp may be connected to the subwoofer jack on the DC-2 rear panel. Reconnect to Center Output jack.
No Input Level Meters	The meters will only appear when adjusting the Gain parameter of a selected, active input, or when the Status menu is displayed.
No Video	Make sure that video cables (particularly S-Video cables) are fully inserted and that the appropriate connector is assigned to the VIDEOIN parameter in the Input Configuration menu.

Problem	Possible Cause and Solution
Hum	<p>Finding and eliminating audio hum in a complex installation can be a very frustrating task. Often, the easiest way to identify the culprit(s) is to systematically eliminate devices from the audio chain. If Cable TV is connected to any component in the system, start by unplugging the Cable completely, preferably right at the wall jack. If this eliminates, or greatly reduces the hum, it is worth a call to your Cable company. A quick fix, assuming your cable is round 75Ω wire, is to attach a 75-300Ω transformer to the end, then attach a 300-75Ω transformer to that, so that the end is back to a round 75Ω wire. There are commercially available antenna lead isolators which may provide additional insulation from electrical surges.</p>
Interference with Radio or TV	<p>The DC-2 does generate minimal amounts of RF energy and is in compliance with FCC rules and CE standards. If some interfering noise is noted, move AM loop and FM "T" type antennas away from the DC-2 and reorient them as necessary. Use shielded cable for FM and TV antenna feeds.</p>
Erratic recall of modes	<p>Severe power surges or sags can confuse the DC-2 memory. To correct, or if you simply want to start over, restore the factory defaults with the procedure described at the end of this section.</p>
If all else fails...	<p>Turn off all amplifiers. Turn the master power switch on the DC-2 rear panel OFF, wait 10 seconds, then turn it ON again. This causes the unit to run a diagnostic self-test routine which takes a couple of seconds. If the DC-2 LCD displays normally at the end of this test, no problems have been found with the DC-2 circuitry. If the internal tests fail, the LCD may display an error message, or no message at all. If this happens, contact your dealer or Lexicon Customer Service.</p> <p>If you find that your custom settings are routinely being corrupted, the lithium battery in the DC-2 may need replacing. This part is not field-replaceable — contact your dealer or Lexicon Customer Service.</p> <p>If the unit is still behaving erratically, perform the Restore Defaults procedure described on the following page.</p> <div data-bbox="581 1598 1429 1717" style="border: 1px solid black; padding: 5px;"> <p><b>Lexicon maintains a knowledge base on its website (<a href="http://www.lexicon.com">www.lexicon.com</a>) where you can find answers to frequently-asked questions and additional troubleshooting information.</b></p> </div>



Other than occasional replacement of the batteries in the remote control, the DC-2 requires minimal maintenance. Use a soft, lint-free cloth slightly dampened with warm water to clean the exterior surfaces of the unit.

**Do not use alcohol, benzene or acetone-based cleaners or any strong commercial cleaners.**

Do not use abrasive materials such as steel wool or metal polish. If the unit is exposed to a dusty environment, a *low-pressure* blower may be used to remove dust from the DC-2 exterior.

## Routine Maintenance

If severe power surges or sags cause problems with normal DC-2 operation, or you simply want to start with a clean slate, you can restore all of the factory defaults with the following procedure.

**This will erase any programs you have stored, as well as all setup and calibration values.**

**Note any settings you want to re-use before proceeding.**

## Restoring Defaults

Turn the DC-2 OFF with the remote. Turn the unit back ON and immediately press and hold MUTE on the remote. (Make sure you do not block the infrared receiver on the DC-2 front panel.) The on-screen display will read:

FACTORY PRESETS MENU

**EXIT**

RESTORE DEFAULTS

If you want to resume normal operation *without* restoring all defaults, this is your last chance. Use MENU ▲ or ▼ to highlight EXIT, then press SELECT.

To restore defaults, use MENU ▲ or ▼ to highlight RESTORE DEFAULTS, then press SELECT. This will clear and reload all preset effects and all factory settings of Volume, Balance, Contrast, Configuration, etc.

When the message FACTORY DEFAULTS RESTORED is displayed, press DONE to return to normal operation. All of the adjustable parameters in the DC-2 have now been reset to the values assigned when it cleared final Quality Control at the factory.

If you cannot solve functional problems through these procedures, consult your dealer or Lexicon Customer Service.

**DO NOT OPEN THE UNIT.  
DOING SO WILL VOID YOUR WARRANTY,  
AND MODIFICATIONS MAY RENDER THE UNIT UNSERVICEABLE.**

---

## Specifications

---

- Inputs:** Audio: 8 stereo (RCA) pairs  
Video: 5 composite (RCA), 5 S-video,  
Digital: 8: 5 coaxial (RCA), 3 optical (TosLink),  
conforms to IEC-958, S/PDIF standards
- Outputs:** Audio: 8 outputs: Left, Center, Right, L&R Sides, L&R Rears, Subwoofer (RCA)  
Video: 2 composite (RCA), 2 S-video
- Audio:** A/D Conversion: 24-bit Delta-Sigma  
D/A Conversion: 24-bit Delta-Sigma  
Frequency Response: 10 Hz – 20 kHz, +0.2dB, -0.3dB, referenced to 1kHz  
THD+Noise: Less than 0.005% @ 1kHz,  
Dynamic Range: 100dB minimum, 22kHz bandwidth, referenced to  
1kHz @ –60dB below maximum output level  
Signal-to-Noise Ratio: 100dB minimum, 22kHz bandwidth, referenced to  
1kHz at maximum output level  
Input Level: 2 Vrms for maximum output  
with Input Gain=0 dB); 200mV rms for Dolby level  
Input Impedance: 100 k $\Omega$  in parallel with 150pF  
Output Level: 6Vrms (System Volume = +12dB)  
Output Impedance: 100 $\Omega$  in parallel with 150pF
- Video:** NTSC M, PAL and SECAM-compatible  
Output Level: 1 V peak-to-peak  
Impedance: 75 $\Omega$   
Video Signal-to-Noise Ratio: 70dB  
Bandwidth: 10MHz
- Power Requirements:** 90–250 VAC, 50-60Hz, 35 Watts (universal input);  
IEC detachable power cord
- Dimensions: 17.3"W x 11.5"D x 3.6"H (440 x 292 x 92mm);  
Rack mounted: 19.0"W x 11.5"D x 3.5"H (483 x 292 x 89mm)  
Weight: 11.25 lbs. (5.11kg)
- Environment:** Operating Temperature: 32° to 95°F (0° to 35°C)  
Storage Temperature.: –22° to 167°F (–30° to 75°C)  
Relative Humidity: 95% max without condensation
- Remote Control:** Hand-held, battery-powered infrared remote control unit, uses 2 AA batteries

*Specifications subject to change without notice.*

# Installation Worksheet

Model/Serial # \_\_\_\_\_ / \_\_\_\_\_

Installed by \_\_\_\_\_ Phone \_\_\_\_\_ Date \_\_\_\_\_

Inputs			
<b>VCR</b>	Gain _____ Name _____	PCM FX _____ AC-3 FX _____ DTS FX _____	Audio In _____ Video In _____ Trigger: <input type="checkbox"/> enabled <input type="checkbox"/> disabled
		FX Format: <input type="checkbox"/> Auto <input type="checkbox"/> PCM <input type="checkbox"/> AC-3 <input type="checkbox"/> DTS	Rec/Zone2: <input type="checkbox"/> Analog <input type="checkbox"/> Digital <input type="checkbox"/> Blocked
<b>DVD</b>	Gain _____ Name _____	PCM FX _____ AC-3 FX _____ DTS FX _____	Audio In _____ Video In _____ Trigger: <input type="checkbox"/> enabled <input type="checkbox"/> disabled
		FX Format: <input type="checkbox"/> Auto <input type="checkbox"/> PCM <input type="checkbox"/> AC-3 <input type="checkbox"/> DTS	Rec/Zone2: <input type="checkbox"/> Analog <input type="checkbox"/> Digital <input type="checkbox"/> Blocked
<b>V-DISC</b>	Gain _____ Name _____	PCM FX _____ AC-3 FX _____ DTS FX _____	Audio In _____ Video In _____ Trigger: <input type="checkbox"/> enabled <input type="checkbox"/> disabled
		FX Format: <input type="checkbox"/> Auto <input type="checkbox"/> PCM <input type="checkbox"/> AC-3 <input type="checkbox"/> DTS	Rec/Zone2: <input type="checkbox"/> Analog <input type="checkbox"/> Digital <input type="checkbox"/> Blocked
<b>TV</b>	Gain _____ Name _____	PCM FX _____ AC-3 FX _____ DTS FX _____	Audio In _____ Video In _____ Trigger: <input type="checkbox"/> enabled <input type="checkbox"/> disabled
		FX Format: <input type="checkbox"/> Auto <input type="checkbox"/> PCM <input type="checkbox"/> AC-3 <input type="checkbox"/> DTS	Rec/Zone2: <input type="checkbox"/> Analog <input type="checkbox"/> Digital <input type="checkbox"/> Blocked
<b>AUX</b>	Gain _____ Name _____	PCM FX _____ AC-3 FX _____ DTS FX _____	Audio In _____ Video In _____ Trigger: <input type="checkbox"/> enabled <input type="checkbox"/> disabled
		FX Format: <input type="checkbox"/> Auto <input type="checkbox"/> PCM <input type="checkbox"/> AC-3 <input type="checkbox"/> DTS	Rec/Zone2: <input type="checkbox"/> Analog <input type="checkbox"/> Digital <input type="checkbox"/> Blocked
<b>CD</b>	Gain _____ Name _____	PCM FX _____ AC-3 FX _____ DTS FX _____	Audio In _____ Video In _____ Trigger: <input type="checkbox"/> enabled <input type="checkbox"/> disabled
		FX Format: <input type="checkbox"/> Auto <input type="checkbox"/> PCM <input type="checkbox"/> AC-3 <input type="checkbox"/> DTS	Rec/Zone2: <input type="checkbox"/> Analog <input type="checkbox"/> Digital <input type="checkbox"/> Blocked
<b>TUNER</b>	Gain _____ Name _____	PCM FX _____ AC-3 FX _____ DTS FX _____	Audio In _____ Video In _____ Trigger: <input type="checkbox"/> enabled <input type="checkbox"/> disabled
		FX Format: <input type="checkbox"/> Auto <input type="checkbox"/> PCM <input type="checkbox"/> AC-3 <input type="checkbox"/> DTS	Rec/Zone2: <input type="checkbox"/> Analog <input type="checkbox"/> Digital <input type="checkbox"/> Blocked
<b>TAPE</b>	Gain _____ Name _____	PCM FX _____ AC-3 FX _____ DTS FX _____	Audio In _____ Video In _____ Trigger: <input type="checkbox"/> enabled <input type="checkbox"/> disabled
		FX Format: <input type="checkbox"/> Auto <input type="checkbox"/> PCM <input type="checkbox"/> AC-3 <input type="checkbox"/> DTS	Rec/Zone2: <input type="checkbox"/> Analog <input type="checkbox"/> Digital <input type="checkbox"/> Blocked

**OSD Position:**  bottom  center  top      **Status:**  always on  2 sec. time out  always off

**Calibrate Panorama**  
Speaker Listener Angle \_\_\_\_\_°      Listener Position \_\_\_\_\_

**Speaker Configuration** (circle selection)

<b>FRONT</b>	LG	SM	40	80	120				
<b>CENTER</b>	LG	SM	NONE	40	80	120			
<b>SIDES</b>	LG STD	LG DIP	SM STD	SM DIP	NONE	40	80	120	
<b>REARS</b>	LG	SM	NONE	40	80	120			
<b>SUBWFR</b>	YES	NO	OFF	40	80	120			

**Sub Pk Limit** \_\_\_\_\_  
**Mute Level** \_\_\_\_\_  
**Pwr-On Vol** \_\_\_\_\_  
**Z-2 Pwr-On** \_\_\_\_\_  
**A/V Sync Delay** \_\_\_\_\_

Output Level	Speaker Distance
<b>Nearest Speaker</b> _____	
L. Front _____ dB	_____
Center _____ dB	_____
R. Front _____ dB	_____
R. Side _____ dB	_____
R. Rear _____ dB	_____
L. Rear _____ dB	_____
L. Side _____ dB	_____
Sub _____ dB	_____

## Free Manuals Download Website

<http://myh66.com>

<http://usermanuals.us>

<http://www.somanuals.com>

<http://www.4manuals.cc>

<http://www.manual-lib.com>

<http://www.404manual.com>

<http://www.luxmanual.com>

<http://aubethermostatmanual.com>

Golf course search by state

<http://golfingnear.com>

Email search by domain

<http://emailbydomain.com>

Auto manuals search

<http://auto.somanuals.com>

TV manuals search

<http://tv.somanuals.com>