

# Leica DISTO™ D3

The original laser distance meter



**Leica DISTO™**  
**3** Years  
Warranty  
if registered within 8 weeks after  
purchase at [www.disto.com](http://www.disto.com)

- when it has to be **right**

**Leica**  
Geosystems

Download from [Www.Somanuals.com](http://Www.Somanuals.com). All Manuals Search And Download.

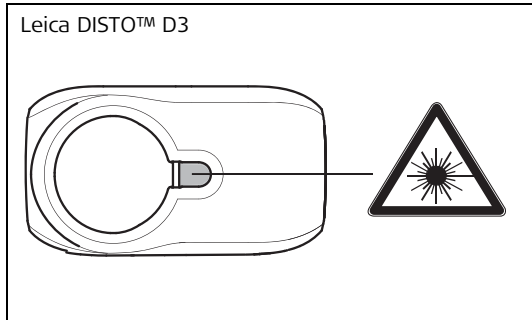

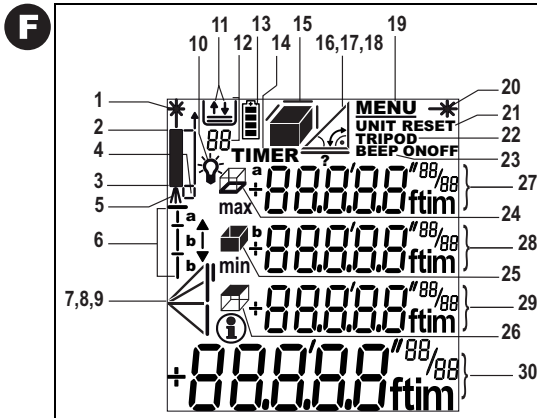
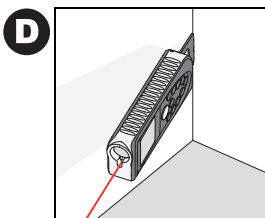
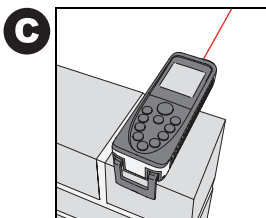
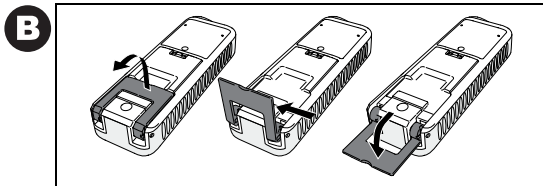
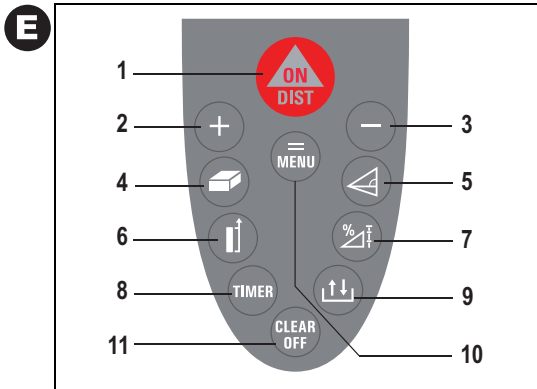
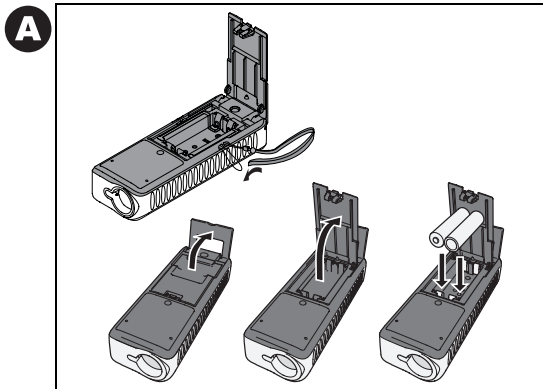



# User Manual

## English

Congratulations on the purchase of your Leica DISTO™ D3 .



Carefully read the Safety Instructions and the User Manual before using this product.

The person responsible for the instrument must ensure that all users understand these directions and adhere to them.

## Contents

Safety Instructions .....	1
Start-up.....	5
Menu functions.....	7
Operation.....	8
Measuring .....	9
Functions .....	10
Appendix.....	15

## Safety Instructions

EN

### Symbols used

The symbols used in the Safety Instructions have the following meanings:



#### **WARNING:**

Indicates a potentially hazardous situation or an unintended use which, if not avoided, will result in death or serious injury.



#### **CAUTION:**

Indicates a potentially hazardous situation or an unintended use which, if not avoided, may result in minor injury and/or in appreciable material, financial and environmental damage.



Important paragraphs which must be adhered to in practice as they enabled the product to be used in a technically correct and efficient manner.

### Use of the instrument

#### Permitted use

- Measuring distances
- Computing functions, e. g. areas and volumes
- Measuring tilts

#### Prohibited use

- Using the instrument without instruction
- Using outside the stated limits
- Deactivation of safety systems and removal of explanatory and hazard labels

- Opening of the equipment by using tools (screwdrivers, etc.), as far as not specifically permitted for certain cases
- Carrying out modification or conversion of the product
- Use after misappropriation
- Use of accessories from other manufacturers without the express approval of Leica Geosystems.
- Deliberate or irresponsible behaviour on scaffolding, when using ladders, when measuring near machines which are running, or near parts of machines or installations which are unprotected
- Aiming directly into the sun
- Deliberate dazzling of third parties; also in the dark
- Inadequate safeguards at the surveying site (e.g. when measuring on roads, construction sites, etc.)

## Limits of use



See section "Technical Data".

The Leica DISTO™ is designed for use in areas permanently habitable by humans, do not use the product in explosion hazardous areas or in aggressive environments.

## Areas of responsibility

### Responsibilities of the manufacturer of the original equipment Leica Geosystems AG, CH-9435 Heerbrugg (for short Leica Geosystems):

Leica Geosystems is responsible for supplying the product, including the User Manual and original accessories, in a completely safe condition. (additional language versions can be found at:

**www.disto.com.**

### Responsibilities of the manufacturer of non-Leica accessories:

 The manufacturers of non-Leica accessories for the Leica DISTO™ are responsible for developing, implementing and communicating safety concepts for their products. They are also responsible for the effectiveness of these safety concepts in combination with the Leica Geosystems equipment.

### Responsibilities of the person in charge of the instrument:

#### **WARNING**

The person responsible for the instrument must ensure that the equipment is used in accordance with the instructions. This person is also accountable for the deployment of personnel and for their training and for the safety of the equipment when in use.

The person in charge of the instrument has the following duties:

- To understand the safety instructions on the product and the instructions in the User Manual.
- To be familiar with local safety regulations relating to accident prevention.
- To inform Leica Geosystems immediately if the equipment becomes unsafe.

## Hazards in use



### CAUTION:

Watch out for erroneous distance measurements if the instrument is defective or if it has been dropped or has been misused or modified.

### Precautions:

Carry out periodic test measurements. Particularly after the instrument has been subject to abnormal use, and before, during and after important measurements.

Make sure the Leica DISTO™ optics is kept clean and that there is no mechanical damage to the bumpers.



### CAUTION:

In using the instrument for distance measurements or for positioning moving objects (e.g. cranes, building equipment, platforms, etc.) unforeseen events may cause erroneous measurements.

### Precautions:

Only use this product as a measuring sensor, not as a control device. Your system must be configured and operated in such a way, that in case of an erroneous measurement, malfunction of the device or power failure due to installed safety measures (e.g. safety limit switch), it is assured that no damage will occur.



### WARNING:

Flat batteries must not be disposed of with household waste. Care for the environment and take them to the collection points provided in accordance with national or local regulations.



The product must not be disposed of with household waste.

Dispose of the product appropriately in accordance with the national regulations in force in your country.

Always prevent access to the product by unauthorized personnel.

Product specific treatment and waste management information can be downloaded from the Leica Geosystems home page at <http://www.leica-geosystems.com/treatment> or received from your Leica Geosystems dealer.

## Electromagnetic Compatibility (EMC)

The term "electromagnetic compatibility" is taken to mean the capability of the product to function smoothly in an environment where electromagnetic radiation and electrostatic discharges are present, and without causing electromagnetic interference to other equipment.



### WARNING:

The Leica DISTO™ conforms to the most stringent requirements of the relevant standards and regulations. Yet, the possibility of it causing interference in other devices cannot be totally excluded.

**CAUTION:**

Never attempt to repair the product yourself. In case of damage, contact the local dealership.

## FCC statement (applic. in U.S.)

This equipment has been tested and found to comply with the limits for a Class B digital device, pursuant to part 15 of the FCC Rules. These limits are designed to provide reasonable protection against harmful interference in a residential installation.

This equipment generates, uses and can radiate radio frequency energy and, if not installed and used in accordance with the instructions, may cause harmful interference to radio communications.

However, there is no guarantee that interference will not occur in a particular installation.

If this equipment does cause harmful interference to radio or television reception, which can be determined by turning the equipment off and on, the user is encouraged to try to correct the interference by one or more of the following measures:

- Reorient or relocate the receiving antenna.
- Increase the separation between the equipment and receiver.
- Connect the equipment into an outlet on a circuit different from that to which the receiver is connected.
- Consult the dealer or an experienced radio/TV technician for help

**WARNING:**

Changes or modifications not expressly approved by Leica Geosystems for compliance could void the user's authority to operate the equipment.

## Laser classification

### Integrated distancemeter

The Leica DISTO™ produces a visible laser beam which emerges from the front of the instrument. It is a Class 2 laser product in accordance with:

- IEC60825-1 : 2007 "Radiation safety of laser products"

### Laser Class 2 products:

Do not stare into the laser beam or direct it towards other people unnecessarily. Eye protection is normally afforded by aversion responses including the blink reflex.

**WARNING:**

Looking directly into the beam with optical aids (e.g. binoculars, telescopes) can be hazardous.

### Precautions:

Do not look directly into the beam with optical aids.

**CAUTION:**

Looking into the laser beam may be hazardous to the eyes.

### Precautions:

Do not look into the laser beam. Make sure the laser is aimed above or below eye level. (particularly with fixed installations, in machines, etc.)



## Labelling

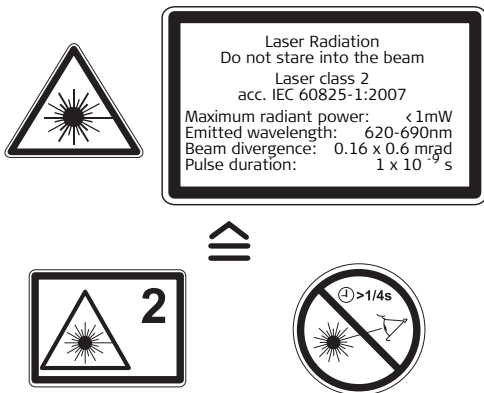



Position of the product label see last page!

## Start-up

### Inserting/replacing batteries

See figure {A}

- 1 Remove battery compartment lid and attach handstrap.
- 2 Insert batteries, observing correct polarity.
- 3 Close the battery compartment again. Replace the batteries when the symbol  flashes permanently in the display.

-  Use alkaline batteries only.
-  Remove the batteries before any long period of non-use to avoid the danger of corrosion.

### Multifunctional endpiece

See figure {B}

The instrument can be adapted for the following measuring situations:

- For measurements from an edge, fold out the positioning bracket until it first locks in place. See figure {C}.
- For measurements from a corner, open the positioning bracket until it locks in place, then push the positioning bracket lightly to the right to fold it out fully. See figure {D}.

A built-in sensor automatically detects the orientation of the positioning bracket and adjusts the zero point of the instrument accordingly.

## Keypad

See figure {E}:

- 1 **ON / DIST (On/measuring) button**
- 2 **Plus (+) button**
- 3 **Minus (-) button**
- 4 **Area / volume button**
- 5 **Indirect measurement (Pythagoras) button**
- 6 **Reference button**
- 7 **Functions button**
- 8 **Timer button**
- 9 **Storage button**
- 10 **Menu/equal button**
- 11 **Clear/off button**

## Display

See figure {F}

- 1 Laser active
- 2 Reference (front)
- 3 Reference (rear)
- 4 Reference (corner stop)
- 5 Measuring with the tripod
- 6 Stake out function
- 7 Single Pythagorean measurement
- 8 Double Pythagorean measurement
- 9 Double (partial height) measurement
- 10 Illumination

- 11 Save constant value, call up constant value
- 12 Historical memory, call up values
- 13 Battery status
- 14 Timer
- 15 Area/volume
- 16 Tilt
- 17 Horizontal distance measurement using tilt
- 18 Room corner angle function
- 19 Menu
- 20 Continuous laser
- 21 Reset
- 22 Reference (tripod)
- 23 Beep
- 24 Circumference
- 25 Wall area
- 26 Ceiling area
- 27 Intermediate line 1
- 28 Intermediate line 2
- 29 Intermediate line 3
- 30 Summary line

## Menu functions

### Settings

The menu allows settings to be altered and permanently stored. After switching off the device or replacing the batteries the settings are stored.



### Navigation in the menu

The menu allows settings to be made at the user level. The instrument can be specifically configured to your personal requirements.

### General description

 button (pressed **long**) brings up the **MENU**, the set units and the **UNIT** symbol are displayed.

 button (pressed **short**) pages through each menu item. See figure {G}.

 or  button to make changes in menu items.

 button (pressed **short**) brings up the next menu item.

A long press on the  button in the menu confirms the new settings made in the submenu items .

Pressing the  button **for longer** in the menu allows you to quit the settings function without saving.

## Setting the unit for distance measurements

The following units can be set:

	Distance	Area	Volume
1.	0.000 m	0.000 m <sup>2</sup>	0.000 m <sup>3</sup>
2.	0.000 <sup>0</sup> m	0.000 m <sup>2</sup>	0.000 m <sup>3</sup>
3.	0.00 m	0.000 m <sup>2</sup>	0.000 m <sup>3</sup>
4.	0.00 ft	0.00 ft <sup>2</sup>	0.00 ft <sup>3</sup>
5.	0'00'' $\frac{1}{32}$	0.00 ft <sup>2</sup>	0.00 ft <sup>3</sup>
6.	0'00'' $\frac{1}{16}$	0.00 ft <sup>2</sup>	0.00 ft <sup>3</sup>
7.	0'00'' $\frac{1}{8}$	0.00 ft <sup>2</sup>	0.00 ft <sup>3</sup>
8.	0.0 in	0.00 ft <sup>2</sup>	0.00 ft <sup>3</sup>
9.	0 $\frac{1}{32}$ in	0.00 ft <sup>2</sup>	0.00 ft <sup>3</sup>
10.	0 $\frac{1}{16}$ in	0.00 ft <sup>2</sup>	0.00 ft <sup>3</sup>
11.	0 $\frac{1}{8}$ in	0.00 ft <sup>2</sup>	0.00 ft <sup>3</sup>

## Setting the unit for tilt measurements

The following units can be set for tilt measurements:

	Units for tilt
1.	+/- 0.0°
2.	0.00%

## Beep (BEEP)

You can switch the beep on or off.

## Continuous laser ( )

You can switch the continuous laser function on or off.

With the continuous laser function set on, each press of the  button triggers a measurement. The laser automatically switches off after 15 minutes.

## Measuring with the tripod ( **TRIPOD** )

The reference must be appropriately adjusted in order to be able to take correct measurements with a tripod. To do this select the **TRIPOD** symbol in this menu item. You can switch the reference on the tripod on or off. The setting can be seen on the display .

## Display - keypad illumination ( )

Automatic illumination of the display and the keypad can be switched on or off.

## Reset - returning the instrument to the factory settings ( **RESET** )

The instrument has a **RESET** function. When you select the menu function **RESET** and confirm, the instrument defaults to the factory settings.

A reset returns the following values to their factory settings:

- Reference (rear)
- Display illumination (ON)
- Beep (ON)
- Unit (m(mm))
- Stack and memory are erased

 All customised settings and stored values are also lost.

## Operation

### Switching on and off



Switches on the instrument and laser. The display shows the battery symbol until the next button is pressed.



Pressing this button for longer switches the instrument off.

The instrument switches off automatically after 6 minutes of inactivity.

### CLEAR button





The last action is cancelled. While making area or volume measurements, each single measurement can be deleted and remeasured in series.

## Display / keypad illumination

The instrument has a sensor that automatically switches the display and keypad illumination on or off in response to lighting conditions.

## Reference setting

The default reference setting is from the rear of the instrument.

 Press this button to take the next measurement from the front edge . A special beep sounds whenever the reference setting is changed.

After a measurement the reference returns automatically to the default setting (rear reference). See figure {H}.

 Press this button for **longer** the front reference is set permanently.

 Press this button, the rear reference is set again.

## Measuring

### Single distance measurement

 Press to activate the laser. Press again to trigger the distance measurement.

The result is displayed immediately.

### Minimum/maximum measurement

This function allows the user to measure the minimum or maximum distance from a fixed measuring point. It can also be used as to determine spacings. See figure {I}

It is commonly used to measure room diagonals (maximum values) or horizontal distances (minimum values).

 Press and hold down this button until you hear a beep. Then slowly sweep the laser back and forth and up and down over the desired target point - (e.g. into the corner of a room).

 Press to stop continuous measurement. The values for maximum and minimum distances are shown in the display as well as the last measured value in the summary line.

## Functions

### Addition / subtraction

Distance measuring.

 The next measurement is added to the previous one.

 The next measurement is subtracted from the previous one.

This process can be repeated as required. The result is always shown in the summary line with the previous value in the second line.

 The last step is cancelled.

### Area

 Press **once**. The  symbol appears in the display.

 Press this button to take the first length measurement (e.g. length).

 Press it again to take the second length measurement (e.g. width).

The result is displayed in the summary line.

Press the  button **for longer** to calculate the circumference.

### Volume

 Press this button **twice**. The  symbol

appears in the display.

 Press this button to take the first length measurement (e.g. length).

 Press this button to take the second length measurement (e.g. width).

 Press this button to take the third length measurement (e.g. height). The value is shown in the second line.



The volume then appears in the summary line.

Press the  button **for longer** to display additional room information such as ceiling/floor area, surface area of the walls, circumference.

### Tilt measurement



 The inclination sensor measures tilts between  $\pm 45^\circ$ .

 During tilt measurement the instrument should be hold without a transverse tilt ( $\pm 10^\circ$ ).

 Press this button **once** to activate the tilt sensor. The  symbol appears in the display. The tilt is continuously shown as  $^\circ$  or % depending on the setting.

 Press to measure the inclination and the distance. See figure {J}.



## Direct horizontal distance

 Press this button **twice** and the following symbol appears in the display .

 Press this button to measure tilt and distance. The summary line displays the result as the direct horizontal distance.

## Room corner angle function

The angles in a triangle can be calculated by measuring the three sides. This function can be used e. g. to check a right-angled room corner. See figure {K}.

 Press this button **three times** and the room corner symbol appears in the display .

Mark the reference points to the right and left (d1/ d2) of the angle to be measured.

 Press this button to measure the first (short) side of the triangle (d1 or d2).

 Press this button to measure the second (short) side of the triangle (d1 or d2).

 Press this button to measure the third (long) side of the triangle (d3).



The result is displayed in the summary line as the room corner angle.

## Stake out function



Two different distances (a and b) can be entered into the instrument and can then be used to mark off defined measured lengths, e.g. in the construction of wooden frames.

See figure {L}.



Entering stake out distances:

 Press this button **four times** and the stake out function symbol appears in the display .

The value (a) and the corresponding intermediate line flash.

By using  and , you can adjust the values (first a and then b) to suit the desired stake out distances. Holding the buttons down increases the rate of change of the values.

Once the desired value (a) has been reached it can be confirmed with the .

The value (b) and the intermediate line flashes (the defined value (a) is automatically adopted). Value (b) can be entered using  and .

The defined value (b) is confirmed with the  button.

Pressing the  button starts the laser measurement. The display shows required stake out distance

in the summary line between the stake out point (first a and then b) and the instrument (rear reference).

If the DISTO™ is then moved slowly along the stake out line the displayed distance decreases. The instrument starts to beep at a distance of 0.1m from the next stake out point.

The arrows in the display  indicate in which direction the DISTO™ needs to be moved in order to achieve the defined distance (either a or b). As soon as the stake out point is reached the beep changes and the intermediate line starts to flash.

The function can be stopped at any time by pressing the  button.

## Indirect measurement

The instrument can calculate distances using Pythagoras' theorem.

This method is especially helpful if the distance to be measured is difficult to reach.

 Make sure you adhere to the prescribed sequence of measurement:

- All target points must be in a horizontal or vertical plane.
- The best results are achieved when the instrument is rotated about a fixed point (e.g. with the

positioning bracket fully folded out and the instrument placed on a wall).



- The minimum/maximum function can be used - see explanation in "Measuring -> Minimum/maximum measurement". The minimum value must be used for measurements at right angles to the target; the maximum distance for all other measurements.

 Make sure that the first measurement and the distance to be measured are at right angles. Use the Minimum/maximum function, as explained in "Measuring -> Minimum/maximum measurement".

## Indirect measurement - determining a distance using 2 auxilliary measurements

See figure {M}

e.g. for measuring building heights or widths. It is helpful to use a tripod when measuring heights that require the measurement of two or three measurements.

 Press this button **once**, the display shows . The laser is switched on.

 Aim at the upper point (1) and trigger the measurement. After the first measurement the value is adopted. Keep the instrument as horizontal as possible.

 Press and hold down this button to trigger





continuous measurement, sweep the laser back and forth and up and down over the ideal target point.

 Press to stop continuous measurement (2). The result is displayed in the summary line, the partial results in the secondary line.

### Indirect Measurement - determining a distance using 3 measurements

See figure {N}

 Press this button **twice**; the display shows the following symbol . The laser is switched on.

 Aim at the upper point (1) and trigger the measurement. After the first measurement the value is adopted. Keep the instrument as horizontal as possible

 Press and hold down this button to trigger continuous measurement, sweep the laser back and forth and up and down over the ideal target point.



 Press to stop continuous measurement (2). The value is adopted. Aim at the lower point and

 Press this button to trigger the measurement (3). The result is displayed in the summary line, the partial results in the secondary lines.

### Indirect measurement - determining a chain value using 3 measurements

See figure {O}

e.g. determining the height between point 1 and point 2 using three target points.

 Press this button **three times** ; the display shows the following symbol . The laser is switched on.

Aim at the upper point (1).

 Press this button and trigger the measurement. After the first measurement the value is adopted. The display flashes (2).

 Triggers the measurement. After the second measurement the value is adopted. The display flashes (3).

 Press and hold down this button to trigger continuous measurement. Sweep the laser back and forth and up and down over the ideal target point.



 Press this button to end continuous measurement. The result is displayed in the summary line, the partial results in the secondary lines.

## Storage of constants/historical storage

### Storage of a constant

You can store and recall a frequently used value e.g. height of a room. Measure the desired distance, press and hold the  button until the device beeps to confirm storage.

### Recalling the constant

 Press this button **once** to recall the constant and make it available for further calculations by pressing button .

### Historical storage

 Press this button **twice** and the previous 20 results (measurements or calculated results) are shown in reverse order.

The  and  buttons can be used for navigation.

 Press this button to use a result from the summary line for further calculations.

Pressing the  and  buttons at the same time erases all the values in historical storage.

## Timer (self-triggering)

 Press this button to set a 5-second time delay.  
or

 Press and hold down this button until the desired time delay is reached (max. 60 seconds).

Once the key is released the remaining seconds until measurement (e.g. 59, 58, 57...) are displayed in a countdown. The last 5 seconds are counted down with a beep. After the last beep the measurement is taken and the value is displayed.

 The timer can be used for all measurements.

## Appendix

### Message codes

All message codes are displayed with either  or "Error". The following errors can be corrected:

	Cause	Remedy
156	Transverse tilt greater than 10°	Hold the instrument without any transverse tilt
160	Main tilt direction, angle too high (> 45°)	Measure angle up to max. ± 45°
204	Calculation error	Repeat procedure
252	Temperature too high	Cool down instrument
253	Temperature too low	Warm up instrument
255	Receiver signal too weak, measurement time too long, distance > 100 m	Use target plate
256	Received signal too strong	Target too reflective (use target plate)
257	Wrong measurement, background brightness too high	Darken target (measure in different lighting conditions)
260	Laser beam interrupted	Repeat measurement

Error	Cause	Remedy
Error	Hardware error	Switch on/off the device several times. If the symbol still appears, then your instrument is defective. Please call your dealer for assistance.

### Technical data

<b>Distance measurements:</b> Measuring accuracy up to 30 m (2 $\sigma$ , standard deviation)	typically: ± 1.5 mm* ± 1/16 ""*
Power Range Technology™: Range (use target plate from about 80m)	0.05 m to 100 m
Smallest unit displayed	0.1 mm
Distance measurement	✓
Minimum/maximum measurement, Continuous measurement	✓
Area/volume calculation of room data	✓
Addition / subtraction	✓
Indirect measurement using Pythagoras	✓

<b>Tilt measurements:</b> Tilt sensor: Accuracy (2 $\sigma$ , standard deviation) - to laser beam - to the housing	$\pm 0.3^\circ$ $\pm 0.3^\circ$
Indirect measurement using tilt sensor (direct horizontal distance)	✓
Angle measurement using tilt sensor ( $\pm 45^\circ$ )	✓
<b>General:</b> Laser class	II
Laser type	635 nm, < 1 mW
$\emptyset$ laser point (at distances)	6 / 30 / 60 mm (10 / 50 / 100 m)
Autom. laser switch-off	after 3 min
Autom. instrument switch-off	after 6 min
Display illumination	✓
Keypad illumination	✓
Multifunctional endpiece	✓
Timer (self-triggering)	✓
Save constant value	✓
Historical storage (20 values)	✓
Tripod thread	✓
Battery life, Type AAA, 2 x 1.5V	up to 5 000 measurements
Protection against splashes and dust	IP 54, dust-proof, splash-proof

Dimensions	125 x 45 x 25 mm
Weight (with batteries)	110 g
Temperature range: Storage	-25°C up to +70°C (13°F up to +158°F) -10°C up to +50°C (14°F up to +122°F)
Operation	

\* maximum deviation occurs under unfavourable conditions such as bright sunlight or when measuring to poorly reflecting or very rough surfaces. Measuring accuracy may deteriorate by approx.  $\pm 0.1$  mm/m for distances above 30 m.

## Measuring conditions

### Measuring range

The range is limited to 100 m.

At night or dusk and if the target is in shadow the measuring range without target plate is increased.

Use a target plate to increase the measurement range during daylight or if the target has poor reflection properties.

### Target surfaces

Measuring errors can occur when measuring toward colourless liquids (e.g. water) or dust free glass, Styrofoam or similar semi-permeable surfaces.

Aiming at high gloss surfaces may deflect the laser beam and lead to measurement errors.

Against non-reflective and dark surfaces the measuring time may increase.

---

## Care

Do not immerse the instrument in water. Wipe off dirt with a damp, soft cloth. Do not use aggressive cleaning agents or solutions. Handle the instrument as you would a telescope or camera.

---

## Warranty

The Leica DISTO™ D3 comes with a three\* year warranty from Leica Geosystems AG.

More detailed information can be found at:

**[www.disto.com](http://www.disto.com)**

All illustrations, descriptions and technical specifications may be subject to change without prior notice.

\* To receive the three year warranty, the product must be registered on our website **[www.disto.com](http://www.disto.com)** within eight weeks of the purchase date. If the product is not registered, a two year warranty applies.





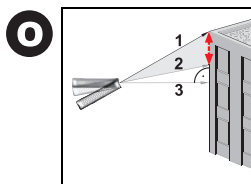
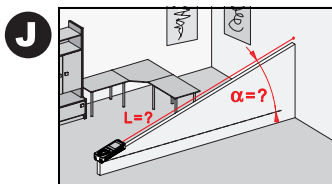
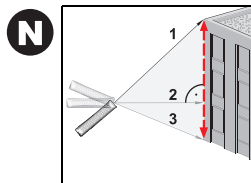
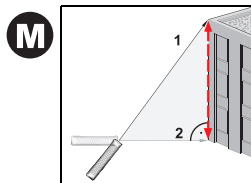
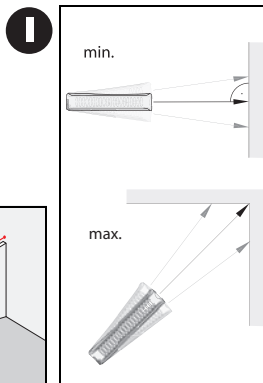
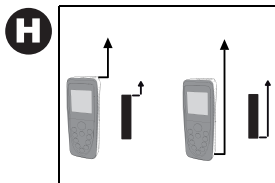
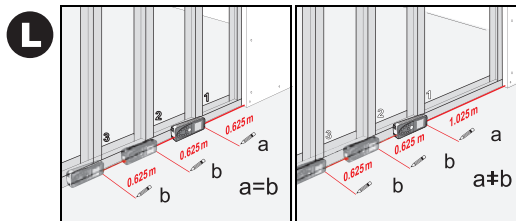
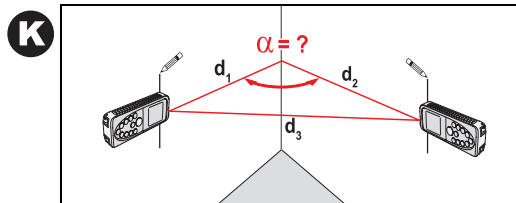
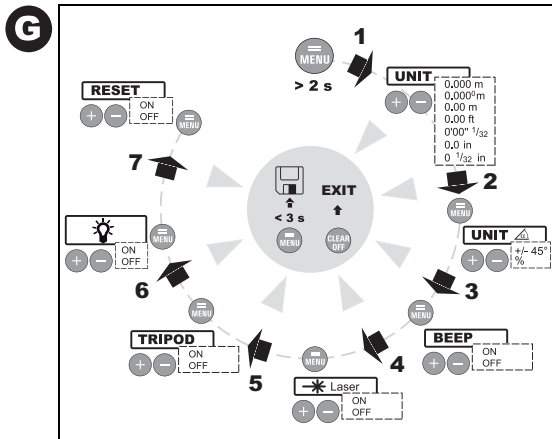





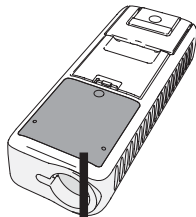



# Leica DISTO™ D3





 

*Complies with 21 CFR 1040.10 and 1040.11  
except for deviations pursuant to Laser Notice  
No. 50, dated July 26, 2001.*

   **SWISS Technology**  
*by Leica Geosystems*

PATENTS: *WO 0427164* *US 5968531*  
*WO 0218964* *WO 0244754*  
*EP 1196617* *WO 9818019* 

Type: Leica DISTO™ D3

Power: 3V<sub>batt</sub>/0.3A  

Made in Austria [www.leica-geosystems.com](http://www.leica-geosystems.com)



Leica Geosystems AG, Heerbrugg, Switzerland has been certified as being equipped with a quality system which meets the International Standards of Quality Management and Quality Systems (ISO standard 9001) and Environmental Management Systems (ISO standard 14001).

Total Quality Management - Our commitment to total customer satisfaction. Ask your local Leica Geosystems agent for more information about our TQM program.

Printed in Switzerland - Copyright Leica Geosystems AG, Heerbrugg, Switzerland 2007  
Translation of original text (760150)

Pat. No.: WO 9427164, WO 9818019, WO 0244754, WO 0216964,  
US 5949531, EP 1195617, US 7030969, WO 03104748



Leica Geosystems AG  
CH-9435 Heerbrugg  
(Switzerland)  
[www.disto.com](http://www.disto.com)

- when it has to be **right**

**Leica**  
**Geosystems**

Download from [Www.Somanuals.com](http://Www.Somanuals.com). All Manuals Search And Download.

## Free Manuals Download Website

<http://myh66.com>

<http://usermanuals.us>

<http://www.somanuals.com>

<http://www.4manuals.cc>

<http://www.manual-lib.com>

<http://www.404manual.com>

<http://www.luxmanual.com>

<http://aubethermostatmanual.com>

Golf course search by state

<http://golfingnear.com>

Email search by domain

<http://emailbydomain.com>

Auto manuals search

<http://auto.somanuals.com>

TV manuals search

<http://tv.somanuals.com>