

Leica Lino

L360, L2P5, L2+, L2G+, L2, P5, P3



- when it has to be **right**

Download from www.somanuals.com. All Manuals Search And Download.

Leica
Geosystems

User Manual

Version 757665i

English

Congratulations on your purchase of the Leica Lino.



The safety instructions follow the section on how to operate the instrument. Before starting up the instrument for the first time, please read through the entire User Manual paying special attention to the section Safety Instructions .

Contents

Start up	1
Operation.....	3
Technical data	12
Safety instructions	14

Start up

Inserting / replacing batteries

Slide the locking button forwards to unlock the battery compartment. Open the battery compartment cover and insert the batteries, observing the correct polarity. Then press the battery compartment cover back down until it engages.

The battery symbol  lights up when the battery voltage is too low. Replace the batteries as soon as possible.

- Insert the batteries observing the correct polarity
- Use alkaline batteries or rechargeable batteries only
- Remove the batteries if the instrument is not to be used for a long period of time (to prevent corrosion)

en

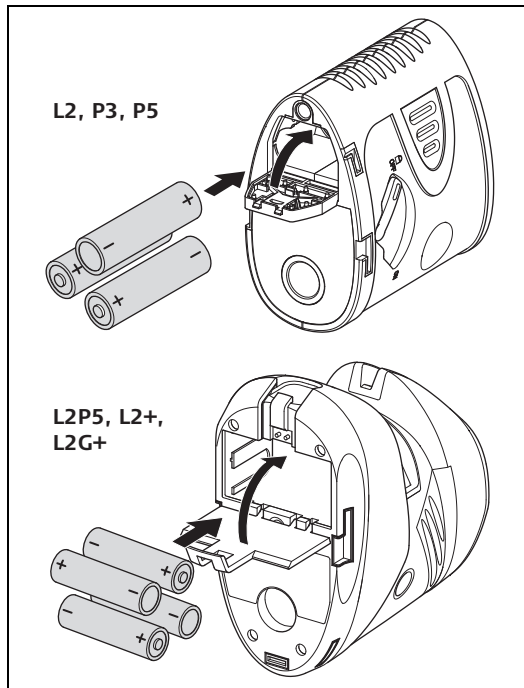

Charging / first-time use

- The battery must be charged prior to first use because it is delivered with as low an energy content as possible.
- The permissible temperature range for charging is between 0°C and +40°C/+32°F and +104°F. For optimal charging we recommend charging the batteries at a low ambient temperature of +10°C to +20°C/+50°F to +68°F if possible.
- It is normal for the battery to become warm during charging.

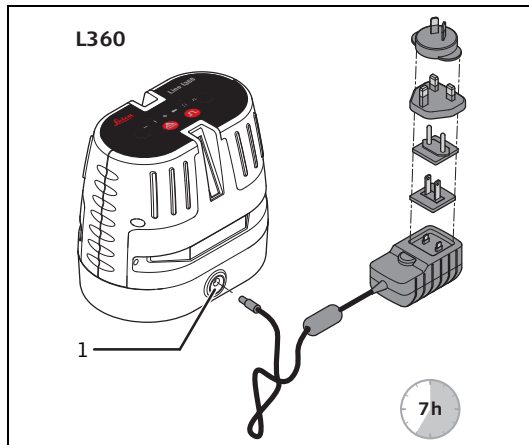

- ① Jack for battery charger

Storage of L360 NiMH Batteries

- Ensure that the product is stored in dry environment with a temperature range of 0°C to +20°C / 32°F to 68°F, in order to minimize the discharge rate of the battery.
- Recharge batteries before longer storage periods.
- At the recommended storage temperature range, batteries can be stored up to 6 months, after which the batteries should be fully recharged.
- After longer storage intervals, please recharge batteries before use.

Operation

Keypad and control elements

- ① LASER key
- ② PULSE/POWER SAVE MODE key
- ③ Lock switch

Display

- ④ Laser crossline
- ⑤ Horizontal laser line
- ⑥ Vertical laser line
- ⑦ Locked
- ⑧ Pulse/Power save mode ON
- ⑨ Battery voltage too low
- ⑩ Plumb and crossline intersection point
- ⑪ Plumb point
- ⑫ Laser switched on

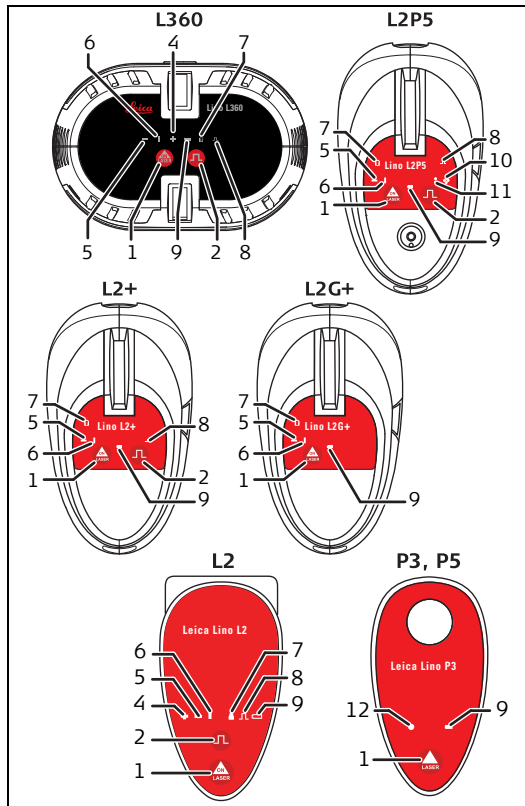
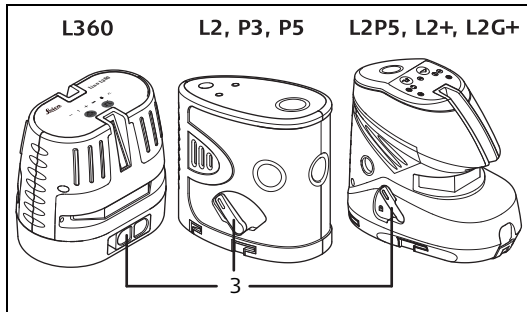

en

Switching on/off

Lino L360, L2P5, L2+, L2G+, and L2:

- **ON:** Briefly press the LASER key ①.
- **OFF:** Press and hold down the LASER key ①.

Lino P3 and Lino P5:

- **ON:** Move the Lock switch ③ to the right.
- **OFF:** Move the Lock switch ③ to the left.

Laser functions

Pressing the LASER key ① activates the following laser functions:

Action	L360	L360	L2P5	L2P5	L2	L2+	L2G+	P3	P5
	not in Lock mode	in Lock mode	not in Lock mode	in Lock mode					
1x	horizontal and vertical	only horizontal	horizontal and vertical	only horizontal	horizontal and vertical	horizontal and vertical	horizontal and vertical	all 3 points	all 5 points
2x	only horizontal	only vertical	all lines and points	only vertical	only horizontal	only horizontal	only horizontal	only plumb points	only plumb points
3x	only vertical	again as 1x	all points	again as 1x	only vertical	only vertical	only vertical	again as 1x	plumb point and right/left
4x	again as 1x	-	only plumb point	-	again as 1x	again as 1x	again as 1x	-	again as 1x
5x	-	-	again as 1x	-	-	-	-	-	-

Self-levelling and Lock functions

The instrument automatically levels itself within the specified grade range (Refer to "Technical data") . Press the Lock switch ③ in order to transport or tilt the instrument beyond the self-levelling range. When locked, the pendulum is fixed and the self-levelling function is deactivated.

Pulse/Power save mode

(only Lino L360, L2P5, L2+, and L2)

The instrument is fitted with a Power save mode. If particularly good visibility of the laser line is not necessary and you wish to save energy, you can switch the Pulse mode on and off by pressing the PULSE/POWER SAVE MODE key ②.

To be able to detect the laser lines over long distances (> 15 m) or in unfavourable lighting conditions, a laser detector can be used. The detector is able to locate the laser beam in Pulse mode, even over long distances.

(Laser detector refer to accessories)

 The L2G+ operates in a continuously pulsed mode to optimize battery life and visibility, and as a consequence the L2G+ has no pulse/Power save button.

Applications

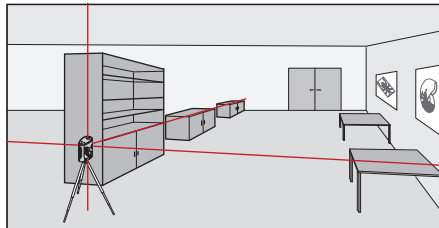
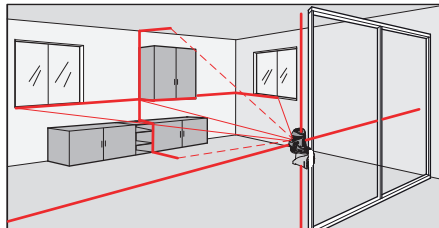
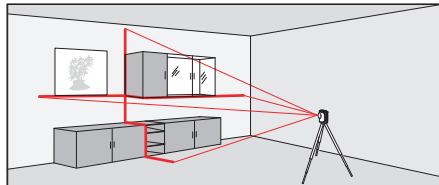
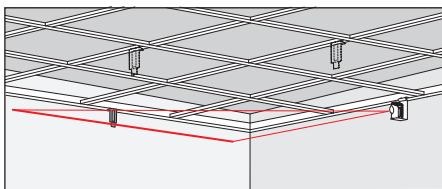
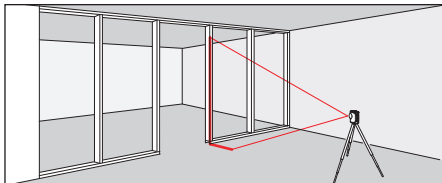
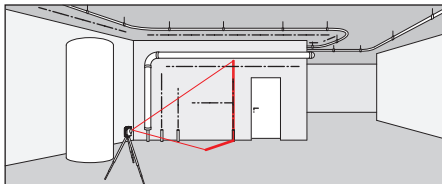
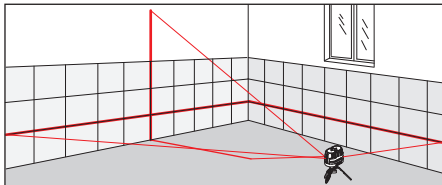

How to use the wall mount bracket:

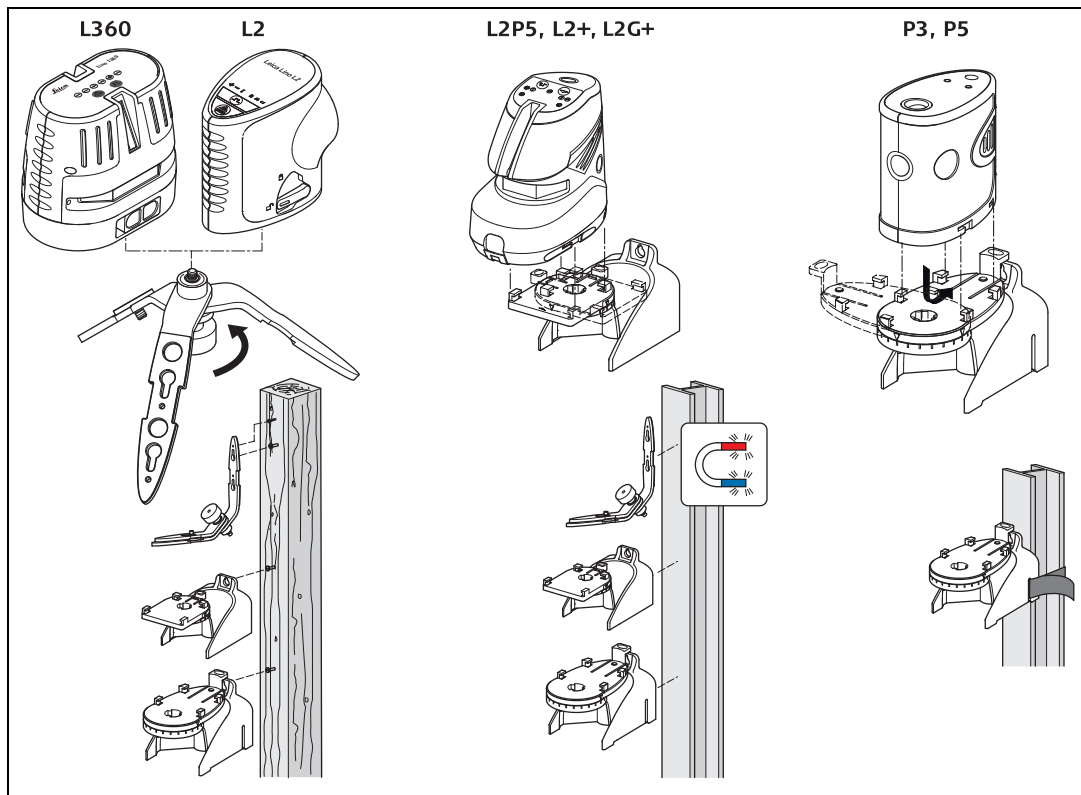

en

Checking the accuracy of the Leica Lino

☞ Check the accuracy of your Leica Lino regularly and particularly before important measuring tasks.

Checking the accuracy of the levelling

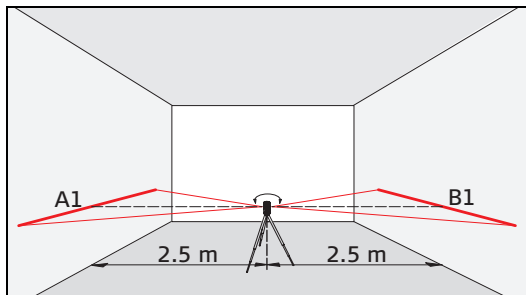

Set the instrument on a tripod half-way between two walls (A+B) that are approx. 5 m apart.

Place the Lock switch ③ in the "Unlocked" () position.

Direct the instrument at wall A and switch on the instrument. Activate the horizontal laser line or laser point and mark the position of the line or the point on wall A (-> A1).

Rotate the instrument by 180° and mark the horizontal laser line or the laser point in exactly the same way on wall B (-> B1).

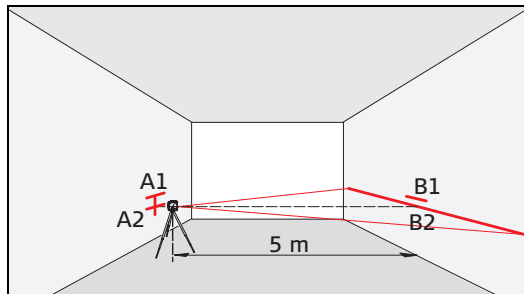

Then place the instrument at the same elevation as close as possible to wall A and again mark the horizontal laser line or the laser point on wall A (-> A2) . Rotate the instrument by 180° again and mark the laser on wall B (-> B2). Measure the distances of the marked points A1-A2 and B1-B2. Calculate the difference of the two measurements. If the difference does not exceed 2 mm, then the Leica Lino is within tolerance.

$$|(A1 - A2) - (B1 - B2)| \leq 2 \text{ mm}$$

Checking the accuracy of the horizontal line (only Lino L360, L2P5, L2+, L2G+, and L2)

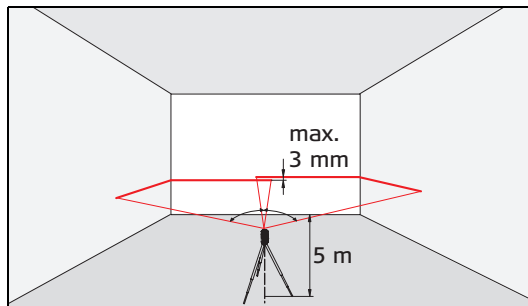



Place the Lock switch ③ in the "Unlocked" () position.

Position the instrument approx. 5 m away from the wall. Direct the instrument at the wall and switch on with the LASER key ①. Activate the laser line with the LASER key ① and mark the intersection point of laser crosshairs on the wall.

Swivel the instrument to the right and then to the left. Observe the vertical deviation of the horizontal line from the marking. If the difference does not exceed 3 mm, then the Leica Lino is within tolerance.

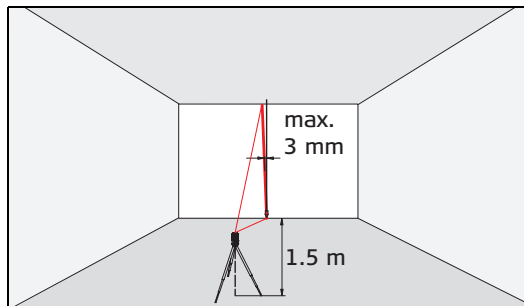
Checking the accuracy of the vertical line: (only Lino L360, L2P5, L2+, L2G+, and L2)



Place the Lock switch ③ in the "Unlocked" () position.

As reference, use a plumb-bob and attach it as close as possible to an approx. 3 m high wall.

Position the instrument at a distance of approx. 1.5 m from the wall at an elevation of approx. 1.5 m. Direct the instrument at the wall and switch on with the LASER key ①. Activate the laser line with the LASER key ①. Rotate the instrument and align it with the bottom of the plumb line. Now read off the maximum deviation of the laser line from the top of the plumb line. If the difference does not exceed 3 mm, then the Leica Lino is within tolerance.

Checking the accuracy of the vertical plumb points:

(only Lino P3, Lino P5 and Lino L2P5)

Place the Lock switch ③ in the "Unlocked" () position.

Checking the upper plumb point:

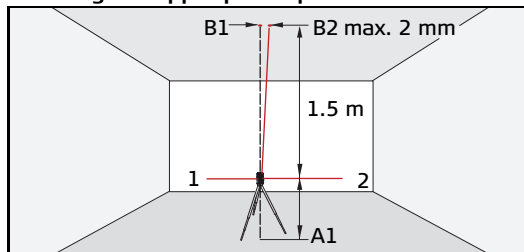

Checking the lower plumb point:

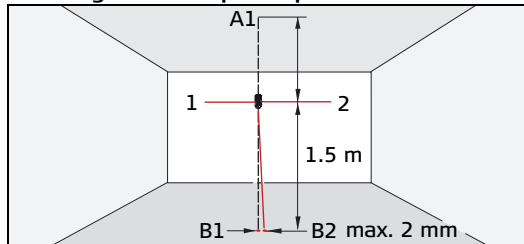

Set up the laser on its tripod or wall mount bracket near point A1 at a minimum distance of 1.5 m from point B1. The horizontal laser is aligned in direction 1. Mark the laser points A1 and B1 with a pin.

Rotate the instrument by 180° so that it points in the opposite direction 2 to direction 1. Adjust the instrument so that the laser beam hits point A1 exactly. If point B2 is no further than 2 mm away from point B1, then the Leica Lino is within tolerance.

 Should your Leica Lino be outside of the specified tolerance, please contact an authorised dealership or Leica Geosystems.

Display notices

Falling below or exceeding the permissible temperature range:

The laser switches off and all symbols flash.

Outside of the self-levelling range:

The laser switches off and the symbol of the selected function indicator light starts to flash (for L2), or the line or point will begin to flash on and off and the symbol of the selected function indicator light begins to flash (for P3, P5, L2+, L2G+, and L2P5).

Pendulum locked:

(only Lino L360, L2P5, L2+, L2G+, and L2)

The laser beam is not levelled and the Lock symbol ⑦ lights up.

Care and advice on operation

Do not immerse the instrument in water. Wipe off dirt with a damp soft cloth. Do not use aggressive cleaning agents or solvents. Treat the instrument with the same care that you would apply to binoculars or a camera.

Dropping or violent shaking of the instrument may damage it. Check the instrument for any damage before using it. Check the levelling accuracy of the instrument regularly.

Transport

To safely transport the instrument, set the Lock switch ③ to "Locked" ().

Warranty

Lifetime Manufacturer's Warranty

Warranty coverage for the entire usage time of the product according to Leica Geosystems International Limited Warranty. Free of charge repair or replacement for all products that suffer defects as a result of faults in materials or manufacturing, for the entire life of the product.

3 Years no Cost

Guaranteed service should the product become defective and require servicing under normal conditions of use, as described in the user manual, at no additional charge.

To receive the "3 years no cost" period, the product must be registered at www.leica-geosystems.com/ registration within 8 weeks of the purchase date. If the product is not registered, a "2 years no cost" period applies.

Technical data

	L360	L2P5	L2	L2+	L2G+	P3	P5
Range	up to 30 m*						
Range with detector	up to 60 m						
Levelling accuracy @ 5 m	± 1.5 mm		± 1 mm		± 1.5 mm		
Self-levelling range	3.5° ± 0.5°		4° ± 0.5°				
Accuracy of plumb points @ 5 m	-		± 1.5 mm		-		± 1.5 mm
Accuracy of horizontal line @ 5 m	± 1.5 mm						
Vertical accuracy @ 3 m line length	± 0.75 mm				± 1.5 mm		-
Beam divergence	360° (horizontal)	< 180°	< 120°	< 180°			-
Number of laser points	-		4		-		3 5
Number of laser lines	2						
Beam direction	vertical, horizontal	vertical, horizontal, up, down, right, left	vertical, horizontal			up, down, forward	up, down, forward, right, left
Laser type	635 nm, laser class 2				515-520 nm, laser class 2		635 nm, laser class 2
Batteries	NiMH battery pack (rechargeable)	Type AA 4 x 1.5 V	Type AA 3 x 1.5 V	Type AA 4 x 1.5 V		Type AA 3 x 1.5 V	
Protection class spray water / dust	IP 65		IP 54				
Operating temperature	-10°C to 40°C				0°C to 40°C		-10°C to 40°C
Storage temperature	-25°C to 70°C						
Dimensions (H x D x W)	131.7 x 145 x 96.2 mm	117.8 x 130.7 x 75.4 mm	96 x 91 x 54 mm	117.8 x 130.7 x 75.4 mm		99.1 x 108.1 x 59.3 mm	
Weight without batteries	1009 g (with batteries)	370 g	321 g	370 g	370 g	310 g	320 g
Tripod thread	1/4"						
Humidity range	maximum relative humidity 80 % for temperatures up to 31 °C decreasing linearly to 50 % relative humidity at 40 °C						
Altitude	< 3500 m						
Intended environment	Primarily indoor use						

* depending on lighting conditions

All rights reserved for changes (on drawings, descriptions and technical data).

	L360	L2P5	L2	L2+	L2G+	P3	P5	
Range	up to 100 ft*							
Range with detector	up to 200 ft					-		
Levelling accuracy @ 16 ft	± 1/16 "		± 0.04 in	± 1/16 "				
Self-levelling range	3.5° ± 0.5°	4° ± 0.5°						
Accuracy of plumb points @ 16 ft	-	± 1/16 "	-			± 1/16 "		
Accuracy of horizontal line @ 16 ft	± 1/16 "							
Vertical accuracy @ 10 ft line length	± 1/32 "				± 1/16 "		-	
Beam divergence	360° (horizontal)	< 180°	< 120°	< 180°		-		
Number of laser points	-	4	-			3	5	
Number of laser lines	2							
Beam direction	vertical, horizontal	vertical, horizontal, up, down, right, left	vertical, horizontal			up, down, forward	up, down, forward, right, left	
Laser type	635 nm, laser class 2				515-520 nm, laser class 2	635 nm, laser class 2		
Batteries Type	NiMH battery pack (rechargeable)	Type AA 4 x 1.5 V	Type AA 3 x 1.5 V	Type AA 4 x 1.5 V		Type AA, 3 x 1.5 V		
Protection class spray water / dust	IP 65	IP 54						
Operating temperature	14°F to +104°F				32°F to +104°F		14°F to +104°F	
Storage temperature	-13°F to +158°F							
Dimensions (H x D x W)	5.19 x 5.71 x 3.79 in	14.6 x 5.1 x 2.95 in	3.8 x 3.6 x 2.1 in	14.6 x 5.1 x 2.95 in		3.9 x 4.25 x 2.3 in		
Weight without batteries	35.6 oz (with batteries)	13.1 oz	11.3 oz	13.1 oz	13.1 oz	10.9 oz	11.3 oz	
Tripod thread	1/4"							
Humidity range	maximum relative humidity 80 % for temperatures up to 87.8°F decreasing linearly to 50 % relative humidity at 104°F							
Altitude	< 11,400 ft							
Intended environment	Primarily indoor use							

* depending on lighting conditions

All rights reserved for changes (on drawings, descriptions and technical data).

NiMH battery pack L360 (rechargeable, Art.No.: 790532)

Input voltage	7.5 V
Input current	1 A
Charging time	7 h

Safety instructions

The person responsible for the instrument must ensure that all users understand these directions and adhere to them.

Symbols used

The symbols used have the following meanings



WARNING:

Indicates a potentially hazardous situation or an unintended use which, if not avoided, may result in death or serious injury.



CAUTION:

Indicates a potentially hazardous situation or an unintended use which, if not avoided, may result in minor injury and/or appreciable material, financial and environmental damage.



Important paragraphs which must be adhered to in practice as they enable the product to be used in a technically correct and efficient manner.

Permitted use

- Projection of horizontal and vertical laser lines and laser points

Prohibited use

- Using the product without instruction
- Using outside the stated limits
- Deactivation of safety systems and removal of explanatory and hazard labels
- Opening of the equipment by using tools (screwdrivers, etc.), as far as not specifically permitted for certain cases
- Carrying out modification or conversion of the product
- Deliberate dazzling of third parties; also in the dark
- Inadequate safeguards at the surveying site.

Limits of use



Refer to section "Technical data".

The Leica Lino is designed for use in areas permanently habitable by humans. Do not use the product in explosion hazardous areas or in aggressive environments.

Areas of responsibility

Responsibilities of the manufacturer of the original equipment Leica Geosystems AG, CH-9435 Heerbrugg (for short Leica Geosystems):

Leica Geosystems is responsible for supplying the product, including the User Manual in a completely safe condition.

Leica Geosystems is not responsible for third party accessories.

Responsibilities of the person in charge of the instrument:

The person in charge of the instrument has the following duties:

- To understand the safety instructions on the product and the instructions in the User Manual.
- To be familiar with local safety regulations relating to accident prevention.

Hazards in use



CAUTION:

Watch out for erroneous measurements if the instrument is defective or if it has been dropped or has been misused or modified.



Carry out periodic test measurements.

Particularly after the instrument has been subject to abnormal use, and before, during and after important measurements.

Refer to section "Checking the accuracy of the Leica Lino".



WARNING:

Empty batteries must not be disposed of with household waste. Care for the environment and take them to the collection points provided in accordance with national or local regulations.



The product must not be disposed of with the household waste.

Dispose of the product appropriately in accordance with the national regulations in force in your country.

Always prevent access to the product by unauthorised personnel.

Product specific treatment and waste management information can be downloaded from the Leica Geosystems home page at <http://www.leica-geosystems.com/treatment> or received from the Leica Geosystems dealer.



WARNING

Using a battery charger not recommended by Leica Geosystems can destroy the batteries. This can cause fire or explosions.

Precautions:

Only use chargers recommended by Leica Geosystems to charge the batteries.

Electromagnetic Compatibility (EMC)

**WARNING:**

The Leica Lino conforms to the most stringent requirements of the relevant standards and regulations. Yet, the possibility of it causing interference in other devices cannot be totally excluded.

FCC statement (applic. in U.S.)

This device complies with Part 15 of the FCC Rules. Operation is subject to the following two conditions: (1) This device may not cause harmful interference, and (2) this device must accept any interference received, including interference that may cause undesired operation.

This equipment has been tested and found to comply with the limits for a Class B digital device, pursuant to part 15 of the FCC Rules. These limits are designed to provide reasonable protection against harmful interference in a residential installation.

This equipment generates, uses and can radiate radio frequency energy and, if not installed and used in accordance with the instructions, may cause harmful interference to radio communications.

However, there is no guarantee that interference will not occur in a particular installation.

If this equipment does cause harmful interference to radio or television reception, which can be determined by turning the equipment off and on, the user

is encouraged to try to correct the interference by one or more of the following measures:

- Reorient or relocate the receiving antenna.
- Increase the separation between the equipment and receiver.
- Connect the equipment into an outlet on a circuit different from that to which the receiver is connected.
- Consult the dealer or an experienced radio/TV technician for help

**WARNING:**

Changes or modifications not expressly approved by Leica Geosystems for compliance could void the user's authority to operate the equipment.

Laser classification

The Leica Lino produces visible laser beams, which are emitted from the instrument:

en

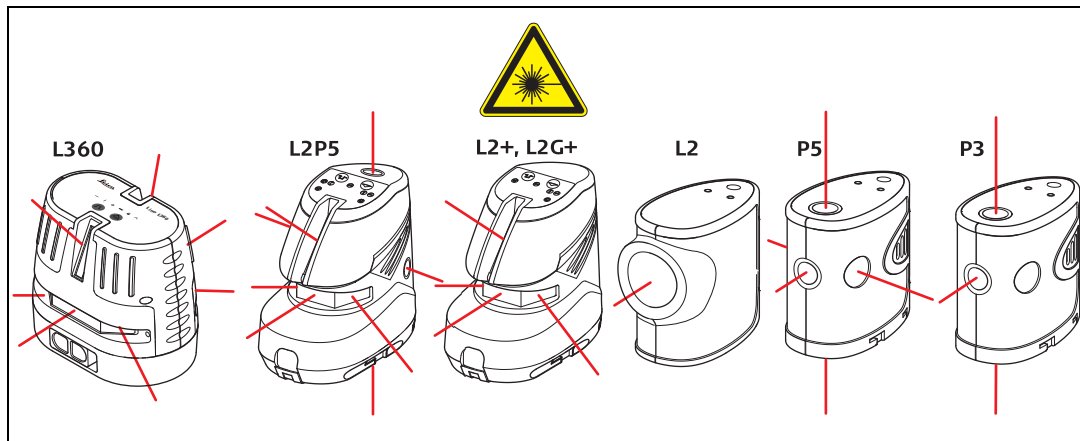

It is a Class 2 laser product in accordance with:

- IEC60825-1 : 2007 "Radiation safety of laser products"
- Lino L2G+: IEC 60825-1:2014

Laser Class 2 products:

Do not stare into the laser beam or direct it towards other people unnecessarily. Eye protection is normally afforded by aversion responses including the blink reflex.



WARNING:

Looking directly into the beam with optical aids (e.g. binoculars, telescopes) can be hazardous.



















CAUTION:

Looking into the laser beam may be hazardous to the eyes.

Labelling

en

<p>L2P5</p> 	<p>Laser Radiation Do not stare into the beam Laser class 2 in acc. with IEC 60825-1:2007 Maximum radiation power: <1.0mW c.w. Emitted wavelength: 620-690nm Beam divergence: <180°</p>	<p>Laser Radiation Do not stare into the beam Laser class 2 in acc. with IEC 60825-1:2007 Maximum radiation power: <1.0mW c.w. Emitted wavelength: 620-690nm Beam divergence: <1.5 mrad</p>	 		
<p>L2</p> 	<p>Laser Radiation Do not stare into the beam Laser class 2 in acc. with IEC 60825-1:2007 Maximum radiation power: <1.0mW c.w. Emitted wavelength: 620-690nm Beam divergence: <120°</p>	 			
<p>L2+</p> 	<p>Laser Radiation Do not stare into the beam Laser class 2 in acc. with IEC 60825-1:2007 Maximum radiation power: <1.0mW c.w. Emitted wavelength: 620-690nm Beam divergence: <180°</p>	 	<p>L2G+</p>	<p>Laser Radiation Do not stare into the beam Laser class 2 in acc. with IEC 60825-1:2014 Maximum radiation power: <0.7mW Emitted wavelength: 515-520nm Beam divergence: <180° Pulse Repetition frequency: 10 kHz Pulse duration: 50 µs</p>	 
<p>P3/P5</p> 	<p>Laser Radiation Do not stare into the beam Laser class 2 in acc. with IEC 60825-1:2007 Maximum radiation power: <1.0mW c.w. Emitted wavelength: 620-690nm Beam divergence: <1.5 mrad</p>	 	<p>L360</p>	<p>Laser Radiation Do not stare into the beam Laser class 2 in acc. with IEC 60825-1:2007 Maximum radiation power: <1.0mW c.w. Emitted wavelength: 620-690nm Beam divergence: <360°</p>	 

Position of label:

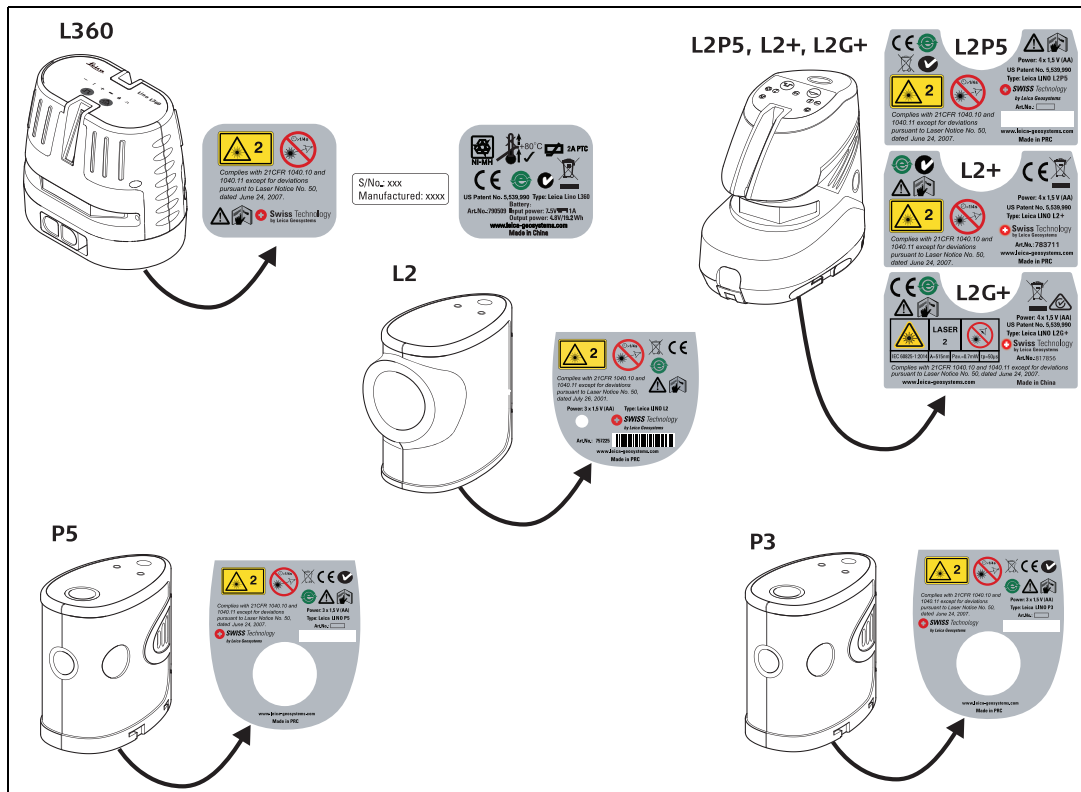

Leica Geosystems AG, Heerbrugg, Switzerland has been certified as being equipped with a quality system which meets the International Standards of Quality Management and Quality Systems (ISO standard 9001) and Environmental Management Systems (ISO standard 14001).

Copyright Leica Geosystems AG, Heerbrugg,
Switzerland 2014
Original text (757665i EN)

Leica Geosystems AG
CH-9435 Heerbrugg
(Switzerland)
www.leica-geosystems.com

- when it has to be **right**

Leica
Geosystems

Download from Www.Somanuals.com. All Manuals Search And Download.

Free Manuals Download Website

<http://myh66.com>

<http://usermanuals.us>

<http://www.somanuals.com>

<http://www.4manuals.cc>

<http://www.manual-lib.com>

<http://www.404manual.com>

<http://www.luxmanual.com>

<http://aubethermostatmanual.com>

Golf course search by state

<http://golfingnear.com>

Email search by domain

<http://emailbydomain.com>

Auto manuals search

<http://auto.somanuals.com>

TV manuals search

<http://tv.somanuals.com>