

# Roteo 20HV/25H/35/35G User Manual



Version 1.2

- when it has to be **right**

Download from [www.somanuals.com](http://www.somanuals.com). All Manuals Search And Download.

**Leica**  
Geosystems

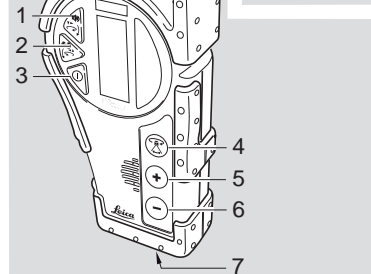
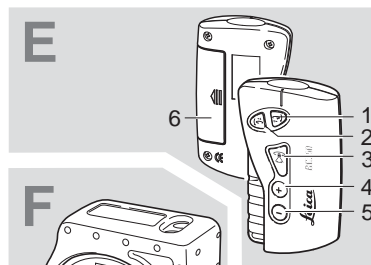
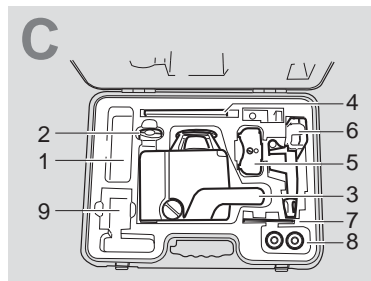
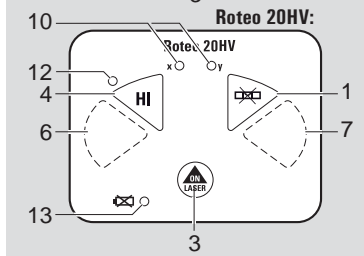
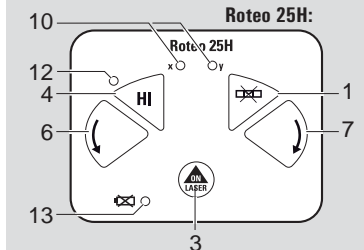
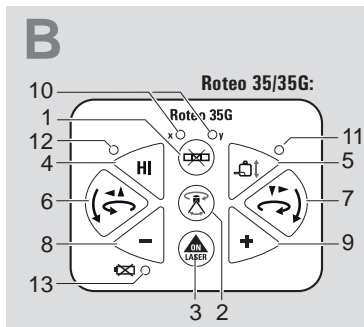
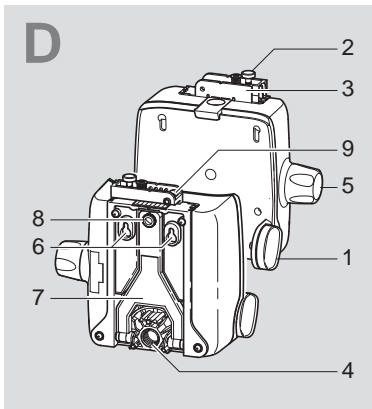
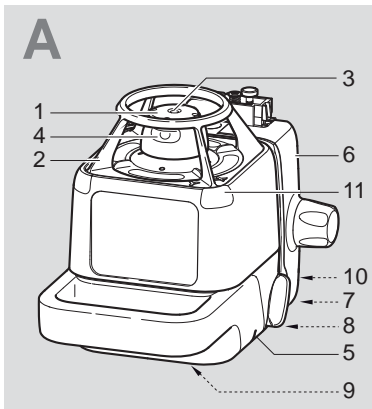

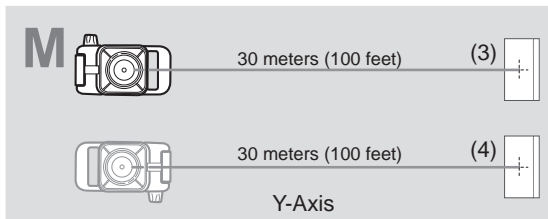
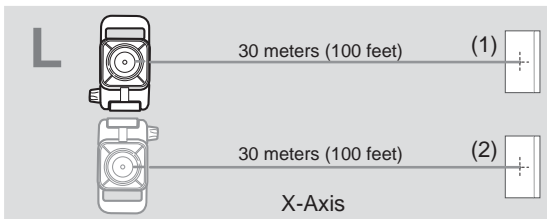
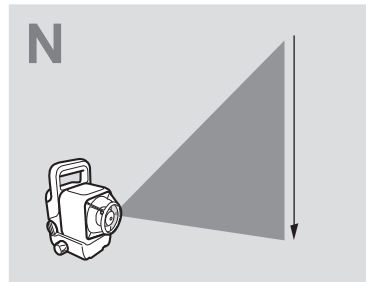
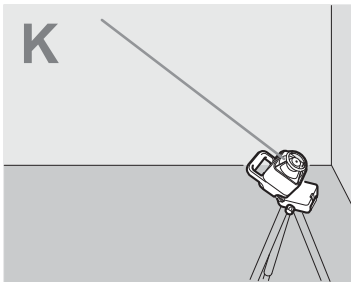
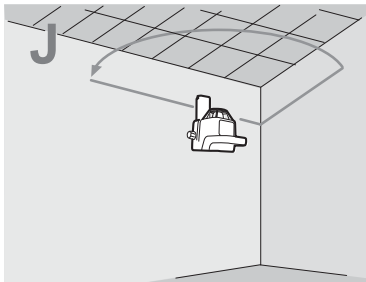
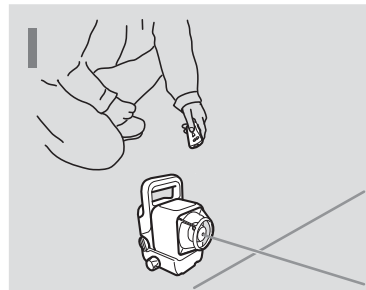
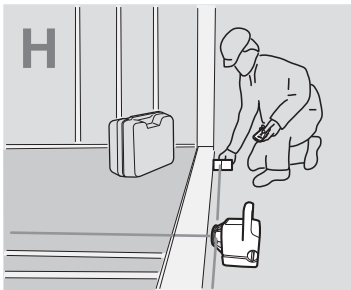
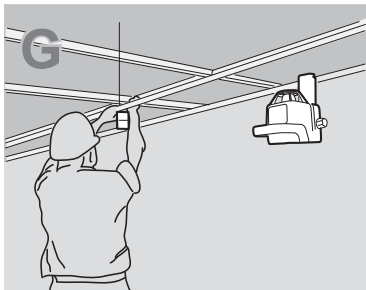

# User Manual

EN

English

## Introduction

### Purchase

Congratulations on the purchase of a new Rotating Laser from Leica Geosystems.

### Product



This manual contains important safety directions as well as instructions for setting up the product and operating it. Refer to "Safety Directions" for further

information.

Read carefully through the User Manual before you switch on the product.

### Product identification

The model and the serial number of your product are indicated on the type plate.

Enter the model and serial number in your manual and always refer to this information when you need to contact your agency or Leica Geosystems authorized service workshop.

Type: \_\_\_\_\_ Serial no.: \_\_\_\_\_



**Note:** There are drawings on the first and last page of the user manual. Unfold these pages while reading through the User Manual. The letters and numbers in  always refer to these drawings.

### Symbols

The symbols used in this manual have the following meanings:



#### DANGER

Indicates an imminently hazardous situation which, if not avoided, will result in death or serious injury.



#### WARNING

Indicates a potentially hazardous situation or an unintended use which, if not avoided, could result in death or serious injury.



#### CAUTION

Indicates a potentially hazardous situation or an unintended use which, if not avoided, may result in minor or moderate injury and / or appreciable material, financial and environmental damage.



Important paragraphs which must be adhered to in practice as they enable the product to be used in a technically correct and efficient manner.

### Trademarks

All trademarks are the property of their respective owners.

# Contents

<b>Introduction</b> .....	1
Features.....	2
Laser Overview {A}.....	3
Keypad Overview {B}.....	3
Carrying Case Overview {C}.....	3
<b>Basic Operation</b> .....	3
How to use your Roteo.....	3
Button Functions.....	4
Automatic / Manual modes.....	4
H.I. Alert mode.....	5
Rotation mode (Roteo 20HV/35/35G).....	5
Scanning mode (Roteo 20HV/35/35G).....	5
Wall Mount {D} (Roteo 20HV/35/35G).....	6
<b>Set-up and applications</b> .....	6
Set-up for manual slopes.....	6
Set-up for ceiling work.....	8
Set-up for layout or floor work (Roteo 20HV/35/35G).....	8
Set-up for squaring or establishing 90° angles (Roteo 20HV/35/35G).....	9
<b>Accessories</b> .....	9
RC-350 Remote Control.....	9
RRC-350 Receiver/Remote Control.....	9
R-250 Receiver.....	10
Other accessories.....	10
<b>Batteries</b> .....	10
Low battery Indicator.....	10
Replacing alkaline batteries.....	10
Using rechargeable NiMH batteries.....	11
Later recharging.....	11
<b>Check and Adjust</b> .....	11
Notes and Responsibilities.....	11
Checking level accuracy.....	11
Checking vertical accuracy.....	12
Adjusting level accuracy – The X-axis.....	12

Adjusting level accuracy – The Y-axis.....	12
Adjusting vertical accuracy – The Z-axis.....	13
Check your work.....	13
<b>Troubleshooting</b> .....	14
<b>Care and Transport</b> .....	16
Transport.....	16
Storage.....	16
Cleaning and Drying.....	17
<b>Safety Directions</b> .....	17
General.....	17
Intended Use.....	17
Limits of Use.....	18
Responsibilities.....	18
Hazards of Use.....	18
Laser Classification.....	21
Electromagnetic Compatibility (EMC).....	23
FCC Statement, Applicable in U.S.....	24
<b>Technical Data</b> .....	26
<b>International Limited Warranty</b> .....	27

EN

## Features

The Roteo laser from Leica Geosystems offers the interior contractor many great features to make your work easier and more accurate. A bright red beam; motorized wall mount; small, ergonomic remote control; optional receiver-remote control unit combine to provide consistent value for the professional contractor.

## Laser Overview {A}

See the inside front cover for a diagram of the laser {A} and keypad {B} corresponding to these callouts. See separate descriptions of the motorized wallmount, remote control and detector.

- 1) Rotating head
- 2) Aluminum head protection with axes indications
- 3) Plumb or square beam laser beam aperture
- 4) Rotating laser beam aperture
- 5) Index marks for alignment and 90°
- 6) Motorized wall or floor mount
- 7) Batteries
- 8) Jack for battery charger
- 9) 5/8"-11 Tripod mount for horizontal setup
- 10) 5/8"-11 Tripod mount for vertical setup
- 11) Sensors for remote control signal

## Keypad Overview {B}

The keypad for the Roteo laser has nine buttons and five LED indicators.

- 1) Automatic / Manual Mode
- 2) Scan / Rotation Mode
- 3) On / Off
- 4) H.I. (Elevation) Alert
- 5) Motorized Mount On / Off
- 6) CCW Scan-Stationary Beam / Manual Slope
- 7) CW Scan-Stationary Beam / Manual Slope
- 8) Minus – Head Speed / Scan Width / Motorized Mount
- 9) Plus – Head Speed / Scan Width / Motorized Mount
- 10) LED's – X/Y Axis Level Indicators (2) – Green (self-leveling), Red (manual)
- 11) LED – Motorized Mount Enabled

## Basic Operation

- 12) LED – H.I. Alert
- 13) LED – Low Battery

## Carrying Case Overview {C}

Not all items indicated are included in the standard package. The following identifies the locations that these items can be placed in the carrying case.

- 1) Spare compartment
- 2) RC350 Remote Control
- 3) Roteo
- 4) User Manual
- 5) Spare Battery Holder
- 6) RRC350 Receiver-Remote Control (optional)
- 7) Ceiling Target
- 8) Spare D-cell Batteries

## Basic Operation

### How to use your Roteo

The wall mount and the metal head protection can both be removed from the laser, if you wish to work without these attachments.

#### Horizontal Setup

The laser can be mounted on a 5/8"-11 tripod or placed directly on a solid, stable surface. Roteo 20/35 can be suspended from a ceiling grid using the wall mount (see later section).

#### Vertical Setup

The laser can be mounted on a 5/8"-11 tripod or placed directly on its back (opposite the handle) on a solid,

stable surface. For more stability, it is recommended to use the wall mount. Use the support plate **{D-7}** for stability when in vertical mode.

### Turning on the laser

Turn on the laser with the On/Off key **{B-3}**. It does a self-test and the beam blinks while the laser is self-leveling. After it is leveled, the head rotates. You can choose H.I. Alert mode or change to manual mode (see later sections).

The laser has a wide self-leveling range; however, if the laser is set up out of the leveling range, the laser beam will continue to blink and the rotation will not start.

### X-axis and Y-axis LED indicators

The X and Y-axis LED indicators **{B-10}** slowly blink green while the axes are leveling and turn on solid when each axis has reached a level position. They will rapidly blink red when in manual mode and the axis can be adjusted. They will be red and on solid when in manual, but the axis cannot be adjusted.

## Button Functions

The CCW/CW and Plus/Minus buttons on the laser and the remote control units have multiple functions depending on the mode of operation. Please refer to the chart below to better understand their functionality.

Mode	CCW / CW Buttons	Plus / Minus Buttons
Automatic mode - rotating	Moves stationary beam – CCW/CW	Changes head speed
Automatic mode - scanning	Moves scanning beam – CCW/CW	Changes scan width
Laydown mode - rotating	Moves vertical plane – Left/Right	Changes head speed
Laydown mode - scanning	Moves scanning beam – CCW/CW	Changes scan width
Manual mode - rotating	Moves manual slope – Inclines plane	Changes head speed
Manual mode - scanning	Moves scanning beam – CCW/CW	Changes scan width
Motor mount mode	No function	Moves the laser - Up/Down

These fully apply only on Roteo 35. Other models feature less functions, according the following sections. Roteo 20HV/25H do not feature all buttons **{B}** as Roteo 35. Refer to RC350 section later to see how to use RC350 instead of the **{B}** buttons.

## Automatic / Manual modes

The Roteo is in automatic, self-leveling mode when turned on. Once the instrument has self-leveled, the

laser head will start rotating (Roteo 20HV/35/35G: 300 rpm, Roteo 25H: 600 rpm).

In manual mode, the laser does not self-level; this means that the beam will rotate even if the laser is not leveled. It can therefore be used on inclined planes such as stairs, roofs, or when manual grade setting is required. See later section on setting slope in manual or semi-automatic modes.

---

## H.I. Alert mode

The H.I. feature stops the laser automatically and sounds an alarm if the laser is disturbed, preventing inaccurate readings. It functions only when selected.

- ▶ To activate this safeguard feature, press the H.I. key **{B-4}** after turning on the laser. The H.I. LED **{B-12}** will blink rapidly while the laser is self-leveling.
- ▶ Thirty seconds after the head starts to rotate, the LED will blink slowly, indicating the H.I. Alert function is activated.
- ▶ If the laser is disturbed while in H.I. Alert mode, the head will stop rotating, the beam will turn off, the LED indicator will be on continuously, and an alarm will sound (Roteo 35/35G).
- ▶ On Roteo 20HV and 25H models all LEDs will be on continuously when disturbed in H.I. mode.
- ▶ Press the H.I. key to turn off the H.I. Alert function. Check to see if the beam elevation has changed from its original benchmark position.
- ▶ The laser is no longer in H.I. Alert mode. Press the H.I. key to re-activate the H.I. Alert function.

---

## Rotation mode (Roteo 20HV/35/35G)

The head rotates at four speeds: 0, 150, 300, 450, 600 rpm. The default setting is 300 rpm. The laser beam is more visible at slower rotation speeds.

- ▶ To increase the rotation speed press the Plus key **{B-9}**. Press the Minus key **{B-8}** to decrease speed. Press and hold the Minus key to stop rotation.
- ▶ When the beam is stopped, the point can be moved to the right or left using the Counter-clockwise / Clockwise (CCW/CW) rotation keys **{B-6 and B-7}**. You can also move the head manually to position the beam point. To start rotation again, press the Plus key **{B-9}**.

---

## Scanning mode (Roteo 20HV/35/35G)

For interior applications, scanning mode allows you to see the beam easier at a distance.

- ▶ To scan press the Scan / Rotation key **{B-2}**. The beam will blink until the laser has self-leveled.
- ▶ To increase the scan length press the Plus key **{B-9}**. Press the Minus key **{B-8}** to decrease the scan length.
- ▶ The scanning beam can be moved to the right or left using the Counter-clockwise / Clockwise (CCW/CW) rotation keys **{B-6 and B-7}**.



## Wall Mount {D} (Roteo 20HV/35/35G)

See the inside, front cover for illustrations of the Wall Mount.

- 1) Attachment clamps for laser and mount
- 2) Clamp for ceiling grid
- 3) Adjustable plate
- 4) 5/8"-11 tripod mount (vertical setup)
- 5) Moves laser manually on mount
- 6) Holes for attaching mount to wall
- 7) Adjustable support for wall or ground stability
- 8) Screw to adjust support
- 9) Index notches for alignment

The wall mount can be used to move the laser up or down on a ceiling grid. It can also be used when installing walls and partitions to move the laser back and forth for vertical alignment.

## Motorized Wall Mount (Roteo 35/35G)

### Activating the motorized wall mount

Allow the laser to self-level. Note the position of the beam.

- ▶ Press the Motorized mount key {**B-5**} to activate the mount. The motorized mount LED {**B-11**} will turn on to indicate that the mount is now active (on the Remote, press Scan/Rotation key {**E-3, F-4**} for 1.5 seconds).
- ▶ To raise the laser press the Plus key {**B-9**}. Press the Minus key {**B-8**} to lower the laser.

### Maximum movement

When the beam is at 0 on the adjustable plate, the laser can be raised a maximum of 50 mm (2") and lowered a maximum of 60 mm (2.25").

### Wait until self-leveled

While the laser is moving on the mount it does not self-level and the beam continues to rotate.

- ▶ After moving the laser, wait a few seconds in case the laser needs to self-level. Check that it is still on the point or level desired and make adjustments if needed.

### Automatic exit from mode

If you have not activated the wall mount for five minutes, the laser will automatically exit from the motorized mount mode and return to the previous mode. The Motorized mount LED will turn off.

### Troubleshooting

- ▶ If the laser does not move on the mount, check that the knobs {**D-1**} are tight enough to make the power contact for the motor. The mount can also be detached to check that the contacts are clean where the laser and mount.

## Set-up and applications

### Set-up for manual slopes

The Roteo can be used to manually create slopes for special applications, stairways, sloped ceilings, etc.

### Two modes are available:

- Full manual mode – Both the X and Y-axes will be in manual mode
- Semi-automatic mode – The X-axis self-levels, The Y-axis is in manual mode.

For slopes up to 10%, set up the laser in horizontal mode and use the remote to set the slope following the instructions below.

For slopes greater than 10%, set up the laser in vertical mode and use the inclined plane feature explained in the following section.

### Set-up for full manual mode

In full manual mode, the unit will not self-level and the head will continue to rotate. The plane of laser light can be tilted in either one or both planes.

#### To use the laser in full manual mode:

- ▶ After turning the laser on and allowing it to self-level, press the Auto/Manual key **{B-1}**. The X-axis LED **{B-10}** above the key will blink red rapidly, indicating that you are in manual mode and you can set slope in the X-axis. (The Y-axis LED will also be on and red.)
- ▶ Turn the laser so that the X on the top of the laser faces the direction of the slope.
- ▶ Press either CCW/CW (manual slope) keys **{B-6 or B-7}** to adjust the slope of the X-axis.
- ▶ To adjust the slope of the Y-axis, press the Auto/Manual key **{B-1}** again. The Y-axis LED **{B-10}** above the key will blink red rapidly, indicating that you are in manual mode and you can set slope in the Y-axis. (The X-axis LED will also be on and red.)

- ▶ Turn the laser so that the Y on the top of the laser faces the direction of the slope.
- ▶ Press either CCW/CW (manual slope) keys **{B-6 or B-7}** to adjust the slope of the Y-axis.
- ▶ Press the Auto/Manual key **{B-1}** for 1.5 seconds to exit manual mode and return to automatic mode. See illustration **{J}** in the back, inside cover of this manual.

### Set-up for semi-automatic mode

In semi-automatic mode, the unit will self-level in the X-axis. The plane of laser light can be tilted manually in the Y-axis.

#### To use the laser in semi-automatic mode:

- ▶ After turning the laser on and allow the laser to self-level, press and hold the Auto/Manual key **{Roteo 35/35G: B-1, Roteo 20HV/25H: E-3}** for three seconds. Roteo 20HV/25H: The X-axis LED **{B-10}** above the key will blink green slowly while leveling. The Y-axis LED will blink quickly indicating that the Y-axis is in manual mode and you can set slope in the Y-axis.
- ▶ Turn the laser so that the Y on the top of the laser faces the direction of the slope.
- ▶ Press either CCW/CW (manual slope) keys **{B-6 or B-7}** to adjust the slope of the Y-axis.
- ▶ Press the Auto/Manual key **{B-1}** again to exit semi-automatic mode and return to automatic mode.

### Set-up for inclined planes (Roteo 20HV/35/35G)

The Roteo can also be tilted, for manual slope, at various angles on the wall mount. A tripod with rotating mounting plate will speed set-up.

### To use the laser for inclined planes:

- ▶ Set the laser in vertical mode, preferably on a tripod. If setting on the ground, flip down the support plate for stability.
- ▶ After the laser has self-leveled, set in manual or semi-automatic mode.
- ▶ Loosen the knobs on either side **{D-1}** to partially separate the mount from the laser.
- ▶ Move the laser to the approximate inclined position and tighten slightly.
- ▶ Move to the final position and tighten further. See illustration **{K}** in the back, inside cover of this manual.

## Set-up for ceiling work

The Roteo is perfect for the leveling of suspended ceilings when used together with the wall mount and magnetic ceiling grid target.

### To attach the laser and wall mount to the first piece of perimeter ceiling grid (Roteo 20HV/35/35G):

- ▶ Flip down the support plate **{D-8}**
- ▶ Release the clamp **{D-2}** on top of the adjustable plate **{D-3}**.
- ▶ Lock the clamp against the ceiling grid.
- ▶ If the foot on the support plate is not touching the wall, use the screw **{D-9}** to adjust.

### To move the laser up or down (Roteo 35/35G):

- ▶ Turn on the laser and wait for it to self-level. The head must be rotating before you can enter motorized mount mode.

- ▶ Press the motorized mount key **{B-5}** to activate the mount. The motorized mount LED **{B-11}** will turn on to indicate that the mount is now active.
- ▶ To raise the motorized mount press the Plus key **{B-9}**. Press the Minus key **{B-8}** to lower motorized mount. Holding the key will result in fast movement; short clicks will move the laser more precisely.

### Getting to work:

- ▶ Raise the laser on the wall mount until the rotating beam is at the same level as the perimeter ceiling grid. Use the line created by the laser as a reference to attach the perimeter grid to the wall.
- ▶ Lower the laser on the wall mount until the rotating beam is striking the on-grade position on the magnetic, ceiling grid target.
- ▶ Adjust the height of the ceiling grid using the laser beam on the target as your reference. See illustration **{G}** in the back, inside cover of this manual.

## Set-up for layout or floor work (Roteo 20HV/35/35G)

The Roteo can easily be used in the laydown or vertical mode for laying out walls locations, transferring points from the floor to the ceiling and plumb applications.

### To use the laser in the vertical mode:

- ▶ Flip down the support plate **{D-8}** and place the laser in vertical mode on the floor.
- ▶ If the support plate is not level, use the screw **{D-9}** to adjust.
- ▶ Set up the laser over a control point by first pointing the stationary beam downward, and then manually, or

by using the wall mount, move the laser over the reference mark.

- ▶ Adjust the rotating or scanning beam to a second control point to establish the desired vertical plane. For fine adjustments, use the CCW/CW **{B-6 and B-7}** buttons to move the beam left and right.
- ▶ Once the laser is adjusted to the two reference marks, points can easily be transferred from the floor to the ceiling for the construction of walls.
- ▶ This type of set up is an excellent application of the use of the remote control unit. Use the remote while monitoring the beam until it is in line with the second control point. See illustration **{H}** in the back, inside cover of this manual.

## Set-up for squaring or establishing 90° angles (Roteo 20HV/35/35G)

The Roteo has a plumb beam that projects from the top of the rotating head. This beam is projected at a 90° angle to the main beam. This feature allows the laser to be used for laying out floor plans.

### To use the laser to square or establish 90° angles:

- ▶ Follow exactly the same set up procedure above for layout work.
- ▶ Align the laser to two reference points using either the main beam or the top plumb beam.
- ▶ Once aligned, the two beams create an accurate 90° angle for wall layout and construction. See illustration **{I}** in the back, inside cover of this manual.

## Accessories

### RC-350 Remote Control

The RC-350 Remote Control has five buttons which perform the same function as the buttons on the laser. Refer to illustration **{E}** on the inside front cover of this manual.

- 1) CCW Scan-Stationary Beam / Manual Slope
- 2) CW Scan-Stationary Beam / Manual Slope
- 3) Scan / Rotation Mode (1.5 seconds - Motorized Mount)
- 4) Plus – Head Speed / Scan Width / Motorized Mount
- 5) Minus – Head Speed / Scan Width / Motorized Mount

The performance of CCW/CW and Plus/Minus keys is dependent on the mode of operation selected. Please refer to the table in "Button Functions" on page 4 to better understand their functionality.

- The red LED at the top of the remote will flash each time a button is pressed, indicating that the remote is transmitting to the laser.
- Battery – To open the battery compartment **{E-6}** and change the battery, push the battery cover in the direction of the arrow. The RC-350 requires one AA alkaline battery.

### RRC-350 Receiver/Remote Control

The RRC-350 Receiver/Remote Control is a combination Laser Receiver and Remote Control for the laser. It is important to note that with the power turned ON, the

unit acts as a laser receiver. With power turned OFF, the unit performs as a remote.

The RRC-350 has six buttons; two of which have dual functions depending on whether the unit is being used as a receiver or as a remote. Refer to illustration **{F}** on the inside front cover of this manual.

- 1) Audio (Receiver), CW Scan-Stationary Beam / Manual Slope (Remote)
- 2) Bandwidth (Receiver), CCW Scan-Stationary Beam / Manual Slope (Remote)
- 3) Power – On (Receiver) / Off (Remote)
- 4) Scan / Rotation Mode (1.5 seconds - Motorized Mount)
- 5) Plus – Head Speed / Scan Width / Motorized Mount
- 6) Minus – Head Speed / Scan Width / Motorized Mount

As a remote, the performance of the CCW/CW and Plus/Minus keys is dependent on the mode of operation selected. Please refer to the table in Section "Button Functions" on page 4 to better understand their functionality.

- The RRC-350 can be used as a receiver and attached magnetically to the ceiling grid to be used in place of the ceiling grid target in poor visibility conditions.
- Battery – To replace the battery on your RRC-350 Receiver/Remote use a finger or small coin to open the battery compartment **{F-7}** at the base of the unit. The RRC-350 requires a 9-volt type alkaline battery.

## R-250 Receiver

The R-250, delivered with Roteo 25H, has all receiver functions of RRC-350 without the remote control func-

tions. Refer to illustration **{E}** on the inside front cover of this manual.

- 1) Audio
- 2) Bandwidth
- 3) Power ON/OFF

(Keys 4, 5 and 6 are only available on RRC-350)

## Other accessories

- Laser enhancing glasses improve the visibility of the laser beam in bright light conditions.
- The ceiling grid target is used to view the beam on suspended ceiling applications. The target attaches magnetically to the grid.

## Batteries

### Low battery Indicator

When the battery power is low, the laser head will stop rotating and the low battery LED **{B-13}** will stay on.

### Replacing alkaline batteries

Follow the steps below to replace the alkaline batteries in your laser.

- ▶ To access the battery compartment, loosen the knobs connecting the laser to the wall mount.
- ▶ Use a coin or small screwdriver to remove the cover of the battery compartment at the back of the laser.
- ▶ Insert two fresh alkaline batteries (D size or LR20), following the polarization indicated at the bottom of the

battery compartment. The plus contact is rounded and raised. When replacing batteries, change both at the same time.

- ▶ Replace the compartment and tighten with a coin or screwdriver.

## Using rechargeable NiMH batteries

If your laser has a rechargeable battery, you must charge it for 8 hours before first using the laser.

- ▶ Insert the charger plug into the jack located at the back of the laser, under the wall mount.
- ▶ Plug the charger into an electrical outlet.
- ▶ Charge for 8 hours.

## Later recharging

The laser can be charged while working if electricity is available on the jobsite. Simply plug in the charger and keep on working.

You can also remove the battery pack to charge it, or replace it with the alkaline battery compartment to keep on working.

## Check and Adjust

### Notes and Responsibilities

- It is the responsibility of the user to follow operating instructions and to periodically check the accuracy of the instrument and work as it progresses.
- The laser is adjusted to the defined accuracy specifications at the factory. It is recommended to check

your laser for accuracy upon receipt and periodically thereafter to ensure accuracy is maintained. If your laser requires adjustment, contact the nearest authorized service center or adjust the laser using the following procedure.

- Do not enter this mode or attempt adjustment unless you plan to change the accuracy. Accuracy adjustment should only be performed by a qualified individual that understands basic adjustment principles.

## Checking level accuracy

To check the level accuracy of your laser, place the unit on a flat, level surface or tripod approximately 30 meters (100 ft.) from a wall. See illustration **{L}** in the back, inside cover of this manual.

- ▶ Align the X-axis so that it is square to the wall. Allow the laser to self-level completely (approximately one minute after the laser begins to rotate). Then mark the position of the beam (Position 1).
- ▶ Rotate the laser 180°, allow it to self level and mark the opposite side of the first axis (Position 2).
- ▶ Align the Y-axis by rotating the laser 90° so that this axis is now square to the wall. Allow the laser to self-level completely, and then mark the position of the beam (Position 3). See illustration **{M}** in the back, inside cover of this manual.
- ▶ Rotate the laser 180°, allow it to self level and mark the opposite side of the Y-axis (Position 4).
- ▶ The laser is within its accuracy specification if the four marks are within  $\pm 3$  mm ( $\pm 1/8$ " ) from the center.

## Checking vertical accuracy

To check the vertical accuracy of your laser, place the unit in the laydown position on a flat, level surface approximately 15-30 meters (50-100 ft.) from a wall. See illustration **{N}** in the back, inside cover of this manual.

- ▶ Hang a plumb line on the wall.
- ▶ Move the laser until the vertical, rotating beam is aligned to the plumb line.
- ▶ If the rotating beam is not plumb, adjustment is necessary.

## Adjusting level accuracy – The X-axis

After checking the accuracy of your laser, perform the following steps to adjust the accuracy of the X-axis.

- ▶ Turn off the laser.
- ▶ Press and hold the Auto/Manual key **{B-1}**, then press the On/Off key **{B-3}**.
- ▶ After the X and Y LED's blink three times simultaneously, release the Auto/Manual key.
  - The X-axis LED will flash rapidly (red) while leveling.
  - The X-axis LED will flash slowly (red) when ready for adjustment.
  - The head will not be rotating.
  - To use a receiver, press the Scan/Rotation key **{B-2}** to start rotation mode.
- ▶ Press a CCW/CW key **{B-6 or B-7}**, hidden on Roteo 20HV} to adjust the beam up or down. Five presses of the key will move the beam approximately 1.5 mm at 30 meters (1/16" at 100 feet). Use of the

remote for this adjustment will make the job easier by not disturbing the laser.

### After completing the changes to the X-axis, do one of the following steps:

- ▶ Press the Plus key **{B-9}** after completing adjustment to switch to the Y-axis.
- ▶ Press the Minus key **{B-8}** to exit adjustment mode, save changes and turn off the laser.
- ▶ Press the On/Off key **{B-3}** at any time to turn off the laser without saving any changes.

## Adjusting level accuracy – The Y-axis

### After checking the accuracy of your laser, perform the following steps to adjust the accuracy of the Y-axis.

- ▶ If already in adjustment mode for the X-axis, press the Plus key **{B-9}** to switch to the adjustment of the Y-axis.
- ▶ If not in adjustment mode, follow the steps above for entering adjustment mode, then press the Plus key to switch to the adjustment of the Y-axis.
  - The Y-axis LED will flash rapidly (red) while leveling.
  - The Y-axis LED will flash slowly (red) when ready for adjustment.
  - The head will not be rotating.
  - To use a receiver, press the Scan/Rotation key **{B-2}** to start rotation mode.
- ▶ Press a CCW/CW key **{B-6 or B-7}**, hidden on Roteo 20HV} to adjust the beam up or down. Five presses of the key will move the beam approximately 1.5 mm at 30 meters (1/16" at 100 feet). Use of the

remote for this adjustment will make the job easier by not disturbing the laser.

EN

**After completing the changes to the Y-axis, do one of the following steps:**

- ▶ Press the Minus key **{B-8}** to exit adjustment mode, save changes and turn off the laser.
- ▶ Press the On/Off key **{B-3}** at any time to turn off the laser without saving any changes.

---

## Adjusting vertical accuracy – The Z-axis

**After checking the vertical accuracy of your laser, perform the following steps to adjust the Z-axis.**

- ▶ Turn off the laser.
- ▶ Place the laser in the laydown position approximately 6 meters (20 feet) from a plumb line on a wall.
- ▶ Press and hold the Auto/Manual key **{B-1}**, then press the On/Off key **{B-3}**.
- ▶ After the X and Y LED's blink three times simultaneously, release the Auto/Manual key.
  - The Z-axis (Y-axis) LED will flash rapidly (red) while leveling.
  - The Z-axis (Y-axis) LED will flash slowly (red) when ready for adjustment.
  - The head will not be rotating.
  - To use a receiver, press the Scan/Rotation key **{B-2}** to start rotation mode.
- ▶ Press a CCW/CW key **{B-6 or B-7, hidden on Roteo 20HV}** to adjust the beam to the plumb line. Twenty-five presses of the key will move the beam approximately 1.5 mm at 6 meters (1/16" at 20 feet).

Use of the remote for this adjustment will make the job easier by not disturbing the laser.

**After completing the changes to the Z-axis, do one of the following steps:**

- ▶ Press the Minus key **{B-8}** to exit adjustment mode, save changes and turn off the laser.
- ▶ Press the On/Off key **{B-3}** at any time to turn off the laser without saving any changes.

---

## Check your work

After any accuracy adjustments always double check your work, by making a final check of the laser.



Symptom	Possible Causes and Solutions
Low battery LED is on or flashing and the head will not rotate.	<p>Check your batteries</p> <ul style="list-style-type: none"> <li>• Replace alkaline batteries.</li> <li>• Charge rechargeable batteries.</li> </ul>
H.I. Alert is on and an alarm is sounding.	<p>The laser has been disturbed and possibly changed elevation.</p> <ul style="list-style-type: none"> <li>• Press H.I. <b>{B-5}</b> to stop the alert.</li> <li>• Check the height against a known benchmark.</li> <li>• After checking, press H.I. to reset function.</li> </ul>
The laser will not self-level	<p>The laser must be in automatic to self-level.</p> <ul style="list-style-type: none"> <li>• In automatic mode, both the X-axis and Y-axis LED's will blink green while leveling.</li> <li>• In manual mode, one or both of the X-axis or Y-axis LED's will be red.</li> </ul>
The laser beam blinks, but the unit will not self-level or rotate.	<p>The unit is most likely out of its 10% self-leveling range.</p> <ul style="list-style-type: none"> <li>• Check your set up and re-level the tripod if necessary.</li> <li>• If this does not solve the problem, the laser should be returned to an authorized service center for service.</li> </ul>
The laser does not turn on	<p>The symptom may be caused by low or dead batteries.</p> <ul style="list-style-type: none"> <li>• Check, change, charge the batteries.</li> <li>• If not the batteries, the laser should be returned to an authorized service center for service.</li> </ul>

Symptom	Possible Causes and Solutions
The laser's distance is reduced	<p>Dirt may be reducing the output of the laser.</p> <ul style="list-style-type: none"> <li>• Clean the windows of the laser and receiver to improve distance.</li> <li>• If not the windows, the laser should be returned to an authorized service center for service.</li> </ul>
The IR Remote is not working	<p>Check for proper operation of the remote.</p> <ul style="list-style-type: none"> <li>• Check that the laser is turned on.</li> <li>• The remote may be outside the usable distance.</li> <li>• Aim the remote more directly at the laser for maximum distance.</li> <li>• The remote's battery may be low.</li> </ul>
The laser's receiver is not functioning properly.	<p>Check for proper operation of the receiver.</p> <ul style="list-style-type: none"> <li>• The laser is not rotating. It is leveling or in elevation alert.</li> <li>• The receiver may be outside the usable distance.</li> <li>• The remote's battery may be low.</li> </ul>
Elevation alert function is not working	<p>The elevation alert function for the Roteo is normally off until activated by the user.</p> <ul style="list-style-type: none"> <li>• Press the H.I. button to activate the H.I. function.</li> <li>• When turned on, the H.I. LED will flash rapidly (5 Hz), flash slowly when active, and will turn on solid with an audio alarm when an alert occurs.</li> </ul>
Motorized mount will not move.	<p>Check that the locking knobs <b>{D-1}</b> are tight enough to make contact for the motor.</p> <ul style="list-style-type: none"> <li>• Tighten the locking knobs.</li> <li>• Remove the mount and clean the contacts.</li> </ul>
Top four LED's are flashing in sequence.	<p>Unit cannot level. Check your set up.</p> <ul style="list-style-type: none"> <li>• Unit is tipped beyond self-leveling range.</li> <li>• Unit is on unstable surface.</li> </ul>

## Transport

### Transport in the field

When transporting the equipment in the field, always make sure that you

- either carry the product in its original transport container,
- or carry the tripod with its legs splayed across your shoulder, keeping the attached product upright.

### Transport in a road vehicle

Never carry the product loose in a road vehicle, as it can be affected by shock and vibration. Always carry the product in its transport container and secure it.

### Shipping

When transporting the product by rail, air or sea, always use the complete original Leica Geosystems packaging, transport container and cardboard box, or its equivalent, to protect against shock and vibration.

### Shipping, transport of batteries

When transporting or shipping batteries, the person in charge of the product must ensure that the applicable national and international rules and regulations are observed. Before transportation or shipping, contact your local passenger or freight transport company.

### Field Adjustment

After transport inspect the field adjustment parameters given in this user manual before using the product.

## Storage

### Product

Respect the temperature limits when storing the equipment, particularly in summer if the equipment is inside a vehicle. Refer to "Technical Data" for information about temperature limits.

### Field Adjustment

After long periods of storage inspect the field adjustment parameters given in this user manual before using the product.

### NiMH Batteries

- Refer to "Technical Data" for information about storage temperature range.
- A storage temperature range of 0°C to +20°C / 32°F to 68°F in a dry environment is recommended to minimize self-discharging of the battery.
- At the recommended storage temperature range, batteries containing a 10% to 50% charge can be stored up to one year. After this storage period the batteries must be recharged.
- Remove batteries from the product and the charger before storing.
- After storage recharge batteries before using.
- Protect batteries from damp and wetness. Wet or damp batteries must be dried before storing or use.

### Alkaline Batteries

If the equipment is to be stored for a long time, remove the alkaline batteries from the product in order to avoid the danger of leakage.

## Cleaning and Drying

### Product and Accessories

- Blow dust off optical parts.
- Never touch the glass with your fingers.
- Use only a clean, soft, lint-free cloth for cleaning. If necessary, moisten the cloth with water or pure alcohol.
- Do not use other liquids; these may attack the polymer components.

### Damp Products

- Dry the product, the transport container, the foam inserts and the accessories at a temperature not greater than 40°C / 104°F and clean them.
- Do not repack until everything is completely dry.

### Cables and Plugs

- Keep plugs clean and dry.
- Blow away any dirt lodged in the plugs of the connecting cables.

## Safety Directions

### General

#### Description

The following directions should enable the person responsible for the product, and the person who actually uses the equipment, to anticipate and avoid operational hazards.

The person responsible for the product must ensure that all users understand these directions and adhere to them.

## Intended Use

### Permitted Use

- The instrument casts a horizontal laser plane for the purposes of alignment.
- The unit can be set up on its own base plate, wall-mount or on a tripod.
- The laser beam can be detected by means of a laser detector.
- This product is intended for indoor use and applications.

### Adverse Use

- Use of the product without instruction.
- Use outside of the intended limits.
- Disabling safety systems.
- Removal of hazard notices.
- Opening the product using tools, for example screwdriver, unless this is specifically permitted for certain functions.
- Modification or conversion of the product.
- Use after misappropriation.
- Use of products with obviously recognizable damages or defects.
- Use with accessories from other manufacturers without the prior explicit approval of Leica Geosystems.
- Inadequate safeguards at the work site, for example when using on or near roads.

- Deliberate dazzling of third parties.
- Controlling of machines, moving objects or similar monitoring application without additional control and safety installations.



### **WARNING**

Adverse use can lead to injury, malfunction and damage. It is the task of the person responsible for the equipment to inform the user about hazards and how to counteract them. The product is not to be operated until the user has been instructed on how to work with it.

## **Limits of Use**

### **Environment**

Suitable for use in an atmosphere appropriate for permanent human habitation: not suitable for use in aggressive or explosive environments.



### **DANGER**

Local safety authorities and safety experts must be contacted before working in hazardous areas, or in close proximity to electrical installations or similar situations by the person in charge of the product.

## **Responsibilities**

### **Manufacturer of the product**

Leica Geosystems AG, CH-9435 Heerbrugg, hereinafter referred to as Leica Geosystems, is responsible for supplying the product, including the user manual and original accessories, in a completely safe condition.

### **Manufacturers of non Leica Geosystems accessories**

The manufacturers of non Leica Geosystems accessories for the product are responsible for developing, implementing and communicating safety concepts for their products, and are also responsible for the effectiveness of those safety concepts in combination with the Leica Geosystems product.

### **Person in charge of the product**

The person in charge of the product has the following duties

- To understand the safety instructions on the product and the instructions in the user manual.
- To be familiar with local regulations relating to safety and accident prevention.
- To inform Leica Geosystems immediately if the product and the application becomes unsafe.



### **WARNING**

The person responsible for the product must ensure that it is used in accordance with the instructions. This person is also accountable for the training and the deployment of personnel who use the product and for the safety of the equipment in use.

## **Hazards of Use**



### **WARNING**

The absence of instruction, or the inadequate imparting of instruction, can lead to incorrect or adverse use, and can give rise to accidents with far-reaching human, material, financial and environmental consequences.

**Precautions:**

All users must follow the safety directions given by the manufacturer and the directions of the person responsible for the product.

**CAUTION**

Watch out for erroneous measurement results if the product has been dropped or has been misused, modified, stored for long periods or transported.

**Precautions:**

Periodically carry out test measurements and perform the field adjustments indicated in the user manual, particularly after the product has been subjected to abnormal use and before and after important measurements.

**DANGER**

Because of the risk of electrocution, it is very dangerous to use grade rods and staffs in the vicinity of electrical installations such as power cables or electrical railways.

**Precautions:**

Keep at a safe distance from electrical installations. If it is essential to work in this environment, first contact the safety authorities responsible for the electrical installations and follow their instructions.

**WARNING**

If the product is used with accessories, for example masts, staffs, poles, you may increase the risk of being struck by lightning.

**Precautions:**

Do not use the product in a thunderstorm.

**WARNING**

Inadequate securing of the working site can lead to dangerous situations, for example in traffic, on building sites, and at industrial installations.

**Precautions:**

Always ensure that the working site is adequately secured. Adhere to the regulations governing safety and accident prevention and road traffic.

**CAUTION**

If the accessories used with the product are not properly secured and the product is subjected to mechanical shock, for example blows or falling, the product may be damaged or people may sustain injury.

**Precautions:**

When setting-up the product, make sure that the accessories are correctly adapted, fitted, secured, and locked in position. Avoid subjecting the product to mechanical stress.

**⚠ CAUTION**

During the transport, shipping or disposal of batteries it is possible for inappropriate mechanical influences to constitute a fire hazard.

**Precautions:**

Before shipping the product or disposing of it, discharge the batteries by running the product until they are flat. When transporting or shipping batteries, the person in charge of the product must ensure that the applicable national and international rules and regulations are observed. Before transportation or shipping contact your local passenger or freight transport company.

**⚠ WARNING**

Using a battery charger not recommended by Leica Geosystems can destroy the batteries. This can cause fire or explosions.

**Precautions:**

Only use chargers recommended by Leica Geosystems to charge the batteries.

**⚠ WARNING**

High mechanical stress, high ambient temperatures or immersion into fluids can cause leakage, fire or explosions of the batteries.

**Precautions:**

Protect the batteries from mechanical influences and high ambient temperatures. Do not drop or immerse batteries into fluids.

**⚠ WARNING**

Short circuited battery terminals can overheat and cause injury or fire, for example by storing or trans-

porting in pockets if battery terminals come in contact with jewellery, keys, metallized paper or other metals.

**Precautions:**

Make sure that the battery terminals do not come into contact with metallic objects.

**⚠ CAUTION**

During the operation of the product there is a hazard of squeezing extremities by moving parts.

**Precautions:**

Keep extremities in a safe distance from the moving parts.

**⚠ WARNING**

If the product is improperly disposed of, the following can happen:

- If polymer parts are burnt, poisonous gases are produced which may impair health.
- If batteries are damaged or are heated strongly, they can explode and cause poisoning, burning, corrosion or environmental contamination.
- By disposing of the product irresponsibly you may enable unauthorized persons to use it in contravention of the regulations, exposing themselves and third parties to the risk of severe injury and rendering the environment liable to contamination.

**Precautions**

The product must not be disposed with household waste.

Dispose of the product appropriately in accordance with the national regulations in force in your country.

Always prevent access to the product by unauthorized personnel.

Product specific treatment and waste management information can be downloaded from the Leica Geosystems home page at <http://www.leica-geosystems.com/> treatment or received from your Leica Geosystems dealer.



### WARNING

Only Leica Geosystems authorized service workshops are entitled to repair these products.

## Laser Classification

### General

The following directions (in accordance with the state of the art - international standard IEC 60825-1 (2007-03) and IEC TR 60825-14 (2004-02)) provide instruction and training information to the person responsible for the product and the person who actually uses the equipment, to anticipate and avoid operational hazards.

The person responsible for the product must ensure that all users understand these directions and adhere to them.

Products classified as laser class 1, class 2 and class 3R do not require

- laser safety officer involvement,
- protective clothes and eyewear,
- special warning signs in the laser working area if used and operated as defined in this user manual due to the low eye hazard level.

Products classified as laser class 2 or class 3R may cause dazzle, flash blindness and afterimages, particularly under low ambient light conditions.

### Roteo 20HV/25H/35/35G

The rotating laser produces a visible red/green laser beam which emerges from the rotating head.

The laser product with a stationary rotating head is classified as laser class 3R in accordance with \*):

- IEC 60825-1 (2007-03): "Safety of laser products".
- \*) Class 2 product if head is rotating.

### Class 3R laser products:

Direct intrabeam viewing may be hazardous (low level eye hazard), in particular for deliberate ocular exposure. The risk of injury for laser class 3R products is limited because of:

- a) unintentional exposure would rarely reflect worst case conditions of (e.g.) beam alignment with the pupil, worst case accommodation.
- b) inherent safety margin in the maximum permissible exposure to laser radiation (MPE)
- c) natural aversion behaviour for exposure to bright light for the case of visible radiation.



Description	Value
Maximum radiant power	< 2.7 mW c.w.
Pulse duration (effective)	4.5, 2.2, 1.5, 1.1 ms
Pulse repetition frequency	0, 2.5, 5, 7.5, 10 rps
Wavelength - Roteo 20HV/25H/35 - Roteo 35G	620-690 nm 529-535 nm
Beam divergence	< 1.5 mrad
NOHD (Nominal Ocular Hazard Distance) @ 0.25s	35 m / 115 ft
Scan angle	2 to 36°

**WARNING**

From a safety perspective class 3R laser products should be treated as potentially hazardous.

**Precautions:**

Prevent direct eye exposure to the beam. Do not direct the beam at other people.

**WARNING**

Potential hazards are not only related to direct beams but also to reflected beams aimed at reflecting surfaces such as prisms, windows, mirrors, metallic surfaces etc.

**Precautions:**

Do not aim at areas that are essentially reflective, such as mirror, or which could emit unwanted reflections.

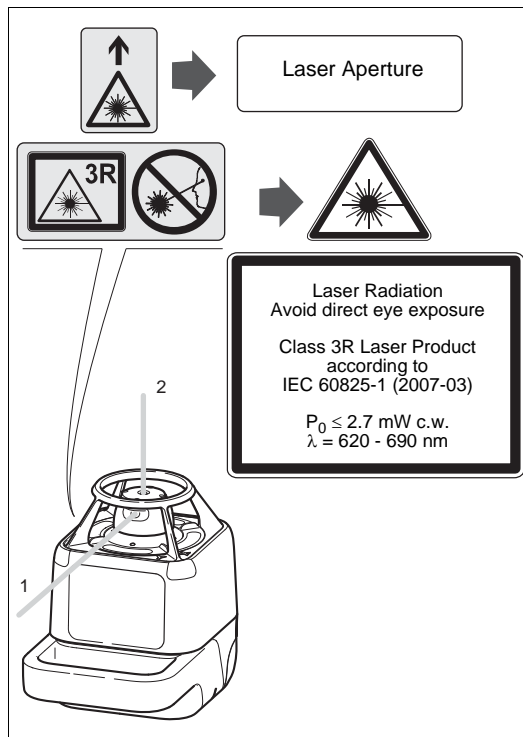
**Labelling, Laser Class 3R (Roteo 20HV/25H/35)**

- 1) Laser beam
- 2) Plumb beam

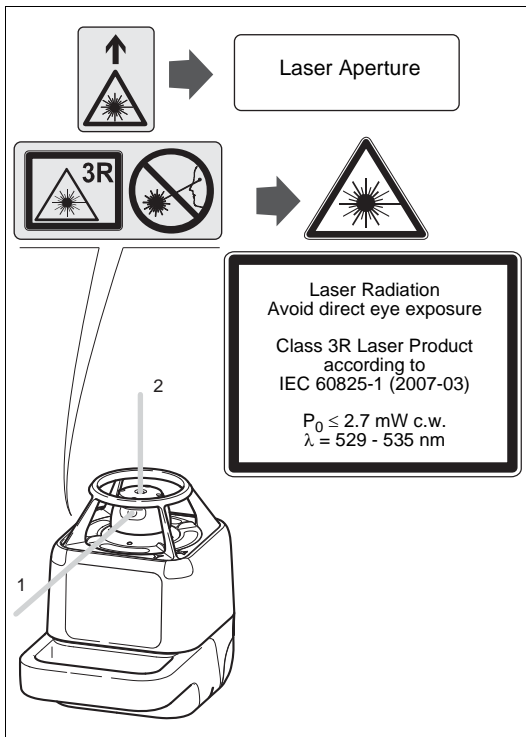

- 1) Laser beam
- 2) Plumb beam

## Electromagnetic Compatibility (EMC)

### Description

The term Electromagnetic Compatibility is taken to mean the capability of the product to function smoothly in an environment where electromagnetic radiation and electrostatic discharges are present, and without causing electromagnetic disturbances to other equipment.

### ⚠ WARNING

Electromagnetic radiation can cause disturbances in other equipment.

Although the product meets the strict regulations and standards which are in force in this respect, Leica Geosystems cannot completely exclude the possibility that other equipment may be disturbed.

### ⚠ CAUTION

There is a risk that disturbances may be caused in other equipment if the product is used in conjunction with accessories from other manufacturers, for example field computers, personal computers, two-way radios, non-standard cables or external batteries.

### Precautions:

Use only the equipment and accessories recommended by Leica Geosystems. When combined with the product, they meet the strict requirements stipulated by the guidelines and standards. When using computers and two-way radios, pay attention to the information about electromagnetic compatibility provided by the manufacturer.

### ⚠ CAUTION

Disturbances caused by electromagnetic radiation can result in erroneous measurements.

Although the product meets the strict regulations and standards which in this respect, Leica Geosystems cannot completely exclude the possibility product may be disturbed by very intense electromagnetic radiation, near radio transmitters, two-way radios or diesel generators.

**Precautions:**

Check the plausibility of results obtained under these conditions.

**WARNING**

If the product is operated with connecting cables attached at one of their two ends, for example, external supply cables, interface cables, the permitted level of electromagnetic radiation may be exceeded and the correct functioning of other products may be impaired.

**Precautions:**

While the product is in use, connecting cables, for example product to external battery, product to computer, must be connected at both ends.

dance with the instructions, may cause harmful interference to radio communication.

However, there is no guarantee that interference will not occur in a particular installation.

If this equipment does cause harmful interference to radio or television reception, which can be determined by turning the equipment off and on, the user is encouraged to try to correct the interference by one or more of the following measures:

- Reorient or relocate the receiving antenna.
- Increase the separation between the equipment and the receiver.
- Connect the equipment into an outlet on a circuit different from that to which the receiver is connected.
- Consult the dealer or an experienced radio/TV technician for help.

**WARNING**

Changes or modifications not expressly approved by Leica Geosystems for compliance could void the user's authority to operate the equipment.

## FCC Statement, Applicable in U.S.

**WARNING**

This equipment has been tested and found to comply with the limits for a Class B digital device, pursuant to part 15 of the FCC rules.

These limits are designed to provide reasonable protection against harmful interference in a residential installation.

This equipment generates, uses and can radiate frequency energy and, if not installed and used in accor-

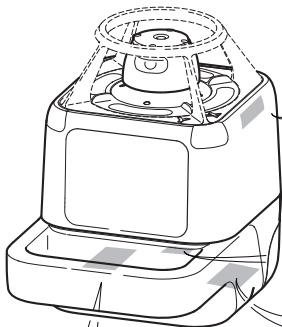

**Type: MWM 350** Art.No.: 762769  
Leica Geosystems AG

**Type: WM 200** Art.No.: 772792  
Leica Geosystems AG  
CH-9435 Heerbrugg  
Manufactured:  
S.No.:  
Made in China



**Type: Roteo 20HV**  
Art.No.: 772789





**Type: Roteo 25H**  
Art.No.: 772788



**Type: Roteo 35**  
Art.No.: 762768



**Type: Roteo 35G**  
Art.No.: 772787  
Power: 3.0V ~ / 1.5A  
Leica Geosystems AG  
CH-9435 Heerbrugg  
Manufactured:  
S.No.:  
Made in China



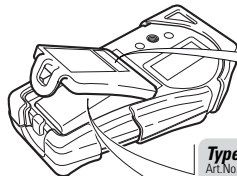

Complies with 21CFR 1040.10 and 1040.11 except for deviations pursuant to Laser Notice No.50, dated July 26, 2001.

This device complies with part 15 of the FCC Rules. Operation is subject to the following two conditions: (1) This device may not cause harmful interference, and (2) this device must accept any interference received, including interference that may cause undesired operation.



**Type: RRC350**  
Art.No.: 762771



**Type: RRC350G**  
Art.No.: 772795



**Type: R250**  
Art.No.: 772783  
Power: 9.0V ~ / 0.2A  
Leica Geosystems AG  
CH-9435 Heerbrugg  
Manufactured:  
S.No.:  
Made in China  
This device complies with part 15 of the FCC Rules. Operation is subject to the following two conditions: (1) This device may not cause harmful interference, and (2) this device must accept any interference received, including interference that may cause undesired operation.



**Type: RC350**  
Art.No.: 762770



Power: 1.5V ~ / 0.4A  
Leica Geosystems AG  
CH-9435 Heerbrugg  
Manufactured:



	Roteo 35	Roteo 35G	Roteo 20HV	Roteo 25H
Operating Range (rotating beam)	up to 150 m (500 ft) (Radius) with receiver			
Self-leveling Accuracy*	±3 mm at 30 m (±1/8" at 100 ft)			
Automatic Leveling	horizontal, vertical			horizontal
Self-leveling Range	± 4.5°			
Rotation Speeds	0, 150, 300, 450, 600 rpm			600 rpm
Scanning Angle	variable from 2° to 36°			n/a
Laser Diode Type	635 nm (red)	532 nm (green)	635 nm (red)	
Wall-mount	motorized		manual	n/a
Dimensions (H xW x D)	189 x 136 x 208 mm (7.4 x 5.4 x 8.2") (w/o wall-mount)			
Weight with Batteries	1.7 kg (3.7 lbs)			
Batteries	Alkaline D-cells 2 x 1.5 V*** or Rechargeable (NiMH)			
Battery life - alkaline / NiMH**	50 hrs. (Rechargeable), 160 hrs. (Alkaline)	25 hrs. (Rechargeable), 40 hrs. (Alkaline)	50 hours (Rechargeable), 160 hours (Alkaline)	50 hours (Rechargeable), 160 hours (Alkaline)
Operating temperature	-10 to +50°C (14 to +122°F)	0 to +40°C (32 to +104°F)	-10 to +50°C (14 to +122°F)	
Storage temperature (without batteries)	-20 to +70°C (-4 to +158°F)			
Protection against water	IP54, dust-proof, splash-proof			

**RC-350 IR Remote Control**

IR Remote range	up to 30 m (100 ft)
Batteries	one AA alkaline battery***

**RRC-350 IR Remote Receiver Control**

Batteries	a 9-volt type alkaline battery***
-----------	-----------------------------------

**R-250 IR Receiver**

Batteries	a 9-volt type alkaline battery***
-----------	-----------------------------------

**NiMH Battery Pack**

Input voltage	7.5 VDC
Input current	1.0 A
Charge time	8 hrs

**NiMH Charger/Adapter**

Input voltage	100-240 VAC, 55-60 Hz
Output voltage	7.5 VDC
Output current	1.0 A
Polarity	Shaft - neg, Tip - pos

\* Accuracy is defined at 25°C

\*\* Battery life is dependent upon environmental conditions

\*\*\* Leakage proof alkaline batteries strongly recommended

**International Limited Warranty**

This product is subject to the terms and conditions set out in the International Limited Warranty which you can download from the Leica Geosystems home page at <http://www.leica-geosystems.com/internationalwarranty> or collect from your Leica Geosystems distributor. The foregoing warranty is exclusive and is in lieu of all other warranties, terms or conditions, express or implied, either in fact or by operation of law, statutory or otherwise, including warranties, terms or conditions of merchantability, fitness for a particular purpose, satisfactory quality and non-infringement, all of which are expressly disclaimed.

**Total Quality Management: Our commitment to total customer satisfaction.**



Leica Geosystems AG, Heerbrugg, Switzerland, has been certified as being equipped with a quality system which meets the International Standards of Quality Management and Quality Systems (ISO standard 9001) and Environmental Management Systems (ISO standard 14001).

**Ask your local Leica dealer for more information about our TQM program.**

**Leica Geosystems AG**  
Heinrich-Wild-Strasse  
CH-9435 Heerbrugg  
Switzerland  
Phone +41 71 727 31 31

- when it has to be **right**

**[www.leica-geosystems.com](http://www.leica-geosystems.com)**

Download from [Www.Somanuals.com](http://Www.Somanuals.com). All Manuals Search And Download.

763096-1.2.0

Copyright Leica Geosystems AG, Heerbrugg,  
Switzerland 2009

**Leica**  
**Geosystems**

## Free Manuals Download Website

<http://myh66.com>

<http://usermanuals.us>

<http://www.somanuals.com>

<http://www.4manuals.cc>

<http://www.manual-lib.com>

<http://www.404manual.com>

<http://www.luxmanual.com>

<http://aubethermostatmanual.com>

Golf course search by state

<http://golfingnear.com>

Email search by domain

<http://emailbydomain.com>

Auto manuals search

<http://auto.somanuals.com>

TV manuals search

<http://tv.somanuals.com>