



# LEICA NOCTILUX-M 50 mm f/0.95 ASPH.



The LEICA NOCTILUX-M 50mm f/0.95 ASPH offers a unique range of features. A noticeably (11%) higher speed has been achieved in a body with almost the same diameter and only very slightly longer than its predecessor, the Noctilux-M 50mm f/1. At the same time, its rendition quality significantly exceeds that of its predecessor, while retaining the typical, slightly soft reproduction of the previous lens. Even at full stop, the LEICA NOCTILUX-M 50mm ASPH f/0.95 demonstrates excellent reproduction quality, which only deteriorates slightly towards the edges - while the slightly smaller format of the Leica M8 models only capture less of these areas anyway. Stopping down brings a continuous significant improvement in performance, up to an exceptional level over the entire image field at 5.6. Even in the close-up range, this performance is largely retained thanks to a "floating element". The strikingly low degree of vignetting for such a high speed lens is a maximum - i.e. in the corners of the image - of just 3.2 stops at full aperture in 35mm format, or around 1.5 on the Leica M8 models. Stopping down to 2 visibly reduces this light falloff towards the edge of the image, with practically only the natural vignetting remaining. Distortion is slightly barrel-shaped and, at a maximum of just 1%, is hardly perceptible in practice. The construction is similar to a double Gauss type and uses a total of eight lenses to achieve this excellent performance. Of these, five are made of glass types with anomalous color dispersion (partial dispersion) to correct color defects, while three simultaneously have extremely high refractive power. Because of their large diameter, the two aspherical lens surfaces are produced by meticulous grinding and polishing. To maintain performance in the close-up range, the rearmost element of the optical system is a "floating element", i.e. it moves independently of the rest of the mechanism.

Summary: The LEICA NOCTILUX-M 50mm f/0.95 ASPH represents a unique high performance lens. It combines exceptionally high speed with an image performance that ranks alongside that of today's leading lenses and once again extends the composition options of Leica M photography.

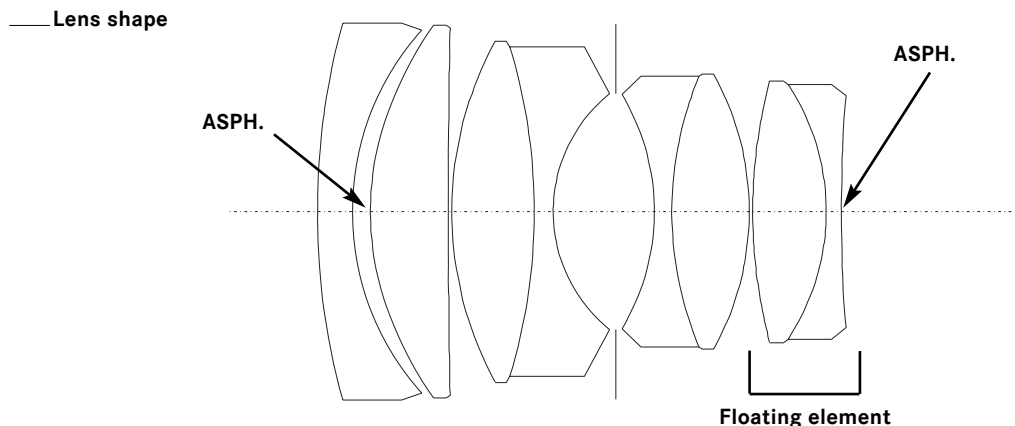



— Engineering drawing

**Technical Data**

<b>Angle of view (diagonal, horizontal, vertical)</b>	47° / 40° / 27°
<b>Optical design</b>	<b>Number of lenses/groups:</b> 8 / 5 <b>Focal length:</b> 52.3 mm <b>Position of entrance pupil:</b> 50.6 mm (related to the first lens surface in light direction) <b>Focusing range:</b> 1 m to infinity
<b>Distance setting</b>	<b>Scales:</b> Combined meter/feet graduation <b>Smallest object field:</b> 406 mm x 608 mm <b>Largest reproduction ratio:</b> 1:17
<b>Aperture</b>	<b>Setting/Function:</b> With click-stops, half values available <b>Lowest value:</b> 16
<b>Bayonet</b>	Leica M quick-change bayonet with 6 bit lens identification bar code for digital M models
<b>Filter mount</b>	Screw-on filter E60 with accessory filter holder
<b>Lens hood</b>	Yes, extendable
<b>Dimension and weight</b>	<b>Length:</b> approx. 75.1 mm <b>Largest diameter:</b> approx. 73 mm <b>Weight:</b> approx. 700 g

— MTF graphs

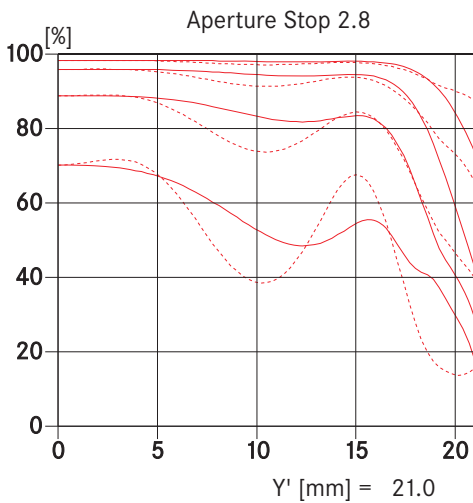
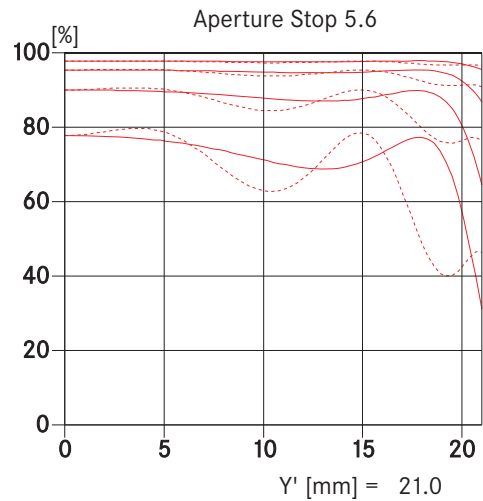
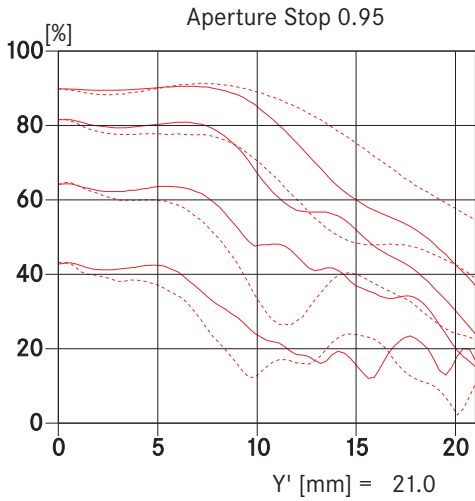

The MTF is indicated both at full aperture and at f/5.6 at long taking distances (infinity). Shown is the contrast in percentage for 5, 10, 20 and 40 lp/mm across the height of the 35 mm film format, for tangential (dotted line) and sagittal (solid line) structures, in white light. The 5 and 10 lp/mm will give an indication regarding the contrast ratio for large object structures. The 20 and 40 lp/mm records the resolution of finer and finest object structures.

- sagittal structures
- - - tangential structures

— Distortion

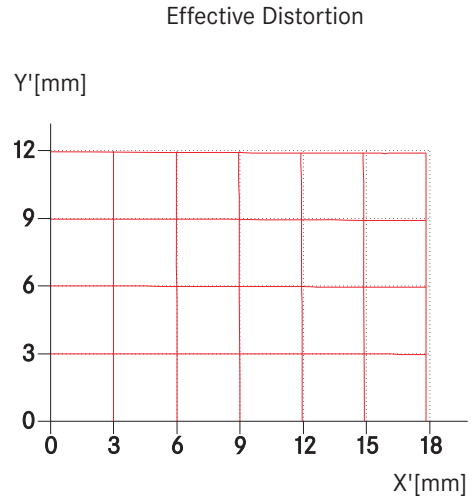
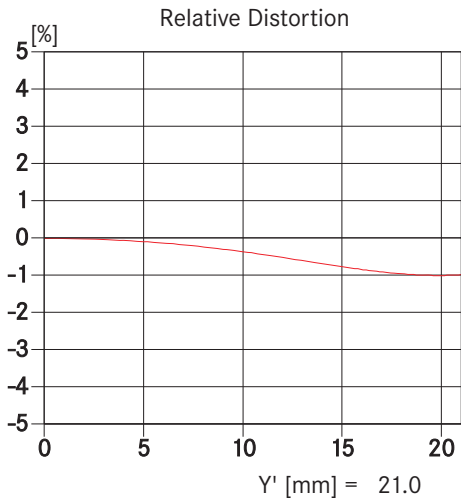

— Vignetting

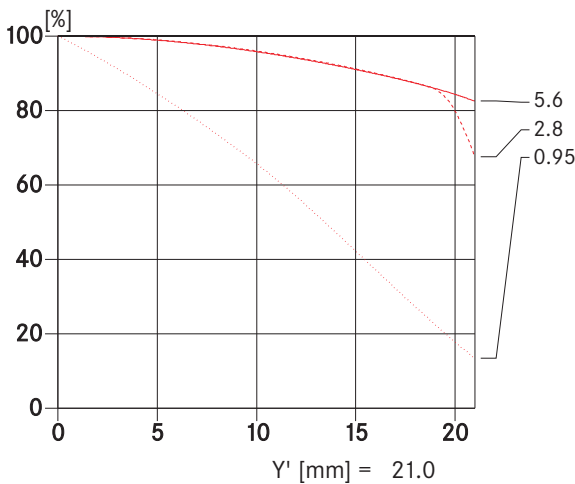

Distortion is the deviation of the real image height (in the picture) from the ideal image height. The relative distortion is the percentage deviation. The ideal image height results from the object height and the magnification. The image height of 21.6mm is the radial distance between the edge and the middle of the image field for the format 24mm x 36mm. The graph of the effective distortion illustrates the appearance of straight horizontal and vertical lines in the picture.

Vignetting is a continuous decrease of the illumination to the edges of the image field. The graph shows the percentage loss of illumination over the image height. 100% means no vignetting.



### Depth of field table

Distance Setting [m]	Aperture Stop									Magnification
	0,95	1,4	2	2,8	4	5,6	8	11	16	
1	0,990 - 1,010	0,986 - 1,015	0,980 - 1,021	0,972 - 1,030	0,960 - 1,044	0,945 - 1,063	0,923 - 1,092	0,897 - 1,131	0,858 - 1,204	1/16,9
1,2	1,185 - 1,215	1,179 - 1,222	1,170 - 1,232	1,158 - 1,245	1,141 - 1,265	1,120 - 1,294	1,088 - 1,339	1,052 - 1,400	0,997 - 1,516	1/20,7
1,5	1,476 - 1,525	1,466 - 1,535	1,452 - 1,551	1,434 - 1,573	1,407 - 1,606	1,374 - 1,653	1,326 - 1,729	1,271 - 1,835	1,189 - 2,045	1/26,4
2	1,957 - 2,045	1,939 - 2,065	1,914 - 2,094	1,882 - 2,135	1,835 - 2,198	1,777 - 2,289	1,697 - 2,441	1,606 - 2,663	1,475 - 3,142	1/36
3	2,902 - 3,105	2,862 - 3,152	2,807 - 3,222	2,737 - 3,321	2,638 - 3,481	2,516 - 3,720	2,354 - 4,150	2,180 - 4,852	1,941 - 6,772	1/55
5	4,730 - 5,303	4,622 - 5,446	4,478 - 5,662	4,299 - 5,979	4,055 - 6,528	3,772 - 7,442	3,414 - 9,425	3,053 - 14,16	2,598 - 89,26	1/93,1
10	8,97 - 11,31	8,581 - 11,99	8,090 - 13,10	7,517 - 14,96	6,796 - 19,01	6,026 - 29,79	5,153 - 202,2	4,365 - ∞	3,482 - ∞	1/188
∞	85,64 - ∞	59,73 - ∞	41,85 - ∞	29,91 - ∞	20,95 - ∞	14,98 - ∞	10,50 - ∞	7,654 - ∞	5,279 - ∞	1/∞

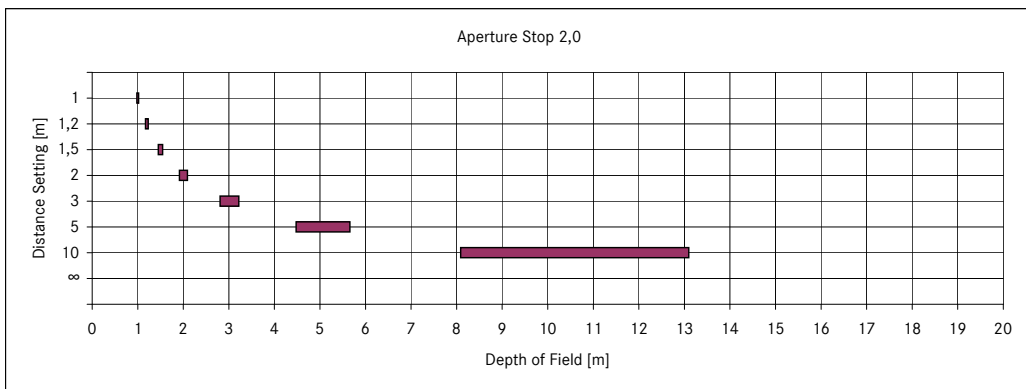
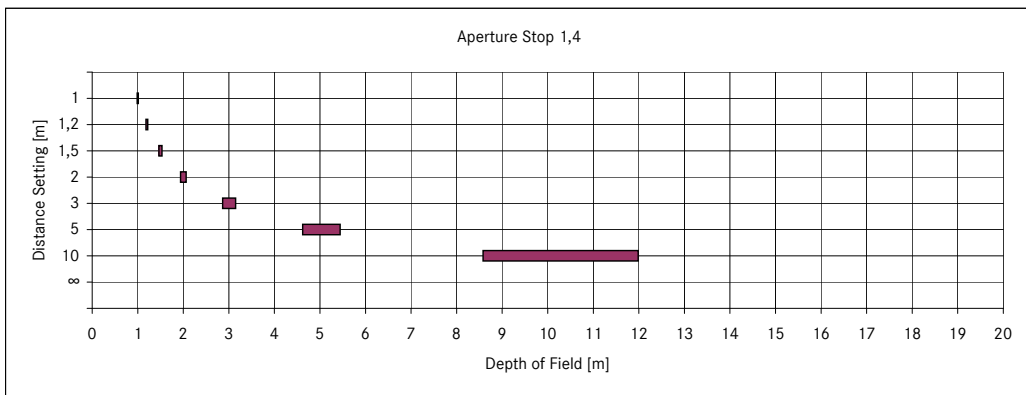
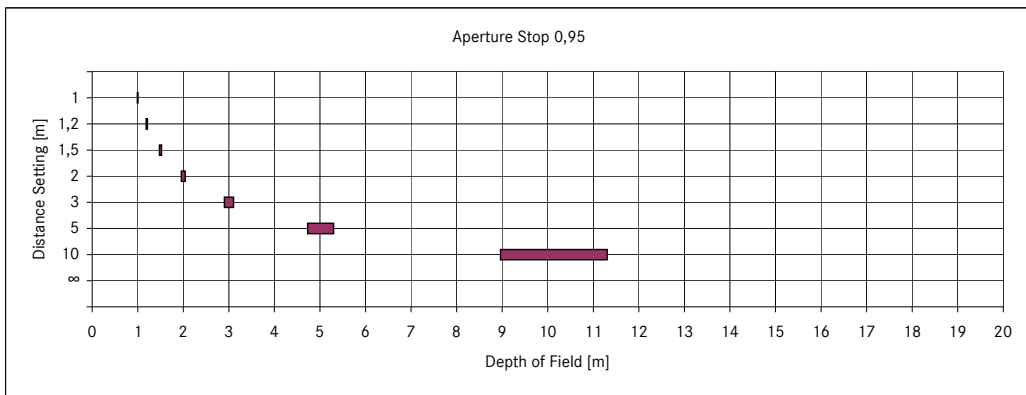

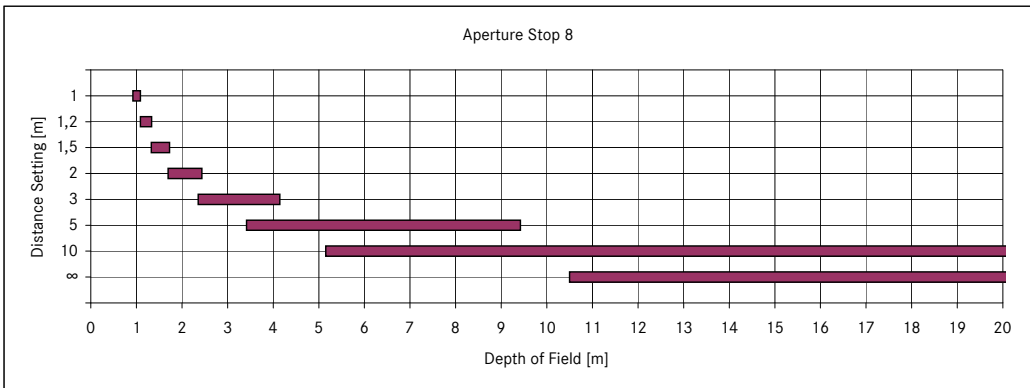
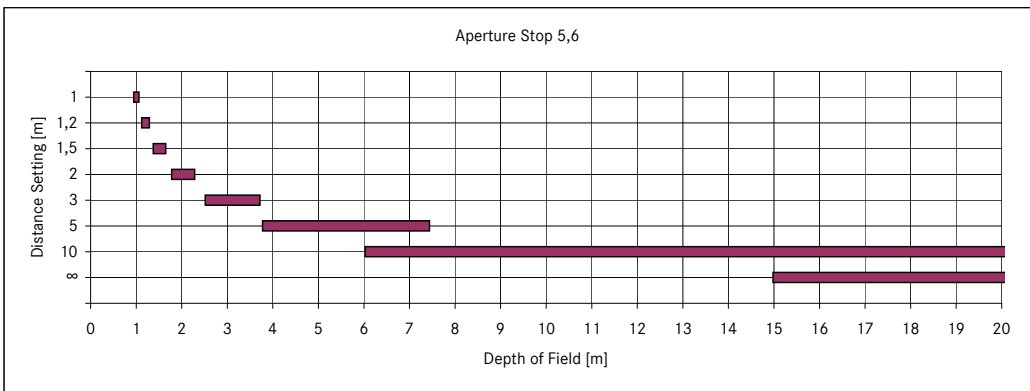
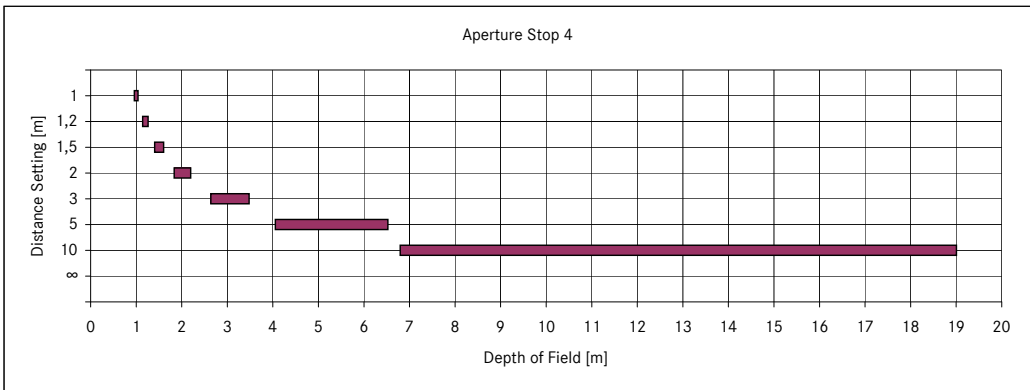
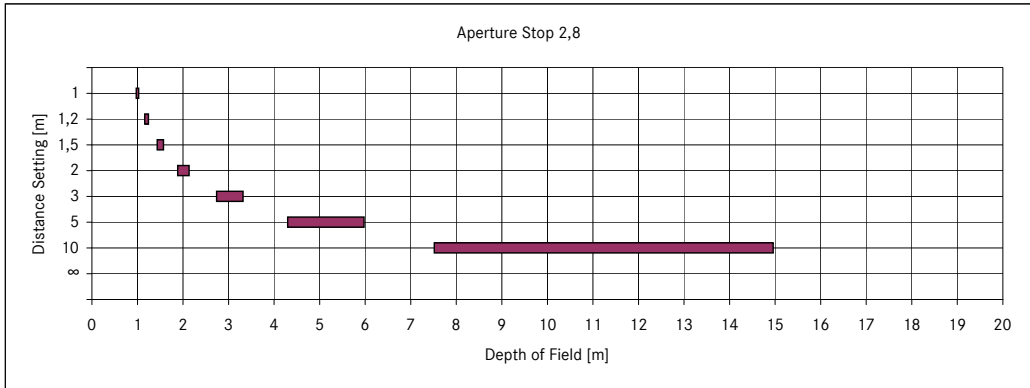

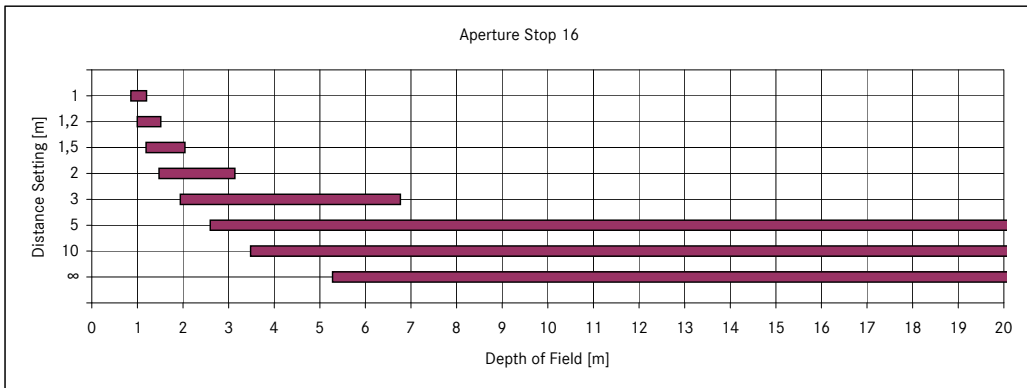
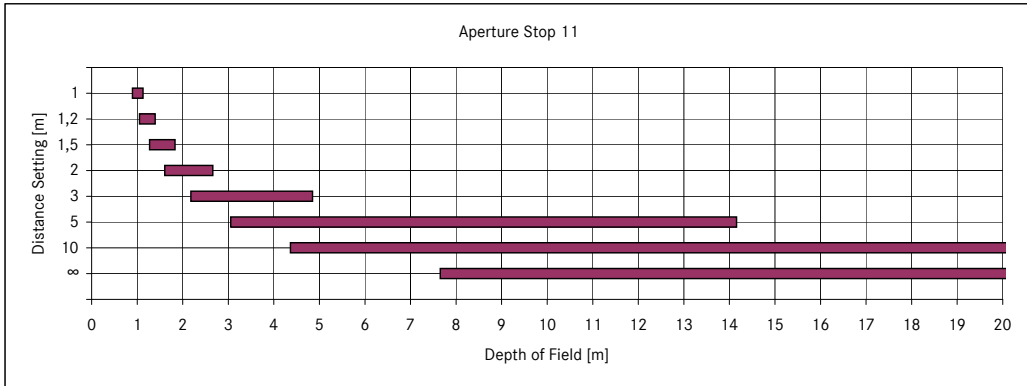

## Free Manuals Download Website

<http://myh66.com>

<http://usermanuals.us>

<http://www.somanuals.com>

<http://www.4manuals.cc>

<http://www.manual-lib.com>

<http://www.404manual.com>

<http://www.luxmanual.com>

<http://aubethermostatmanual.com>

Golf course search by state

<http://golfingnear.com>

Email search by domain

<http://emailbydomain.com>

Auto manuals search

<http://auto.somanuals.com>

TV manuals search

<http://tv.somanuals.com>