

## Amplified Cordless Phone Model: KR2812

### USER MANUAL

## TABLE OF CONTENTS

<b>Table of Contents</b> .....	2
<b>Important Safety Instructions</b> .....	5
<b>Safety and Care</b> .....	7
Safety Precautions .....	7
Caring for Your Product .....	7
Caution .....	7
<b>Introduction</b> .....	8
Main Features .....	8
Package Contents .....	9
<b>Product Overview</b> .....	10
Handset and Base Unit - Front View .....	10
Handset and Base Unit - Back View .....	11
LCD Display Symbols .....	11
<b>Getting Started</b> .....	12
Connecting AC Adaptor / Phone Line .....	12
Installing Handset Batteries .....	12
Charging Handset Batteries .....	13
Low Battery Warning .....	13
Attaching the Belt Clip .....	13
Wall-Mounting the Base Unit .....	14
Initialization and Standby Mode .....	14
Handset Reception .....	14
Using Handset Keys .....	15
<b>Basic Handset Functions</b> .....	15
Making Calls .....	15
Receiving / Ending Calls .....	16
Adjusting Volume .....	16
Amplifying Volume .....	16
Muting Volume .....	16
Adjusting Tone.....	17
Using Pre-Dial .....	17
Last Number Redial.....	17
Using the Pause .....	17

Call Waiting .....	17
<b>Using the Phonebook .....</b>	<b>18</b>
Adding a Phonebook Entry .....	18
Editing a Phonebook Entry .....	19
Deleting a Phonebook Entry .....	19
Deleting All Phonebook Entries .....	19
Calling a Stored Phonebook Entry .....	20
<b>Emergency and Direct Number Memory .....</b>	<b>20</b>
Memory Menu .....	21
<b>Caller ID Display .....</b>	<b>21</b>
Viewing Caller ID Records .....	22
Saving Caller ID Records in the Phonebook .....	23
Changing the Caller ID Number Format .....	24
Edit the Call Log Number Before Dialing .....	24
Erasing a Caller ID Record .....	24
Erasing All Caller ID Records .....	25
Dialing a Caller ID Record .....	25
<b>Additional Phone Functions .....</b>	<b>26</b>
Using the Intercom .....	25
Transferring Calls .....	25
Making a Conference Call .....	26
One-way Base Paging .....	26
<b>Menu Settings .....</b>	<b>26</b>
Navigating Handset Menus .....	26
Language.....	27
Ring Setting .....	27
Set Time .....	28
Phone Setup .....	30
Security Setting / Registering Additional Handsets .....	32
Default Settings .....	34
<b>Troubleshooting .....</b>	<b>35</b>
<b>Specifications .....</b>	<b>36</b>
<b>About Krown .....</b>	<b>36</b>
<b>FCC Statement .....</b>	<b>36</b>

<b>Declaration of Conformity .....</b>	<b>37</b>
<b>Lightning .....</b>	<b>38</b>
<b>Consumer Information .....</b>	<b>38</b>
<b>Warranty.....</b>	<b>39</b>

**EN**

## IMPORTANT SAFETY INSTRUCTIONS

Some of the following information may not apply to your particular product. However, when using telephone equipment, basic safety precautions should always be followed to reduce the risk of fire, electric shock and injury to persons, including the following:

1. Read and understand all instructions.
2. Follow all warnings and instructions marked on the product.
3. Unplug this product from the wall outlet before cleaning. Do not use liquid cleaners or aerosol cleaners. Use a damp cloth for cleaning.
4. This product should not be used while you are in a bathtub, shower or pool. Immersion of the product in water could cause an electrical shock.
5. Slots and openings in the cabinet back or bottom are provided for ventilation, to protect it from overheating. These openings must not be blocked or covered. The openings should never be blocked by placing the product on the bed, sofa, rug, or other similar surface. This product should not be placed in a built-in installation unless proper ventilation is provided.
6. This product should be operated only from the type of power source indicated on the marking label. If you are not sure of the type of power supplied to your home, consult your dealer or local power company.
7. Do not allow anything to rest on the power cord. Do not locate this product where the cord will be abused by persons walking on it.
8. Do not overload wall outlets and extension cords as this can result in the risk of fire or electric shock.
9. Never push objects of any kind into this product through cabinet slots as they may touch dangerous voltage points or short out parts that could result in a risk of fire or electric shock. Never spill liquid of any kind on the product.
10. To reduce the risk of electric shock, do not disassemble this product, but take it to a qualified serviceman when service or repair work is required. Opening or removing covers may expose you to dangerous voltages or other risks. Incorrect reassembly can cause electric shock when the telephone equipment is subsequently used.
11. Do not expose the product to extreme temperatures such as areas near a hot radiator or stove or in a hot car.
12. Do not place lighted candles, cigarettes, etc., on the telephone.

13. Never touch uninsulated telephone wires or terminals unless the telephone line has been disconnected at the network interface.
14. Never install or modify telephone wiring during a lightning storm.
15. Never install telephone jacks in wet locations unless the jack is specifically designed for wet locations.
16. Use caution when installing or modifying telephone lines to prevent electrical shock and/or fire.
17. Unplug this product from the wall outlet and refer servicing to qualified service personnel under the following conditions:
  - A. When the power supply cord or plug is damaged or frayed.
  - B. If the product has been exposed to rain or water.
  - C. If the product does not operate normally by following the operating instructions.
  - D. If the product's cabinet has been damaged.
  - E. If the product exhibits a distinct change in performance.
18. Do not use the telephone to report a gas leak in the vicinity of the leak.
19. Do not place this product on an unstable cart, stand or table. The product may fall, causing serious damage to the product.
20. Use only the power cord and batteries indicated in this manual. Do not dispose of batteries in a fire. They may explode.
21. For servicing or replacement, you can purchase a suitable headset through service center or retailer shop.



## CAUTION

You must use a Class 2 power source that supplies 9V DC and delivers at least 500mA.

Its plug must fit the phone's DC jack. The adapter supplied meets these specifications. Using an adapter that does not meet these specifications could damage the phone or the adapter.

Always connect the AC adapter to the phone before you connect it to AC power. When you finish, disconnect the adaptor from AC power before you disconnect from the phone.

**SAVE THESE INSTRUCTIONS**

## SAFETY AND CARE

Observe the following safety precautions and warnings when setting up and using this product.

### SAFETY PRECAUTIONS

- LCD panel – The LCD panel is made of glass, and may break if the unit is dropped. Place the unit securely on a stable surface.
- Heat sources – Keep the product away from heat sources, such as radiators, stoves, heaters, and other heat-generating products.
- Water and moisture – Do not use the product in or near water or in high moisture areas, such as a bathroom.
- The KR2812 is designed for indoor use only. Do not place the handset in direct sunlight, as this will damage the LCD and invalidate your warranty.

### CARING FOR YOUR PRODUCT

- Do not clean any part of your phone with benzene, thinner or other solvent chemicals as this may cause permanent damage that is not covered by the warranty. When necessary, clean it with a damp cloth.
- Keep your phone away from hot, humid conditions or strong sunlight.
- Never immerse the unit in water or use your phone outdoors in the rain, or handle it with wet hands.
- Do not subject the base unit to extreme force, shock, or fluctuations in humidity.
- Do not tamper with the internal components or disassemble the unit.
- Do not mix new and old batteries or batteries of different types  
Replace batteries with the same or equivalent type recommended by the manufacturer.
- Every effort has been made to ensure the highest standards of reliability for your phone. However, if something does go wrong, do not try to repair it yourself – consult your supplier.

### CAUTION

- Dispose of old, defective batteries in an environmentally friendly manner in accordance with the relevant legislation.
- No open flames, such as lighted candles, should be placed near the apparatus.
- **Never** use your phone in the open air during a thunderstorm – unplug

the base unit from the phone line and the A/C power when there are storms in your area.

- **Do not** install the base unit near a sink, bath or shower, or anywhere it could get wet. Electrical equipment can cause serious injury if used while you are wet or standing in water.
- If the base unit ever falls into water, do not retrieve it until you have unplugged the power lead from the A/C wall outlet and the phone line from the phone outlet; then pull it out by the unplugged cables.
- When handling batteries exercise care. Contact with conductive materials can short the batteries. To avoid the risk of fire never use non-rechargeable batteries.
- Use only the power source marked on the power supply (adaptor). If you are unsure of the power supplied to you home, consult your power company. Do **not** place objects on the power cord.
- **Never** use this unit near a gas leak as this can cause explosions.
- Occasional loss of synchronization between the handset and base unit is normal if there is significant interference from the surrounding environment.
- Disconnect the telephone line from the wall-outlet before replacing the battery.

## INTRODUCTION

Thank you for selecting the Krown Amplified Cordless Phone model KR2812. Based on the 2.4GHz ISM FHSS WDCT platform, the KR2812 cordless phone provides the freedom to communicate from anywhere in your home, making phone conversations louder, clearer and easier to understand.

## MAIN FEATURES

- Long-range cordless communications between handset and base unit up to 300 meters / 980 feet (outdoors) without obstacles
- Loud base unit ringer up to 95dBSPL(A) with Amplify handset volume option for enhanced audio clarity; rubberized earpiece cushion for comfortable listening
- 24 large, easy-press handset navigation / number keys with backlight, including 5 programmable preset emergency and direct memory keys, and 1 tone control key
- Extended handset operation time of 6.5 hours with standby time of at least 100 hours



- 3.6V rechargeable battery pack provides long-lasting cordless use
- Up to 3 additional handsets (not supplied) can be used with the same base unit
- Bright handset LCD can display information in English, French or Spanish with large font display option
- Save up to 99 24-digit phonebook / Caller ID records; review and edit all information in one screen with call time display and single-digit name search
- Convenient handset rotary audio volume control and base unit ringer slide switch; user-selectable ring tones and audio volume settings
- Real-time clock in 12/24-hour format with alarm function
- Large, easy-to-view LED ringer indicator on base and handset units
- Other phone features include intercom, call waiting, call transferring, multi-party conferencing, one-way base-to-handset paging, handset manual / auto-answer, baby call, message waiting indication and, pulse / tone dialing modes.

**NOTE** To use the call waiting and caller ID features you must subscribe to these services from your phone service provider.

**EN**

## PACKAGE CONTENTS

- Handset
- Rechargeable handset battery
- Base unit
- AC / DC adaptor for base unit
- Phone line for base unit
- Belt clip for handset
- Wall mount hanger
- User manual

**NOTE** Keep this manual handy as you use your new product. It contains practical step-by-step instructions, as well as technical specifications and warnings you should know.

## PRODUCT OVERVIEW

### HANDSET AND BASE UNIT - FRONT VIEW

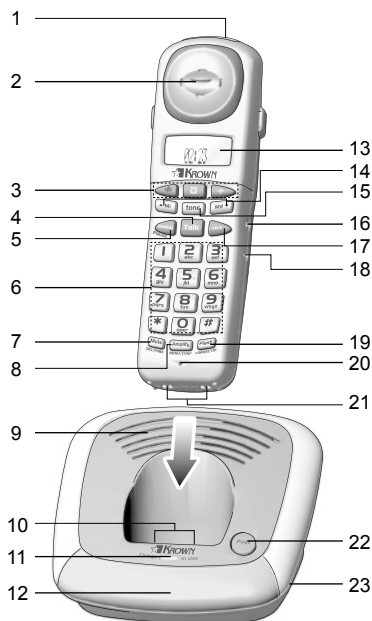

1. Visual ringer alert
2. Receiver
3. Emergency number memory  
🔥 Fire / 🚒 Police / +  
Ambulance
4. **Talk**: answer and end calls
5. **Redial / Pause**
6. **0-9, \*, # numeric keypad**:  
enter numbers and characters
7. **Mute / DEL / PHBK**
8. **Amplify; MENU / CONF**:  
amplify volume level; enter  
menu settings
9. Base Speaker
10. Charging contacts on base  
unit
11. Charging / In Use LED
12. Base visual ringer alert
13. LCD display
14. Direct number memory  
▲ **M1 / M2** ▼: view Caller ID  
log; navigate menus and  
settings
15. **Tone**: adjust receiver tone
16. 📶 Neck loop jack
17. **INT**: dial internal line
18. 📞 Headset jack
19. **Flash; FORMAT / CID**
20. Microphone
21. Charging contacts on phone
22. **Page**: pages handsets (up to 4)
23. **Ringer Hi-Low-Off** switch

EN

## HANDSET AND BASE UNIT - BACK VIEW

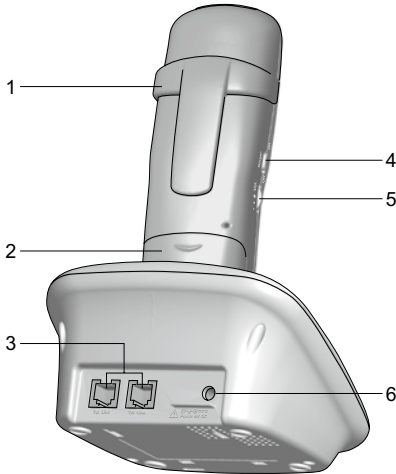

1. Detachable belt clip
2. Battery compartment
3. Jacks for telephone and auxiliary lines
4. Ringer On / Off
5. Rotary volume control
6. Jack for base unit power supply(9V DC)

EN

## LCD DISPLAY SYMBOLS

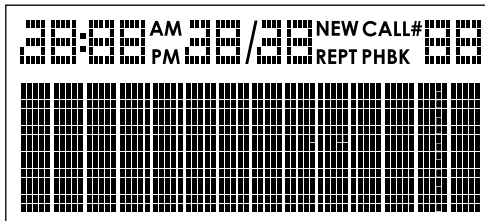

There are 3 rows to display phone information according to the corresponding highest-to-lowest priority: incoming call indication, alarm, external line in use, handset name / clock.

- Top row: displays status icons and shows date / time, call-log number index and phone book number index.
- Second row: displays phone name (name of caller) information.
- Third row: displays phone number information.

**NOTE:** When any key is pressed on the handset, the LCD and keypad back-light will light up.

## GETTING STARTED

### CONNECTING A/C ADAPTOR / PHONE LINE

Plug one end of the telephone line cord into the Tel. Line jack on the back of the base and the other end into a phone jack. Plug the adaptor into the jack on the back of the base and the other end of the adaptor into the electrical outlet.

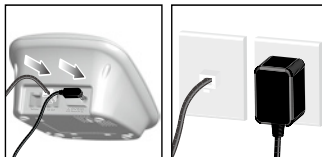

**NOTE:** The auxiliary line jack can be used to connect an additional telephone and a telephone signaling device to the same line as the base unit.

### INSTALLING HANDSET BATTERIES

The handset uses a rechargeable 600 mAh 3.6V (AA) Ni-Cd (Nickel Cadmium) battery pack (SANIK, type no. 3SN-AA60-S-J1F).

#### To insert the handset battery pack:

1. Slide the battery compartment cover off.
2. Insert the battery pack into the compartment, ensuring the red-black wire mini-connector is plugged into the corresponding socket.



3. Slide the cover back until it clicks firmly into place.

**WARNING:** Risk of explosion if battery is replaced by an incorrect type. Dispose of used batteries according to the instructions.

#### BATTERY SAFETY PRECAUTIONS

- Do not burn, disassemble, mutilate, or puncture. Like other batteries of this type toxic materials could be released which can cause injury.
- Cadmium is a chemical recognized by the State of California to cause cancer.
- Do not short-circuit the battery.
- Do not place the rechargeable nickel-cadmium battery used in this equipment in any charger other than the one designed to charge this battery as specified in the user manual.
- To reduce the risk of fire or personal injury, use only the battery listed in the User Manual.

- Rechargeable Nickel-Cadmium batteries must be recycled or disposed of properly.
- Keep batteries out of the reach of children.
- Remove batteries if storing over 30 days.

## Rechargeable Nickel–Cadmium Batteries Must Be Recycled or Disposed of Properly

**NOTE:** The RBRC seal on the battery used in your KROWN product indicates that we are participating in a program to collect and recycle Nickel Cadmium batteries throughout the United States. Please call 1-800-8-BATTERY for information or contact your local recycling center. RBRC(R) is a registered trademark of the Rechargeable Battery Recycling Corporation.



### CHARGING HANDSET BATTERIES

Place the handset in the handset cradle of the base unit to charge. Allow the handset to charge for 14 hours before use.

EN

### LOW BATTERY WARNING



When the battery is low on power, the handset emits a tone and “LOW BATTERY” appears on the display.

### ATTACHING THE BELT CLIP

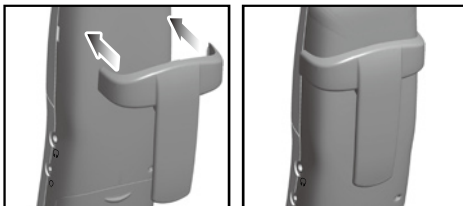

## WALL-MOUNT THE BASE UNIT

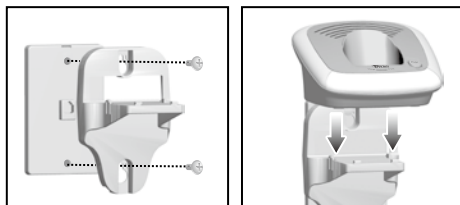

## INITIALIZATION AND STANDBY MODE

After inserting the battery (handset) and A/C power (base unit), both go to standby mode directly. All previously saved settings are kept. During normal operation, the handset's display shows handset name / time and the base unit LED is off.

**NOTE:** Do not adjust volume by pressing Amplify directly after initialization.

## HANDSET RECEPTION

When outdoors, the handset can be used up to 300 meters (approx. 980 feet) away from the base unit. When indoors, the handset can be used up to 50 meters (approx. 160 feet) from the base unit. An out-of-range tone is generated if the handset is nearly out of range. If the handset connection is completely lost, the base station automatically goes on-hook and "OUT OF RANGE" is displayed on the LCD.

During outdoor and indoor use, the effective range is dependent upon the surrounding environment, i.e., obstacles or interference that may affect transmission. Interference from electrical appliances such as a TV, microwave or mobile phone should be avoided.

**NOTE:** Due to radio interference, occasional loss of synchronization between the handset and base unit may occur. If this happens the base unit will quickly switch to another channel automatically to restore synchronization.

EN

## USING HANDSET KEYS

Characters are entered by pressing the 0...9, \* and # keys. A consecutive press of the same key will enter a different character according to the table below:

Key	Character versus key press numbers					
	1	2	3	4	5	6
1	<i>space</i>	1	,	.	;	:
2	A(a)	B(b)	C(c)	2	(	[
3	D(d)	E(e)	F(f)	3	)	]
4	G(g)	H(h)	I(i)	4	\$	<
5	J(j)	K(k)	L(l)	5	'	>
6	M(m)	N(n)	O(o)	6	+	-
7	P(p)	Q(q)	R(r)	S(s)	7	%
8	T(t)	U(u)	V(v)	8	~	^
9	W(w)	X(x)	Y(y)	Z(z)	9	=
0	0	/	\	&		_
*	*	#	?	!	{	}
#	Toggle between upper / lower case letters					

Characters can be generated or deleted by multiple presses of the numerical or **DEL** key

## BASIC HANDSET FUNCTIONS

### MAKING CALLS

EXTERNAL CALL  
TALK 00:06 U01

1. Pick up the handset and press **Talk**.
2. Use the numeric keypad **0...9** to dial the phone number you want to call. If an external call is successfully made, "TALK" is shown on the LCD and you may begin speaking into the handset microphone.

## RECEIVING / ENDING CALLS

When the base unit receives a call, the handset rings immediately. If there is no Caller ID available, the LCD displays "EXTERNAL CALL". Pick up the handset and press **Talk** at any time to begin the conversation.

### To end a call:

During a call, press **Talk** to end the current connection at any time OR place the handset in the base unit. The handset returns to standby mode.

## ADJUSTING VOLUME



The volume level ranges from 1 to 4 and is shown in the lower right side of the display. To adjust volume during a call, rotate the volume control on the handset.

## AMPLIFYING VOLUME



Amplifying volume enhances sound quality so a conversation can be heard more clearly for a selected volume level. The Amplify function further increases a volume level by 25dB.

### To amplify volume during a call:

Press **Amplify** to toggle between amplified / normal volume level. When amplified volume is selected, a display with volume level is shown.

**WARNING:** Make sure to lower or minimize the volume level before selecting the Amplifying volume function to protect your ears from damage.

## MUTING VOLUME

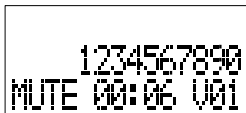

### To mute the microphone during a call:

1. Press **Mute**. A text message in the display indicates the mute status.
2. The microphone can be un-muted by pressing **Mute** again.



## ADJUSTING TONE



Adjusting the tone can help make a conversation be heard more clearly.

During a call, press **Tone** to toggle between low, normal, medium and high tone levels. A text message in the display indicates the level selected.

## USING PRE-DIAL

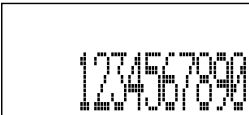

The pre-dial function allows you to dial your number first and view it as shown on the display, then press **Talk** to make your call. For viewing convenience in pre-dial mode, digits are displayed in large fonts.

1. In standby mode, enter a destination phone number using **0...9**. If you entered a digit in error, press **DEL** to delete.
2. Press **Talk** to start dialing.
3. When conversation ends, press **Talk** or place the handset in the base.

## LAST NUMBER REDIAL

Pressing **Redial** allows you to automatically redial the last number dialed.

In pre-dial mode, the last phone number dialed can be accessed by pressing **Redial**. The number is dialed when pressing **Talk**.

**NOTE:** If **Flash** is pressed during a call conversation, redialed numbers are not stored until the next call is made.

## USING THE PAUSE

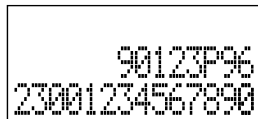

Making some outgoing calls may require a brief pause in between dialing. A three second pause will be inserted into the sequence of digits each time the **Pause** button is pressed. It is indicated on the display by the character "P".

## CALL WAITING

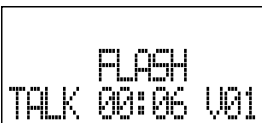

During a call, a call waiting alert tone in the handset receiver will notify you there is another incoming call. To answer the waiting call, press **Flash**. "FLASH" appears on the LCD. To reconnect to the original caller, press

## Flash again.

If another handset is engaged in a call, the message, "EXT IN USE" will be displayed .

## USING THE PHONEBOOK

The phonebook can store up to 99 phone numbers up to 24 digits each and names (up to 14 characters).

1. To enter the phonebook and view stored numbers, press **PHBK**. The first phonebook entry is shown.

If there are no numbers stored in the phonebook, the LCD shows:



If there are numbers stored, the first entry is displayed:

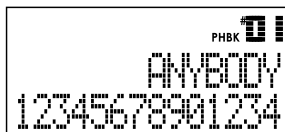

2. Press **▲** / **▼** to view other phonebook entries.
3. To exit the phonebook, press **DEL** to return to standby mode. If no key is pressed for several seconds, the unit automatically exits the phonebook.

**NOTE:** When viewing a phone number that contains 11 digits or less in the phonebook, memory or Caller ID, the number is shown as x-xxx-xxx separated by "-".

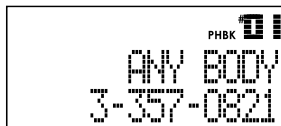

## ADDING A PHONEBOOK ENTRY



While viewing the phonebook, press **MENU** to enter the phonebook menu. Use **▲** / **▼** to scroll through the 4 sub- menu options available, Add Record, Edit Record, Delete Record and Delete All, and press **MENU** to select an option.

1. Select the sub-menu item "ADD RECORD" to add a phonebook entry. If the phonebook is full, a "PHONEBOOK FULL" message will be displayed.
2. If there is available storage space in the phonebook, select from one of the free memory slots. "ENTER NAME" appears on the LCD.

Press **0...9** and **\*,#** to enter a phonebook name, repeatedly pressing the keys until the desired character appears. Wait for 1 second or press a different key to input a new character. Repeat until the name is entered.



ENTER NAME  
ROBERTY

3. Press **MENU** to confirm the name entry. The “ENTER NUMBER” prompt then appears. To enter a phonebook number, press **0...9** and **\*,#**, **Pause**.



ENTER NUMBER  
012345

4. Press **MENU** to confirm the number entry and return to the phonebook list.

**TIP:** A number can be saved without entering a name.

## EDITING A PHONEBOOK ENTRY

1. Press **▲ / ▼** to alphabetically search and select the entry you wish to edit and press **MENU** to confirm.
2. Select the sub-menu item “EDIT RECORD” to edit a phonebook entry. “ENTER NAME” appears on the LCD.
3. Use **0...9** to edit the name entry and press **MENU** to confirm. The “ENTER NUMBER” prompt appears.
4. Use **0...9** to edit the number entry and press **MENU** to confirm and to return to phonebook list.

EN

## DELETING A PHONEBOOK ENTRY

1. Select the sub-menu item “DELETE RECORD” to delete a phonebook entry.
2. Press **▲ / ▼** to alphabetically search and select the entry you wish to delete. The “DELETE?” prompt is displayed on the LCD.
3. Press **MENU** to confirm deletion or press any other key to return to the phonebook view screen. OR, press **DEL** to cancel the operation and return to phonebook view.

## DELETING ALL PHONEBOOK ENTRIES

Select the sub-menu item “DELETE ALL” to delete all phonebook entries. Press **MENU** to confirm.

## CALLING A STORED PHONEBOOK ENTRY

1. While viewing the phonebook, press ▲ / ▼ to alphabetically search and select the entry you wish to call. OR, press 2...9 corresponding to the first letter of the entry and use ▲ / ▼ to select the name you are seeking, e.g., for names beginning with "R" press 7 three times.

## EMERGENCY AND DIRECT NUMBER MEMORY

The Emergency and Direct Number Memory feature provides one-touch convenience for dialing up to 5 important phone numbers stored in memory.



### To store / edit a memory record:

1. Press **M1** or **M2** to scroll to the number you wish to store.
2. Press **MENU** to enter the memory menu, use ▲ / ▼ to select Edit Record, and press **MENU** to confirm.
3. Use 0...9, \*,# and **Pause** to enter a number.
4. Press **MENU** to confirm the number entry and return to the memory menu view.



### To dial emergency and direct numbers:

1. To use this "speed-dial" feature, press any one of the following keys:

KEY PRESS	STORED NUMBER TO DIAL
Emergency Memory	
	Fire (Emergency 1)
	Police (Emergency 2)
	Ambulance (Emergency 3)
Direct Memory	
<b>M1</b>	Direct 1
<b>M2</b>	Direct 2

The corresponding stored number is shown on the display. The name is fixed as "DIRECT" for direct number memory and as "EMERGENCY" for emergency number memory.

If there is no number,  
the LCD shows:



If there is a number, the entry  
is displayed as follows:



2. Press ▲ / ▼ to review other entries in the following order: 🔔, 📞, +, M1, M2.
3. Press **Talk** to dial the selected stored number.
4. Press **DEL** to return to standby mode. If there is no key pressed after a few seconds, the unit automatically returns to standby mode.

## MEMORY MENU

To delete an emergency or direct number, press **M1** or **M2** to scroll to the number you wish to delete, then press **MENU** to enter the memory menu. Use ▲ / ▼ to scroll through the options (Edit Record, Delete Record, Delete All) and press **MENU** to select an option.

### To delete a memory record:

Press **MENU** to confirm deletion of a memory number or press any key to return to the number memory review. OR, press **DEL** to cancel the operation and return to memory review.

EN

## CALLER ID DISPLAY

If you have Caller ID service from your local telephone company, the handset will display incoming call details. If the number is in your phonebook the name will also be displayed. The call log records the caller name, number and the date / time for up to 99 calls.

If the Caller ID information is blocked, the handset will display calls with blocked name / numbers:

Private number ("P"):



Out of area number ("O"):

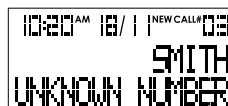

Private name ("P"):



10:20 AM 12/11 NEW CALL#04  
BLOCKED NAME  
987-654-3210

If both name and number is blocked: Private name and number ("P")



10:20 AM 12/11 NEW CALL#06  
BLOCKED CALL

Out of area name ("O"):

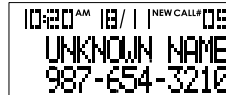

10:20 AM 12/11 NEW CALL#05  
UNKNOWN NAME  
987-654-3210

Out of area name and number ("O"):



10:20 AM 12/11 NEW CALL#06  
UNKNOWN CALLER

When the call is accepted, the display changes depending on the type of call. If the unit times out before a new Caller ID is received during a call conversation, the display returns to talk mode.

Call with name and number:



SOMEBODY  
TALK 00:06 001

Call with Caller ID (number only):

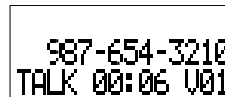

987-654-3210  
TALK 00:06 001

In cases where the Caller ID number is blocked (and the name is not available), the incoming call is shown as:

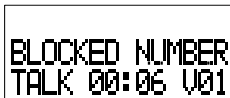

BLOCKED NUMBER  
TALK 00:06 001

OR



UNKNOWN NUMBER  
TALK 00:06 001

For calls with a blocked name or unknown name, the Caller ID is shown as:



BLOCKED NAME  
TALK 00:06 001

OR



UNKNOWN NAME  
TALK 00:06 001

## VIEWING CALLER ID RECORDS

1. Press **CID** on the handset. If the call log is empty when you try to enter call log review, a message "NO CALLS" is displayed and the phone returns to the main menu. Otherwise, the total number and new number of call logs are shown.
2. Press **▲** / **▼** to review calls. All information including caller name, number and date / time are shown.



ALL=XX  
NEW=XX

**NOTE:** The number on the right side of the display's first line shows the call log number – "1" is the last received call. The first (oldest) call is the call log number 1. Incoming calls are sorted by the order of arrival; the oldest is shown first. A number is only contained once in the list. A new call from a caller that is already contained in the log removes the old entry and inserts the new call.



3. Use ▲ / ▼ to see other call log entries.
4. Press **DEL** to exit the call log review and return to standby mode.



While viewing the Caller ID logs, press **MENU** then use ▲ / ▼ to scroll through the menu options (Edit Record, Edit To Call, Delete Record, Delete All) and press **MENU** to select an option.

## SAVING CALLER ID RECORDS IN THE PHONEBOOK

1. When reviewing the call log, press **MENU** to enter the call log menu and to select the sub-menu item "ADD RECORD" to add a phonebook entry. The prompt "ENTER NAME" appears on the LCD. If there is a name available for the Caller ID, it is displayed. Otherwise, the name is blank.
2. Use **0...9** and \* to edit a name and press # to change between uppercase and lowercase characters.
3. Press **MENU** to confirm the name entry. "ENTER NUMBER" then appears onscreen. If there is a number available for the Caller ID, it is displayed. Otherwise, the number is blank.
4. Use **0...9**, \* and # to edit a phone book number.
5. Press **MENU** to confirm the number entry. The call log is stored into the phonebook. The display will return to show the call log number.

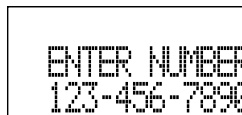
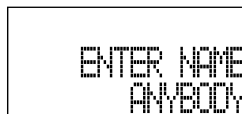

EN

## CHANGING THE CALLER ID NUMBER FORMAT

It is possible to change the number format in the call log before storing the name / number . While viewing the Caller ID list, press **Format** to change the number format . The available number formats depend on the received number. The table below shows the possible selections and the order in which they appear. The number format is changed by truncating or by adding the digits.

INCOMING NUMBER	ACTION	ONSCREEN DISPLAY
Area code is available, number contains 7-digits	Format changes from 7-digits --> 10-digits --> 11-digits, then returns to 7-digits	yyy-yyyy --> xxx-yyy-yyyy --> 1-xxx-yyy-yyy where y is the number, x is the area code
Area code is available / not available, number contains 10-digits	Format change from 10-digits--> 11-digits --> 7-digits, then returns to 10-digits	yyy-yyy-yyyy --> 1-yyy-yyy-yyyy --> yyy-yyyy where y is the number
Area code is available / not available, number contains 11-digits with first digit "1"	Format changes from 11-digits--> 7-digits -->10-digits, then returns to 11-digits	1-yyy-yyy-yyyy --> yyy-yyyy --> yyy-yyy-yyyy where y is the number

EN

## EDIT THE CALL LOG NUMBER BEFORE DIALING

When reviewing the call log, press **MENU** to enter the call log menu and select the sub-menu item "EDIT TO CALL". Edit the number using **0...9** OR press **DEL** to quit the operation. The call log number is transferred to pre-dial mode. The number can be edited before dialing in pre-dial mode.

**NOTE:** During an incoming call, the name that appears on the screen may either be available from the phone network or from information previously stored in the phonebook. If the Caller ID data contains the caller's name information, it will be displayed. If the calling number matches a number in the phonebook, the name associated with this number is shown instead. The phonebook name takes precedence.

## ERASING A CALLER ID RECORD

1. When reviewing a call log, press **MENU** to enter the call log menu and select the sub-menu item "DELETE RECORD".
2. "DELETE?" appears onscreen. Use **MENU** to confirm deletion of the selected Caller ID record OR press any other key to cancel the operation and return to call log review.



## ERASING ALL CALLER ID RECORDS

1. When reviewing a call log, press **MENU** to enter the call log menu and select the sub-menu item “DELETE ALL?” to delete all Caller ID entries.
2. “DELETE?” appears onscreen. Use **MENU** to confirm deletion of all Caller ID records OR press any other key to cancel the operation and return to call log review.

## DIALING A CALLER ID RECORD

When reviewing a call log, press **Talk** to dial the Caller ID entry that is being reviewed.

## ADDITIONAL PHONE FUNCTIONS

### USING THE INTERCOM

1. Press **INT** to make an intercom call.
2. Dial the number of the handset you wish to call.
3. Press **Talk** to start. “INTERNAL CALL” indicates an intercom call is in progress.



INTERNAL CALL  
HANDSET 2



HANDSET 2  
TALK 00:06 U01

Once an intercom call is connected, the called unit number is displayed. “TALK” is shown on the lower left side. If engaging an external call, it is placed on hold.

4. If the intercom is activated during a call, you may toggle between the external and internal call by pressing **INT**.



INTERCOM HOLD  
TALK 00:06 U01

When the calling handset is in the middle of an external call, the called handset will be put on hold. “INTERCOM HOLD” appears onscreen to indicate that the internal call is on hold.

## TRANSFERRING CALLS

An incoming call can be transferred to another handset during an ongoing call:

1. On the first handset, press **INT** and the external call is put on hold .
2. Select the local handset number from the menu, then press **Talk**.

- Once the second handset answers the call, press **Talk** on the first handset to end its connection. The second handset will be engaged in the external call.

**NOTE:** When transferring a call, the first handset must wait for the other handset to answer before pressing **Talk** to complete the transfer .

## MAKING A CONFERENCE CALL

To establish a conference call between two handsets and an external party:

- If a handset has an active connection (external) and another connection is on hold, a conference call may be established by pressing **CONF**. During a conference call, the calling and called handset displays the following on the LCD:



If a handset is connected to the external line and a second handset is off hook, a conference call is immediately established.

- To disconnect a conference call on one of the handsets, press **Talk**. The connection continues between the remaining party and the external party.

## ONE-WAY BASE PAGING

The paging function is used to help locate handsets. Paging of all handsets is done by pressing **Page** from the base unit. Paging stops automatically after 120 seconds or if any key is pressed on the handset or base unit.

## MENU SETTINGS

### NAVIGATING HANDSET MENUS

KEY	FUNCTION
▲	Press to scroll up menu and sub-menu options
▼	Press to scroll down menu and sub-menu options
<b>MENU</b>	Press to confirm selection
<b>DEL</b>	Press to exit to previous menu and / or exit and return to standby mode

## How to navigate menus:

Standby

Language
Ring Setting
Set Time
Phone Setup
Security Setting
Set Default

1. In standby mode, press **MENU** to enter the handset menu.
2. Use ▲ / ▼ to select the menu. > appears beside a menu to indicate that it is being selected.
3. Press **MENU** to enter the selected menu option and use ▲ / ▼ to navigate the menu options, then press **MENU** again to confirm and exit to the previous menu. Repeat step 3 if there are settings available to choose from the menu options and sub-menu settings, respectively.
4. Use **DEL** to exit to the previous menu at anytime.

### TIP

- You cannot enter the menu if you are making a call or have pre-dialed any part of a phone number.
- When you have changed a setting the handset will provide a confirmation beep and exit the menu.

EN

## LANGUAGE

Language

English
French
Spanish



The handset LCD can display information in English, Spanish and French. Once the language is set, all menu information is shown in that language.

## RING SETTING

Ring setting, which includes ring volume and ring tone, can be adjusted for incoming external / internal calls.

## Ring Setting

### Ring Volume

External Call 1-5

Internal Call 1-5

### Ring Tone

External Call Ring Tone 1-5

Internal Call Ring Tone 1-5

### To adjust ring volume:

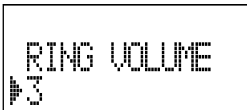

There are 5 different ring volume levels available, with "1" being the lowest and "5" the highest ring volume. The selected ring volume is played once .

**TIP:** You may control whether the ringer is on / off by adjusting the handset **Ringer On / Off** or base unit **Ringer Hi-Low-Off** switch.

### To select ring tone:



There are 3 ring tones to select from.  
The selected ring tone is played once.

EN

## SET TIME

In standby mode, the handset displays a clock in 12-hour or 24-hour format.

### Set Time

Clock Setting (E.g. 12:00AM)

### Alarm

Off (E.g. 12:00AM)

On

### Set Format

12 Hr

24 Hr

MM/DD

DD/MM

### To adjust clock:



1. On the numeric keypad, press **0...9** to enter the clock time sequentially from left (hours) to right (minutes) using ▲ / ▼ .
2. Press # to toggle between AM / PM if the time format is 12-hour format.

### To set the alarm:

1. Use ▲ / ▼ to select between alarm On / Off. If the alarm is set to "Off", the display returns to the previous menu. If the alarm is set to "On", the display shows the alarm time as a clock setting.
2. Follow the same steps as entering the clock time to enter the alarm time. When the alarm sounds, press any key to stop the alarm from ringing.



### To adjust the time display format:

1. Use ▲ / ▼ to toggle between 12 / 24 hour formats and press **MENU** to confirm selection. Then enter the MM/DD format (month / date). The selected MM/DD format is displayed.
2. Use ▲ / ▼ to toggle between Month-Date display formats.



**NOTE** This format will also change the day and date format in the Caller ID screen.

## PHONE SETUP

### Phone Setup

Set Area Code		
Contrast		
Key Tone		
	Off	
	On	
Auto Answer		
	Off	
	On	
Baby Call		
	Off	
	On	
Prefix		Baby call # ?
	Off	
	On	
Dial Mode		Prefix # ?
	Tone	
	Pulse	
Handset Name		
	Enter name	

EN

#### To set the area code:

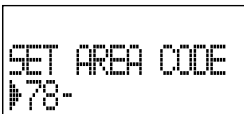

An area code generally identifies a geographic area and appears onscreen when the Caller ID number is displayed during call reception and Caller ID list view. If no area code is set, the display will show “—”. Press **0...9** to enter the 3-digit area code sequentially.

**NOTE:** When the first few digits of a Caller ID number received is identical to the area code, the Caller ID number will not display the matched digits.

#### To set the key tone:

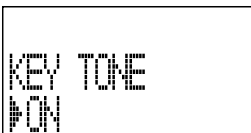

Each phone key generates and transmits key tones of differing pitch when pressed. These tones corresponding to the digits of the number being called. Use **▲ / ▼** or press any digit

on the numeric keypad to select between key tone On / Off.

#### To set auto answer:

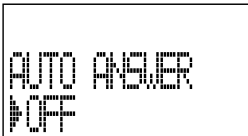

When auto answer is activated, the unit connects to internal / external calls automatically once the handset is picked up from the base unit. There is no need to press **Talk**. If auto answer is not set, you must press **Talk** to connect the call. Use ▲ / ▼ to toggle between auto answer On / Off.

#### To set baby call:

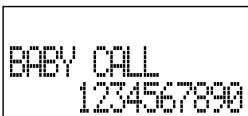

Baby call allows you to set a number to automatically dial when any key (apart from **MENU**) is pressed. Use ▲ / ▼ to toggle between baby call On / Off. If baby call is turned off, the display returns to the previous menu.

If baby call is turned on, you are prompted to enter the baby call number. Press **0...9** to enter the number sequentially.

When the Baby Call function is set, you can press any key during standby mode to begin an external call and dial the baby call number.

#### To set the prefix dialing number:

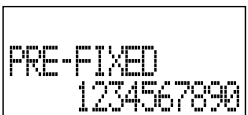

When the prefix dialing number is set, the number will be inserted prior to the dial . Use ▲ / ▼ to toggle between prefixed dialing On / Off. If prefixed dialing is turned off, the display returns to the previous menu. If prefix dialing is turned on, you are prompted to enter the prefix number.

#### To set dial mode:

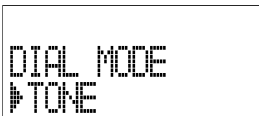

There are 2 dial modes TONE and PULSE. Use ▲ / ▼ to toggle between "TONE" and "PULSE" dialing mode.

**NOTE:** Temporary tone dialing: If pulse dialing has been set, pressing \* will change the pulse dialing mode to tone dialing mode until the call ends.

### To set programmable handset name:

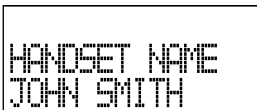

Programming a name into your handset allows you to identify and differentiate it from other handsets. Similar to keying in phonebook name characters, use any numeric key to change the handset name.

## SECURITY SETTING / REGISTERING ADDITIONAL HANDSETS

The handset and base unit are factory pre-registered with each other. When you purchase an additional handset, you must register it to the base unit in order to make and answer calls. A maximum of four handsets can be registered to one base. Select the base to be used as primary and connect it to the telephone line. The other base(s) will act as the charger(s) only. Do not connect the additional bases into the telephone line.

### Security Setting

Registration	
De-registration	
Clr Msg Wait	
	No
	Yes
Select Base	
	1-4
Show ID	

EN

### To register the handset:

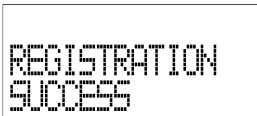
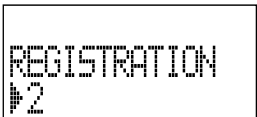

1. Use ▲ / ▼ to select base number for registration.
2. Press **MENU** to confirm the selected base number and hold the handset close to the base unit.
3. Press and hold the **PAGE** key on the primary base until the ring indicator flashes rapidly.
4. If registration is successful, "SUCCESS" appears onscreen and the display returns

to the previous menu. If registration is not successful, "RETRY?" appears. Press **MENU** to retry registration OR **DEL** to return to the previous menu.

**NOTE:** The registered handset number will be displayed after the handset is returned to any base. Changing the handset name will not change the registered handset number.



### To de-register the handset:



1. Use ▲ / ▼ to select handset number for de-registration.
2. Press **MENU** to confirm. If de-registration is successful "SUCCESS" appears on the LCD screen, otherwise "RETRY" appears. Press **MENU** to retry or **DEL** to return to the previous menu.

### To manually clear message waiting:

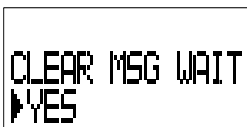

Use ▲ / ▼ to select "YES" or "NO" and press **MENU** to confirm. If you selected "No", the display returns to the previous menu. If you selected "Yes" the unit will clear the message waiting status. If successful, "SUCCESS" appears and the display returns to the previous menu.

If you have voicemail service from your local telephone company activated and you have a message waiting, the base unit LED will flash. The LED will stop flashing once all messages have been read and deleted.

### To select base:



1. You can have up to four handsets and bases. To register a handset to a base Use ▲ / ▼ to select the base number.
2. Press **MENU** to confirm. If registration is successful "SUCCESS" appears on the LCD screen, otherwise "RETRY" appears. Press **MENU** to retry or **DEL** to return to the previous menu.

### To show ID:

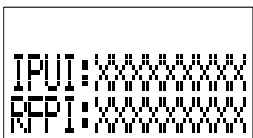

RFPI (Radio Fixed Part Identity) and IPUI (International Portable User Identity) are identity numbers unique to each handset and base unit that allows its corresponding base unit / handset to identify one another during phone registration.

## DEFAULT SETTINGS

Set Default

No

Yes

The phone can be reset to its factory default settings at any time. The default settings are:

<b>SETTING</b>	<b>DEFAULT VALUE</b>
Language	English
Internal / external ring volume	4
External ring tone	Ring Tone 1
Internal ring tone	Ring Tone 1
Alarm	Off
Alarm time	12:00 AM
Display format	12-hour
Month-Date display format	MM / DD
Key tone	On
Auto answer	Off
Call	Off
Call number	Clear
Dial tone	Tone dial
Flash time	600ms
Handset name	Clear
Handset volume	V01
Base ringer level	Highest
Pre-fixed	Off
Pre-fixed number	Clear

## TROUBLESHOOTING

See below for some common problems and their remedies. Whatever the problem, you should first check:

- The base unit is connected to the power supply and phone line.
- The main power is switched on at the A/C outlet.
- The handset battery is installed and has not run out of power.

**DO NOT** attempt any repairs yourself. This will invalidate your warranty.

PROBLEM	POSSIBLE CAUSES / REMEDIES
Can't make a call / "OUT OF RANGE" appears on the handset	<ul style="list-style-type: none"> <li>• Out of range of base unit - move to within 300 m (approx. 980 ft)</li> <li>• Interference due to environment - position base unit to reduce interference (move higher)</li> <li>• De-synchronization has occurred. The base unit will reset synchronization automatically</li> </ul>
Can't enter the sub-menus	<ul style="list-style-type: none"> <li>• Handset may not be registered to base unit</li> <li>• Ensure unit is not in the base</li> <li>• Return to standby mode by pressing <b>DEL</b></li> </ul>
Every key I press calls a preset number	<ul style="list-style-type: none"> <li>• Phone is in Call mode. To deactivate see section on PHONE SETUP</li> </ul>
Caller ID is not displayed	<ul style="list-style-type: none"> <li>• Check your network subscription to Caller ID</li> <li>• Name and number need to be stored in phonebook for name display</li> </ul>
Handset does not ring	<ul style="list-style-type: none"> <li>• Ring Volume "OFF" (to turn ring volume on see section on RING SETTING)</li> </ul>
I can't hear the person talking on the other line	<ul style="list-style-type: none"> <li>• Make sure that your ear is touching the top section of the handset (receiver) when you are talking</li> </ul>
Battery is low, even if recharged	<ul style="list-style-type: none"> <li>• Battery pack may need to be replaced</li> </ul>
I can't register my new handset	<ul style="list-style-type: none"> <li>• A maximum of 4 units can be registered to the base. De-register a handset and try again</li> <li>• Make sure you select a base number that has not been assigned</li> </ul>
I can't make a call with my new handset	<ul style="list-style-type: none"> <li>• Only one external call and one internal call can take place at once. Make sure no other handset is making a call</li> </ul>

## SPECIFICATIONS

TYPE	DESCRIPTION
Handset dimensions	41.5 mm (W) x 184.7 mm (L) x 54.2 mm (D)
Handset weight	0.171 kg (without battery)
Base unit dimensions	126.6 mm (W) x 122 mm (L) x 73 mm (D)
Base unit weight	0.186 kg
Standard	Worldwide Digital Cordless Telecommunications (WDCT)
Communication range	Up to 300 meters (approx. 980 feet) in open area
Base power supply	Input: 120 V / 60 Hz Output: 9V / 500 mA
Handset power supply	Rechargeable 600 mAh 3.6 V (AA) Ni-Cd battery pack
Operating time	Handset: approx. 6.5 hours
Standby time	Handset: at least 100 hours
Charge time	Approx. 14 hours
Display language	English, Spanish, French
Operating temperature	0 °C to 50 °C (32 °F to 122 °F)
Storage temperature	-20 °C to 60 °C (-4 °F 140 °F)

EN

## ABOUT KROWN

Visit our website ([www.krownmfg.com](http://www.krownmfg.com)) to learn more about Krown Manufacturing products. The website also includes contact information for our Customer Care department in case you need to reach us, as well as frequently asked questions and customer downloads.

We hope you will find all the information you need on our website, however if you would like to contact the Krown Customer Care department directly, please visit: [www.krownmfg.com/html/contactus.html](http://www.krownmfg.com/html/contactus.html) OR call (817) 738-2485.

## FCC STATEMENT

This device complies with Part 15 of the FCC Rules. Operation is subject to the following two conditions: (1) This device may not cause harmful interference, and (2) This device must accept any interference received, including interference that may cause undesired operation.

Privacy of communications may not be ensured when using the phone.

**WARNING:** Changes or modifications to this unit not expressly approved by the party responsible for compliance void the user warranty.

**NOTE:** This equipment has been tested and found to comply with the limits for a Class B digital device, pursuant to Part 15 of the FCC Rules. These limits are designed to provide reasonable protection against harmful interference in a residential installation.

This equipment generates, uses and can radiate radio frequency energy and, if not installed and used in accordance with the instructions, may cause harmful interference to radio communications.

This equipment is hearing aid compatible.

This product meets the applicable Industry Canada technical specifications.

However, there is no guarantee that interference will not occur in a particular installation. If this equipment does cause harmful interference to radio or television reception, which can be determined by turning the equipment off and on, the user is encouraged to try to correct the interference by one or more of the following measures:

- Reorient or relocate the base.
- Increase the separation between the equipment and receiver.
- Connect the equipment into an outlet on a circuit different from that to which the receiver is connected.
- Consult the dealer or an experienced radio / TV technician for help.

**CAUTION:** To maintain compliance with the FCC's RF exposure guidelines it is recommended a typical distance at least 20cm is maintained between the base unit and nearby persons.

## DECLARATION OF CONFORMITY

The information below is not to be used as contact for support or sales. Please call our customer service number (listed on our website at [www.krownmfg.com](http://www.krownmfg.com), or on the warranty card) for all inquiries .

Name: Krown Manufacturing, Inc.

Address: 3408 Indale Road, Fort Worth, TX 76116

### declare that the product

Product No.: KR2812

Product Name: Krown Digital Amplifier Cordless Phone

is in conformity with Part 15 of the FCC Rules. Operation is subject to the

following two conditions:

1. This device may not cause harmful interference.
2. This device must accept any interference received, including interference that may cause undesired operation.

## LIGHTNING

Your telephone has built-in lightning protection to reduce the risk of damage from surges in telephone line and power line current. This lightning protection meets or exceeds FCC requirements. However, lightning striking the telephone or power lines can damage your telephone.

Lightning damage is not common. Nevertheless, if you live in an area that has severe electrical storms, we suggest that you unplug your phone when storms approach to reduce the possibility of damage.

## CONSUMER INFORMATION

This equipment complies with Part 68 of the FCC rules and the requirements adopted by the ACTA. On the bottom of this equipment is a label that contains, among other information, a product identifier in the format US:KT5W400BKR2812. If requested, this number must be provided to the telephone company.

An applicable certification jacks Universal Service Order Codes (USOC) for the equipment is provided (i.e., RJ11C) in the packaging with each piece of approved terminal equipment. The mounting of the approval unit in the final assembly must be made so that the approved unit is isolated from exposure to any hazardous voltages within the assembly. Adequate separation and restraint of cable and cords have provided.

A plug and jack used to connect this equipment to the premises wiring and telephone network must comply with the applicable FCC Part 68 rules and requirements adopted by the ACTA. A compliant telephone cord and modular plug is provided with this product. It is designed to be connected to a compatible modular jack that is also compliant. See installation instructions for details.

The REN is used to determine the number of devices that may be connected to a telephone line. Excessive RENs on a telephone line may result in the devices not ringing in response to an incoming call. In most but not all areas, the sum of RENs should not exceed five (5.0). To be certain of the number of devices that may be connected to a line, as determined by the total RENs, contact the local telephone company. [For products approved after July 23, 2001, the REN for this product is part of the product identifier that has the format US:KT5W400BKR2812. The digits represented

by N/A are the REN without a decimal point (e.g., 03 is a REN of 0.3). For earlier products, the REN is separately shown on the label.]

If this equipment causes harm to the telephone network, the telephone company will notify you in advance that temporary discontinuance of service may be required. But if advance notice isn't practical, the telephone company will notify the customer as soon as possible. Also, you will be advised of your right to file a complaint with the FCC if you believe it is necessary.

The telephone company may make changes in its facilities, equipment, operations or procedures that could affect the operation of the equipment. If this happens the telephone company will provide advance notice in order for you to make necessary modifications to maintain uninterrupted service. Should you experience trouble with this equipment, please contact Krown Manufacturing at [www.krownmfg.com/html/contactus.html](http://www.krownmfg.com/html/contactus.html) OR call (817) 738-2485 for repair or warranty information.

If the equipment KR2812 is causing harm to the telephone network, the telephone company may request that you disconnect the equipment until the problem is resolved.

Please follow instructions for repairing if any (e.g. battery replacement section); otherwise do not alternate or repair any parts of device except specified.

Connection to party line service is subject to state tariffs. Contact the state public utility commission, public service commission or corporation commission for information.

**NOTICE:** If your home has specially wired alarm equipment connected to the telephone line, ensure the installation of this [equipment ID] does not disable your alarm equipment. If you have questions about what will disable alarm equipment, consult your telephone company or a qualified installer.

**NOTICE:** According to telephone company reports, AC electrical surges, typically resulting from lightning strikes, are very destructive to telephone equipment connected to AC power sources. To minimize damage from these types of surges, a surge arrester is recommended.

## WARRANTY

Krown Manufacturing, Inc. warrants the Digital Amplified Cordless Phone KR2812 sold by Krown Manufacturing, Inc. is free from defects in materials and workmanship under normal use and service for one year. This warranty is applicable only to the original purchaser of the cordless phone when accompanied by a sale receipt stating the date of purchase and the name of the company from which purchased. This warranty is in lieu and excludes

all other warranties, expressed or implied, including any implied warranty of merchantability or fitness and of any obligation on the part of Krown Manufacturing, Inc. If the phone shall prove the defective, then Krown Manufacturing, Inc shall either replace or repair the phone at no cost to the original purchaser within one year of the date of purchase. During the one-year period you may return the phone to Krown Manufacturing, Inc. at the following address:

Krown Manufacturing, Inc. 3408 Indale Rd. Fort Worth, TX 76116
--

Shipping charges are at the customer's expense. Please include a check or money order make out to Krown Manufacturing in the amount of \$15.00 to cover for the Shipping and Handling. This warranty does not extend to any phone sold by Krown Manufacturing, Inc., which has been subjected to misuse, neglect, accident, improper application, improper installation, or any use in violation of the instruction furnished by Krown Manufacturing, Inc. Battery pack provided with this product is not covered under this warranty. This warranty does not extend to or apply to any phone, which has been repaired or altered by any persons who have not been expressly approved by Krown Manufacturing, Inc. Krown Manufacturing, Inc. shall not be liable for any special or consequential damages or for loss or expense directly or indirectly arising from use of the product or any inability to use them either separately or in combination with other equipment or product accessories or from any other cause. This warranty is only applicable to a product purchased through Krown Manufacturing, Compu-TTY, or a Krown dealer. Other than state herein, there is no other warranty whether by the sample or model, by description or quantity, whether expressed or implied, and there are no implied warranties of fitness for a particular purpose or of merchantability.

EN



## Free Manuals Download Website

<http://myh66.com>

<http://usermanuals.us>

<http://www.somanuals.com>

<http://www.4manuals.cc>

<http://www.manual-lib.com>

<http://www.404manual.com>

<http://www.luxmanual.com>

<http://aubethermostatmanual.com>

Golf course search by state

<http://golfingnear.com>

Email search by domain

<http://emailbydomain.com>

Auto manuals search

<http://auto.somanuals.com>

TV manuals search

<http://tv.somanuals.com>