

640 LC4 **640 LC4 SUPERMOTO**

KTM
SPORTMOTORCYCLES

BEDIENUNGSANLEITUNG

OWNERS HANDBOOK
MANUALE D'USO
MANUEL D'UTILISATION
MANUAL DE INSTRUCCIONES

2002



Art.Nr. 3.210.21 9/2001

IMPORTANT

WE STRONGLY SUGGEST THAT YOU READ THIS MANUAL CAREFULLY AND COMPLETELY BEFORE GOING ON YOUR FIRST RIDE. IT CONTAINS A GREAT DEAL OF INFORMATION AND ADVICE WHICH WILL HELP YOU USE AND HANDLE YOUR BIKE PROPERLY. IN YOUR OWN INTEREST, PLEASE PAY PARTICULAR ATTENTION TO NOTICES THAT ARE MARKED AS FOLLOWS:

△ **WARNING** △

IGNORING THESE INSTRUCTIONS, CAN ENDANGER YOUR BODY AND YOUR LIFE.

! **CAUTION** !

IGNORING THESE INSTRUCTIONS COULD CAUSE DAMAGE TO PARTS OF YOUR MOTORCYCLE OR THAT THE MOTOR-CYCLE IS NOT ROAD-SAFE ANYMORE.

Please insert the series numbers of your motorcycle in the boxes below

Chassis number

Engine number

Stamp of dealer

CONSUMER INFORMATION FOR AUSTRALIA ONLY

TAMPERING WITH NOISE CONTROL SYSTEM PROHIBITED

Owners are warned that the law may prohibit:

- (a) The removal or rendering inoperative by any person other than for purposes of maintenance, repair or replacement, of any device or element of design incorporated into any new vehicle for the purpose of noise control prior to its sale or delivery to the ultimate purchaser or while it is in use; and
- (b) the use of the vehicle after such device or element of design has been removed or rendered inoperative by any person.

KTM SPORTMOTORCYCLE AG RESERVES THE RIGHT TO MODIFY ANY EQUIPMENT, TECHNICAL SPECIFICATIONS, COLORS, MATERIALS, SERVICES OFFERED AND RENDERED, AND THE LIKE SO AS TO ADAPT THEM TO LOCAL CONDITIONS WITHOUT PREVIOUS ANNOUNCEMENT AND WITHOUT GIVING REASONS, OR TO CANCEL ANY OF THE ABOVE ITEMS WITHOUT SUBSTITUTING THEM WITH OTHERS. IT SHALL BE ACCEPTABLE TO STOP MANUFACTURING A CERTAIN MODEL WITHOUT PREVIOUS ANNOUNCEMENT. IN THE EVENT OF SUCH MODIFICATIONS, PLEASE ASK YOUR LOCAL KTM DEALER FOR INFORMATION. WE SHALL NOT BE HELD LIABLE FOR ANY PRINTING ERRORS.

Introduction

We would like to congratulate you on your purchase of a KTM motorcycle.

You are now the owner of a state-of-the-art sports motorcycle that guarantees to bring you lots of fun and enjoyment, provided that you clean and maintain it appropriately. **Before you go for your first ride, be sure to read this manual carefully and thoroughly in order to familiarize yourself with how to operate your new motorcycle and with its characteristics, even if this means that you have to dedicate some of your valuable time to this task. Only by doing so will you learn how to tune your motorbike to your specific needs and how to protect yourself against injury. Besides, this manual contains important information on motorcycle maintenance.** At the time this manual was typeset, it was up-to-date with the latest state of this production series. It cannot be completely ruled out, however, that there may exist minor discrepancies resulting from further design upgrades of these motorcycles.

This manual is an important part of your motorbike and should be passed on to any subsequent owner in case you decide to sell it.

Many motorcyclists have a good working knowledge of motorcycle mechanics; if this is true in your case, you will be able to use this manual to carry out most of the maintenance steps yourself. If, on the other hand, you are not very familiar with motorcycles, it might be better to have a professional KTM dealer perform those steps marked * described in the chapter entitled "Maintenance Work on Chassis and Engine" of this manual.

For your own safety use only KTM-approved parts and accessories. KTM is not liable for damage that arises in connection with the use of other products.

Take special care to follow the recommended run in, inspection, and maintenance intervals. Heeding these guidelines will significantly increase the life of your motorcycle. Have services carried out by a KTM dealer so that your warranty claim remains intact.

Contact a specialized KTM workshop supported by the KTM importer if you have any special wishes. Please remember to wear a helmet, protective glasses and protective clothing while driving. KTM drivers are considerate drivers.

We wish you a lot of fun when driving !



REG.NO. 12 100 6061

KTM Austria's certificate of achievement for its Quality System ISO 9001 is the beginning of an on-going total re-engineering quality plan for a brighter tomorrow.

KTM SPORTMOTORCYCLE AG
5230 MATTIGHOFEN, AUSTRIA

ALL RIGHTS RESERVED TO MAKE ALTERATIONS TO DESIGN AND MODEL.

© by KTM SPORTMOTORCYCLE AG, AUSTRIA All rights reserved

INDEX

	Page		Page
SERIAL NUMBER LOCATIONS	4	Check the rear brake fluid level	21
Chassis number	4	Refilling the rear brake fluid reservoir	21
Engine number, engine type.....	4	Checking the rear brake pads	21
OPERATION INSTRUMENTS	4	Dismounting and mounting the front wheel (LC4)	22
Clutch lever	4	Dismounting and mounting the front wheel (LC4 Supermoto).....	22
Hand decompression lever.....	4	Dismounting and mounting the rear wheel.....	23
Choke lever	5	Checking the shock absorbtion rubbers in the rear hub.....	23
Hand brake lever	5	Tires, air pressure.....	24
Speedometer, indicator lamps.....	5	Checking spoke tension.....	24
Ignition lock	5	Battery	25
Combination switch.....	6	Charging the battery	25
Starter tip switch, emergency OFF switch	6	Main fuse	26
Filler cap.....	6	Fuses for individual power-consuming units	26
Fuel	6	Exchanging the headlight lamp.....	26
Fuel tap.....	7	Replacing the parking light bulb	26
Shift lever	7	Exchanging the brake light and tail light bulb	27
Kickstarter	7	Cooling system.....	27
Foot brake pedal	7	Checking the cooling liquid level	28
Compression damping of fork	8	Cleaning the air filter	28
Rebound damping of fork	8	Adjusting idling speed	28
Compression damping of shock absorber	8	Adjusting the throttle cable	29
Rebound damping of shock absorber	8	Draining the carburetor float chamber.....	29
Holding bars.....	8	Adjusting the clutch cable.....	29
DRIVING INSTRUCTIONS	9	Checking and adjusting the chocke cable play	30
PERIODIC MAINTENANCE-SCHEDULE	14	Checking the adjustment of the hand decompression cable	30
MAINTENANCE WORK ON CHASSIS AND ENGINE	16	Engine oil	30
Tool set	16	Checking the engine oil level	30
Removing the seat.....	16	Oil circuit.....	31
Checking and adjusting steering head bearing.....	17	Oil and fine screen filter change, bleeding of the oil system.....	31
Changing the spring preload of the shock absorber	17	Changing oil filter	32
Lubricate shock absorber linkage	17	TROUBLE SHOOTING	33
Checking rubber ring on the rear shock absorber.....	18	CLEANING.....	36
Checking chain tension.....	18	CONSERVATION FOR WINTER OPERATION	36
Correct chain tension.....	18	STORAGE	36
Chain maintenance.....	18	Re-initiation after time of storage.....	36
Chain wear.....	19	TECHNICAL SPECIFICATIONS - CHASSIS.....	37
General information on KTM disc brakes	19	TECHNICAL SPECIFICATIONS - ENGINE	38
Adjisting of free travel at the hand brake lever	19	CONSUMER INFORMATION FOR USA ONLY	40
Checking of brake fluid level - front brake.....	20	HEAD WORD INDEX.....	43
Refilling the front brake fluid reservoir.....	20	WIRING DIAGRAM.....	APPENDIX
Checking the front brake pads.....	20		
Changing the basic position of the foot brake pedal	20		



SERIAL NUMBER LOCATIONS

Chassis number

The chassis number is stamped on the right side of the steering head tube. Write this number into the relevant area on page 1.

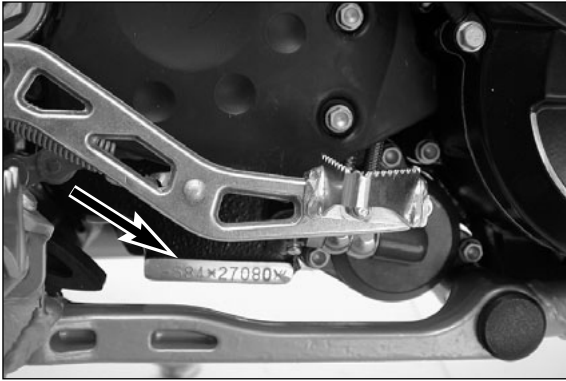

Engine number, engine type

The engine number and engine type are stamped on the right hand side of the engine below the chain sprocket. Write this number into the relevant area on page 1.

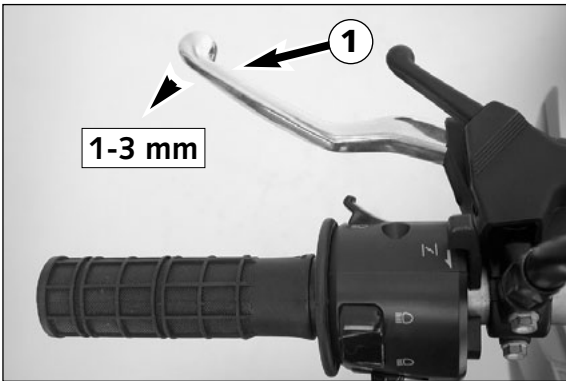

OPERATION INSTRUMENTS

Clutch lever

The clutch lever ① is fitted on the left hand side of the handle bar. When engine is cold, there should always be a play of 1–3 mm (0,04–0,1 in) at this lever (measured at outer edge).

! CAUTION !

IF THERE IS NO PLAY ON THE CLUTCH LEVER, THE CLUTCH WILL START TO SLIP. THE CLUTCH WILL THEN OVERHEAT, DESTROYING THE CLUTCH LININGS.

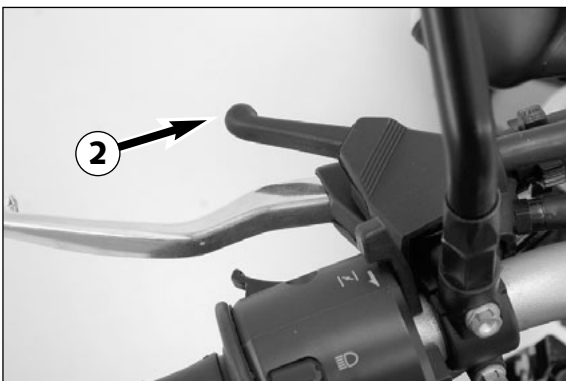

Hand decompression lever

The hand decompression lever ② is only used in two special cases:

- a) When the engine stalled.
It is possible that the starter motor is not able to crank the engine on the next attempt. This is due to the fact that the automatic decompressor doesn't work properly. If this happens, pull the manual decompression lever and start again. Afterwards normal starting will be possible.
- b) When you want to push the motorcycle.

While pushing, pull the hand decompression lever to make it easier to get the engine going.

! CAUTION !

THE SETTING OF THE HAND DECOMPRESSION CABLE SHOULD BE REGULARLY CHECKED (SEE MAINTENANCE WORK). A LACK OF PLAY IN THE HAND DECOMPRESSION LEVER CAN RESULT IN ENGINE DAMAGE.

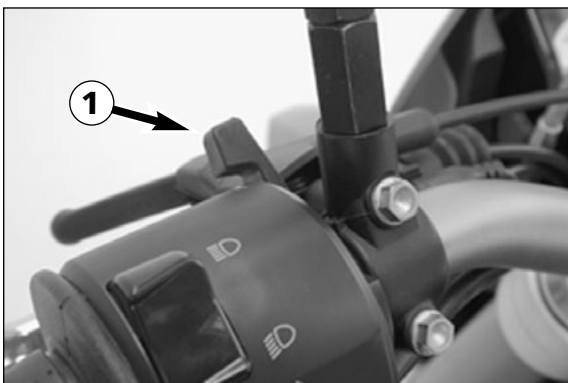

Choke lever

If the choke lever ❶ is pulled backwards, a bore will be opened in the carburetor through which the engine may draw in additional fuel. This produces a „rich“ fuel/air mixture necessary for cold start. If the choke lever is pushed forward up to the stop, the bore will be closed again. In this position the choke cable must have a play of approx. 4 mm.

! CAUTION !

IF THERE IS NO PLAY IN THE CHOKE CABLE, THE BORE OF THE COLD STARTER SYSTEM CANNOT BE COMPLETELY CLOSED. THIS RESULTS IN HIGH FUEL CONSUMPTION, AN UNEVEN RUNNING ENGINE, AND AN EXTREME WEAR OF PISTON AND CYLINDER.

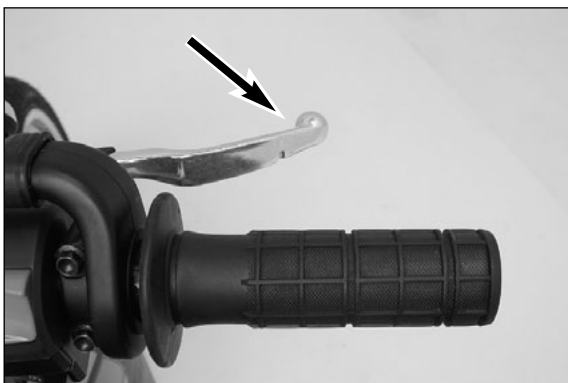

Hand brake lever

The hand brake lever is mounted on the handlebar on the right and actuates the front wheel brake.

⚠ WARNING ⚠

IF THE RESISTANCE IN THE HAND BRAKE LEVER OR FOOT BRAKE PEDAL FEELS „SPONGY“ (TOO MUCH GIVE), THIS IS AN INDICATION THAT SOMETHING IS WRONG WITH THE BRAKE SYSTEM. DON'T RIDE YOUR MOTORCYCLE ANYMORE WITHOUT FIRST HAVING THE BRAKE SYSTEM LOOKED OVER BY A KTM DEALER.

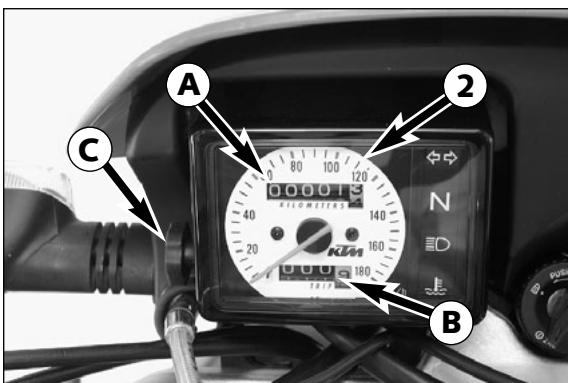

Speedometer, indicator lamps

The mileage indicator ❶ in the speedometer ❷ indicates overall mileage. The day mileage indicator ❸ can be set to 0 by means of the setting wheel ❹. Turn the setting wheel forward until only zeros can be seen in the display.



The green indicator lamp flashes when the flasher light is working in the same rhythm as the flasher light.



The green indicator lamp lights up when the gear is switched to idle.



The blue indicator lamp lights up when the high beam is on.



The red cooling liquid temperature warning lamp lights up at a cooling liquid temperature of 105°C (223°F).

! CAUTION !

POSSIBLE CAUSES FOR THE RISE IN TEMPERATURE AND THE LIGHTING OF THE RED COOLING LIQUID TEMPERATURE WARNING LIGHT:

- SLOW RIDING WITH LARGE LOADS AT A HIGHER AIR TEMPERATURE
- TOO LITTLE COOLING LIQUID IN THE SYSTEM
- THE COOLING FAN ON THE LEFT COOLER IS NOT WORKING
- EXCESSIVE USE OF THE CLUTCH AT SLOW SPEED

(SEE PAGE 27)

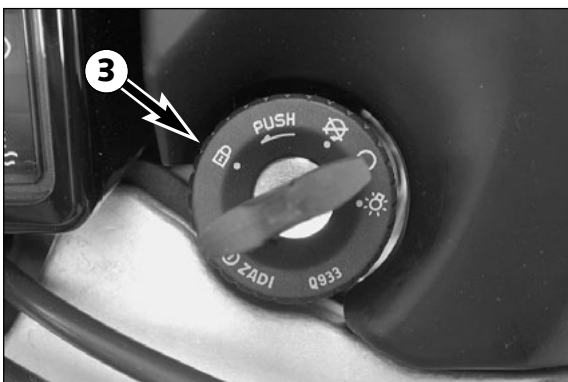

Ignition lock with 4 switch positions

Switch positions of ignition lock ❸:



Ignition off, light off (engine can't be started)



Ignition on, light off (engine can be started)



Ignition on, light on (engine can be started) **Riding just with lights!**



Ignition off, light off, handlebar blocked
To switch the ignition to position ❸ turn the ignition key to position ❶ and firmly press it into the lock. Turn the handlebar all the way to the left, then turn the ignition key to the left.

The ignition key can be withdrawn in position ❶ and ❸.

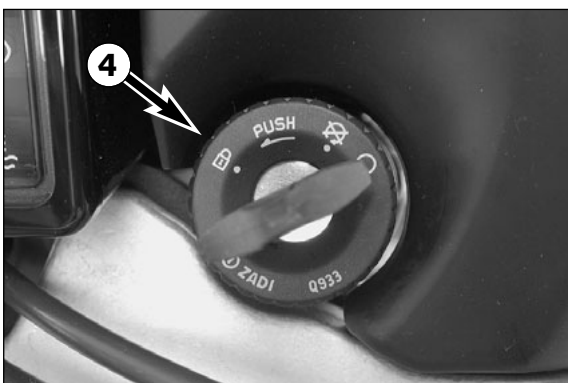

Ignition lock with 3 switch positions

Switch positions of ignition lock ❹:



Ignition off, light off (engine can't be started)



Ignition on, light on (engine can be started)



Ignition off, light off, handlebar blocked
To switch the ignition to position ❹ turn the ignition key to position ❶ and firmly press it into the lock. Turn the handlebar all the way to the left, then turn the ignition key to the left.

The ignition key can be withdrawn in position ❶ and ❹.

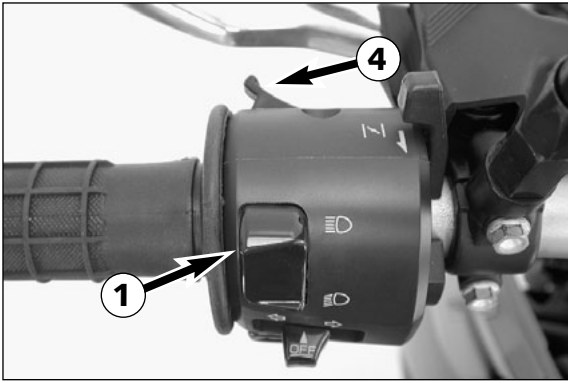

Combination switch

The rocker switch LIGHTS ① actuates the high beam or low beam.

☰☉ = High-beam light

☰☉ = Low-beam light

↔ The indicator switch ② returns to central position after actuation. Press flasher switch towards switch housing to switch off the flasher.

🔊 The horn is sounded with button ③.

☰☉ The light signal (high beam) is actuated with button ④.

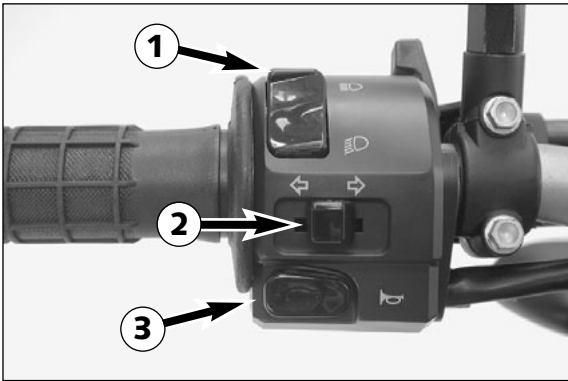

Starter tip switch, emergency OFF tip switch

⚡ Use the starter tip switch ⑤ to operate the electric starter.

! CAUTION !
 MAXIMUM PERIOD FOR CONTINUOUS STARTING: 5 SECONDS. WAIT AT LEAST 5 SECONDS BEFORE TRYING AGAIN.

The emergency off switch ⑥ is provided for emergency situations and should not be used to switch off the engine.

The engine is ready for operation in position ☉ (ignition circuit and starter circuit are switched on).

The engine cannot be started in position ☒ (ignition circuit and starter circuit are interrupted).

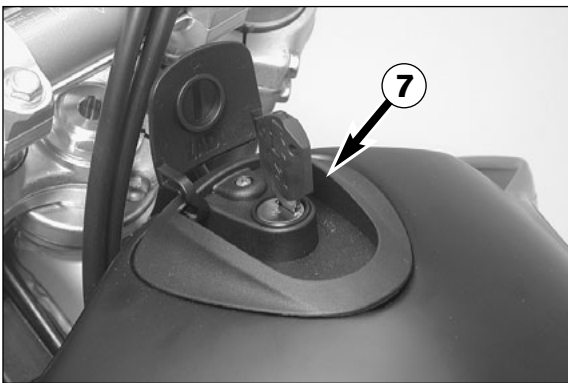
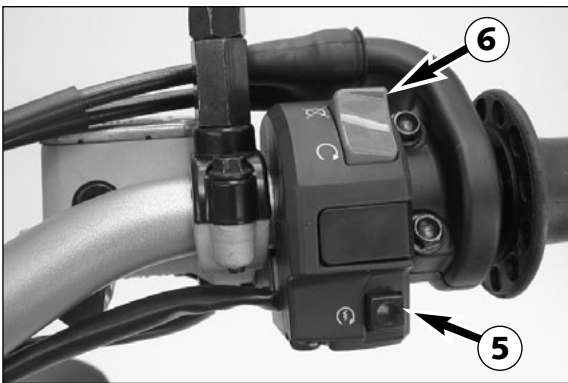

Filler cap

The filler cap ⑦ can be locked and is provided with a fuel evaporation control system.

To open the cap insert the ignition key, turn it 90° counterclockwise, then lift off the filler cap.

To close the tank insert the filler cap, turn the ignition key 90° clockwise and take out the key.

Fuel

The LC4 engine needs premium gasoline with an octane number of 95 or higher.

! CAUTION !
 USE LEADED OR UNLEADED PREMIUM GRADE GASOLINE (95 OCTANES). NEVER USE ANY GASOLINE HAVING LESS THAN 95 OCTANES BECAUSE IT MAY DAMAGE THE ENGINE.

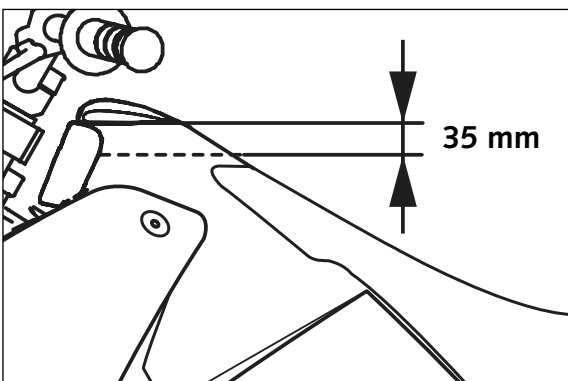

⚠ WARNING ⚠
 GASOLINE IS HIGHLY FLAMMABLE AND POISONOUS. EXTREME CAUTION SHOULD BE USED WHEN HANDLING GASOLINE. DO NOT REFUEL THE MOTORCYCLE NEAR OPEN FLAMES OR BURNING CIGARETTES. ALWAYS SWITCH OFF THE ENGINE BEFORE REFUELLING. BE CAREFUL NOT TO SPILL GASOLINE ON THE ENGINE OR EXHAUST PIPE WHILE THE ENGINE IS HOT. WIPE UP SPILLS PROMPTLY. IF GASOLINE IS SWALLOWED OR SPLASHED IN THE EYES, SEEK A DOCTOR'S ADVICE IMMEDIATELY.

Fuel expands when its temperature rises. Therefore do not fill the tank to the top (see fig.).



Fuel tap

- OFF** In this position the fuel tap is closed. No fuel may flow to the carburetor.
- ON** When using the motorcycle, the twist grip must be set to the **ON** position. Now fuel may flow to carburetor. In this position the tank empties down to the fuel reserve of approx. 2.5 liters.
- RES** The reserve, approximately 2.5 liters, cannot be tapped until the twist grip is turned to the **RES** position. Fill the tank as soon as possible and remember to turn the twist grip back to the **ON** position so that you will have backup fuel next time, too.

! CAUTION !

THE FUEL TAP SHOULD BE LOCKED WHENEVER THE MOTORCYCLE IS PARKED. IF THE TAP IS NOT CLOSED THE CARBURETOR MAY OVERFLOW AND FUEL CAN GET INTO THE ENGINE.

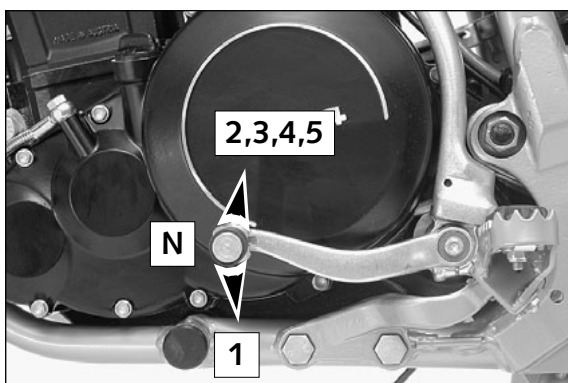
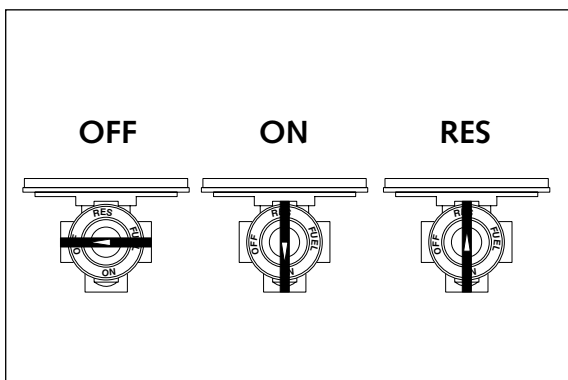

Shift lever

The shift lever is mounted on the left side of the engine. The position of the gears is shown in the illustration. Neutral, or the idle speed, is located between first and second gear.



Kickstarter

The kickstarter is mounted on the left side of the engine. Its upper part can be swivelled.

⚠ WARNING ⚠

- WHEN STARTING THE ENGINE, MAKE SURE THAT YOU ALWAYS WEAR STURDY MOTORCYCLING BOOTS IN ORDER TO AVOID INJURY. YOU MIGHT SLIDE OFF THE KICKSTARTER, OR THE ENGINE MAY CAUSE THE KICKSTARTER TO RECOIL, THEREBY CAUSING INJURIES TO FOOT AND LEG.
- ALWAYS KICK THE KICKSTARTER BRISKLY ALL THE WAY AND, WHILE DOING SO, NEVER OPEN THE THROTTLE. KICKSTARTING WITH INSUFFICIENT MOMENTUM AND AN OPENED THROTTLE LEVER INCREASES THE DANGER OF A POSSIBLE RECOIL.

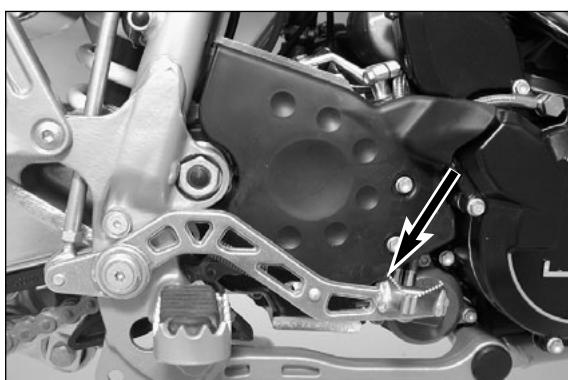

Foot brake pedal

The foot brake pedal is located in front of the right footrest. Its basic position can be adjusted to your seat position (see maintenance work).

⚠ WARNING ⚠

IF THE RESISTANCE IN THE HAND BRAKE LEVER OR FOOT BRAKE PEDAL FEELS "SPONGY" (TOO MUCH GIVE), THIS IS AN INDICATION THAT SOMETHING IS WRONG WITH THE BRAKE SYSTEM. DON'T RIDE YOUR MOTORCYCLE ANYMORE WITHOUT FIRST HAVING THE BRAKE SYSTEM LOOKED OVER BY A KTM DEALER.

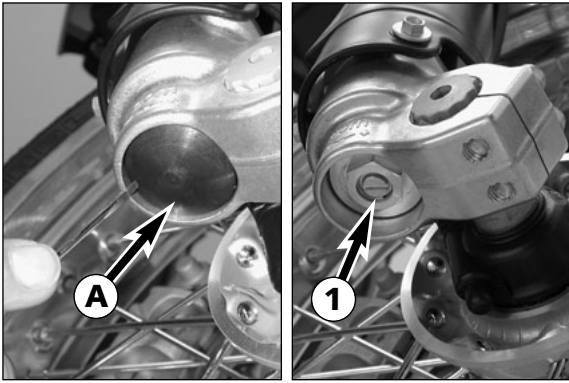

Compression damping of fork

The compression damping is to be set at the lower end of the fork tubes. It only regulates the degree of damping during compression. Remove closing cap **A**. By using the knob **1** (COM), the degree of damping of the compression can be adjusted. Turn the knob clockwise to increase damping, turn it counterclockwise to reduce damping during compression.

BASIC SETTING:

- turn rotary knob clockwise as far as it will go
 - turn it back counter-clockwise by as many clicks as are specified for the relevant type of fork
- | | | |
|-------------------|-----------|---------------------|
| WP 0518W714 | 20 Klicks | (640 LC4) |
| WP 0518W722 | 14 Klicks | (640 LC4 Supermoto) |

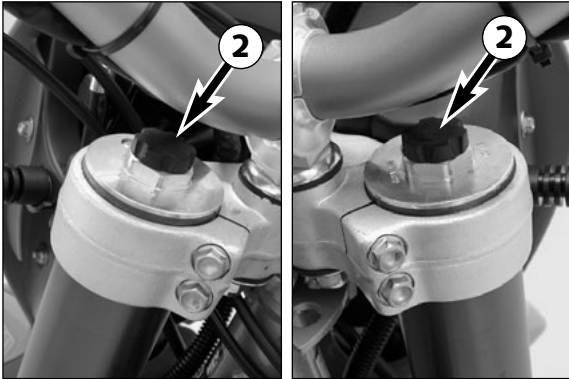

Rebound damping of fork

The rebound damping is to be set at the upper end of the fork tubes. It only regulates the degree of damping during rebounding. By using the knob **2** (REB), the degree of damping of the rebound can be adjusted. Turn the knob clockwise to increase damping, turn it counterclockwise to reduce damping during rebounding.

BASIC SETTING:

- turn rotary knob clockwise as far as it will go
 - turn it back counter-clockwise by as many clicks as are specified for the relevant type of fork
- | | | |
|-------------------|-----------|---------------------|
| WP 0518W714 | 12 Klicks | (640 LC4) |
| WP 0518W722 | 14 Klicks | (640 LC4 Supermoto) |

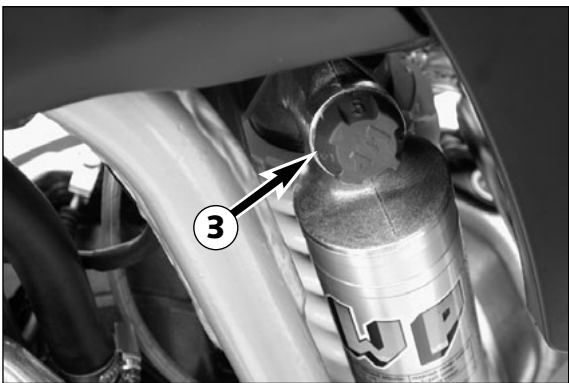

Compression damping of shock absorber

With the knob **3** the degree of damping of the compression can be adjusted to 7 positions. Turn the knob counterclockwise to increase damping, turn it clockwise to reduce damping during compression.

BASIC SETTING:

- | | | |
|------------------|------------|---------------------|
| WP 0118W724..... | Position 6 | (640 LC4) |
| WP 0118W721..... | Position 5 | (640 LC4 Supermoto) |

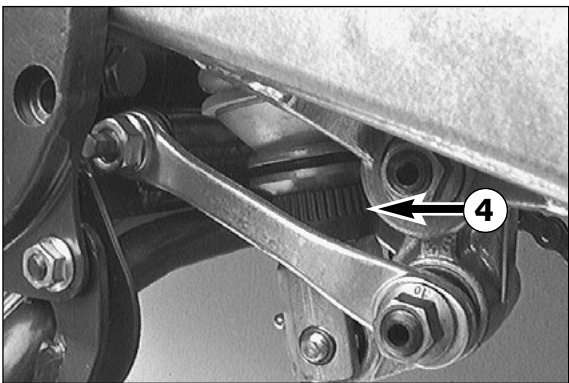

Rebound damping of shock absorber

With the setting wheel **4** the degree of damping of the rebound can be adjusted to 11 positions. Turn the knob to the left side to increase damping, turn it to the right side to reduce damping during rebounding.

BASIC SETTING:

- | | | |
|------------------|------------|---------------------|
| WP 0118W724..... | Position 7 | (640 LC4) |
| WP 0118W721..... | Position 7 | (640 LC4 Supermoto) |



WARNING



- NEVER CHANGE DAMPING BETWEEN THE TEST DRIVES MORE THAN 2 CLICKS.
- THE DAMPING UNIT OF THE SHOCK ABSORBER IS FILLED WITH HIGHLY COMPRESSED NITROGEN. NEVER TRY TO TAKE THE SHOCK ABSORBER APART OR TO DO ANY MAINTENANCE WORK YOURSELF. SEVERE INJURIES COULD BE THE RESULT.



Holding bars

The passenger can hold on to the holding bars on the rear end of the vehicle.

Check the following before each start

When you start off, the motorcycle must be in a perfect technical condition. For safety reasons, you should make a habit of performing an overall check of your motorcycle before each start.

The following checks should be performed:

- 1 CHECK THE OIL LEVEL
Insufficient oil results in premature wear and consequently to engine damage.
- 2 FUEL
Check that there is sufficient fuel in the tank; when closing the filler cap.
- 3 CHAIN
A loose chain can fall off; an extremely worn chain can tear, and insufficient lubrication can result in unnecessary wear to the chain and rear sprockets.
- 4 TIRES
Check for damaged tires. Tires showing cuts or dents must be replaced. The tread depth must comply with the legal regulations. Also check the air pressure. Insufficient tread and incorrect air pressure reduce the driving performance.
- 5 BRAKES
Check the brakes for proper functioning as well as the brake-fluid level in the tanks. The reservoirs have been designed in such a way that brake fluid does not need to be refilled even when the brake pads are worn. If the level of brake fluid falls below the minimum value, this indicates a leak in the braking system or completely worn out brake pads. Arrange for the braking system to be checked by a KTM specialist garage, as complete failure of the braking system can be expected.
Also check the state of the brake hoses and the thickness of the brake linings.
Check free travel at hand brake lever and foot brake pedal.
- 6 CABLES
Check correct setting and easy running of all control cables.
- 7 COOLING LIQUID
Check the level of cooling liquid when the engine is cold.
- 8 ELECTRICAL SYSTEM
Check headlight, parking light, tail light, brake light, flashers, indicator lamps and horn for faultless operation.
- 9 LUGGAGE
If you are taking luggage with you, check that this is securely fastened.



WARNING



- WEAR SUITABLE CLOTHING WHEN DRIVING A MOTORCYCLE. CLEVER KTM DRIVERS ALWAYS WEAR A HELMET, BOOTS, GLOVES AND A JACKET, REGARDLESS OF WHETHER DRIVING ALL DAY OR JUST FOR A SHORT TRIP. THE PROTECTIVE CLOTHING SHOULD BE BRIGHTLY COLOURED SO THAT OTHER USERS OF THE ROADS CAN SEE YOU AS EARLY AS POSSIBLE. YOUR PASSENGER OF COURSE WILL ALSO NEED SUITABLE PROTECTIVE CLOTHING.
- ALWAYS TURN ON THE LIGHT TO MAKE SURE THAT OTHER DRIVERS BECOME AWARE OF YOU AS EARLY AS POSSIBLE.
- DO NOT DRIVE AFTER HAVING CONSUMED ALCOHOL.
- ONLY USE ACCESSORIES THAT HAVE BEEN RELEASED BY KTM. FOR EXAMPLE, FRONT PANNELLING CAN IMPAIR THE DRIVING PROPERTIES OF THE MOTORCYCLE. CASES, EXTRA TANKS ETC. CAN ALTER THE WEIGHT DISTRIBUTION AND THUS ALSO IMPAIR THE VEHICLE'S DRIVING PROPERTIES.
- THE FRONT AND REAR WHEEL ARE ONLY ALLOWED TO BE TIRED WITH TIRES THAT HAVE THE SAME PROFILE TYPE.

Instructions for initial operation

- Verify that your KTM dealer performed the PREPARATION OF VEHICLE jobs (see Customer Service Manual).
- Read the entire manual carefully before your first drive.
- Familiarize yourself with the operating elements.

- Adjust the hand brake lever and the foot brake pedal to the most comfortable positions for you.
- Get used to handling the motorcycle on an empty car park, before starting on a longer drive. Also try to drive as slowly as possible and in standing position, to improve your feeling for the vehicle.
- Do not drive along off-road tracks which go beyond your ability and experience.
- Hold the handlebar with both hands and leave your feet on the foot rests while driving.
- Remove your foot from the foot brake pedal when you are not braking. If the foot brake pedal is not released the brake pads rub continuously and the braking system is overheated.
- You may only be accompanied by a passenger if your motorcycle is fitted and registered for such purposes. The passenger must hold tight to the brackets or hold on to the driver during the drive, with his feet on the passenger foot rests.
- Do not make any alterations to the motorcycle and always use ORIGINAL KTM SPARE PARTS. Spare parts from other manufacturers can impair the safety of the motorcycle.
- Motorcycles are sensitive to alterations in the distribution of weight. If you are taking luggage with you, this should be secured as close as possible to the middle of the vehicle; distribute the weight evenly between the front and rear wheel. Never exceed the maximum permissible laden weight and the axle weights. The maximum permissible laden weight is made up of the following components:
 - Motorcycle ready for operation and tank full
 - Luggage
 - Driver and passenger with protective clothing and helmet.
- Pay attention to running in instructions.

Running in the LC4 models

Even finely machined surfaces of engine parts have rougher surfaces than parts that slide on each other for a long time. Therefore, every engine must be run in. For this reason, do not demand maximum performance from the engine for the first 100 kilometers. The vehicle must be run in at low, changing performance level for the first 1000 KM (620 miles). The engine speed of 4800 r.p.m. must not be exceeded during the first 1000 kilometers (620 miles). During this break-in time, you should ride your motorcycle in different conditions. The following table shows you the maximum velocity values in the different gears at 4800 r.p.m. as based on the rear wheel transmission ratio of your motorcycle.

Exceeding the above listed rotations as well as pushing high rpm when the engine is cold will have an adverse effect on the life of your engine.

ratio gear	640 LC4 16:42 t	Supermoto 17:42 t				
1st	35 (22)	35 (22)				
2nd	50 (32)	50 (32)				
3rd	70 (44)	70 (44)				
4th	90 (57)	90 (57)				
5th	100 (63)	100 (63)				

km/h (mph)

NOTE:

DURING THE STAGE OF RUNNING THE ENGINE IN, THAT IS THE FIRST 1000 KM (620 MILES), THE ENGINE OIL USED SHOULD BE OF A MINERAL OIL FORMULA. THIS ALSO APPLIES IF THE ENGINE HAS BEEN REPAIRED.

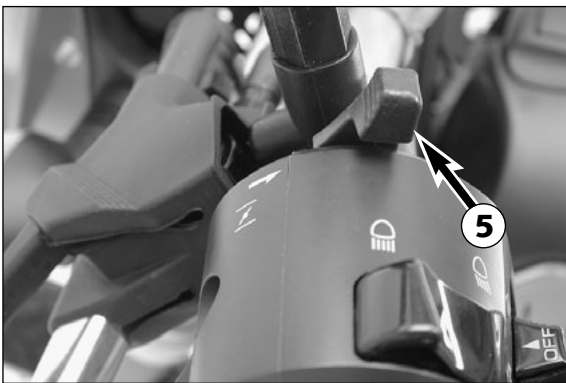
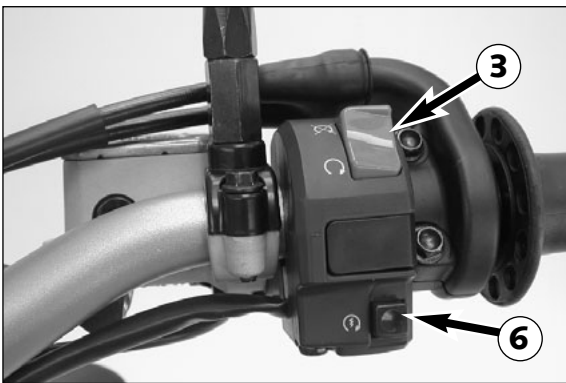
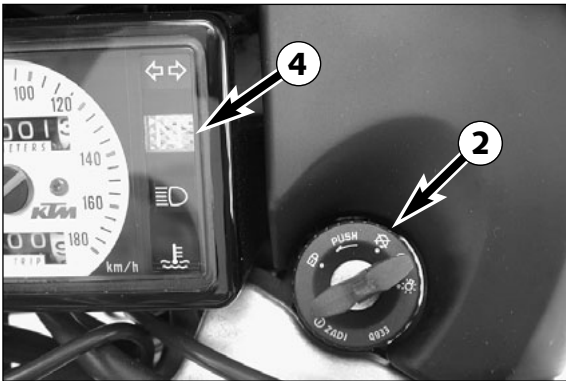
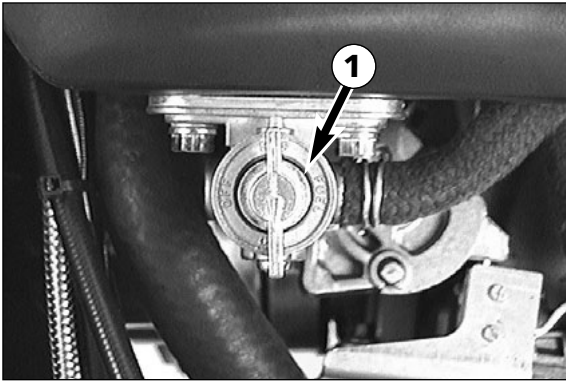

Starting when the engine is cold

- 1 Open the fuel tap ①
- 2 Switch on ignition (turn ignition key ② into position ☉).
- 3 Switch on emergency OFF switch ③.
- 4 Switch transmission to idle (green indicator lamp N ④ lights up).
- 5 Operate cold starting device (choke) ⑤.
- 6 Do not accelerate; operate starter button ⑥.
- 7 If the engine starts, push the choke lever back a little bit, as soon as the engine runs unevenly.
- 8 Take the motorcycle off of the main stand or side stand.

⚠ **WARNING** ⚠

- To AVOID INJURIES, IT IS RECOMMENDED TO WEAR BOOTS WHEN USING THE KICKSTARTER.
- DO NOT START THE ENGINE AND ALLOW IT TO IDLE IN A CLOSED ROOM. EXHAUST FUMES ARE POISONOUS AND CAN CAUSE LOSS OF CONSCIOUSNESS AND DEATH. ALWAYS PROVIDE ADEQUATE VENTILATION WHILE THE ENGINE IS RUNNING.

! **CAUTION** !

- MAXIMUM PERIOD FOR CONTINUOUS STARTING: 5 SECONDS. WAIT AT LEAST 5 SECONDS BEFORE TRYING AGAIN.
- DON'T RIDE YOUR MOTORCYCLE WITH FULL LOAD AND DON'T REV ENGINE WHEN COLD. BECAUSE THE PISTON IS WARMING UP FASTER THAN THE WATER COOLED CYLINDER, IT CAN CAUSE ENGINE DAMAGE. ALWAYS LET THE ENGINE WARM UP BEFORE AND REFRAIN FROM DRIVING WITH FULL LOAD UNTIL THE ENGINE IS WARM.

IF THE ENGINE DOES NOT CRANK WHEN YOU ACTUATE THE STARTER TIP SWITCH:

- the transmission is switched to idle
- Check if the emergency OFF switch is on
- Check if the ignition is on
- the headlight is on (ignition lock in position ☼).
- If this is not the case, the battery is discharged
- If the lights are on, proceed as described in the „Trouble-shooting“ section or contact a KTM dealer.

IF THE ENGINE CRANKS BUT DOES NOT START, WHEN YOU ACTUATE THE STARTER TIP SWITCH:

- Check if the fuel tap is open
- Check if the choke lever has been operated
- Check if sufficient fuel is in the tank
- If this is not the case, refill the tank
- if sufficient fuel is in the tank, proceed as described in the „Trouble-shooting“ section or contact a KTM dealer.

NOTE LC4:

This motorcycle is equipped with a safety starter system. The engine can only be started when the transmission is switched to idle or the clutch lever is pulled, respectively.

NOTE LC4 SUPERMOTO:

This motorcycle is equipped with a safety starter system. The engine can only be started when the transmission is switched to idle or the clutch lever is pulled, respectively.

Motorcycles with side stands are also equipped with a safety starting system.

If you put in a gear with the side stand in its swung-out position, and if you let go of the clutch lever, the engine will stop.

Starting when the engine is warm or hot

- 1 Open the fuel tap ①
- 2 Switch on ignition (turn ignition key ② into position ☉).
- 3 Switch on emergency OFF switch ③.
- 4 Switch transmission to idle (green indicator lamp N ④ lights up).
- 5 Do not accelerate; operate starter button ⑥.
- 6 Take the motorcycle off of the main stand or side stand.

What to do when the engine is „flooded“

The throttle must be fully opened when starting. If necessary change spark-plug.

Kickstart instructions

Start as described above, then push the kickstarter hard ALL THE WAY.



WARNING



- WHEN STARTING THE ENGINE, MAKE SURE THAT YOU ALWAYS WEAR STURDY MOTORCYCLING BOOTS IN ORDER TO AVOID INJURY. YOU MIGHT SLIDE OFF THE KICKSTARTER, OR THE ENGINE MAY CAUSE THE KICKSTARTER TO RECOIL, THEREBY CAUSING INJURIES TO FOOT AND LEG.
- ALWAYS KICK THE KICKSTARTER BRISKLY ALL THE WAY AND, WHILE DOING SO, NEVER OPEN THE THROTTLE. KICKSTARTING WITH INSUFFICIENT MOMENTUM AND AN OPENED THROTTLE LEVER INCREASES THE DANGER OF A POSSIBLE RECOIL.

Starting off

Pull the clutch lever. Put the engine into first gear, slowly release the clutch lever and open throttle at the same time.



WARNING



- BEFORE YOU START OFF, CHECK THAT THE MAIN STAND HAS BEEN SWUNG UP FULLY. IF THE STAND DRAGS ON THE GROUND, THE MOTORCYCLE CAN GO OUT OF CONTROL.
- ALWAYS TURN ON THE LIGHT TO MAKE SURE THAT OTHER DRIVERS BECOME AWARE OF YOU AS EARLY AS POSSIBLE.

Shifting/Riding

You are now in first gear, referred to as the drive or uphill gear. Depending on the conditions (traffic, road gradient, etc.), you can shift to a higher gear. Close throttle, at the same time pull clutch lever and shift to the next higher gear. Let clutch lever go again and open throttle. If you turned on the choke, make sure you turn it off again as soon as engine is warm.

When you reach full speed through turning the throttle grip all the way, turn throttle back to 3/4; the speed hardly decreases although the engine will use less gas. Never open the throttle wider than the engine can handle. Excessive turning of the throttle grip will increase full consumption.



By shifting down, use the brakes if necessary and close throttle at the same time. Pull clutch lever and shift down to the next gear. Let clutch lever go slowly and open throttle or shift down again.

If the engine is killed f.ex. at a crossing, simply pull the clutch lever and start. It is not necessary to switch the gear to NEUTRAL.



WARNING



- OBSERVE THE TRAFFIC REGULATIONS, DRIVE DEFENSIVELY AND TRYING TO LOOK AHEAD AS FAR AS POSSIBLE SO THAT ANY HAZARDS CAN BE RECOGNIZED AS EARLY AS POSSIBLE.
- ADJUST YOUR DRIVING SPEED ACCORDING TO THE CONDITIONS AND YOUR DRIVING SKILLS.
- DRIVE CAREFULLY ON UNKNOWN ROADS
- AVOID ABRUPT LOAD CHANGES WHILE RIDING AROUND BENDS AND ON WET OR SLIPPERY GROUND. OTHERWISE YOU MIGHT EASILY LOSE CONTROL OVER YOUR MOTORCYCLE.
- WHILE RIDING YOUR MOTORCYCLE, NEVER SWITCH THE IGNITION LOCK TO POSITIONS  AND .
- RENEW THE VIZOR ON YOUR HELMET OR THE GLASS OF YOUR GOGGLES ON TIME SO AS TO ENSURE OPTIMUM VISION IN ANY SITUATION.
- WHEN DRIVING OFF-ROAD, ALWAYS HAVE A FRIEND ON A SECOND MOTORCYCLE TO KEEP YOU COMPANY, SO THAT YOU CAN HELP EACH OTHER SHOULD DIFFICULTIES ARISE.
- REPLACE THE HELMET VISOR RESPECTIVELY GOGGLE GLASSES IN PLENTY OF TIME. WHEN LIGHT SHINES DIRECTLY ON SCRATCHED VISOR OR GOGGLES, YOU WILL BE PRACTICALLY BLIND.

- AFTER FALLING WITH THE MOTORCYCLE, CHECK ALL FUNCTIONS THOROUGHLY BEFORE STARTING UP OPERATIONS AGAIN.
- A DEFORMED HANDLEBAR MUST ALWAYS BE REPLACED. UNDER NO CIRCUMSTANCES SHOULD YOU STRAIGHTEN THE HANDLEBAR WHICH WOULD CONSEQUENTLY LOSE ITS STABILITY.



CAUTION



- HIGH RPM RATES WHEN THE ENGINE IS COLD HAVE AN ADVERSE EFFECT ON THE LIFE OF YOUR ENGINE. WE RECOMMEND YOU RUN THE ENGINE IN A MODERATE RPM RANGE FOR A FEW MILES GIVING IT A CHANCE TO WARM UP. AFTER THAT NO FURTHER PRECAUTIONS IN THIS RESPECT NEED BE TAKEN. THE ENGINE HAS REACHED ITS OPERATING TEMPERATURE AS SOON AS THE RADIATORS BECOME WARM.
- NEVER HAVE THE THROTTLE WIDE OPEN WHEN CHANGING DOWN TO A LOWER GEAR. THE ENGINE WILL OVERSPEED, DAMAGING THE VALVES. IN ADDITION, THE REAR WHEEL BLOCKS SO THAT THE MOTORCYCLE CAN EASILY GET OUT OF CONTROL.
- LONG WHEELIES LEAD TO A DROP IN THE OIL PRESSURE WHICH CAN LEAD TO ENGINE DAMAGE.
- NEVER USE YOUR MOTORCYCLE WITHOUT AN AIR FILTER. OTHERWISE DUST AND DIRT MAY ENTER THE ENGINE AND CAUSE INCREASED WEAR.
- THE RED COOLANT WARNING LAMP LIGHTS UP WHEN THE COOLANT TEMPERATURE HAS REACHED 105°C.
POSSIBLE CAUSES FOR THE INCREASE IN TEMPERATURE:
 - LOW DRIVING VELOCITY AND HIGH LOAD SITUATION IN HIGH AIR TEMPERATURES
 - LEVEL OF COOLANT IN THE SYSTEM IS INSUFFICIENT
 - FAN AT LEFT RADIATOR IS NOT RUNNING
 - IMPROPER USE OF THE CLUTCH WHILE DRIVING AT LOW VELOCITIESPLACE A CLOTH ON THE RADIATOR CAP. OPEN THE CAP SLOWLY, SO THE EXCESS PRESSURE IN THE COOLING SYSTEM CAN ESCAPE.
- CAUTION SCALDING HAZARD! - AND CHECK THE COOLING LIQUID LEVEL.
DO NOT DRIVE ON, UNTIL THERE IS SUFFICIENT LIQUID IN THE COLING SYSTEM. HOWEVER, CALL ON ONE OF KTM'S DEALERS AS SOON AS POSSIBLE IN ORDER TO HAVE THE DEFECT REMEDIED.
- IF ANY ABNORMAL VIBRATIONS OCCUR WHILE DRIVING, CHECK THAT THE ENGINE FASTENING BOLTS ARE TIGHT.
- IN THE EVENT THAT, WHILE RIDING ON YOUR MOTORCYCLE, YOU NOTICE ANY UNUSUAL OPERATION-RELATED NOISE, STOP IMMEDIATELY, TURN THE ENGINE OFF, AND CONTACT AN AUTHORIZED KTM DEALER.

Braking

Close throttle and apply the hand and foot brakes at the same time. When driving on sandy, wet or slippery ground use mainly the rear wheel brake. Always brake with feeling, blocking wheels can cause you to skid or fall. Also change down to lower gears depending on your speed.

When driving downhill, use the braking effect of the engine. Change down one or two gears but do not overspeed the engine. In this way, you will not need to brake so much and the brakes will not overheat.



WARNING



- IN THE RAIN, OR AFTER THE MOTORCYCLE HAS BEEN WASHED, BRAKING ACTION MAY BE DELAYED DUE TO WET BRAKE DISCS. FIRST, THE BRAKES MUST BE BRAKED DRY.
- ON SALT-SPRAYED OR DIRTY ROADS BRAKE ACTION MAY BE DELAYED AS WELL. FIRST, THE BRAKES MUST BE BRAKED CLEAN.
- WHEN YOU BRAKE, THE BRAKE DISCS, BRAKE PADS, BRAKE CALIPER AND BRAKE FLUID HEAT UP. THE HOTTER THESE PARTS GET, THE WEAKER THE BRAKING EFFECT. IN EXTREME CASES, THE ENTIRE BRAKING SYSTEM CAN FAIL.

Stopping and parking

Apply the brakes fully and put the engine into neutral. To stop the engine, switch off the ignition. Turn the fuel tap to the OFF position, park on an area where the ground is firm, and lock the motorcycle.



WARNING



- ALWAYS PARK YOUR MOTORBIKE ON A SOLID AND HORIZONTAL SURFACE.
- NEVER LEAVE YOUR MOTORCYCLE WITHOUT SUPERVISION AS LONG AS THE ENGINE IS RUNNING.
- MOTORCYCLE ENGINES PRODUCE A GREAT AMOUNT OF HEAT WHILE RUNNING. THE ENGINE RADIATORS, EXHAUST, EXHAUST SYSTEM, BRAKE DISCS, AND SHOCK ABSORBERS CAN BECOME VERY HOT. DO NOT TOUCH ANY OF THESE PARTS AFTER OPERATING THE MOTORCYCLE, AND TAKE CARE TO PARK IT WHERE PEDESTRIANS ARE NOT LIKELY TO TOUCH IT AND GET BURNED
- NEVER PARK YOUR MOTORCYCLE IN PLACES WHERE THERE EXIST FIRE HAZARDS DUE TO DRY GRASS OR OTHER EASILY FLAMMABLE MATERIALS.



CAUTION



- CLOSE THE FUEL TAP WHEN LEAVING YOUR VEHICLE. OTHERWISE THE CARBURETOR CAN OVERFLOW AND FUEL WILL ENTER THE ENGINE.
- ALWAYS TAKE OUT THE IGNITION KEY WHEN PARKING YOUR MOTORCYCLE SO THAT IT CANNOT BE USED BY UNAUTHORIZED PERSONS.



NOTE REGARDING THE CENTER STAND:

We advise the following procedure to place the motorcycle on the center stand as effortlessly as possible:

- a) press main stand to ground using foot
- b) swing out kickstarter and pull motorcycle backwards at an angle as illustrated (see illustration).

Make sure that the ground is solid and that your motorcycle is standing securely.



CAUTION



THE CENTER STAND IS DESIGNED TO HOLD THE WEIGHT OF THE MOTORCYCLE ONLY. BY SITTING ON THE MOTORCYCLE, YOU WILL PUT ADDITIONAL WEIGHT ON THE CENTER STAND, POSSIBLY CAUSING THE CENTER STAND OR FRAME TO BE DAMAGED OR THE MOTORCYCLE TO FALL DOWN.

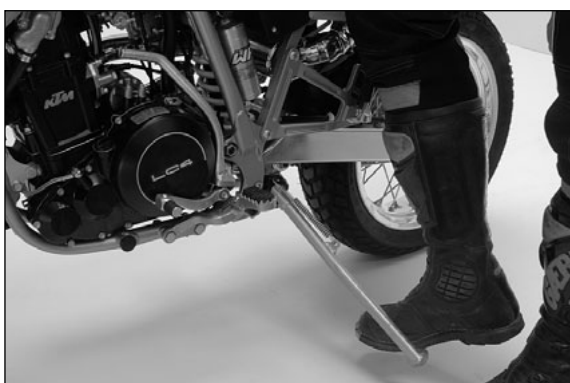

INFORMATION ABOUT THE SIDE STAND:

Use your foot to push the side stand forward as far as possible, and lean your motorcycle to the side. Make sure that your motorcycle is standing safely on solid ground. Just in case, you can also put in a gear.



CAUTION



THE SIDE STAND IS DIMENSIONED FOR THE WEIGHT OF THE MOTORCYCLE ONLY. IF YOU ARE SITTING ON THE MOTORBIKE AND THUS APPLY AN ADDITIONAL LOAD ONTO THE SIDE STAND, YOU MAY CAUSE DAMAGE TO THE SIDE STAND OR THE FRAME, AND YOUR MOTORBIKE MAY FALL OVER.

A washed motorcycle can be checked more quickly which saves money!

1. Service after 1000 km	2. Service after 5000 km, then every 5000 km or once a year
--------------------------	---

	1. Service after 1000 km	2. Service after 5000 km, then every 5000 km or once a year	
ENGINE	Change engine oil, oil filter, and fine filter	●	●
	Clean oil screens and magnet of drain plug	●	●
	Check oil lines for damage and kink-less arrangement	●	●
	Check and adjust spark plug, replace it every 10,000 km		●
	Check and adjust valve clearance	●	●
	Check engine fastening screws for tight fit	●	●
	Make sure all engine screws accessible from the outside are screwed tight.	●	●
CARBURETOR	Check carburetor connection boots for cracks and leaks		●
	Check idle setting	●	●
	Check bleeder hoses for damage and kink-free arrangement	●	●
ADD-ON-PARTS	Check cooling system for leaks, antifreeze protection	●	●
	Check radiator fan for proper operation		●
	Check exhaust system for leaks and suspension	●	●
	Check actuating cables for damage, smooth operation, and kink-less arrangement, adjust and lubricate them	●	●
	Clean air filter and air filter box		●
	Check cables for damage and kink-less arrangement		●
	Check headlamp adjustment		●
	Check electrical system for function (low/high beams, stop light, turn indicators, headlamp flasher, tell-tale lamps, speedometer illumination, horn, side-stand switch, clutch switch, emergency-off switch)	●	●
	Make sure all screws and nuts are tight.	●	●
	BRAKES	Check brake fluid level, lining thickness, and brake discs	●
	Check brake lines for damage and leaks	●	●
	Check/adjust smooth operation, free travel of handbrake/footbrake levers	●	●
	Check screws of brake system for tight fit	●	●
CHASSIS	Check suspension strut and fork for leaks and proper operation	●	●
	Check O-ring of suspension strut for wear		●
	Clean fork dust sleeves		●
	Bleed fork legs	●	●
	Check swinging-fork pivot	●	●
	Check/adjust steering-head bearing	●	●
	Lubricate reversing lever		●
	Check all chassis screws for tight fit (fork plates, fork leg, axle nuts/screws, swinging-fork pivot, reversing lever, suspension strut)	●	●
WHEELS	Check spoke tension and rim joint	●	●
	Check tire condition and inflation pressure	●	●
	Check chain and chain guides for wear, force fit and tension.	●	●
	Check screws on pinion and chain sprocket for locking devices and a tight fit.	●	●
	Lubricate chain	●	●
	Check wheel bearings and jerk damper for play		●

IMPORTANT RECOMMENDED MAINTENANCE PROCEDURES TO BE PERFORMED BASED ON A SEPARATE SUPPLEMENTARY ORDER

	at least once a year	every 2 years or 20000 km
Perform complete fork maintenance	●	
Perform complete suspension strut maintenance		●
Perform complete reversing lever maintenance		●
Clean and lubricate steering-head bearing and sealing elements	●	
Clean and adjust the carburetor	●	
Treat the electrical contacts and switches with contact spray	●	
Treat battery connections with contact grease	●	
Change the brake fluid	●	

IF MOTORCYCLE IS USED FOR COMPETITION 5000 KM SERVICE SHOULD BE CARRIED OUT AFTER EVERY RACE! SERVICE INTERVALLS SHOULD NEVER BE EXCEED BY MOOR THAN 500 KM. MAINTENANCE WORK DONE BY KTM AUTHORISED WORKSHOPS IS NOT A SUBSTITUTE OF CARE AND CHECKS DONE BY THE RIDER!

VITAL CHECKS AND CARE PROCEDURES TO BE CONDUCTED BY THE OWNER OR THE MECHANIC

	before each start	after every cleaning	for cross country use	once a year
Check oil level	●			
Check brake fluid level	●			
Check brake pads for wear	●			
Check lighting system for proper operation	●			
Check horn for proper operation	●			
Lubricate and adjust actuating cables and nipples		●		
Bleed fork legs in regular intervals			●	
Remove and clean fork dust sleeves in regular intervals			●	
Clean and lubricate chain as necessary		●	●	
Check chain tension	●	●	●	
Clean air filter and filter box			●	
Check tire pressure and wear	●			
Check coolant level	●			
Check fuel lines for leaks	●			
Drain float chamber		●		
Check all control elements for smooth running.	●			
Check brake performance	●	●		
Treat exposed metal components (except for the braking and exhaust systems) with wax-based anti-corrosion agents		●		
Treat ignition/steering lock and light switch with contact spray		●		
Check all screws, nuts, and hose clamps for their tight fit				●

MAINTENANCE WORK ON CHASSIS AND ENGINE



WARNING



ALL SERVICING AND ADJUSTMENT PROCEDURES DESIGNATED BY AN ASTERISK * REQUIRE THE KNOWLEDGE AND SKILLS OF A PROFESSIONAL. IN THE INTEREST OF YOUR OWN SAFETY, HAVE THESE PROCEDURES CARRIED OUT AT A KTM SERVICE STATION! AT KTM YOUR MOTORCYCLE WILL RECEIVE OPTIMAL SERVICING BY SPECIALLY TRAINED MECHANICS.



CAUTION



- WHEN CLEANING THE MOTORCYCLE, DO NOT USE A HIGH PRESSURE CLEANING UNIT IF POSSIBLE, OTHERWISE WATER WILL PENETRATE THE BEARINGS, CARBURETOR, ELECTRIC CONNECTORS ETC.
- WHEN TRANSPORTING YOUR KTM, ENSURE THAT IT IS HELD UPRIGHT WITH RESTRAINING STRAPS OR OTHER MECHANICAL FASTENING DEVICES. IF THE MOTORCYCLE SHOULD FALL OVER, FUEL CAN LEAK FROM THE CARBURETOR OR FUEL TANK
- DO NOT USE TOOTHED WASHERS OR SPRING WASHERS WITH THE ENGINE FASTENING SCREWS, AS THESE WORK INTO THE FRAME PARTS AND KEEP WORKING LOOSE. INSTEAD, USE SELF-LOCKING NUTS.
- LET YOUR MOTORCYCLE COOL DOWN BEFORE BEGINNING ANY MAINTENANCE WORK IN ORDER TO AVOID GETTING BURNED.
- DISPOSE OF OIL, GREASE, FILTERS, FUELS, CLEANING AGENTS ETC. ACCORDING TO YOUR LOCAL REGULATIONS.
- UNDER NO CIRCUMSTANCES MAY USED OIL BE DISPOSED OF IN THE SEWAGE SYSTEM OR IN THE OPEN COUNTRYSIDE. 1 LITER USED OIL CONTAMINATES 1,000.000 LITERS WATER.
- IF YOU UNFASTEN SELF-LOCKING NUTS, YOU HAVE TO REPLACE THEM BY NEW ONES.
- IF YOU UNFASTEN SCREWS AND NUTS SECURED BY LOCTITE, YOU HAVE TO REATTACH AND SECURE THEM IN THE SAME WAY. SEE TECHNICAL SPECIFICATIONS - FASTENING TORQUES ON PAGE 39.



Tool set

The tool set ❶ is located in the tool box under the right side cover.

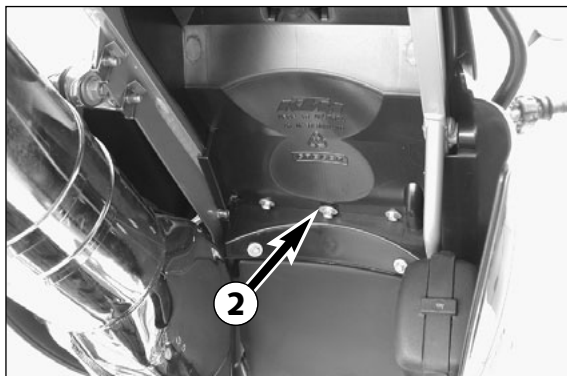

Removing the seat

Remove the collar screws ❷ from the underside of the fender. Lift the rear of the seat, pull backwards, and unhook it from the oval-head screw ❸.

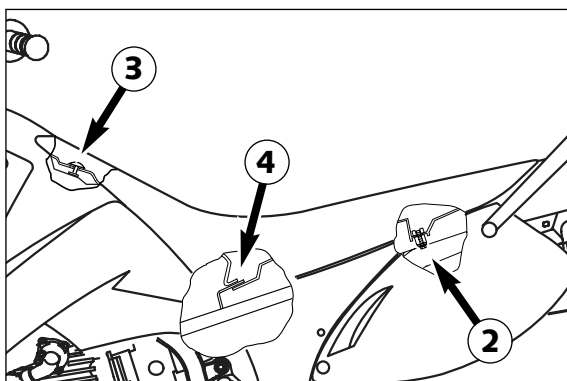

To mount the seat hook it into the oval head screw, lower the rear part of the seat and push the whole seat forwards. If necessary push the middle of the seat slightly down to let the retaining bracket ❹ engage with the seat. Finally fasten the seat with the corresponding screw.

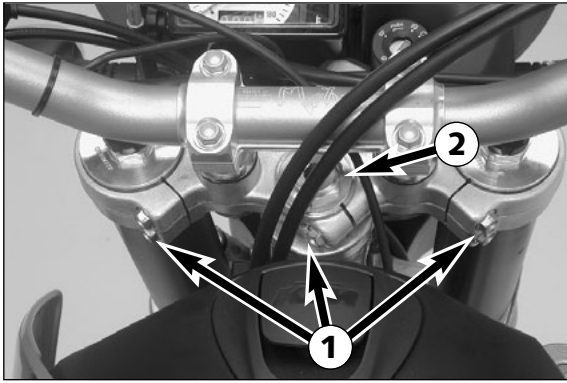

Checking and adjusting steering head bearing *

Check steering head bearing for play periodically. To check this put motorcycle on a stand so that the front wheel is off the ground. Now try to move the fork forward and backward. To adjust, loosen the five clamp screws ① of the top triple clamp and turn steering stem bolt clockwise ② until there is no more play. Don't tighten the steering stem bolt all the way, otherwise the bearings will be damaged. With a plastic hammer, lightly rap on the triple clamp to avoid tension. Re-tighten the five clamp screws with 15 Nm (11 ft.lb).



WARNING



IF THE STEERING HEAD BEARING IS NOT ADJUSTED TO BE FREE OF PLAY, THE MOTORCYCLE WILL SHOW AN UNSTEADY DRIVING PERFORMANCE AND CAN GET OUT OF CONTROL.



CAUTION



IF YOU DRIVE WITH PLAY IN THE STEERING HEAD BEARING FOR LONGER PERIODS, FIRST THE BEARINGS AND THEN THE BEARING SEATS IN THE FRAME WILL BE DESTROYED.

At least once a year, the steering head bearings should be greased.

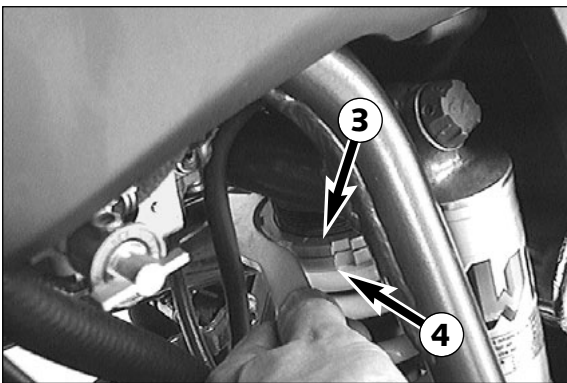
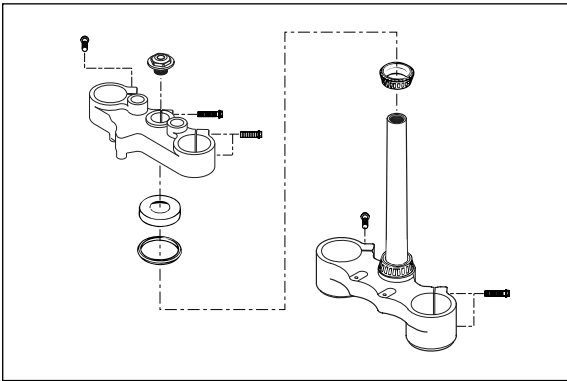

Changing the spring preload of the shock absorber

KTM sets the shock absorber for a driver only, weighing approximately 75 kg (165 lb). If you want to take a passenger with you, or if you weigh considerably more or less than 75 kg (165 lb), you should change the spring preload accordingly ①. This is easily done.

NOTE:

- Before changing the spring preload note down the basic setting, e.g. how many threads are visible above the adjusting ring.
- One rotation of the adjusting ring ④ changes the spring preload by approximately 1,75 mm (0,07 in).

Loosen the locking ring ③ with the hook wrench from the tool set. Change the spring preload with the adjusting ring ④ and retighten the locking ring.

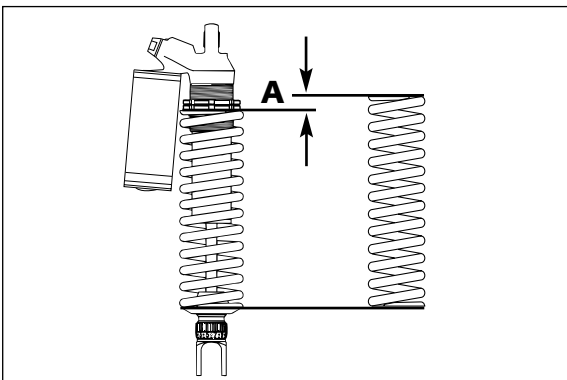

BASIC SETTING – SPRING PRELOAD

WP 0118W724.....A = 23,5mm (640 LC4)

WP 0118W721.....A = 15mm (640 LC4 Supermoto)

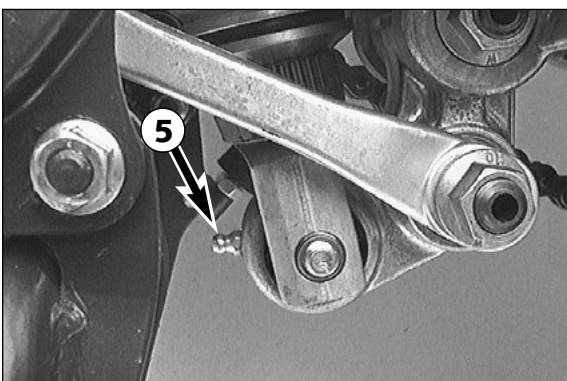

Lubricating the shock absorber linkage

The bearings in the rocker arm must be greased (Shell Advance Grease) in regular intervals. For this purpose, a grease nipple ⑤ is mounted on the rocker arm.



CAUTION



AFTER EACH TIME THE MOTORCYCLE IS WASHED, IT IS ESPECIALLY IMPORTANT TO GREASE THE GREASE NIPPLE TO PUSH ANY WATER OUT OF THE BEARINGS.

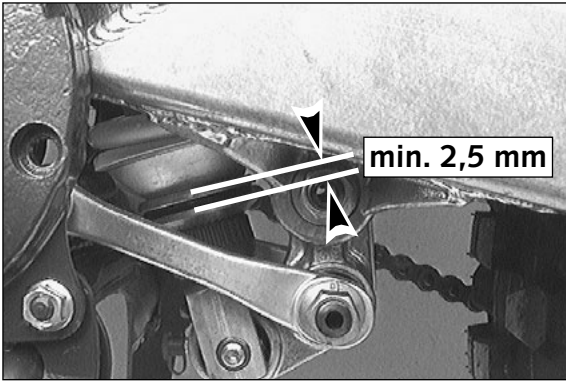

Checking rubber ring on the WP rear shock absorber

A rubber ring mounted on the rear shock absorber serves as a vibration damper. This ring gets pressed together with time and loses its shock absorbing quality.

Measure the distance between the two discs at various points around their circumferences. The space should be at least 2.5 mm (0,1 in) wide. Have the rubber ring replaced by an KTM dealer when compaction due to wear has exceeded this lower limit.

! CAUTION !

NOT REPLACING THE RUBBER RING IN TIME CAN RESULT IN DAMAGE TO THE REAR SHOCK ABSORBER.

⚠ WARNING ⚠

THE DAMPING UNIT OF THE SHOCK ABSORBER IS FILLED WITH HIGH COMPRESSED NITROGEN. NEVER TRY TO TAKE THE SHOCK ABSORBER APART OR TO DO ANY MAINTENANCE WORK YOURSELF. SEVERE INJURIES COULD BE THE RESULT.

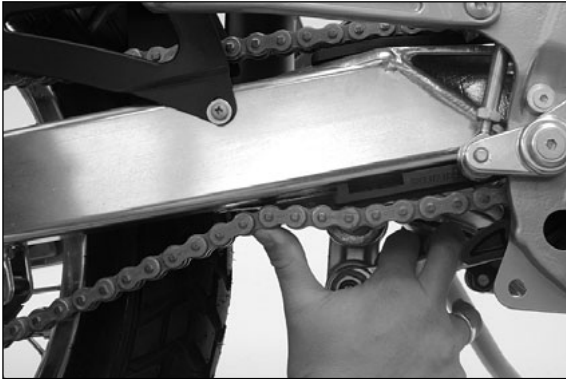

Checking chain tension

Support the motorcycle on the center stand or side stand, respectively. Switch transmission to neutral.

Push the chain upwards appr. 30 mm (1,2 in) from the end of the chain sliding component until the upper part of the chain is tensioned (see illustration)

Now, the distance **A** between chain and swingarm should be 0 mm. The upper part of the chain **B** must be tight (see illustration).

Correct chain tension, if necessary!

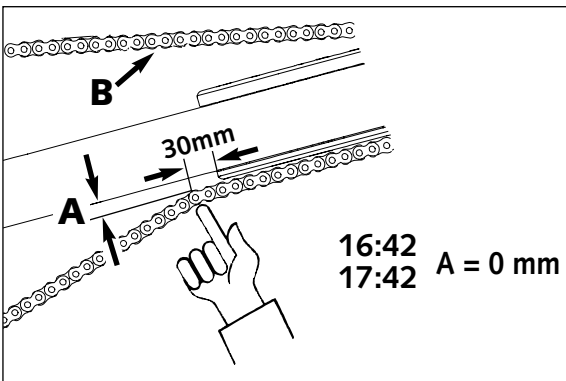

⚠ WARNING ⚠

- IF CHAIN TENSION IS TOO GREAT, PARTS WITHIN THE SECONDARY POWER TRANSMISSION (CHAIN, CHAIN SPROCKETS, TRANSMISSION AND REAR WHEEL BEARINGS) WILL BE SUBJECTED TO UNNECESSARY STRESS, RESULTING IN PREMATURE WEAR AND EVEN CHAIN BREAKAGE.
- TOO MUCH SLACK IN THE CHAIN, ON THE OTHER HAND, CAN RESULT IN THE CHAIN JUMPING OFF THE CHAIN WHEELS. IF THIS HAPPENS, THE CHAIN COULD ALSO BLOCK THE REAR WHEEL OR DAMAGE THE ENGINE.
- IN EITHER CASE THE OPERATOR IS LIKELY TO LOSE CONTROL OF THE MOTORCYCLE.

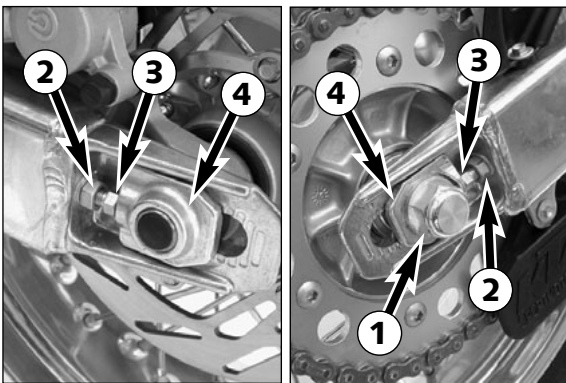

Correct chain tension

Loosen collar nut **1**, loosen counter nuts **2**, and turn right and left adjusting screws **3** equally far. Tighten counter nuts **2**.

Before tightening the wheel spindle, verify that the chain adjusters **4** are sitting close to the adjusting screws and that the rear wheel has been aligned with the front wheel.

Tighten collar nut **1** with 80 Nm (60 ft.lb).

⚠ WARNING ⚠

IF YOU DON'T HAPPEN TO HAVE A TORQUE WRENCH AT HAND, MAKE SURE YOU HAVE THE TIGHTENING TORQUE CORRECTED BY A KTM DEALER AS SOON AS POSSIBLE. A LOOSE AXLE MAY LEAD TO AN UNSTABLE DRIVING BEHAVIOR OF YOUR MOTORCYCLE.

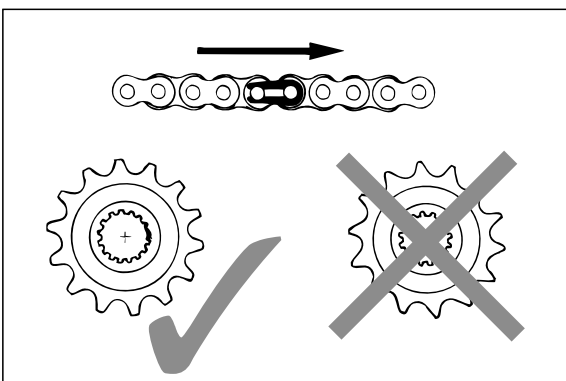

Chain maintenance

For long chain life, good maintenance is very important. X-ring chains require only modest maintenance. The best way is to use lots of water, but never use brushes or solvents. After letting the chain dry, you can use a special X-ring chain spray (Shell Advance Bio Chain).

⚠ WARNING ⚠

NO LUBRICATION IS ALLOWED TO REACH THE REAR TIRE OR THE BRAKE DISK, OTHERWISE THE ROAD ADHERENCE AND THE REAR WHEEL BRAKING EFFECTS WOULD BE STRONGLY REDUCED AND THE MOTORCYCLE COULD EASILY GET OUT OF CONTROL.

! CAUTION !

WHEN MOUNTING THE CHAIN JOINT, THE CLOSED SIDE OF THE SAFETY DEVICE MUST POINT IN RUNNING DIRECTION.

Also check sprockets and chain guides for wear, and replace if necessary.

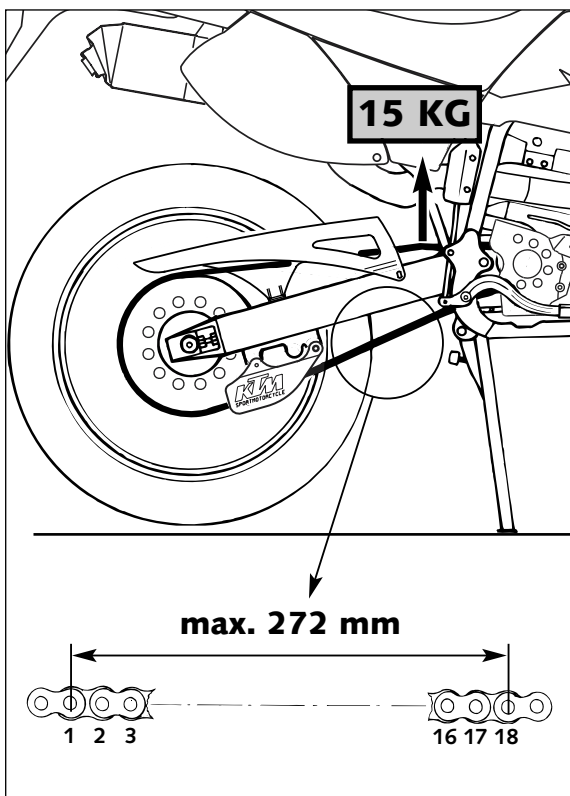

Chain wear

In order to check the chain wear, regard the following instructions: Shift the gear into idling and pull the upper chain strand with approx. 10-15 kilogramm (33 lb) upwards (see figure). Now one can measure a space of 18 chain reels at the lower chain strand. The chain should be replaced at the latest when a space of 272 mm (10,70 in) is measured. Chains do not always wear off evenly, therefore repeat the measurement at different places on the chain.

NOTE: If you mount a new chain, the sprockets should also be replaced. New chains wear faster if used on old used sprockets.

General informations about KTM disc brakes

BRAKE CALIPERS:

The brake calipers of this series "float". This means that the brake calipers are not solidly attached to the caliper support. Thus, the brake pads are always in optimum contact with the brake disc. Secure the screws of the caliper support with Loctite 243 and tighten to 25 Nm (19 ft.lb).

BRAKE PADS:

The motorcycles are delivered with organic brake pads and have also been type-coded with these pads. Said pads are suitable for almost the entire range of application of these motorcycles. It is only for competitive racing in extremely dirty conditions (e.g., water in combination with sand and mud) that we recommend brake pads that have sintered linings. However, take notice of the fact that brake pads with sintered linings have not been type-coded! Besides, they may cause greater wear on the brake discs.

⚠ **WARNING** ⚠

BRAKE SHOES AVAILABLE IN THE ACCESSORY TRADE ARE OFTEN NOT AUTHORIZED FOR OPERATION OF YOUR KTM MOTORCYCLE IN ROAD TRAFFIC. THE BRAKE SHOE'S DESIGN AND FRICTION FACTOR AND THEREFORE THE BRAKING POWER CAN DEVIATE SIGNIFICANTLY FROM ORIGINAL KTM BRAKE SHOES. IF YOU USE DIFFERENT BRAKE SHOES THAN THOSE PROVIDED WITH THE ORIGINAL EQUIPMENT, IT CANNOT BE WARRANTED THAT THEY ARE AUTHORIZED FOR USE IN ROAD TRAFFIC. YOUR MOTORCYCLE WILL NOT LONGER COMPLY WITH THE REGULATIONS AUTHORIZING THE USE OF VEHICLES FOR ROAD TRAFFIC AND THE WARRANTY WILL BE VOID.

BRAKE FLUID RESERVOIRS:

The brake fluid reservoirs on the front and rear wheel brakes have been designed in such a way that even if the brake pads are worn it is not necessary to top up the brake fluid. If the brake fluid level drops below the minimum either the brake system has a leak or the brake pads are completely worn down. In this case, consult an authorized KTM dealer immediately.

BRAKE FLUID:

KTM fills the brake systems with Shell Advance Brake DOT 5.1 brake fluid, one of the best brake fluids that is currently available. We recommend that you continue to use it. DOT 5.1 brake fluid is based on glycol ether and of an amber color. If you do not have any DOT 5.1 for refilling, you may use DOT 4 brake fluid. However, you should replace it as soon as possible by DOT 5.1.

Never use DOT 5 braking fluid. It is based on silicone oil and has a purple color. Gaskets and brake hoses are not compatible with it.

BRAKE DISCS:

Wear reduces the thickness of the brake disc in the area of contact ① with the brake pads. At its thinnest spot ②, the brake disc must not be more than 0.4mm thinner than its nominal dimension ③. The nominal dimension can be gaged in a location beyond the area of contact with the brake pads. Check wear in several spots.

⚠ **WARNING** ⚠

- BRAKE DISCS SUFFERING FROM WEAR GREATER THAN 0.4 MM CONSTITUTE A SAFETY HAZARD. HAVE THE BRAKE DISC REPLACED IMMEDIATELY AS SOON AS IT REACHES ITS WEAR LIMIT.
- AS A MATTER OF PRINCIPLE, HAVE ANY REPAIR OF THE BRAKE SYSTEM CARRIED OUT BY A LICENSED KTM MECHANIC.

Adjusting of free travel at the hand brake lever

Free travel at the hand brake lever may be readjusted by using adjusting screw ②. In this way, the position of the point of pressure (i.e., the resistance you feel on the hand brake lever when the brake pads are pressed against the brake disc) can be adjusted for any hand size.

! **CAUTION** !

AT THE HAND BRAKE LEVER, FREE TRAVEL MUST AT LEAST BE 3 MM. ONLY THEN MAY THE PISTON IN THE HAND BRAKE CYLINDER BE MOVED (TO BE RECOGNIZED BY THE GREATER RESISTANCE OF THE HAND BRAKE LEVER). IF THIS FREE TRAVEL IS NOT PROVIDED, PRESSURE WILL BUILD UP IN THE BRAKING SYSTEM, AND THE FRONT WHEEL BRAKE MAY FAIL DUE TO OVERHEATING.

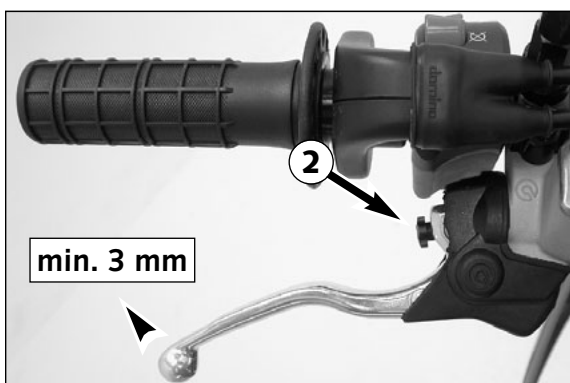
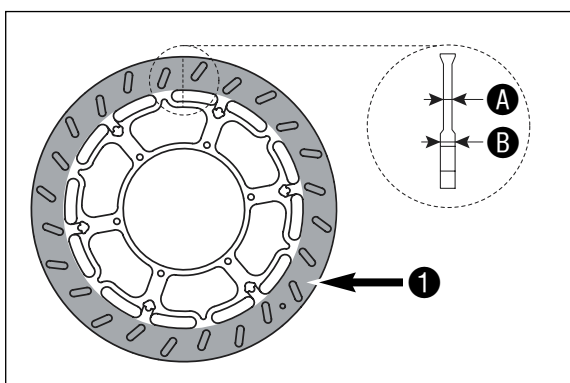
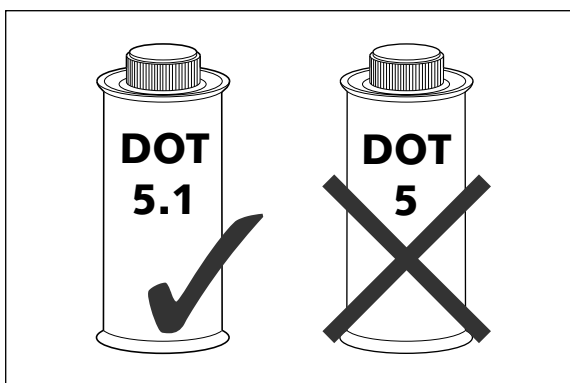

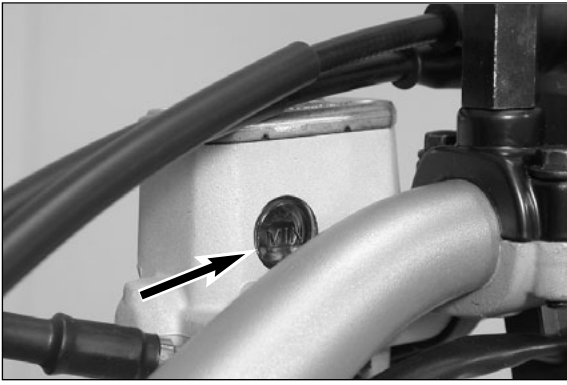

Checking of brake fluid level - front brake

The brake fluid reservoir is linked with the hand brake cylinder at the handlebar and the reservoir is provided with an inspection glass. With the reservoir in a horizontal position, the brake fluid level should not go below middle of the glass.

⚠ **WARNING** ⚠

IF THE BRAKE FLUID LEVEL DROPS BELOW THE MINIMUM EITHER THE BRAKE SYSTEM HAS A LEAK OR THE BRAKE PADS ARE COMPLETELY WORN DOWN. IN THIS CASE, CONSULT AN AUTHORIZED KTM DEALER IMMEDIATELY.

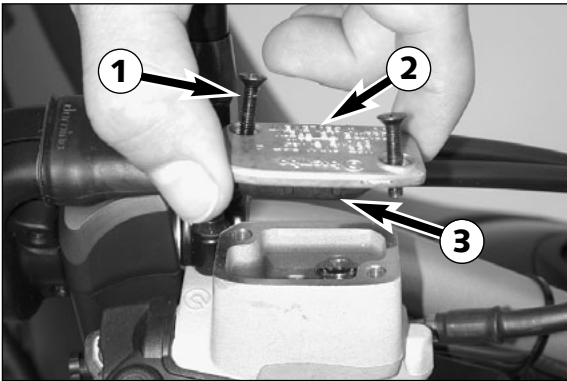

Refilling the front brake fluid reservoir*

Loosen screws ① and remove lid ② and membrane ③.

If necessary, dismount the mirror and loosen the throttle grip.

Place hand brake cylinder in a horizontal position and fill the brake fluid reservoir to 5 mm (0,2 in) below the rim with brake fluid DOT 5.1 (Shell Advance Brake DOT 5.1). Replace membrane and lid, tighten screws. Rinse off spilled or overflowing brake fluid with water.

⚠ **WARNING** ⚠

- NEVER USE DOT5 BRAKE FLUID! IT IS BASED ON SILICONE OIL AND OF A PURPLE COLOR. SEALS AND BRAKE HOSES MUST BE ESPECIALLY ADAPTED TO IT.
- STORE BRAKE FLUID OUT OF REACH OF CHILDREN.
- BRAKE FLUID CAN CAUSE SKIN IRRITATION. AVOID CONTACT WITH SKIN AND EYES. IF YOU GET BRAKE FLUID IN YOUR EYES, RINSE WITH PLENTY OF WATER AND CONSULT A DOCTOR.
- THE BRAKE FLUID RESERVOIRS ON THE FRONT AND REAR WHEEL BRAKES HAVE BEEN DESIGNED IN SUCH A WAY THAT EVEN IF THE BRAKE PADS ARE WORN IT IS NOT NECESSARY TO TOP UP THE BRAKE FLUID. IF THE BRAKE FLUID LEVEL DROPS BELOW THE MINIMUM EITHER THE BRAKE SYSTEM HAS A LEAK OR THE BRAKE PADS ARE COMPLETELY WORN DOWN.
IN THIS CASE, CONSULT AN AUTHORIZED KTM DEALER IMMEDIATELY.

! **CAUTION** !

- DON'T LET BRAKE FLUID GET IN CONTACT WITH PAINT, IT IS AN EFFECTIVE PAINT REMOVER.
- USE ONLY CLEAN BRAKE FLUID TAKEN FROM A TIGHTLY SEALED CONTAINER.

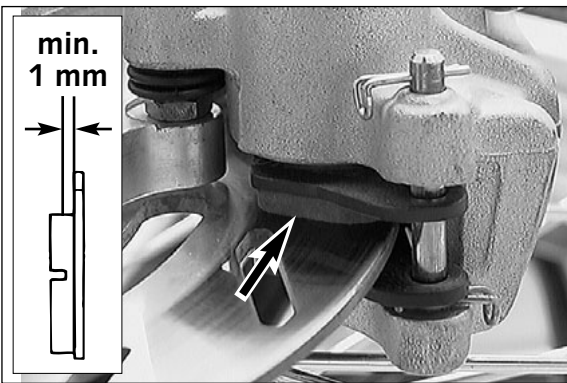
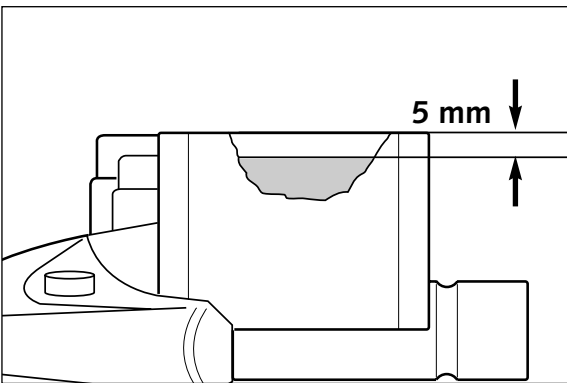

Checking the front brake pads

The brake pads can be inspected from below. The linings must be at least 1 mm (0,04 in) thick.

⚠ **WARNING** ⚠

AT THEIR MOST WORN POINT BRAKE PAD LININGS SHOULD NOT BE THINNER THAN 1 MM, OTHERWISE THEY COULD LEAD TO BRAKE FAILURE. FOR YOUR OWN SAFETY DON'T PUT OFF HAVING YOUR BRAKE PADS CHANGED.

! **CAUTION** !

IF THE BRAKE PADS ARE REPLACED TOO LATE SO THAT THE LINING IS PARTLY OR ENTIRELY WORN AWAY, THE STEEL COMPONENTS OF THE BRAKE PAD WILL RUB AGAINST THE BRAKE DISC, IMPAIRING THE BRAKING EFFECT AND DESTROYING THE BRAKE DISC.

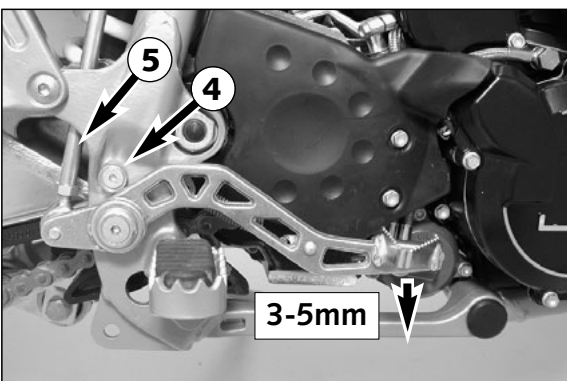

Changing the basic position of the foot brake pedal*

The basic position of the foot brake pedal can be altered by turning the stop roller ④. The free play at the foot brake pedal must then be adjusted by means of the piston rod ⑤.

Measured on the outside, the foot brake pedal must have 3-5 mm (0,12-0,20 in) of free play, before the piston rod can move the piston in the brake cylinder (to be recognised from the resistance on the foot brake pedal).

! **CAUTION** !

IF THIS FREE PLAY IS NOT PRESENT, THEN PRESSURE CAN BUILD UP IN THE BRAKE SYSTEM WHEN DRIVING, CAUSING CONSTANT FRICTION OF THE BRAKE PADS. THE BRAKING SYSTEM OVERHEATS AND CAN FAIL COMPLETELY IN EXTREME CASES.

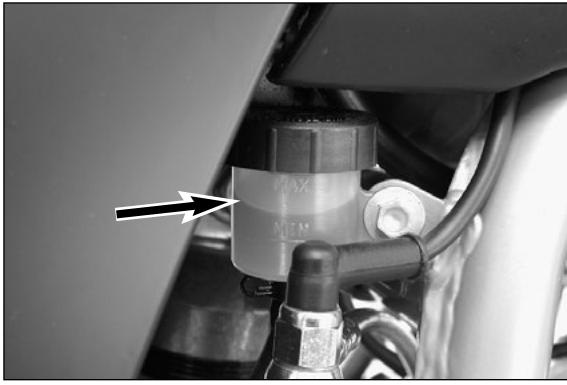

Checking rear brake fluid level

The reservoir for the rear disc brake is located on the left-hand side of the vehicle next to the carburetor carburetor connection boot. The brake fluid level may not drop below the „MIN“ marking when the vehicle is in an upright position.



WARNING



IF THE BRAKE FLUID LEVEL DROPS BELOW THE MINIMUM EITHER THE BRAKE SYSTEM HAS A LEAK OR THE BRAKE PADS ARE COMPLETELY WORN DOWN. IN THIS CASE, CONSULT AN AUTHORIZED KTM DEALER IMMEDIATELY.



Refilling the rear brake fluid reservoir*

When the brake fluid level has dropped to the MIN mark, you need to refill the brake fluid reservoir.

For easier access to the brake fluid reservoir it is recommended to remove the hexagon screw ①. Then move the container outwards as indicated in the illustration. Remove plug ② with rubber boot ③ and add brake fluid DOT 5.1 (Shell Advance Brake DOT 5.1) up to the „MAX“ mark. Replace rubber boot and plug. Overflowed or spilled brake liquid must be rinsed off with water. Mount the screw and fix the brake fluid reservoir to the frame, always making sure to prevent kinks in the connecting hose.



WARNING



- NEVER USE DOT5 BRAKE FLUID! IT IS BASED ON SILICONE OIL AND OF A PURPLE COLOR. SEALS AND BRAKE HOSES MUST BE ESPECIALLY ADAPTED TO IT.
- STORE BRAKE FLUID OUT OF REACH OF CHILDREN.
- BRAKE FLUID CAN CAUSE SKIN IRRITATION. AVOID CONTACT WITH SKIN AND EYES. IF YOU GET BRAKE FLUID IN YOUR EYES, RINSE WITH PLENTY OF WATER AND CONSULT A DOCTOR
- THE BRAKE FLUID RESERVOIRS ON THE FRONT AND REAR WHEEL BRAKES HAVE BEEN DESIGNED IN SUCH A WAY THAT EVEN IF THE BRAKE PADS ARE WORN IT IS NOT NECESSARY TO TOP UP THE BRAKE FLUID. IF THE BRAKE FLUID LEVEL DROPS BELOW THE MINIMUM EITHER THE BRAKE SYSTEM HAS A LEAK OR THE BRAKE PADS ARE COMPLETELY WORN DOWN.
IN THIS CASE, CONSULT AN AUTHORIZED KTM DEALER IMMEDIATELY.



CAUTION



- DON'T LET BRAKE FLUID GET IN CONTACT WITH PAINT, IT IS AN EFFECTIVE PAINT REMOVER.
- USE ONLY CLEAN BRAKE FLUID TAKEN FROM A TIGHTLY SEALED CONTAINER.

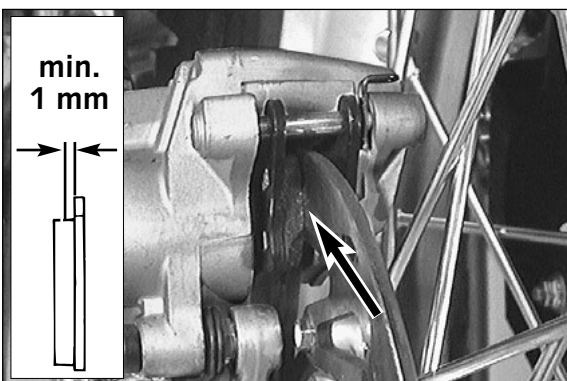
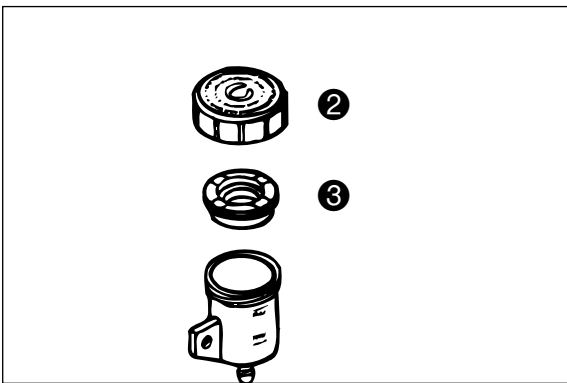

Checking the rear brake pads

The brake pads can be inspected from the rear. The thickness of the linings may not be less than 1 mm (0.04 in).



WARNING



AT THEIR MOST WORN POINT BRAKE PAD LININGS SHOULD NOT BE THINNER THAN 1 MM, OTHERWISE THEY COULD LEAD TO BRAKE FAILURE. FOR YOUR OWN SAFETY DON'T PUT OFF HAVING YOUR BRAKE PADS CHANGED.



CAUTION



IF THE BRAKE PADS ARE REPLACED TOO LATE SO THAT THE LINING IS PARTLY OR ENTIRELY WORN AWAY, THE STEEL COMPONENTS OF THE BRAKE PAD WILL RUB AGAINST THE BRAKE DISC, IMPAIRING THE BRAKING EFFECT AND DESTROYING THE BRAKE DISC.

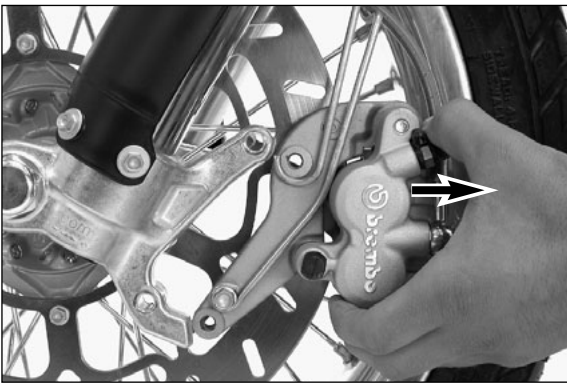
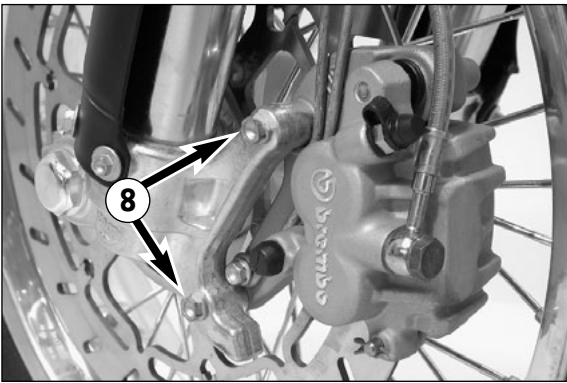
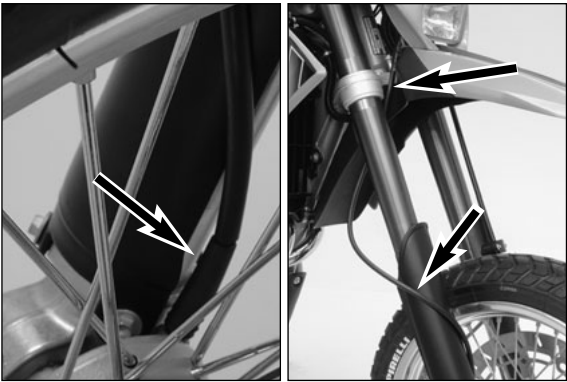
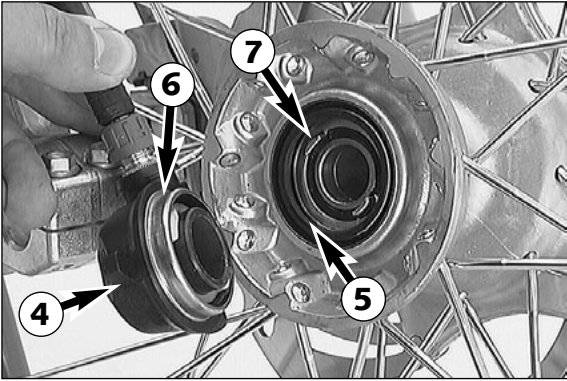
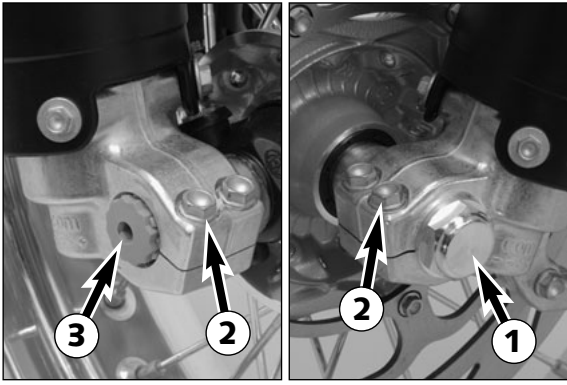

Dismounting and mounting the front wheel (LC4)

To remove the front wheel, jack the motorcycle up on its frame so that the front wheel no longer touches the ground.

Loosen both clamp screws ② on the left fork leg. Then loosen the collar nuts ① before loosening the clamp screws ② on the right fork leg.

Hold the front wheel and withdraw the wheel spindle ③.

Note: The wheel spindle can be withdrawn more easily by turning it moderately with a 6 mm ALLAN/IMBUS key while pulling.

Remove front wheel carefully from the fork and take the speedometer drive ④ off the hub.

-
- ! CAUTION !**
-
- DO NOT OPERATE THE HAND BRAKE WHEN THE FRONT WHEEL HAS BEEN DISMOUNTED.
 - ALWAYS PLACE THE WHEEL ON THE GROUND WITH THE BRAKE DISC POINTING UPWARDS. OTHERWISE THE BRAKE DISC MAY BE DAMAGED.

Prior to mounting the front wheel, clean and grease sealing ring ⑤ and running surface ⑥ at the speedometer drive.

To mount the front wheel, lift it into the fork. Insert speedometer drive into the hub. Make sure that the driving tabs ⑦ engage with the slots of the drive.

Position front wheel and speedometer drive, and mount wheel spindle.

The speedometer shaft must be placed as running along the outside of the fork guard and pass the triple clamp in front between fender and fork leg. Screw on the collar nuts ① without tightening them. Make sure that the speedometer drive runs upwards and parallel to the fork leg (see below). Tighten the clamp screws ② on the right fork leg so as to prevent the wheel spindle from twisting, and then tighten the collar nuts with 40 Nm.

Loosen the clamp screws on the right fork leg. Take the motorcycle down from its stand. Press the front wheel brakes and push down on the fork a few times vigorously so that the fork legs come into alignment.

Only after this has been accomplished, tighten the clamp screws on both fork legs with 10 Nm (7 ft. lbs).

-
- ⚠ WARNING ⚠**
-
- IF YOU DON'T HAPPEN TO HAVE A TORQUE WRENCH AT HAND, MAKE SURE YOU HAVE THE TIGHTENING TORQUE CORRECTED BY A KTM DEALER AS SOON AS POSSIBLE. A LOOSE AXLE MAY LEAD TO AN UNSTABLE DRIVING BEHAVIOR OF YOUR MOTORCYCLE.
 - AFTER MOUNTING THE FRONT WHEEL, KEEP OPERATING THE HAND BRAKE UNTIL THE PRESSURE POINT RETURNS.
 - IT IS VERY IMPORTANT TO KEEP THE BRAKE DISC FREE FROM OIL AND FATTY MATTERS, OTHERWISE THE BRAKING EFFECTS WOULD BE STRONGLY REDUCED.

Dismounting and mounting the front wheel (LC4 Supermoto)

The front wheel of the Supermoto is essentially removed in the same manner as the front wheel of the LC4-E. However, the brake caliper has first to be removed. To remove the front brake caliper, remove both screws ⑧ and pull the caliper backwards from the brake disc.

After mounting the front wheel, slide the brake caliper to the brake disc. Remove the grease from the threads of both screws ⑧ and apply Loctite 243. Tighten the screws with 25 Nm (19 ft. lbs).

-
- ⚠ WARNING ⚠**
-
- THE SCREWS ⑧ MUST BE SECURED WITH LOCTITE 243.

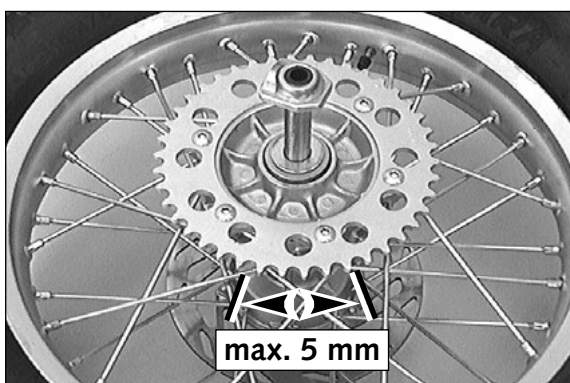
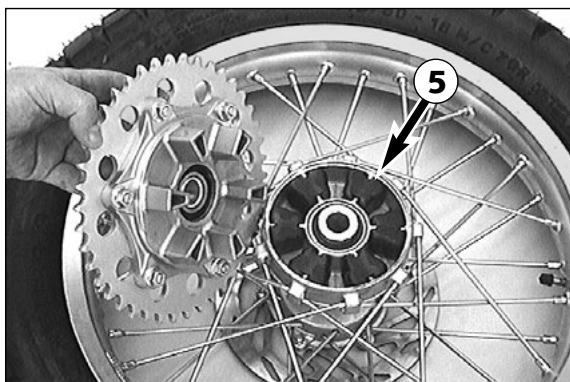
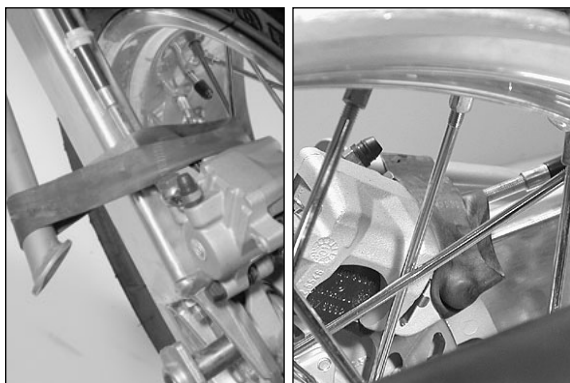
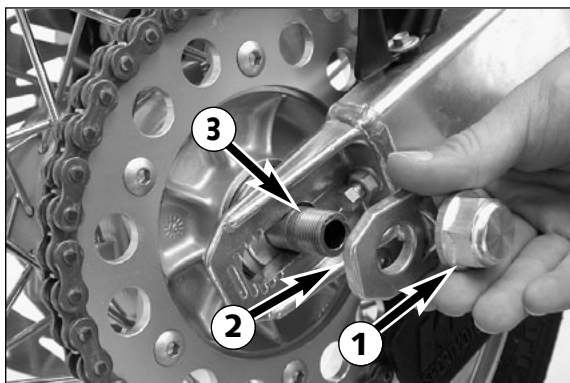

Dismounting and mounting the rear wheel (LC4)

Park the motorcycle on the center stand. The rear wheel must not touch the ground.

Loosen the collar nut ①, remove chain tensioner ②, hold the rear wheel and pull out the wheel spindle ③ until the rear wheel is free but the brake caliper support is still held. Push the rear wheel as far forward as possible, take the chain from the rear sprocket and carefully take the rear wheel out of the swingarm.

! CAUTION !

- DO NOT OPERATE THE REAR BRAKE WHEN THE REAR WHEEL HAS BEEN DISMOUNTED.
- ALWAYS PLACE THE WHEEL ON THE GROUND WITH THE BRAKE DISC POINTING UPWARDS. OTHERWISE THE BRAKE DISC MAY BE DAMAGED.
- IF THE AXLE IS DISMOUNTED, CLEAN THE THREAD OF THE WHEEL SPINDLE AND COLLAR NUT THOROUGHLY AND APPLY A NEW COAT OF GREASE (SHELL ADVANCE GREASE) TO PREVENT THE THREAD FROM JAMMING.

NOTE: If the rear wheel has been dismounted, you should also check the shock absorption rubber.

The rear wheel is remounted in reverse order. Before tightening the collar nut to 80 Nm (60 ft.lb), push the rear wheel forwards so that the chain tensioners lie on the tension screws.

Dismounting and mounting the rear wheel (LC4 SUPERMOTO)*

To remove the front wheel, jack the motorcycle up on its frame so that the front wheel no longer touches the ground.

Remove rear screw ④ from the chain guard.

To avoid damage to the rim and to fix the brake caliper, stretch a rubber band or an old hose between the brake caliper and the side stand (see illustration).

Remove collar nut ①, remove chain tensioner ②, hold on to the rear wheel while you pull out wheel spindle ③.

Push the rear wheel as far forward as possible and remove the chain from the sprocket. Carefully push the rear wheel back, lift slightly and swivel to the left. Carefully lift the wheel diagonally towards the rear and remove from the swing arm. Do not use force to remove the rear wheel to avoid damaging the rim.

NOTE: If the rear wheel has been dismounted, you should also check the shock absorption rubber.

The rear wheel is remounted in reverse order. Before tightening the collar nut to 80 Nm (60 ft.lb), push the rear wheel forwards so that the chain tensioners lie on the tension screws.

⚠ WARNING ⚠

- IF YOU DON'T HAPPEN TO HAVE A TORQUE WRENCH AT HAND, MAKE SURE YOU HAVE THE TIGHTENING TORQUE CORRECTED BY A KTM DEALER AS SOON AS POSSIBLE. A LOOSE WHEEL SPINDLE MAY LEAD TO AN UNSTABLE DRIVING BEHAVIOR OF YOUR MOTORCYCLE.
- AFTER MOUNTING THE REAR WHEEL, KEEP OPERATING THE FOOTBRAKE UNTIL THE PRESSURE POINT RETURNS.
- IT IS VERY IMPORTANT TO KEEP THE BRAKE DISC FREE FROM OIL AND GREASE, OTHERWISE THE BRAKING EFFECT WOULD BE STRONGLY REDUCED.

Checking the shock absorption rubbers in the rear hub *

LC4 models have a damped rear wheel hub. For this purpose, the engine power is conveyed from the rear sprocket via 6 shock absorption rubbers ⑤ to the rear wheel. These 6 absorption rubbers wear with increasing operation time, and should be checked for wear whenever the rear wheel is dismounted.

For this purpose, lie the rear wheel on a work bench with the rear sprocket upwards, and put the wheel spindle in the hub. Now hold the rear wheel firmly and try to turn the rear sprocket. The rear sprocket may not turn more than maximum 5 mm (0,2 in) measured on the outside. If the play in the chain wheel is larger, all 6 shock absorption rubbers are to be replaced. Check the shock absorption rubbers for signs of damage and dirt.

! CAUTION !

IF THE SHOCK ABSORPTION RUBBERS ARE NOT REPLACED IN GOOD TIME, THE REAR SPROCKET CARRIER AND THE REAR HUB WILL BE DAMAGED. ALWAYS REPLACE ALL 6 ABSORPTION RUBBERS, NEVER SINGLE RUBBERS.



Tires, air pressure

Tire type, tire condition, and how much air pressure the tires have in them affect the way your motorcycle rides, and they must therefore be checked whenever you're getting ready to go anywhere on your motorcycle.

⚠ **WARNING** ⚠

IN ORDER TO ENSURE RIDING SAFETY AND OPTIMAL RIDING PERFORMANCE, ONLY KTM-APPROVED TIRES MAY BE USED. OTHER TIRES CAN HAVE A NEGATIVE EFFECT ON RIDING PERFORMANCE (E.G. VIBRATION AT HIGHER SPEEDS).

Approved tires for 640 LC4 (as of September 2001)
 METZELERENDURO 3, ENDURO 4, KAROO
 MICHELINSIRAC, T63
 PIRELLIMT21, MT60, MT70, MT90

- Tire type and size can be found in the technical specifications and in the homologation certificate
- Tire condition has to be checked every time you want to ride your motorcycle. Before leaving check for punctures and nails or other sharp objects that might have become embedded in the tire.
- Refer to the specific regulations in your country for minimum tire tread requirements. We recommend replacing tires at the latest when the tread is down to 2 mm.
- Tire pressure should be checked regularly on a "cold" tire. Proper pressure ensures optimum driving comfort and extends the life of your tires.

⚠ **WARNING** ⚠

- DO NOT MOUNT TIRES WHICH HAVE NOT BEEN APPROVED BY KTM. OTHER TIRES COULD HAVE ADVERSE EFFECTS ON THE WAY YOUR MOTORCYCLE RIDES.
- USE TIRES OF THE SAME BRAND AND TYPE FOR THE FRONT AND REAR WHEELS.
- FOR YOUR OWN SAFETY REPLACE DAMAGED TIRES IMMEDIATELY.
- WORN TIRES CAN HAVE A NEGATIVE EFFECT ON HOW YOUR MOTORCYCLE PERFORMS, ESPECIALLY ON WET SURFACES
- IF AIR PRESSURE IS TOO LOW, ABNORMAL WEAR AND OVERHEATING OF THE TIRE CAN RESULT

TIRES - AIR PRESSURE		
640 LC4	front	rear
Road, driver only	1,8 bar (26psi)	2,0 bar (29psi)
Road, with passenger	2,0 bar (29 psi)	2,2 bar (31psi)
640 LC4 Supermoto	front	rear
Road, driver only	2,0 bar (29psi)	2,2 bar (31psi)
Road, with passenger	2,2 bar (31psi)	2,4 bar (34psi)

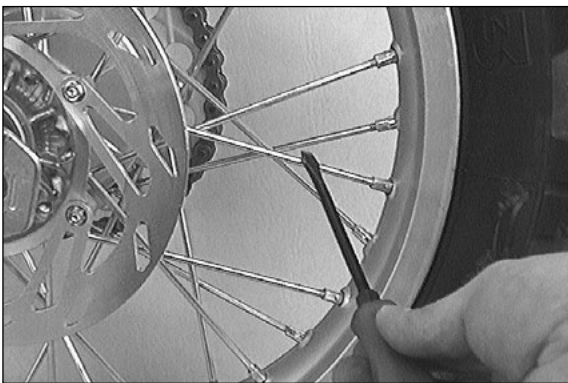

Checking spoke tension

The correct spoke tension is very important for the stability of the wheels and thus for riding safety. A loose spoke causes the wheel to become unbalanced and before long other spokes will have come loose. Check spoke tension, especially on a new motorcycle, in regular intervals. For checking, tap on each spoke with the blade of a screw driver (see illustration). A clear tone must be the result. Dull tones indicate loose spokes. If necessary, have the spokes retightened and the wheel centered by a KTM dealer.

⚠ **WARNING** ⚠

- SPOKES CAN TEAR IF YOU CONTINUE TO RIDE WITH THEM LOOSE. THIS MAY LEAD TO AN UNSTABLE HANDLING OF YOUR MOTORCYCLE.
- EXCESSIVELY TENSIONED SPOKES MAY RUPTURE DUE TO LOCAL OVERLOADING. THE SPOKES MUST BE TENSIONED TO 4 NM.

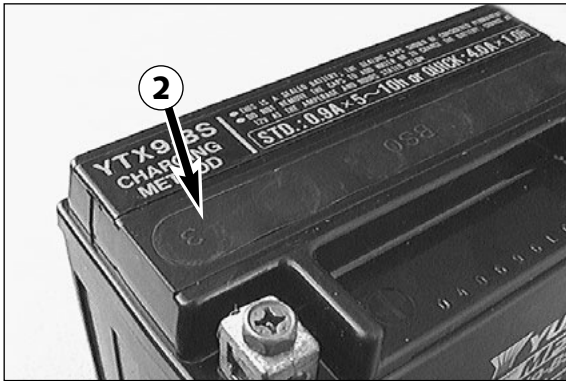
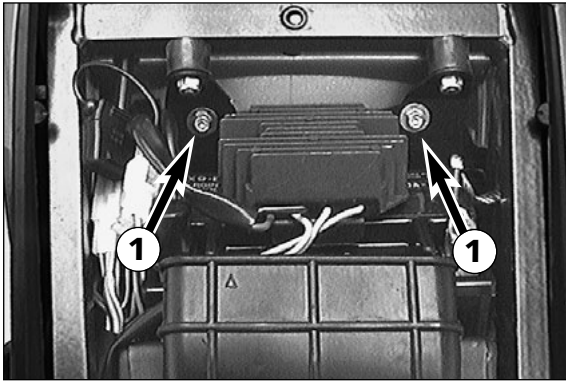

Battery

The battery is mounted under the seat (remove the seat, see page 16). The battery has a closed system and therefore requires no maintenance. It is not necessary to check the electrolyte level or to refill water. Simply keep the battery poles clean and slightly grease them with an acid-free grease if necessary.

Removing the battery:

First disconnect the negative and then the positive pole of the battery.

Remove screws 1 and swing retaining bracket and voltage regulator out of the way.

Remove battery.

When replacing, connect first the positive and then the negative pole.



WARNING



- IF ELECTROLYTE (SULPHURIC ACID) LEAKS FROM THE BATTERY, PROCEED WITH GREAT CARE. THE ELECTROLYTE CAN CAUSE SEVERE BURNS.
- IN THE CASE OF SKIN CONTACT RINSE THOROUGHLY WITH WATER.
- IN THE CASE OF CONTACT WITH THE EYES, THOROUGHLY RINSE EYES WITH WATER FOR AT LEAST 15 MINUTES. IMMEDIATELY CONSULT A DOCTOR!
- THE BATTERY IS A CLOSED MODEL BUT CAN NEVERTHELESS EMIT EXPLOSIVE GASES. AVOID SPARKS AND OPEN FIRE NEAR THE BATTERY.
- DEFECT BATTERIES MUST BE STORED OUT OF THE REACH OF CHILDREN. ENSURE PROPER DISPOSAL OF DISCARDED BATTERIES.



CAUTION



- TO AVOID DAMAGE, DO NOT REMOVE THE LOCKING BAR 2 !
- NEVER DISCONNECT THE BATTERY WHILE THE ENGINE IS RUNNING. THIS WILL DESTROY THE RECTIFIER-REGULATOR.

BATTERY STORAGE:

When preparing the motorcycle for a longer period of standstill, remove the battery and recharge it. Storage temperature: 0 - 35°C (30 - 95°F). Do not expose to direct sun radiation.

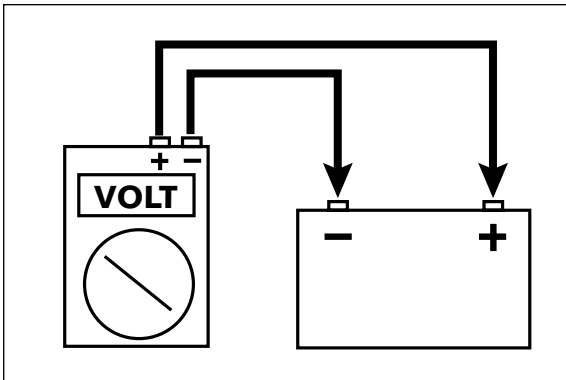

Charging the battery

Remove the battery and check the charging level. Use a voltmeter to measure the voltage between the battery poles (off-load voltage).

off load voltage Volt	charging level %	charging time 0,8 A	charging voltage
>12,7	100	—	max. 14,4 V
~12,5	75	4 h	
~12,2	50	7 h	
~12,0	25	11 h	
~11,8	0	14 h	

Accurate results can only be obtained if the battery has neither been charged nor discharged during a period of 30 minutes preceding the measuring.

If the battery is empty, it can be recharged for a maximum period of 10 hours at 0.8 A and a maximum of 14.4 V.



CAUTION



- TO AVOID DAMAGE, DO NOT REMOVE THE LOCKING BAR
- ALWAYS CONNECT THE BATTERY TO THE CHARGING UNIT BEFORE TURNING THE CHARGING UNIT ON.
- WHEN RECHARGING THE BATTERY IN CLOSED ROOMS ENSURE SUFFICIENT VENTILATION. EXPLOSIVE GASES ARE RELEASED DURING THE BATTERY CHARGING PROCESS.
- CHARGING TIME AND CHARGING VOLTAGE SHOULD NOT EXCEED THE STATED VALUES. OTHERWISE ELECTROLYTE WILL BE RELEASED THROUGH THE SAFETY VALVES.
- AVOID QUICK CHARGING IF POSSIBLE.



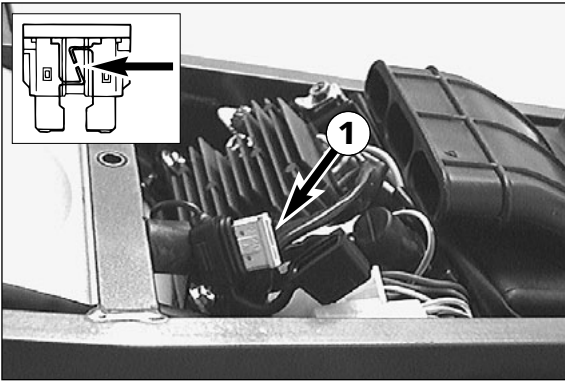

Main fuse

Located near the battery under the seat, the main fuse ① protects all power consumers.

Replace a blown fuse only with an equivalent one. If a new fuse that has just been set in gets blown again, you are strongly advised to have it inspected by a KTM dealer.

The fuse capacity is 20 Ampere.

! CAUTION !

UNDER NO CIRCUMSTANCES IS A STRONGER FUSE ALLOWED TO BE SET IN OR A FUSE ALLOWED TO BE "REPAIRED". AN INEXPERT TREATMENT COULD DAMAGE THE WHOLE ELECTRICAL INSTALLATION!

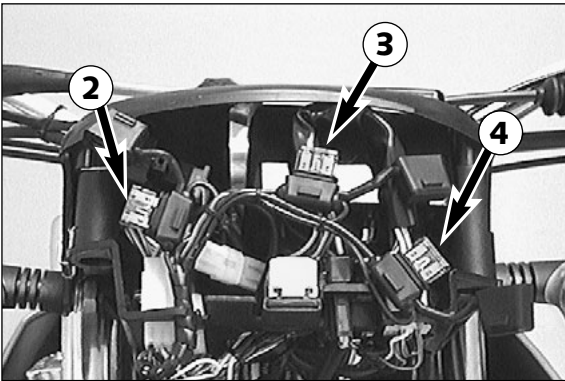

Fuses for individual power-consuming units

Additional fuses separately protecting different power-consuming units are mounted under the headlight mask.

For instructions to remove and mount the headlight mask please refer to "Exchanging the headlight lamp".

Fuse ② (10 Ampere) protects the following power-consuming units:

- headlight
- parking light

Fuse ③ (10 Ampere) protects the following power-consuming units:

- flasher lights
- brake light
- horn
- radiator fan motor

Fuse ④ (10 Ampere) protects the following power-consuming units:

- ignition
- starter system

Replace a blown fuse only with an equivalent one. If a new fuse that has just been set in gets blown again, you are strongly advised to have it inspected by a KTM dealer.

! CAUTION !

UNDER NO CIRCUMSTANCES IS A STRONGER FUSE ALLOWED TO BE SET IN OR A FUSE ALLOWED TO BE "REPAIRED". AN INEXPERT TREATMENT COULD DAMAGE THE WHOLE ELECTRICAL INSTALLATION!

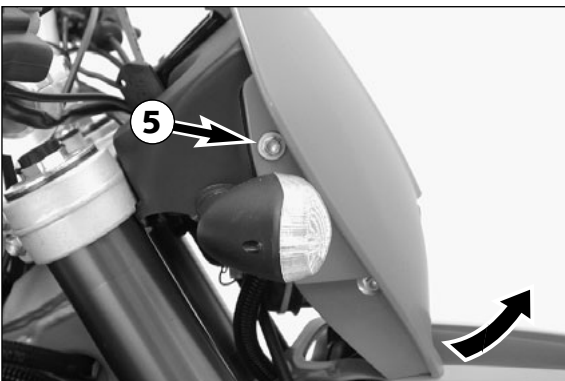

Exchanging the headlight lamp

Remove the headlight mask:

Remove screws ⑤ on the left and on the right side.

Depress the front section of the fender, pull the headlight mask upwards, unhook it from the lower part of the fender, then swing it forwards.

Exchanging the headlight lamp:

Disconnect plug ⑥ from the bulb.

Remove the rubber cap ⑦

Unhook the retaining bracket, then remove the bulb.

When inserting the new bulb make sure that the wider of the 3 tongues ⑧ is located in the corresponding groove in the socket.

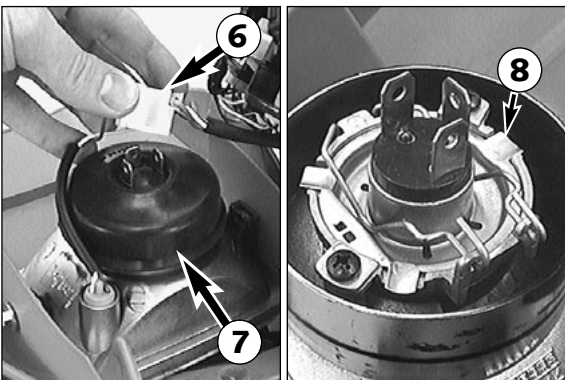

! CAUTION !

NEVER TOUCH THE GLASS OF THE BULB WITH YOUR FINGERS. THE GLASS OF THE BULB MUST REMAIN ABSOLUTELY FREE FROM GREASE. HEAT WILL OTHERWISE CAUSE THE GREASE TO EVAPORATE AND SETTLE DOWN ON THE REFLECTOR.

Hook in the retaining bracket, mount the rubber cap and connect the plug to the bulb.

Mounting the headlight mask:

Appropriately position the headlight mask. The headlight must be located below the cockpit.

Depress the front part of the fender, pull the headlight mask upwards and insert the retaining pins ⑨ into the corresponding bores of the fender.

Mount the screws ⑤.

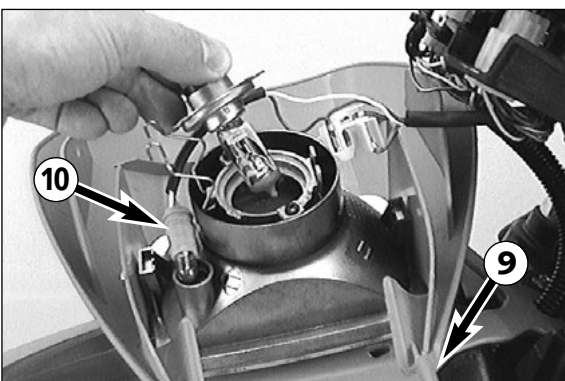

Replacing the parking-light bulb

Disassemble the headlight as described above and simply pull the bulb socket ⑩ out of the reflector.

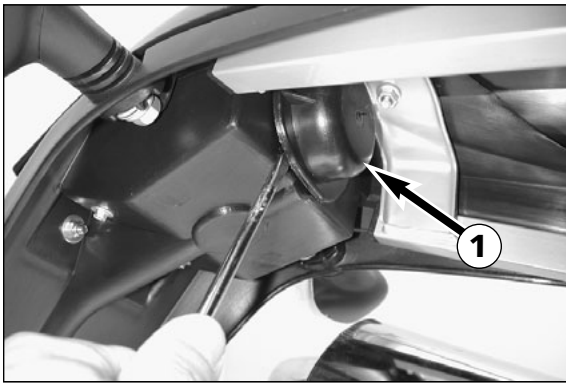

Exchanging the brake light and tail light bulb

Remove the cap ❶ on the underside of the license plate retainer.



Turn the lamp socket ❷ approximately 30° counterclockwise and pull it out of the tail light housing.

Slightly depress the bulb, turn it approx. 30° counterclockwise and pull it out of the socket.

To mount the lamp reverse the worksteps indicated above.



Cooling system

Coolant is circulated by a water pump located in the engine. When the engine is cold the cooling liquid circulates only through the cylinder and the cylinder head. After the engine has reached its operating temperature (about 70°C, 158°F), the thermostat opens and the cooling liquid is also pumped through both aluminum radiators.

Air blowing in through the radiators cools the cooling liquid. The slower the speed of the motorcycle, the less the cooling liquid is cooled down. Dirty radiator fins also reduce the cooling efficiency.

If little or no air blows through the radiators, for example when riding through slow traffic or waiting at traffic lights, the coolant temperature will rise. If the coolant temperature rises to 85° C (185°F), the fan ❸ on the left radiator will switch on. This fan will provide additional air circulation through the radiator thereby preventing the cooling system from overheating.



! CAUTION !

THE RED COOLING LIQUID TEMPERATURE WARNING LIGHT ❹ WILL BEGIN TO LIGHT UP, IF THE COOLING LIQUID TEMPERATURE REACHES APPROX. 105°C (223°F) AND HENCEFORTH HAS EXCEEDED ITS NORMAL OPERATING TEMPERATURE.

POSSIBLE CAUSES:

- SLOW RIDING WITH LARGE LOADS AT A HIGHER AIR TEMPERATURE:
IF POSSIBLE INCREASE YOUR RUNNING SPEED, SO THAT MORE AIR CAN BLOW THROUGH THE RADIATORS. SHOULD THE WARNING LIGHT STILL BE ON OFF AFTER 300 METERS, STOP IMMEDIATELY, SWITCH OFF THE ENGINE AND LOOK FOR OTHER POSSIBLE CAUSES.
- TOO LITTLE COOLING LIQUID IN THE SYSTEM:
LET THE ENGINE COOL DOWN, AND CHECK THE SYSTEM FOR LEAKAGE'S. ALSO EXAMINE THE COOLING LIQUID LEVEL CAUTION SCALDING HAZARD! Do NOT DRIVE ON, UNTIL THERE IS SUFFICIENT LIQUID IN THE COOLING SYSTEM. GO TO YOUR NEAREST KTM GARAGE AND GET IT SEEN TO. IF YOU DRIVE WITH THE COOLING LIQUID TEMPERATURE WARNING LIGHT ON, YOU WILL CAUSE EVEN MORE DAMAGES TO THE ENGINE.
- THE COOLING FAN ON THE LEFT COOLER IS NOT WORKING:
THE COOLING FAN MUST BE RUNNING, WHEN THE COOLING LIQUID TEMPERATURE IS 105°C (223°F) AND THE IGNITION IS ON. IF THE FAN IS NOT WORKING, AND THERE APPEARS TO BE SUFFICIENT COOLING LIQUID, THE ONLY THING YOU CAN DO IS TO DRIVE ON TO YOUR NEAREST KTM GARAGE AT THE LEAST POSSIBLE ENGINE LOAD.
- EXCESSIVE USE OF THE CLUTCH AT SLOW SPEED

⚠ WARNING ⚠

IF POSSIBLE, ALWAYS CHECK LEVEL OF COOLING LIQUID WHEN ENGINE IS COLD. IF YOU HAVE TO OPEN THE RADIATOR CAP WHEN ENGINE IS HOT, USE A RAG TO COVER THE CAP AND OPEN SLOWLY TO RELEASE PRESSURE.

A mixture of 40% antifreezer and 60% water is used as cooling liquid. How-ever, the anti-freeze protection must be at least -25° C (-13° F). Aside from antifreezing protection, this mixture also provides great corrosion protection which is why it must not be replaced by pure water.

! CAUTION !

FOR THE COOLING SYSTEM, USE ONLY HIGH-GRADE ANTIFREEZER (SHELL ADVANCE COOLANT). USING LOWERGRADE ANTIFREEZE AGENTS, CAN CAUSE CORROSION AND COOLANT FOAMING.

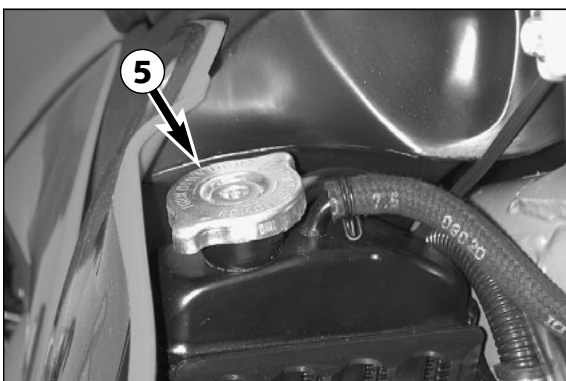

Pressure induced by heating of the cooling liquid in the cooling system is controlled by a valve in the radiator cap ❺; a water temperature rising up to 120° C (248° F) is admissible, without fear of problems.

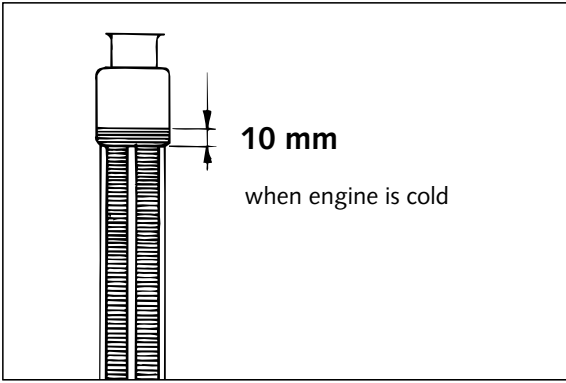

Checking the cooling liquid level

The cooling liquid should be 10 mm (0,4 in) above the cooling elements when the engine is cold (cf. diagram). In the event of the cooling liquid being drained, always fill the system before hand, then top off while the engine is running.



WARNING



IF POSSIBLE, ALWAYS CHECK LEVEL OF COOLING LIQUID WHEN ENGINE IS COLD. IF YOU HAVE TO OPEN THE RADIATOR CAP WHEN ENGINE IS HOT, USE A RAG TO COVER THE CAP AND OPEN SLOWLY TO RELEASE PRESSURE.

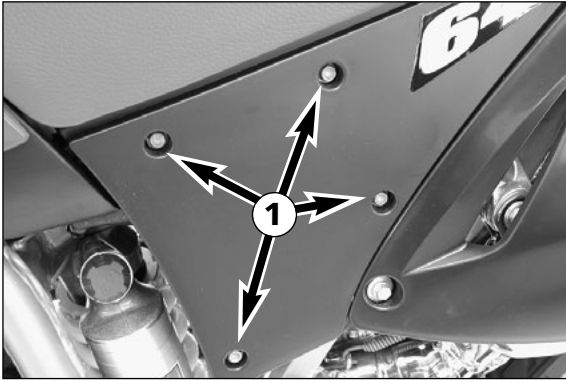

Cleaning the air filter *

It is very important for the engine's life expectancy to clean the air filter regularly.

To clean the air filter, remove screws ① and the filter box cover. Detach retaining clip ② and remove the air filter ③ including the filter holder ④ from the filter box.

Remove the air filter from the filter holder and wash thoroughly in special cleaning fluid. Products required for a professional maintenance of the air filter are available from TWIN AIR. Press out the water from the air filter – but do not wring – and allow the filter to dry. Lubricate the dry air filter thoroughly with high-grade filter oil, rubbing to coat the entire filter surface.

Clean the filter box and cover and check the carburetor connection boot for damage.

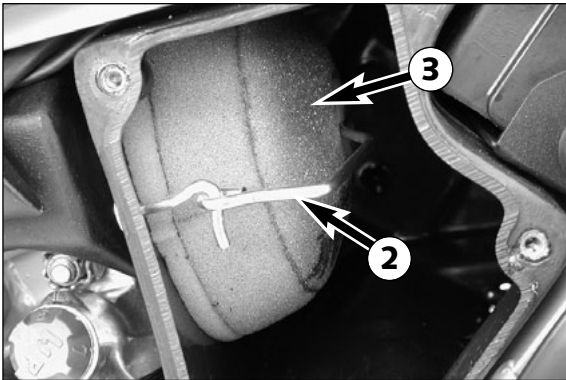

Mount the air filter on the filter holder, position in the filter box (make sure to center) and fix with the retaining clip. Check whether the air filter is positioned correctly and mount the filter box cover.



CAUTION



- DO NOT CLEAN AIR FILTER WITH FUEL OR PETROLEUM SINCE THESE WILL DAMAGE THE FOAM. KTM RECOMMENDS THE PRODUCTS MADE BY TWIN AIR FOR AIR FILTER MAINTENANCE. FOR CLEANING PURPOSES AND TO OIL THE AIR FILTER.
- DUST AND DIRT CAN ACCUMULATE AND DAMAGE THE ENGINE IF THE AIR FILTER IS NOT MOUNTED CORRECTLY.

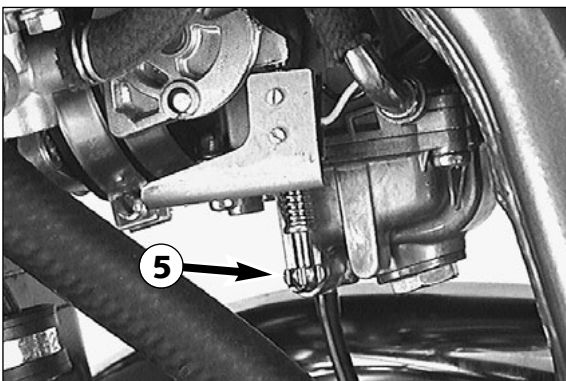
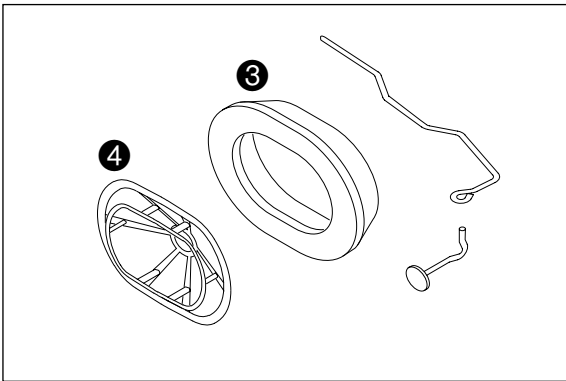

Adjust idling speed *

Use the adjusting screw ⑤ to adjust the basic position of the throttle valve and, thus, the idle speed. Turning in clockwise direction will increase the idling speed, turning in counterclockwise direction will reduce the idling speed. Normal idling speed 1400 - 1500 rpm.

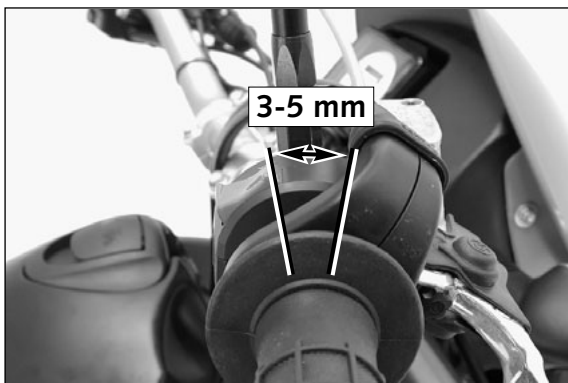

Adjusting the throttle cable *

When starting to turn the throttle grip, you should feel an initial backlash of 3-5 mm.

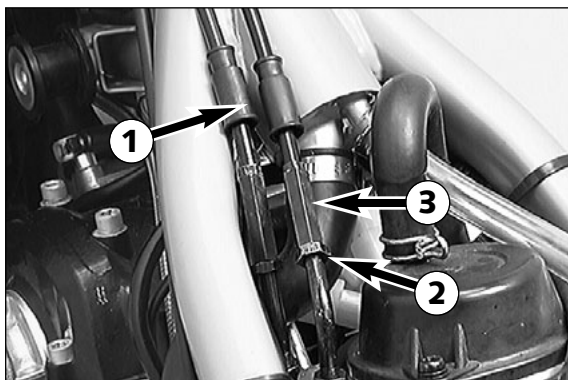

If a correction is necessary, start by removing the tank. Slide back the protection cover ①. To set the backlash, loosen the counter nut ② and turn the adjusting screw ③ accordingly. Then, fasten the counter nut and slide the protection cover back on.

Make sure that the throttle grip will return to the idle position automatically once you let go of it.

To check the correctness of this setting, start the engine, turn the handlebar left and right, in both cases as far as it will go. This must not cause any changes in idling speed. Otherwise, you have to increase the backlash of the throttle cable.

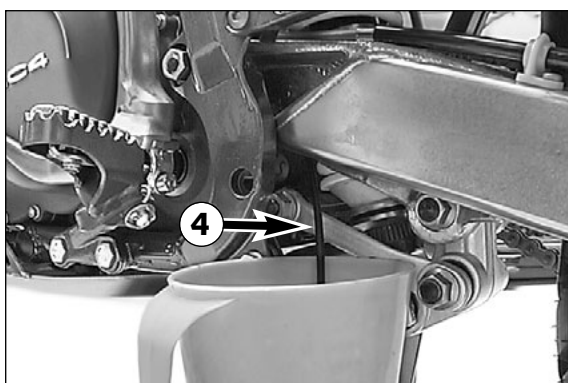

Draining the carburetor float chamber *

Following every wet-cleaning procedure, the float chamber of the carburetor should be drained in order to remove any water that may have penetrated into it. Water in the float chamber causes engine malfunction. Carry out this job with the engine being cold.

Close the fuel tap.

Put one end of the hose ④ that leads downward behind the engine into a collecting vessel.

Open the drain plug ⑤ (turning it counterclockwise) by several turns, and drain the fuel from the float chamber.

Then, retighten the drain plug and open the fuel tap.



WARNING



FUEL IS HIGHLY FLAMMABLE AND TOXIC. BE EXTREMELY CAUTIOUS WHEN HANDLING FUEL. NEVER PERFORM ANY WORK ON THE FUEL SYSTEM NEAR OPEN FIRE OR BURNING CIGARETTES. ALWAYS ALLOW THE ENGINE TO COOL DOWN FIRST. WIPE UP ANY SPILT FUEL IMMEDIATELY. MATERIALS SATURATED WITH FUEL ARE HIGHLY FLAMMABLE, AS WELL. IF YOU HAVE ACCIDENTALLY SWALLOWED FUEL OR IF IT HAS GOTTEN INTO YOUR EYES, GO SEE A PHYSICIAN IMMEDIATELY.

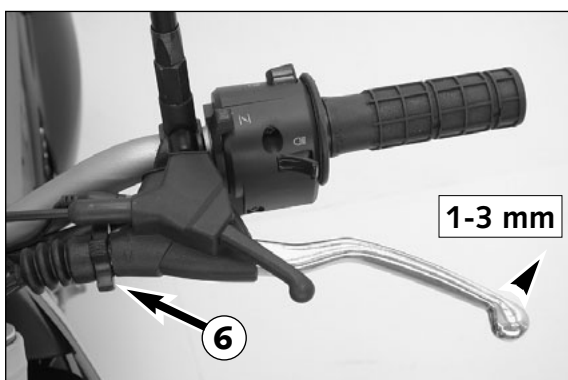
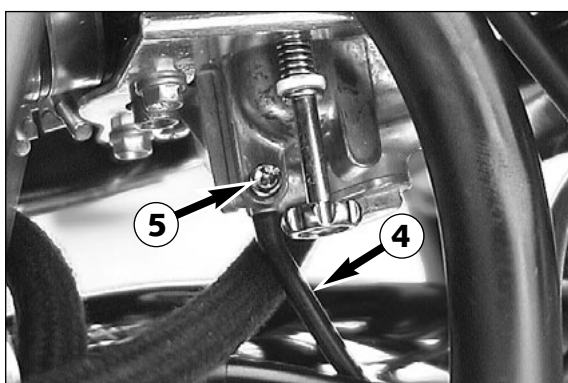

Adjusting the clutch cable

When the engine is cold, the play at the clutch lever should be 1-3 mm (0.04-0.12 in) (measured at the outer edge).

To adjust the clutch cable turn the adjusting nut ⑥ accordingly.

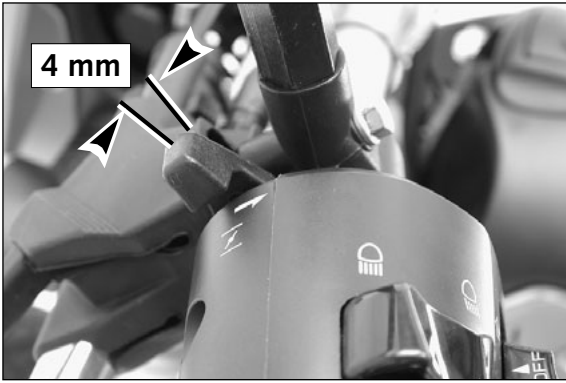

Checking and adjusting the choke cable play *

The choke lever must always have a play of approx. 4 mm (0,16 in). Remove the seat and tank to adjust.

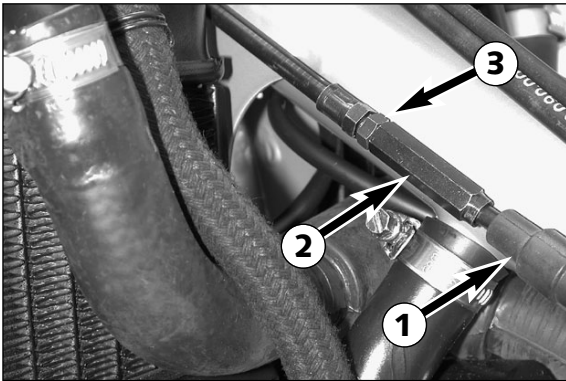

Push the choke lever all the way to the front and slide the protecting cap **1** from the adjusting part **2**. Loosen the lock nut **3** and correct the play by turning the adjusting part. Tighten lock nut and slide protecting cap back on. Mount the tank and seat.

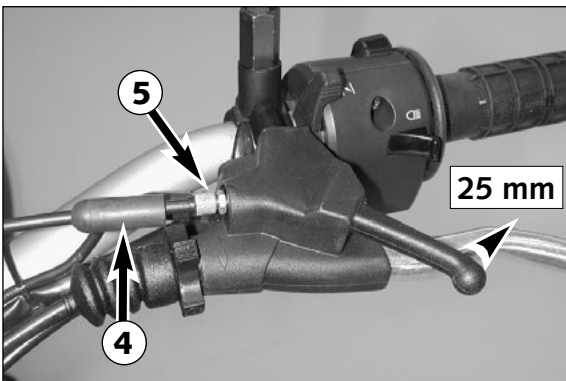

Checking the adjustment of the hand decompression cable*

To check, set piston at compression, so that the valves are closed. While doing this, slowly operate the kickstarter through its stroke until the clicking sound (disengaging) of the automatic decompression can be heard. Now the decompression lever must be operated 25 mm (1 in) until resistance is felt (the exhaust valves begin to open). To adjust move back the protective cover **4**, loosen the counter nut and correct the adjusting screw **5** accordingly. Tighten counter nut and push back protective cover.

! CAUTION !

IF THERE IS NO PLAY IN THE DECOMPRESSION LEVER, THIS CAN RESULT IN ENGINE DAMAGE.

NOTE:
No adjustment need be made to the automatic decompressor.

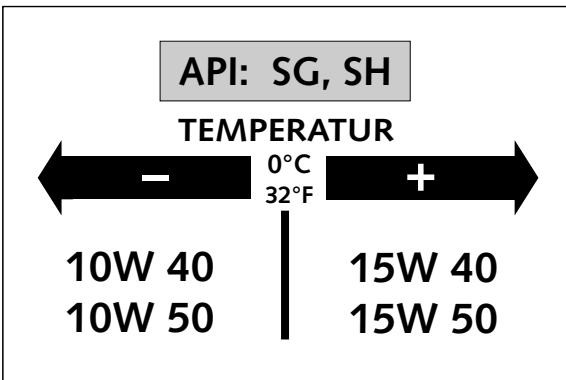

Engine oil

Only use fully synthetic branded oils (Shell Advance Ultra 4) meeting or surpassing the quality requirements of API classes SG or SH (see specifications on the container).

! CAUTION !

INSUFFICIENT OIL OR POOR QUALITY OIL RESULTS IN PREMATURE WEAR OF THE ENGINE.

Checking engine oil level

Allow the engine to run at idle speed for about 4 minutes. Turn off the engine and place the motorcycle on a flat, level surface (center stand). Wait 5 minutes, unscrew and remove the oil dipstick, and wipe it clean with a cloth.

SCREW THE DIPSTICK IN ALL THE WAY AND REMOVE IT AGAIN.

The oil level should be between the two marks on the dipstick, however, it must never rise above the MAX mark. Otherwise, engine oil would get into the air filter box by way of the engine venting system.

Add engine oil if necessary.

! CAUTION !

- INSUFFICIENT OIL OR POOR QUALITY OIL RESULTS IN PREMATURE WEAR OF THE ENGINE.
- CHECKING THE ENGINE OIL LEVEL WHEN THE ENGINE IS COLD RESULTS IN A FALSE READING ON THE OIL DIPSTICK AND THEREFORE AN INCORRECT OIL LEVEL.
- DO NOT OVERFILL THE ENGINE CASE.
- DO NOT UNDERFILL THE ENGINE CASE.

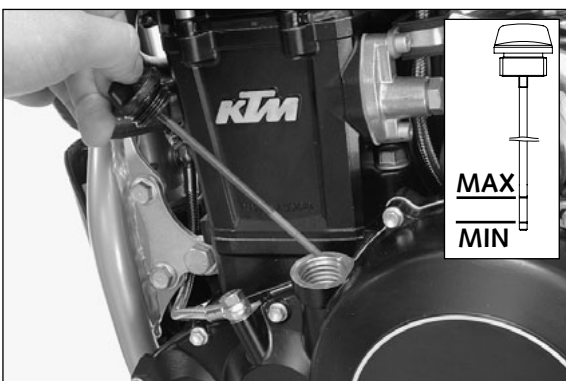

Finally, check oil system and engine for leaks.

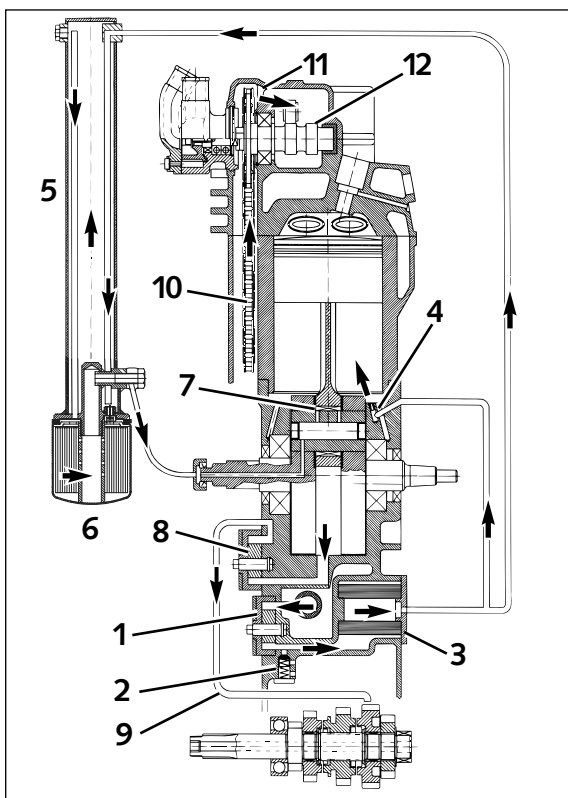

Oil circuit

The oil pump ① pumps the motor oil past the bypass valve ② and through the oil filter ③. Beyond the oil filter, one of the oil lines forks off to a jet ④ that injects motor oil to the piston pin bearing and the piston head. The second oil line leads the main oil flow to the frame breast pipe ⑤ where the motor oil is cooled off. Then the motor oil flows through the fine screen filter ⑥ that removes even the finest of contaminants from the motor oil. The cleansed motor oil is pumped via an oil line and the clutch cover into the crankshaft to the conrod bearing ⑦ and drains from there into the crank case. A additional oil pump ⑧ suctions the motor oil out of the crank case and pumps it through the oil canal ⑨ to the gear wheels of the 4th and 5th gears. The motor oil reaches the oil sump via the gear wheels. The timing chain ⑩ also dips into the oil sump and propels motor oil upwards to the cylinder head. The motor oil reaches the camshaft ⑪ and the valves through the bore ⑫.

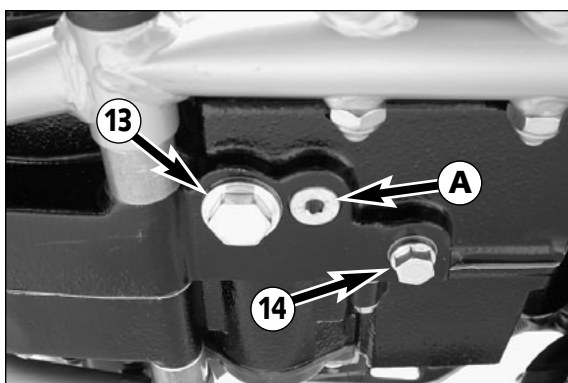

Oil and screen filter change, bleeding of the oil system *

Note: The frame breast pipe is integrated into the oil circuit for the sake of more effectively cooling the motor oil. It is thus important when changing the oil to also remove the fine screen filter, to drain the motor oil from the breast pipe and to de-aerate the oil system.

If the oil system is not bled at all or bled insufficiently, the bearings of the engine will not get enough lubrication, which in turn may result in engine failure.

Therefore, we recommend that you have the engine oil changed by your authorized KTM mechanic. During the guaranty period, the oil change must be performed by an authorized KTM mechanic. Otherwise, the guarantee will become void.

The engine oil change is to be carried out when the engine is still warm.

⚠ **WARNING** ⚠

AN ENGINE HAVING BEEN RUN WARM, AND THE ENGINE OIL IN IT IS VERY HOT - DO NOT BURN YOURSELF.

Place the motorcycle on a horizontal surface. Remove the two plugs ⑬ and ⑭, and drain oil into a container.

! **CAUTION** !

PLUG A MUST NOT BE REMOVED, THIS IS PART OF THE BY-PASS VALVE.

Remove the screws and the cover ⑮. Loosen the fine screen filter ⑯ with an oil filter wrench and then screw it off by hand.

The screw ⑯ must be removed to allow the motor oil to flow out of the frame breast pipe.

Clean the plugs thoroughly with petroleum and compressed air in order to remove any metal filings. After the oil has drained completely, clean the sealing areas and remount the plugs together with their gaskets. Tighten plug ⑮ with 30 Nm and plug ⑭ with 20 Nm. Tighten the screw ⑯ with 10 Nm. Clean sealing surfaces on the frame breast pipe ⑰, fill new fine screen filter with engine oil, and oil rubber gasket ⑱. Replace fine screen filter and screw it back in place, your bare hand will do.

Remove oil dipstick on the clutch cover, fill with 1,3 litre engine oil and attach plug again.

! **CAUTION** !

- USE ONLY ORIGINAL KTM FINE SCREEN FILTERS. USING ANOTHER FILTER BRAND CAN RESULT IN DAMAGE TO THE ENGINE.
- IF THE ENGINE OIL HAS BEEN DRAINED FROM THE FRONT PIPE OF THE FRAME, YOU MUST BLEED THE OIL SYSTEM !

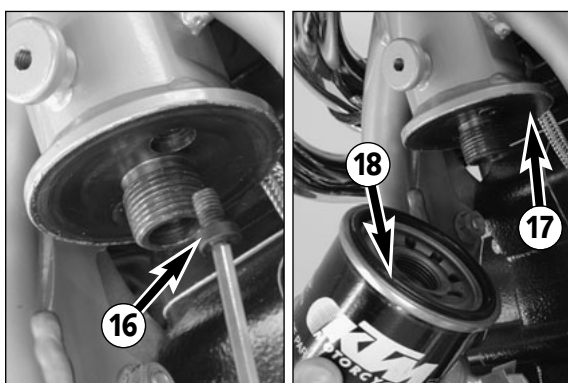



To facilitate bleeding of the oil system, we have added a hose connection piece and a plastic hose to the set of tools. Take an empty oil can (1 liter) and drill a 7 mm-diameter hole into the lid. Screw the hose connection piece into the lid from the outside, and secure it from the inside with the M8 hexagon nut.

Slip the plastic hose onto the hose connection piece, and you will have your filling tool.

Fill 0.6 liters of engine oil into the can and remove the plug **1** next to the steering head. Introduce the plastic hose into the vent hole **B**, (see page 30) and fill 0.6 liters of engine oil into the frame's front tube. Remove plastic hose, start engine, and let it idle (approx. 20 seconds) until oil escapes at the hole **B**. As soon as oil starts to escape, turn off the engine, and mount the plug together with the gasket.

Let the motor run until it warms. Check the oil drain plugs and the fine screen filter to make sure they are properly sealed. Check the level of the motor oil. Place the motorcycle on a horizontal surface (main stand) and wait for 5 minutes. Remove the dip stick and wipe it with a piece of cloth **SCREW THE DIPSTICK IN ALL THE WAY AND REMOVE IT AGAIN.**

The oil level should be between the two marks on the oil dipstick, however, it must never rise above the MAX mark.

Otherwise, engine oil would get into the air filter box by way of the engine venting system.

Add engine oil, if necessary.

! CAUTION !

- INSUFFICIENT OIL OR POOR QUALITY OIL RESULTS IN PREMATURE WEAR OF THE ENGINE.
- CHECKING THE ENGINE OIL LEVEL WHEN THE ENGINE IS COLD RESULTS IN A FALSE READING ON THE OIL DIPSTICK AND THEREFORE AN INCORRECT OIL LEVEL.
- DO NOT OVERFILL THE ENGINE CASE.
- DO NOT UNDERFILL THE ENGINE CASE.

Afterwards check the entire oil system and motor to make sure they are properly sealed. Attach the covering of the fine screen filter to the frame breast pipe.

NOTE: Dispose of used oil properly! Under no circumstances may used oil be disposed of in the sewage system or in the open countryside. 1 liter oil contaminates 1.000.000 liter water

Changing oil filter *

Replace the oil filter when changing the engine oil. Press the foot brake pedal and place a screwdriver or similar between foot brake pedal and stopper roll so that the oil filter cover is more accessible. Remove banjo bolt **2** and the three screws. Remove oil filter cover **3** and oil filter. Clean the filter case, oil filter cover and sealing areas. Make sure the oil duct in the oil filter cover is not clogged.

Place the new oil filter **4** on the connection in the oil filter cover and mount together with a new seal **5**. Tighten the 3 screws in the filter cover to 5 Nm (4 ft.lb). Tighten the hollow screw with seals and tighten to 15 Nm (11 ft.lb).

Finally, start the engine and check the oil system for leakage.

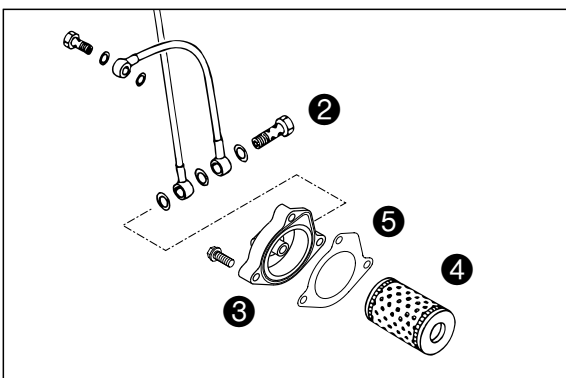
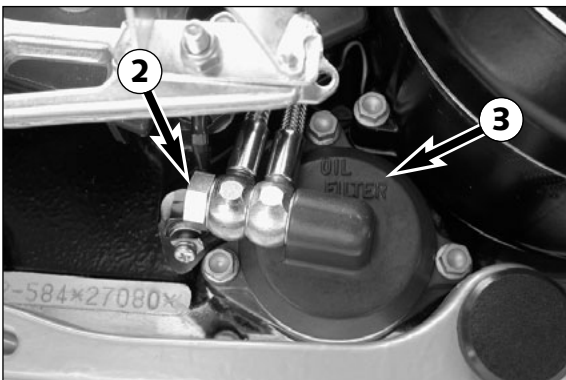
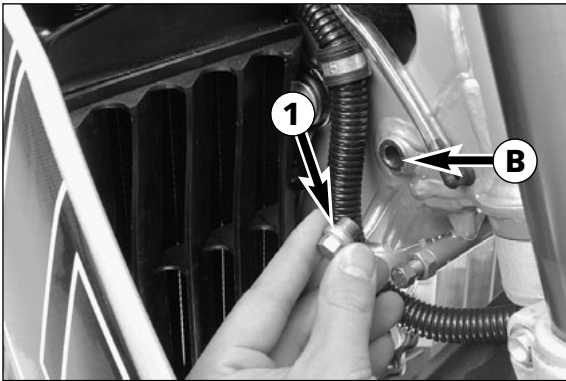

TROUBLE SHOOTING

If you let the specified maintenance work on your motorcycle be carried out, disturbances can hardly be expected. Should an error occur nevertheless, we advise you to use the trouble shooting chart in order to find the cause of error. We would like to point out that many operations cannot be performed by oneself. In case of uncertainty, please contact a KTM-dealer.

TROUBLE	CAUSE	REMEDY
Engine doesn't crank.	Operating error	Turn on the ignition, switch the gear to neutral and switch the emergency OFF switch on.
	Discharged battery.	Recharge the battery and investigate the causes for discharging; contact a KTM dealer.
	Defect ignition lock or emergency OFF switch	Check ignition lock and emergency OFF switch, contact a KTM dealer.
The engine doesn't crank. The neutral indicator lamp doesn't light up.	Blown fuse safe-starting system.	Replace fuse (below the headlight mask).
	Blown main fuse.	Remove seat and replace the main fuse. If fuse blows again contact a KTM dealer.
The engine cranks only with pulled clutch lever	Defect safe-starting system.	Contact a KTM dealer.
Engine cranks with gear engaged.	Defect safe-starting system.	Contact a KTM dealer.
Engine cranks but doesn't start.	Operating error	Open fuel tap, tank fuel, you did not use choke i.e. the warm-start device. Pay attention to starting off information (see driving instructions).
	The motorcycle has been out of operation for a longer period of time. Therefore old fuel has accumulated in the float chamber	The easily inflammable components of the new fuels evaporate during longer periods of standstill. When the motorcycle has been out of operation for more than a week, it is therefore recommended to drain the old fuel from the float chamber. The engine will immediately start off when the float chamber is filled with new fuel.
	Fuel supply interrupted	Place a vessel underneath, remove the drain plug from the carburetor and open the fuel cock, – if fuel leaks out, the carburetor might need cleaning – if no fuel leaks out, check tank ventilation, i.e. clean fuel tap
	Flooded engine	Fully open the throttle when starting or exchange the spark plug, respectively
	Sooty or wet spark plug	Clean and dry the spark plug or exchange it, respectively
	Electrode gap too large	Adjust spark plug elektrode gap to 0,9 mm
	Spark plug connector or spark plug faulty	Dismount spark plug, connect ignition cable, hold to ground (blank place on engine) and actuate starter, a strong spark must be produced at the spark plug – If no spark is created exchange the spark plug. – If the new spark plug doesn't produce a spark either, disconnect the spark plug connector from the ignition cable, hold it a distance of approx. 5 mm from ground and start. – If a spark now occurs, replace spark plug cap – If no spark is produced, control ignition system
	The plug connection of the CDI-unit, the pulse generator or the ignition coil has oxydized	Remove the seat, the right side cover and the fuel tank. Clean the plug connection and treat it with contact spray
	Water in carburetor or jets blocked	Dismount and clean carburetor
	Claped out side stand	Clap up side stand
	Faulty side stand switch	Renew side stand switch

TROUBLE	CAUSE	REMEDY
Engine fails to idle	<p>Glogged idling jet</p> <p>Onincorrect adjustment of adjusting screws on carburetor</p> <p>Defective spark plug</p> <p>Defective ignition system</p>	<p>Disassemble carburetor and clean jets</p> <p>Have carburetor adjusted</p> <p>Replace spark plug</p> <p>Have ignition system checked</p>
Engine does not rev high	<p>Carburetor fuel level too high because</p> <p>Float needle is dirty or worn out</p> <p>Float leaks</p> <p>The cold starting system is permanently activated due to a lack of play in the choke cable.</p> <p>Defective membrane of slide</p> <p>Carburetor leaking</p> <p>Loose carburettor jets</p> <p>Electronic ignition timing faulty</p>	<p>Dismount carburetor and check if worn out</p> <p>Replace float needle</p> <p>Replace float</p> <p>Adjust choke cable.</p> <p>Replace membrane</p> <p>Check vacuum hose and venting hose of carburetor for correct position (no kinks)</p> <p>Tighten jets</p> <p>Have ignition system checked</p>
Engine will not reach full power	<p>Fuel supply partially interrupted or carburetor dirty</p> <p>Float leaks</p> <p>Defective membrane of slide</p> <p>Carburetor leaking</p> <p>Air filter very dirty</p> <p>Valve clearance too small</p> <p>Loss of compression because hand decompressor has no play</p> <p>Electronic ignition timing faulty</p>	<p>Clean and check fuel system as well as carburetor</p> <p>Replace the float</p> <p>Replace membrane</p> <p>Check vacuum hose and venting hose of carburetor for correct position (no kinks)</p> <p>Clean or replace air filter, contact a KTM dealer</p> <p>Have valve clearance adjusted</p> <p>Check setting of the hand decompression cable</p> <p>Have ignition system checked</p>
Engine overheats	<p>Insufficient cooling liquid</p> <p>Radiator fins are extremely dirty</p> <p>Foam forms in cooling system</p> <p>Bent radiator hose</p> <p>Thermostat defective</p> <p>Blown fan fuse</p> <p>Defect thermoswitch</p> <p>Fan defective</p>	<p>Refill cooling liquid (see maintenance work), check cooling system for leaks</p> <p>Clean radiator with water jet</p> <p>Replace cooling liquid, use antifreezer with brand name</p> <p>Shorten or replace cooling hose</p> <p>Remove and check thermostat (opening temperature 70°C (158°F) or replace it, contact a KTM dealer</p> <p>Replace fuse and check if fan operates properly (see below)</p> <p>Contact a KTM dealer</p> <p>Check if fan operates properly. To do this, start the engine, then bypass the connections to the thermoswitch (bottom right radiator), contact a KTM dealer</p>

TROUBLE	CAUSE	REMEDY
High oil consumption	Buckling gear ventilation hose Engine oil level too high Engine oil too thin (viscosity)	Readjust or replace ventilation hose Check engine oil level when the engine is warm; correct if necessary Use thicker engine oil; see chapter „Engine oil“
All switched on lamps blown out	Voltage regulator faulty	Remove seat and check connections. Have voltage regulator checked
Headlight and parking light fail	Blown fuse	Replace fuse (below the headlight mask).
Flasher lights, brake light, fan and horn fail	Blown fuse	Replace fuse (below the headlight mask).
The NEUTRAL lamp is not on even though the gear is in NEUTRAL	Defect indicator lamp. Defect neutral switch.	Replace indicator lamp Connect cable to ground; neutral switch must be replaced if indicator lamp lights up.
The battery is discharged	Loose connections, defect cable. The ignition (power consumer) hasn't been switched off The battery isn't charged by the generator because	Check connections and cables. Recharge the battery according to the relevant instructions. Remove seat and check voltage regulator connections; voltage regulator and generator should be checked by a KTM dealer.

CLEANING

Clean your motorcycle regularly in order to maintain the beauty of its plastic surfaces.

The best manner would be to use warm water that has been mixed with a normal trade washing detergent and a sponge. The hard dirt can be removed before with the help of a soft water jet.

!

CAUTION

!

NEVER CLEAN YOUR MOTORCYCLE WITH A HIGH-PRESSURED CLEANER OR A HIGH-PRESSURED WATER JET. THE WATER COULD OTHERWISE RUN INTO THE ELECTRICAL COMPONENTS, CONNECTORS, SHEATHED CABLES, BEARINGS, CARBURETOR ETC. AND CAUSE DISTURBINGS OR LEAD TO A PREMATURE DESTRUCTION OF THESE PARTS.

- You should use normal trade-mark detergents to clean the engine. Strongly dirtied parts should be cleaned additionally with the help of a paint brush.
- After the motorcycle has been rinsed with a soft water jet, it should be dried by air pressure and a cloth. Then take a short drive until the engine has reached the working temperature and also use the brakes. Due to the heat, the water also evaporates at the unapproachable parts of the engine and the brakes.
- Slide back the protective covers on the handlebar-mounted instruments so that any water that may have seeped into this part of the motorcycle is allowed to evaporate.
- After the motorcycle has cooled down, oil and grease all sliding and pivot points. Treat the chain with a chain spray too.
- To prevent failures in the electric system, you should treat the ignition lock, the emergency OFF switch, light switch and the socket connectors with contact spray.

CONSERVATION FOR WINTER OPERATION

In the event that the motorcycle is also used in winter and on roads where one has to expect salt spraying, you will have to take precautions against the aggressive road salt.

- clean motorcycle thoroughly and let it dry
- treat engine, carburetor, swing arm, and all other bare or galvanized parts (except for brake discs) with a wax-based anti-corrosion agent.

⚠

WARNING

⚠

KEEP ANTI-CORROSION AGENT FROM GETTING INTO CONTACT WITH THE BRAKE DISCS, FOR OTHERWISE THIS WILL SIGNIFICANTLY REDUCE THE BRAKING POWER.

!

CAUTION

!

AFTER RIDES ON SALTED ROADS, CLEAN MOTORCYCLE THOROUGHLY WITH COLD WATER AND LET IT DRY WELL!

STORAGE

Should you desire to make a pause over a longer space of time, please observe the following instructions:

- Clean motorcycle thoroughly (see chapter: CLEANING)
- Change engine oil, oil filter and fine screen filter (old engine oil contains aggressive contaminations).
- Check antifreezer and amount of cooling liquid.
- Warm up the engine once again, close the fuel cock and wait until the engine dies. Then open the drain plug of the float chamber to remove the remaining fuel.
- Remove spark plug and fill in approx. 5 ccm of engine oil into the cylinder through the opening. Actuate kick-starter 10 times in order to distribute the oil onto the cylinder walls and mount the spark plug.
- Set piston to compression so that the valves will be closed (slowly operate the kickstarter, until you can hear the automatic decompressor click (release)
- Let fuel flow out of tank into an appropriate container.
- Correct tire pressure.
- Lubricate pivot points of the control levers, foot rests, etc. as well as the chain.
- Service the shock absorber linkage
- Disassemble and charge battery (see chapter: BATTERY).
- The storage place should be dry and not subject to excessive temperature fluctuations.
- Cover the motorcycle with an air permeated tarpaulin or blanket. Do not use non air permeable materials as a possible humidity might not be able to escape and could cause corrosion.

!

CAUTION

!

IT WOULD BE VERY BAD TO LET THE ENGINE RUN FOR A SHORT TIME DURING THE STORAGE PERIOD. THE ENGINE WOULD NOT GET WARMED UP ENOUGH AND THE THUS DEVELOPED STEAM WOULD CONDENSE DURING THE COMBUSTION PROCESS AND CAUSE THE VALVES AND EXHAUST TO RUST.

RE-INITIATION AFTER TIME OF STORAGE

- Mount the charged battery (regard polarity).
- Fill up tank with fresh fuel.
- Check motorcycle as before each start (see driving instructions).
- Take a short, careful test ride first.

NOTE: Before you put your motorcycle away for the winter, you have to check all parts for their function and wear. Should any service jobs, repairs, or any refitting be necessary, you should have them carried out during the off-season (lower workload at mechanics' shops). This way, you can avoid the long waiting times at your mechanic at the beginning of the next biking season.

TECHNICAL SPECIFICATIONS - CHASSIS 640 LC4, 640 LC4 SUPERMOTO 2002

	640 LC4	640 LC4 Supermoto
Frame	Central chrome-moly-steel frame	
Fork	White Power – Up Side Down 4357 MXMA	
Wheel travel front/rear	270 / 300 mm (10,6 / 11.8 in)	
Rear suspension	Central shock absorber (WP BAVP3612) with PRO-LEVER linkage to rear- swing-arm with needle bearing	
Front brake	Disc brake with carbon-steel brake disc, brake caliper floated	
Front brake disc	Ø 300 mm (11.8 in)	Ø 320 mm (12.6 in)
Rear brake	Disc brake with carbon-steel brake disc Ø 220 mm (8.7 in), brake caliper floated	
Tyres front	90/90-21	120/70-17
Air press. road, driver only	1.8 bar (26 psi)	2.0 bar (29 psi)
Air press. road with passenger	2.0 bar (29 psi)	2.2 bar (31 psi)
Tyres rear	140/80-18	160/60-17
Air press. road, driver only	2.0 bar (29 psi)	2.2 bar (31 psi)
Air press. road with passenger	2.2 bar (31 psi)	2.4 bar (34 psi)
Fuel tank capacity	11 or 18 liter (2.9 or 4.8 US gallons), 2.5 liter (0,6 US gallons) reserve	
Final drive ratio	16:42t 17:42t	
Chain	X – Ring 5/8 x 1/4"	
Bulps	headlight H4 12V 60/55W (socket P43t) parking light 12V 5W (socket W2,1x9,5d) instrument lights 12V 1,2W (socket W2x4,6d) indicator lamps 12V 1,2W (socket W2x4,6d) brake – rear light 12V 21/5 W (socket BaY15d) flasher light 12V 10W (socket Ba15s) license plate illumination . . . 12V 5W (socket W2,1x9,5 d)	
Battery	maintenance-free battery 12V 8Ah	
Steering angle	62,5 °	63°
Wheel base	1510 ± 10 mm (59.4 ± 0.4 in)	
Seat high	940 mm (37.6 in)	910 mm (36.4 in)
Ground clearance	355 mm (14.0 in)	335 mm (13.2 in)
Dead weight without fuel	136kg (300 lbs)	137 kg (302 lbs)
Max. permissible front axle load	211 kg (465 lbs)	
Max. permissible rear axle load	335 kg (740 lbs)	
Max. permissible laden weight	350 kg (773 lbs)	

STANDARD ADJUSTMENT - FORK		
	640 LC4	640 LC4 SUPERMOTO
	WP 0518W714	WP 0518W722
Compression adjuster	20	14
Rebound adjuster	12	14
Spring	4,2 N/mm	5,0 N/mm
Spring preload	6 mm (0,24in)	9 mm (0,36in)
Air chamber length	150 mm (5,9in)	130 mm (5,1in)
Fork oil	SAE 5	SAE 5

STANDARD-ADJUSTMENT - SHOCK ABSORBER		
	640 LC4	640 LC4 SUPERMOTO
	WP 0118W724	WP 0118W721
Compression adjuster	3	5
Rebound adjuster	7	7
Spring	66 / 260	75 / 260
Spring preload	23,5 mm(0,94in)	15 mm(0,6in)

TIGHTENING TORQUES - CHASSIS LC4

Collar nut front axle	M16x1,5	40 Nm	(30ft.lb)
Collar nut rear axle	M20x1,5	80 Nm	(59ft.lb)
Shock absorber top	M10	45 Nm	(33ft.lb)
Shock absorber bottom	M10	45 Nm	(33ft.lb)
Collar screws brake disk front/rear	M6 (10.9)	Loctite 243 + 10 Nm	(7ft.lb)
Screw brake caliper front	M8	Loctite 243 + 25 Nm	(19ft.lb)
Bearing bolt linkage arm/frame	M12	60 Nm	(44ft.lb)
Collar nuts rocker arm bolts	M14x1,5	100 Nm	(74ft.lb)
Engine mounting screw	M10	45 Nm	(33ft.lb)
Ball joint for push rod	M8	Loctite 243 + 25 Nm	(19ft.lb)
Sprocket screws on nuts	M8	Loctite 243 + 35 Nm	(25ft.lb)
Collar nut swingarm bolt	M14x1,5	100 Nm	(74ft.lb)
Clamping screws top triple clamp (USD 43)	M8	20 Nm	(15ft.lb)
Clamping screws bottom triple clamp (USD 43)	M8	15 Nm	(11ft.lb)
Clamping screws fork stubs	M8	10 Nm	(7ft.lb)
Screws handlebar clamp	M8	Loctite 243 + 20 Nm	(15ft.lb)
Allan head screw handle bar support	M10	Loctite 243 + 20 Nm	(15ft.lb)
Spoke nipple	M4	4 Nm	(3ft.lb)
Other screws on chassis	M6	10 Nm	(7ft.lb)
	M8	25 Nm	(19ft.lb)
	M10	45 Nm	(33ft.lb)
Other collar nuts on chassis	M6	15 Nm	(11ft.lb)
	M8	30 Nm	(22ft.lb)
	M10	50 Nm	(37ft.lb)

TECHNICAL DATA – ENGINE 640 LC4, 640 LC4 SUPERMOTO 2002

BASIC CARBURETOR SETTING

	640 LC4 640 LC4 Supermoto
Type	BST40-225
Carb.-setting number	090298
Main jet	142,5
Needle jet	689 X-6
Idling jet	45
Jet needle	6G5
Needle clip pos. f. top	3. from top
Mixt. adj. screw open	2,25

Engine	640 LC4
Design	Liquid-cooled single cylinder 4-stroke engine with balancer shaft and electric starter
Displacement	624,6 ccm
Bore / Stroke	101 / 78 mm
Ratio	11 : 1
Fuel	unleaded premium gasoline with a least RON 95
Valve timing	4 valves over rocker arm and 1 overhead camshaft, camshaft drive through single chain
Camshaft	249/1
Valve diameter	Intake: 36 mm Exhaust: 30 mm
Valve clearance cold	0,15 mm Exhaust: 0,15 mm
Crank shaft bearing	2 cylinder roller bearing
Connecting rod bearing	needle bearing
Top end bearing	bronze bushing
Piston	forged/cast aluminium alloy
Piston rings	1 compression ring, 1 taper face ring, 1 oil scraper ring
Engine lubrication	two Eaton-oilpumps
Engine oil	see bellow #
Engine oil quantity	appr. 2,1 liters including frame
Primary ratio	straight geared spur wheels 30 : 81 teeth
Clutch	multi disc clutch in oil bath
Transmission	5-speed claw shifted
Gear ratio	1st 14:35 2nd 15:24 3rd 18:21 4th 20:19 5th 22:18
Ignition system	contactless DC-CDI ignition with digital advanced system type KOKUSAN
Ignition timing	adjustment to max. 38° BTDC at 6000 rpm
Generator	12V 200W
Spark plug	NGK DPR8 EA9
Spark plug gap	0,9 mm
Cooling system	liquid cooled, permanent rotation of cooling liquid through mechanic driven water pump
Cooling liquid	1 liter, 40% antifreeze, 60% water, at least -25 ° C (-13 ° F)
Starting equipment	electric starter and kickstarter

#

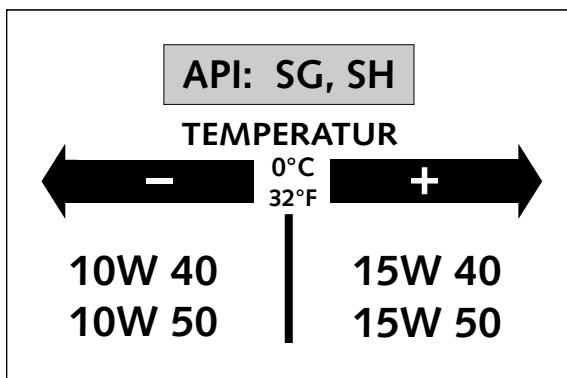

Engine oil

Only use fully synthetic branded oils (Shell Advance Ultra 4) meeting or surpassing the quality requirements of API classes SG or SH (see specifications on the container).

! CAUTION !

POOR OIL QUALITY OR MINOR QUANTITY EFFECT EARLY ENGINE-WEAR.

CONSUMER INFORMATION FOR USA ONLY

REPORTING SAFETY DEFECTS

If you believe that your vehicle has a defect which could cause a crash or could cause injury or death, you should immediately inform the National Highway Traffic Safety Administration (NHTSA) in addition to notifying KTM Sportmotorcycle USA, Inc.

If NHTSA receives similar complaints, it may open an investigation, and if it finds that a safety defect exists in a group of vehicles, it may order a recall and remedy campaign. However, NHTSA cannot become involved in individual problems between you, your dealer, or KTM Sportmotorcycle USA Inc. To contact NHTSA, you may either call the Auto Safety Hotline toll-free at 1-800-424-9393 (or 366-0123) in Washington D.C. area) or write to: NHTSA, U.S. Department of Transportation, Washington, D.C. 20590. You can also obtain other information about motor vehicle safety from the Hotline.

NOISE EMISSION WARRANTY

KTM Sportmotorcycle AG warrants that this exhaust system, at the time of sale, meets all applicable U.S. EPA Federal noise standards. This warranty extends to the first person who buys this exhaust system for purposes other than resale, and to all subsequent buyers.

Warranty claims should be directed to: KTM Sportmotorcycle USA Inc. 1119 Milan avenue, Amherst, Ohio 44001, Telephone: (440) 9853553

TAMPERING WARNING:

TAMPERING WITH NOISE CONTROL SYSTEM PROHIBITED. FEDERAL LAW PROHIBITS THE FOLLOWING ACTS OR CAUSING THEREOF:

- (1) The removal or rendering inoperative by any person other than for purposes of maintenance, repair, or replacement, of any device or element of design incorporated into any new vehicle for the purpose of noise control prior to its sale or delivery to the ultimate purchaser or while it is in use, or
- (2) the use of the vehicle after such device or element of design has been removed or rendered inoperative by any person.

AMONG THOSE ACTS PRESUMED TO CONSTITUTE TAMPERING ARE THE ACTS LISTED BELOW.

- 1) Removal of, or puncturing the muffler, baffles, header pipes or any other components which conducts exhaust gases.
- 2) Removal or puncturing of any part of the intake system.
- 3) Lack of proper maintenance.
- 4) Replacing any moving part of the vehicle, or parts of the exhaust or intake system, with parts other than those specified by the manufacturer.

WARNING STATEMENT:

This product should be checked for repair or replacement if the motorcycle noise has increased significantly through use. Otherwise, the owner may become subject to penalties under state and local ordinances.

VEHICLE MINIMUM STOPPING DISTANCE ON DRY PAVEMENT
This figures indicate braking performance that can be met or exceeded by the vehicle to which they apply, without the wheels, under different conditions of loading. The information presented results obtainable by skilled drivers under controlled road and vehicle conditions, and the information may not be correct under other conditions.

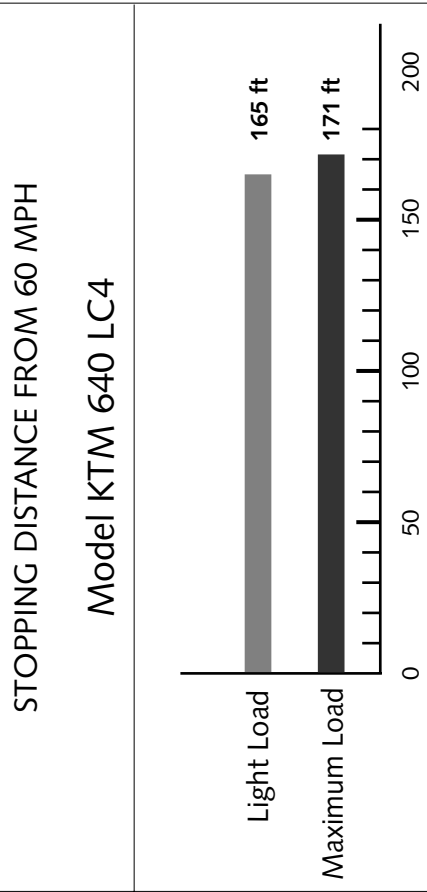

KTM 640 LC4, 640 LC4 Supermoto 2002

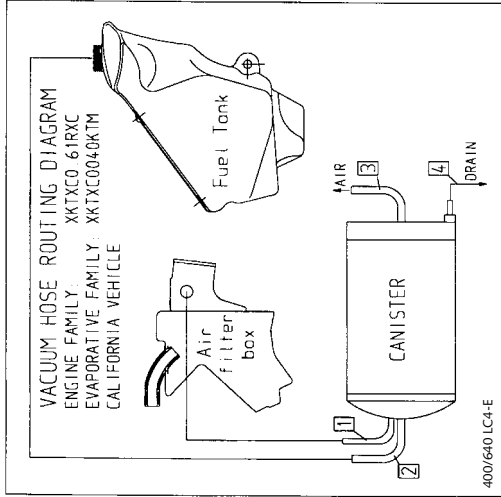

⚠ WARNING

- ALWAYS WEAR A HELMET
- OFF ROAD USE ONLY
- OPERATOR ONLY, NO PASSENGERS
THE ADDITION OF A PASSENGER
WILL ADVERSELY AFFECT THE
ABILITY OF THE OPERATOR TO
CONTROL THE VEHICLE.
- FAILURE TO FOLLOW PROPER
STARTING AND OPERATING
INSTRUCTIONS MAY RESULT IN AN
ACCIDENT. READ THE OWNER'S
MANUAL CAREFULLY.

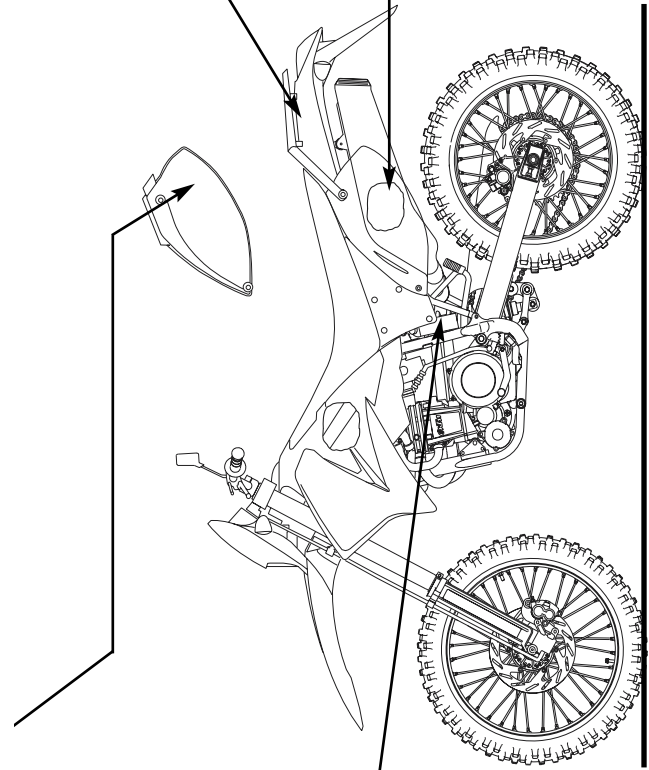

WARNING
THIS SHOCK ABSORBER CONTAINS NITROGEN GAS UNDER HIGH PRESSURE. DO NOT ATTEMPT REFILLING OR REBUILDING THE SHOCK, SINCE THE SHOCK MAY BE DAMAGED. REFER TO THE OWNERS MANUAL

THIS KTM EXHAUST SYSTEM 583.05.083.200 MEETS EPA NOISE EMISSION REQUIREMENTS OF 80 dBA FOR MODEL SPECIFIC CODE KTM 5840625. INSTALLATION OF THIS EXHAUST SYSTEM ON MOTORCYCLES NOT SPECIFIED MAY VIOLATE FEDERAL LAW.
640 LC4

KTM 640 LC4, 640 LC4 Supermoto 2002

KTM SPORTMOTORCYCLES		MFD. BY KTM SPORTMOTORCYCLE AG	DATE 01/09
MOTORCYCLE			
GVWR	770 lbs	350 kg	
GAWR FRONT	331 lbs	150 kg WITH 90/90-21 TIRE, 54S TT TYPE, 1,60-21 RIM, AT	22 psi 1,5 bar COLD
GAWR REAR	551 lbs	250 kg WITH 140/80-18 TIRE, 70R TT TYPE, 2,50-18 RIM, AT	29 psi 2,0 bar COLD
THIS VEHICLE CONFORMS TO ALL APPLICABLE FEDERAL MOTOR VEHICLE SAFETY STANDARDS IN EFFECT ON THE DATE OF MANUFACTURE SHOWN ABOVE.			
MOTORCYCLE NOISE EMISSION CONTROL INFORMATION THIS 2002 KTM5840625 MOTORCYCLE MEETS EPA NOISE EMISSION REQUIREMENTS OF 89 dBA AT 3750 RPM BY THE FEDERAL TEST PROCEDURE. MODIFICATION WHICH CAUSE THIS MOTORCYCLE TO EXCEED FEDERAL NOISE STANDARDS ARE PROHIBITED BY FEDERAL LAW. SEE OWNER'S MANUAL.			
640 LC4			
MADE IN AUSTRIA			

KTM SPORTMOTORCYCLES		MFD. BY KTM SPORTMOTORCYCLE AG	DATE 01/09
MOTORCYCLE			
GVWR	770 lbs	350 kg	
GAWR FRONT	331 lbs	150 kg WITH 120/70-17 TIRE, 58V TL TYPE, 3,50-17 RIM, AT	28 psi 2,0 bar COLD
GAWR REAR	551 lbs	250 kg WITH 160/60-17 TIRE, 69V TL TYPE, 4,25-17 RIM, AT	32 psi 2,2 bar COLD
THIS VEHICLE CONFORMS TO ALL APPLICABLE FEDERAL MOTOR VEHICLE SAFETY STANDARDS IN EFFECT ON THE DATE OF MANUFACTURE SHOWN ABOVE.			
MOTORCYCLE NOISE EMISSION CONTROL INFORMATION THIS 2002 KTM5840625 MOTORCYCLE MEETS EPA NOISE EMISSION REQUIREMENTS OF 89 dBA AT 3750 RPM BY THE FEDERAL TEST PROCEDURE. MODIFICATION WHICH CAUSE THIS MOTORCYCLE TO EXCEED FEDERAL NOISE STANDARDS ARE PROHIBITED BY FEDERAL LAW. SEE OWNER'S MANUAL.			
640 LC4			
MADE IN AUSTRIA			

KTM SPORTMOTORCYCLES		KTM SPORTMOTORCYCLE AG, MATTIGHOFEN, AUSTRIA	
VEHICLE EMISSION CONTROL INFORMATION			
ENGINE FAMILY	2KTXC0.62RXC	EVAPORATIVE FAMILY	2KTXE0040KTM
DISPLACEMENT	625cm ³	EXHAUST EMISSION CONTROL SYSTEM	E.M.
ENGINE TUNE-UP SPECIFICATIONS AND ADJUSTMENTS: N.A.			
ITEM	SPEC	ITEM	SPEC
1. IGNITION TIMING	8° BTDC(1500/RPM)	38° BTDC(6000/RPM)	
2. IDLE SPEED (RPM)	1500		
3. IDLE MIXTURE	NON-ADJUSTABLE		
4. VALVE CLEARANCE (MM) IN EX	0.15		
5. SPARK PLUG	NGK DPR8EA-9	SPARK PLUG GAP (MM)	0.7
FUEL SPECIFICATIONS	ENGINE LUBRICANT SPECIFICATIONS		
GASOLINE GRADE	UNLEADED	ENGINE OIL	2.1 LITRES (INCL.FRAME)
RESEARCH OCTANE	95	TYPE	SAE 15W/40
THIS VEHICLE CONFORMS TO U.S. EPA AND CALIFORNIA REGULATIONS APPLICABLE TO 2002 MODEL YEAR NEW MOTORCYCLES AND IS CERTIFIED TO 1.0 g/km HC EMISSION STANDARD IN CALIFORNIA.			
640 LC4			
MADE IN AUSTRIA			

KTM SPORTMOTORCYCLES		KTM SPORTMOTORCYCLE AG, MATTIGHOFEN, AUSTRIA	
VEHICLE EMISSION CONTROL INFORMATION			
ENGINE FAMILY	2KTXC0.61RXC	EVAPORATIVE FAMILY	2KTXE0040KTM
DISPLACEMENT	625cm ³	EXHAUST EMISSION CONTROL SYSTEM	E.M.
ENGINE TUNE-UP SPECIFICATIONS AND ADJUSTMENTS: N.A.			
ITEM	SPEC	ITEM	SPEC
1. IGNITION TIMING	8° BTDC(1500/RPM)	38° BTDC(6000/RPM)	
2. IDLE SPEED (RPM)	1500		
3. IDLE MIXTURE	NON-ADJUSTABLE		
4. VALVE CLEARANCE (MM) IN EX	0.15		
5. SPARK PLUG	NGK DPR8EA-9	SPARK PLUG GAP (MM)	0.7
FUEL SPECIFICATIONS	ENGINE LUBRICANT SPECIFICATIONS		
GASOLINE GRADE	UNLEADED	ENGINE OIL	2.1 LITRES (INCL.FRAME)
RESEARCH OCTANE	95	TYPE	SAE 15W/40
THIS VEHICLE CONFORMS TO U.S. EPA AND CALIFORNIA REGULATIONS APPLICABLE TO 2002 MODEL YEAR NEW MOTORCYCLES AND IS CERTIFIED TO 1.0 g/km HC EMISSION STANDARD IN CALIFORNIA.			
640 LC4			
MADE IN AUSTRIA			

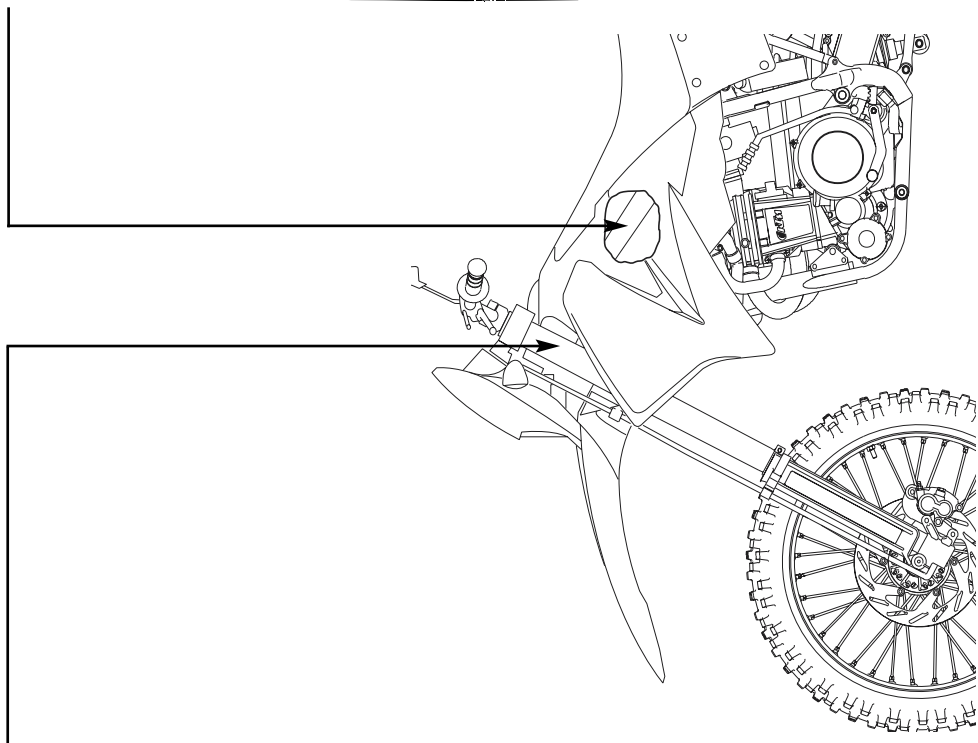

HEAD WORD INDEX

	page		page
Adjusting of free travel at the hand brake lever	19	Engine number, engine type	4
Adjusting idling speed	28	Engine oil	30
Adjusting the choke cable	30	Exchanging the brake light and tail light bulb.....	27
Adjusting the clutch cable	29	Exchanging the headlight lamp	26
Adjusting the throttle cable	29	Filler cap	6
Battery	25	Foot brake pedal	7
Chain maintenance	18	Fuel	6
Chain wear	19	Fuel tap	7
Changing oil filter	32	Fuses for individual power-consuming units.....	26
Changing the basic position of the foot brake pedal	20	General information on KTM disc brakes	19
Changing the fine screen filter	31	Hand brake lever	5
Changing the spring preload of the shock absorber	17	Hand decompression lever	4
Charging the battery.....	25	Head word index	43
Chassis number.....	4	Holding bars	8
Check the rear brake fluid level.....	21	Ignition lock.....	5
Checking and adjusting steering head bearing	17	Kickstarter.....	7
Checking chain tension	18	Lubricate shock absorber linkage	17
Checking of brake fluid level - front brake	20	Main fuse	26
Checking rubber ring on the rear shock absorber	18	Maintenance work on chassis and engine	16
Checking spoke tension	24	Oil and fine screen filter change, bleeding of the oil system	31
Checking the adjustment of the hand decompression cable	30	Oil circuit	31
Checking the cooling liquid level.....	28	Operation Instruments	4
Checking the engine oil level	30	Periodic Maintenance- Schedule	14
Checking the front brake pads	20	Re-initiation after time of storage	36
Checking the rear brake pads.....	21	Rebound damping of fork	8
Checking the shock absorbtion rubbers in the rear hub	23	Rebound damping of shock absorber.....	8
Choke lever	5	Refilling the front brake fluid reservoir	20
Cleaning	36	Refilling the rear brake fluid reservoir	21
Cleaning the air filter	28	Removing the seat	16
Clutch lever	4	Replacing the parking light bulb.....	26
Combination switch	6	Serial number locations	4
Compression damping of fork.....	8	Shift lever	7
Compression damping of shock absorber.....	8	Speedometer, indicator lamps	5
Conservation for Winter Operation.....	36	Starter tip switch, emergency OFF switch.....	6
Consumer Information for USA only	40	Storage	36
Cooling system	27	Technical spezifications- engine	38
Correct chain tension	18	Technical spezifications- chassis	37
Dismounting and mounting the front wheel	22	Tires, air pressure	24
Dismounting and mounting the rear wheel	23	Tool set.....	16
Draining the carburetor float chamber	29	Trouble shooting.....	33
Driving Instructions.....	9	wiring diagram	Appendix



KTM SPORTMOTORCYCLE AG
5230 Mattighofen
Austria
Internet: www.ktm.at



321021

Free Manuals Download Website

<http://myh66.com>

<http://usermanuals.us>

<http://www.somanuals.com>

<http://www.4manuals.cc>

<http://www.manual-lib.com>

<http://www.404manual.com>

<http://www.luxmanual.com>

<http://aubethermostatmanual.com>

Golf course search by state

<http://golfingnear.com>

Email search by domain

<http://emailbydomain.com>

Auto manuals search

<http://auto.somanuals.com>

TV manuals search

<http://tv.somanuals.com>