

Operating Manual

Twin-DVR Sat Receiver UFD 580/580S with Hard Disk Drive

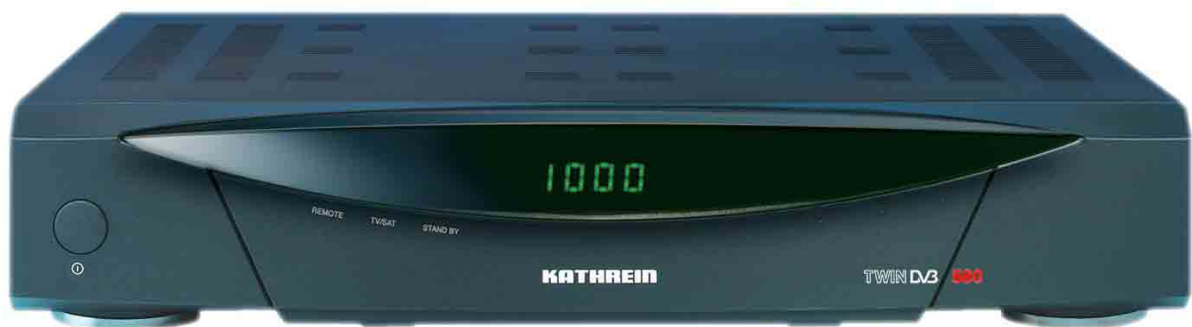

KATHREIN

Antennen · Electronic

Preface

Dear customer,

This Operating Manual is intended to help you make the fullest use of the extensive range of functions offered by your new satellite receiver.

We have tried to make the operating instructions as easy as possible to understand, and to keep them as concise as possible. To help you understand particular specialist terms that cannot be translated, we have added a short glossary at the end of the manual.

The power switch is an environmentally friendly feature. If you will not be using your receiver for a longer period, you should therefore use the power switch to disconnect it from the power supply to save energy. For shorter breaks, you can switch the receiver to standby on the remote control, which uses only a minimal amount of energy.

We wish you good reception and much pleasure using your new DVR-Sat receiver.

Your
KATHREIN Team

Important Information

If you should experience any unexpected problems with your receiver, please contact your specialist dealer or our hotline:

Tel.: +49 8031 184-700

Fax: +49 8031 184-676

The programmes available on the satellites and transponders are subject to continual change. In such cases, it is necessary to reset the channels as the factory preset programming corresponds to the situation on the date of manufacture. The information for this reset can be found on the SAT 1 Videotext/Teletext service, on the Internet or in TV and radio magazines.

Your receiver is factory fitted with the latest software version. We are, however, constantly working on adapting the software to the wishes of our customers and to developments in technology. The "Software and Channel List Update" section contains additional information.

Please keep the original packaging in case you need to return the product at any time.

The hard disks are fragile due to their construction and are only adequately protected in the receiver by the original packaging.

If receiver is not shipped correctly the warranty on the hard disk will be voided.

UFO[®]*micro* and UFO[®]*mini* are registered trademarks of KATHREIN-Werke KG.

DiSEqC™ is a trademark of Eutelsat.

Contents

Preface	2
Contents	3
Safety Instructions - Important Information	6
Receiver-Features	7
Remote control RC 660	7
Remote Control Menu Functions	8
Controls, Displays und Connections	9
View of front panel (flap folded down)	9
View of rear panel	9
Front Panel Controls and Displays	9
Rear Panel Controls and Displays	9
Important Note on Initial Operation of the Receiver on a UFO® micro System	10
Operating Instructions	11
Menu Concept	11
Alphanumeric Inputs	11
Alphanumeric Assignment of Remote Control Number Buttons	12
Language Selection - OSD	12
Connection and Setup	13
Connecting the Unit	13
Sat IF Connection	13
Reception Requirements	13
Reception System Presets	13
Operation on one Antenna Connection	14
TV and Video Recorder Connection	15
Audio Connection	15
SPDIF Connections (Electrical/Optical)	15
Inserting Batteries in the Remote Control	15
Initial Setup	16
Getting Started	16
Power Failure Safety	16
Error Signalling	16
Receiver Presetting	17
On Screen Display (OSD)	18
Important On-Screen Displays	18
Help Function	18
TV Channel Identifier	19
Radio Channel Identifier	19
Error Signalling	19
TV/Radio Channel List	20
Videotext (Teletext)	21
Channel List	22
Selecting a TV Programme	22
Reception Status	22
Selecting a TV Programme by Number	23
Switching to a Radio Programme	24
Common Interface	25
Tein Functions	27
Picture-in-Picture (PIP)	27
Time-Shift	28
One-Touch Recording	28
TVTV EPG and Timer	29
Accessing the TVTV EPG for the First Time	29
Accessing the TVTV EPG	30
“Current” View	30

Contents

Programme List	31
Highlights	32
Programmes Sorted by Category	32
Search Function	33
Details	34
Programming a Recording	35
Timer List	37
Key to Symbols	40
Channel List	41
Hard Disk Recorder	42
Recording and Watching TV	42
LNB Configuration - Overview	42
Tuner input	42
Recording	43
Hard Disk Capacity	43
Time-Shift Recording	44
One-Touch Recording (OTR)	45
Timer Recording	46
Stopping a Recording	46
Split Take	48
Playback and Recording	48
Fast Forward/Fast Rewind (no picture)	49
Playback	49
Audio Mode	52
Search	52
Delete	52
Audio Settings	53
Setting the Volume	53
Muting	53
Stereo and Two-Channel Sound Playback	53
AC 3	53
Programme List	54
Favourites	54
Generating a Favourites List	55
Alphabetical Channel Search	56
Sorting Programmes	58
Deleting Programmes	59
Manually Adding Programmes	59
Selecting the Last Programmes Received	61
Password	62
Factory Default	62
Entering the Password	62
Parental Control	64
Using the Front Panel	66
Backup Operation	66
Setting System Parameters	67
System Parameters	68
Parental Control	68
System Information	68
Local Time/Timer	68
TV Type	69
Aspect Ratio	69
Screen	69
A/V Mode	69
Adding/Removing Satellites	70
Satellite Setup	70
Entering a Satellite Name	71
Removing Satellites	71

Contents

Installation Menu	72
LNB Configuration	72
Antenna Setup	75
Antenna Rotor/Positioner (DiSEqC™ 1.2)	75
Satellite Scan	76
TP Edit/Scan	77
Important Note on Deleting Transponders	79
DiSEqC™ [UFO] Setup	80
UFO® <i>micro</i>	82
Factory Set	82
Logging on to UFO <i>micro</i> ®	82
Video Recorder Connection	83
Recording	83
Playback	83
Software and Programme List Update	84
Receiver to Receiver Data Transfer	86
Preparations	86
Programme List Download	86
Operating System Software Download	86
Technical Appendix	87
Technical Features	87
Technical Data	88
Connections	89
Accessories	90
Scart Socket Assignment	90
VHS/S-VHS Switching	90
Connection Example	91
Troubleshooting	92
Short Technical Guide	93
Service	96

Safety Instructions - Important Information

This page contains important information about the operation, installation location and connection of the unit.

Read these instructions carefully before starting to use the unit.



Mains cable

Make sure that the mains cable (power supply cable) is not damaged. Units with a damaged mains cable must be disconnected from the mains (disconnect mains connector) and repaired by a qualified engineer before setup. Only use the power pack supplied (if available).

Risk of death due to electric shock.

Cleaning

Disconnect the mains connector before cleaning the unit. Only use a dry cloth for cleaning and only clean the outer surface. Never open the unit.

Touching the parts inside the unit carries a risk of death due to electric shock.

Playing children

Make sure that children do not push any objects into the ventilation slots.

Risk of death due to electric shock.



Earth connection

The antenna system must be earthed as specified or equipotentially bonded. EN 60728/11 and any national regulations must be complied with.

Danger due to surge voltages, lightning strikes.

Mains voltage

Only operate the unit with the specified mains voltage (marked on the rear of the unit or on the external power pack). The unit may only be connected to the mains and turned on once it has been connected to the antenna and to the TV set or the cable network and PC.

If the mains voltage is too high, there is a risk of fire.

Repairs

Ensure that any repairs to your unit are carried out by qualified personnel. Opening the unit and attempting to repair it yourself voids all warranty claims.

Improper work on the unit can jeopardise the electrical safety of the unit.

The manufacturer accepts no liability for accidents caused by the user opening the unit.



Connections

Incorrect wiring of the connections can lead to malfunctions or defects on the unit.

Long periods of absence / storms

Always turn off the unit at the mains switch if you will be absent for a long time or there is a storm. If your unit does not have a mains switch, you can disconnect it from the mains by unplugging the mains connector. This also applies to the other equipment connected to the unit. Isolation from the cable network is also recommended. Note any timer programs (receiver) and turn the unit on again promptly before the recording time.



Installation location

All electronic equipment generates heat. However, the heating of this unit lies within the permissible range. Sensitive furniture surfaces and veneers may become discoloured by the effects of constant heat over time. The feet of the unit can also cause colour changes to treated furniture surfaces. If necessary, place the unit on a suitable stable and flat base.



Ventilation

The heat generated in this unit is adequately dissipated. However, the unit should never be installed in a cupboard or on shelves with inadequate ventilation. Never cover the cooling slots on the unit (e.g. with other equipment, magazines, tablecloths or curtains).

Do not place any objects on top of the unit and maintain a clearance of at least 10 cm above the unit, so that the heat generated can be dissipated with no obstructions.

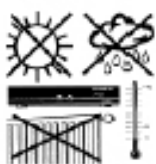

Moisture, sunlight, heat

Protect the unit against moisture, dripping and splashed water (do not place any filled objects such as vases on top of the unit). Do not place the unit close to a heater or expose it to direct sunlight and do not operate it in damp locations. Only use the unit in a moderate climate, not in tropical conditions.

Receiver-Features

The UFD 580 has two separate tuners for simultaneous reception of two programmes, and a hard disk for recording and playback.

Depending on constellation, you can

- view one programme and record another to hard disk,
- play back one programme from the hard disk and record one programme to hard disk, or
- record two programmes to hard disk and play back one programme from the hard disk, or
- record two programmes to hard disk and view a programme from one of the programme packages being received.

To take advantage of all these opportunities, complex operating procedures are necessary. You should therefore read this operating manual thoroughly.



Remote control RC 660

The RC 660 remote control supports up to four devices as well as the receivers of the UFD 5xx (not UFD 552, 554, 558) and UFD 4xx families.



To configure a receiver to an infrared code:

Switch on the relevant receiver.

On the remote control simultaneously press



Address 1 =  +  + 

to



Address 4 =  +  + 



To configure the remote control to an infrared code:

Switch to

Address 1 =  + 

to



Address 4.=  + 

 +  (red) = Kathrein UFD 5xx code for remote control RC 400

The RC 600 and RC 650 remote controls cannot be replaced!

Remote Control Menu Functions

 Sound on/off

 ... 
Number input for programmes, timer etc.



Menu



Prog; Make channel favourite

picture-in-picture from 2nd tuner or from hard disk Lock channel

Volume

Exit menu



Rewind

Play back hard disk content



Freeze frame, video timeshift

Recording
Slow-motion during playback



 Power on/off



Videotext/Teletext

Tone selection

Switch TV/Radio



Programme info

 AV mode

Programm selection up/down

Confirm input

Arrow buttons

Electronic Programme Guide



Fast forward

Stop recording/playback
TV freeze frame

Controls, Displays und Connections

This section provides a brief description of all the controls, displays and connections. The button symbols presented here can also be found in the description of the operating steps.

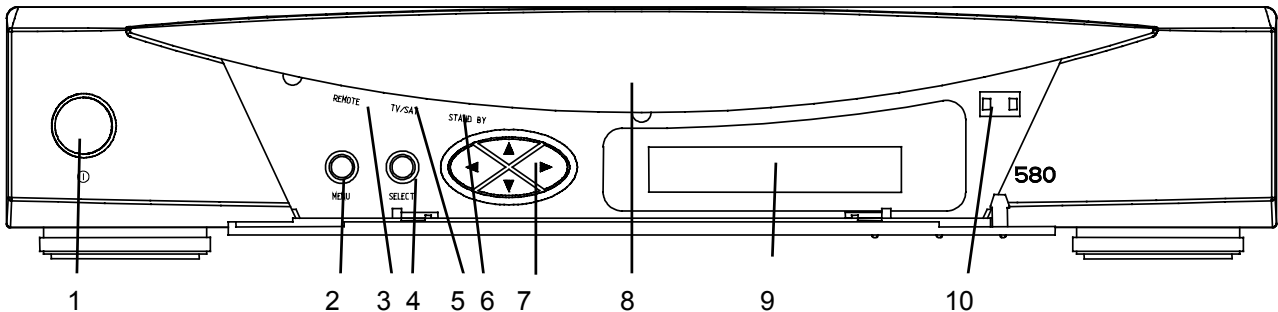
View of front panel (flap folded down)



View of rear panel

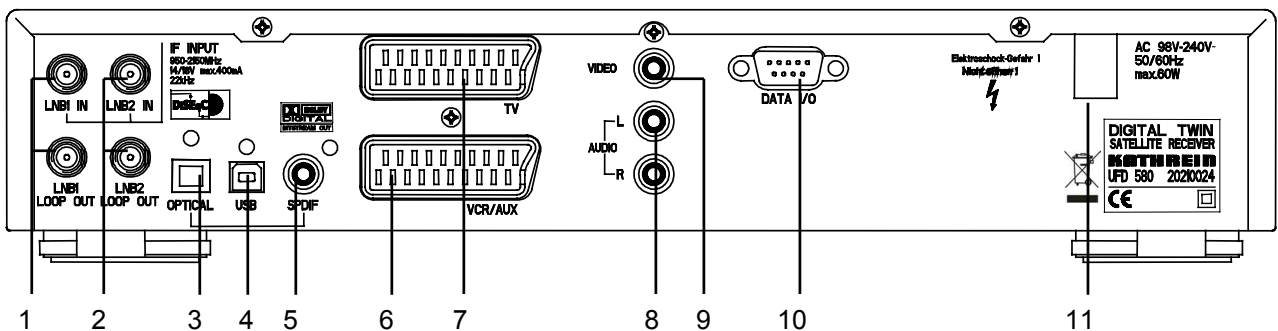

Front Panel Controls and Displays

- 1 On/Off switch (with mains disconnect)
- 2 Menu button to call up or exit menus or submenus
- 3 Remote control signal acknowledge
- 4 Select button to confirm a selection
- 5 Operation indicator
- 6 Standby indicator
- 7 Arrow buttons for menu and programme list
- 8 LED (4-digit, 7-segment display) to show programme slot and time, Play and Record
- 9 Common interface for Pay TV cards^{*)}
- 10 Pressure catch for front flap.
Open by lightly applying pressure on the upper right-hand side

Rear Panel Controls and Displays

- 1 LNB 1 input and loop-through output
- 2 LNB 2 input and loop-through output
- 3 Optical data stream output (SPDIF/Sony Philips Digital Interchange Format) for Dolby Digital AC 3 audio
- 4 USB port (for Service only)
- 5 Electrical SPDIF data stream output (AC 3) audio
- 6 Scart socket for VCR-/AUX connection
- 7 Scart socket for TV connection
- 8 Audio outputs (L/R) cinch sockets
- 9 Video output (FBAS)
- 10 RS 232 port (for Service only)
- 11 Mains power cable

^{*)} CA modules and Pay TV cards are not included

Important Note on Initial Operation of the Receiver on a UFO[®]micro System

It is absolutely essential to carry out the following before and while registering receivers on the EXU 544 UFO[®]micro single-cable matrix:

- Connect the receiver to the TV set, but **do not yet** connect it to the UFO[®]micro ESU 32 outlet!
- You must first check the following settings on the “LNB Configuration” menu and change them as necessary:
 1. Press the **MENU** button to switch to the main menu
 2. Press **▲▼** to get to the installation menu and confirm your entry by pressing **OK**
 3. Press **▲▼** to get to the LNB configuration menu and confirm your entry by pressing **OK**
 4. Press **▲▼** to select the “ASTRA” satellite and confirm your entry by pressing **OK**
 5. Press **▲▼** to select “Tuner input” and press **◀▶** to change the selection to “#1 & #2”
 6. Press **EXIT** to quit the set-up for the “ASTRA” satellite

You must run through steps 4-6 for each satellite received!

7. Press **EXIT** three times to get back to the start screen
 8. Interconnect the “LNB1 LOOP OUT” tuner output and the “LNB2 IN” tuner input by a coaxial cable (F standard connector).
- Now carry out a UFO[®]micro reset on the receiver, as described below:
 1. Press the **MENU** button to switch to the main menu
 2. Press **▲▼** to get to the installation menu and confirm your entry by pressing **OK**
 3. Press **▲▼** to get to the DiSEqC[UFO] set-up and confirm your entry by pressing **OK**
 4. Press **▲▼** to select the UFO option
 5. On the UFO menu press **▲▼** to select “UFO[®]micro”
 6. Press **OK** and change your selection to RESET by pressing **◀▶**
Confirm your selection by pressing **OK**
 7. Press **EXIT** to quit the UFO menu (press **OK** to save your changes)
 8. Press **EXIT** three times to get back to the starting point
 - Press **⏻** to switch the receiver to standby mode
 - Now you can connect the receiver to the ESU 32 outlet
 - Press **⏻** to switch the receiver on
 - The registration is then performed automatically – the screen briefly shows: “UFO[®]micro active”
 - Now perform a UFO[®]micro reset as described above (items 1-8).

Operating Instructions

Menu Concept

The structure of the menu concept is based on logical operating sequences.

The current selected programme always appears in the upper right-hand corner of the screen.

Note:

The selected menus, sub-menus and positions, as well as the parameters to be set, are each highlighted in colour. The menus are self-explanatory to a great extent. For additional information, press the

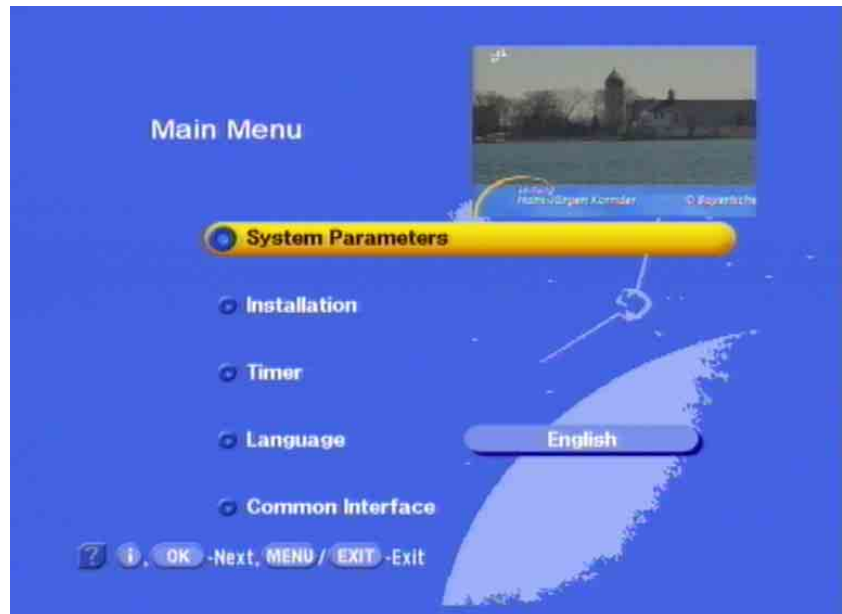

 button (See “On-screen display/Help function”).



Pay attention to the bar at the bottom of the on-screen display! It provides guidance on what to do next.

The main menu is opened by pressing the  button and the sub-menus are selected using the   buttons.

To access the submenus, press . The items in the submenu are selected by pressing the   buttons.

The settings under the various options are made either by pressing the   buttons or using the number pad. Quit the main menu or submenu by pressing .

Alphanumeric Inputs

Pay attention to the bar at the bottom of the screen with details on the relevant menu item!

You use the number pad buttons to enter programme and satellite names. The numbers and letters appear in the name fields of the corresponding menus. Place the cursor in the name field. The first character is automatically given a dark background. You can now use the number pad to enter letters by pressing the relevant button several times. For example, the “2” is also used for A, B and C.

Operating Instructions

Alphanumeric Assignment of Remote Control Number Buttons

Button	1 x	2 x	3 x	4 x	5x
①	1	.	,	?	1
②	2	A	B	S	2
③	3	D	E	F	3
④	4	G	H	I	4
⑤	5	J	K	L	5
⑥	6	M	N	O	6
⑦	7	P/Q	R	S	7
⑧	8	T	U	V	8
⑨	9	W	X	Y	Z
⑩	0	UNUSED	0	UNUSED	0

Language Selection - OSD

The language for the on-screen display is set as follows:

MENU → ▲ ▼ → Menu language → ◀ ▶ → English → MENU

The languages available are Dutch, English, French, German, Italian, Portuguese, Spanish and Turkish.

Connection and Setup

The following section is intended specifically for specialist dealers. You only need to pay attention to this section if you are carrying out the installation yourself.

The “Connection Examples” section provides a range of sample configurations.

Do not connect the unit to the mains until all installation work has been properly carried out.

Refer to the information in the “Safety instructions” section.

Connecting the Unit

Sat IF Connection



Connect the Sat IF inputs on the receiver to the satellite reception system.

Use coaxial cable with a standard F connector.

If the F connectors are not yet fitted on the cable, strip the insulation from the cables as shown in the following illustration and carefully twist the F connectors onto the ends of the cables until they are securely fitted.

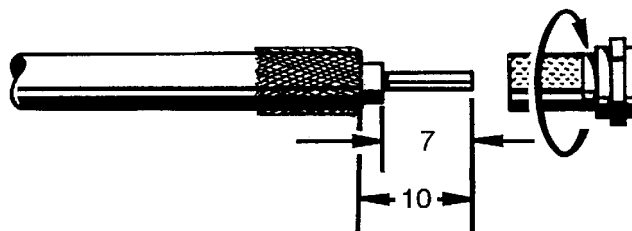

When fitting the connector, make sure that no wires from the braiding are touching the inner conductor, so no short circuit can occur.

The quality of the reception signal depends on the connection.

Reception Requirements



Make sure that your own satellite antenna system is equipped at least with a universal LNB for digital reception in the high-band range.

Reception System Presets

The presets for the control signals have been made for standard reception systems, i.e. 14/18 V for polarity reversal and 22 kHz switching signal for low/high band changeover on multi-feed reception systems.

The preset will need to be changed in the installation menu under “DiSEqC™” if UFO® *micro* or tone burst switching matrices are used in the receiving system.

Refer to the section headed “Installation menu, DiSEqC™ menu”.

Be sure to follow the operating instructions for the matrix used.

Connection and Setup

Operation on one Antenna Connection

To enable you to utilise all the reception and recording properties of your UFD 580 twin-DVR Sat receiver, such as

1. recording one programme and at the same time viewing any other programme or zapping through the programmes, and
2. recording two different programmes at the same time,

the two tuner inputs of the Sat receiver must each be supplied with a dedicated satellite signal from the antenna system/Sat outlet.

The receiver tuner inputs are factory preset on the installation menu for “#1 & #2” mode, meaning for two separate Sat antennas.

If you only have one antenna connection available, we recommend you interconnect the output of tuner 1 and the input of tuner 2 by a coaxial cable with F connectors.

Coax cable with F connectors

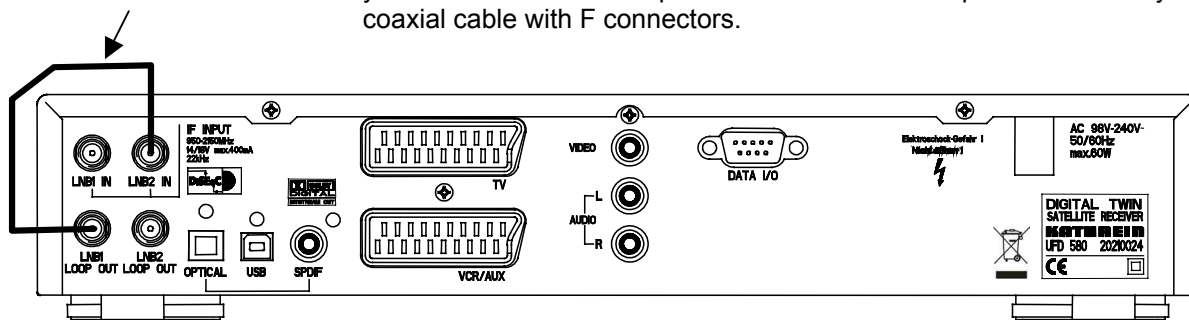

Then “Loop” mode must be selected on the installation menu for the tuner input.

You will find the “Tuner input” option by pressing the **MENU** button. Then select “Installation”, “LNB configuration”, and confirm the satellite you are receiving by pressing **OK**. You can then make the settings here, though a restriction on this is that with tuner 2 you can only receive the additional programmes of the plane currently set by tuner 1 (e.g. Horizontal High).



Note:

*This will only work when receiving one satellite, **not** in multifeed reception!*

If only tuner 1 is connected (with no connection to tuner 2), the setting “#1” must be selected for the tuner input. You can then have only the possibilities offered by a normal “single” receiver available to you.

If this setting is not made, malfunctions will occur and the following message will be displayed:

Weak signal or no signal!

Connection and Setup

TV and Video Recorder Connection

Connect the satellite receiver (TV Scart socket) and the TV set by a Scart cable (see "Connection example").

If your TV has a stereo feature, you can receive the sound in stereo via the Scart connection.

Connect the satellite receiver (VCR/AUX Scart socket) and the video recorder likewise by a Scart cable.

For system reasons, the same video signals are to be found on the Scart outputs and on the video cinch output.

If you are recording using an external video recorder, remember not to operate the receiver during recording, otherwise all the on-screen displays will appear on your recording.



Audio Connection

If you want to play the sound on your hi-fi system, connect the audio cinch sockets to the input sockets on the hi-fi system with an appropriate cable (see "Connection example").

SPDIF Connections (Electrical/Optical)

The electrical SPDIF cinch output and the optical output are for connection to a Dolby digital system (see "Connection example").

Inserting Batteries in the Remote Control

Remove the cover on the rear of the remote control.

Insert the two supplied batteries into the remote control. Ensure correct polarity of the batteries; the + and - markings are indicated inside the battery compartment.

Slide the cover back into the housing until it locks in place.

Used batteries are special waste.

Do not throw used batteries into your household waste; take them to a collection point for old batteries.



Electronic equipment is *not household waste* - in accordance with directive 2002/96/EC OF THE EUROPEAN PARLIAMENT AND THE COUNCIL dated 27th January 2003 on used electrical and electronic equipment, it must be disposed of properly.

At the end of its service life, take this unit for disposal at a designated public collection point.

Initial Setup

Getting Started



Connect the unit to the mains power supply.

Switch on the receiver by pressing the power button on the front of the unit.

The LED shows “- - - -”.





The operation indicator LED lights up red, the unit is in standby.

Switch on the receiver by pressing the  button on the remote control.

The red LED on the front panel of the receiver flashes each time a button on the remote control is pressed.

The screen displays the factory preset programme. In the bottom section of the screen is an information bar showing the name of the programme provider, the time, the timer settings, the programme status and title, provided those details are being broadcast. The LED display indicates the programme's memory location number.

The red standby indicator goes out.

You can now receive the factory preset TV and radio programmes and call them up by pressing the  buttons. Press  (blue) and  to select radio programmes. Press the blue  button again to return to the TV programmes.

For details of how to save additional TV and radio programmes, refer to the "TV/Radio Programme Lists" section.

Please check the time is correct according to whether you are on Summer or Winter time.

When you switch on, the last reception status set is always restored.



Power Failure Safety

After a power failure, the receiver automatically powers up, obtains the time from the reception signal and then returns to standby. This preserves the timer settings.

Error Signalling

If the message “Weak signal or no signal” appears on the screen as well as the display for the last programme received, check the installation of the system and/or the receiver settings. If this only affects individual programme slots, there may be an interrupted signal from the programme provider or a fault in the reception system (cable or satellite system).

First of all, check the connection configuration and whether the default receiver settings are correct for your system. In case of doubt, consult a specialist engineer.

Initial Setup

Receiver Presetting



Your receiver is factory pre-programmed to receive the ASTRA (19° East/28°East) and HotBird satellites, as well as Eutelsat 10E and 16E, TurkSat 42E, Telecom 5W and 8W, and others. You do not normally need to make any additional settings. If you are not connected to a communal system, you will need a multifeed arrangement with at least two LNBS in front of the satellite dish in order to receive multiple satellite systems. Consult your specialist dealer on this.

Before you change the basic settings of your receiver, write down the settings on the form provided at the end of this operating manual. You will then be able to restore the original settings at any time.

On Screen Display (OSD)

Important On-Screen Displays

The receiver functions are controlled by a microprocessor and comprehensive software. The following explanations are intended to improve your understanding of all procedures and to minimise the risk of mistakes.

Help Function

You can call up help for each menu or menu function. This help function provides you with a brief description of the most important functions of the selected menu options. For example, access the main menu by pressing **MENU**.

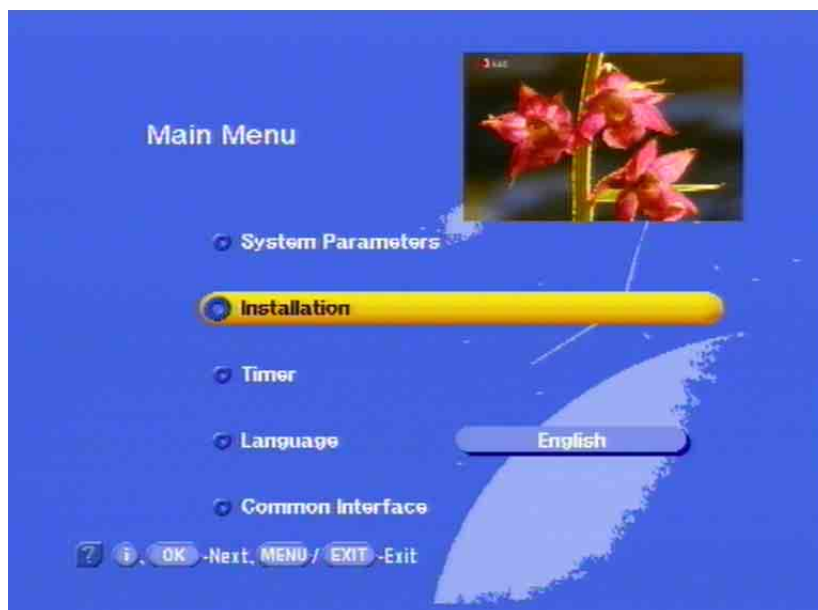

You can now view the help display for the "Installation" option by pressing **i**.



Pay attention to the bar at the bottom of the on-screen display! It provides guidance on what to do next.

You will find detailed descriptions of the selected menu items in the relevant sections of the operating manual.

On Screen Display (OSD)

Press **EXIT** to quit the help function and return to the main menu. Press **EXIT** again to return to the original programme you were receiving.

TV Channel Identifier



The channel identifier is displayed for a few seconds each time you change the programme or constantly if you press the **i** button. The **i** indicates that a channel is being received even if no picture can be seen (e.g. radio). The TV symbol indicates a TV channel - adjacent to it is the selected programme, whether Videotext/Teletext is being received, and the current time. The + on the third line indicates the programme selection from the master list. If the Favourites list is selected, the "apple" symbol appears here. This is followed by the programme title, the start and end time of the current programme, and the next programme, if this data is being transmitted.

Radio Channel Identifier

The message for the set radio channel has the same layout. A radio receiver symbol in the top left-hand corner indicates that it is a radio channel.

Error Signalling



"Weak signal or no signal" indicates that an error has occurred in the reception system or in the receiver settings, or that the transponder is not sending. The channel identifier shows a satellite antenna instead of the **i**. Check the Sat IF connection and the LNB configuration. The list of service settings at the end of this manual can be used to help you do this.

On Screen Display (OSD)

TV/Radio Channel List



Press the **OK** button to access the channel list.

At the top left is a + for the complete list. Information about the channel, the programme provider, and whether the programme is currently encrypted, is shown in the column underneath. In the upper right-hand column are details of the satellites received, the transponder and its frequency, and the polarisation. The desired programme can be chosen using the bar cursor or by entering the relevant number and is then confirmed by pressing **OK**.

In the bottom right-hand corner you will find the “Programme/Channel Settings” menu. The factory settings for programmes and channels can be changed here.

Press the

FAV button (red) to save the channel shown as a favourite channel

PP button (green) to lock the displayed channel

OPT button (yellow) to move the channel to another position

TVR button (blue) to delete the displayed channel from a position

Press **+** to add a new channel

Press **MODE** to select the programme mode of the programme list.

Always follow further instructions or press **EXIT** to quit.

For more information refer to the “Programme Selection” section.

Videotext (Teletext)



This symbol in the programme display shows you whether Videotext/Teletext is broadcast for the selected programme.

When you press the **TEXT** button, the receiver processes the broadcast Videotext/Teletext service for your TV set to display, even when the signal is encrypted.

During the search, the programme page (here P100) which is being searched for is displayed in the top left-hand corner, and the permanent time display is shown at the top right.



When the search is finished, the Videotext/Teletext being broadcast by the relevant programme provider appears:

The individual pages can then be opened using the number buttons. During the search, a white star flashes in the top left-hand corner of the screen.

Press **EXIT** or **TEXT** to exit the Videotext/Teletext.

Channel List

This section describes how you select TV programmes with your receiver and how you can set the desired volume.

The description of the functions assumes that the receiver has been properly connected.

If you wish to connect up the receiver yourself, please read the "Connection and Setup" section first.

Selecting a TV Programme

Reception Status

The following information describes how to select other programmes and what the on-screen displays look like.

To select additional TV programmes in ascending or descending order in the programme memory, simply press the  buttons after turning on the receiver.



Every time you press the button, an on-screen display shows you the selected programme together with the time, the programme start and end times and the programme title on an info bar, provided the relevant data is being broadcast.

You can permanently show or hide this info bar by pressing the  button.

Encrypted programmes are indicated by the message "Encrypted channel":



To view these programmes you will need an authorisation card - a PCMCIA card or Smartcard - from the Pay TV provider (see "Common Interface" section).

The CA module and Smartcard are not included in the supply package.

Channel List

A further option for selecting a different programme is to press the **OK** button. The TV channel list is then displayed. The top right-hand column provides information relating to the satellite being received, the transponder and its transmission frequency, the polarisation, the symbol rate and the encryption. The left-hand column shows the programme location and name, the type of signal being received (FTA/encrypted), the favourites, and any locked channels.



Pay attention to the bar at the bottom of the on-screen display! It provides guidance on what to do next.

Press the **▲▼** buttons to move to the next programme, and use the **◀▶** buttons to jump to the next or previous page.

You can also select a programme by entering a number.

Press the **EXIT** button to exit the programme list and return to the programme already selected.

Selecting a TV Programme by Number

You can select a different TV programme while a programme is running by entering the new programme's location number. Use the number pad buttons **1** to **0** to enter the programme locations.

Example:

You want to select "DSF" at location number 15 (the order of TV programmes is fixed in the programme memory, so this only serves as an example).

To select this programme, press the numbers **1** and **5** one after the other. The receiver waits for about two seconds for input of the next number.

Do not input leading zeroes in front of the number. The 0 button is reserved for switching to AV mode.

The procedure for all other programmes - including those with three- or four-digit location numbers - is exactly the same.

Channel List

Switching to a Radio Programme

You can switch from a TV programme to a radio programme

by pressing the blue  button.

The receiver switches to the last radio programme selected. The on-screen display relating to the programme is shown, just as for a TV programme. The LED shows a small “r” together with the programme's location number. You can return to the TV programme by pressing the same button.

All the functions, such as the channel list, work in the same way in radio mode as in TV mode.

Common Interface



Follow the instructions given by your Pay TV provider.

The Common Interface for insertion of two so-called Conditional Access modules is located underneath the front flap.

The Smartcard sold by the Pay TV provider, specific to a particular encryption technology, is inserted into the CA module. The card is not included in the receiver package.

The cards and modules are issued by the respective Pay TV providers, and contain the subscriber data and details of the programmes for which the subscriber has paid. These programmes are always encrypted.

Contact the Pay TV provider if you are interested in subscribing to a particular Pay TV channel.

You alone are responsible for use of the cards.

Keep the card and the associated PIN code in a safe placing when not in use.

When you turn on the receiver, the following message appears:



A CA module must be inserted for the message to appear, however.

You can find out which card is inserted in the Common Access module by selecting "Common Interface" from the main menu and confirming by pressing **OK**.

The screenshots below depend on the specific module and card, and so are only intended as examples.

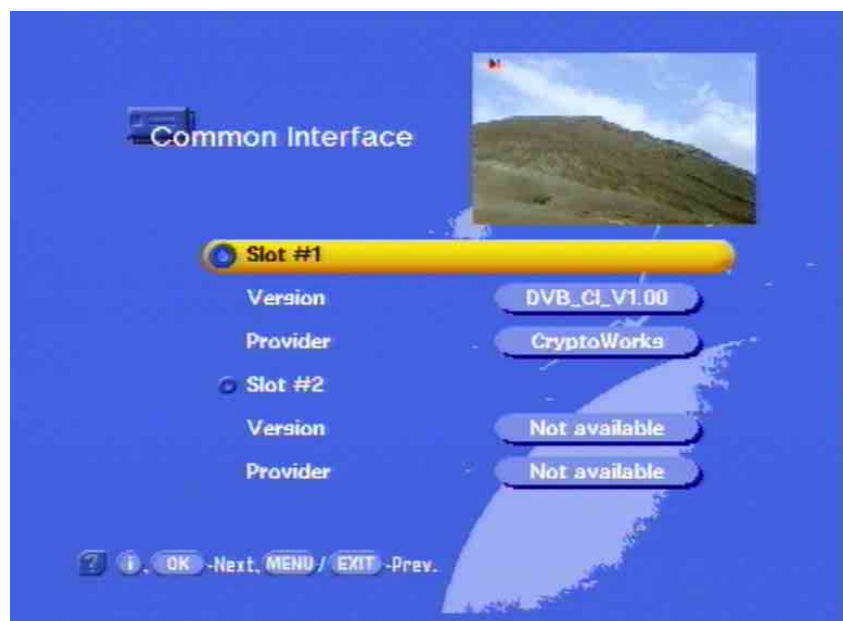

Press **OK** to access a menu generated by the module.

Common Interface

From this menu, your card and your PIN code allow you to access various programmes from your Pay TV provider.



“CryptoWorks” has been selected as an example here. The details may vary for each CA module.

The displays appear in English, even if you have selected German as the menu language for the receiver.



Please always follow the instructions supplied by your Pay TV provider.

Information for Conax, SECA, Viaccess and CryptoWorks users:

Note that with monthly activation intervals, the programme providers have different procedures for activating Pay TV cards. Activation may therefore be a few days before or after the beginning of a new month. During this activation period, the CA module and card must be in the slot, and the receiver must be turned on a set to the booked Pay TV channel. Follow the instructions from the Pay TV provider.

For monthly subscription extensions, the card can be re-initialised by way of the CAM "CAM Re-initialisation" menu.

If your Pay TV card is then still not enabled, we recommend you briefly withdraw the CA module with the card out of the slot, with the receiver switched on, and then re-insert it.

This information has nothing to do with the properties of the unit; it is merely intended to assist you.

Twin Functions

The UFD 580 is equipped with two tuners, enabling you to perform two separate functions at the same time,

including:

- Picture-in-picture (PIP)
- Time-shift and
- One-touch recording.

Picture-in-Picture (PIP)

The picture-in-picture function permits simultaneous viewing of two programmes. This allows you to see when a programme you want to watch begins without having to leave the programme you are currently watching.

When you press the green  button the first time a window opens up in the top right-hand corner. The channel is indicated underneath the picture:



You can then change programme in the main picture with the  buttons.

The programme displayed in the PIP window can be changed with the  buttons.

Press the  buttons to swap the main picture and PIP programmes.



Twin Functions

Press the green  button a second time to view a picture played back from the hard disk in the PIP window:

- A picture currently being recorded is framed in red.
- A previously recorded picture is framed in yellow.



The picture caption is prefixed by an H (for hard disk) and the serial number.

Press the green  button again or the  button to exit the PIP function.

Time-Shift

The time-shift function is described in the “Hard Disk Recorder” section. Note that the receiver switches to hard disk mode when executing this function.

One-Touch Recording

One-touch recording is described in the “Hard Disk Recorder” section. Note that the receiver remains in TV mode when executing this function.

TVTV EPG and Timer

The **tvtv** EPG is a latest-generation Electronic Programme Guide replacing the existing EPG and the timer menu. It provides all the EPG information for around 60 TV channels at no charge, without you having to change programme, and also offers schedule information up to a week ahead (depending on programme provider).







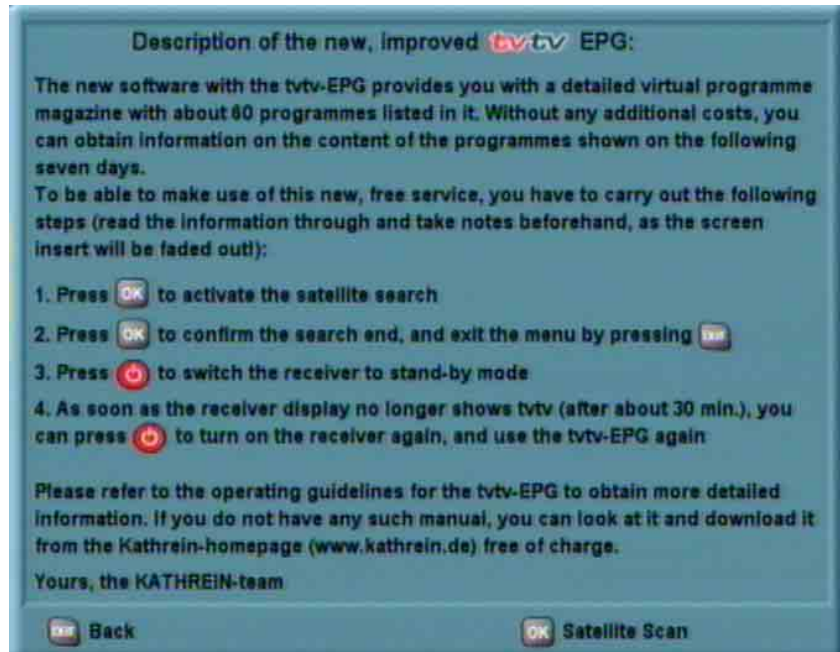

Accessing the TVTV EPG for the First Time

Press  to access the **tvtv** EPG. The first time you access it (and following a factory reset) you see the following on-screen display:



To ensure the functionality of the **tvtv** EPG, the satellite scan for the ASTRA satellite (**with multifeed reception: for “All satellites”**) must be run. This process downloads the necessary signal identifiers for the **tvtv** EPG (SID, TSID and OID).



Press  to switch to the “Satellite search” menu. Use the arrow buttons (, , , ) to navigate around the menu items and select options. Confirm your selection and start the scan by pressing . When the search is finished press . Press  three times to quit the menu and return to the normal TV picture. Then press  to switch the receiver off. The front panel display indicates:



As soon as the display no longer indicates **tvtv** you can switch the receiver back on by pressing the  button and begin using the **tvtv** EPG. The **tvtv** display is usually shown for about 30 minutes. The download may take anywhere between 20 and 60 minutes, however, depending on how much data is waiting to be transferred from the **tvtv** to the receiver.

TVTV EPG and Timer

Accessing the TVTV EPG

The **tvvtv** EPG is accessed by pressing the  button, and automatically displays the “Current” (Now showing) view (see “Current” menu item), regardless of which **tvvtv** EPG view you had been in beforehand.

“Current” View

The **tvvtv** EPG automatically displays the “Current” (Now showing) view when first accessed, highlighting the current selected channel and the current programme.



In the main window you see the channel number at the left, the channel name and current programme in the centre, and a progress bar at the right.

In the top right-hand corner of the picture you see the current day, date and time. The box at the right indicates the day, date and duration of the programme, the programme category (in the example: "Series"), the programme's country of origin and the year it was made.

The bottom section of the display contains the **tvvtv** EPG options selectable from any EPG view. Press

 (red) to view the recording schedule (“Timer list”),

 (green) to view the “Current” (Now showing) display,

 (yellow) to view the “Programme list” (of the selected channel),

 (blue) to view the daily highlight tips (one tip per day, a week ahead),

 to view details of the selected programme, and

 (red) to access the Record menu (the timer).

TVTV EPG and Timer

You can scroll line-by-line or page-by-page through the channels using the arrow buttons (▲▼◀▶) or access channels directly using the number pad.

Press **OK** to confirm a change of channel.

Press **▶** to view the upcoming programme schedules in 15-minute blocks. Press **◀** to return step-by-step to the start point (current time), or press the green **PIP** button to go back directly.

Quit the EPG by pressing either **EPG** or **EXIT**.

Programme List

Press the yellow **OPT** button to access the schedule for the programme to which you are currently tuned in the **tv tv** EPG. The following display appears (example):



Page-by-page scrolling using the **◀▶** buttons can be very useful in locating data several days ahead, as it is very fast!

You can scroll line-by-line or page-by-page through the programme list of the selected channel using the arrow buttons (▲▼◀▶).

Press the **◀▶** buttons to switch channels and then view the new channel's programme list.

The **i** symbol next to the programme title indicates programme details are available to view (see "Det. inform.").

Press the red **●** button to place your selected programme in the Record menu (see "Record").

TVTV EPG and Timer







Highlights

Press the blue  button in the **tv**tv EPG to view the daily highlight tips. The following display appears (example):



A tip is shown for each day, up to a week ahead.

Programmes Sorted by Category

You can use the   buttons to view the following programmes on the Highlights menu by category (e.g. Series, Sport, New, Magazine/Reportage, Kids ...). Within each category you can scroll line-by-line or page-by-page as usual using the arrow buttons (, , , ). Press the red  button to place your selected programme in the Record menu (see "Record").



TVTV EPG and Timer

Search Function

The "Search" function of the **tv**tv EPG allows you to search through all the information available to the **tv**tv EPG (programme name, description, title, cast, director, details) for a word or phrase you enter, with the results being displayed in a list.

From the "Highlights" menu use the $\leftarrow \rightarrow$ buttons to go to the "Search" function. You can use the number pad to input letters in the search form. The assignment of letters to the number pad buttons is displayed at the bottom of the screen as follows:



Use the $\leftarrow \rightarrow$ buttons to enter a space or to delete the last letter entered. Press OK to start the search.



The results found are displayed at the left in the main display box. If the programmes found do not fit on one page, you can scroll page-by-page as well as line-by-line as usual using the arrow buttons ($\uparrow \downarrow \leftarrow \rightarrow$). Press 0 to start a new search.

This function is useful if you are looking for programmes about the country you are going to visit on holiday, for example.

TVTV EPG and Timer

Details

Press **i** in the **tv**tv EPG to call up details on the selected programme. The information is only available if the **i** symbol is displayed next to the programme title. The symbol only appears once you have selected the channel and programme by highlighting it with the yellow cursor bar in the various views of the **tv**tv EPG however.

When you press **i** the following display appears (example):

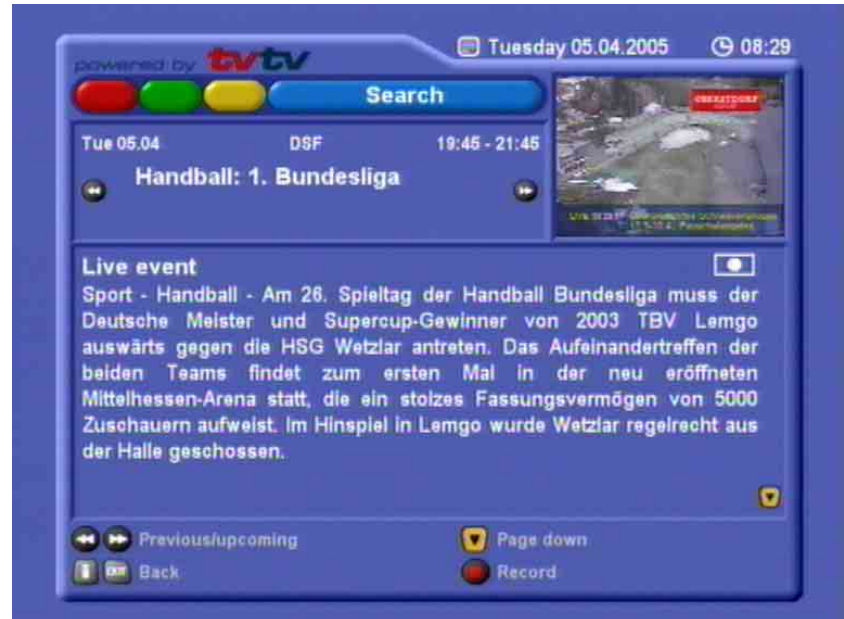

Use the **↓**/**↑** buttons to switch pages in the programme details. The third page displays the upcoming episodes.



TVTV EPG and Timer



You can use the buttons to switch to the details on the next programme in the selected view. Press to return to the previous display, such as the programme list.

Programming a Recording



If no EPG data is available for the channel you selected:

In the "Current" view select the channel for which you want to programme a recording and press the red button. As there is no EPG data, you must enter the data (date, start, end) manually. Use the arrow buttons (, , ,) and number buttons to make your input.

Press to save your settings.

You can programme a recording from the various views of the **tv**tv EPG ("Current", "Program list", "Highlights" and "Det.information" [Details]) and from within their various submenus.

Programming is pre-configured for two SAT IF input signals. If you are operating the receiver in Loop mode ("LNB 1 Loop out" output on "LNB 2 in" input), this may cause problems when two programmes are recorded at once (if both programmes are not transmitted on the same transponder).

Use the arrow buttons (, , ,) to select the programme you want and press the red button. The following display appears (example):



TVTV EPG and Timer



When recording to hard disk the signal is **not** forwarded to the VCR Scart socket!

When recording on a VCR or DVR, also note that most digital TV signals do not include a VPS signal.

This means you must programme your external video recorder or DVR in line with the timer record settings.

You now have a number of options to programme your recording. The settings are made using the arrow buttons (▲▼◀▶) and the number pad:

- Recording status (once, daily, weekly, user-defined, series) - selected using the ◀▶ buttons
- Date (advanced day-by-day) - selected using the ◀▶ buttons
- Start time (advanced minute-by-minute) - selected using the ◀▶ buttons or entered directly using the number pad
- End time (advanced minute-by-minute) - selected using the ◀▶ buttons or entered directly using the number pad
- Recording on (hard disk or external recorder, e.g. video recorder) - selected using the ◀▶ buttons.

In user-defined recording you can use the ◀▶ buttons to move to the various days of the week and press **OK** to activate and deactivate them.

Note:

The timer data and settings of a programmed recording cannot be altered once entered! To change a timer entry you must delete it and create a new one.

Press **OK** to save the selected recording data.

Example of user-defined recording:



TVTV EPG and Timer







Example of series recording:



Note:

If every edition or episode of a series is programmed to be recorded using the "Series recording" function, the tvtv EPG locates the series in question in the updated schedules and automatically programmes recording of them. A change in the time the series is broadcast is no problem for the tvtv EPG, as its programming is based on the series title. This does, however, mean that the schedule change needs to have been notified prior to the last update of the tvtv EPG.

Timer List

The timer list (recording schedule) is accessed by pressing the red  button. The timer list shows all the programmed recordings. You can use the   buttons to toggle back and forth between the master timer list and the "once" and "series" displays. You can scroll line-by-line or page-by-page through the timer list using the arrow buttons (   ).



TVTV EPG and Timer



In the box at the bottom right of the screenshot above you see the day, date and time of recording and the recording mode. If two recordings overlap, the fact is indicated in the box at the bottom right.

Note:

Overlaps of series (timer) recordings are displayed in orange in the box at the bottom right (see screenshot above) and in the master list view (bottom screenshot on previous page). The programmed timer recordings will not be recorded - the overlaps must be eliminated manually!

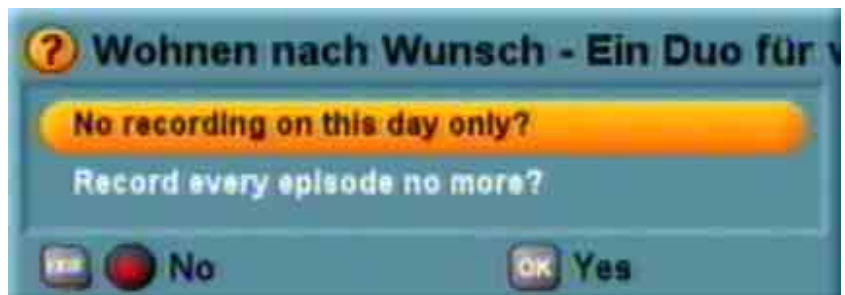

You can delete a programmed timer recording by pressing the red button. If it is a (recurring) series recording, you are additionally asked whether you want to delete all the programmed recordings of this series (in the example below: "Record every episode no more?") or merely the specific recording selected ("No recording on this day only"). Press to confirm, or press to cancel.



TVTV EPG and Timer













Important Additional Information



- If a satellite scan is carried out or programmes supported by the **tv tv** EPG are moved around the programme list, the change is only visible in the **tv tv** EPG following an update. To update, the receiver must be switched to standby mode (**tv tv** appears on the display). As soon as it disappears from the display the **tv tv** EPG is updated.
- The  button does not become active until 15-20 seconds after the picture appears on the TV.
- The **tv tv** EPG' update is only started if no timer recording is programmed within the next hour.
- The **tv tv** EPG is broadcast over the ASTRA satellite at the frequency of 12,603.75 MHz, with a symbol rate of 22 MSymb/s and horizontal polarisation (18 V). If you have accidentally deleted the transponder at this frequency, you will need to start a new satellite and transponder scan for the ASTRA satellite (see "Satellite Search").
- If a factory reset is performed, the information contained in the **tv tv** EPG is also deleted. To restore the data required for the **tv tv** EPG, you must run a satellite scan and then switch the receiver to standby mode to update the **tv tv** EPG data. As soon as the **tv tv** disappears from the receiver display the **tv tv** EPG is updated.
- Digital-compatible single-cable solutions, such as "Technisat DisiCon 4 LNB", do not permit transmission of the **tv tv** EPG data, because the necessary transponder (12,603.75 MHz, symbol rate 22 MSymb/s, horizontal) is not transmitted in that system. This transponder must not be deleted, as the **tv tv** EPG data is transmitted on it.
- The **tv tv** EPG data is buffered on the hard disk, meaning the hard disk is running even during normal SAT reception. Its running noise is much less than in recording or playback mode however. In addition, the hard disk emits a short noise every 10 minutes indicating an essential data balancing operation. This is quite normal, and does not need to concern you.
- At present it is only possible to scroll forward from the "Current" (Now playing) views in the **tv tv** EPG in 15-minute blocks; it is not yet possible to access days ahead by a quick and easy route.
- To do so, press the  button to access the "Highlights" view and use the arrow buttons to select the daily highlight tip displayed on the date you are looking for. You can now press the  button again to switch to the "Current" view and you will then see the data for the day you want.

TVTV EPG and Timer

Key to Symbols

Symbol	Explanation
	Widescreen format
	Programme broadcast in black-and-white
	Dolby Digital 5.1 is a sound transmission method enabling digital surround sound to be reproduced on a home cinema system
	Dolby Surround
	Subtitles for the hard-of-hearing
	Mono
	Stereo
	Two-channel sound (e.g. multiple languages available)
	Daily highlight tips
	Programme details
	Recurring programme recording (series)
	Programme scheduled for recording

TVTV EPG and Timer

Channel List

The channels in the table below are provided with **tv tv** EPG data on Kathrein receivers as at February 10, 2005.

The assignment of the channels below to the **tv tv** EPG may change at any time!

3sat	MDR Television	SF1
ARD Das Erste	MTV Central DE	SF2
ARTE Germany	MTV2 Pop	Sky News Intl
ARTE France	N24	Super RTL
ATVplus	NDR Television	SW Television B-W
BBC World	Neun Live	SW3 (Saarland)
Bloomberg TV Ger	n-tv	TELE 5
BR Alpha	ORF 1	TRT-Internat'l
BR3	ORF 2	TV Berlin
CNBC Europe	Phoenix	TV5 EUROPE
CNN Internat'l	Premiere Start	TW1
DSF	ProSieben	VIVA
Eins Extra	QVC GERMANY	VIVA Plus
Eins Festival	RAI Uno	VOX
Eins Muxx	RBB Television	WDR Television
Euronews DE	RNF PLUS	XXP TV
Eurosport Germany	RTL 2	ZDF
hr television	RTL shop	ZDF documentary channel
HSE24	RTL Television	ZDF info channel
Kabel 1	RTP Internac'l	ZDF theatre channel
Kika	SAT.1	

To obtain the **tv tv** EPG data for the "SF1", "SF2" and "TRT-International" channels (received over HOTBIRD 13° East) in addition to the other channels listed above, you must also perform the essential satellite scan described on page 2 for the "HOTBIRD 13° East" satellite.

However, as you initially only have the possibility to run the scan for one or all satellites, you must select the "All satellites" option (taking around 1 hour).



If you have already started the scan for the "ASTRA" satellite alone, you will not see this scan prompt. You can still run the scan for the "HOTBIRD 13° East" satellite too, though, as described in the "Satellite Scan" section. You do not need to perform a factory reset!

Hard Disk Recorder

Recording and Watching TV

The two tuners and the hard disk of your twin-DVR Sat receiver offer you a range of possibilities to receive different satellites as well as to record and play back programmes.

The following table shows you which recording and playback options you have for each tuner input setting.

You will find the "Tuner input" submenu by pressing the  button. Then select "Installation", "LNB configuration", and confirm the satellite you are receiving by pressing . You can make the settings here,

LNB Configuration - Overview

Recorder \ Tuner	Tuner input			
	#1	#2	Loop	#1 & #2
Record and view <u>one</u> programme from a transponder in a polarisation plane	✓	✓	✓	✓
Record <u>one</u> programme and view <u>an additional</u> programme from <u>a single</u> transponder in a polarisation plane	✓	✓	✓	✓
Record <u>one</u> programme and view <u>one</u> of the programmes from <u>different</u> transponders in <u>one</u> polarisation plane				✓
Record <u>two</u> programmes and view <u>one</u> of the programmes from two transponders in <u>two</u> polarisation planes				✓
Record <u>two</u> programmes and view <u>one</u> of the programmes from <u>two</u> transponders and in two polarisation planes				✓
Simultaneous playback of a recording	✓	✓	✓	✓

To proceed correctly:

For "#1", tuner 1 must be connected to the antenna system. This applies, for example, to a satellite dish with a single LNB or a single-cable system.

For "#2", tuner 2 must be connected to the antenna system. This applies, for example, to a satellite dish with a single LNB or a single-cable system.

For "#1 & #2", connect each single input to a port of a two-cable system.

Hard Disk Recorder

You can allocate one or more satellites to each tuner (provided you have a DiSEqC™ system).

In the “Loop” setting, you must connect one tuner output to the input of the other.

The setting you select for “tuner input” will depend on your reception system. In case of doubt, consult your specialist dealer so that you can use your receiver optimally.

Recording

Your receiver also enables you to record encrypted programmes (with or without a CAM and Smartcard).

For playback, the CAM and Smartcard must be inserted. Encrypted recordings are identified by a \$ sign in the hard disk contents.

In order to convert an encrypted recording into an unencrypted recording, the relevant take must be selected in the hard disk contents and started by pressing the  button.

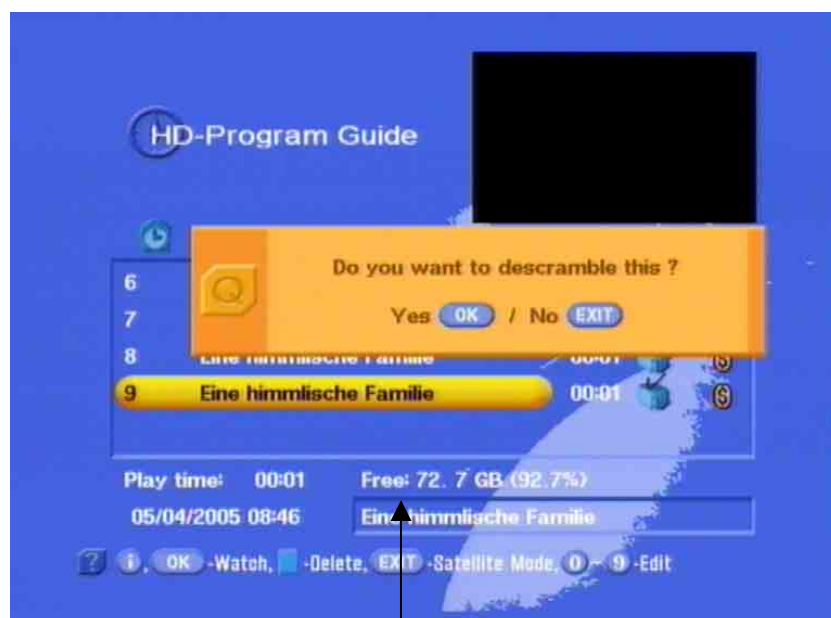

Hard Disk Capacity

Please check that there is adequate hard disk capacity available before every recording! Press  to view the hard disk contents (programme guide) and the available hard disk capacity.

Hard Disk Recorder

Time-Shift Recording

If you cannot catch the beginning of a programme because you are occupied with something else, you can watch the programme in time-shift mode. You can start recording the current programme you are watching by simply pressing the **⏸** button. The receiver switches to hard disk mode.



The red “T” in the info bar indicates time-shift recording. You see a freeze-frame image while the recording is running in the background. For a short time “R” flashes at the top left of the TV screen and the red standby LED on the front panel of the receiver flashes.

To start time-shifted playback, press the **▶** button. You can control the recorder fast forward, rewind, pause and playback functions with the corresponding buttons. When you press the **⏸** button the TV picture freezes, but the recording continues in the background. Press **⏸** again to resume.

You can hide the control console by pressing **EXIT**.

You can also view a current programme. To do this, stop playback by pressing the **⏹** button and quit hard disk mode with the **EXIT** button. You will be asked if you want to stop the recording. Press **EXIT** again to switch to TV mode without interrupting the recording.

Hard Disk Recorder





One-Touch Recording (OTR)

You can record an encrypted programme even if no CAM or Smartcard is inserted!

With your twin-DVR Sat receiver you can immediately record the current programme to the hard disk at the press of a button. All you need to do is press the red  button. During recording, the red standby LED on the front panel of the receiver flashes, and "R" (or 2 x "R" if two recordings are being made) flashes in the top left-hand corner of the screen for a few seconds.

Note:



If you want to start recording within the first five minutes of the programme you will need to press the red  button again and check that the end (stop) time is correct. If required, you can enter the stop time in half-hour increments using the   buttons or directly using the number pad. Press  to save the change.

Recording is automatically stopped after switching EPG or after two hours at the latest.

You can still select all other programmes.





If you press the  button, you will see the recording status and can stop the recording process (see below).







Using the screenshot above, you can also check the recording status without having to interrupt the recording. The stop time is indicated at the right of the top bar. Press  to return to the full screen without stopping recording.





Press  to view the hard disk contents.

Note:

If you press the  button at this stage of recording, a second - time-shifted - recording is started! You can stop that recording by pressing  and  or by pressing .

You can stop recording by pressing  and . You can then delete the programmed recording by pressing  and .



Hard Disk Recorder

If you want to immediately lock in a running recording, all you have to do is select the hard disk contents with the  button, select the relevant recording (from two possibilities) with the   buttons and then confirm with the  button.

Timer Recording

For information about recording by means of a timer, please refer to the “Programming a Recording” section under “TVTV EPG”.

The timer begins recording at the pre-programmed time.

All hard disk functions are active during the timer recording. This means playback can be started in time-shift mode, even when recording has already begun. The recording can only be stopped with the standby button () or the  button – the “HD programme guide” menu appears – or by pressing  and the suggested button.

After the end of the set time by the timer, the receiver automatically switches to standby.

Simultaneous recording of two programmes and playback of a recording is possible!

As soon as the recording and playback options are exhausted, the following display appears:

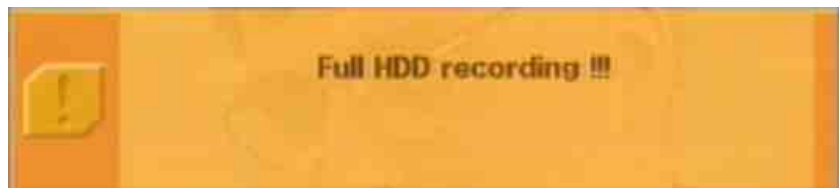

Stopping a Recording



If two recordings are running at the same time the PIP function is not possible!



After the time either preset by the EPG or entered by you elapses the recording automatically stops. The “HD programme guide” menu appears. Press  to return to the original programme.

Important: If you are already recording two programmes, you can only see the programmes that are on the transponders being received! You can easily search for other programmes without interrupting the recording.

You can, however, play back a programme that you have already recorded (see “Playback”)!

You can also stop the recording yourself. To do this, press the  button and the “HD programme guide” will appear. If you press the  button again you will be asked if you want to stop recording. Confirm your choice with the relevant colour button or quit the prompt screen by pressing .

Hard Disk Recorder

“Recording cancelled” then appears on the screen, and the HD programme guide remains displayed. The programme which was being recorded up to this point appears at the end of the list. Press **EXIT** to restore the normal TV picture.

Do the same for a single recording!

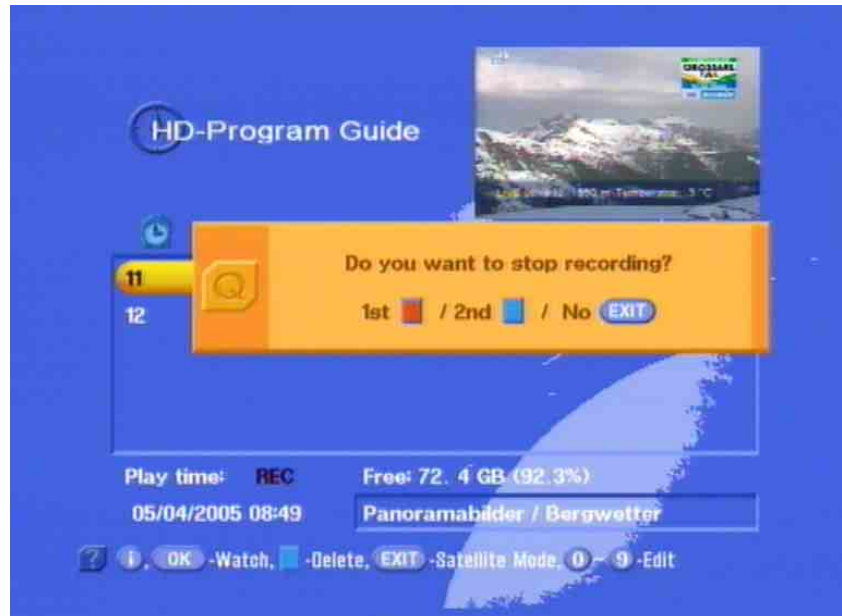

or

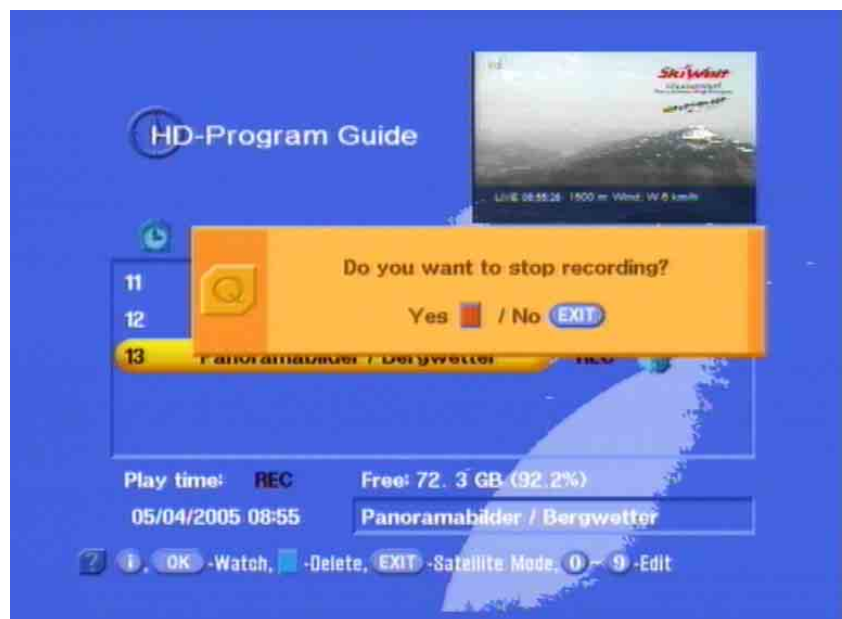

Special Functions

Further “control console” functions are available during the recording. To access them, just press **MENU**. Use the arrow buttons to find the menu you want and select the following functions:

Hard Disk Recorder

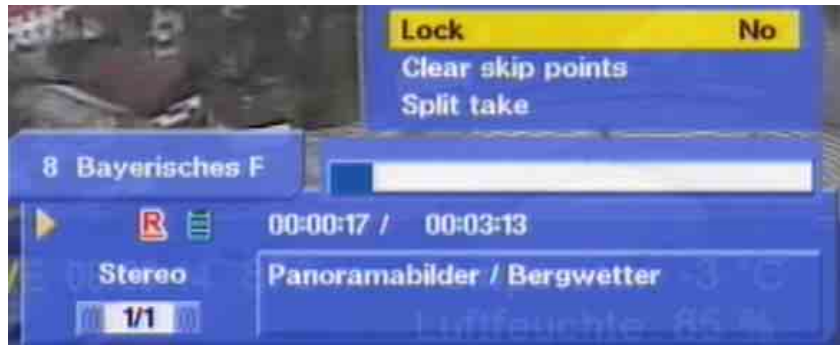

- Lock Yes/No Parental control On/Off Playback is locked (protected by password)
- Clear skip points No function during recording
- Split take No function during recording

The functions can be set with the arrow buttons.

Split Take

You can split a recording at any point during playback. Move the cursor bar to the “Split take” option using the **▲▼** buttons and confirm with **OK**. The recording take is split, and now appears twice in the hard disk programme guide with different running times.

Playback and Recording

To switch to an already recorded programme without stopping the current recording, you can use the **▲▼** buttons to place the coloured bar on one of the previous recordings in the “HD Program Guide” and select it for full-screen playback by pressing **OK**.

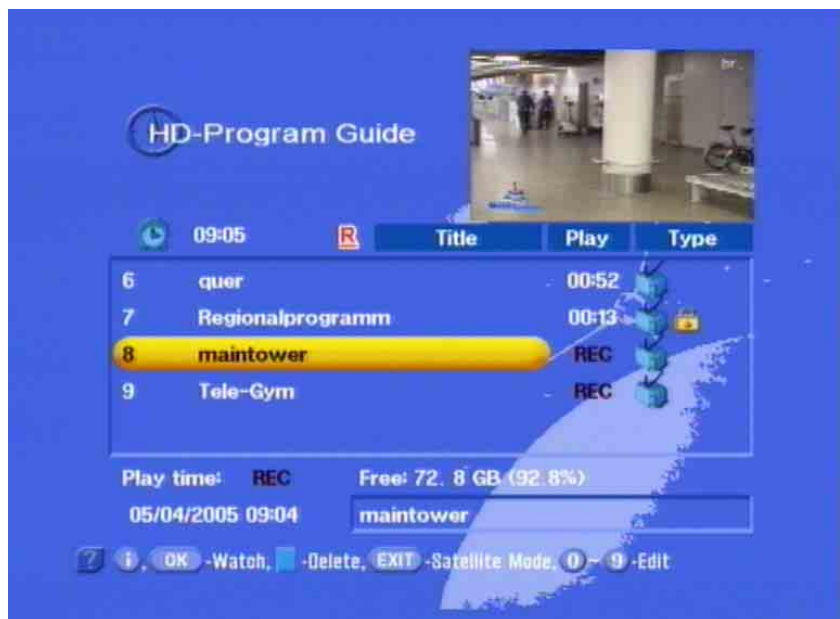

The “REC” flag to the right of the programme title indicates that this programme is being recorded.

Hard Disk Recorder



While you are watching a pre-recorded programme, the previously selected programme continues to be recorded.

For capacity reasons, only 400 single recordings are possible on the 80 GB hard disk.

When started by EPG, the recording time automatically stops five minutes after the end of the programme titles (see page 44).

Without EPG, the recording time is automatically pre-programmed at two hours. Changes can be made using the or by entering numbers.

If the hard disk is full, recording stops.

Fast Forward/Fast Rewind (no picture)

To forward or rewind the receiver rapidly without viewing the picture in playback mode:

- Press during playback of the recorded programme to access the control console and press the pause button .
- You can then press (rewind) or (fast forward) to rewind or fast-forward with no picture (the longer you hold down the button the faster the speed becomes).
- Use the and arrow buttons to jump to the end or back to the start of the recording.

Playback

To play a recording from the hard disk, press the button. The “HD Program Guide” appears with a list of the recordings saved to the hard disk. If there are no recordings stored on the hard disk, a message is shown telling you so.



With the buttons, you can select a currently running or previous recording and start the playback by pressing . The recorder plays the recording you selected. “h****” appears on the LED display.

Hard Disk Recorder

The asterisks stand for the recording number. At the end of the playback, the receiver switches back to the “HD programme guide”.

If you are recording at the time, the display remains “REC 1” or “REC 2”.

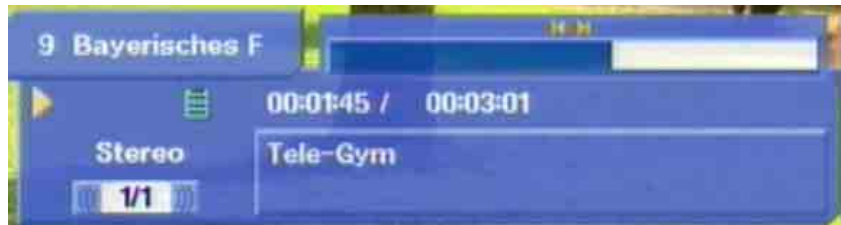

Drive functions can be accessed with the following remote control buttons:

- ◀ = Visible/time-controlled rewind
- ▶ = Visible/time-controlled fast forward
- ▶ = Normal playback
- ⏸ = Freeze-frame; with ◀ or ▶ freeze-frame or picture-by-picture (only if control console is not displayed; if control console is displayed advances 10 seconds at a time!)/unlock with ⏸
- ⏹ = Hard disk programme guide is displayed; playback is stopped; with **OK** playback is resumed
- ⦿ = 4-speed slow-motion during playback
(red button)

The symbol for the current function is displayed in the bottom left-hand corner of the screen.

During playback, you can get all necessary information by pressing the **OK** button. At the top left of the bar the programme being played back is indicated. To the right of it, a progress bar indicates how much of it has been played back so far.

The symbol for the current selected playback function appears at the left, and next to it the current playback time and total duration are displayed.

Important! The 4-speed slow-motion function cannot be selected when the control console is displayed on the screen during playback.

Hard Disk Recorder

Setting Index Marks (Skip Points)

During playback and with the control console displayed (opened with the **i** or **OK** button), index marks (skip points) can be set and can then be displayed above the time bar by pressing the **⊙** button. This function is used to skip specific parts of a recording (from the beginning marker to the next end marker) during the next playback, so as to cut adverts out of films for example.

Note:

*You cannot set index marks as long as the small control console pop-up (opened with the **MENU** button) is on display. Also, you cannot set index marks at the end of a recording!*

Further control console functions can be displayed during playback. To access them, first press the **i** or **OK** button (to open the control console), then the **MENU** button.

If there is a block of adverts at the end of your recording which you want to remove, you must use the "Split take" function. The split portions of the recording will be saved to the hard disk separately. You can then delete the second part of the split (the block of adverts) from the hard disk in the same way as you would delete any other recording. To do this, place the time bar at the start of the last block of adverts and execute the split by navigating to the "Split take" command using the **▲**/**▼** buttons and confirming with **OK**.



- Lock Yes/No Parental control On/Off
Playback is locked (protected by password)
- Clear skip points Clears all index marks
Recording is split at the current position (e.g. when recording two programmes one after the other)

The individual functions can be set with the arrow buttons.

Hard Disk Recorder

Index marks can be cleared in pairs by running a scan to navigate to them and pressing the  button.

Time-Shifted Playback

During a running recording, you can call up and replay scenes from the running programme as it is being recorded (see below) or play the entire programme time-shifted while it is still running, by pressing the fast-forward or rewind button.

See also "Time-shift".

Audio Mode







The audio mode is set with the yellow  button. In our "control console" example, stereo mode (S) is set. Above it, audio mode "2 Ch" specific to the programme location is displayed, and "5.1 Ch" for Dolby.

All sound variants are recorded with the reception signal, so you can then select them during playback (yellow button).

Search

See "Playback" section, under "Drive functions can be accessed with the following remote control buttons":

Delete

To delete a recording, access the "HD programme guide" by pressing the  button. Use the   buttons to select the recording you want to delete and press the blue  button. You will then be asked if you really want to delete the recording. Confirm with  or press  to cancel.



A deleted recording cannot be retrieved!
Recordings cannot be deleted during recording!

Audio Settings

Setting the Volume



Set the required volume level by pressing the  button on the remote control of the receiver. A bar indicator is displayed on the screen to show the set volume.

Muting





Press  to mute the sound. A red bar indicator appears.

Press the button again to restore the sound.

Stereo and Two-Channel Sound Playback

Use the yellow  button to open the Audio menu for sound and language selection, where you can make the desired settings, e.g. subtitles, language selection (soundtrack), audio mode, digital output (MPEG stereo, AC 3), as long as they are included in the reception signal:



Select the menu options using the   buttons and make the desired setting using the   buttons. Press the yellow  button again to exit the menu.

Possible audio settings include:

Soundtrack	1 of 2	2 of 2
Audio mode	Stereo	Mono left or right
Digital Output	MPEG stereo	Dolby Digital/AC 3

AC 3



Be sure to follow the instructions in the manual for your Dolby Digital system.

The receiver has an electrical/optical audio output for AC3 format (Dolby Digital). This gives you the opportunity to bring cinema quality sound into your living room. The AC 3 sound is recorded and can be selected during playback. Connect the corresponding digital audio output to a Dolby Digital system.

If no AC3 signal is received, you can only make the normal stereo or mono settings, and choose the broadcast languages.

Programme List

Favourites

The programme/channel settings made in the factory can be changed in the "Channel List" menu. Access the menu by pressing the **OK** button.

You can organise and sort your preferred TV and radio programmes, such as all English-language programmes or those that broadcast with no commercial breaks. These programmes are marked with the "apple" symbol in the "TV" and "Radio" channel lists, which you can access by pressing the **OK** button.

Pay attention to the bar at the bottom of the on-screen display! It provides guidance on what to do next.



The bar can be scrolled line-by-line or page-by-page using the **▲▼** and **◀▶** buttons to select the desired programme. Or you can also enter the desired programme number using the number pad buttons.

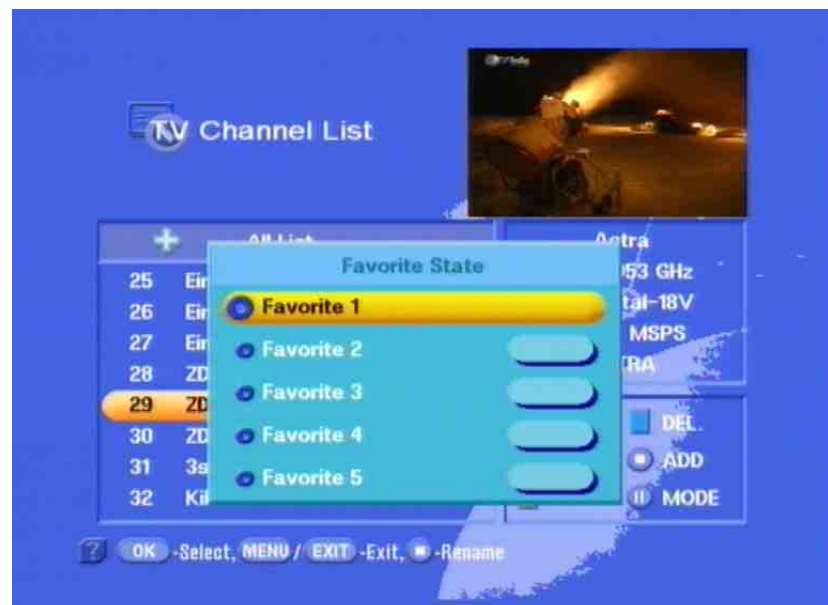

Press the red **FAV** button to access the Favourites list selection.

Using the **▲▼** buttons, you can select a Favourites list from 1 to 5 where you would like to save your favourite programmes. It is possible to save several different programmes in a list.

Programme List





Each family member can then save their own favourite programmes and call them up at any time. Entering a password allows you to protect the programmes against unauthorised use (see "Password" section). The currently selected list is highlighted by a coloured bar. The selected programme appears in the top corner of the screen.

You can then press the red  button to flag the highlighted line with the "apple" symbol.

The next programme from the programme list is automatically selected and appears on the small screen in the top right-hand corner. You can then flag your next favourite programme with the "apple" symbol.





You can assign names to the individual Favourites lists, to arrange movie or sports channels together under Favourites list 1 for example. You can also enter the relevant user's name (such as Peter, Karen, Grandma, Grandpa).



Generating a Favourites List





Press the  button to access the channel list. Press the red  button to call up the "Favorite State" (Favourites status) display. Use the   buttons to select a Favourites list. It is highlighted by a coloured bar:



Pay attention to the bar at the bottom of the on-screen display! It provides guidance on what to do next.

Press the  button to activate the input mode. The first letter is highlighted. You can now rename the Favourites list as you wish using the number pad buttons and the   buttons. Press   to move to the other Favourites lists and change their names likewise.

When you have completed the input by entering all the letters, confirm it by pressing . You are returned to the channel list. Press  again to return to the TV screen. You will see a message confirming that your changes have been saved and the info display for the current programme being received will appear on the screen for a few seconds.

To call up a favourite programme, access the channel list, press the  button, select the desired Favourites list using the   buttons and press  to confirm.

Programme List



Then use the **▲▼** buttons to select your desired programme, which is highlighted by a coloured bar and displayed in the top right-hand corner of the screen. Press **OK** to view your selected favourite programme.

To delete a marking, press **OK** to select the Favourites list containing the programme you want to unmark and clear the “apple” symbol by pressing the red **FAV** button.

To return to the channel list (listing all the programmes from the configured satellites) press the **OK** button and then press **⏸** for “Channel List Mode”. First use the **▲▼** buttons to select the “Satellite” line, and with the **◀▶** buttons select “All satellites”. Press **OK** to access the current channel list.

Alphabetical Channel Search



Pay attention to the bar at the bottom of the on-screen display! It provides guidance on what to do next.

You see an alphabetical listing of programmes. This makes it possible to locate a specific programme from the full programme list very rapidly.

Programme List

Press **OK** to access the channel list.

Press **II** to launch "Channel List Mode".

Use the **▲▼** buttons to select the "Alphabet" line.

Use the **◀▶** buttons to scan the alphabet for the first letter of the entry you are looking for:



Press **OK** to confirm the selected letter, and a list of all the programmes beginning with the letter appears.



Use the **▲▼** buttons to choose your channel, which is then highlighted by a coloured bar. The channel preview appears in the top right-hand corner of the screen. Press **OK** to confirm your selection. The programme appears on the screen.

To return to the channel list (listing all the programmes from the configured satellites) press the **OK** button and then press **II** for "Channel List Mode". First use the **▲▼** buttons to select the "Satellite" line, and with the **◀▶** buttons select "All satellites". Press **OK** to access the current channel list.

Programme List

Sorting Programmes

You can sort the programmes to meet your own requirements. Sorting involves moving entries around the channel list.



Pay attention to the bar at the bottom of the on-screen display! It provides guidance on what to do next.

Press **OK** to access the channel list:

Use the arrow buttons (**←** **↑** **↓** **→**) or the number pad to select the programme you want to move. The line with the current running programme is highlighted in the list by a coloured bar, and the programme appears in the top corner of the screen.

Press the yellow **OFF** button to lock on to the programme you want to move. The lettering in the bar turns red. You can now move it to the desired position. Press the yellow button again to place it at its new location.

Press **EXIT** to exit the programme.

The change is confirmed and is displayed for a few seconds on the screen. The relocated programme appears on the screen and is now stored at its new location in the channel list.

Programme List

Deleting Programmes

The procedure is similar to the method of sorting programmes.

Press **OK** to access the channel list:

Use the arrow buttons (**←** **↑** **↓** **→**) or the number pad to select the programme you want to delete.

Press the blue **TV** button to confirm the deletion.

The control programme asks:

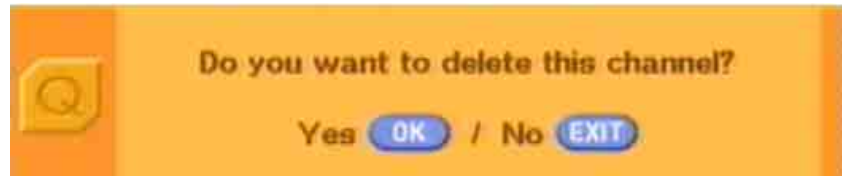

Confirm your answer by pressing the relevant button.

Press **OK** to delete the programme location. The change is saved and confirmed, and the programme from the next programme provider in the programme list appears on the screen.

Manually Adding Programmes

The procedure is similar to the method of adding programmes.

Press **OK** to access the channel list.

Press the **+** button (plus) to display the menu for adding a programme.

Pay attention to the bar at the bottom of the on-screen display! It provides guidance on what to do next.



Important! You can only select satellites that are included in the Installation menu.



Here you can make the entries for the new programme or enter the available data.

The first line in the list is highlighted with a coloured bar.

You can use the **↑** **↓** buttons to move the bar up or down to the desired item.

Programme List

The entry is made using the ◀▶ buttons and the number pad buttons.

You can set:

- the satellite being received,
- the transponder and transponder frequency,
- the polarisation and
- the symbol rate.

The following items:

- Name,
- Video PID (Programme Identification),
- Audio PID,
- PCR PID (PCR = Programme Clock Reference)

will only accept alphanumeric or decimal entries.

Incorrect PID entries are rejected.

Press **OK** to access the channel list. You will see a message confirming that your changes have been saved and the info display for the current programme being viewed will appear on the screen for a few seconds. The new programme is added to the existing channel list.

You can obtain the necessary PIDs from relevant magazines or the Internet, as well as from the SAT 1 Videotext (Teletext) service. Refer to "Operating Instructions" section for information on how to make alphanumeric entries.

Never change the PID information without good reason as they affect identification of the reception signal.





This function is only necessary for programmes which are not broadcast according to the DVB standard. All programmes that comply with the standard are recognised and saved by the automatic search.

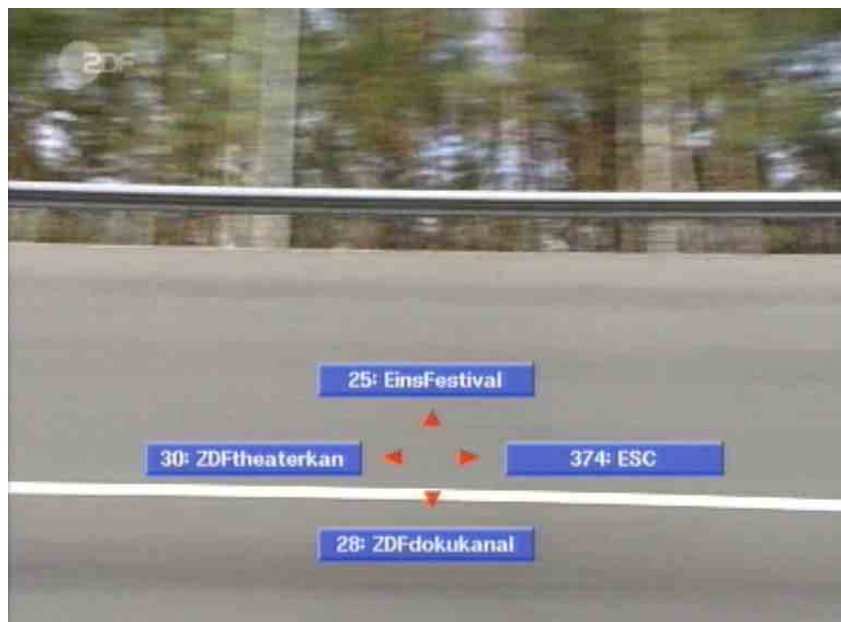

Programme List

Selecting the Last Programmes Received



By pressing the red  button the last four programmes received (that were selected for at least 10 seconds) are displayed on the screen. The arrows shown correspond to the arrow buttons (   ). These buttons can then be used to select the relevant programme.

Password

You can use a password to lock your satellite receiver against unauthorised access by third parties. This protects the receiver against changes to its reception settings by unauthorised persons. At the same time, you can activate a child protection function (parental control), which bars selected programmes.



Keep your password in a safe place, so that you always have access to your programmes should you ever forget it.

Factory Default

The password is set to "0000" in the factory and is inactive.

Entering the Password

Press **MENU** to access the main menu.

Press **▲▼** to select "System Parameters" and confirm with **OK**.

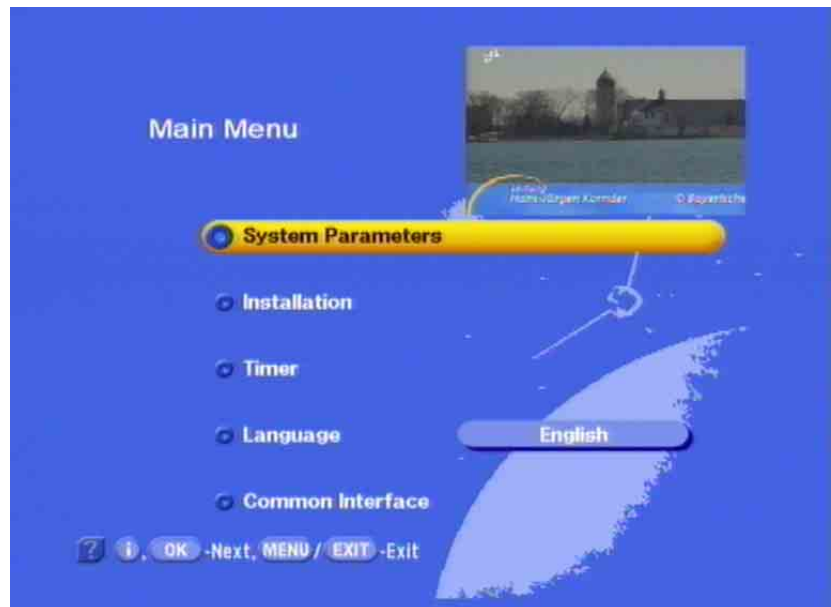

Pay attention to the bar at the bottom of the on-screen display! It provides guidance on what to do next.

Now press the **▲▼** buttons to select the "Parental Control" function, and confirm by pressing **OK**. If you have set a password, you will be asked for it:



Password



You can make the following settings here:

Age Limit: This setting is only effective if the corresponding lock-out signals are transmitted.

Lock Channel Editing: Yes/No. With this option, you can lock or unlock the editing function for programme lists.

Lock Installation: Yes/No. With this option, you can lock or grant access to the installation menu.

New Password: Here you can enter your (new) password using the number buttons.

Verify Password: Here you enter your (new) password again, using the number buttons, to confirm it.

Personal: Here you enter the receiver identification which is displayed when the receiver is turned on. This is useful for identification in case of theft. Refer to the "Operating Instructions" section for information on how to use the number pad buttons on the remote control for alphanumeric input. The factory default setting is "Twin-DVR receiver".

This completes all the settings to secure and identify your satellite receiver.

If you have forgotten your password, you must contact your dealer, who will be able to unlock your receiver for you.

Password

Parental Control

Similarly to marking your favourite programmes with the “apple” symbol, you can set up a child lock to prevent unauthorised access by children. The programmes are marked with the “padlock” symbol in the “TV” or “Radio” programme list.



Press **OK** to access the TV channel list.

Select the programme you want to lock using the **▲▼** and **◀▶** buttons.

You can move the bar page-by-page or line-by-line with the **◀▶** and the **▲▼** buttons.

The selected programme is highlighted by a coloured bar.

Confirm the selection with the **green** **PP** button (Lock), and the “padlock” symbol appears in the bar.

You are automatically taken to the display for the following programme in the programme list.

Press the **green** **PP** button (Lock) to lock another programme, or return to the locked programme with the arrow buttons and press the **green** **PP** button (Lock) again to cancel the lock. The “padlock” symbol disappears.

Press **OK** to save the change. Then the following programme in the list will appear and the info display will be shown for a few seconds.

Password

When the locked programme is selected using the number buttons or the channel list, the message "Channel is locked" appears and the programme cannot be viewed. You are asked to enter your password in order to view the locked programme:



Using the Front Panel

If you have misplaced your remote control, or if the batteries are empty, you can still operate your receiver from the front panel.



Backup Operation



There are six buttons on the front panel:

On/Off; Menu; Select; and the horizontal and vertical arrow buttons.

The unit is switched on and off with the On/Off button.

The menu button, like the  button, brings you to the main menu.

The vertical arrow buttons have the same function as the   buttons and bring you to the submenus.

The horizontal arrow buttons have the same function as the   buttons.

The select button has the same function as .

Because there are no number buttons, no password-protected functions can be called up.



Setting System Parameters

You should not change the following settings without a good reason, as they are factory settings or operating settings that are tailored to your reception system.

New settings are only required if the reception system is changed.

The selected menus, sub-menus and positions, as well as the parameters to be set, are each highlighted in colour. The menus are self-explanatory to a great extent.

Help for the selected item is available by pressing the **i** button. Press **i** again to exit the help.

Pay attention to the bar at the bottom of the on-screen display! It provides guidance on what to do next.

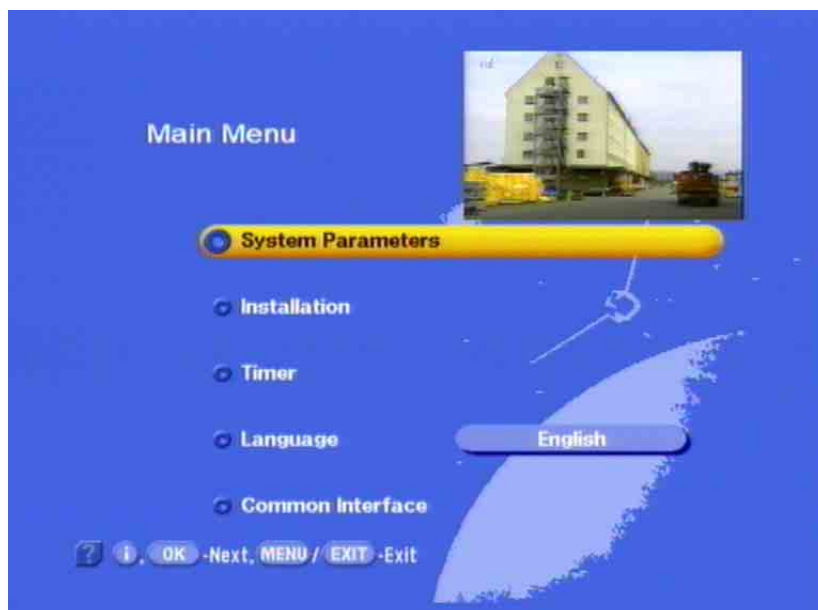

The main menu, which is always accessed with the **MENU** button, consists of the following submenus:

- System Parameters
- Installation
- Timer
- [Menu] Language
- Common Interface

Setting System Parameters

System Parameters

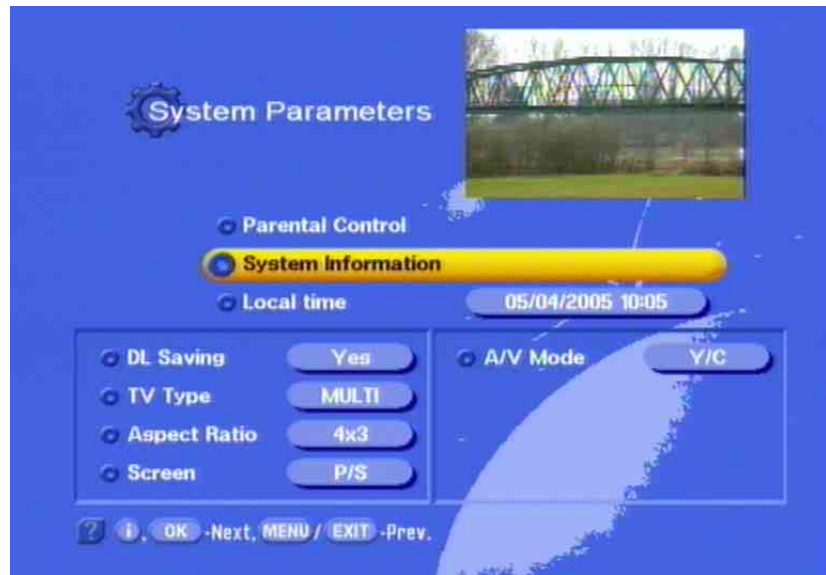

Select the "System Parameters" menu with the **MENU** button, the **▲▼** buttons in the main menu and **OK**. Use the **◀▶** buttons to select the further items.

Parental Control

The basic settings which can be made here are described under the parental lock setting information in the "Password" section.

System Information

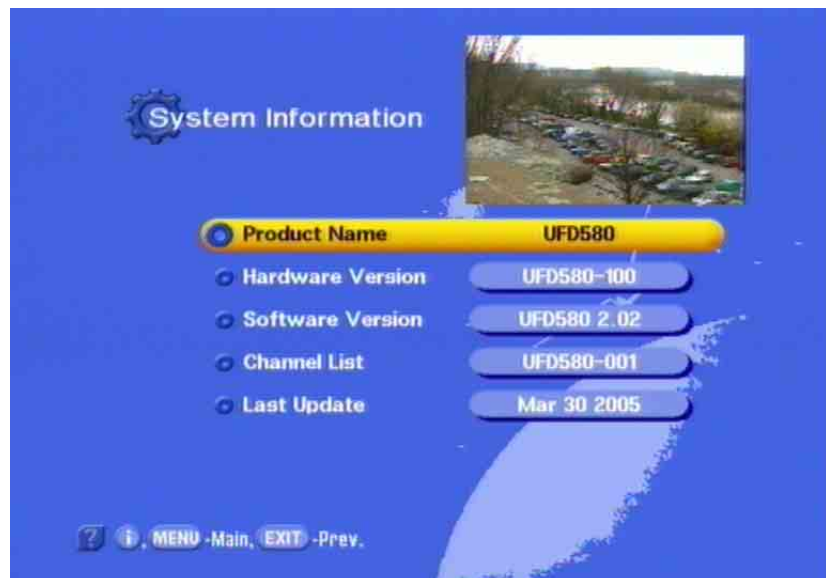





Under the "System Information" menu item, you will find the factory settings, which cannot be altered and are intended solely for service personnel. Press **EXIT** to return to the "System Parameters" submenu.

Local Time/Timer

With the factory setting, the receiver indicates the "UTC" (Universal Time Coordinate, previously Greenwich Mean Time) transmitted with the data stream. For Germany, the time must therefore be corrected by +1 hour.

Setting System Parameters

The summer time should be corrected as necessary in order for the timers to turn on and off at correct times.

You can correct the time yourself in 30 minute increments using the   buttons. To do this, move the cursor bar to the "Local time" item using the  button. Press  twice to end your input. The receiver saves the new setting.

When you subsequently switch the receiver off, do so from the remote control - not at the mains switch, otherwise the settings will be lost.

TV Type

Here, you can use the   buttons to specify whether your TV set is a

- PAL,
- multi-standard or
- NTSC

set.

Press  twice to confirm.

Aspect Ratio

Here, you can use the   buttons to select the type of picture format for which your TV set is designed. Either

- 4:3 format or
- 16:9 format or
- Auto

Press  twice to confirm.



Screen

Here, you can use the   buttons to select the type of screen display.

- Conventional (P/S) = standard representation for 4:3 sets or
- Letterbox display – This setting enforces the widescreen format for a 16:9 set.

Press  twice to confirm.

A/V Mode

Here, you can use the   buttons to select the type of video signal at the Scart socket. Select the signal that your TV set can process.

Refer to the operating instructions for your television set!

- Composite colour – composite baseband signal
- RGB – Red/Green/Blue signal or
- Y/C – S-VHS signal (luminance/chrominance)

Press  twice to confirm your selection.

Adding/Removing Satellites

Satellite Setup

New satellites can of course also be added to the LNB configuration. To do this, you must know the orbit position you need to aim at. The "Antenna Setup" item on the installation menu can be used as an aid in aligning the antenna.

Pay attention to the bar at the bottom of the on-screen display! It provides guidance on what to do next.



To access the "LNB Configuration", press **MENU** for the main menu, use the **▲▼** buttons to select the "Installation" submenu and confirm with **OK** (also entering your password, if activated). Press **OK** to select "LNB Configuration", and you can enter or select a new satellite.

Note that your system must be configured accordingly!

In the next step, use the **▲▼** buttons to move to the "User1" entry for example. After pressing the **◀▶** button, you are asked if you want to add the satellite.

Note:
In two-cable systems the tuner input must be set to "#1 & #2". The DiSEqC™ settings must match the installed reception system.
In single-cable reception select the tuner input used.
Set Loop when the output of tuner #1 is connected to tuner input #2 or vice versa.



Confirm with **OK**.

The following message appears:

Adding/Removing Satellites



You can now make the entries in the relevant items according to your reception system using the **◀▲▼▶** buttons. Press **EXIT** three times to exit the menu. The new transponder data is saved.

Entering a Satellite Name

You can change the satellite name in the “LNB Configuration” menu using the number pad buttons. For information on how to do this, refer to the “Operating Instructions” section.

Removing Satellites

To remove a satellite, open the main menu by pressing **MENU**, select “Installation” with **OK**, select “LNB Configuration” with **OK** and use the **▲▼** buttons to move the cursor bar onto the satellite you want to remove. After pressing **◀▶**, you are asked if you want to remove the satellite, and can confirm or decline the prompt.



Pay attention to the bar at the bottom of the on-screen display! It provides guidance on what to do next.

Installation Menu

You should not change the following settings without a good reason, as they are factory settings or operating settings that are tailored to your reception system.

New settings are only required if the reception system is changed or expanded.

Select the "Installation" menu with the **MENU** button, the **▲▼** buttons in the main menu and **OK**. If a password has been stored, you must enter it. Use the **▲▼** buttons to select the further items.

LNB Configuration

Pay attention to the bar at the bottom of the on-screen display! It provides guidance on what to do next.



The first submenu is the "LNB Configuration". Press **OK** to open it. You should not normally make any changes in this submenu.

Before making any changes, however, you should make a note of the settings in the form provided at the end of this manual. Your receiver is preset at the factory to the satellites of the ASTRA and HOTBIRD systems.

The other basic settings are shown in the screenshot above.

Oscillator Frequency L.O.

Satellite reception systems consist of a parabolic antenna attached to the actual reception system (LNB - Low Noise Blockconverter or LNC - Low Noise Converter), which converts the RF signal from the satellite into a lower frequency that can be processed by a satellite receiver.

The satellite transmission frequencies are located in the following ranges:

10.7-11.7 GHz	Low band
11.7-12.75 GHz	High band

Installation Menu

However, the input frequency range for the receiver is in the range 950 to 2150 MHz. The high frequencies are therefore converted into a lower frequency using the oscillator frequency (LO frequency/ L.O. = LNB local oscillator). Different oscillator frequencies are used for the conversion depending on the satellite frequency range and the system type.

For ASTRA and EUTELSAT reception systems, this is normally 9.75 GHz (9750 MHz) for the lower frequency range (low band) and 10.6 GHz (10600 MHz) for the upper frequency range (high band). Older reception systems still use a 10 GHz oscillator frequency in the low band range (which is not normally suitable for digital reception).

The receiver generates the frequency to which it needs to adjust by subtracting the oscillator frequency from the satellite transmission frequency saved for each programme. You only have to set the oscillator frequency used by your reception system. Before changing the LO frequency, you must therefore ascertain whether this is actually necessary.

The oscillator frequencies listed above are the factory settings.

Changing the Oscillator Frequency

Press **OK** to move to the right-hand section of the LNB configuration menu. The setting for L.O. High is highlighted in colour. You can now use the number buttons to enter a new frequency appropriate for your system. Use the **▲▼** buttons to select L.O. Low and do the same.

Press **EXIT** four times to exit the menu. This saves the set value.

If you make an incorrect setting, you will see the following message:

Weak signal or no signal

Operation

The factory setting is "On".

Under normal circumstances, the supply voltage should be turned on.

Receiving Two Satellites

If your receiver is connected to a multi-feed antenna, which is aligned with the HotBird satellites for example, you must change the receiver settings for the DiSEqC™ signal. This also applies to other satellites as well of course (DiSEqC™ = Digital Satellite Equipment Control).

Different control signals are required to select the satellite signals. To date, the LNB supply voltage of 14/18 V and the 22 kHz signal (superimposed on the LNB supply voltage) have been sufficient for signal selection for most applications. These four switching signals allow you to switch between the horizontally and vertically polarised signals and between two satellites (multi-feed reception).

To extend the frequency range to the 12 GHz range (high band) or for reception from more than two satellites, additional control signals are required for LNB actuation and signal selection.

The DiSEqC™ signal is responsible for this. This is a special modulation of the existing 22 kHz signal.

Installation Menu

DiSEqC™ Setting



The precondition for this setting is that you have not made any changes in the DiSEqC™ (UFO) setup; refer to the “DiSEqC™ UFO Setup” section.

When you are in the LNB Configuration menu (see above), press the buttons to move the coloured bar to the “HOTBIRD” item. Press the or button and to confirm that you want to add a satellite. The transponder data is now stored and a tick appears after “HOTBIRD” to confirm the setting. You can now set the DiSEqC™ signal. It is used to switch between the two aligned satellites. Press to access the DiSEqC™ 1 setup.

Set #1 for ASTRA and #2 for HOTBIRD. Both positions are pre-programmed. Press four times to exit the menu. This saves the set value. If you make an incorrect setting, you will see the following message:

Weak signal or no signal

With cascaded switches, a total of 16 satellite positions can be stored under DiSEqC™2. H/V and High/Low give a total of 256 possible settings. These settings and the configuration of a system of this kind should be left to a specialist.

Tuner Select

Here you select whether both tuners (IF input) are connected to the antenna system or only one of them. In the “Loop” setting, the reception signal is looped through to the outputs, in order to make it available for other Sat receivers.

Installation Menu

Antenna Setup

This menu is exclusively intended for service purposes and be used to align the antenna in an emergency, if no measuring instruments are available.

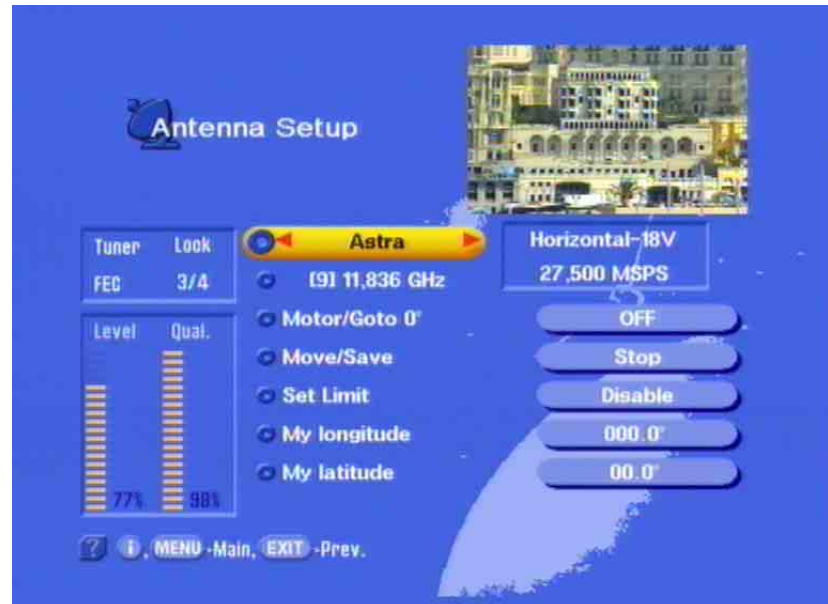

The first line is used to specify the satellite and the second line to specify the transponder.

The polarisation of the received signal and the transmitted symbol rate are shown on the next line.

The bars provide information about the strength (relative level) of the signal and its quality. However, this information cannot be used to draw any conclusions about the quality of the antenna system or the cable connection.

Antenna Rotor/Positioner (DiSEqC™1.2)

For operation with a rotor (DiSEqC™1.2), select “On” on the “Motor/Goto 0°” line.

On the next line, “Move/Save”, you can align the antenna to the east or to the west using the ◀ or ▶ button. Press **OK** to confirm. The optimum setup can be viewed in the "Level" bar chart.

On the “Set Limit” line, you can press ◀ or ▶ to specify the outermost aiming point (limited by a wall or other obstruction) in a westerly or easterly direction.

Always read the operating manual supplied by the rotor manufacturer thoroughly (particularly with regard to settings different to those described above).

Installation Menu

Satellite Scan



In the "Satellite Scan" menu you set the receiver searching for programmes on a satellite. Move to the menu line you want using the **▲▼** buttons. On the first line, press **◀** or **▶** to select whether to scan for only FTA or FTA and encrypted (scrambled) programmes. You can also set one of the registered programme providers, e.g. PREMIERE. Press **◀** or **▶** to set the satellite you want. Then press **OK** to start the scan.

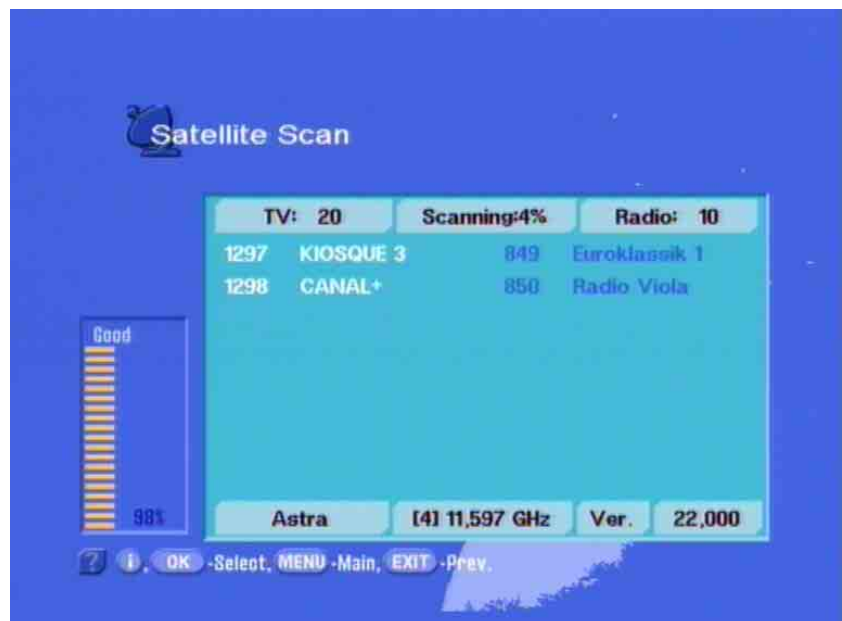

Pay attention to the bar at the bottom of the on-screen display! It provides guidance on what to do next.

If you want to change your system to a completely new satellite, you will need to manually enter at least one known transponder in order to start the scan (see "TP Edit/Scan"). You can obtain the necessary information from the relevant TV and satellite magazines or Internet websites.

During scanning, the signal quality, the scanning progress and the new programmes found are displayed.

Installation Menu

At the end of the scan this message appears:

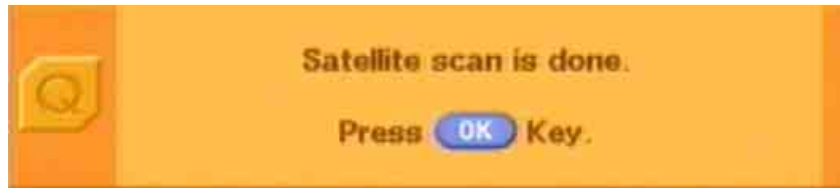

All new programmes are added to the existing programme list and highlighted in a different colour!

You can interrupt the scan by pressing the **EXIT** button.

TP Edit/Scan

In this menu, you can scan through the transponders for specific programmes when, for example, new programmes are offered in the





Pay attention to the bar at the bottom of the on-screen display! It provides guidance on what to do next.









package of a specific programme provider. You can obtain this information from the SAT 1 Videotext (Teletext) service, from TV and satellite magazines, as well as from the Internet. Press **OK** to open the menu.

Installation Menu

Transponder Selection

The following settings are now possible (select items with  ):



- Select desired satellite with  or .
- Select transponder frequency with  or .
- Select polarisation with  or .
- Select symbol rate with number pad buttons.
- Select scan mode for FTA only or FTA and scrambled programmes with  or .
- Delete transponder (refer to note on page 79).

The bar chart shows the relative signal strength, and is not an indicator of the quality of the reception system.

Start the scan by pressing  from the "Scan" entry.



Press  to exit this menu and skip to the programme highlighted by the cursor bar.

Installation Menu

Press  to return to this menu, where you can search for additional transponders.

If the search is unsuccessful, the following message appears:

Error

All new programmes are added to the existing programme list.

The “TP Delete” option allows you to remove the transponder from the programme memory by pressing . You are asked to confirm before it is deleted.

Important Note on Deleting Transponders



The following transponder must not be deleted, as the **tvtv** EPG data is transmitted on it:

ASTRA, 12,603.75 MHz, symbol rate 22MSymb/s, horizontal

Installation Menu

DiSEqC™ [UFO] Setup

Pay attention to the bar at the bottom of the on-screen display! It provides guidance on what to do next.

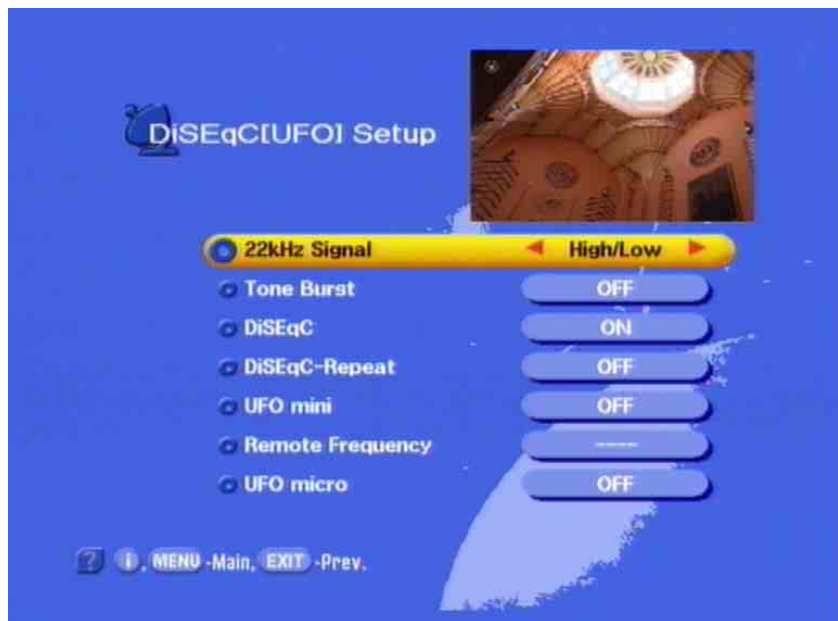

You should only make changes in this menu if the receiver is connected to a different reception system with different properties or if changes have been made to the reception system.

You should therefore carefully follow the instructions for your Sat IF system. However, before each change you should note the settings on the form at the end of this operating manual.

Press **MENU**, **▲**, **▼** and **OK** to access the DiSEqC™ menu.

22 kHz Signal

This menu option is used to specify whether the 22 kHz signal is to be used to switch between the upper and lower frequency ranges for a satellite (low/high) or between two satellite positions.

Tone Burst and DiSEqC™ Signal

If more than four control criteria are required in a reception system, a DiSEqC™ control signal is required.

Which of the setting options - Tone Burst or DiSEqC™ - is required depends on the components of the reception system.

You should therefore refer to the descriptions of the existing components (switching matrices) of the reception system.

Installation Menu

Tone Burst

Here the 22 kHz signal can be set as follows:

Switching states for setting:			Switching states for setting:			Switching states for setting:		
22 kHz Signal → High/Low			22 kHz Signal → Pos. A/B			22 kHz Signal → Pos. A/B		
and			and			and		
Tone Burst → Pos. A/B:			Tone Burst → Opt. A/B			Tone Burst → High/Low		
Low	22 kHz	Off	Pos	Tone Burst	22 kHz	Low	Tone Burst	0
High	22 kHz	On				High	Tone Burst	1
Pos. 1	Tone Burst	0	1	0	Off	Pos. 1	22 kHz	Off
Pos. 2	Tone Burst	1	2	0	On	Pos. 2	22 kHz	On
			3	1	Off			
			4	1	On			

DiSEqC™

If the receiver is connected to a DiSEqC™ switching matrix, set the menu option to “On”.

The switching criteria and the input assignment of the DiSEqC™ switching matrices must be observed. You should therefore follow the description of the switching matrices or contact the engineer who installed the reception system.



DiSEqC™ Repeat

If the receiver is operated in a reception system with two or more DiSEqC™ switching matrices connected in series (cascaded), the DiSEqC™ command must be repeated.

In this case, set the “DiSEqC™ Repeat” menu option to 1 or 2.

Default setting: “Off”

UFO® mini

In a subscriber-controlled processing system, the input frequency of the receiver is a fixed setting. The subscriber-controlled processing system transmits the signals at this frequency. The reception parameters for programme selection are communicated to the reception system by a DiSEqC™ command and set.

The setting that has to be selected depends on the design of the subscriber-controlled processing system.

The setting is made according to the installation instructions for the subscriber-controlled processing system.

Remote Frequency

If you have set the UFO® mini menu option to “ON”, use this menu option to make the setting from the transmission frequency.

The transmission frequency to be set is specified in the installation manual for the subscriber-controlled processing system.

You should therefore be sure to follow the instructions given in the installation manual for the subscriber-controlled processing system.



Installation Menu



UFO[®]micro

The setting for this menu option is also designed for operation of the receiver in a processing system.

The return path of the coaxial cable is used for control and communication between the receiver and the Kathrein UFO[®]micro system. If the receiver is operated in a UFO[®]micro reception system, the "UFO[®]micro" menu option must be set to "On".

The reception system then assigns the receiver a special address upon installation, so that it will recognise the control commands sent by the receiver to the reception system for signal selection.

In this operating mode, a remote frequency does not need to be set, as it is specified by the UFO[®]micro system with the addressing.

If the receiver is being used in a UFO[®]micro reception system for the first time, the address previously assigned must be deleted. This is done under the "UFO[®]micro" menu option by selecting "Reset" with the   buttons and confirming with .

The receiver is then assigned the original factory setting. It then needs to be set to "On" again. The receiver receives its new address from the new system.

"Reset" does not delete the pre-programming.

Default setting: "Off".



Factory Set

Under this menu item, you can reset all the settings to their factory defaults by pressing .

The factory settings do not necessarily correspond to the settings required for your specific system.

You may need to re-enter all the settings following the reset.

Note down the settings on the service page provided at the end of this manual!



Logging on to UFO[®]micro



Important: The receiver must not be connected to the antenna socket outlet prior to logging on!

Procedure (see page 10)

Video Recorder Connection

For details of how to connect your video recorder to the receiver refer to the connection diagram provided at the end of this manual and the instructions for the video recorder.

Recording

In order to make a VCR recording (Record), the satellite receiver must be switched on or the timers must be pre-programmed (see "Timer Settings" section).

Playback

For VCR playback (Play), the satellite receiver must be set to "standby", so that the signal path is switched through from the VCR/AUX Scart socket to the TV Scart socket.

You must set the Scart socket of the Sat receiver to "AUX" with the  button in order for your TV set to automatically play back the picture from the video recorder.



In this setting, the picture from the video recorder is switched through to the TV set during playback.



If you set "SAT" by pressing the  button, the Sat receiver will have priority.



In the "TV" setting, the video signal of the TV set has priority. TV mode is indicated by the green LED on the front panel.

Note:

For system reasons the TV and VCR Scart sockets carry the same signal.

Software and Programme List Update

Thanks to digital technology, you can receive satellite updates of the software and programme list for your receiver. The “Software Download” sub-menu tells you whether new software or programme lists are available. The only prerequisite is that your satellite reception system is aligned with ASTRA 19.2° East.

Press **MENU** to access the main menu, use the **◀▶** buttons to select the “Installation” submenu and confirm with **OK**. Then move the cursor bar to the “On Air Download” menu item and select it by pressing **OK**. Your receiver automatically searches for the ASTRA transponder, which broadcasts the current software and programme list.



If there are no new versions, an on-screen message appears to inform you of this.

The light-coloured cursor bar in “On Air Download” can be moved with the **▲▼** buttons. Press **OK** under the “Display Info” item to get information about the software and programme list being broadcast. The “Display Info”, “Main SW” (operating software and “Ch List” (channel list) options are automatically set to “Yes” if new information and content is available.

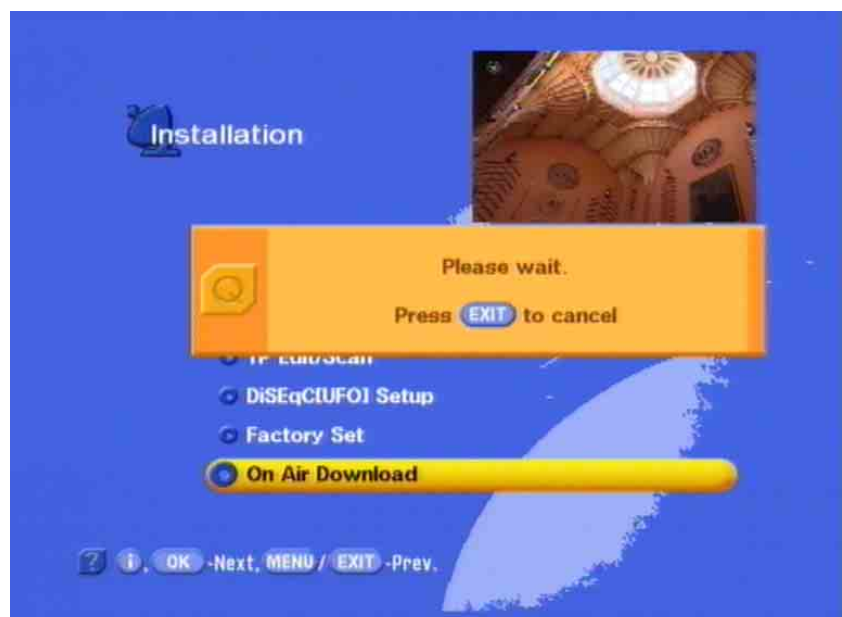

Software and Programme List Update



After the “Display Info” request an on-screen display appears which you should use as a guide.

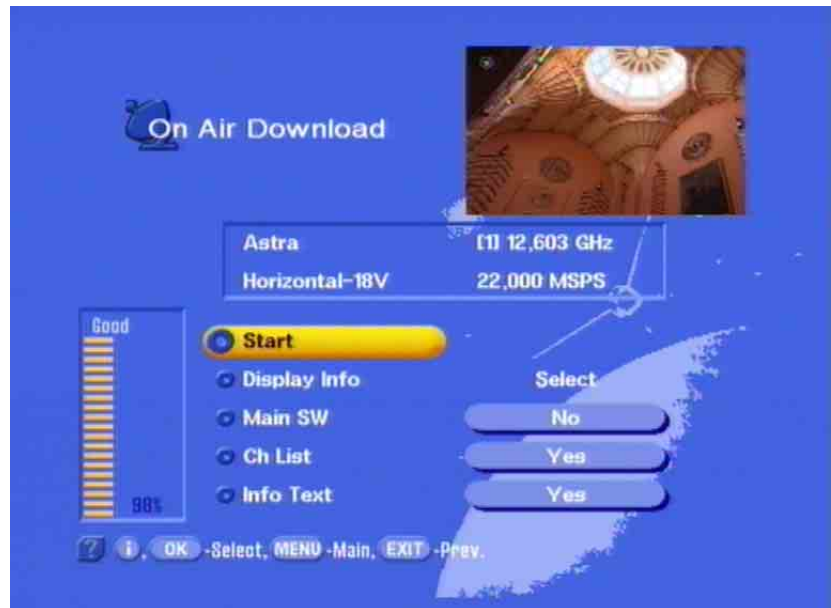

You can move the light-coloured cursor bar using the **▲**, **▼** and **◀** or **▶** buttons to select the item you want to deactivate (No). Items that are already inactive cannot be changed. If you only want to update the software but leave your channel list alone, deselect the “Channel List” field, or vice versa. You can also request “Info Text” only.

To update, move the cursor bar to “Start” and confirm with **OK**. The receiver then begins the update and displays the following message where applicable:

Pay attention to all on-screen displays!

Following a software update you must reset Winter/Summer time as appropriate!

You can also download the updates from the Internet, at:

http://www.kathrein.de/esc-kathrein/englisch/download/ufd/firmware_ufd580.cfm

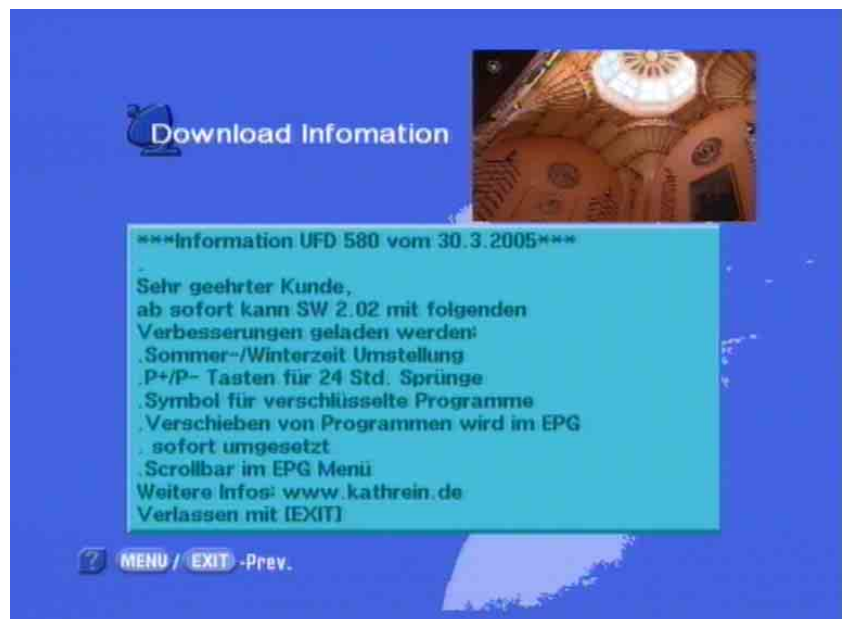

Once the update is complete, the receiver is re-initialised and starts operation again. In case of an error or no signal, the message “Download failed” appears.

Never turn off the receiver during the update process, as otherwise you could lose the entire software. If this happened, the receiver would have to be re-installed at the factory or using a PC and zero-modem cable. During the download “Please wait” flashes on-screen.

Receiver to Receiver Data Transfer

Your receiver is able to receive data from another receiver via its RS232 port. For this, the two receivers are interconnected via a so-called zero-modem cable. The transmitting receiver is the "master", and the receiving receiver is the "slave".

Preparations

The master and slave are first switched to standby mode and then disconnected from the mains by pressing the power switch.

The data ports of the two receivers are interconnected by a zero-modem cable.

The master is then switched on again.

Programme List Download

Simultaneously press ← (left arrow button) and "SELECT" under the front flap of the master to transfer the programme list.

The slave can now be switched on. The transfer begins.

During downloading, the display of the master shows "t001 t002 .. t00n", while the slave correspondingly shows "r001 r002..r00n".

The LED displays "----" during the block transfer.

If both receivers indicate "Succ", the download was successful.

Operating System Software Download

The procedure for downloading the operating system software is the same as that described above.

Start the transfer of the operating system software by simultaneously pressing → (right arrow button) and "SELECT" under the front flap of the master.

During downloading, the display of the master shows "t001 t002 .. t00n", while the slave correspondingly shows "r001 r002..r00n".

The LED displays "----" during the block transfer.

If both receivers indicate "Succ", the download was successful.

If any problems occur in transmission, the master display will show "F * * *", with * representing a numerical value. In such cases, check the cable connection and retry.

The receiver to receiver data exchange as described above must only be carried out between devices of the same type, otherwise malfunctions or total loss of the operating system software may occur.

On no account may the receivers be switched off or the connection interrupted during data transfer. This may result in data loss, malfunctions or total failure of the operating system.

Always wait until the "Succ" or "F * * *" message appears on the display.



Technical Features

The twin-Sat receiver UFD 580 has two separate reception and signal processing paths. This allows you to record a programme and simultaneously zap through other programmes, or to record two different programmes and at the same time watch one of them (either live or time-shifted) or another previously recorded programme.

The following functions are also available:

Reception of digital TV and radio programmes

Common Interface for two CA modules for Pay TV (not included)

Suitable for software updating via satellite or RS232 port

PIP (Picture-in-Picture), optional access across all channels

One-touch recording

Time-shift recording

Loop-through Sat IF input

Videotext/Teletext processing internal and via TV set

4000 programme memory slots

Satellite input frequency range from 2 x 950 MHz to 2150 MHz

tvtv EPG (Electronic Programme Guide with timer function)

USB 2.0 port for hard disk data download

(PC software available from http://www.kathrein.de/esc-kathrein/download/ufd/firmware_ufd580.cfm)

Mains switch with mains power isolation

Automatic date and time setting via DVB data stream

On-screen display (OSD) in 8 languages (Dutch, English, French, German, Italian, Portuguese, Spanish, Turkish)

4-character LED display

DiSEqC™ 1.2 and tone burst control signal

Operation with UFO® *mini* and UFO® *micro*

RS 232 port for data copying

Programme scan and sort functions

Automatic aspect ratio recognition (optional 4:3 or 16:9 picture format)

Volume adjustment and muting

Radio button

Infrared remote control

2 Scart sockets (TV and VCR/AUX connection)

Additional audio outputs via cinch sockets

Electrical and optical output for Dolby Digital data stream output (AC 3)

RF level indicator

Technical Appendix

Technical Data

RF Properties, Tuner 1 and 2

Sat IF frequency range	2 x 950 to 2150 MHz
Input level range	43 to 83 dB μ V *)
IF frequency	479.5 MHz
Reception threshold (EB/NO dig.)	> 4.8 dB
Sat IF input	2x F socket with loop-through output
Input impedance	75 Ω

Video

Modulation, FEC, demultiplexer	DVB-S standard
Video resolution	CCIR 601 (720 x 576 lines)
Frequency range	20 Hz to 5 MHz
Input data rates	2-45 MSymbol/s
Video decoding	MPEG-1/2 compatible
Bit rate	1.5-15 MB/s
Output voltage	1 V _{ss}
S/N	> 53 dB

Audio

Audio decoding	MPEG-1/2, Layer 1 and 2
Bit rate	32/44,1/48 kb/s
Frequency range	40 Hz to 15 kHz
Output voltage	Typ. 770 (TV Scart and Cinch)
S/N	> 65 dB

Memory

Flash RAM	4 MB
SD-RAM	32 MB

Common Interface

2 slots

Hard Disk Recorder

Capacity	80 GB
Recording time	Up to 56 hours*

*Depending on data rate and refresh rate

Power supply

Mains voltage	230 V \pm 10 %, 50 Hz
Power supply	< 35 W
Power consumption in standby	< 3 W
LNB supply voltage	2 x 0, +14 V (vert.), +18 V (hor.)
LNB supply current	2 x 400 mA max.
Control signals	22 kHz square 0.6 V _{ss} , tone burst DiSEqC™ 1.2 UFO® <i>micro</i> UFO® <i>mini</i>

Technical Appendix

Connections

2 Sat signal inputs/outputs (looped-through)	4 x F socket
TV Connection	Scart socket, 21-pin
VCR/AUX Connection	Scart socket, 21-pin
Video/audio output	3 x Cinch socket
Digital audio output	Optical standard fibre-optic socket
	Electrical cinch socket
Digital audio format	Dolby Digital/AC 3 Compressed PCM
	MPEG Stereo PCM
Data port for service	RS 232 Sub D 9-pin/USB 2.0

General

Unit dimensions (W/H/D)	335 x 63 x 280 mm
Weight	approx. 2.75 kg

Temperature range

Ambient temperature	+5 °C to +40 °C
---------------------	-----------------



Technical Appendix

Accessories

- 1 infrared remote control (RC 660)
- 2 batteries 1.5 V, type: LR 03, size: AAA (Micro)
- 1 Scart cable
- 1 operating manual

Scart Socket Assignment

Signal	Connection no.	TV	VCR/AUX
Audio right output	1	X	X
Audio right input	2		X
Audio left output	3	X	X
Audio earth	4	X	X
Blue earth	5	X	X
Audio left input	6		X
Blue signal	7	X	X
Switching voltage	8	X	X
Green earth	9	X	X
Data signal	10		
Green signal	11	X	X
Data signal	12		
Red earth	13	X	X
Data earth	14		
Red signal (C)	15	X	X
Blanking signal	16	X	X
Video earth	17	X	X
Blanking signal earth	18	X	X
Video output (FBAS/Y)	19	X	X
Video input	20		X
Connector shielding	21	X	X

VHS/S-VHS Switching

The Scart sockets are switchable between VHS and S-VHS. The switch is made in the "System Parameters / A/V Mode" menu.

VHS (**RGB**):

The RED signal is connected to terminal 15, the Composite Colour output to terminal 19.

S-VHS (**C/Y**):

The C output is connected to terminal 15, the Y output to terminal 19.

Technical Appendix

Connection Example

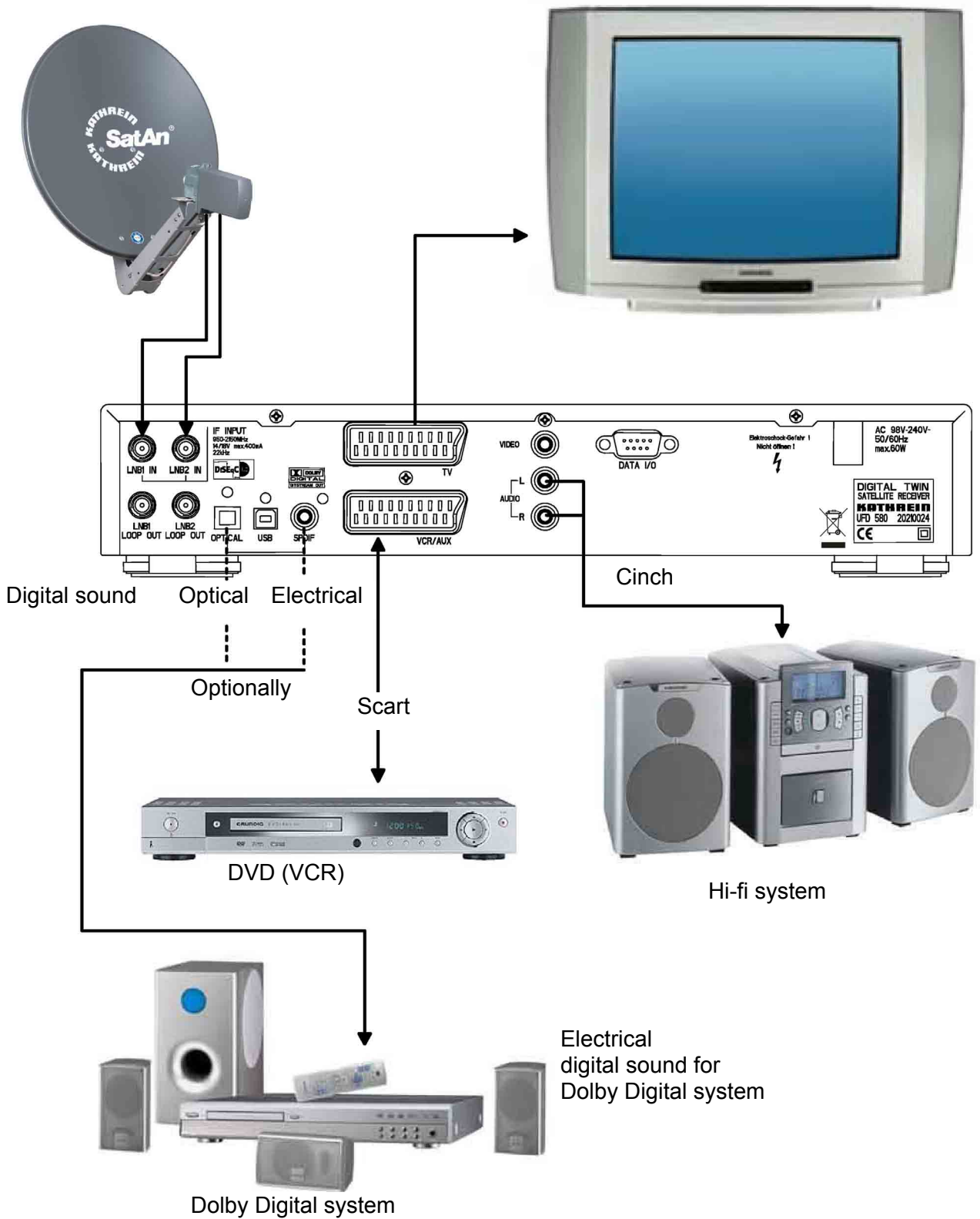

Troubleshooting

In the event of a malfunction, first check all the cable connections and operating states:

1. Receiver and TV set power plugs are connected to wall socket
2. Antenna cable on receiver input
3. Receiver and TV set correctly interconnected by a Scart or cinch cable
4. Audio connections are made to hi-fi or Dolby Digital system as appropriate (see previous page)
5. Receiver and TV set (hi-fi/Dolby Digital system) are switched on (check power indicators)
6. Receiver is responding to remote control

A selection of troubleshooting tips is offered below.

Problem	Cause	Remedy
"Weak signal or no signal!!" warning appears on some or all programmes	<p>Antenna signal of Sat reception system is missing or faulty</p> <p>Incorrect oscillator frequencies set in LNB Configuration menu</p> <p>Only one cable from Sat system connected</p>	<p>Consult an antenna specialist to have it checked and repaired as necessary</p> <p>In "Installation" menu check LNB configuration for satellite in question: High L.O. "10,600" GHz and Low L.O. "9,750" GHz, and change as necessary</p> <p>Connect tuner input "LNB2 IN" with second cable (connect coaxial cable with F connection of SAT socket). OR: In "Installation" menu change LNB configuration tuner input to "#1" (if only one satellite being received)</p>
In software download only "NO" is displayed under "Main SW" and cannot be changed to "YES"	Latest operating system software already installed on computer	Not possible to download again
Remote control no longer responding	Receiver or remote control command set may have been unintentionally changed	Set infrared code 1, as described in operating manual on page 7; check batteries
No new programmes can be added to programme list	Wrong menu option selected	In "Installation" menu select "TP Edit/Scan", enter frequency, polarisation and symbol rate and then under Scan press "OK"
Wrong time being displayed	<p>"Summer time yes/no" setting wrong</p> <p>A incorrect time was imported from the reception signal</p>	<p>In "System Parameters" menu check Summer time Yes/No and change as necessary</p> <p>Switch off receiver at mains switch from current running programme, e.g. ARD or ZDF, wait 10 seconds and then switch back on</p>
The following programmes cut out or "Weak signal or no signal!!" appears: PRO 7, SAT 1, Kabel 1, DSF, N 24, Tele 5, 9 Live, HSE 24 and Sonnenklar TV	DECT telephones are operating on the same frequency as these programmes. Interference may occur due to inadequate level or poor shielding of cable	Consult your antenna specialist
Programmed timer settings cannot be cleared	The timer settings are permanently displayed and do not have to be cleared, but deactivated	In "Timer" menu under Deactivate set "No"
Black or blue screen, no on-screen displays	Scart connection to TV deactivated by accidentally pressing 0 button	Press 0 button repeatedly until "Scart SAT" appears on-screen

DiSEqC™

DiSEqC™ (Digital Satellite Equipment Control) is a communication system between a satellite receiver (master) and the peripheral satellite components (slaves), such as LNBs, multi-switches, rotating antenna systems.

It is a single master/multi-slave system, i.e. there is only ever one master in the satellite system. All activities start from the master.

DiSEqC™ components

If DiSEqC™ switching matrices are cascaded, the master receiver must transmit the DiSEqC™ signal several times, so that all DiSEqC™ multi-switches in the cascade receive their commands.

These days, DiSEqC™ components (slaves) must be reverse compatible, i.e. respond to the analogue switching criteria from receivers that are only equipped with H/V and 22 kHz control signals.

A DiSEqC™ switching matrix will work with analogue switching criteria until the DiSEqC™ command from the master is received. All analogue switching criteria are then ignored.

DVB MPEG-2

DVB is the abbreviation for Digital Video Broadcasting. DVB-S refers to the transmission method (S = satellite). MPEG is the abbreviation for Moving Picture Experts Group, a working group that formulates internationally applicable standards for the digital compression of video and audio. MPEG-2 has established itself as the standard for compression of digital TV signals. MPEG-2 works up to a data rate of 100 MBit/s.

EB/NO ratio

The EB/NO ratio is a measure of the signal to noise ratio of a digital signal. The value is not identical to the C/N value familiar from analogue reception technology. At EB/NO values below 5 dB no reception is normally possible.

FEC

FEC is the abbreviation for Forward Error Correction. The FEC error rate corresponds to the Viterbi rate.

OTR

One Touch Recording

PID

The PID (Packet IDentification) number is an identification number for video signals and audio signals in the digital data stream of DVB-MPEG-2 signals. The receiver uses the PID number to create a unique assignment for the video and audio data transmission. The

PCR PID is the identification number for the synchronisation signal. The PCR PID is normally identical to the video PID. For programmes broadcast in multiple languages, the audio PID can be entered manually to assign a different language to the TV programme. After the PID is entered, the digital receiver automatically selects the audio data identified by the PID number from the data stream and assigns it to the video signal.

Programme package

The programme package for a digital transponder normally includes several TV and radio programmes. Each programme package has a fixed assignment for the transponder transmission frequency, for polarisation (horizontal or vertical), for the symbol rate and for the Viterbi rate or error rate.

PIP

Picture In Picture function

Symbol rate

The symbol rate describes the quantity of data that is transmitted per second. The symbol rate is measured in MSymbols/s and is equal to the number of symbols received per second.

Transponder

A transponder is a satellite channel which transmits TV and radio signals. A satellite has several transponders.

Analogue transponders transmit only one TV programme and possibly multiple radio programmes on the transmission frequency.

Digital transponders simultaneously transmit several TV and several radio programmes at a transmission frequency. If a programme provider is broadcasting several TV programmes via a digital transponder, we refer to the provider's programme package. The terms "digital transponder" and "programme package" have the same meaning.

Video bit rate

The video bit rate describes the quantity of data from the digitised video signal that is transmitted per second.

Viterbi rate

The Viterbi rate (code rate, error rate) characterises the error protection used by the programme provider. The DVB standard provides the following values: 1/2 - 2/3 - 3/4 - 5/6 - 7/8

Short Technical Guide

Glossary

AC 3	Output for Dolby Digital signal
Audio output	Sound output on the receiver
AV programme slot	Preferred programme slot on TV set for Scart input
CA	Conditional Access (for decoding of encrypted programmes)
CI	Internationally standardised interface for CA modules
Decoder	Encryption device for Pay TV
DiSEqC™	Control system between receiver and LNB, multi-switch
DVB	Digital Video Broadcasting
EB/NO [dB]	Power density per unit of information
EB/NO ratio	Digital signal to noise ratio
LED display	Display on receiver
LNB	Low Noise Block Converter
Mute	Muting of sound
OSD	On Screen Display
PAL	Analogue TV standard
Pay TV	Television channels available on subscription (e.g. PREMIERE)
PCMCIA	Standard for internal decoder interface for Pay TV
PID	See Short Technical Guide
PIN	Personal Identification Number
PIP	See Short Technical Guide
Receiver	Satellite receiver
RGB	Video signal made up of three individual colour signals (red, green, blue)
Satellite IF signal	Receiver input signal
Scart cable	21-pin connecting cable (e.g. receiver/TV)
Smartcard	Card from Pay TV provider to encrypt its programmes
Standby	Standby mode
S-VHS	Super Video Home System (video recorder standard)
Symbol rate	Rate of data transmission of satellite signal
Time-shift function	Time-shifted playback
Timer function	Clock function for pre-programmed switch on and off times
Transponder	See Short Technical Guide
UFO® <i>micro</i> and UFO® <i>mini</i>	Kathrein-specific satellite signal processing systems
VCR connection	Video recorder connection
Viterbi rate	See Short Technical Guide

Service

OSD language	Aspect ratio	LNB mode	Tuner input
<input type="radio"/> German <input type="radio"/>	<input type="radio"/> 4:3 <input type="radio"/> 16:9	<input type="radio"/> ON <input type="radio"/> OFF	<input type="radio"/> #1 <input type="radio"/> #2 <input type="radio"/> #1 & #2 <input type="radio"/> Loop

Satellite 1	Satellite 2	Satellite 3
Satellite: _____	Satellite: _____	Satellite: _____
LO1: <input type="radio"/> 9750 _____	LO1: <input type="radio"/> 9750 _____	LO1: <input type="radio"/> 9750 _____
LO2: <input type="radio"/> 10600 _____	LO1: <input type="radio"/> 10600 _____	LO1: <input type="radio"/> 10600 _____
Satellite _____	Satellite _____	Satellite _____

DiSEqC™ menu

22 kHz: High/Low PosA/B OFF

Tone Burst: High/Low PosA/B Opt.A/B OFF

DiSEqC™ ON OFF

DiSEqC™ Repeat ON OFF

UFO®*mini* ON OFF

Remote Frequency _____ MHz

UFO®*micro* ON OFF

Additional settings:		
<input type="radio"/>	<input type="radio"/>	<input type="radio"/>
<input type="radio"/>	<input type="radio"/>	<input type="radio"/>

936-2576/B/0605/ZWT - Technical data subject to change.

Internet: www.kathrein.de

KATHREIN-Werke KG · phone +49 8031 184-0 · Fax +49 8031 184-306
Anton-Kathrein-Straße 1 - 3 · P.O. Box 100 444 · 83004 Rosenheim Germany

KATHREIN
Antennen · Electronic

Free Manuals Download Website

<http://myh66.com>

<http://usermanuals.us>

<http://www.somanuals.com>

<http://www.4manuals.cc>

<http://www.manual-lib.com>

<http://www.404manual.com>

<http://www.luxmanual.com>

<http://aubethermostatmanual.com>

Golf course search by state

<http://golfingnear.com>

Email search by domain

<http://emailbydomain.com>

Auto manuals search

<http://auto.somanuals.com>

TV manuals search

<http://tv.somanuals.com>