

Twin-PVR Satellite Receiver

UFS 822sw/822si

with hard disk and Ethernet



PREFACE

Dear customer,

this operating manual is intended to help you make the fullest use of the extensive range of functions offered by your new satellite receiver.

We have tried to make the operating instructions as easy as possible to understand, and to keep them as concise as possible. To help you understand particular specialist terms that cannot be translated, we have added a short glossary at the end of the manual.

The power switch is an environmentally friendly feature. If you will not be using your receiver for a longer period, you should use the power switch to disconnect it from the power supply and save energy. For shorter breaks, you can use the remote control to switch the receiver to standby, which uses only a minimal amount of energy.

We wish you good reception and much pleasure using your new PVR satellite receiver.

Your
KATHREIN Team

CONTENTS

PREFACE	2
CONTENTS.....	3
IMPORTANT INFORMATION	4
SAFETY INSTRUCTIONS - IMPORTANT NOTES	6
RECEIVER FEATURES/SCOPE OF SUPPLY.....	7
CONTROLS, DISPLAYS AND CONNECTIONS	8
CONNECTION AND SET-UP	9
REMOTE CONTROL.....	13
FIRST INSTALLATION	15
MENU TREE	28
OPERATING INSTRUCTIONS	29
ON-SCREEN DISPLAYS (OSD)	31
COMMON INTERFACE	34
SYSTEM SETUP.....	37
USER PREFERENCES	50
VIDEOTEXT (TELETEXT).....	58
ORGANIZE CHANNELS.....	59
TWIN FUNCTIONS	65
TIMESHIFT	67
TVTV EPG AND TIMER.....	68
AUDIO SETTINGS	81
RECORDING.....	83
RECORDING LIST.....	87
MULTIMEDIA/GAMES.....	104
INSTALLATION MENU	114
CONNECTING UP THE VIDEO/PVR	127
SOFTWARE AND PROGRAMME LIST UPDATE.....	128
PVR MANAGER	132
USING THE FRONT PANEL	133
RECEIVER TO RECEIVER DATA TRANSFER	134
TECHNICAL APPENDIX.....	135
SHORT TECHNICAL GUIDE	147
TROUBLESHOOTING.....	150
SUBJECT INDEX.....	151
SERVICE	155

IMPORTANT INFORMATION

The channels available on the satellites and transponders are subject to continual change. In such cases, it is necessary to reset the channels as the factory preset programming corresponds to the situation on the date of manufacture. The information for these settings can be found on the Internet or in relevant magazines.

Your receiver is factory fitted with the latest software version. We are, however, constantly working on adapting the software to the wishes of our customers and to developments in technology. The "Software and Programme List Update" section contains additional information.

To connect your PC/laptop to the receiver over the network and to use the functions of the PVR Manager , you must have unlimited rights (administrator rights) on your PC/laptop and on your network.

**Please keep the original packaging in case you need to return the product at any time!
Due to their design, hard disks are liable to damage by impacts; they are adequately protected within the receiver only when it is in its original packaging.
If the product is not properly packed, the warranty on the hard disk is invalidated.**

Any modifications to the receiver software, or the use of applications not provided by Kathrein, will invalidate the warranty!

You will have to bear the costs yourself for dispatching and repairing any receiver that requires attention due to modifications to the software and use of applications other than those provided by Kathrein!

Therefore exclusively use only software and applications provided by Kathrein for your receiver. These are available by downloading from the satellite or from our Internet pages (www.kathrein.de).

Make a note of the receiver's basic settings, so as to be able to restore them if necessary!

Make sure that neither the fans on the device's rear panel nor the ventilation slits are covered or blocked. If so, the device may overheat. Fire hazard!

Included in the software for this receiver is software that is licensed under the GNU (General Public Licence). The source code of the program is obtainable under: <http://www.kathrein.de/linux/receiver/ufs822/>

DiSEqC™ is a trademark of Eutelsat.

IMPORTANT INFORMATION

REFERENCE NOTE ON AUDIO MPEG INC. AND S.I.SV.EL, S.P.A:

This device employs legally protected technologies which are protected by patents in the USA as well as by intangible property laws in other countries.

Audio MPEG Inc. and Societa' Italiana per lo sviluppo dell'elettronica, S.I.SV.EL, S.P.A, have granted KATHREIN-Werke KG rights of use which are subject to certain restrictions. These restrictions must also be observed by you as a customer.

According to these, this device is only to be used by end customers for private, non-commercial purposes and for licensed content. Use for commercial purposes is not authorised. Utilisation of products or procedures sold or used with this device are not comprehended. With reference to licensed technologies, application of reversible procedures as well as dismantling of the device are both not permitted.

ONE-TOUCH RECORDING ON EXTERNAL USB STORAGE MEDIA

Die USB interface on the receiver front panel is not intended for connection of USB storage media!

To directly record a broadcast with the UFS 822 on an external USB storage medium (e.g. external hard disk) with USB port), die Sie an die USB 2.0 Host-Schnittstelle an der **Rückseite** des Receivers anschließen können, ist folgendes unbedingt zu beachten:



Please observe that the receiver only transmits a current of 500mA on the USB 2.0 socket. For some hard disks, this is not sufficient to guarantee flawless operation. To guarantee optimal power supply to the hard disk, use an external hard disk with its own power supply or insert a USB 2.0 hub with its own power supply.

The recording function is only valid for One Touch Recording (OTR). Programming via EPG is not possible!

SAFETY INSTRUCTIONS - IMPORTANT NOTES

GB

Safety Instructions – Important Information

This page contains important information about the operation, installation location and connection of the unit. Read these instructions carefully before starting to use the unit.



Mains cable

Make sure that the mains cable (power supply cable) is not damaged. Units with a damaged mains cable must be disconnected from the mains (disconnect mains connector) and repaired by a qualified engineer before setup. Only use the power pack supplied (if available)!

Risk of death due to electric shock!

Cleaning

Disconnect the mains connector before cleaning the unit. Only use a dry cloth for cleaning and only clean the outer surface. Never open the unit.

Touching the parts inside the unit carries a risk of death due to electric shock!

Playing children

Make sure that children do not push any objects into the ventilation slots.

Risk of death due to electric shock!



Earth connection

The antenna system must be earthed as specified or equipotentially bonded. EN 60728/11 and any national regulations must be complied with.

Danger due to surge voltages, lightning strikes!

Mains voltage

Only operate the unit with the specified mains voltage (marked on the rear of the-unit or on the external power pack)! The unit may only be connected to the mains and turned on once it has been connected to the antenna and to the TV set or the cable network and PC.

If the mains voltage is too high, there is a risk of fire!

Repairs

Ensure that any repairs to your unit are carried out by qualified personnel. Opening the unit and attempting to repair it yourself voids all warranty claims! Improper work on the unit can jeopardise the electrical safety of the unit.

The manufacturer accepts no liability for accidents caused by the user opening the unit!



Connections

Incorrect wiring of the connections can lead to malfunctions or defects on the unit!

Long periods of absence/storms/accessibility of the mains connector

Always turn off the unit at the mains switch if you will be absent for a long time or there is a storm. Disconnect it from the mains by unplugging the mains connector. This also applies to the other equipment connected to the unit. Isolation from the cable network is also recommended. Note any timer programs (receiver) and turn the unit on again promptly before the recording time. Ensure the mains connector is accessible at all times.



Installation location

All electronic equipment generates heat. However, the heating of this unit lies within the permissible range. Sensitive furniture surfaces and veneers may become discoloured by the effects of constant heat over time. The feet of the unit can also cause colour changes to treated furniture surfaces. If necessary, place the unit on a suitable stable and flat base!



Ventilation

The heat generated in this unit is adequately dissipated. However, the unit should never be installed in a cupboard or on shelves with inadequate ventilation. Never cover the cooling slots on the unit (e.g. with other equipment, magazines, tablecloths or curtains)!

Do not place any objects on top of the unit and maintain a clearance of at least 10 cm above the unit, so that the heat generated can be dissipated with no obstructions.

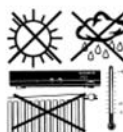

Moisture, sunlight, heat, naked flames

Protect the unit against moisture, dripping and splashed water (do not place any filled objects such as vases on top of the unit). Do not place the unit close to a heater or expose it to direct sunlight and do not operate it in damp locations. Only use the unit in a moderate climate, not in tropical conditions! Do not expose the unit to any naked flame, such as from a candle! This constitutes a fire hazard!

RECEIVER FEATURES/SCOPE OF SUPPLY

The UFS 822 multi-functional satellite receiver is fitted with two independent reception and signal processing systems as well as a computer hard disk with a capacity of 160 GByte, allowing one to download over 100 hours of TV and radio programmes, and to view these as often as wanted without any loss in quality, either at the same time or time-delayed (timeshift function).

The integrated Common Interface can accommodate two CA modules to enable viewing of additional Pay-TV channels. The receiver's 16-digit alphanumeric display shows the channel names, while 16 status icons inform you on the current receiver state (e.g. Dolby Digital, timer, ...)

The HDMI interface allows one to connect the receiver to the HDMI interface on an HDMI-capable screen for optimal viewing comfort. A video composite connection and two Scart connections are additionally provided. The receiver is fitted with an optical audio output so that the Dolby Digital data stream AC 3 can be transmitted to a Dolby Digital stereo system.

USB 2.0 host: Playback of MP3 files, JPEG files and recordings; recording on external storage medium, formatting of external USB devices, use for service purposes (updating software)

Ethernet port: Playback of MP3 files, JPEG files and recordings, VLC streaming, software update and channel list editing using a PC/Laptop.

The „File Sharing“ feature is enabled using the programme „MFServer“, which is integrated in the PVR Manager. The programme can be downloaded free of charge from the Kathrein website. The professionally edited tvtv EPG provides free information on over 60 programmes without requiring bothersome channel change-over, even up to one week in advance.

The receiver's operational system is LINUX based. The receivers are available in silver and black.

PRODUCT PACKAGE

- UFS 822si and UFS 822sw
- Remote control RC 660
- Scart cable
- Coaxial loop-through cable for loop-through operation
- 2 Batteries AAA 1.5 V
- Power supply cable
- Operating Manual

CONTROLS, DISPLAYS AND CONNECTIONS

This section provides a brief description of all the controls, displays and connections. The key symbols presented here can also be found in the description of the operating steps.

VIEW OF FRONT PANEL (FLAP FOLDED DOWN)

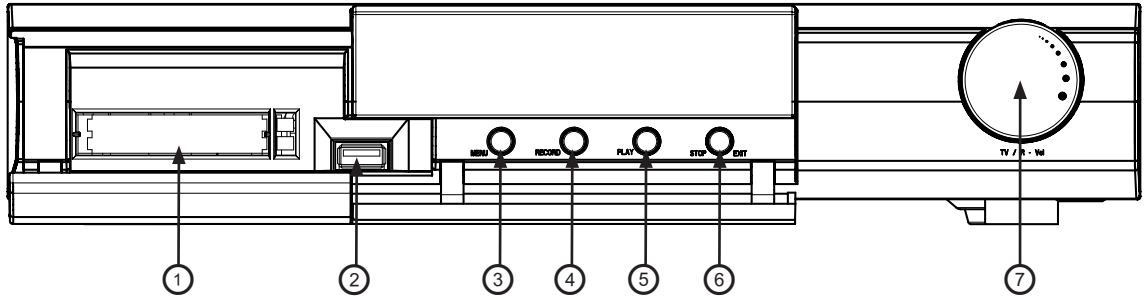

VIEW OF REAR PANEL

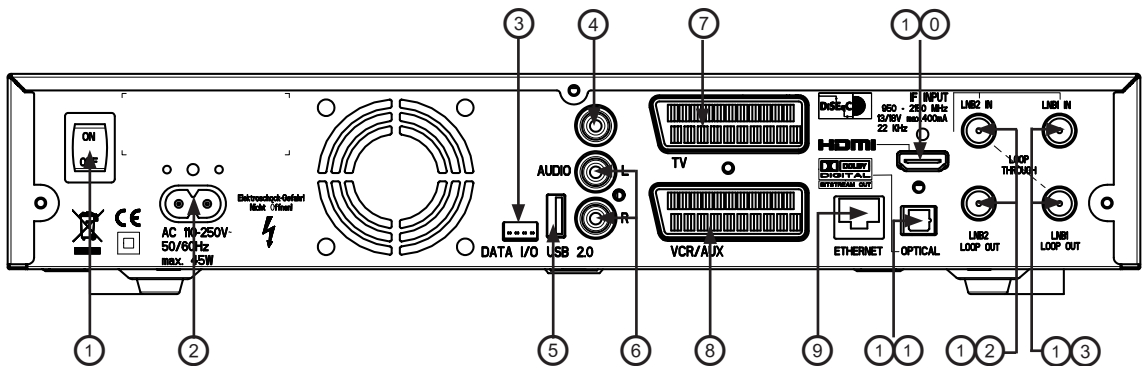

Front panel controls and displays

1. Common Interface for two CA modules for Pay-TV cards *)
2. USB 1.1 port
3. Menu button to call up or exit menus or sub-menus
4. Record button to start recording manually
5. Play button to start playback manually
6. Stop/Exit button to stop playback/recording manually or exit the menus
7. Multifunction control

*) CA modules and Pay TV cards are not included

Rear panel controls and displays

1. On/Off switch (with mains disconnect)
2. Mains supply cable
3. Data interface (only for service)
4. Video output (composite colour)
5. USB 2.0 host port
6. Audio outputs (L/R) cinch sockets
7. Scart socket for TV connection
8. Scart socket for VCR-/AUX connection
9. Network connection (Ethernet)
10. HDMI connection
11. Optical data stream output (SPDIF/Sony Philips Digital Interface Format) for Dolby Digital AC 3 audio
12. LNB 2 input and loop-through output
13. LNB 1 input and loop-through output

CONNECTION AND SET-UP

The following section is intended specifically for specialist dealers. You only need read this section if you are performing the installation yourself.

The "Connection Examples" section provides a sample configuration.

Do not connect the unit to the mains until all installation work has been properly carried out.

Refer to the information in the "Safety Instructions" section.

CONNECTING THE UNIT (SAT-IF CONNECTIONS)



Connect the Sat IF inputs on the receiver to the satellite reception system. Use coaxial cable with a standard F connector.

If the F standard connectors are not yet fitted on the cable, strip the insulation from the cable as shown in the following illustration and carefully twist the F standard connectors on to the ends of the cables until they are securely seated.

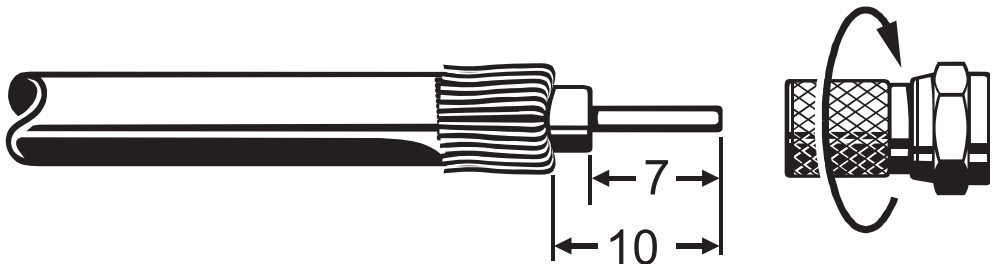

When fitting the connector, make sure that no wires from the braid are touching the inner conductor, so no short circuit can occur.

The quality of the reception signal depends on the connection!

RECEPTION REQUIREMENTS



Make sure that your own satellite antenna system is equipped at least with a universal LNB for digital reception in the high-band range.

RECEPTION SYSTEM PRESETS

The presets for the control signals have been made for standard reception systems, i.e. 14/18 V for polarity reversal and 22 kHz switching signal for low/high band changeover on multi-feed reception systems.

If tone-burst switch matrices are used in the reception system, the default selection in the installation menu, Antenna Setup, Tuner 1 and Tuner 2, under "DiSEqC™ Switch", must be changed. Refer to the "Installation Menu" section on this, under "Antenna Setup", "Tuner 1" and "Tuner 2". Be sure to follow the operating instructions for the matrix used.

CONNECTION AND SET-UP

INFORMATION ABOUT ANTENNA CONNECTION AND “LOOP THROUGH” OPERATION

To enable you to utilise all the reception and recording properties of your UFS 822 twin-PVR Sat receiver, such as

1. recording one programme and at the same time viewing any other programme or zapping through the channels, and
2. recording two different programmes at the same time,

the two tuner inputs of the Sat receiver must each be supplied with a dedicated satellite signal from the antenna system/Sat outlet.

The receiver tuner inputs are factory preset on the installation menu to work with two separate Sat antenna connections.

If you only have one antenna connection available, we recommend you interconnect the output of tuner 1 and the input of tuner 2 using the loop-through cable supplied.

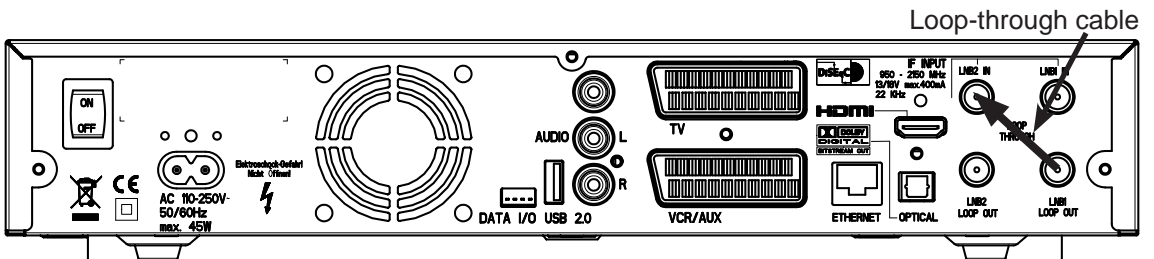

For this, in “First Installation” for tuner input 2 select “Loop-through mode” (see “First Installation” section).

Press the **MENU** button to access the “Tuner Input” menu option, then choose “Installation” and “First Installation”. Go through step-by-step until you get to Tuner Setup, you can make the settings here, though a restriction on this is that with tuner 2 you can only receive the additional channels of the plane currently set by tuner 1 (e.g. Horizontal High).

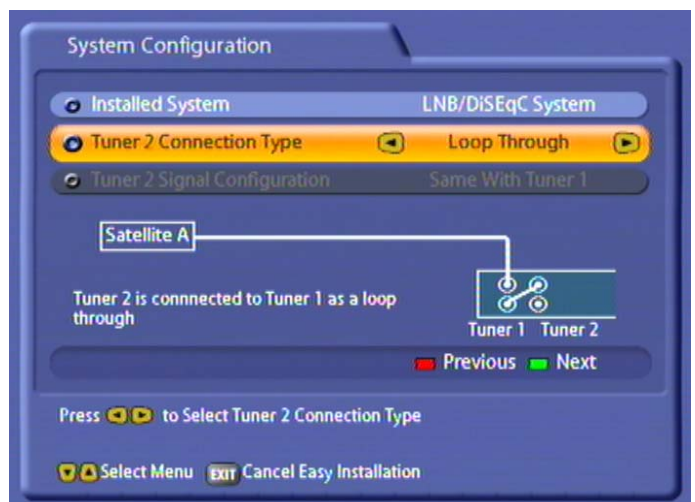
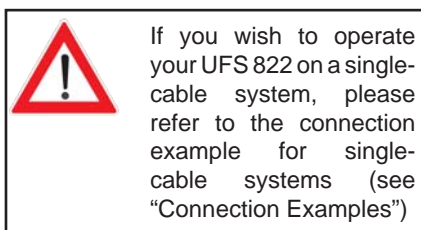

CONNECTION AND SET-UP



This will only work when receiving one satellite, not in multi-feed reception!

If only tuner 1 is connected (with no connection to tuner 2), the “Single Mode” setting must be selected for the tuner input. You then have only the facilities of a normal “single receiver” available to you. If this setting is not made, malfunctions will occur and the following message will be displayed:

No signal!

To access the menu for the setting “Single Mode”, proceed as follows:

Main menu → Installation → Antenna settings → Connection type

TV AND VIDEO RECORDER CONNECTION

Connect the satellite receiver (TV Scart socket) and the TV set using a Scart cable (see “Connection Example”). If your TV has a stereo capability, you can receive the sound in stereo via the Scart connection. Connect the satellite receiver (VCR/AUX Scart socket) and the video recorder/PVR likewise by a Scart cable. For system reasons, the same video signals are to be found on the Scart outputs and on the video cinch output.



If you are recording using an external video recorder, remember not to operate the receiver during recording, otherwise all the on-screen displays will appear on your recording.

AUDIO CONNECTION

If you want to play the sound on your hi-fi system, connect the audio cinch sockets to the input sockets on the hi-fi system with an appropriate cable (see “Connection Example”).

OPTICAL DIGITAL OUTPUT

The fibre-optic output is intended for the connection of a Dolby Digital system (see “Connection Example”).

CONNECTION AND SET-UP

INSERTING BATTERIES INTO THE REMOTE CONTROL



Remove the cover on the rear of the remote control.

Insert the two supplied batteries into the remote control. Ensure correct polarity of the batteries; the + and - markings are indicated inside the battery compartment.

Slide the cover back into the housing until it locks in place.

Used batteries are special waste!

Do not throw spent batteries into your domestic waste; take them to a collection point for old batteries!

DISPOSAL INSTRUCTION





Electronic equipment is not domestic waste - in accordance with directive 2002/96/EC OF THE EUROPEAN PARLIAMENT AND THE COUNCIL dated 27th January 2003 on used electrical and electronic appliances, it must be disposed of properly.

At the end of its service life, take this unit for disposal to an appropriate official collection point.

REMOTE CONTROL

 Sound on/off

 Number input for channels, timers etc.

 Access main menu
Exit menus

 (red)
Access Favorites list

 (green)
Picture-in-picture from 2nd tuner or hard disk

 Volume

 Exit menu -
back to TV picture

 Fast rewind

 Playback
Hard disk contents

 Pause (freeze-frame)
Timeshift

 (red)
One-touch recording



 Power/standby

 Videotext (Teletext)

 (yellow)
Access channel options Sound/subtitles selection

 (blue)
Switch between TV/radio

 Access channel notification
Programme info

 AV mode

 Channel selection up/down

 Confirm input
Access channel list

 Cursor buttons

 Access TVTV EPG (Electronic Programme Guide)

 Fast forward
Display recordings

 Stop recording/playback

REMOTE CONTROL

REMOTE CONTROL RC 660

The RC 660 remote control supports up to four devices which are supplied with the RC 660 as standard.

First, switch off all other receivers (mains switch).

1. Setting via menu (as of software version 1.01)

For the UFS 822, the remote control code does not have to be entered manually. You can easily select one of the four existing remote control codes in the menu (see menu "System setup", "STB management", "Remote control code").

Notice: *As of software version 1.01, the remote control code can only be modified through the menu. Manual modifications will not be saved by the receiver.*

2. Manual setting (only possible if the software version is older than 1.01)

Switch on the relevant receiver.

On the remote control simultaneously press

Address 1 = **EXIT** + **9** + **1**

Then switch the receiver off again at the power switch and do the same for the other units (**EXIT** + **9** + **2**) for the second receiver; **EXIT** + **9** + **3** for the third receiver and **EXIT** + **9** + **4** for the fourth receiver)

Make sure only one receiver is on at a time!

To switch the remote control to an infrared code:

When you have configured all receivers to their infrared code, to switch between units on the remote control do the following:

For operating the first receiver (address 1), press

EXIT + **1**, for the second receiver **EXIT** + **2**, for the third receiver **EXIT** + **3** and for the fourth receiver **EXIT** + **4**.

EXIT + **FAV**(red) = Kathrein UFD 5xx code for remote control RC 400

The RC 600 and RC 650 remote controls cannot be replaced!

FIRST INSTALLATION

Before using your unit for the first time, read the “Safety Instructions” and “Connection and Setup” sections.

The “Connection Examples” section provides a sample configuration.

Do not connect the unit to the power supply until all installation work has been properly carried out.

The guidance given in the “First Installation” section assumes that the receiver has been properly connected, as per the “Safety Instructions” and “Connection and Set-Up” sections.



First switch your TV set on and select the AV channel position. Switch on your receiver at the power switch on the rear of the unit. The following screen appears:

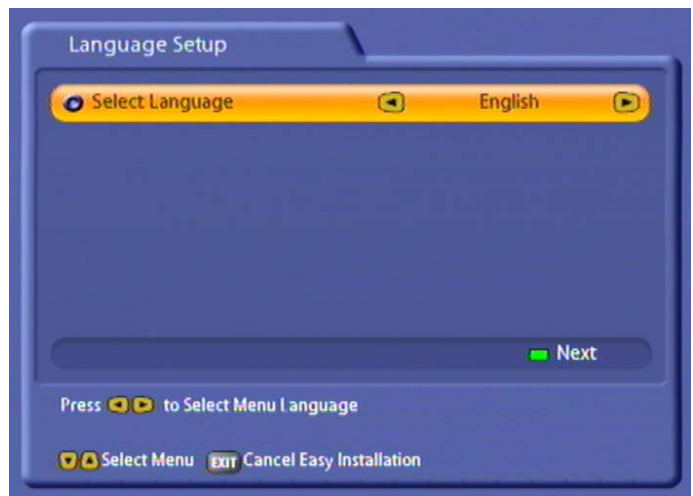
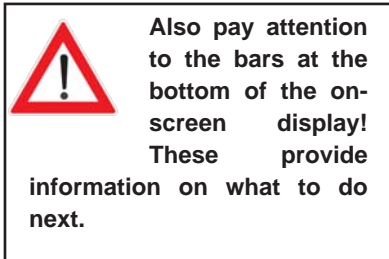





Select the menu language you want using the   buttons. Available options: German, English, Turkish, Italian, Spanish, Polish, Dutch and French.

Press the  (green) button to move to the next menu.

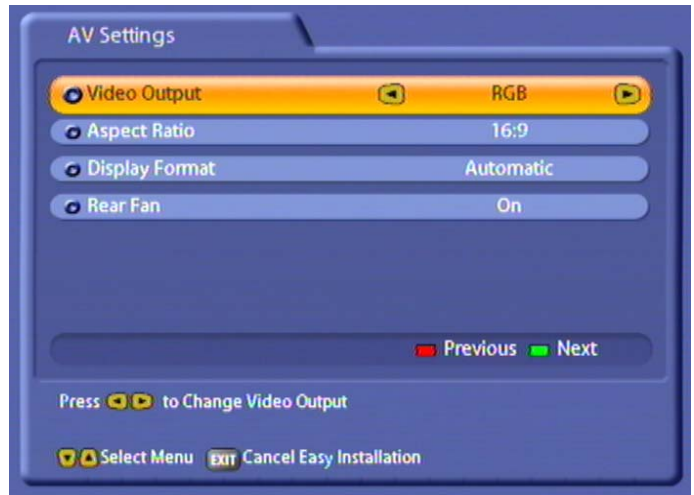
FIRST INSTALLATION

The following display appears:



Use the     buttons here to select the settings for your TV set.

Refer to the operating instructions for your television set!

Video Output

Here select the type of video signal at the Scart socket or HDMI socket. Select the signal that your TV set can process.

- FBAS – composite colour baseband signal (colour/picture/blanking/synchronisation signal)
- RGB – Red/Green/Blue signal
- Y/C – S-Video signal (luminance/chrominance) or
- YUV – component data

TV Type

Here select the TV's picture format. Either

- 4:3 format,
- 16:9 format or
- HDMI

Display Format

Select the screen display mode here:

- for TV type "4:3": "Pan & Scan" or "Letter-Box"
- for TV type "16:9": "Automatic" or "Always 16:9"
- for TV type "HDMI": "Automatic" or "Always 16:9"

Rear fan

Here you can select whether the rear fan always runs whilst the unit is switched on "On" or whether the fan will be switched on and off again at pre-programmed intervals "Scheduled".

Press the  (green) button to move to the next menu.

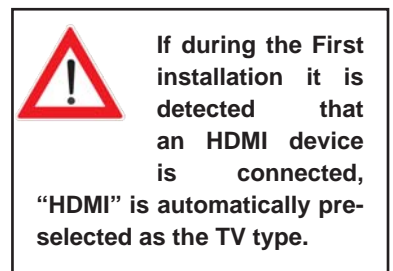



FIRST INSTALLATION

The following display appears:

Note:

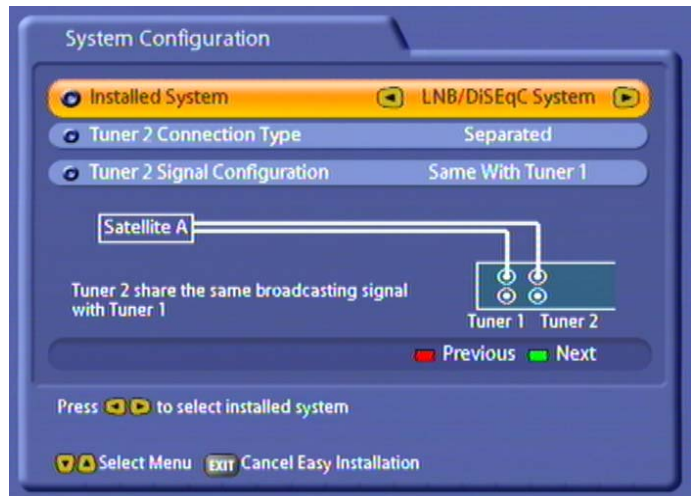
If you are unsure whether you chose the right option from a previous menu, you can go back a step at any time during the First installation process by pressing the  (red) button.



Press the   buttons here to select the connection type and signal configuration for the tuners set on the receiver by you or the engineer.

You have the following options:

Installed system

- “LNB/DiSEqC™ System”: Conventional satellite reception (simple digital satellite system)
- “Single-cable system”: Satellite reception using a “single-cable system” (**functions at present only using a single cable system from Kathrein!**)

Connection type for tuner 2

- “Separated”: Tuner 2 (input) has its own signal input, i.e. a direct connection between the antenna socket and the tuner 2 input
- “Loop-through”: The signal currently connected to the tuner 1 loop-through output is looped-through to tuner 2 (input). Refer also to the section headed “Operation on one Antenna Connection”

Signal configuration for tuner 2 (only in “Separated” connection type)

- As for tuner 1: Both tuners are connected to the same signal source (same cable from LNB)
- Different from tuner 1: The two tuners are connected to different signal sources (separate cables from LNB)

Press the  (green) button to move to the next menu. The notes on the subsequent First Installation menus are divided into two columns. The left-hand column indicates the further installation procedure for the “Same with tuner 1”, signal configuration, while the right-hand column details the “Different to tuner 1” procedure. If your reception system is a “Single-cable” system from Kathrein, continue the First installation as described on page 25.



The satellites shown in the following screenshots are factory preset. To be able to receive the satellites you want, your system must be aligned to them!

FIRST INSTALLATION

Signal configuration “As for tuner 1”

Press the ^{TVR} (blue) button to view the satellites by continent; that is, which satellites are accessible on which continent. The continents are displayed above the list of satellite names. The selected continent is shown in yellow.

The satellites from the pre-programmed channel list are automatically pre-entered in the right-hand column, and can be changed/deleted according to your reception system.



Press the **▲▼** buttons and the **OK** button to select the satellites from which you want tuners 1

and 2 to receive signals. Press the **OK** button to confirm your selection; the chosen satellite is then moved into the tuner satellite list on the right.

If you have unintentionally transferred a satellite into the list on the right, you can press the

^{OPT} (yellow) button to switch between the lists, and

then press the **OK** button to remove the satellite concerned.

When you have selected all the satellites you want, press the ^{PIP} (green) button.

Signal configuration “Different from tuner 1”



Press the **▲▼** buttons and the **OK** to select the satellites you want tuner 1 to receive signals from.

Press the **OK** button to confirm your selection; the chosen satellite is then moved into the tuner satellite list on the right.

If you have unintentionally transferred a satellite into the list on the right, you can press the

^{OPT} (yellow) button to switch between the lists, and

then press the **OK** button to remove the satellite concerned.

When you have selected all the satellites you want, press the ^{PIP} (green) button.

FIRST INSTALLATION









Select here the satellites you want tuner 2 to receive signals from, as you did for tuner 1. When you have selected all the satellites you want,

press the  (green) button.



Press the     buttons and the  button to select the satellite configuration for each satellite you previously selected.

LNB Type:







Press the  button to open the LNB settings menu. Press the   buttons to make your selection. To confirm your selection press the   buttons to select "OK" and press the  button.

- Single (LNB Low frequency 9750 MHz)
- Dual (LNB Low frequency 9750 MHz and LNB High frequency 10,600 MHz)
- Universal (LNB Low frequency 9750 MHz and LNB High frequency 10,600 MHz and Limit frequency 11,700 MHz)



Press the     buttons and the  button to select the satellite configuration for each satellite you previously selected.



LNB Type:

Press the  button to open the LNB settings menu. Press the   buttons to make your selection. To confirm your selection press the   buttons to select "OK" and press the  button.



- Single (LNB Low frequency 9750 MHz)
- Dual (LNB Low frequency 9750 MHz and LNB High frequency 10,600 MHz)
- Universal (LNB Low frequency 9750 MHz and LNB High frequency 10,600 MHz and Limit frequency 11,700 MHz)

FIRST INSTALLATION

22kHz Control:



Press the   buttons to make your selection (On/Off). The 22kHz Control is needed to switch LNBS in multi-feed reception and to switch between Low and High band.

DiSEqC™ input:

Press the   buttons to make your selection.

- 1 of 4: for the first satellite of the tuner
- 2 of 4: for the second satellite of the tuner
- 3 of 4: for the third satellite of the tuner
- 4 of 4: for the fourth satellite of the tuner
- Mini A: Tone-burst control signal 1 for the first satellite of the tuner (if reception system not DiSEqC™-compatible)
- Mini B: Tone-burst control signal 2 for the second satellite of the tuner (if reception system not DiSEqC™-compatible)
- Disable: If your reception system is not DiSEqC™-compatible and only one satellite per tuner is selected.

22kHz Control:

Press the   buttons to make your selection (On/Off). The 22kHz Control is needed to switch LNBS in multi-feed reception and to switch between Low and High band.



DiSEqC™ input:

Press the   buttons to make your selection.

- 1 of 4: for the first satellite of the tuner
- 2 of 4: for the second satellite of the tuner
- 3 of 4: for the third satellite of the tuner
- 4 of 4: for the fourth satellite of the tuner
- Mini A: Tone-burst control signal 1 for the first satellite of the tuner (if reception system not DiSEqC™-compatible)
- Mini B: Tone-burst control signal 2 for the second satellite of the tuner (if reception system not DiSEqC™-compatible)
- Disable: If your reception system is not DiSEqC™-compatible and only one satellite per tuner is selected.

FIRST INSTALLATION

Transponder:



Press the   buttons to scroll through the transponders of the satellite highlighted in yellow at the top of the display. At the right you will see the signal strength of the transponder on the two tuners, enabling you to check that the satellite configuration you just set up is OK.

When you have finished configuring the satellite, press the  (green) button.

If in the preceding "Select Satellite" menu you selected more than one satellite, you will now see the configuration for the next of the satellites you selected. Configure the satellite as described above.

When you have finished configuring the satellite, press the  (green) button. The receiver then automatically calls up the selection menu for the channel search.

Transponder:

Press the   buttons to scroll through the transponders of the satellite highlighted in yellow at the top of the display. At the right you will see the signal strength of the transponder on the two tuners, enabling you to check that the satellite configuration you just set up is OK.

When you have finished configuring the satellite, press the  (green) button.

If in the preceding "Select Satellite" menu you selected more than one satellite, you will now see the configuration for the next of the satellites you selected. Configure the satellite as described above.

When you have configured all the satellites you previously selected for tuner 1, you see the satellite configuration display for the second tuner (see example screenshot):



Configure the satellites for the second tuner in the same way as for tuner 1.

When you have finished configuring the satellite, press the  (green) button. The receiver then automatically calls up the selection menu for the channel search.

The notes on First installation are unified once again from this point!
Continue First installation as described on page 25.

FIRST INSTALLATION

Single-cable system “Automatic”

Note: If there already is a UFS 822 on the system and a second UFS 822 is to be added, the first UFS 822 should be switched on and both tuners should be active, so that the single-cable frequencies for the first receiver remain reserved. The two receivers cannot share the same frequencies.

Press the  (green) button to continue with the installation.

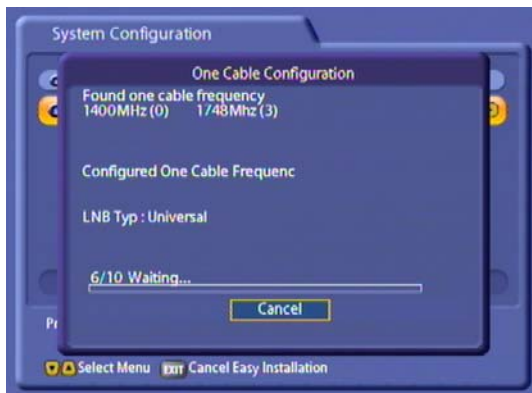
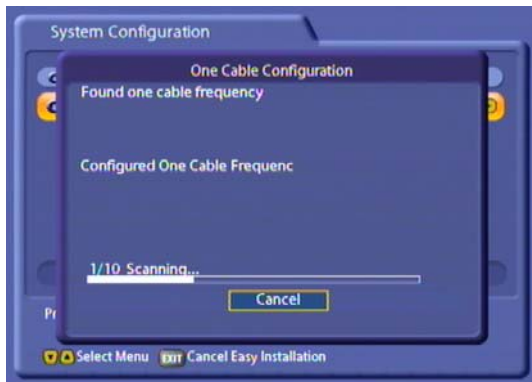

Display of the valid single-cable frequencies found by the receiver (example):

- Single-cable frequency 0–1400 MHz
- Single-cable frequency 1–1516 MHz
- Single-cable frequency 2–1632 MHz
- Single-cable frequency 3–1748 MHz

The number of searches is limited to 10. If the tenth search is performed and still no success, the system switches to manual mode. It can however be switched back into automatic mode.

Single-cable system “Manual”

Note: If there already is a UFS 822 on the system and a second UFS 822 is to be added, you must assign different frequencies to the second UFS 822 (otherwise the receivers will interfere with each other).

A maximum of two UFS 822 receivers can be connected to a 4-SCR system.



Press the     buttons to set the two single-cable frequencies to be used by your receiver.

Then press the  (green) button to obtain the next screen.



FIRST INSTALLATION

The receiver now checks whether two free single-cable frequencies are available for the receiver to use.

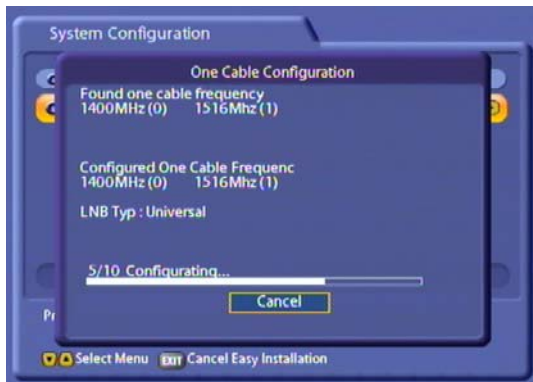

Display of the frequencies selected by the receiver (example):

Single-cable frequency 0–1400 MHz
Single-cable frequency 1–1516 MHz

The receiver now automatically performs the configuration (setting the LNB frequency and the LNB type).

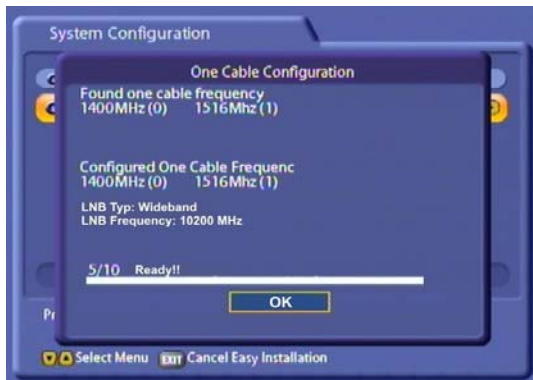

Once the automatic configuration has been completed, the receiver displays an overview for you. Now press the **OK** button.

Press the **▲▼** buttons and the **OK** button to select the satellites from which you want tuners

1 and 2 to receive signals. Press the **OK** button to confirm your selection; the chosen satellite is then moved into the tuner satellite list on the right.

If you have unintentionally transferred a satellite into the list on the right, you can press the

OFF **⏻** (yellow) button to switch between the lists, and

then press the **OK** button to remove the satellite concerned.

When you have selected all the satellites you

want, press the **PP** **⏻** (green) button.



If the LNB type used in your reception system is a single-cable LNB, the setting must be “Wideband” LNB. If a Universal LNB is used with a single-cable matrix, the setting must be “Universal” LNB (for this, refer to the product information, user instructions and manuals for the LNB and for the matrix).

For “LNB Type” perform here a suitable setting for your reception system, “Wideband” or “Universal”. The “22kHz Control” must be set to “Off” and the “DiSEqC™ Input” must be set to “Disable”.

You can see whether the configuration is correct for your reception system by viewing the test transponder signal strength (selection by pressing

the **◀▶** buttons).

FIRST INSTALLATION



Press the **▲▼** buttons and the **OK** button to select the satellites from which you want tuners

1 and 2 to receive signals. Press the **OK** button to confirm your selection; the chosen satellite is then moved into the tuner satellite list on the right.

If you have unintentionally transferred a satellite into the list on the right, you can press the

OFF (yellow) button to switch between the lists, and then press the **OK** button to remove the satellite concerned.

When you have selected all the satellites you want, press the **PP** (green) button.



The “22kHz Control” must be set to “Off” and the “DiSEqC™ Input” must be set to “Disable”.

You can see whether the configuration is correct for your reception system by viewing the test transponder signal strength (selection by pressing

the **◀▶** buttons).

FIRST INSTALLATION

The notes on First installation are unified once again from this point!

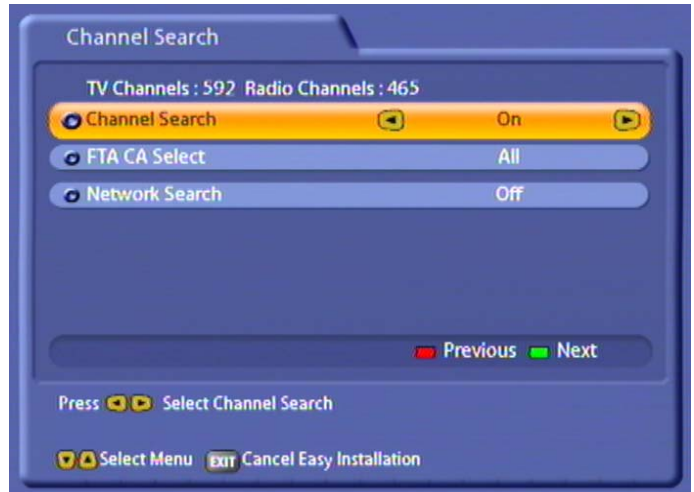

Perform the settings by pressing the buttons.

Channel Search

Press the buttons to select whether you want to use the factory default channel list or whether you want to search for more/new channels.

FTA CA Select:

- All: FTA (free-to-air) and encoded channels are searched for
- Only FTA channels: Only non-encrypted channels, such as ZDF in Germany, are searched for
- Only encrypted channels: Only encrypted channels, such as Austria's ORF, are searched for



Encrypted channels can be decoded only by using a CA module and corresponding smart card. CA modules and smart cards are not supplied with this product. Please contact your respective Pay-TV supplier.

Network scan

If you set the network search to "Off", only the factory stored transponders of the satellites you previously selected will be scanned for new as yet unlisted channels.

If you set the network scan to "On", the transponder network enables additional transponders that have not yet been stored to be located. They are then stored and searched for new channels in the same way as the existing transponders.

Press the (green) button to start the channel search, or if you set the channel search to "Off" you are guided straight to the next item in the First installation process.

FIRST INSTALLATION

If the search is successful, you see the following message (example):

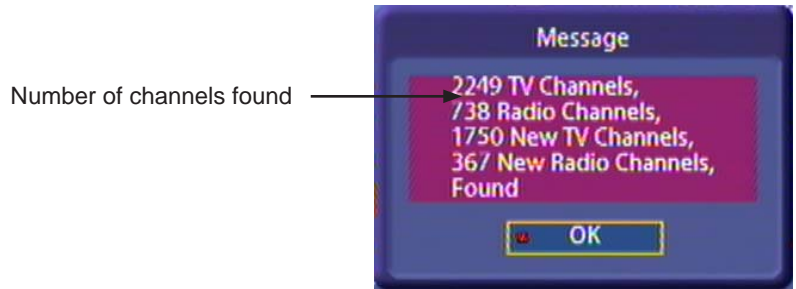

Press the **OK** button to confirm loading the newly found channels and move on to the next step in First installation.

Here press the **◀▶** buttons to select the time mode:

- Manual or
- Auto (receiver takes time from preset channel)

“Manual” time setting

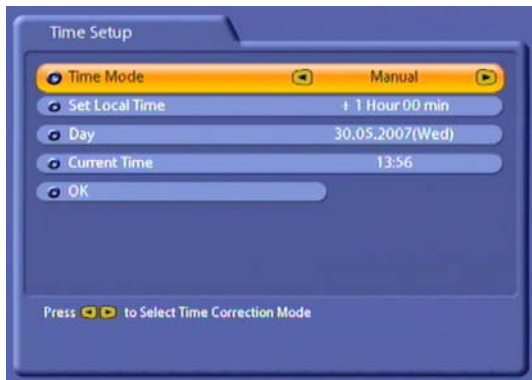

Use the **▲▼◀▶** buttons to make the settings.

“Auto” time setting



Use the **▲▼◀▶** buttons to make the settings.

FIRST INSTALLATION

Set Local Time

Press the **OK** button to set the variance from UMTC (Universal Mean Time Coordinate; formerly Greenwich Mean Time) and Winter/Summer time. At the bottom of the screen you see a listing of major cities to provide an indication of which time zone you have just set. Example: For Berlin (Germany) you need to enter +1 hour.

Use the **◀▶** buttons to make the setting.

Day

Select today's date here. Press the **OK** button to display a calendar. Select the day using

the cursor buttons (**▲▼◀▶**). If the right month and year are not displayed, you can select as follows:

- Previous month (**FAV** (red) button)
- Next month (**PP** (green) button)
- Previous year (**OPT** (yellow) button)
- Next year (**TVR** (blue) button)

Press the **OK** button to confirm your selection.

Current Time

Use the numeric pad to key in the current time here. The position at which the number needs to be entered is automatically underlined.

Press the **▲▼** buttons to select "OK" and press the **OK** button to complete the First installation. Then press the **EXIT** button to view the TV picture.

Set Local Time

Press the **OK** button to set the variance from UMTC (Universal Mean Time Coordinate; formerly Greenwich Mean Time) and Winter/Summer time. At the bottom of the screen you see a listing of major cities to provide an indication of which time zone you have just set. Example: For Berlin (Germany) you need to enter +1 hour.

Use the **◀▶** buttons to make the setting.

Time Setup Channel

If the time mode is set to automatic, enter the channel here (pre-setting: "Das Erste"), from which the receiver should receive the time. Press

the **OK** button to call up a channel list from which you can select the channel you want using the

▲▼ buttons. Press the **OK** button to confirm your selection.

Setup Time Now

Press the **OK** button to set the time immediately. It may take a few seconds for the right time and date to be displayed.

If the time on the receiver varies by more than a minute, the time on the receiver will automatically be updated on selecting "Das Erste" channel.

MENU TREE

Main Menu

(call up by pressing the  button)

Organize Channels	Programme Guide	System Setup	Installation	User Preference	Recording List	Multimedia/ Games
Edit TV Channels		TV Settings	First installation	Language Setup		MP3 Player
Edit Radio Channels		Time Setup	Antenna Setup	Sleep Timer		Photo Album
Edit TV Favorites		Common Interface	Channel search	Parental Control		Games
Edit Radio Favorites		STB Management	Motorized Antenna	Appearance Setup		Applications
		HDD Management	Edit Satellite	PVR Setup		VLC Streaming
		USB Devices	Edit Transponder	EPG Setup		External Recordings
		Ethernet Setup	On Air Download	Dynamic SI Handling		

OPERATING INSTRUCTIONS

MENU CONCEPT

The structure of the menu concept is based on logical operating sequences. The programme showing on the current selected channel always appears in the top right-hand corner of the screen.

You will find detailed descriptions of the selected menu items in the relevant sections of the operating manual!

Note: *The selected menus, sub-menus and positions, as well as the parameters to be set, are each highlighted in colour. The menus are self-explanatory.*

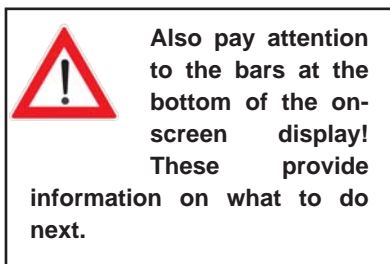

Press the **MENU** button to call up the main menu and press the **▲▼** buttons to call up the sub-menus.



Press the **OK** button to access the sub-menus. Press the **▲▼** buttons to select items within the sub-menus.

The settings under the various options are made either by pressing the **◀▶** buttons or by using the numeric pad. You can exit the main menu and sub-menus, and the various options, step-by-step

by pressing the **MENU** button (the settings/changes you made are saved). Press the **EXIT** button to return directly from one of the menus to the TV picture (the settings/changes you made are saved).

OPERATING INSTRUCTIONS







ALPHANUMERIC INPUTS

To enter channel, favourites and satellite names, use the key pad that is displayed (see screenshot on the right). Select the desired letters/symbols using the number keys on your remote control. Press the  button to delete the last position or press the  (red) button to delete the entire name. Once you have selected all letters/symbols, press the  button to save your entry.



LANGUAGE SELECTION - OSD

The language for the on-screen display is set as follows:

 →   → User Preferences →  → Language Setup →  →   → German

The languages available are German, English, Italian, French, Dutch, Polish, Spanish and Turkish.

You can now make the other possible settings:

- Subtitles language
- Audio language
- SI (Event) language

Settings are performed in the same way as the OSD language.

When you have made all the settings, press the  button to exit the menu and save your settings.

Press the  button to return directly to the TV picture.

SYMBOL CODES FOR THE RECEIVER DISPLAY

Various symbols are occasionally shown in the receiver display above the normal display (channel name). These are not shown permanently, they are shown only for specific functions, procedures or channel features.

 USB port for the application

 Radio operation

 Pause

 Transmission is broadcast in HD

 Mute

 Recording in progress

 Hard disk in receiver active

 Play

 Encrypted broadcast

 Transmission is broadcast in Dolby Digital

 MP3 playback

 Rewind/Wind on

ON-SCREEN DISPLAYS (OSD)

CHANNEL INFORMATION

TV CHANNEL INFORMATION

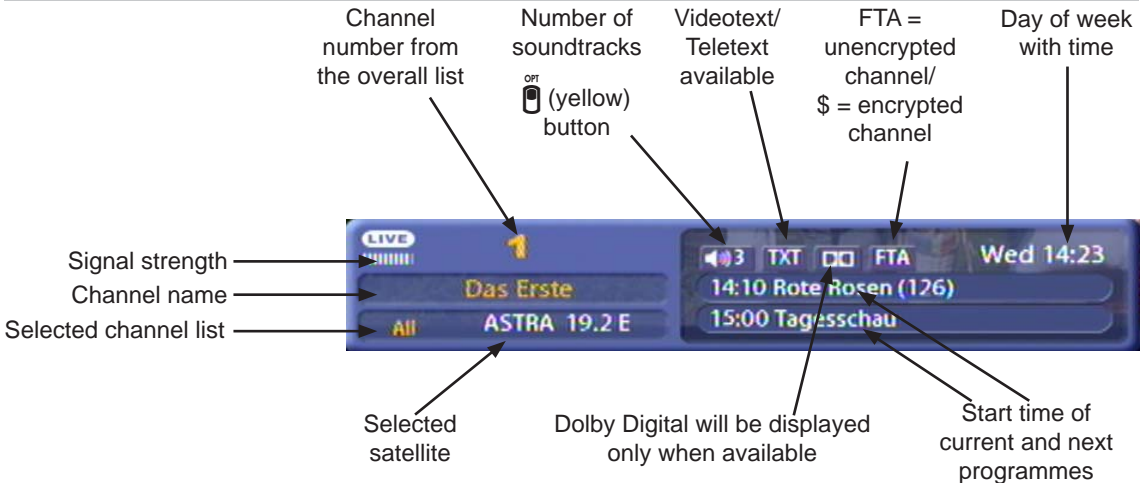

The channel notification is displayed for a few seconds (configurable on the "User Preference" menu under "Appearance Setup") every time you change channel, or can be displayed permanently by pressing the **i** button.

RADIO CHANNEL INFORMATION

The message for the set radio channel has the same layout. If a radio channel supports "Radiotext plus", you will see the display "RT+" alongside the channel identification. The available radio text is shown in the UFS 822 display.

CHANNEL INFORMATION

Press the **i** button twice to view information on the current channel, if transmitted by the channel provider. Use the **▲▼** buttons to scroll through the pages.

OPTIONAL CHANNELS

Some channels offer you the facility to select special optional channels (e.g. for football or Formula 1 broadcasts). Press the **OPT** (yellow) button once to view further soundtrack selection options, if these are transmitted by the channel provider. Use the **▲▼** buttons to scroll through the available channels and press the **OK** button to select them. Pressing the **OPT** (yellow) button a second time returns you to the normal options menu. Pressing the **OPT** (yellow) button again, or pressing the **EXIT** button exits this display again.

ON-SCREEN DISPLAYS (OSD)

ERROR SIGNALLING

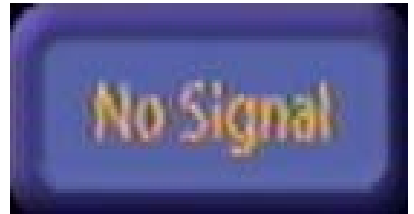

“No signal” indicates that an error has occurred in the reception system or in the receiver settings, or that the transponder is not transmitting.

Check the Sat IF connection and the LNB configuration. If you have changed settings, compare them against the basic settings (provided you had made a note of them as suggested).

TV/RADIO CHANNEL LIST



Press the **OK** button to access the channel list.

At the top left a TV set or radio icon indicates whether the list is a TV channel list or a radio channel list.

Press the **TV/R** (blue) button to switch between the TV and radio channel lists.

To the right of it you see the current channel list sort order as selected by you.



The channel list can display channels according to various selection and sort criteria, combined variably (see also the example screenshot at the bottom of the next page).





Selection options:

- Press the **FAV** (red) button to switch between your own Favorites lists and the list containing all the channels.
- Press the **SAT** (green) button to view only the channels from a specific satellite (e.g. ASTRA) or from all the satellites being received (corresponding to the “All channels” list).

ON-SCREEN DISPLAYS (OSD)

Sort options (accessed by pressing the  (yellow) button):

- Press the  (red) button to access the alphabetical listing. It shows all the channels sorted alphabetically, or the ones beginning with the selected initial letter.
- Press the  (green) button to sort the channels by provider, or to view the channels from a specific provider.
- Press the  (blue) button to sort the channels either by channel number, A-Z, Z-A, or by FTA and encoded (CI) channels.

Selections within the menus are made using the cursor buttons (   ) and are confirmed by pressing the  button (optional channels are displayed as Opt 01, Opt 02, etc. in the channel list)

Press the  button to view the following additional items of information on a channel (see example screenshot at left):

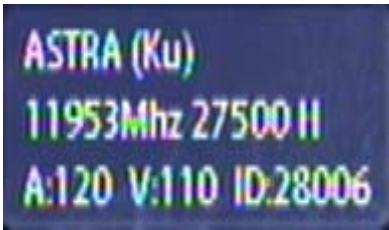

- Transmitting satellite
- Frequency (MHz)
- Symbol rate
- Polarisation
- Audio and video PID (Packet Identification Number, used to assign the data of a channel on the transponder)
- ID (Identification Number) of the channel on the transponder

The following screenshot is an example of how selection and sort criteria can be combined in the channel list (selection: TV channels from all satellites, sorted by: channel names beginning with "B"):



COMMON INTERFACE

IMPORTANT INFORMATION

Always follow the operating instructions from your Pay-TV provider and the instructions supplied with the Smartcard and the CA module!

Smartcards and CA modules are not included with this product!

The cards and modules are issued by the respective Pay TV providers, and contain the subscriber data and details of the channels for which the subscriber has paid. These channels are always encrypted.

Contact the Pay TV provider if you are interested in subscribing to a particular Pay TV channel.

You are responsible for the use of the Smartcard in the CA!

The Smartcard sold by the Pay TV provider, specific to a particular encryption technology, is inserted into the CA module.

Store your card and PIN code securely when not in use!



INSERTING THE SMARTCARD AND THE CA MODULE

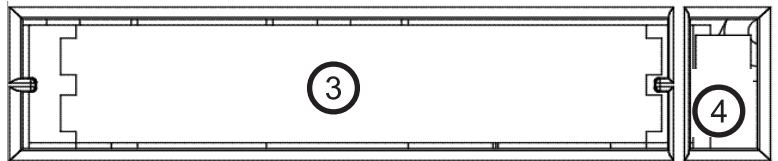
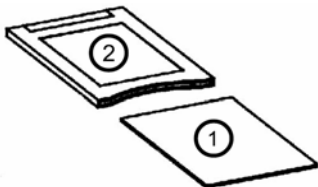

The Common Interface (CI) (3) of the UFS 822 is suitable for the use of two CA (Conditional Access) modules. These two CI slots are located at the bottom left on the front.

The CA module (2) accepts the SmartCard (1) (chip contacts pointing upwards and towards socket strip) and is then inserted into one of the two CI slots (3).

The Smartcard should be inserted into the CA module without excessive force. This also applies to inserting the CA module into the CI slot. Do not use excessive force, and follow the instructions supplied with the Smartcard and the CA module.

To remove the module, press the relevant eject button (4).

When you insert the module, the following message appears:

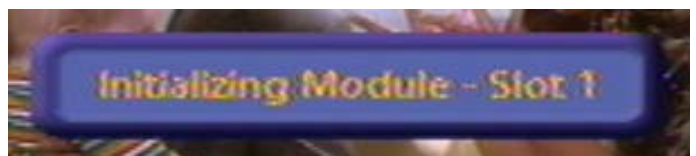

COMMON INTERFACE

You can find out which Conditional Access modules are in the CI slots on the UFS 822 and which Smartcard is in which CA module from the “Main Menu” under “System Setup”, and the “Common Interface” menu. Confirmation is by pressing the **OK** button.

The screenshots below depend on the specific module and card, and so are only intended as examples:

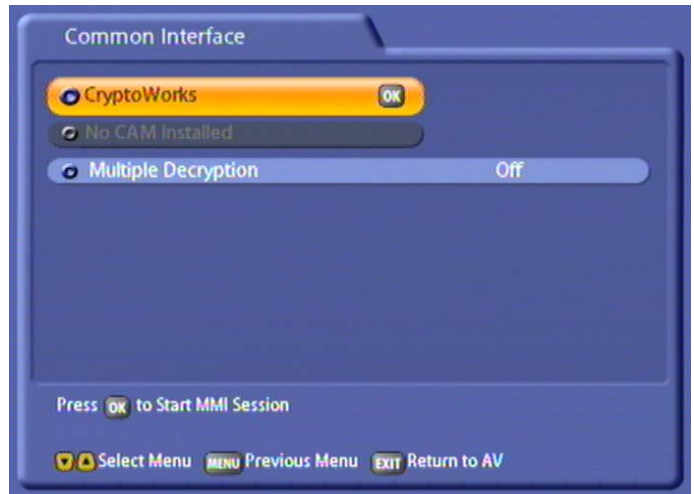

Pressing the **OK** button takes you to the menu generated by the CA module:

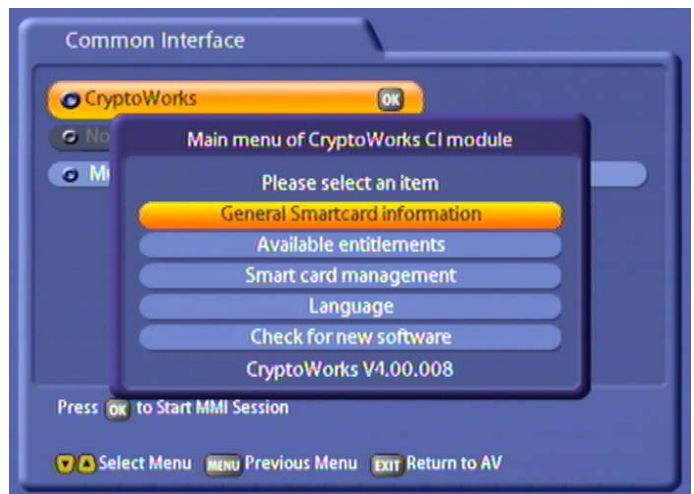



From this menu, your card and your PIN code allow you to access various channels from your Pay-TV provider.

“Alphacrypt Light” has been selected as an example here. The details can be different for each CA module. Always follow the instructions supplied by your pay TV provider!

Note: *The module displays may be shown in English, even if you have selected German as the menu language, because the menu is generated directly by the module!*

COMMON INTERFACE

MULTIPLE DECODING

If your CA module is capable of decoding multiple channels, you can press the   buttons to select whether the module should always decode only one channel (Off) or multiple channels (On).

If you select "Off", when making an unencrypted recording of an encrypted channel you cannot at the same time view an encrypted channel through the same CA module.

If you select "On", when making an unencrypted recording of an encrypted channel you can at the same time view an encrypted channel through the same CA module and the currently selected transponder. The number of encrypted channel that you can view at the same time depends on the CA module you are using.

Note: *You cannot at the same time make unencrypted recordings from two encrypted channels that are being decoded by different CA modules.*

Information for Conax, SECA, Viaccess and CryptoWorks users:

Note that with monthly activation intervals, the programme providers have different procedures for activating pay TV cards. Activation may therefore be a few days before or after the beginning of a new month. During this activation period, the CA module and card must be in the slot, and the receiver must be turned on a set to the booked Pay TV channel.

Follow the instructions from the Pay TV provider.

If your Pay TV card is then still not enabled, we recommend you briefly withdraw the CA module with the card out of the slot, with the receiver switched on, and then re-insert it.







This information has nothing to do with the properties of the unit; it is merely intended to assist you.

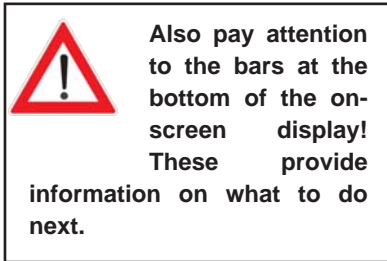





SYSTEM SETUP



The selected menus, sub-menus and positions, as well as the parameters to be set, are each highlighted in colour. The menus are to a large extent self-explanatory.



Select the “System Setup” menu using the menu button , the   buttons on the main menu and .



Use the   buttons to select further options. If there is another sub-menu layer, press the  button to open it. If there are no more sub-menus, make the settings using the     or numeric pad.

Press the  button to save your settings and return to the previous menu. Press the  button to return directly to the TV picture.

SYSTEM SETUP

TV SETTINGS

Press the  button to access the "TV Settings" menu. The following screen appears:



AV SETTINGS

VIDEO OUTPUT

Select the type of video signal at the Scart socket here. Select the signal that your TV set can process. **Refer to the operating instructions for your television set!**

- FBAS – composite colour baseband signal (colour/picture/blanking/synchronisation signal)
- RGB – Red/Green/Blue signal or
- Y/C – S-Video signal (luminance/chrominance)
- YUV – component data

AUDIO OUTPUT

Select the type of audio signal at the Scart socket here:

- Stereo – Left and right side audio channel
- Mono left – Left side audio channel only
- Mono right – Right side audio channel only

You will need to select further audio settings for the specific channel (such as Dolby Digital playback) directly on the TV screen using the  (yellow) button.

SYSTEM SETUP

TV TYPE

Here select the TV's picture format. Either

- 4:3 format,
- 16:9 format or
- HDMI

DISPLAY FORMAT

Select the screen display mode here:

- for TV type "4:3": "Pan & Scan" or "Letter-Box"
- for TV type "16:9": "Automatic" or "Always 16:9"
- for TV type "HDMI": "Automatic" or "Always 16:9"

SEPARATE CHANNEL VOLUME

Choose whether the volume setting is to be applied to all channels here (selection: Off), or whether you want to set the volume for each channel separately (selection: On).

OSD POSITION SETUP

You can use the cursor buttons () to select and arrange the position where the menus are displayed on the TV screen. The receiver displays are then positioned on-screen as you specified.

TV STANDARD

Here you specify whether your TV set is a

- PAL or
- NTSC deviceset.

HDMI MODE

Here you set the picture resolution that will be sent to your TV set from the HDMI connection. Either

- 1080i
- 576p or
- 720p

TIME SETUP

Press the  button to access the "Time Setup" menu. Depending on the setting ("Manual" or "Auto"), you see the following:

SYSTEM SETUP

If the time setting is "Manual", the time setting will be performed after an **tv tv** update in standby. If the Astra satellite is installed, the time setting will be performed from "Das Erste". If Astra is not installed, the time setting will be performed from channel 1 of the channel list.



TIME MODE

Select the time mode here:

- Manual or
- Auto (receiver takes time from preset channel)

TIME MODE MANUAL

SET LOCAL TIME

Set the variance from UMTC (Universal Mean Time Coordinate; formerly Greenwich Mean Time) here. At the bottom of the screen you see a listing of major cities to provide an indication of which time zone you have just set:

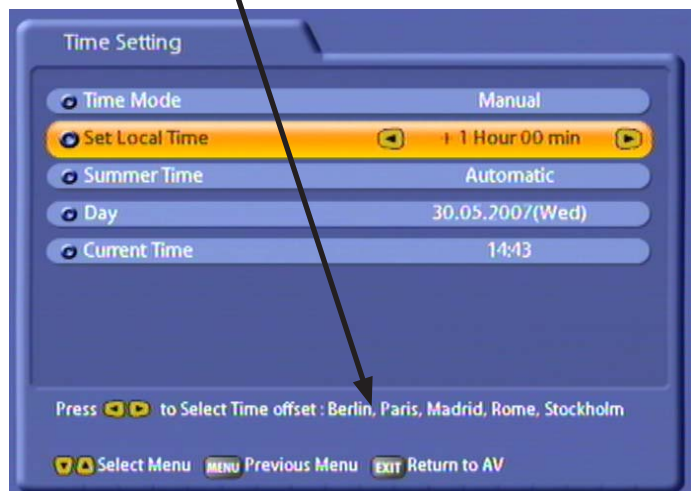

SYSTEM SETUP

SUMMER TIME/WINTER TIME

Choose between Summer and Winter time. In the example on the previous page, Summer time was selected.

DAY

Select the current date here. Press the **OK** button to display a calendar. Select the day using the cursor buttons (**▲▼◀▶**). If the right month and year are not displayed, you can select as follows:

- Previous month (**FAV** (red) button)
- Next month (**POP** (green) button)
- Previous year (**OPT** (yellow) button)
- Next year (**TVR** (blue) button)

Press the **OK** button to confirm your selection.

CURRENT TIME

Use the numeric pad to key in the current time here. The position at which the number needs to be entered is automatically underlined.

TIME MODE AUTO

If the time setting is "Automatic", the time setting will be performed after a TVTV update in standby. You influence the choice of channel responsible for time updating in "Main menu", "System Setup" and "Time Setup".

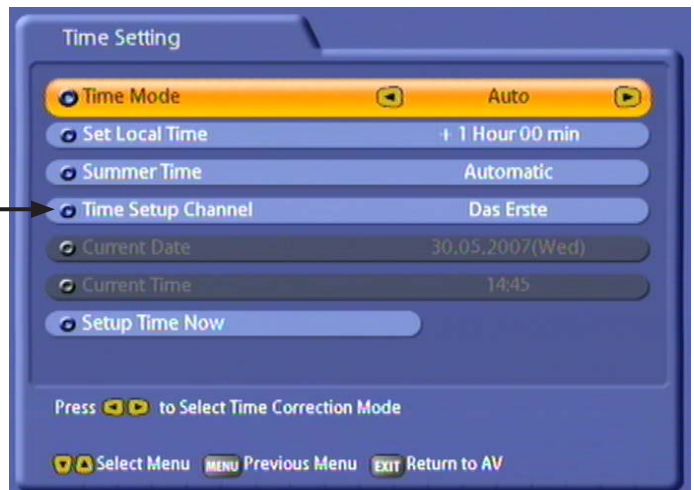

SET LOCAL TIME

See "Set Local Time" - "Time Mode Manual"

SYSTEM SETUP

SUMMER TIME/WINTER TIME

Choose between Summer and Winter time. In the example on the previous page, Summer time was selected.

TIME SETUP CHANNEL

If you have selected automatic time mode, set the channel here from which you want the receiver to get the time. Press the **OK** button to call up a channel list from which you can select the channel you want using the **▲▼** buttons. Press the **OK** button to confirm your selection.

SETUP TIME NOW

Confirm with the **OK** button to update the time immediately.

COMMON INTERFACE

See “Common Interface” section

SYSTEM SETUP

STB MANAGEMENT

Press the **OK** button to access the “STB Management” menu. The following screen appears:

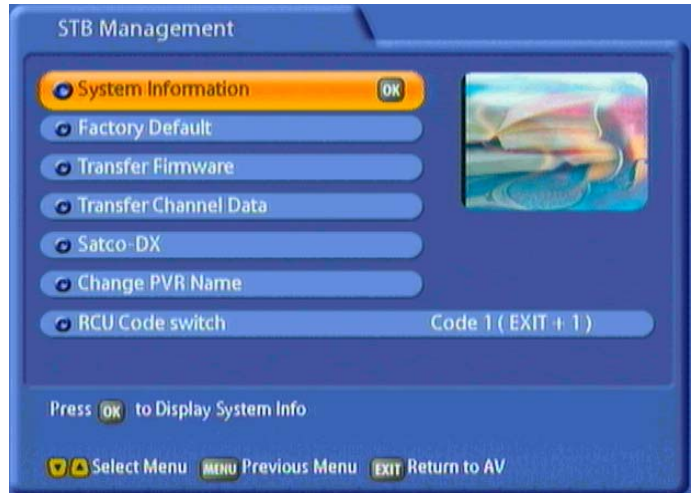

SYSTEM INFORMATION

Press the **OK** button to view the current software version. Press the **OK** button again to close the display.

FACTORY DEFAULT

When you press the **OK** button you are asked whether you want to reset all settings to their factory defaults. Use the **←** **→** buttons to select “OK” and start the reset by pressing the **OK** button.



All your personal preferences will be deleted (favorites lists, channel sort, etc.)!

TRANSFER FIRMWARE

Transfer the operating software from one UFS 822 to another UFS 822. Not yet available in this software version.

TRANSFER CHANNEL DATA

Transfer the channel list from one UFS 822 to another UFS 822. See “Receiver to Receiver Data Transfer” section.

SYSTEM SETUP

SATCO-DX

Download satellite channel lists from the Internet at "http://www.satcodx.com/".
See "PVR Manager (USB Tool)" section.

CHANGE PVR NAME

Press the **OK** button and enter the unit ID here. This is useful for identification in case of theft. The alphanumeric input procedure is as described in the "Alphanumeric Inputs" section. In the example shown here the ID "UFS 822" has been assigned.

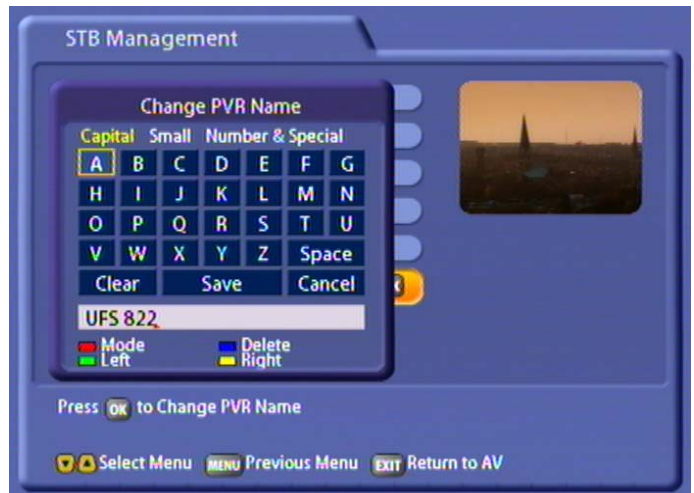

REMOTE CONTROL CODE

Use the **Left** and **Right** buttons to select one of the four existing remote control codes. Once you have selected one of the codes, the following display appears:

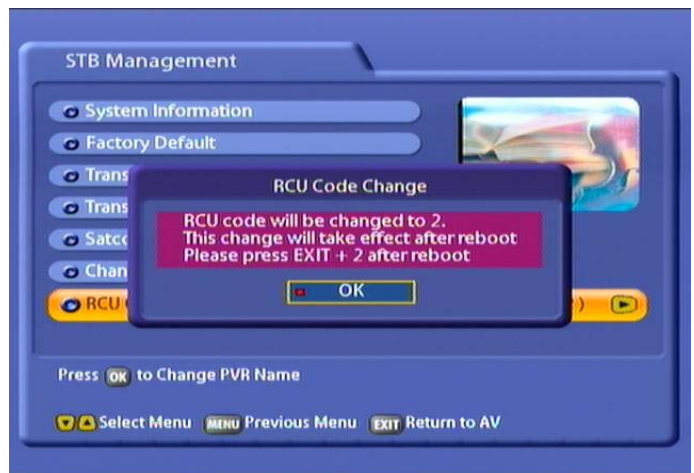

Confirm the displayed message with the **OK** button. The next time you switch on your receiver, your UFS 822 will display the following message (example): **RCU 2 (Exit + 2)**. Now, you just have to change your remote control code to **RCU 2**. To do this, simultaneously press the remote control keys **EXIT** and **2** for a period of two seconds. The remote control code has now been switched to **RCU 2**.

HDD MANAGEMENT

Press the **OK** button to access the "HDD Management" menu. The following screen appears:

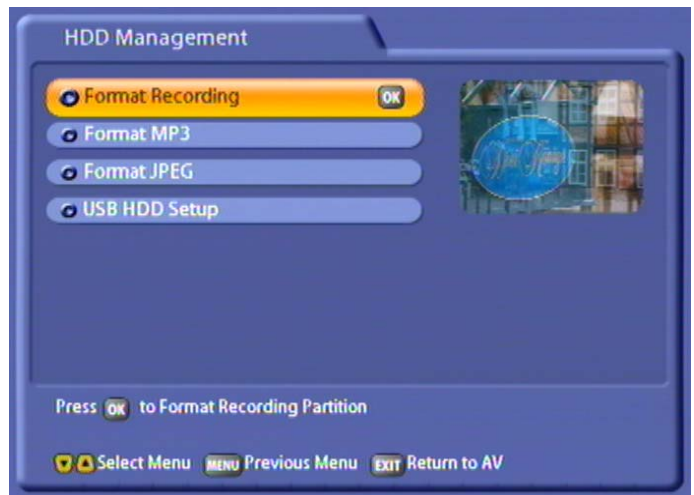

FORMAT RECORDING LIST

When you press the **OK** button you are asked whether you want to delete all recordings. Use the **◀▶** buttons to select "OK" and start the reset by pressing the **OK** button.



All the recordings on the hard disk are irrevocably deleted!

FORMAT MP3 ARCHIVE

When you press the **OK** button you are asked whether you want to delete all MP3 files. Use the **◀▶** buttons to select "OK" and start the reset by pressing the **OK** button.



All the MP3 files on the hard disk are irrevocably deleted!

SYSTEM SETUP

FORMAT PHOTO ARCHIVE

When you press the **OK** button you are asked whether you want to delete all photos/images. Use the **◀▶** buttons to select "OK" and start the reset by pressing the **OK** button.



All the photos on the hard disk will be irrevocably deleted!

USB HDD SETUP

If the **OK** button is pressed, the receiver displays to you the leading data on the storage medium currently connected to the USB port. The following display appears (example):



Pressing the **OK** button opens the selection field for formatting the storage medium. The following screen appears:



Your external storage medium must be "FAT 32" formatted.

If your external storage medium has not been formatted to "FAT 32", you can undertake this here.

SYSTEM SETUP

Use the ◀▶ buttons to select the transponder frequency and type of partitioning. You have the following options:

- Option 1: Type of formatting FAT 32, complete hard disk (for Windows XP, MAC, Linux user)
- Option 2: Type of formatting EXT3, max. 100 GB partitions (for Linux and experienced Windows users)
- Option 3: Type of formatting FAT 32, three 32 GB partitions, the remainder of the storage volume formatted as for option 2 (for Windows 2000 and earlier Windows versions)



Formatting irrevocably deletes all data on the storage medium!

Use the ▼▲ buttons to select “OK” and start the reset by pressing the OK button. The following message appears:



Use the ◀▶ buttons to select “OK” and start the reset by pressing the OK button.

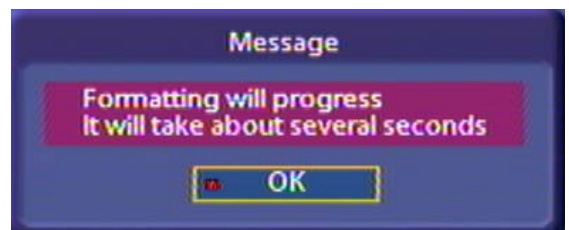
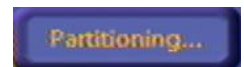



Press the OK button. For formatting, the receiver switches briefly into standby mode, but the display shows you the progress of the formatting operation. The receiver then automatically goes back into operation.

This indicates that the formatting is complete.

SYSTEM SETUP

RADIO TEXT

Press the   buttons to select whether or not the receiver should display the radio text when in radio mode (this option is available only from software version 1.2).

ETHERNET SETUP



These settings should not be made unless the receiver is linked into a network or is linked to a PC/laptop using a crossed over network cable.

The Ethernet interface used in the receiver is a 10/100 base T Ethernet interface.



Press the  button to access the "Ethernet Setup" menu. The following display appears (example):



If you wish to connect your receiver to a DHCP server, use the   buttons to select the "On" setting. If you wish to connect your receiver to a PC or laptop, the DHCP setting must be "Off".

SYSTEM SETUP

Note: Refer to our network function connection examples at the end of this manual and the instructions on this subject available on the Internet under “www.kathrein.de” “Service” → “Software and Downloading” → “Receiver” → “UFS 822”.

DHCP “On”



Use the buttons to select the “Get IP Address” field and confirm by pressing the button. Your DHCP server now indicates the IP address to the receiver. As soon as the receiver has been assigned its IP address by the DHCP server (IP address is displayed), press the buttons to switch to the “Save” field and press the button to confirm.

DHCP “Off”



Perform the settings for your network as required. Use the buttons to select the lines to be changed; make the changes using the numeric keypad. When you have completed all the settings, press the buttons to switch back to the “Save” field and press the button to confirm.

Configuration example:

Receiver:

IP Address: 192.168.0.11
Subnet Mask: 255.255.255.0

PC/Laptop:

IP Address: 192.168.0.10
Subnet Mask: 255.255.255.0



If with the “DHCP On” setting no connection can be established between the receiver and DHCP server/router, switch the setting to “DHCP Off” and perform the setting as described for (DHCP “Off”).

USER PREFERENCES



Select the “User Preference” menu using the menu button **MENU**, the **▲▼** buttons on the main menu and **OK**.

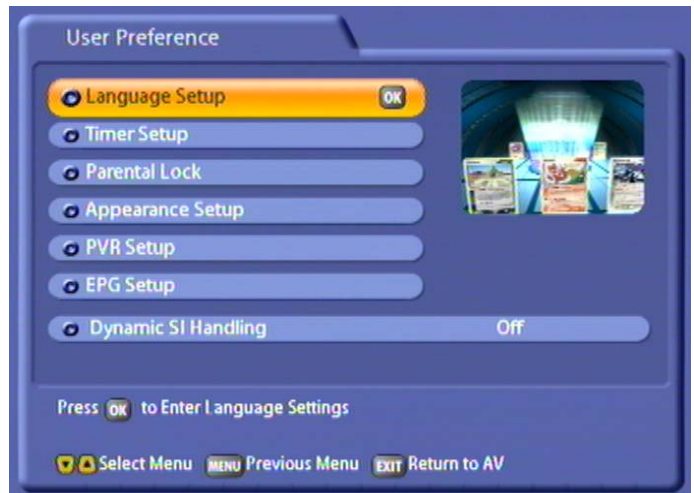

Use the **▲▼** buttons to select further options. If there is another sub-menu layer, press the **OK** button to open it. If there are no more sub-menus, make the settings using the **◀▶▲▼** or numeric pad.

Press the **MENU** button to save your settings and return to the previous menu. Press the **EXIT** button to return directly to the TV picture.

USER PREFERENCES

LANGUAGE SETTINGS

See "Operating Instructions" section under "Language Selection - OSD". In this menu you can select the language for the menu, the subtitles, the audio and the programme.

SLEEP TIMER

Use the ◀▶ buttons to select the time after which you want the UFS 822 to automatically switch off (standby). The minimum time you can set is 15 minutes, and the maximum 360 minutes. Each press of the

◀▶ buttons increases or reduces the power-off time by 15 minutes. The calculated time at which the receiver will switch off is shown in the grey bar underneath.

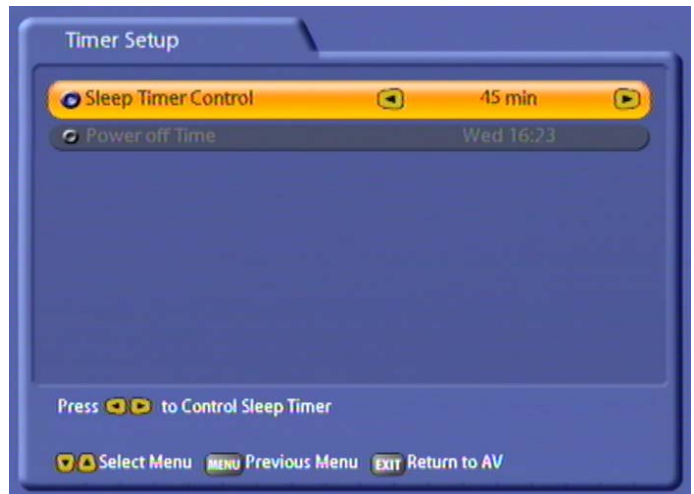

PARENTAL CONTROL

This menu is password-protected and can only be accessed by entering the password. The factory default password is "0000". The following screen appears:

USER PREFERENCES

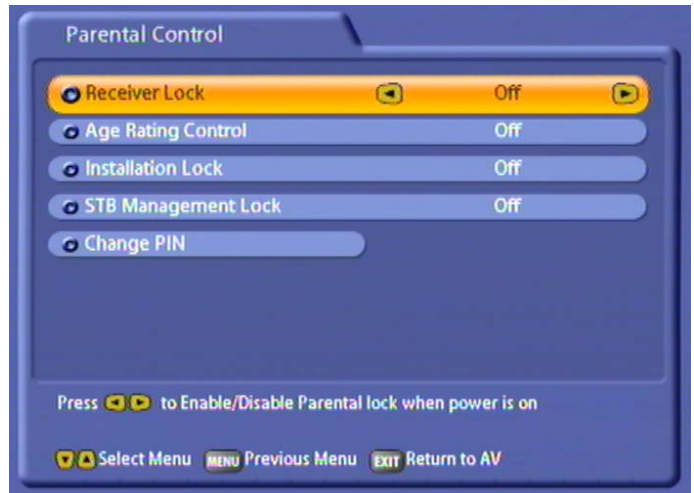

RECEIVER LOCK

Use the buttons (On/Off) to choose whether use of the receiver should be protected by a four-digit PIN. When switching the unit on from Standby, you are then prompted to enter the PIN. If the PIN is not entered the receiver cannot be operated.

AGE RATING CONTROL

Use the buttons to select the age rating to watch TV programmes. The minimum age rating you can set is "under 4", and the maximum "under 18". Each press of the buttons increases or reduces the age rating by 2 years. The channels concerned can then only be viewed by entering the PIN.



This lock is only effective if the necessary locking signals are transmitted.

INSTALLATION LOCK

Use the buttons (On/Off), to select whether settings/modifications can be made in the installation menu without entering a PIN code.

STB MANAGEMENT LOCK

Use the buttons (On/Off) to select whether settings/changes on the STB Management menu (a sub-menu of the System Setup menu) may be made without entering the PIN or not.

USER PREFERENCES

CHANGE PIN

Press the **OK** button to replace the old PIN with a new one. Enter the new (four-digit) PIN. For security you must repeat the new PIN code once again. On the screen which then appears use the **◀ ▶** buttons to select "OK" and confirm the changed PIN by pressing the **OK** button.



Keep your password in a safe place, so that you always have access to your channels should you ever forget it.

If you have forgotten your password, you must contact your dealer, who will be able to unlock your receiver for you.

DISPLAY SETTINGS

On this menu you can set how long the channel notification and the playback information are displayed on-screen. You can also specify whether the volume bar is displayed when adjusting the volume.

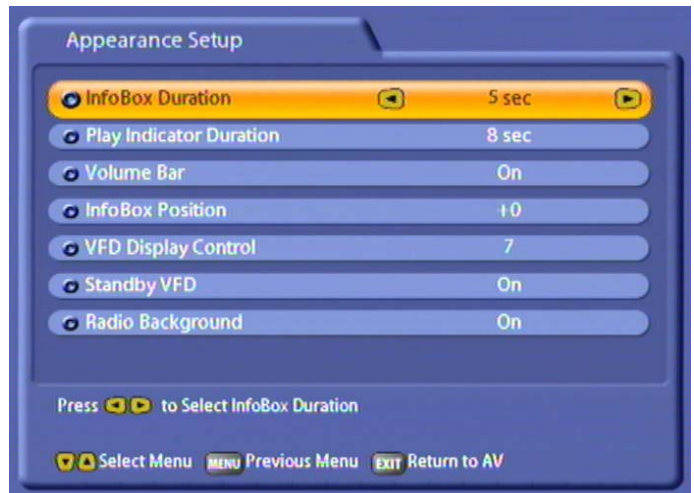



INFOBOX DURATION



Use the **◀ ▶** buttons to select the time after which you want the on-screen channel notification display to be automatically cancelled. You can choose between 5, 8, 10, 12 and 15 seconds, or "Hide".

USER PREFERENCES



PLAY INDICATOR DURATION

Use the   buttons to select the time after which you want the on-screen play information display to be automatically cancelled. You can choose between 5, 8, 10, 12 and 15 seconds, or "Hide".

DISPLAYING THE VOLUME BAR

Use the   buttons (On/Off) to specify whether the volume bar is displayed when adjusting the volume.



INFOBOX POSITION

Use the   buttons (+0 to +10) to select the vertical position of the channel notification. This function allows you to move the channel notification further up the screen (may be necessary if a channel notification is cut off by the bottom edge of the screen because of the zoom factors of the TV set).



VFD DISPLAY CONTROL

Use the   buttons (1 to 7) to select the desired brightness for the display of the receiver.

STANDBY VFD

Use the   buttons (On/Off) to select whether the display of the receiver is switched on or off when in standby mode.

RADIO BACKGROUND

Use the   buttons (On/Off) to select whether the radio background image is shown in radio operation, or the screen is switched to black.

USER PREFERENCES

PVR SETUP

On this menu you can make settings for your recordings and for timeshifting.



AUTOMATIC TIMESHIFT

Use the [Left] [Right] buttons to select whether automatic timeshifting is enabled or disabled. When you select "On" the receiver automatically (in the background) starts recording the programme you are viewing as soon as you switch to the channel. Then, in manual record mode, you can press the [Red] (red) button to choose whether to record the programme from the current time or from the time you switched to the channel. The advantage of this is that you do not lose the part of the programme you were watching before you decided to record it! When you select "Off" you can only record the programme as from the point you press Record, and lose the portion of the programme before you started recording.

TIMESHIFT BUFFER SIZE

Use the [Left] [Right] buttons here to select the size of the background buffer the receiver makes available for timeshift recording. You can choose between 1 and 8 GB, in 1 GB increments. The receiver indicates in brackets after the GB figure how long this will enable it to background-record for.

DISK MANAGEMENT

Use the [Left] [Right] buttons to select whether hard disk management is controlled by the receiver "Automatic" or by you "Manual".

If you select "Automatic", the receiver automatically deletes older recordings when it reaches the maximum disk capacity, so as to make room for planned recordings. (You can, however, protect recordings from being deleted by the receiver, as described in the "Recording List" section under "Edit Recordings" - "Deletion Block".)

If you select "Manual" you must always ensure there is sufficient hard disk capacity yourself. If the available disk capacity falls below five percent, a warning appears the next time you restart the unit.

USER PREFERENCES

ONE-TOUCH RECORDING INFO WINDOW



Use the ◀▶ buttons here to select whether to enable on-screen display of the advanced recording settings on starting (press the ● (red) button) or not. If you select “Disable”, in manual recording mode, timeshift recording is automatically started (see “Recording” section). Other recording modes are then excluded.

DEFAULT RECORD DURATION

Use the ◀▶ buttons here to select the default recording time. If you forget to stop a recording you started manually, it is automatically stopped by the receiver when the default recording time elapses. You can choose a value between 30 minutes and 4 hours, in 30 minute increments.

SAVE

When you have made all the settings, press the OK button to save them.



EPG GRABBING SETUP

On this menu use the ◀▶ buttons to set the time at which you want the UFS 822 to update the EPG data. The receiver (which must be in Standby mode) switches on from Standby, updates the data and then returns to standby. Scheduled recordings do not affect this; the receiver then carries out the update automatically later when recording is finished.

If you set the “EPG Grabbing” to “Off”, the tvtv EPG will not be updated at any time, and the existing tvtv file will be deleted. The EPG then refers back to the SI data (EPG data) sent out by the channel providers. If you set the “EPG Grabbing” back to “On”, you must first update the tvtv data before you can use the



tvvtv EPG again. To do this, press the ⏻ button to switch the receiver into standby mode and wait whilst the update starts up and completes the process.

USER PREFERENCES



If the tvtv EPG data are older than 36 hours, or had previously been deleted by the “Invalidate tvtv-data” command, the receiver updates the tvtv EPG data automatically, provided that the  button had been pressed to place the receiver in standby mode. The update can be interrupted by pressing the  button a second time.





RECORDING LEADING OFFSET

Here use the   buttons to select the number of minutes before the time set in the EPG at which the recording should start. You can choose a value between 1 minute and 10 minutes, in 1 minute increments. The recording will start that number of minutes before the due time. This allows a contingency for small variations in transmission times. Unwanted parts of the recording can later be discarded, as described in the Chapter “Recording List” under “Edit Recordings”, “Cut”.



RECORDING FOLLOWING OFFSET

Here use the   buttons to select the number of minutes after the time set in the EPG for which the recording should run on. You can choose a value between 1 minute and 30 minutes, in 1 minute increments. The recording will stop that number of minutes after the due time. This allows a contingency for small variations in transmission times. Unwanted parts of the recording can later be discarded, as described in the Chapter “Recording List” under “Edit Recordings”, “Cut”.

INVALIDATE TVTV-DATA

In this menu you can use the  button to delete the stored tvtv data. You can then have the UFS 822 update the tvtv data at the selected time or press  to switch your receiver to standby. The receiver automatically starts updating the tvtv data. The progress of the tvtv data update is indicated on-screen. After updating the data, the receiver automatically switches back to Standby. You can now restart the receiver by pressing the  button.

DYNAMIC SI HANDLING

Use the   buttons to select “On” or “Off”. When the receiver is switched on, it automatically uses the program names broadcast by the transmitter. Setting this to “Off” allows you to change the program names, and prevents the receiver automatically changing those names back to the broadcast setting.

VIDEOTEXT (TELETEXT)



This symbol in the channel notification shows you whether Videotext/Teletext is available for the selected channel.











When you press the  button, the receiver processes the broadcast Videotext/Teletext service for your TV set to display, even when the signal is encrypted.

During the search, the page which is being searched for is displayed in the top left-hand corner with the time and date displayed at the top right.







When the search is finished, the videotext/Teletext being broadcast by the relevant encrypted provider appears:

You have several options for calling up the desired pages:





- Input with the numeric pad
- Scroll through using the   buttons
- Select one of the links on the current page (at the top of the screen, e.g. pages 133, 135, 116, ...) using the   buttons and open by pressing the  button
- Select the options shown at the bottom end by pressing the respective coloured button ( (blue),  (yellow),  (green) and  (red))
- Scroll up and down in the sub-pages (e.g. 1/2 and 2/2) using the   buttons

Use the -buttons to scroll between the pages most recently selected/called up.

Pressing the  button repeatedly allows you to display the Videotext in three transparent stages. Pressing the  button a fourth time causes the Videotext to revert to its normal form.

Press the  button or  button to exit Videotext. When you next call up Videotext it will automatically open at the Videotext page you last selected.



ORGANIZE CHANNELS

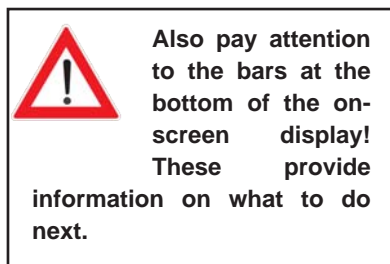

Select the "Organize Channels" menu using the menu button , the   buttons on the main menu and .

This menu is password-protected and can only be accessed by entering the password. The factory default password is "0000".

The factory pre-programmed channel lists can be changed on this menu. You can organise and sort your preferred TV and radio channels, such as all English-language channels or those that broadcast with no commercial breaks.



Use the   buttons to select further options. If there is another sub-menu layer, press the  button to open it.

Press the  button to save your settings and return to the previous menu. Press the  button to return directly to the TV picture.

ORGANIZE CHANNELS

EDIT TV CHANNELS



LOCK CHANNELS

Select the channel you want to lock using the cursor buttons (**▲** **▼** **◀** **▶**) and press the **OK** button to activate the lock. Press **OK** again to unlock the channel.

You can also sort the channels first, according to the following criteria:

- by satellite **FP** (green) button
- by favorites list **OPT** (yellow) button
- by alphabetical or numerical sequence **TNR** (blue) button



Select the sort order you want to apply using the **▲** **▼** buttons and confirm with the **OK** button.

RENAME CHANNELS

Select the channel you want to rename, using the cursor buttons (**▲** **▼** **◀** **▶**), and press the **OK** button to open the keyboard. You can now rename the channel as you want, applying the method described in the “Alphanumeric Inputs” section.





You can also sort the channels first, according to the following criteria:

ORGANIZE CHANNELS

- by satellite  (green) button
- by favorites list  (yellow) button
- by alphabetical or numerical sequence  (red) button







Select the sort order you want to apply using the   buttons and confirm with the  button.

REARRANGE CHANNELS

Select the channel you want to move, using the cursor buttons (   ), and press the  button.



You can now move the channel to the intended channel number using the cursor buttons, then press  again to insert it there.

SKIP CHANNELS

Go to the channel you want to skip during zapping using the cursor buttons (   ) and press the  button to select it. The channel name is displayed in grey. Press the  button again to cancel the skip.

All the channels marked “Skip” will be omitted from the EPG and the channel list!

You can also sort the channels first, according to the following criteria:

- by satellite  (green) button
- by favorites list  (yellow) button
- by alphabetical or numerical sequence  (blue) button

Select the sort order you want to apply using the   buttons and confirm with the  button.

ORGANIZE CHANNELS

DELETE CHANNELS

Select the channel you want to delete using the cursor buttons (**▲▼◀▶**) and press the **OK** button to mark it as deleted. The channel name is underlined in red. Press the **OK** button again to cancel your channel selection for deletion (this will only work as long as you have not yet quit the menu by pressing the **MENU** button).



Deleted channels can only be relocated by a channel search!

You can also sort the channels first, according to the following criteria:

- by satellite (**FP** (green) button)
- by favorites list (**OF** (yellow) button)
- by alphabetical or numerical sequence (**TVB** (blue) button)

Select the sort order you want to apply using the **▲▼** buttons and confirm with the **OK** button.

You can also press the **FAV** (red) button to select all channels at once, or cancel the global selection.

EDIT RADIO CHANNELS

Press the **OK** button to access the “Edit Radio Channels” menu. The following screen appears:



ORGANIZE CHANNELS

The functions on the “Edit Radio Channels” menu are controlled in the same way as those on the “Edit TV Channels” menu.

EDIT TV FAVORITES

Press the **OK** button to access the “Edit TV Favorites” menu. The following screen appears:

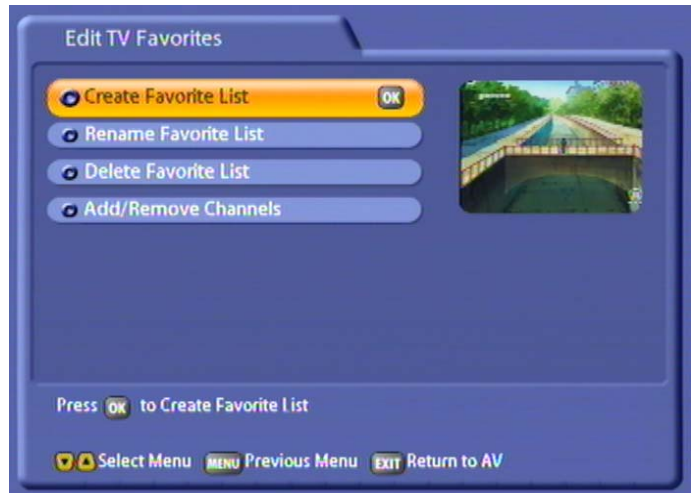

CREATE FAVORITE LIST

Press the **OK** button to access the menu. You can now use the on-screen keypad (operated as described under “Alphanumeric Inputs”) to name the next free Favorites list. You can set up a total of eight favorites lists (incl. radio) for your favorite TV channels.

Each family member can then save their own favorite channels and call them up at any time.

RENAME FAVORITE LIST

Press the **OK** button to access the menu. Select the favorites list you want to rename using the **▲▼** buttons and confirm the selection with the **OK** button. You can now use the on-screen keypad (operated as described under “Alphanumeric Inputs”) to name or rename the favorites list.

DELETE FAVORITES LIST

Press the **OK** button to access the menu. Select the favorites list you want to delete using the **▲▼** buttons and confirm its deletion with the **OK** button. Use the **◀▶** buttons to select “OK” and confirm again by pressing the **OK** button.



ORGANIZE CHANNELS

Note: Only the favorites list is deleted; the channels in the favorites list are retained.



ADD/REMOVE CHANNELS (FAVORITE LIST)

Press the  button to access the menu. Use the  buttons to select the favorites list to/from which you want to add or delete channels and confirm your selection with the  button.

Add:





Use the  buttons (one channel up/down) or the  buttons (sideways) to select the channel you want and press the  button to transfer it into the favorites list. You can add more channels to the current selected favorites list in the same way.

You can also sort the channels first, according to the following criteria:

- by satellite  (green) button
- by alphabetical or numerical sequence  (blue) button

Select the sort order you want to apply using the  buttons and confirm with the  button.

Remove:

Press the  (red) button to switch to the right-hand list (listing of channels in favorites list). Use the  buttons (one channel up/down) or the  buttons (sideways) to select the channel you want and press the  button to delete it from the favorites list. You can remove more channels from the current selected favorites list in the same way.

EDIT RADIO FAVORITES

Press the  button to access the “Edit Radio Favorites” menu. The radio favorite channels are edited in the same way as the TV favorite channels.

TWIN FUNCTIONS

The UFS 822 is equipped with two tuners, enabling you to perform two separate functions at the same time, this includes the functions:

- Picture-in-Picture (PIP),
- Timeshift and
- One-touch recording.

PICTURE-IN-PICTURE (PIP)

The picture-in-picture function permits simultaneous viewing of two programmes. This allows you to see when a programme you want to watch begins without having to exit the programme you are currently watching. Due to its small size, the PIP window is only intended to be used for control purposes and is thus not suitable for viewing complete broadcasts.



When you press the green  button the first time a window opens up in the top right-hand corner. The channel is indicated underneath the picture:



CHANNEL SELECTION IN THE MAIN PICTURE

You can still change channel in the main picture with the channel buttons  in the usual way.

CHANNEL SELECTION IN THE PIP

The channel in the PIP window can be changed using the   buttons, working in the sequence shown in the currently selected channel list.

CHANNEL SWITCH BETWEEN MAIN PICTURE AND PIP

The  button allows switching between the two channels being received (main picture and PIP).



TWIN FUNCTIONS



Press the green  button a second time to view a picture played back from the hard disk in the PIP window (see screenshot example on the next page):

- If the programme is currently being recorded, the PIP is framed in red
- If the PIP a programme that was recorded previously it is framed in yellow

The picture caption is prefixed by an H (for hard disk) and the serial number.

Press the green  button again or the  button to exit the PIP function.

TIMESHIFT

The timeshift function is described in the “Timeshift” section. Note that the receiver switches to hard disk mode when executing this function.

ONE-TOUCH RECORDING

One-touch recording is described in the “Recording” section.

TIMESHIFT

TIMESHIFT

If you cannot catch the beginning of a programme because you are occupied with something else, or if you have to break off watching whilst a programme is being transmitted, you can watch it in timeshift mode. Press the **⏸** button to activate this function. The receiver continues recording the programme in the background while you see a freeze-frame with an inset circular icon and the pause button (see screenshot):



Once you have viewed the programme in full it is not available for you to retrieve from the hard disk! To save a programme to the hard disk, you must record it as described in the "Recording" section.



"TSR" (Timeshift Recording) is shown on the receiver display in front of the channel number and name.

To start timeshifted playback, press the **▶** button or **⏸** button. You can control the recorder fast forward (to the point the broadcast has currently reached), rewind (to the point at which you started recording the programme), pause and playback functions by the corresponding buttons. If you press the **⏸** button the TV picture freezes, but the recording continues in the background. Press the **⏸** button or the **▶** button again to resume viewing.

You can cancel timeshifted playback any time by pressing the **■** button.

TVTV EPG AND TIMER

The **tvvtv** EPG is a latest-generation Electronic Programme Guide. It provides all the EPG information for around 60 TV channels at no charge, without you having to change channel, and also offers schedule information up to a week ahead (depending on programme provider).

ACCESSING THE TVTV EPG FOR THE FIRST TIME

Press the **EPG** button to access the **tvvtv** EPG. The first time you access it (if you have not yet run an ASTRA satellite scan and the **tvvtv** data have not yet been updated!) you see the following on-screen display:

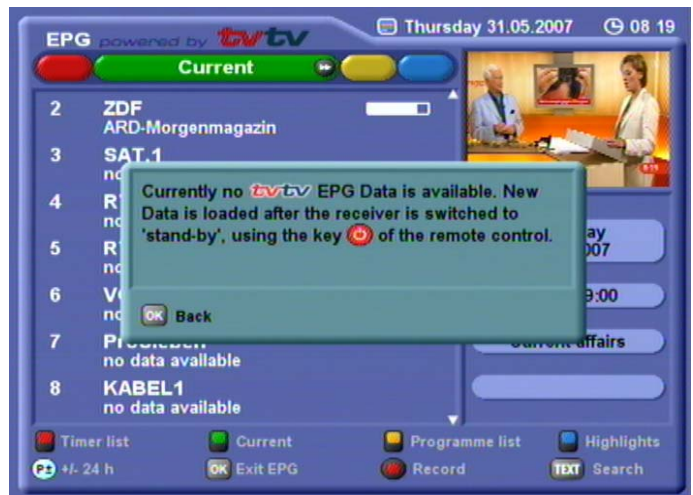

Press the **OK** button to close the display. Exit the **tvvtv** EPG by pressing the **EXIT** button. You now have two options for updating the **tvvtv** data:

- To get the data immediately, switch the receiver off by the **Power** button. The receiver first displays the message "Receiving tvvtv", then the download status as a percentage (Downloading tvvtv ...%). As soon as the display no longer indicates this message, you can switch the receiver back on by pressing the **Power** button and begin using the **tvvtv** EPG.
- To download the data at a specific time when you will not be using the receiver, you can set a download time on the receiver as described under "User Preference" - "EPG Grabbing Setup".

ACCESSING THE TVTV EPG

The **tvvtv** EPG is accessed by pressing the **EPG** button, and automatically displays the "Current" view (see "Current" menu item), regardless of which **tvvtv** EPG view you had been in beforehand.





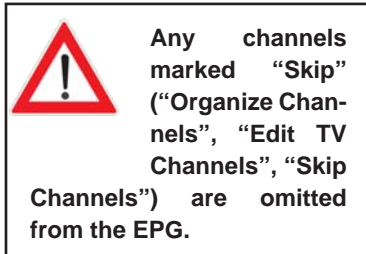

TVTV EPG AND TIMER





“CURRENT” VIEW

The **tvvtv** EPG automatically displays the “Current” view when first accessed, highlighting the current selected channel and the current programme.









In the main window you see the channel number at the left, the channel name and current programme in the centre, and a progress bar at the right. In the top right-hand corner of the picture you see the current day, date and time. The box at the right indicates the day, date and duration of the programme, the programme category (in the example above: “Documentation”), the programme’s country of origin and the year it was made. The bottom section of the display contains the **tvvtv** EPG options selectable from any EPG view. Press the

-  (red) button to view the “Timer list”,
-  (green) to view the “Current” display,
-  (yellow) to view the “Programme list” (for the selected channel),
-  (blue) to view the “Highlights” (one tip per day, a week ahead),
-  button to view details of the selected programme, and the
-  (red) to access the “Record” menu (the timer).

You can scroll line-by-line or page-by-page through the channels using the cursor buttons () or access channels directly using the numeric pad. With the  buttons you can scroll back and forth 24 hours at a time (day-by-day).

Press the  button to confirm your channel selection.



Press the  button to view the upcoming programme schedules in 15-minute blocks. Press the  button to return step-by-step to the start point (current time), or press the  (green) button to go back directly. Quit the EPG by pressing either the  button or the  button, or by pressing  twice.

TVTV EPG AND TIMER

CHANNEL LIST

Press the  (yellow) button to access the schedule for the channel to which you are currently tuned in the **tv tv** EPG. The following display appears (example):



Press the cursor buttons (, , , ) to scroll line-by-line or page-by-page through the programme list of the selected channel.

Press the   buttons to switch channels and then view the new channel's programme list.

The  symbol next to the programme title indicates programme details are available to view (see "Details").

Press the  (red) button to place your selected programme in the Record menu (see "Record").

With the  buttons you can scroll back and forth 24 hours at a time (day-by-day).

HIGHLIGHTS







Press the blue  (blue) button in the **tv tv** EPG to view the daily highlight tips. The following display appears (example):

TVTV EPG AND TIMER



A tip is shown for each day, up to a week ahead.

PROGRAMMES SORTED BY CATEGORY

You can use the   buttons to view the following programmes on the Highlights menu by category (e.g. Series, Sport, News, Magazine/Reportage, Kids ...). Within each category you can scroll line-by-line or page-by-page as usual using the cursor buttons (   ). Press the  (red) button to place your selected programme in the Record menu (see "Record").



TVTV EPG AND TIMER

SEARCH FUNCTION

Pressing the **TEXT** button on the **tv tv** EPG allows you to search through all the information available to the **tv tv** EPG (programme name, description, title, cast, director, details) for a word or phrase you enter, with the results being displayed in a list.

Press the **TEXT** button to switch to "Search". You can use the numeric pad to input letters in the search form. The assignment of letters to the numeric pad buttons is displayed at the bottom of the screen as follows:



Use the **◀▶** buttons to enter a space or to delete the last letter entered.

Press the **OK** button to start the search.



The results found are displayed at the left in the main display box. If the programmes found do not fit on one page, you can scroll page-by-page as well as line-by-line as usual using the cursor buttons (**▲▼◀▶**).

Press the **TEXT** button to start a new search. This function is useful if you are looking for programmes about the country you are going to visit on holiday, for example.

TVTV EPG AND TIMER

SEARCH STORAGE



You can save individual search terms in the search memory. To do this, enter the search term, as described on the previous page. Press the **OK** button to load the search term into the memory. Now select the memory location using the **▲▼** buttons. Press the **OK** button to load the term into the memory.



There are two ways of using a search term that is stored in the memory.

1. You must have opened the search function. Press the **▼** button to open the search memory. Use the **▲▼** buttons to select the desired search term. Start the search by pressing the **OK** button.
2. Press the **TVR** (blue) button; you can then use the **◀▶** buttons to select the desired search term; the programmes that match that search term are then displayed.

TVTV EPG AND TIMER

DETAILED INFORMATION

Press the **i** button in the **tvvtv** EPG to call up details on the selected programme. The information is only available if the **i** symbol is displayed next to the programme title. The symbol only appears once you have selected the channel and programme by highlighting it with the yellow cursor bar in the various views of the **tvvtv** EPG however.

When you press the **i** button the following display appears (example):

When you call up additional information in the EPG using the **i** button, you will be shown only the first page of description of the programme.

To obtain the full information on the programme, set the item "EPG Grabbing" in the "User Preference"/"EPG Setup" menu to "Off". The tvtv data will be deleted and not collected again.

You now can use the full extent of the SI data sent by the programme provider in the EPG.

In order to use the tvtv EPG again, you must restore the item "EPG Grabbing" in the "User Preference"/"EPG Setup" menu to "On".



In the selection field "EPG Grabbing Time" you can set a specific time of day for updating the tvtv data. To update the tvtv EPG data immediately, press the **⏻** button to switch the receiver to standby mode.

Use the **⏮****⏭** buttons to scroll up and down the various pages of detailed information. The third page displays the upcoming episodes (such as of a series; see example):







If further episodes are available (see example), you can display them by pressing the **TEXT** "More Episodes" button. To record a following episode see "Programming a Recording".

TVTV EPG AND TIMER

You can use the   buttons to switch to the details on the next programme in the selected view. Press the  button to return to the previous display, such as the programme list.

PROGRAMMING A RECORDING

You can programme a recording from the various views of the **tv tv** EPG ("Current", "Programme list", "Highlights" and "Detailed information") and from within their various sub-menus. When programming recordings, the **tv tv** EPG automatically adapts to the actual SAT IF input signal mode (Single/Loop through/Double Tuner). Example: If you are operating the UFS 821 in loop-through mode, you cannot simultaneously record one programme on the ARD channel and one on the ProSieben channel, because the two channels are not transmitted on the same transponder.

Use the cursor buttons (   ) to select the programme you want and press the  (red) button. The following display appears (example):

You can set the automatic lead-in and run-on times for your recordings in the "User Preference", "EPG Setup" menu (see also the Chapters "User Preference", "EPG Setup")



If there are no EPG data available for the channel you selected:





Select the channel for which you want to programme a recording in the

"Current" view and press the  (red) button. As there is no EPG data, you must enter the data (date, start, end)









manually. Enter the data using the cursor buttons (   ) and numeric pad. Press the  button to save your settings.







If a program on a protected channel is selected, you must enter the four-digit PIN code (factory setting "0000"). The PIN can be changed by the user, as described in the Chapter "Access control".

You now have a number of options to programme your recording. The settings are made using the cursor buttons (   ) and the numeric pad:

TVT V EPG AND TIMER

- Recording status (once, daily, weekly, user-defined, series) - selected using the   buttons.
- Date (advanced day-by-day) - selected using the   buttons.
- Start time (advanced minute-by-minute) - selected using the   buttons or entered directly using the numeric pad.
- End time (advanced minute-by-minute) - selected using the   buttons or entered directly using the numeric pad.

In user-defined recording you can use the   buttons to move to the various days of the week and press the  button to activate and deactivate them.

Press the  to save the selected recording data.

If the timer recording you are programming overlaps with one or more recordings already programmed, you will see the following message (example):

Note: *You can also change the data and settings of timer recordings you have programmed from the timer list by pressing the  button! Edit data by the same method used to input them.*



When recording to the hard disk the signal is not forwarded to the VCR Scart socket!

Also, when recording to a VCR or PVR, note that most digital TV signals do not contain a VPS signal.

You must therefore always programme your external video or PVR to match the timer settings.



Press the  to return to the listing and edit your input accordingly. The recordings in black are the ones already stored. The one in white is the one you are currently programming which cannot be entered because of other existing recordings.

If you nevertheless want to programme the recording shown in white, you can edit or delete the pre-programmed recordings.

TVTV EPG AND TIMER

Example of user-defined recording:



Example of series recording:

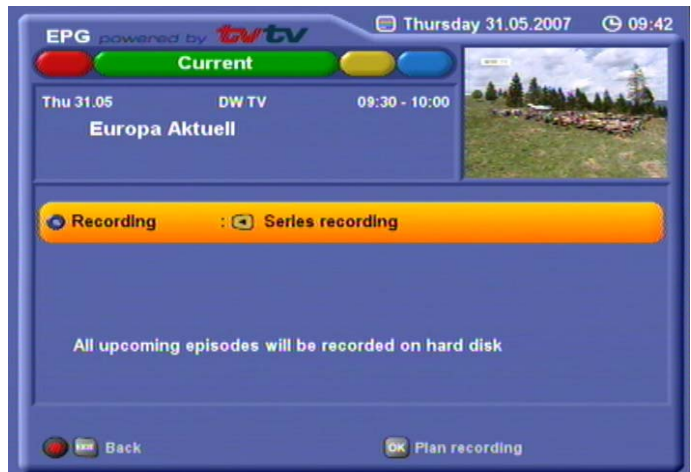

Note: *If every episode of a series is programmed to be recorded using the “Series recording” function, the tvtv EPG locates the series in question in the updated schedules and automatically programmes recording of them. A change in the time the series is broadcast is no problem for the tvtv EPG, as its programming is based on the series title. This does, however, mean that the schedule change needs to have been notified prior to the last update of the tvtv EPG.*







DIRECT DECODING OF TVTV TIMERS



If two timers are set for encrypted channels, both with decoding set to “On”, and the recording times overlap, the first timer will record decoded and the second timer will record encrypted. The unit cannot make two decoded recordings at the same time (the first programme will be recorded decoded and the second programme will be recorded encrypted). If two timers are set for encrypted channels, both with decoding set to “On”, and the recording times do not overlap, both timers will record decoded. During decoded recording, the only channels that can be viewed are other channels from that same transponder. The last decoding option selected remains in effect until changed.

TVTV EPG AND TIMER

TIMER LIST





The timer list (recording schedule) is accessed by pressing the  (red) button. The timer list shows all the programmed recordings. You can use the   buttons to toggle back and forth between the master timer list and the "once" and "series" displays. You can scroll line-by-line or page-by-page through the timer list using the cursor buttons (, , , ).



In the box at the bottom right of the screenshot above you see the day, date and time of recording and the recording mode.

Overlaps are indicated in orange text. Use the   buttons to move to the orange listing and you will see the overlapping recording shaded in white (see screenshot above).

Use the  button to call up a programmed timer entry and edit it.

You can delete a programmed timer recording by pressing the  (red) button. If it is a (recurring) series recording, you are additionally asked whether you want to delete all the programmed recordings of this series (in the example below: "Discontinue daily recording?") or merely the specific recording selected ("No recording on this day only?"). Press the  button, or press the   (red) button to cancel.















TVTV EPG AND TIMER

IMPORTANT ADDITIONAL INFORMATION

- The  button does not become active until 15-20 seconds after the picture appears on the TV.
- Updating of the **tv tv** EPG is only started if the **tv tv** EPG data is more than 36 hours old.
- The **tv tv** EPG is broadcast over the ASTRA satellite at the frequency of 12,603.75 MHz, with a symbol rate of 22 MSymb/s and horizontal polarisation (18 V). If you have accidentally deleted the transponder at this frequency, you will need to start a new satellite and transponder scan for the ASTRA satellite (see "Channel Search").
- Digital-compatible single-cable solutions, such as "Technisat DisiCon 4 LNB", do not permit transmission of the **tv tv** EPG data, because the necessary transponder (12,603.75 MHz, symbol rate 22 MSymb/s, horizontal) is not transmitted in that system. This transponder must not be deleted, as the **tv tv** EPG data is transmitted on it.

KEY TO SYMBOLS

Symbol	Explanation
	Widescreen format
	Programme broadcast in black-and-white
	Dolby Digital 5.1 is a sound transmission method enabling digital surround sound to be reproduced on a home cinema system
	Dolby Surround
	Subtitles for the hard-of-hearing
	Mono
	Stereo
	Two-channel sound (e.g. multiple languages available)
	Daily highlight tips
	Programme details
	Recurring programme recording (series)
	Programme scheduled for recording

TVTV EPG AND TIMER

CHANNEL LIST

The channels in the table below are provided with **tvvtv** EPG data on Kathrein receivers as at 09.02.2006.

The assignment of the channels below to the **tvvtv** EPG may change at any time!

3sat	MDR Fernsehen	Sky News Intl
ARD Das Erste	MTV Central DE	Super RTL
ARTE Deutschland	N24	SW Fernsehen (BW)
ARTE France	NDR Fernsehen	SW3 (Saarland)
ATVplus	Neun Live	TELE 5
BBC World	n-tv	TV5 EUROPE
Bloomberg TV Ger	ORF 1	TW 1
BR Alpha	ORF 2	VIVA
BR3	Phoenix	VIVA Plus
CNN Internat'l	Premiere Start	VOX
Das Vierte	ProSieben	WDR Television
DSF	QVC GERMANY	XXP TV
Eins Plus	RBB Television	ZDF
Eins Extra	RNF PLUS	ZDF dokukanal
Eins Festival	RTL 2	ZDF infokanal
Euronews DE	RTL shop	ZDF theaterkanal
Eurosport DtLand	RTL Television	
hr-fernsehen	RTP Internac'l	
HSE24	SAT.1	
Kabel 1	SF1	
Kika	SF2	

To receive the **tvvtv** EPG data for the "SF1" and "SF2" channels (received over HOTBIRD 13° East) in addition to the other channels listed above, you must additionally run a channel scan for the "HOTBIRD 13° East" satellite.

AUDIO SETTINGS

SETTING THE VOLUME



The required volume level can be set using the  buttons on the remote control of the receiver. A bar indicator is displayed on the screen to show the set volume.



MUTING

Press the  button to mute the sound. "Mute" is displayed. Press the button again to restore the sound.

OPTIONS MENU FOR AUDIO AND SUBTITLES

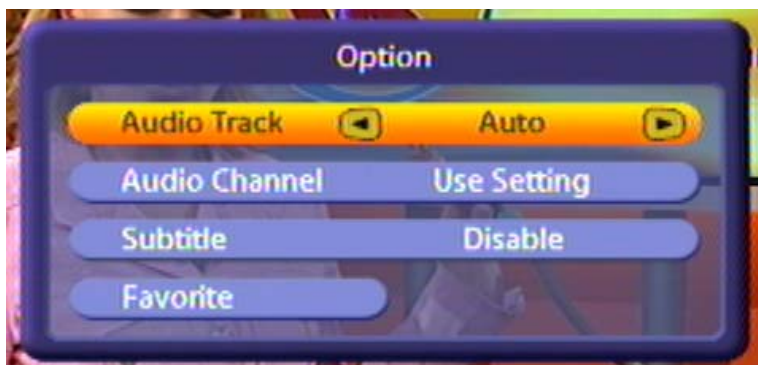
Press the  (yellow) button to call up the audio menu for selecting the sound and language. This menu allows you to make settings such as audio track, audio channel and subtitle, where these are available within the received signal:



Select the menu options using the  buttons and make the desired setting using the  buttons.

Press the  (yellow) button again to exit the menu.

Possible audio settings include:

- Audio Track: Auto (oriented to menu setting) or optionally the audio track transmitted by the channel (e.g. Mono audio film, Dolby Digital, Dolby Digital 2.0, Dolby Digital 5.1)
- Audio Channel: Selection from menu setting, stereo, mono left and mono right
- Subtitle: Enable/disable
- Favorite: Press the  button to save the previously selected sound settings with the selected channel in a favorites list. If no favorites list has been created, you will be asked whether you wish to create a new favorites list (see example on the next page).

AUDIO SETTINGS

Example:

You can for instance create a favorites list with the name "Dolby Digital" in the "Organize Channels", "Edit TV Favorites" menu. By setting "Dolby Digital" in the "Favorite" function mentioned above you can also select channels that broadcast using Dolby Digital and save them in the "Dolby Digital" favorites list. When calling up one of these saved channels you no longer need add the specification "Dolby Digital sound track".



Press the **OK** button.



Use the **▲▼** buttons to select the desired favorites list. Confirm the saving of the channel with the selected sound track setting in the selected favorites list by pressing the **OK** button.

AC 3

The receiver has an optical audio output for AC3 format (Dolby Digital). This gives you the opportunity to bring cinema quality sound into your living room. The AC 3 sound is recorded and can be selected during playback. Connect the corresponding digital audio output to a Dolby Digital system. If no AC3 signal is received, you can only make the normal stereo or mono settings, and choose the broadcast languages.



Always follow the operating instructions for your Dolby Digital system.

RECORDING

The UFS 822 offers you the following options for recording a programme:

- **Timeshift**
Allowing you to include the background recordings made up to that point to be included in your recording
- **Record direct to hard disk**
Allowing you to start recording immediately or later
- **Timer recording (see tvtv EPG)**
Allowing you to coordinate your recordings and plan them well ahead, also providing a range of options such as the series timer



Check that there is adequate hard disk capacity available before every recording! You can see this on the right-hand side of the “Recording List” menu, indicated as “Disk Usage”. It is impossible to say exactly how much storage space a recording will take up, as this depends on the volume of data content transmitted. You can work on a basis of about 1.5 GB for one hour's recording.

RECORDING DIRECT TO HARD DISK (STORE TIMESHIFT RECORDING)

The UFS 822 offers you a special feature in this context. As soon as you switch to a channel, the receiver automatically starts recording the programme you are viewing to the hard disk in the background. When you change channel again, the stored data is deleted and background recording begins again.

If, after viewing the programme for a time, you decide you want to record it, you can do so as from the point you switched to the channel in question.

Pre-requirement: *On the “PVR Setup” menu the “Automatic Timeshift” option must be set to “On” and the “Timeshift Buffer Size” entry must allow sufficient hard disk capacity for the timeshift recording.*

Also refer to the “User Preference” section on this, under “PVR Setup”.

Start

Press the  (red) button. The following screen appears:

RECORDING

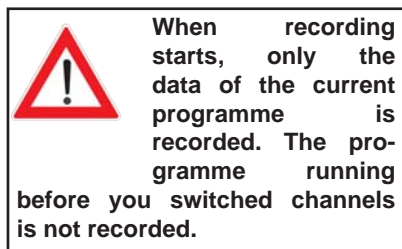

Note: The “Decoding” line is shown only when recording an encrypted channel.

You can start recording the programme as from the point you switched to the channel in question simply by pressing the **OK** button, or you can simply wait the 5 seconds for automatic recording to begin. If you want to alter the end time or recording duration, you can do so as described under “Duration/End” before pressing **OK** to start recording.

Duration/End

You can specify the duration of a recording regardless of when it starts. The receiver automatically retrieves the end time of the programme you are currently viewing from the EPG data (where available) and inserts it in the “Duration” field. Otherwise the end time is based on the default duration you set on the “User Preference” menu under “PVR Setup”. If your programmed recording overlaps with another scheduled recording, the end time of the current recording is matched to the start time of the one already scheduled. To change the recording duration, use the **▲▼** to move to the “Duration” field and use the **◀▶** to select the time after which you want recording to stop automatically. Press the **OFF** (yellow) button to shorten the recording by 10 minutes and the **TVR** (blue) button to extend it by 10 minutes.

Decoding (only shown when recording an encrypted channel)

Here you can use the **◀▶** buttons to select whether the programme should be recorded on the hard disk unencoded (selection “On”) or encrypted (selection “No”). If you select “On”, there is a possibility that you will not be able to view further encrypted channels decrypted by the CA module in use. This will depend on the settings in the menu “System setup” “Common Interface” “Multiple decoding” (see section “System setup” “Common Interface”, “Multiple decoding”).

Record path (only if an external USB storage medium has been connected)

If an external USB storage medium has been connected to the UFS 822 rear panel, recordings can be saved directly to the USB storage medium. Direct recording of encrypted channels on the USB storage medium

RECORDING

can only be effected if the setting "Decoding - on" has been activated.

Once all settings have been made, use the **▲▼** buttons to select "OK". Confirm by pressing the **OK** button. If the end time overlaps with the start time of a scheduled recording, the receiver will automatically jump to the tvtv-EPG recording list, where you can either delete, cancel or edit one of the two recordings.

Press the **■** button to cancel recording at any desired time.

If there is an overlap with another scheduled or ongoing recording, this fact is indicated. The receiver then presets the end time for your new recording as the start time of the overlapping programme (see "Duration/End" at the right).

RECORDING DIRECT TO HARD DISK IMMEDIATELY/LATER

Start

Press the **●** (red) button. The following screen appears:







- You can record the programme immediately. To do this, use the **▲▼** buttons to reach the "Start recording" selection field and there use the **◀▶** buttons to change the setting to "Immediate".
- You can also start recording at a later time. Use the **▲▼** buttons to move to the "Start Record" field and use the **◀▶** buttons to select the time after which you want recording to start. You can choose a value between 1 minute and 119 minutes, in 1 minute increments.

RECORDING

Duration/End

You can specify the duration of a recording regardless of when it starts. The receiver automatically retrieves the end time of the programme you are currently viewing from the EPG data (where available) and inserts it in the "Duration" field. Otherwise the end time is based on the default duration you set on the "User Preference" menu under "PVR Setup". If your programmed recording overlaps with another scheduled recording, the end time of the current recording is matched to the start time of the one already scheduled.

To change the recording duration, use the  to move to the "Duration" field and use the  to select the time after which you want recording to stop automatically. Press the  (yellow) button to shorten the recording by 10 minutes and the  (blue) button to extend it by 10 minutes.

Decoding (only shown when recording an encrypted channel)

Here you can use the  buttons to select whether the programme should be recorded on the hard disk unencoded (selection "On") or encrypted (selection "No").

If you select "On", there is a possibility that you will not be able to view further encrypted channels decrypted by the CA module in use. This will depend on the settings in the menu "System setup" "Common Interface" "Multiple decoding" (see section "System setup" "Common Interface", "Multiple decoding").

Record path (only if an external USB storage medium has been connected)

If an external USB storage medium has been connected to the UFS 822 rear panel, recordings can be saved directly to the USB storage medium. Direct recording of encrypted channels on the USB storage medium can only be effected if the setting "Decoding - on" has been activated.

Once all settings have been made, use the  buttons to select "OK". Confirm by pressing the  button. If the end time overlaps with the start time of a scheduled recording, the receiver will automatically jump to the tvtv-EPG recording list, where you can either delete, cancel or edit one of the two recordings.

Press the  button to cancel recording at any desired time.



If there is an overlap with another scheduled or ongoing recording, this fact is indicated. The receiver then presets the end time for your new recording as the start time of the overlapping programme (see "Duration/End" above).

RECORDING LIST

SETTING BOOKMARKS DURING THE RECORDING

During the recording you can set bookmarks, as described below under "Bookmarks". This allows you to set bookmarks at specific points of the recording, so that when you view the recording on subsequent occasions you can skip certain parts of the programme, such as the commercial breaks.



Select the "Recording List" menu using the menu button **MENU**, the **▲▼** buttons on the main menu and **OK**.

You can also call up the Recording List directly from TV screen, using the **▶** button. The following display appears (example):

You can use the **▶** button to call up a list of the available recordings, from which by pressing the **▲▼** buttons you can select the desired recording and call it up by pressing the **OK** button. The Recording List edit functions are not available when you use this access method. Pressing the **▶** button again causes the display to be cleared.



RECORDING LIST

FOLDER VIEW

Press the **TV** button to switch from the normal view to the folder view. Now use the **Left** **Right** buttons to select between the normal view and the folder view. Furthermore, you will be able to specify which folder your future recordings are to be saved to (in the second line). If you have already created folders (e.g. in the PVR Manager), the following screen will appear when you press the **EXIT** button (example):

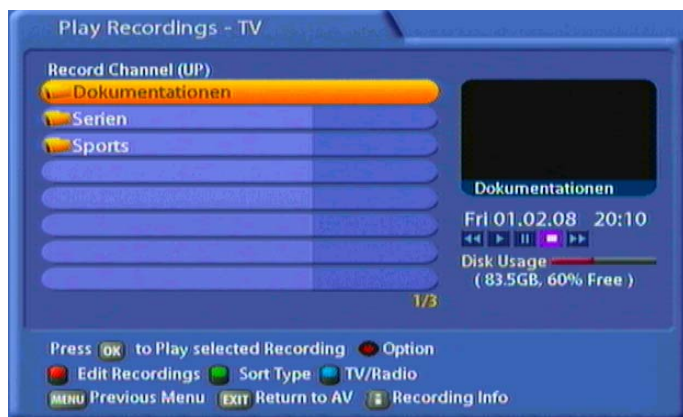

CREATE NEW FOLDER AND SAVE TO FOLDER

For instructions on how to create new folders and how to save recordings to different folders, see the section "Edit recordings" or consult the separate documentation available for the PVR manager.

PLAY RECORDINGS (FOLDER VIEW)

Use the **TV** (blue) button to choose between TV and radio recordings within the recording list. Select the desired folder using the **Up** **Down** buttons. Press the **OK** button to open the folder and view all the recordings contained in it..

Select the desired recording with the

Up **Down** buttons and press **OK** to start playback. The recorded programme will be displayed full-screen. If the folder contains several recordings, you can sort the recordings according to different criteria as described under "Play recordings (Normal view)".

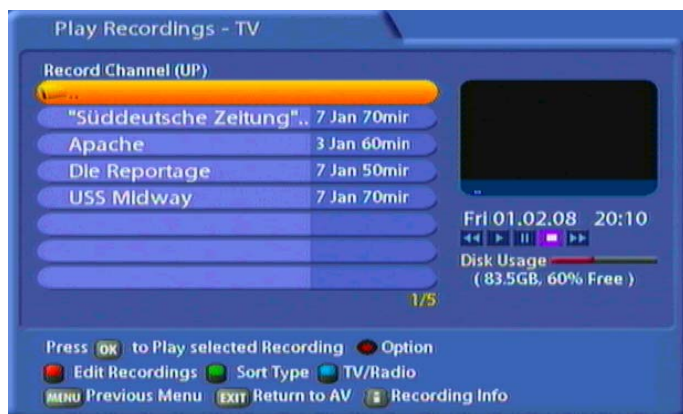

RECORDING LIST





PLAY RECORDINGS (NORMAL VIEW)



Use the  (blue) button to choose between TV and radio recordings within the recording list.

By pressing the  (green) button, you can sort recordings according to the following criteria:

- Date of recording (ascending)
- Duration of recording (descending)
- Duration of recording (ascending)
- Channel (descending)
- Channel (ascending)
- Name of recording (descending)
- Name of recording (ascending)
- Date of recording (descending)

Select the desired recording with the     buttons and press  to start playback. The recorded programme will be displayed full-screen. The next time the recording list is called up, the last mode (TV/radio) and sort type will automatically be displayed.

RECORDING LIST

If you press the **i** button during playback, channel information will be permanently displayed. Press the button a second time to view the recorded EPG data (see example below).

Press the **i** button once more to hide the display.

Recorded EPG data. Use the

▲▼ buttons to scroll through the EPG data.

Recorded broadcast

Programme name

Length played/
Total recording duration

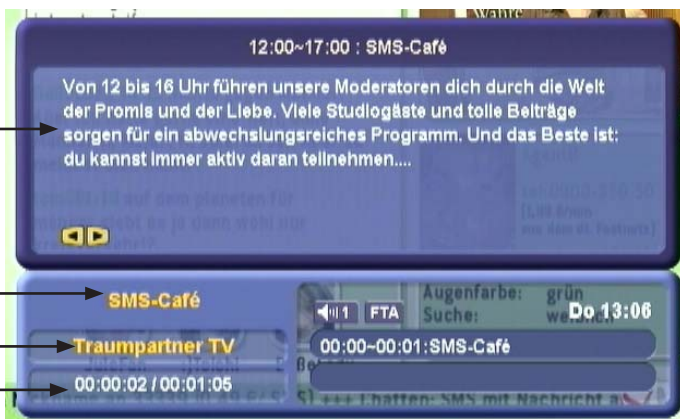

REMOTE CONTROL BUTTONS AND THEIR FUNCTIONS IN PLAY-BACK MODE

▶ Button (play)

- Start play
- End fast forward/rewind and resume playback
- End pause and resume playback
- Display the playback progress bar in playback mode (shows the overall duration of the recording, the current playback position and index marks that have been set)

⏸ Button (pause)

- Interrupting or pausing the playback
- Resuming playback if it had been paused using the **⏸** button

■ Button (stop)

- Playback is stopped or cancelled (reverts automatically to the recording archive)



i Button (information)

- Displaying channel information. Pressing it a second time brings up the associated EPG data

⏮ **⏭** Buttons (Rewind/fast forward)

- Rewind/fast forward at up to 24 times normal replay speed (recordings that have yet to be decoded can be fast forwarded at only 4 times normal replay speed and rewind at only 2 times normal replay speed). During rewinding/fast forwarding you can reduce the speed by one step for every press of the button for the opposite direction of winding.

RECORDING LIST



- After playback has been paused using the  button, you can press the  button to start slow-motion winding. Every time the  button is pressed, the slow-motion speed will be increased one step. There are 7 steps, step 7 being the slowest (slow motion is available only for forwards winding!)

Buttons (left/right cursor buttons)

- 30 second jumps forwards and backwards (can be changed using the  (yellow) button, see below)
- Pressing the button continuously achieves larger jumps (receiver performs the jump only when the button is released)

Buttons (up/down cursor buttons)

- 10% jumps forwards and backwards





 (red),  (green),  (blue) buttons (see "Recording List" "Bookmarks")



Button (Videotext)

- Calling up the recorded Videotext

Button

- Displaying a list of all recordings (only TV recordings)

 (yellow) button (selection and changes are made using the     buttons)

- Selecting the sound track
- Selecting the audio channel (sound options: stereo, mono left, mono right, menu setting, possibly Dolby Digital)
- Switch subtitles on/off (if available)
- "Jump back" (jumps using the  button), setting the size of the jumps (adjustable from 30 seconds to 10 minutes in 30 second increments)
- "Jump forward" (jumps using the  button), setting the size of the jumps (adjustable from 30 seconds to 10 minutes in 30 second increments)

RECORDING LIST

DECODING A RECORDING

You can record encoded programmes even when the CA module with the Smartcard is not inserted. However, to view what you have recorded the CA module with Smartcard must be inserted in the Common Interface on the receiver.

You can also decode a recording after having recorded it, so as to be able to view it in future without the CA module/Smartcard combination. For this the CA module with Smartcard must be inserted in the Common Interface on the receiver.

Encoded recordings are indicated by a \$ sign at the end of the line (after the recording duration).

Use the     buttons to select the encrypted recording, and press the  (yellow) button.

On the screen which the receiver then displays use the   buttons to select "OK" and press the

 button to prepare decoding. The receiver then displays the following message:
"Decoding will be started in standby".

Press the  button to acknowledge this message. As soon as you next switch the receiver to standby the recording will be decoded. The progress of decoding is indicated on the display. Wait for the decoding to complete before switching on the receiver.



The receiver saves both the decoded and the encrypted programmes on the hard disk. If you wish you can delete the encrypted programme (this is not deleted automatically by the receiver).

BLOCKED RECORDINGS

To view recordings that were made from a protected channel you must enter the four-digit PIN code (factory setting "0000").

EDIT RECORDINGS/FOLDERS

Before you define what type of editing you would like to perform, press the  (blue) button to select whether you would like to edit a TV or radio broadcast. Recordings can be sorted as described under "Playback recordings".

Use the  (red) button to access the various editing options. Switch between editing options by pressing the  (red) button. Editing functions can also be used on folders. To do this, both the folder view and the desired folder must be selected. Press the  (blue) button to perform the desired function for the selected folder:

- Delete (for recordings and folders)
- Move (for recordings and folders)
- Rename (for recordings and folders)
- Copy (for recordings only)
- Cut (for recordings only)

RECORDING LIST

- USB (for recordings only)
- Merge (for recordings only)
- Change Type (deletion block) (for recordings only)
- Lock (for recordings only)

At the bottom of the screen, you will also view the option "Create New Folder" (access with  button).

Note: *Recordings in progress will be displayed in red print and cannot be edited until recording has been completed. The following message will appear: "Function not possible".*

To return to the recording list, press the  button.

Editing options are displayed.
The selected editing function
appears in yellow print.

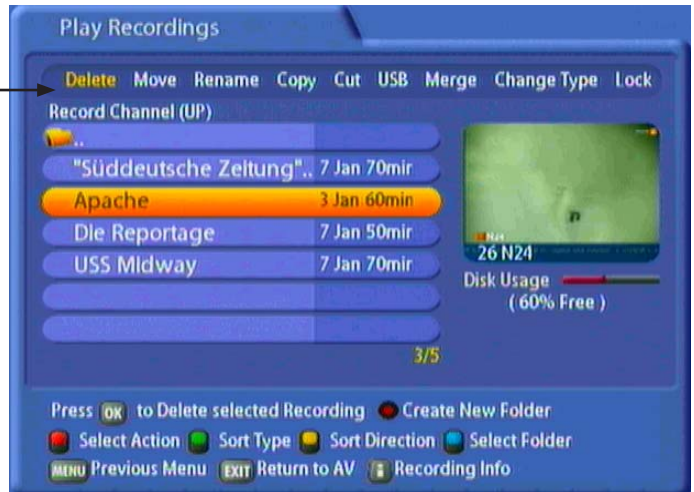
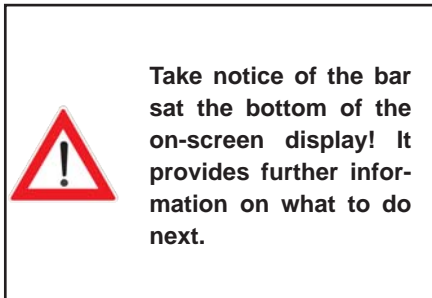



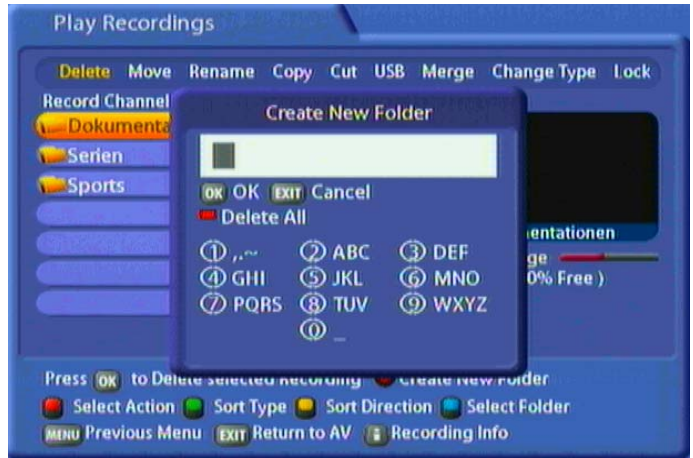

RECORDING LIST

CREATE NEW FOLDER









Press the  button to create a new folder. The following screen appears:



Use the on-screen keypad (with the number keys on your remote control) to give the folder a name. Press  to confirm your entry. A new folder is created. Press the  button to cancel. To delete the last letter entered, press the  button. To delete the entire entry, press the  (red) button.

DELETE RECORDINGS/FOLDERS

To delete recordings:

Select the recording to be deleted with the , , ,  buttons and confirm by pressing the  button. The selected recording will be crossed out in red and the selection cursor will automatically jump to the next recording. Further recordings can be prepared for deleting through the same procedure. Provided you have not exited the menu with the  (red) button, you can cancel deleting by pressing the  button. Recordings will only be permanently deleted when you have left the menu by pressing the  (red) button.

RECORDING LIST

MOVE (RECORDINGS TO A FOLDER)

Use the **▲▼◀▶** buttons to select the recording to be moved and confirm by pressing the **OK** button. The recording will be marked with a white “+” symbol on a red background and the selection cursor will automatically jump to the next recording, enabling further recordings to be selected in the exact same way. Provided you have not exited this menu by pressing the **FAV**(red) button, it is possible to unmark recordings that have been selected for transfer by pressing the **OK** button. Provided you have not exited this menu by pressing the **FAV**(red) button, it is possible to unmark recordings that have been selected for transfer by pressing the **OK** button. You will only be asked if you really want to transfer the file when you exit the menu with the **FAV**(red) button. Use the **▲▼** and **OK** buttons to select the destination and then press the **FAV**(red) button to launch the procedure. You will be asked: “Do you want to move the selected recordings? Move to: Folder name”. Use the **◀▶** buttons to select “OK” and confirm by pressing the **OK** button.

RENAME

Make sure you have also selected “Rename” with the **FAV**(red) button.

Use the **▲▼◀▶** to select the recording you want to rename, then press the **OK** button. The following display appears (example):



Use the **▲▼** buttons to select “Input Directly” and confirm this by pressing the **OK** button. You can now assign the recording any name you like as described under “Alphanumeric Inputs”.

COPY

With this function you can copy a recording, or parts of it, to the hard disk.

Make sure you have also selected “Copy” with the **FAV**(red) button.

Use the **▲▼◀▶** to select the recording you want to copy, then press the **OK** button. The following display appears (example):



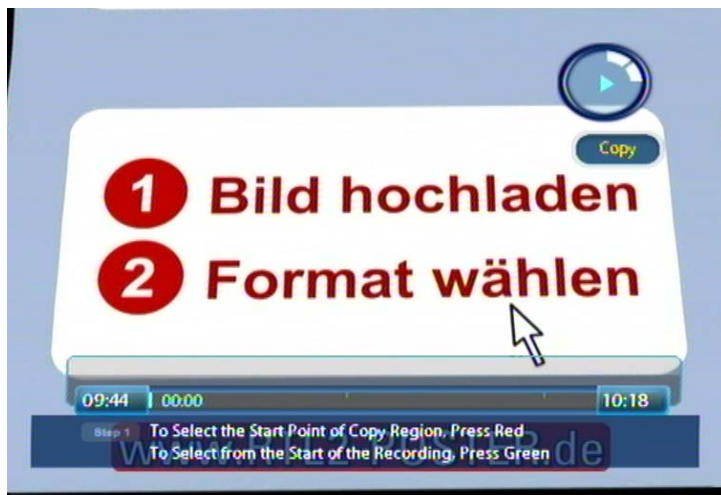
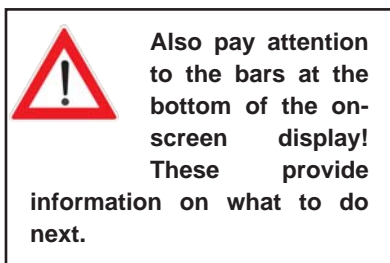



RECORDING LIST





The receiver automatically starts playing back the recording. You now have several options for specifying the range to be copied (see example bar):







To set the exact times for the start and end markers of the copy range as quickly as possible you can use various buttons as aids:

- Use the   buttons to rewind or fast forward at up to 24 times playback speed (you can only fast forward recordings which have not yet decoded at 4 times playback speed and rewind them at 2 times playback speed)
- You can use the  button to pause the playback and view a freeze-frame (pressing the  button starts the slow motion forwards wind (7 steps obtainable by repeatedly pressing the  button))
- Use the   buttons to jump forward or backwards in 30-second blocks

Copy the range marked "Start" as follows:



- Move to the end of the range you want to copy and press the  button. Then press the  (green) button to set the start point marker of the range to be copied. The receiver automatically marks the full range back to the start of recording. Then press the  (red) button to set the end marker at the end of the recording range you want to copy.

Copy the range marked "Middle" as follows:

- Move to the start of the range you want to copy and press the  button. Then press the  (red) button to set the start point marker of the range to be copied. Then move on to the end of the copy range. Press the  button again and the  (red) button to set the end marker.



RECORDING LIST

Copy the range marked "End" as follows:

- Move to the start of the range you want to copy and press the  button. Then press the  (red) button to set the start point marker of the range to be copied. Then press the  (green) button to automatically mark the full range to the end of the recording.

Copy the complete recording as follows:

- Press the  (green) button twice to select the complete recording.





Press the  (red) button to copy the selected range (the selection will be darkened on-screen) or press the  (green) button to reset the markers.

The UFS 822 then internally duplicates the selected recording range as a new recording. When the copy operation is complete the recording list appears. The copy is indicated by a "C:" in front of the name.

CUT

You can use this function, for example, to remove ad breaks from your recorded programmes.

Make sure you have also selected "Cut" with the  (red) button.

Use the     to select the recording you want to cut, then press the  button. The following display appears (example):



The removed portion of a recording cannot be recovered! For security, make a backup copy of the recording before cutting it for the first time, so that if necessary you will be able to recover it (see "Copy").



Also pay attention to the bars at the bottom of the on-screen display! These provide information on what to do next.



RECORDING LIST

The receiver automatically starts playing back the recording. You now have several options for specifying the range to be cut (see example bar):



To set the exact times for the start and end markers as quickly as possible you can use various buttons as aids:

- Use the buttons to rewind or fast forward at up to 24 times playback speed (you can only fast forward recordings which have not yet decoded at 4 times playback speed and rewind them at 2 times playback speed)
- You can use the button to pause the playback and view a freeze-frame (pressing the button starts the slow motion forwards wind (7 steps obtainable by repeatedly pressing the button))
- Use the buttons to jump forward or backwards in 30-second blocks

Cut the range marked "Start" as follows:

- Move to the end of the range you want to cut and press the button. Then press the (green) button to set the start point marker of the range to be cut. The receiver automatically marks the full range back to the start of recording. Then press the (red) button to set the end marker at the end of the recording range you want to cut.

Cut the range marked "Middle" as follows:

- Move to the start of the range you want to cut and press the button. Then press the (red) button to set the start marker and move forward to the end of the cut range. Press the button again and the (red) button to set the end marker.

Cut the range marked "End" as follows:

- Move to the start of the range you want to cut and press the button. Then press the (red) button to set the start marker and press the (green) button to automatically select the full range to the end of the recording.

Press the (red) button to cut the marked range from the recording, or press the (green) button to reset the markers.













You can only remove one block from the recording in each cut operation. To remove multiple blocks you have to repeat the process.

RECORDING LIST

USB

Use this function to copy recordings saved on your hard disk to an external USB storage medium that has been connected to the rear panel of your receiver.

Select the recording to be transferred using the     buttons and confirm by pressing the  button. The recording will be marked with a white "+" symbol on a red background and the cursor bar will automatically jump to the next recording, enabling further recordings to be selected for transfer in the exact same way. Provided you have not exited this menu by pressing the  (red) button, it is possible to unmark recordings that have been selected for transfer by pressing the  button. You will only be asked if you really want to transfer the file when you exit the menu with the  (red) button. Use the   buttons to select "OK" and confirm by pressing the  button. The receiver will estimate the approximate duration of copying and will then launch the procedure. The following message will appear (example):

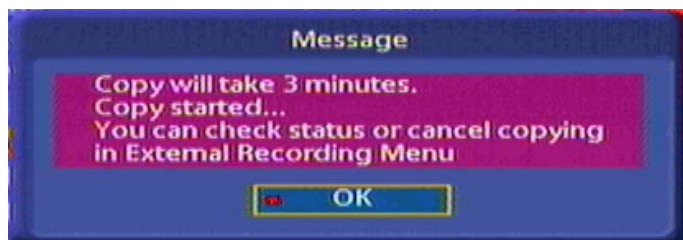

Press  to confirm the message displayed. To cancel copying, access "Main menu", "Multimedia/Games", "External Recording". If the copying procedure has not yet stopped, the following message is displayed (example):





Press  to confirm the message. To cancel the procedure, press the  (blue) button.

RECORDING LIST

MERGE

You can use this function to merge together two or more recordings on one channel.

Make sure you have also selected "Merge" with the  (red) button.

Use the  to select the recordings you want to merge, then press the  button. The following display appears (example):

 The merged recording adopts the name of the first recording selected. You can however change the name after merging on the "Rename" menu.



When you have selected all the recordings you want to merge press the  (red) button. The receiver shows the following display (example):



RECORDING LIST

Use the **◀▶** buttons to select "OK" and press the **OK** button to start merging the recordings. The receiver merges the two recordings. The newly created single recording is assigned the name of the first recording you selected for merging.

DELETION BLOCK

You can use this function to protect recordings from being deleted when automatic hard disk management is active (see "User Preference" section under "PVR Setup", "DISK Management").

Make sure you have also selected "Deletion Block" with the **FAV** (red) button.

Use the **▲▼◀▶** to select the recording you want to protect, then press the **OK** button. The recording then has a "*" in front of its name indicating that it is protected against being deleted.

Press the **OK** button again to cancel the deletion block, the "*" will disappear.

LOCK

You can use this function to block recordings. The recording can only be played back by entering the PIN.

Make sure you have also selected "Lock" with the **FAV** (red) button.

This editing function is PIN-protected. When you select the lock function you must enter the PIN (factory default "0000").

Use the **▲▼◀▶** buttons to select the recording you want to block, and confirm by pressing the **OK** button. The recording then has a padlock symbol in front of its name indicating that it is blocked.

Press the **OK** button again to cancel the block; the padlock symbol will disappear.



RECORDING LIST

BOOKMARKS

You can use this function to divide recordings into chapters, or to find specific sequences in a recording very quickly.

SETTING BOOKMARKS

Start a recorded programme by pressing the **OK** button. When the playback reaches the point at which you wish to set a bookmark, press the **FAV** (red) button. A “flag” will appear at this point. You can repeat this process as often as you like.

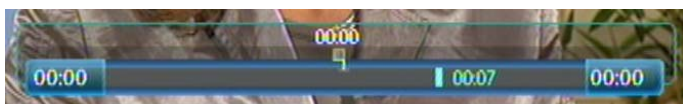

After you have set all your bookmarks, switch to the “Chapters” menu by pressing the **TVR** (blue) button:















Use the **Left**, **Up**, **Down**, and **Right** buttons to select the desired bookmark. Pressing the **OK** button starts the playback. You can press the **PP** (green) button at any time during the playback, to skip to the next bookmark.

Note: You can set bookmarks even whilst recording. Use the **Left**, **Right**, **Left**, **Right** buttons to select the desired point in the recording, and press the **FAV** (red) button.

RECORDING LIST





DELETING BOOKMARKS

Use the  buttons in the “Chapters” menu to select the bookmark to be deleted. Then press the  (red) button. Use the  buttons to select “OK” within the message that is displayed, and confirm again by pressing the  button.

To delete all bookmarks, press the  (green) button in the “Chapters” menu. Use the  buttons to select “OK” within the message that is displayed, and confirm again by pressing the  button.

MULTIMEDIA/GAMES



Select the "Multimedia/Games" menu using the menu button , the   buttons on the main menu and . The following display appears (example):

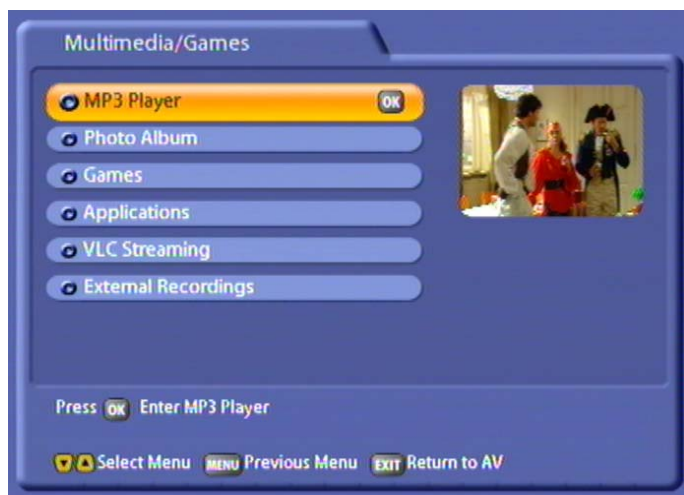

Select the function you want, using the   buttons and confirm with the  button. The following displays appear (examples only):

MULTIMEDIA/GAMES

MP3 PLAYER



Use the **▲▼** buttons to select the desired directory and press the **OK** button to open the directory and access its subfolders. In the above example the first directory listed is the local hard disk of the UFS 822 (Local HDD). The second directory is a USB memory stick. You can also access an external hard disk via the USB port on the UFS 822 and open files on it without having to save them to the UFS 822. The third directory shown above is the File Sharing Folder on the hard disk of the PC/laptop.

The following display appears (example):

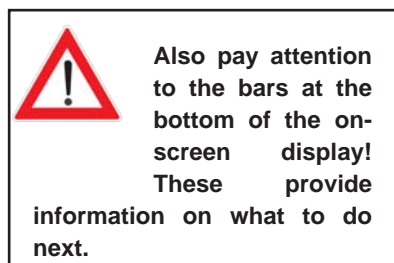

Use the **▲▼** buttons to select the file to play, or select multiple files using the **TV** (blue) (multiple selection) button. Press the **OK** button again to open the MP3 player. The following display appears on the TV screen (example):

MULTIMEDIA/GAMES



The MP3 player automatically starts playing the first file you selected. You now have the following options:

- Use the buttons to skip to the next/previous track
- Use the buttons to rewind or fast forward through the current selected track
- Use the button to pause playback, and the button to resume playback
- Use the button to cancel playback
- Use the (blue) button to access additional playback settings, and use the buttons to select them:
 - Repeat: On (everything is repeated), Current song, Off
 - Shuffle: On/Off
 - Close: Press the - button to quit "Settings"
- Press the button to adjust the volume.

Press the button to return to the MP3 selection list (MP3 Files).

ORGANISING MP3 FILES

You can organise the files on the "MP3 Files" menu. For this, press the (yellow) button. The following display appears (example):

MULTIMEDIA/GAMES

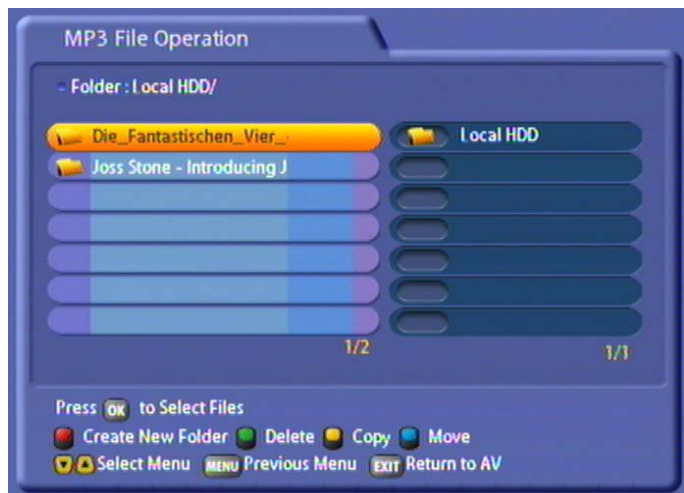





Select the folder or file you want by pressing the **OK** button. Your selection is marked by a "+" sign at the end. You now have the following options:

- Press the **PIP** (green) button to delete the folder/file you selected
- Press the **TV/R** (blue) button to move the files (such as from the hard disk to an external storage device or vice versa). The receiver automatically jumps to the drive selection listings (selected using the **▲▼** buttons). Press the **FAV** (red) button to start the move operation or press the **PIP** (green) button to cancel it
- Press the **FAV** (red) button to create a new folder in the selected directory (for how to input the name using the on-screen keypad see "Alphanumeric Inputs")
- Press the **OPT** (yellow) button to copy the selected file/folder (e.g. from the hard disk to an external storage device or vice versa). The receiver automatically jumps to the drive selection listings (selected using the **▲▼** buttons). Press the **FAV** (red) button to start the copy operation or press the **PIP** (green) button to cancel it.

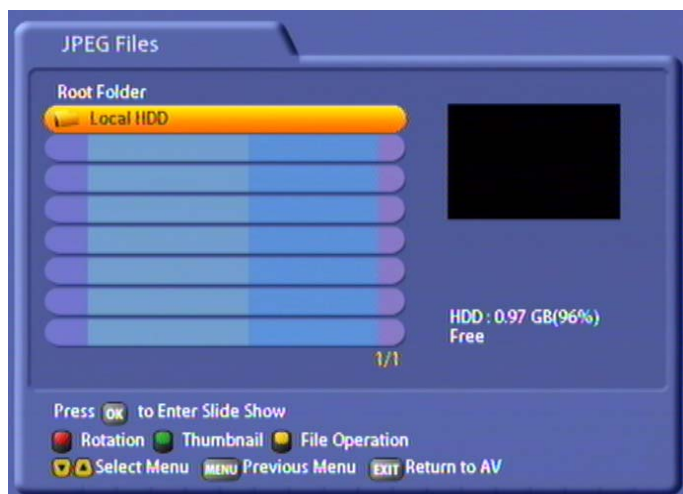
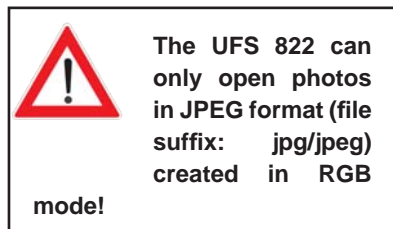
MULTIMEDIA/GAMES





PHOTO ALBUM

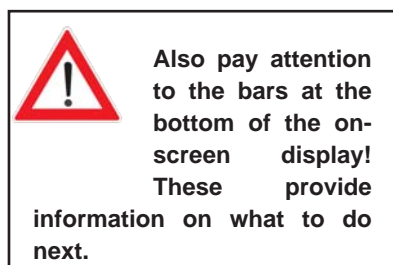

Use the   buttons to select the desired directory and press the  button to open the directory and access its subfolders. In the above example the first directory listed is the local hard disk of the UFS 822 (Local HDD). The second directory is a USB memory stick. You can also access an external hard disk via the USB port on the UFS 822 and open files on it without having to save them to the UFS 822. The third directory shown above is the File Sharing Folder on the hard disk of the PC/laptop.

The following display appears (example):



Use the   buttons to select the file you want to view. Press the  (green) button to open the preview. Press the  button to start a slide show. The following display appears on the TV screen (example):

MULTIMEDIA/GAMES

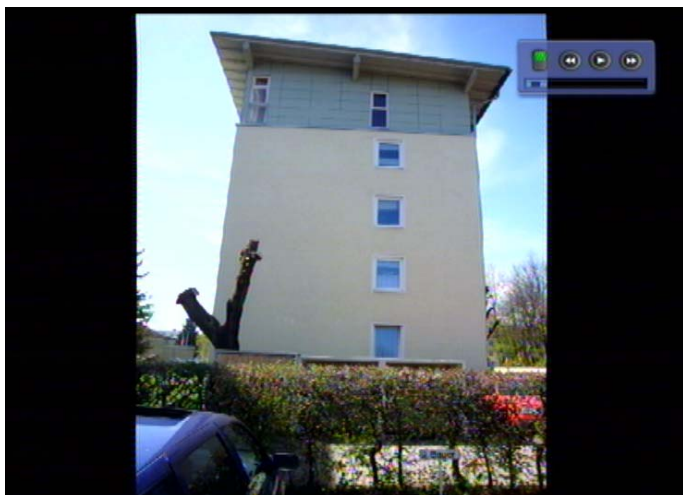

The slide show starts automatically with the first selected photo. You now have the following options:

- Press the **OK** button to show the slide show help bar (see screenshot above, lower part)
- Press the **⏸** button to stop the slide show and then use the **⏮** **⏭** buttons to scroll back and forth through the individual photos. Press the **▶** button to resume the slide show
- Press the **PIP** (green) button to return to the start of the slide show
- Press the **TV/R** (blue) button to open a PIP (Picture-in-Picture) window running the current selected channel. Use the **▲** **▼** buttons to switch PIP channels. Press the **TV/R** (blue) button again to cancel the PIP.
- Press the **OPT** (yellow) button to change the position of the PIP window on the TV screen
- Press the **FAV** (red) button to open the slide show settings.

Perform the settings using the **▲** **▼** **⏮** **⏭** buttons. You have the following options:

- Picture effects (picture layout): You can switch between various picture layout variants
 - Duration: Here you specify how long each photo is shown for in the slide show
 - Control box: Specify whether the control box (at the top right of the picture) is to be shown or hidden
- Press the **MENU** button to return to the photo selection list (JPEG Files).











MULTIMEDIA/GAMES

ORGANISING PHOTO FILES

You can organise the files on the “JPEG Files” menu. For this, press the  (yellow) button. The following display appears (example):



Select the folder or file you want by pressing the  button. Your selection is marked by a “+” sign at the end. You now have the following options:

- Press the  (green) button to delete the folder/file you selected
- Press the  (blue) button to move the files (such as from the hard disk to an external storage device or vice versa). The receiver automatically jumps to the drive selection listings (selected using the  buttons). Press the  (red) button to start the move operation or press the  (green) button to cancel it
- Press the  (red) button to create a new folder in the selected directory (for how to input the name using the on-screen keypad see “Alphanumeric Inputs”)
- Press the  (yellow) button to copy the selected file/folder (e.g. from the hard disk to an external storage device or vice versa). The receiver automatically jumps to the drive selection listings (selected using the  buttons). Press the  (red) button to start the copy operation or press the  (green) button to cancel it.

MULTIMEDIA/GAMES

GAMES

No games are currently available for the UFS 822.



APPLICATIONS

Not yet available in the current software version.

MULTIMEDIA/GAMES

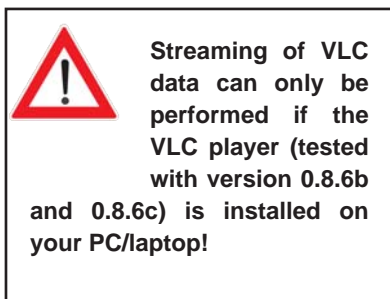



VLC STREAMING

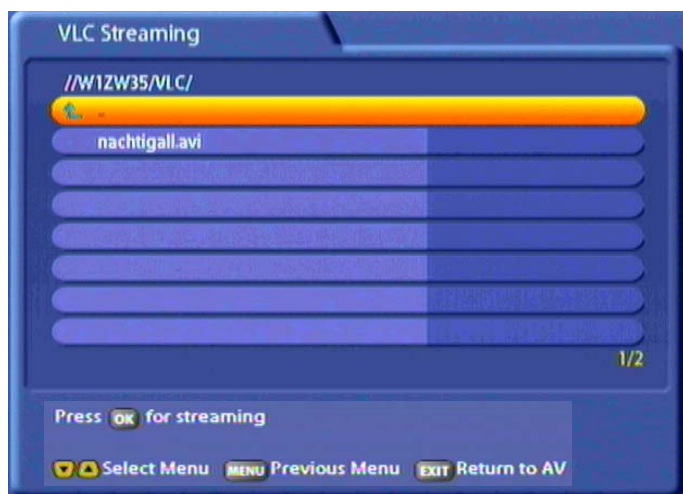

Use the   buttons to select the desired directory, and press the  button to open the directory and access its subfolders. In the example shown above there is only a single directory, which is the enabled folder on the hard disk of the PC/laptop.

The following display appears (example):



Use the     buttons to select the desired file, and press the  button to start playing it. The UFS 822 then uses the VLC player installed on the PC/laptop to open the file and plays the video and sound signal on the TV set. The controls (pause, play back, fast forward and rewind) can be performed using either the remote control for the receiver or using the VLC player control list displayed on the PC/laptop.

MULTIMEDIA/GAMES

EXTERNAL RECORDINGS



Use the **▲▼** buttons to select the desired directory and press the **OK** button to open the directory and access its subfolders. In the above example you see the USB stick on the USB 2.0 host output as the first directory, and the enabled folder on the PC/laptop as the second directory.

The following display appears (example):









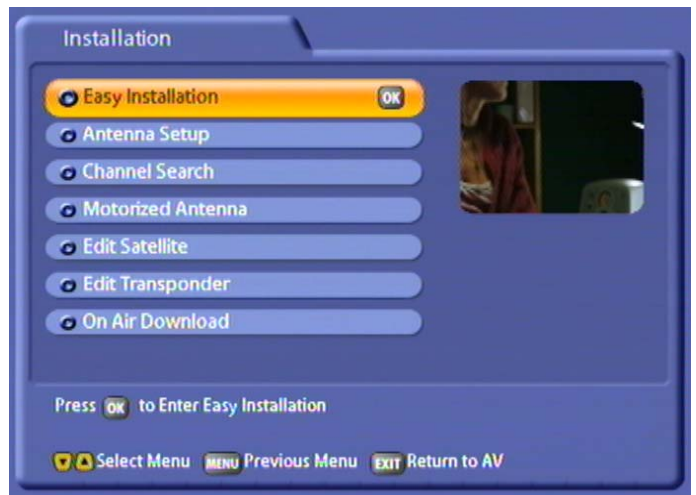

Use the **▲▼◀▶** buttons to select the desired recording, and press the **OK** button to start playing it. The controls (pause, play back, fast forward and rewind) are performed using the remote control for the receiver.



INSTALLATION MENU



Select the "Installation" menu using the menu button , the   buttons on the main menu and .



Use the   buttons to select further options. If there is another sub-menu layer, press the  button to open it. If there are no more sub-menus, make the settings using the     or numeric pad.

Press the  button or the  button to save the settings and return to the previous menu or the TV picture.

INSTALLATION MENU

FIRST INSTALLATION



See "First Installation" section.

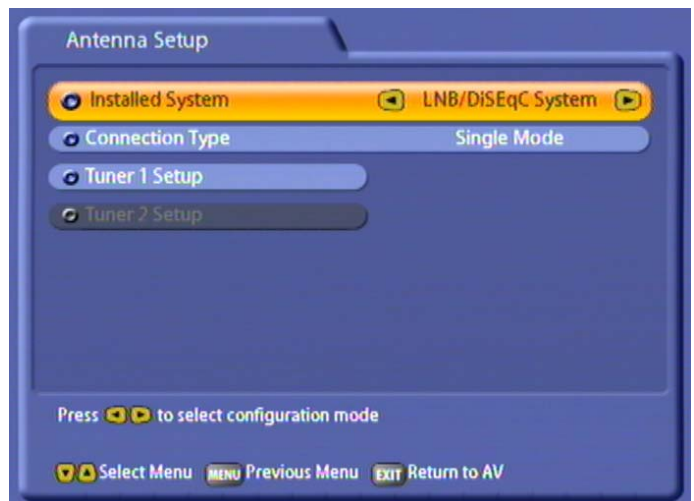

Only make changes to this menu when settings or circumstances on/relating to your reception system have changed. You made the settings for the antenna during first installation. The settings should be made by a specialist engineer.

ANTENNA SETTINGS



Use the   buttons to select whether you want to use only tuner 1 (single mode) or both tuners (dual mode). In dual mode (both tuners receiving a dedicated signal or the signal from tuner 1 is looped-through to tuner 2) a SAT IF signal must be connected to both tuners.

INSTALLATION MENU

TUNER 1 SETUP

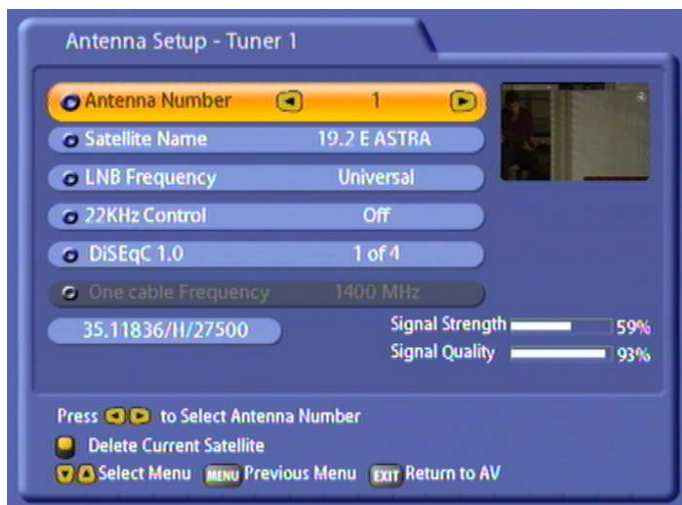

Antenna Number:

Each tuner can receive from up to four satellites. Use the **[Left/Right]** buttons to select the position to which you want to assign a new or different satellite.

Satellite Name:

Press the **[OK]** button to access the list of available satellites. Select the satellite you want using the **[Up/Down]** buttons and confirm your selection with the **[OK]** button. Make sure your reception system is aligned to the selected satellite.

LNB Frequency:

Use the **[Left/Right]** buttons to select the LNB frequency applicable to your reception system or press the **[OK]** button to view the same listing as on First installation, containing the most common variants as follows:

- Single (LNB Low frequency 9750 MHz)
- Dual (LNB Low frequency 9750 MHz and LNB High frequency 10,600 MHz)
- Universal (LNB Low frequency 9750 MHz and LNB High frequency 10,600 MHz and Limit frequency 11,700 MHz)



Press the **[Left/Right]** buttons to make your selection. To confirm your selection press the **[Up/Down]** buttons to select "OK" and press the **[OK]** button.

22kHz Control:

Press the **[Left/Right]** buttons to make your selection (On/Off). The 22kHz Control is needed to switch LNBS in multi-feed reception and to switch between Low and High band.

INSTALLATION MENU

DiSEqC™1.0:

Press the   buttons to make your selection.

- 1 of 4: for the first satellite of the tuner
- 2 of 4: for the second satellite of the tuner
- 3 of 4: for the third satellite of the tuner
- 4 of 4: for the fourth satellite of the tuner
- Mini A: Tone-burst control signal 1 for the first satellite of the tuner (if reception system not DiSEqC™ compatible)
- Mini B: Tone-burst control signal 2 for the second satellite of the tuner (if reception system not DiSEqC™ compatible)
- Disable: If your reception system is not DiSEqC™ compatible and only one satellite per tuner is selected



Single-cable frequency:

If you have selected "Single-cable system", you can here manually select the single-cable frequency for tuner 1 and tuner 2 (see "First installation").

Save:

Once you have made all the settings, use the   buttons to select "Save" and press the  button to save the data.

CHANNEL SEARCH

Use the   buttons to select whether you want the search to cover all satellites or only one specific one. If you select "All Satellites" only "Automatic Search" mode is possible. If you choose one specific satellite, your options are:

- Automatic Search: Unrestricted search across all transponders on all satellites (network search possible, selection of FTA and encoded channels possible)
- Manual Search (transponder selection possible, FTA and encoded channels possible, network search possible)
- Advanced Search: Search for a specific channel possible, based on transponder data and PIDs

INSTALLATION MENU

AUTOMATIC SEARCH

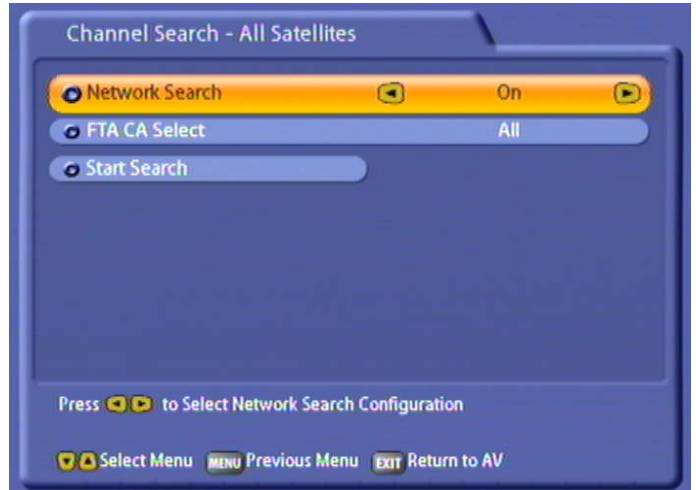

Network Search:

Use the [Left] [Right] buttons to select the setting for the network search.

If you set the network scan to "On", the transponder network enables additional transponders that have not yet been stored to be located. They are then stored and searched for new channels in the same way as the existing transponders.

If you set the network search to "Off", only the current stored transponders of the satellites you previously selected will be scanned for new as yet unlisted channels.

FTA CA Select:

Use the [Left] [Right] buttons to select whether you want to search through all channels or only FTA (Free to Air) or CA (Conditional Access) channels (Common Interface "encrypted channels").

Start Search:

When you have made your selection, use the [Up] [Down] buttons to select "Start Search" and press the [OK] button to start the search.

INSTALLATION MENU

MANUAL SEARCH

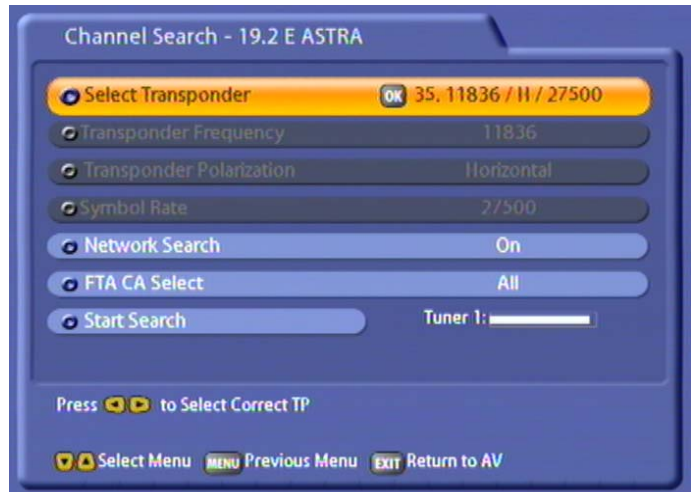

Select Transponder:

Press the **OK** button to call up a list of available stored transponders on the satellite you previously selected. Use the **Left** **Right** **Up** **Down** buttons to select the transponder you want. If the transponder you want is not listed, select the “Enter New Transponders” option. Press the **OK** button to save your selection.

If you have selected an already stored transponder, skip the next points and resume from “Network Search”.

Transponder Frequency

(Input field only active if “Enter New Transponders” selected):

Use the numeric pad on your remote control to key in the frequency of the new transponder here.

Transponder Polarisation

(Input field only active if “Enter New Transponders” selected):

Use the **Left** **Right** buttons to select the polarisation of the new transponder here.

Symbol Rate

(Input field only active if “Enter New Transponders” selected):

Use the numeric pad on your remote control to key in the symbol rate of the new transponder here.

At the bottom right you will see the signal strength of the transponder on the two tuners, enabling you to check that the transponder data you just entered is OK.

INSTALLATION MENU

Network Search:

Use the ◀▶ buttons to select the setting for the network search.

If you set the network scan to “On”, the transponder network enables additional transponders that have not yet been stored to be located. They are then stored and searched for new channels in the same way as the existing transponders.

If you set the network search to “Off”, only the factory stored transponders of the satellites you previously selected will be scanned for new as yet unlisted channels.

FTA CA Select:

Use the ◀▶ buttons to select whether you want to search through all channels or only FTA (Free to Air) or CA (Conditional Access) channels (Common Interface “encrypted channels”).

Start Search:

When you have made your selection, use the ▲▼ buttons to select “Start Search” and press the OK button to start the search.

ADVANCED CHANNEL SEARCH

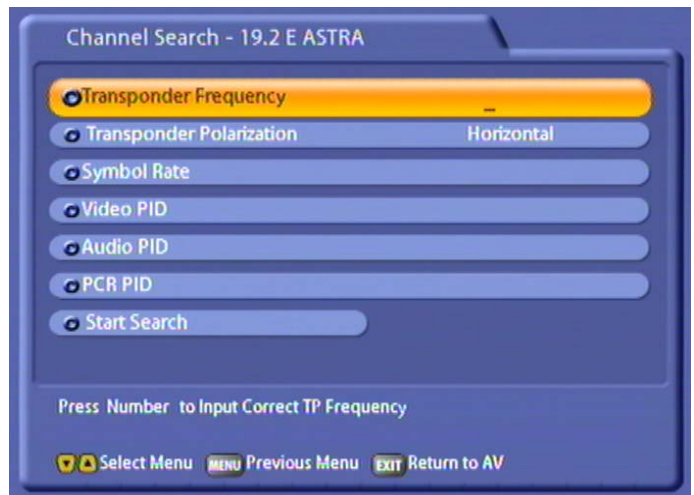

Transponder Frequency:

Use the numeric pad on your remote control to key in the frequency of the transponder on which the channel you are searching for is located.

Transponder Polarisation:

Use the ◀▶ buttons to select the polarisation of the desired transponder here.

Symbol Rate:

Use the numeric pad on your remote control to key in the symbol rate of the transponder here.

INSTALLATION MENU

Video PID (Packet Identification Number):

Use the numeric pad on your remote control to key in the video PID (Packet Identification Number) identifying the video data of the new channel you want on the transponder.

Audio-PID (Packet Identification Number):

Use the numeric pad on your remote control to key in the audio PID of the desired new channel, identifying the audio data of the channel on the transponder.

PCR-PID (Program Clock Reference-Packet Identification Number):

Use the numeric pad on your remote control to enter the PCR PID of the desired new channel here. It is normally identical to the video PID.

Start Search:

When you have made your selection, use the   buttons to select "Start Search" and press the  button to start the search.

If the search is successful, you see the following message (example):

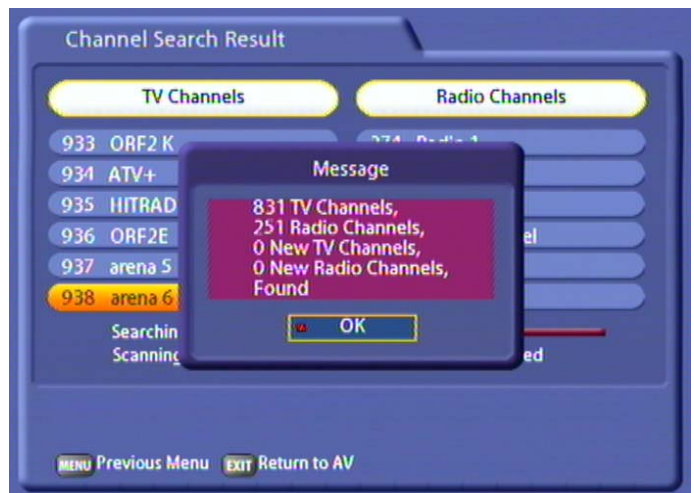

MOTORIZED ANTENNA



Only make changes to this menu when settings or circumstances on/relating to your reception system have changed. The settings should be made by a specialist engineer.

INSTALLATION MENU

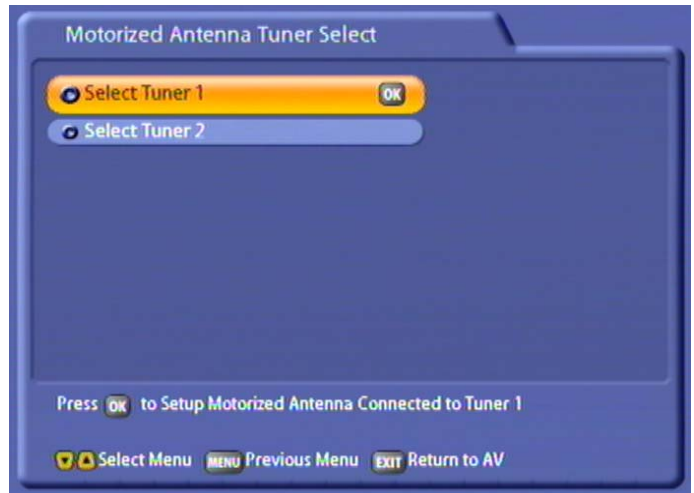

Use the buttons to select the tuner for which you want to make the settings and confirm your menu selection by pressing the button. The settings for both tuners are performed in the same way.

TUNER SETTINGS

Select Satellite:

Use the buttons to select the desired satellite here.

Select Transponder:

Use the buttons to select the desired transponder here.

Motorised Antenna Setup:

Use the buttons to select the control signal you want to use for the motorised antenna here ("DiSEqC™1.2", "DiSEqC™1.3 (USALS)" or "Off" for none)



Motor Control:

Use the buttons to select the command for the motorised antenna here. You can choose between:

- Stop
- Save
- Set East Limit (Start rotation eastwards with the (green) button, and step-by-step eastwards with the (blue) button)
- Set West Limit (Start rotation eastwards with the (red) button, and step-by-step westwards with the (yellow) button)
- Limits Off
- Reset

INSTALLATION MENU

Action:

Pressing the  button on the "OK" button allows the "Stop", "Save", "Limits Off" and "Reset" actions to be activated. You can also press the  (green)/ (red) buttons here to stop ongoing rotations and save the current position.

The optimum setup is shown by the signal strength and quality bar charts at the bottom.



With the East/West limit you can set the extreme stop points (limited by a wall or other obstacles) in the westward and eastward directions.

Always read the operating manual supplied by the rotor/antenna manufacturer thoroughly (particularly with regard to settings different to those described here).

EDIT SATELLITE





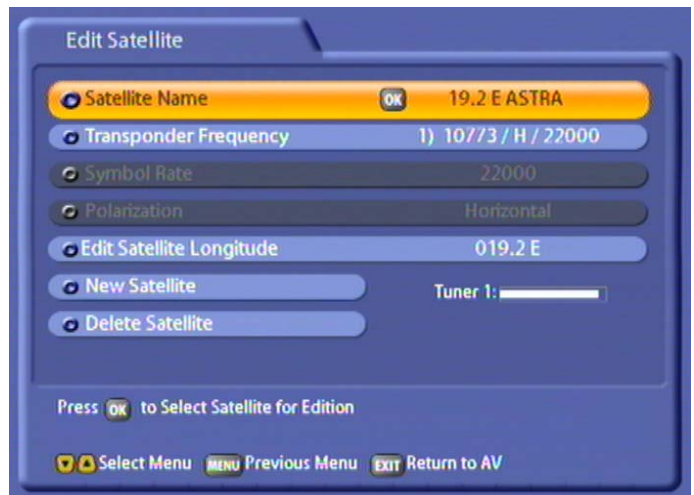

Only make changes to this menu when settings or circumstances relating to the satellites have changed. The settings should be made by a specialist engineer.



INSTALLATION MENU



Satellite Name:

Press the  button to access a list of all stored satellites. Use the     buttons to select the satellite you want.

Transponder Frequency:

Use the   buttons to select the transponder frequency.

Edit Satellite Longitude:





Use the numeric pad to key in the new longitude. Use the   buttons to choose between E (East) and W (West).

New Satellite:

Press the  button to enter the name of a new satellite using the alphanumeric keypad (see "Alphanumeric Inputs").

You can now edit the "Satellite Longitude" setting for this satellite.

Delete Satellite:

Press the  button to delete the currently selected satellite. Use the   buttons to select "OK" on the on-screen prompt and press the  button to confirm deletion of the satellite with all its transponders and channels.



Deleted satellites must be re-entered manually. If the satellite was factory pre-programmed, it can also be restored by a factory reset. In the process however all your personalised settings (such as Favorites lists) will be lost.

EDIT TRANSPONDERS



Only make changes to this menu when settings or circumstances relating to the transponders have changed. The settings should be made by a specialist engineer.

INSTALLATION MENU



Satellite Name:

Press the **OK** button to access a list of all stored satellites. Use the **◀▶▲▼** buttons to select the satellite you want.

Transponder Frequency:

Use the **◀▶** buttons to select the transponder frequency.

New Transponder:

Press the **OK** button to access the input form to enter the data of a new transponder on the satellite you previously selected.

Enter the data (frequency, polarisation, symbol rate) using the numeric pad and the **◀▶▲▼** buttons.

When you have entered all the data and settings, use the **▲▼** buttons to select "OK" and press the **OK** button to add the new transponder. The new transponder is inserted into the list of available transponders on the satellite.

Delete Transponder:

Press the **OK** button to delete the currently selected transponder. Use the **◀▶** buttons to select the "OK" button within the on-screen prompt and confirm the transponder deletion with its channels by pressing the **OK** button.



Deleted transponders can be re-located by way of an automatic search with active network search on the transmitting satellite.

INSTALLATION MENU



Edit Transponders:

Here you can input the "Frequency", "Polarization" and "Symbol" to edit the transponder. Press the **OK** button to confirm the settings.

ON AIR DOWNLOAD

See "Software and Programme List Update" section

CONNECTING UP THE VIDEO/PVR

For details of how to connect your external recorder to the receiver refer to the connection diagram provided at the end of this manual and the instructions for the external recorder.

VIDEO/PVR RECORDER RECORDING

For VCR recording, the satellite receiver must be switched on or the timers must be pre-programmed and the receiver be on the channel to be recorded. During the recording the remote control must not be operated, since all displays would be included on the recording.

VIDEO/PVR RECORDER PLAYBACK

You must first set the Scart socket of the UFS 822 to "VCR mode" by pressing the **0** button while the receiver is in operation in order for your TV set to automatically play back the picture from the external recorder.

In this setting, the picture from the external recorder is switched through to the TV set during playback.

Pressing the **0** button again restores priority to the signal from the UFS 822.

Note: *The system ensures that the same video and audio signal is present at the TV and VCR Scart sockets. The signal output format at the TV Scart socket may however differ from that at the VCR Scart socket. The setting of the format output from the TV Scart socket can be set in the menu ("System Setup", "TV Settings", "AV Settings" "Video output" or in the First Installation). The format "FBAS" is output as standard at the VCR Scart socket.*

SOFTWARE AND PROGRAMME LIST UPDATE

Thanks to digital technology, you can receive satellite updates of the software and programme list for your receiver. The "On Air Download" sub-menu on the "Installation" menu tells you whether new software or programme lists are available. The only prerequisite is that your satellite reception system is aligned with ASTRA 19.2° East.

Press **MENU** to access the main menu and use the **▲▼** buttons and **OK** to select the "Installation" submenu.

Then move the cursor bar to the "On Air Download" menu item and select it by pressing **OK**.

Your receiver automatically searches for the ASTRA transponder, which broadcasts the current software and programme list.

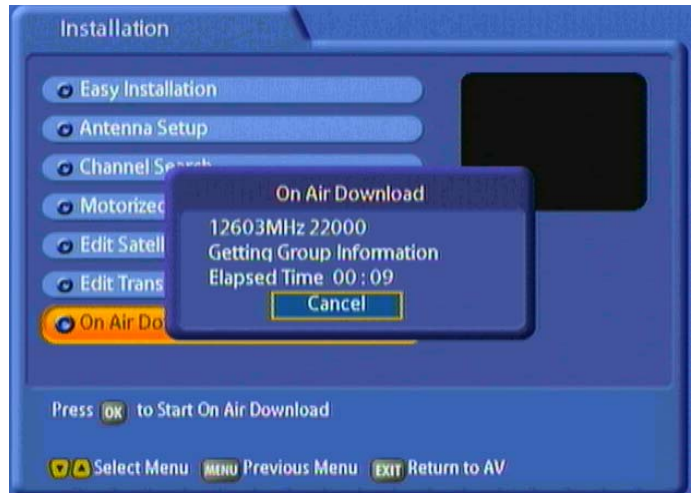

The following display appears (example):

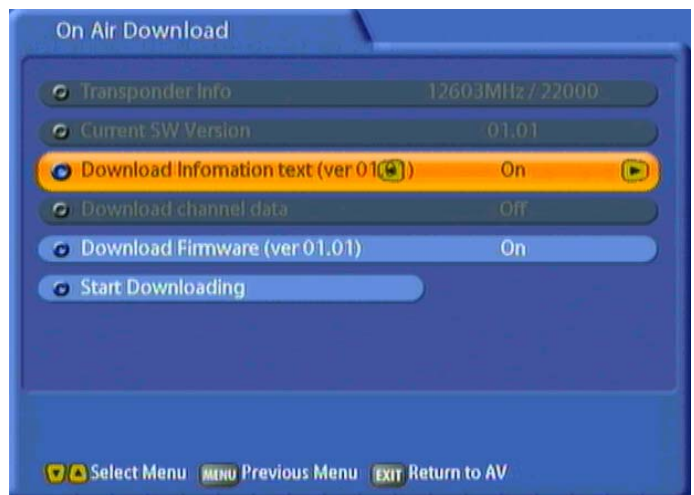

Move the light-coloured cursor bar using the **▲▼** buttons. Make the settings using the **◀▶** buttons.

SOFTWARE AND PROGRAMME LIST UPDATE

TRANSPONDER INFO

The transponder information “Frequency” and “Symbol Rate” are displayed here.

CURRENT SW VERSION

The current software version is displayed here.

DOWNLOAD INFORMATION TEXT

Use the  buttons to select whether you want to download the latest information text. The information text is displayed during the software download, providing details of the new features offered by the software update.

CHANNEL LIST UPDATE

Use the  buttons to select whether you want to download the latest channel list.

UPDATE OPERATING SOFTWARE

The software currently available on the transponder is displayed here. Compare the version with the one listed under “Current Software Version”. If the version on the transponder is higher than the current version on the receiver, use the  buttons to select whether you want to download the latest software.

START DOWNLOADING

When you have made all the settings, press the  button here to start the download. The following display appears (see next page):

Note: *If you are not sure whether you want to download new software to your receiver, you can first activate the “information text” and then start the download. Only the information text is displayed. If you want the changes the new software offers, you can then still run the download as described above.*

SOFTWARE AND PROGRAMME LIST UPDATE

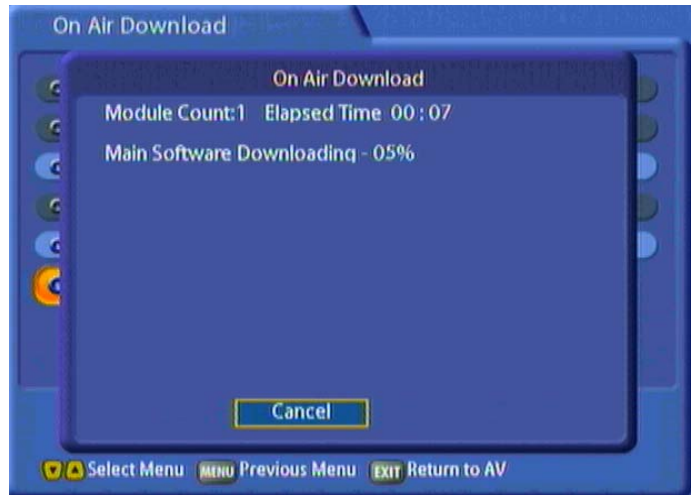

The receiver starts downloading. On the next screen you see the following:

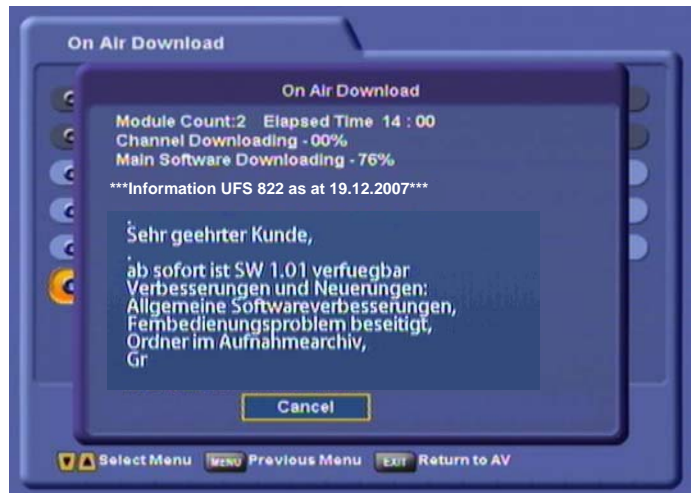

- The number of modules being downloaded
- The elapsed time
- The current operation
- The information text, if previously selected

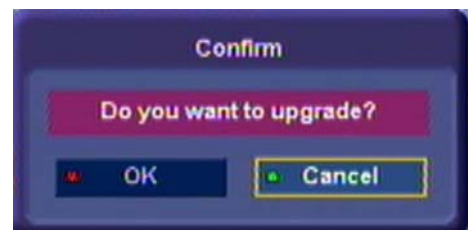

When the software has been successfully downloaded the receiver asks you whether you want to upgrade the firmware:



SOFTWARE AND PROGRAMME LIST UPDATE

Use the   buttons to select "OK" and launch updating by pressing the  button. The following display appears: first "Er.xxx" and then "Wr xxx". Once the update has been completely transferred to the receiver, the message "Complete" is displayed.

Once the update is complete, the receiver is re-initialised and starts operation again. Never turn off the receiver during the update process, as otherwise you could lose the entire software. If this happened, the receiver would have to be re-installed at a workshop or using a PC and USB cable. On the "STB Management" - "System Information" menu you can see whether the new software has been installed.

Follow all on-screen instructions!

Check the time setting following a software update!

You can also download the updates from the Internet. The address is:

<http://www.kathrein.de>



You will find the software under "Service" → "Software and Download" → "Receiver" → "UFS 822"

You can install these updates by way of the PVR Manager.

PVR MANAGER



The Ethernet port (10/100 base T) and the “PVR-Manager” software available for download enable you to integrate the receiver into your home network. This permits you to access the following options:

- Management of the data saved on the UFS 822 hard disk (recordings, MP3s, JPEGs)
- File-sharing between PC and receiver (MP3, JPEG, recordings, video files e.g. Divx, Xvid)
- Software and channel list updates

You can download the PVR manager free of charge from our home page „<http://www.kathrein.de>“ under „Service“ → „Software and Download“ → „Receiver“ → „UFS 822“.

A guide to the installation and use of the PVR manager is also available for downloading as a document in PDF format.

USING THE FRONT PANEL

BACKUP OPERATION

If you have misplaced your remote control, or if the batteries are flat, you can still operate your receiver from the front panel.

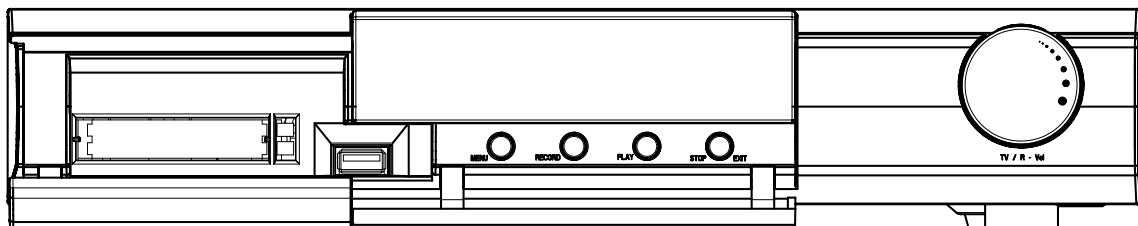

Because there are no number buttons, no password/PIN-protected functions can be displayed.

The front panel houses four buttons and the multifunction control (from now on referred to as “the control”).

Menu button:

Press the Menu button to access the main menu. Move to the various sub-menu items by rotating the control. Select the sub-menus by pressing the middle of the control. Press the Menu button to exit the selected menu and save your changes. Press the Stop/Exit button to exit the menu.

Record button:

Press the Record button to start a manual recording. Select the setting by rotating the control. Press the middle of the control to make your settings. Press the Stop/Exit button to exit the menu without recording the current programme.

Play button:

Press the Play button to access the recording list. Select the programme you want to view by rotating the control and start playback by pressing the middle of the control. Press the Stop/Exit button to exit the menu without starting playback.

Stop/Exit button:

Used to cancel all ongoing actions, such as “Record” and “Play”.

Multifunction control:

- Rotate the control to switch channels.
- Tap the middle of the control to call up the volume bar, then rotate the control to adjust the volume.
- Press the control button twice to switch between TV and radio reception.
- Press and hold down the control button to switch the receiver to Standby mode. Tap the control button to restart the receiver.

RECEIVER TO RECEIVER DATA TRANSFER

Your receiver is able to receive data from another receiver via its RS232 port. For this, the two receivers are connected with a null modem cable. The transmitting receiver is the “master”, and the receiving receiver is the “slave”.



Only possible between two UFS 822 receivers!

PREPARATION

The master and slave are both switched on. Then the RS 232 ports of the two receivers are interconnected by a null modem cable.

CHANNEL LIST DOWNLOAD

Master:

Select “System Setup”, “STB Management”, “Transfer Channel Data”. Press the **OK** button. Use the **◀▶** buttons to select “OK” and start the download by pressing the **OK** button. The master searches for the slave and, once it has found it, automatically begins downloading the channel list. The following display appears: “Channel data being transmitted”.

Slave:

The following display appears: “Receiving data”. Once all the data has been received, first remove the zero-modem cable and then switch the receiver off and back on again at the power switch (hard reset). You can now use the new channel data.

DOWNLOAD OPERATING SYSTEM

Not yet available in the current software version.

TECHNICAL APPENDIX

TECHNICAL FEATURES

The UFS 822 twin DVB-S receiver is fitted with two independent reception and signal processing systems, making it possible to record a broadcast and simultaneously zap through other channels. It also enables one to record two broadcasts while viewing one of them either simultaneously or time-shifted or even while viewing a programme that has been previously recorded.

- Reception of digital satellite TV and radio programmes
- Two independent Sat tuners with loop-through output
- 4,000 programme memory positions
- Integrated 160 GByte hard disk with over 100 hours recording capacity for TV broadcasts or 2,000 hours capacity for radio broadcasts ¹⁾
- Timeshift function
- tvtv EPG (electronic programme guide) with detailed information on approx. 60 programmes up to one week in advance
- 16-digit alphanumeric display with status icons shows channel names and programme information
- Common Interface for two CA modules ²⁾
- HDMI output allows one to connect the receiver to the HDMI interface on an HDMI-capable screen for optimal viewing comfort
- Up-scaler to upscale the Pal signal to 576p, 720p and 1080i
- A USB 1.0 port on the receiver front panel for software updates via USB stick
- A USB 2.0 port on the receiver back panel for connection of external devices
- Ethernet interface
- Multi-function controller on the device
- Optical audio output for Dolby Digital data stream (AC 3)
- Cinch sockets for AV signal (Composite-FBAS, stereo-audio)
- Composite colour picture, RGB and Y/C signal output programmable on Scart socket
- Any number of timer recordings can be made
- 8 favourite programme lists
- Timer programming via the EPG
- Suitable for software updates (operational software and channel list separately) via satellite, USB stick and PC
- PIP function (picture-in-picture representation) on all channels
- MPEG data stream transfer to a PC or laptop via Ethernet ³⁾
- Load-in and playback of MP3 files
- JPEG viewer to view (slide show) and save pictures
- Videotext decoder with 800-page memory
- On-screen display (OSD) in eight languages (D, GB, F, I, NL, PL, E, TR)
- Automatic 4:3 and 16:9 picture format recognition with choice of viewing format
- DiSEqC™ 1.2 control signal and SCR single-cable control signals
- LINUX based operational system
- Mains switch
- Delivery scope: infra-red remote control, batteries, manual, safety notes, Scart cable, power cable, loop-through cable

¹⁾ Depending on the data rate of the broadcast being transmitted

²⁾ CA modules and smartcards are not supplied

³⁾ Software for PC can be downloaded from the Kathrein website

TECHNICAL APPENDIX

Type	CE	UFS 822si	UFS 822sw
Order no./Colour		20210119/Silver	20210120/Black
RF range			
Sat-IF range	MHz	2 x 950-2150	
Input level range	dB μ V	44-83	
Reception threshold (EB/NO)	dB	< 4.5	
TV system Video			
Modulation, FEC, de-multiplexer		DVB-S standard	
Video resolution		CCIR 601 (720 x 576 lines), 576p, 720p, 1080i	
Video decoding		MPEG-1 and MPEG-2 compatible	
Input data rate	MSymb/s	2-45	
Bit rate	MBit/s	1.5-15	
Frequency range	MHz	0.02-5	
Output voltage	V _{ss}	1	
S/N	dB	> 53	
TV system Audio			
Audio decoding		MPEG-1 and MPEG-2, Layer 1 and 2	
Sampling rate	kHz	32/44.1/48	
Frequency range	kHz	0.04-20	
Output voltage	mV _{ss}	770	
S/N	dB	> 65	
Memory			
Flash-RAM	MB	4/32	
Processor clock rate	MHz	166	
Hard disk recorder			
Capacity/ Recording time	GByte/Std.	160/Ca. 100 (depending on data rate and changes of picture contents)	
Power supply			
Mains voltage	V/Hz	100-240/50-60	
Power consumption (oper./stand-by mode)	W	< 35/< 1	
LNB supply (horiz./vert.)	V/mA	14/18; Max. 500	
Control signal	kHz	22; ToneBurst; DiSEqC™1.2, SCR single-cable system	
Connections			
Sat-IF input/output		4 x F-type socket	
Connection TV/VCR		2 x Scart socket	
Video output (analogue)		1 x Cinch socket	
Video/audio output (digital)		1 x HDMI	
Audio output (analogue)		2 x Cinch sockets	
Audio digital output (optical)		Standard optical output	
Data interface		2 x USB socket (1.1 and 2.0), Data I/O	
Common Interface		For 2 CA modules	
Ethernet		1	
General			
Ambient temperature range	°C	Max. +5 to +40	
Dimensions (W x H x D)/Weight	mm/kg	342 x 67 x 273/3.1	

TECHNICAL APPENDIX

ACCESSORIES

- 1 infrared remote control (RC 660)
- 2 batteries 1.5 V, type: LR 03, size: AAA (micro)
- 1 Scart cable
- 1 operating manual

SCART SOCKET ASSIGNMENT

Signal	Pin no.	TV	VCR/AUX
Right audio output	1	X	X
Right audio input	2		X
Left audio output	3	X	X
Audio earth	4	X	X
Blue earth	5	X	X
Audio left input	6		X
Blue signal	7	X	X
Switching voltage	8	X	X
Green earth	9	X	X
Data signal	10		
Green signal	11	X	X
Data signal	12		
Red earth	13	X	X
Data earth	14		
Red signal (C)	15	X	
Blanking signal	16	X	X
Video earth	17	X	X
Blanking signal earth	18	X	X
Video output (FBAS/Y)	19	X	X
Video input	20		X
Connector shield	21	X	X

VHS/S-VHS SWITCHING

The TV Scart socket is switchable between VHS and S-VHS. The switch is made by selecting "System Setup", "TV Settings", "AV Settings" from the Main Menu.

VHS (RGB): The red signal is connected to terminal 15, the composite colour output to terminal 19.
S-VHS (Y/C): The Y output is connected to pin 19, the C output to pin 15.

TECHNICAL APPENDIX

CONNECTION EXAMPLES

Conventional DiSEqC™ system

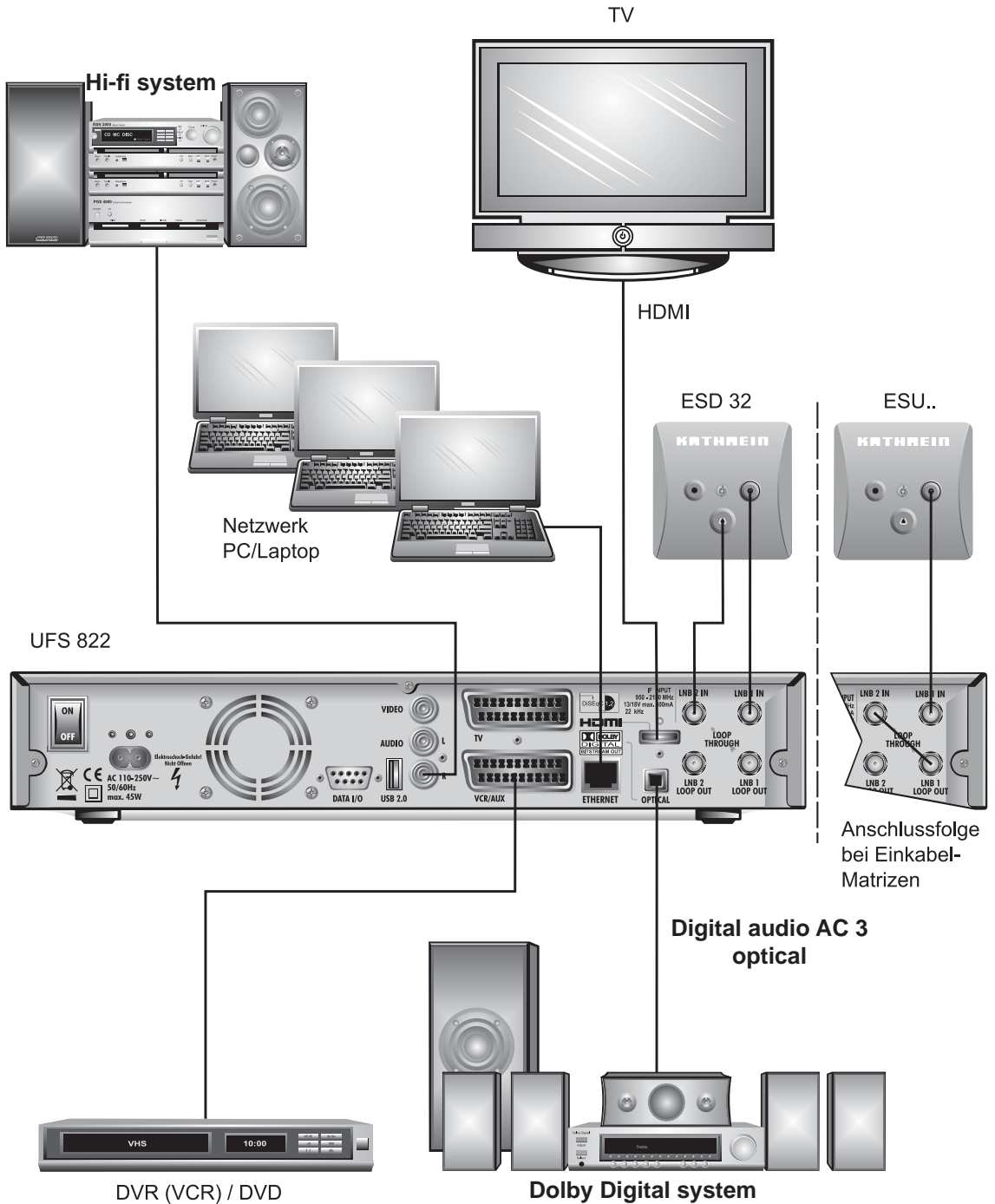

TECHNICAL APPENDIX

EXAMPLES Single-cable system

EXR 501/551/552

Single-cable switching matrices

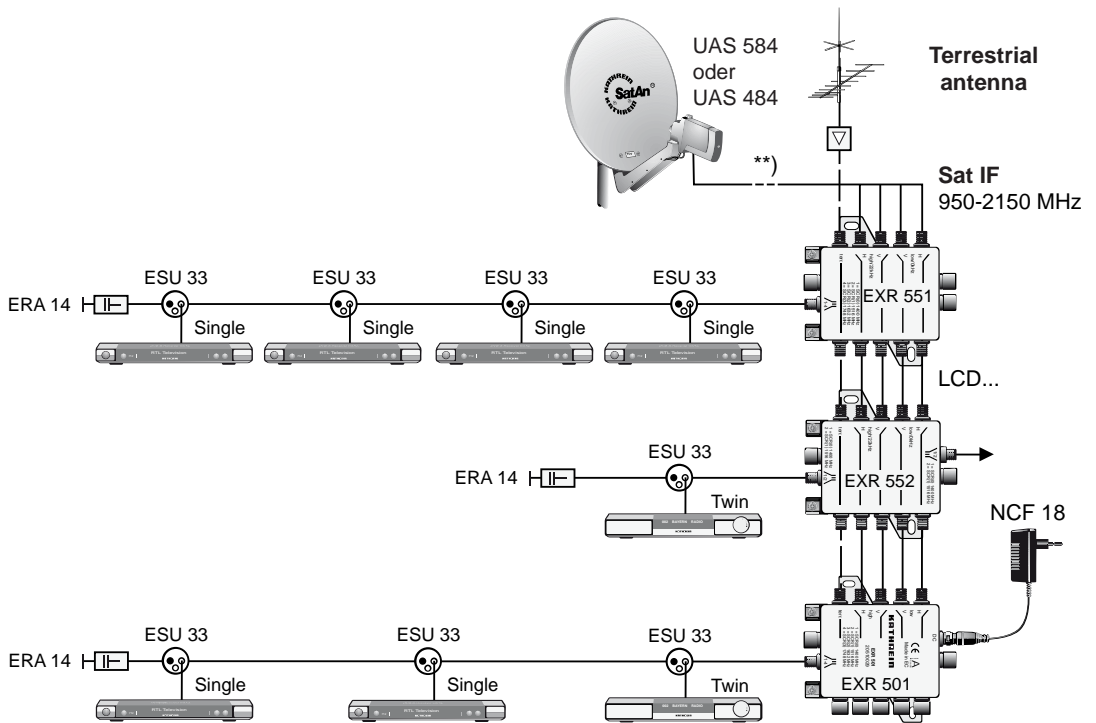

UAS 481

Single-cable feed system

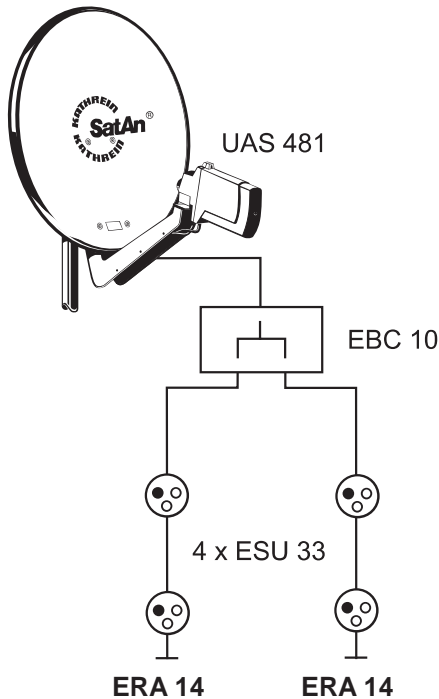

Note:

A maximum of two UFS 822s can be operated on this system.

Connect the tuner input "1" to the socket and loop the signal to the tuner input "2" (connect LNB 1 "Loop-through output" to LNB 2 input). Using this type of connection with the "Single cable" system, in contrast to the normal DiSEqC™ system, allows you to exploit the complete twin capabilities of your UFS 822. This leaves two sockets unused, which are not however available for another receiver without interference on reception.

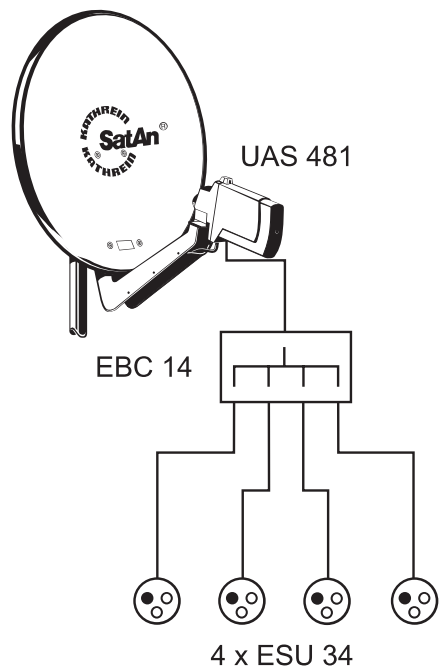
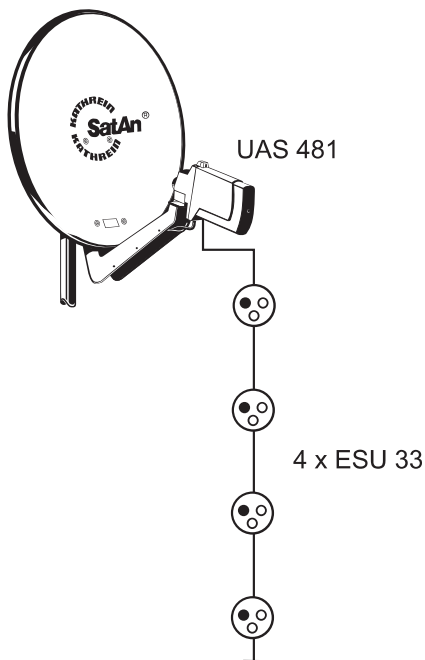

TECHNICAL APPENDIX

CONNECTION EXAMPLES FOR THE NETWORK-FUNCTION

DHCP (Receiver): OFF

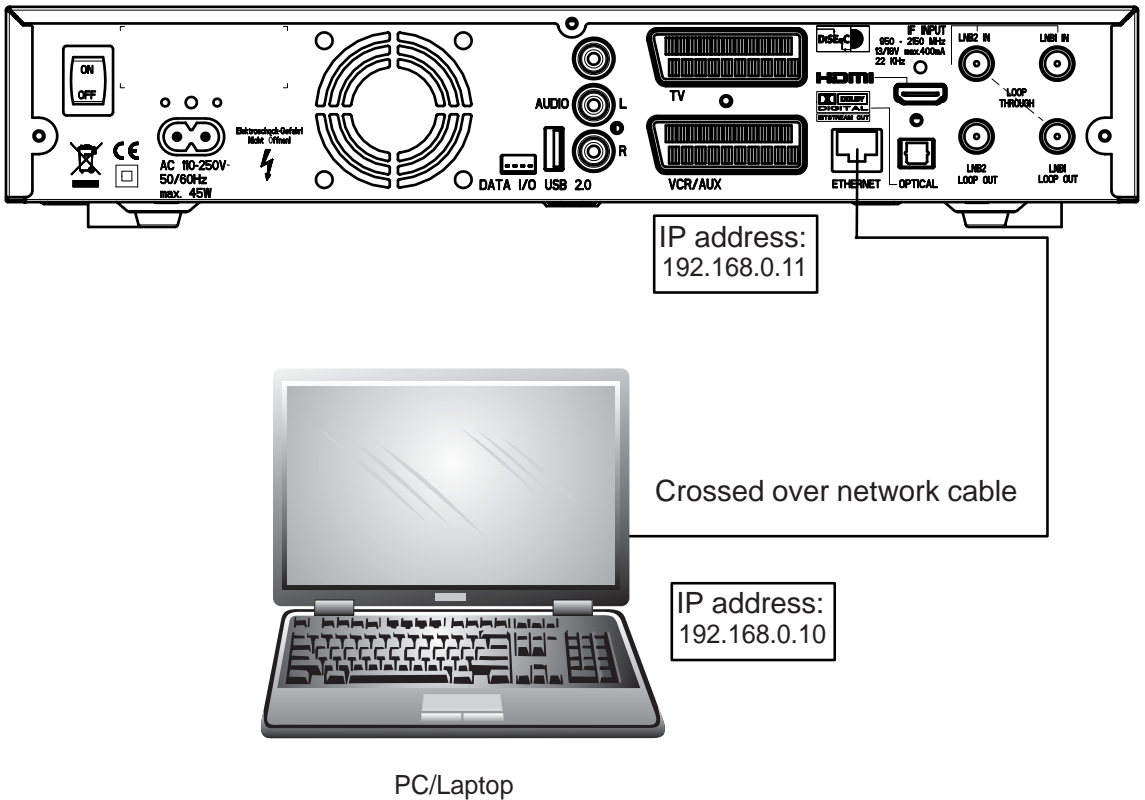

TECHNICAL APPENDIX

DHCP (Receiver): OFF

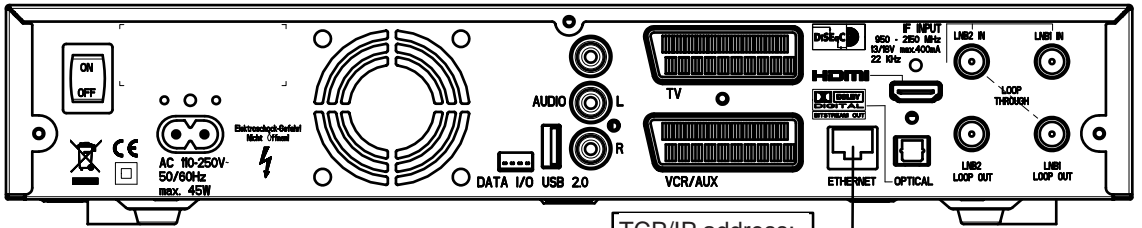

TCP/IP address:
192.168.0.12

Network cable

Switch/HUB

Network cable

Network cable



PC/Laptop

TCP/IP address:
192.168.0.10



PC/Laptop

TCP/IP address:
192.168.0.11

TECHNICAL APPENDIX

DHCP (Receiver): OFF

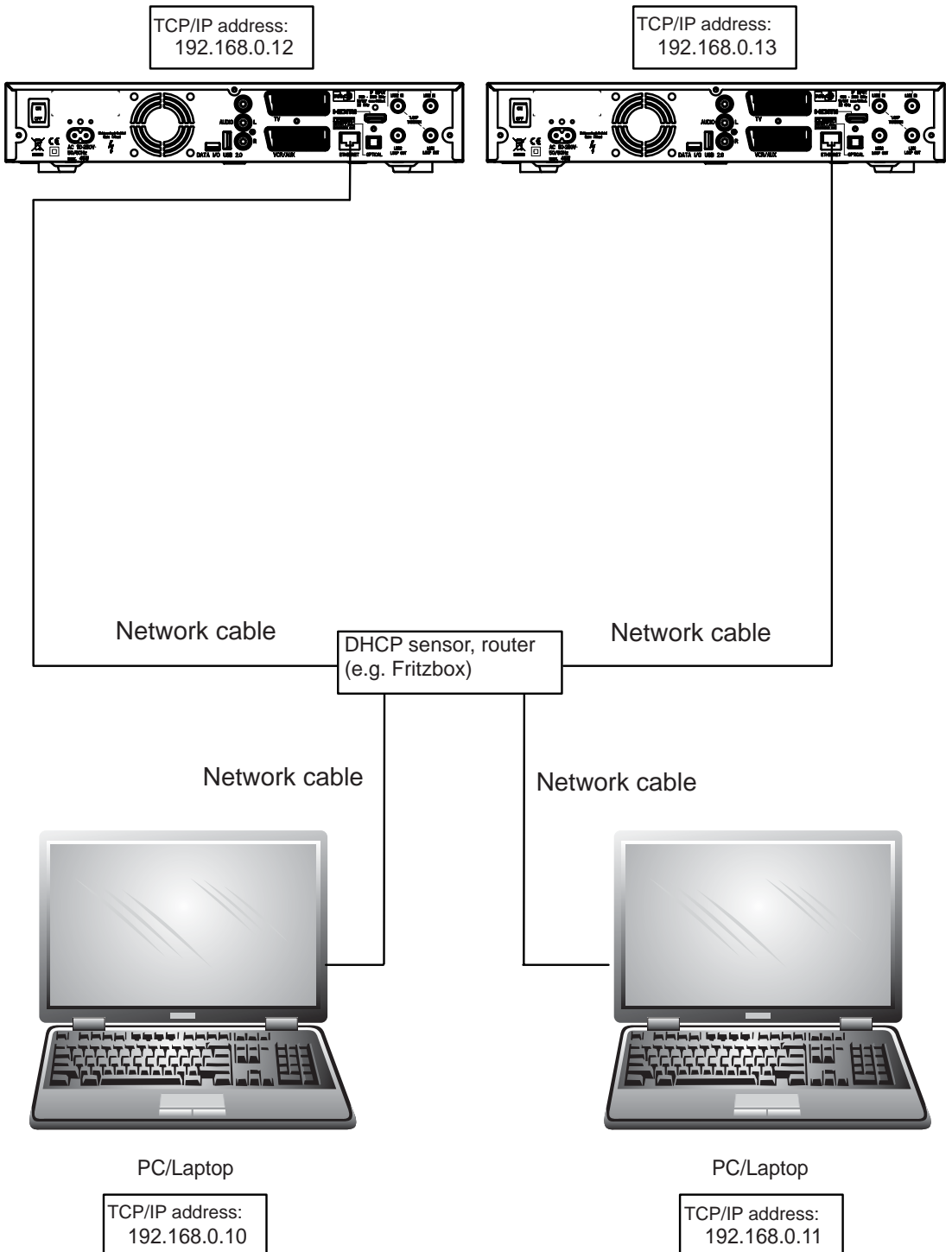

TECHNICAL APPENDIX

DHCP (Receiver): ON

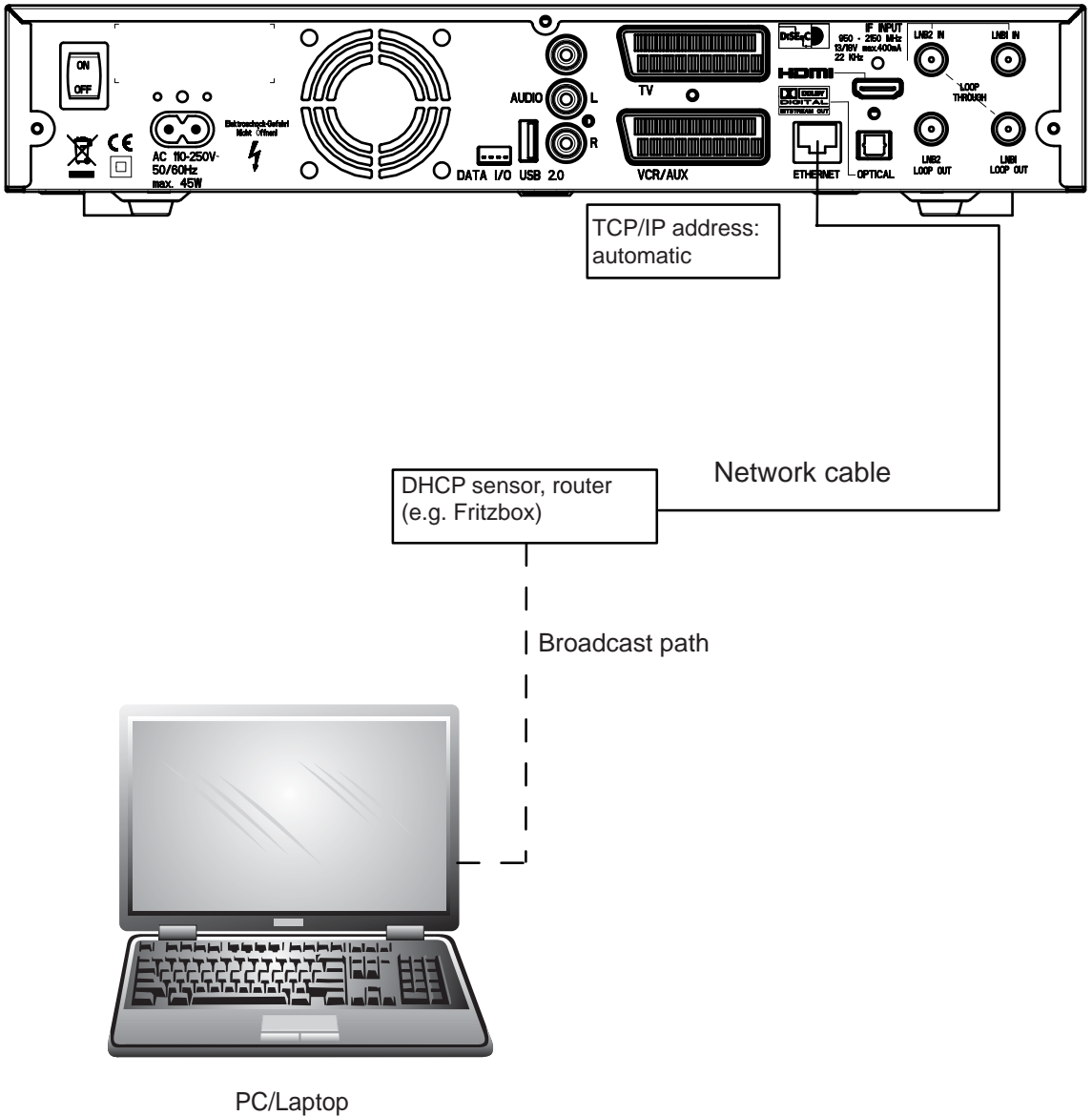

TECHNICAL APPENDIX

DHCP (Receiver): ON

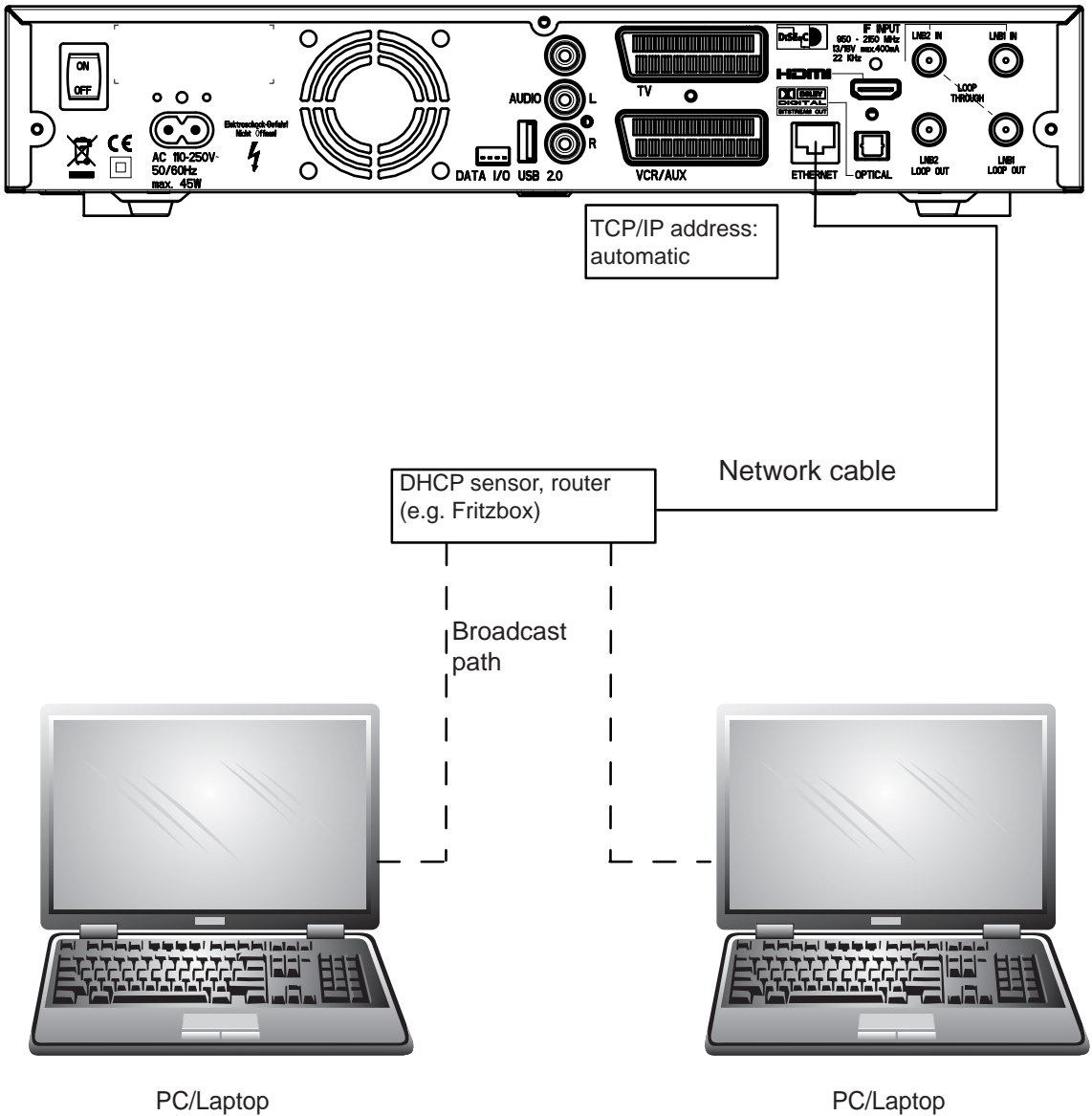

TECHNICAL APPENDIX

DHCP (Receiver): ON

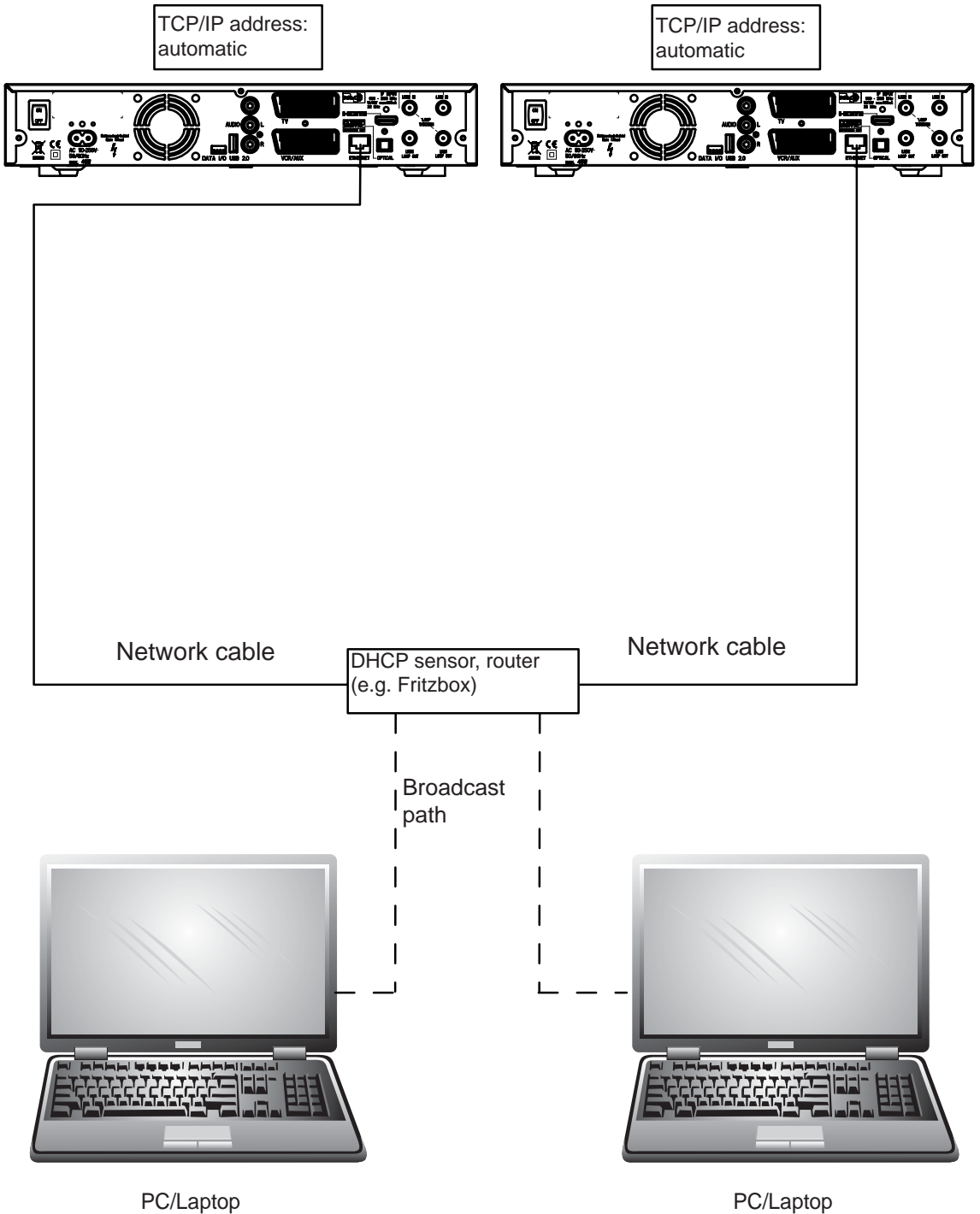

SHORT TECHNICAL GUIDE

CHANNEL PACKAGE

The channel package for a digital transponder normally includes several TV and radio programmes. Each channel package has a fixed assignment for the transponder transmission frequency, for polarisation (horizontal or vertical), for the symbol rate and for the Viterbi rate or error rate.

DiSEqC™

DiSEqC™ (Digital Satellite Equipment Control) is a communication system between a satellite receiver (master) and the peripheral satellite components (slaves), such as LNBs, multi-switches, rotating antenna systems.

It is a single master/multi-slave system, i.e. there is only ever one master in the satellite system. All activities start from the master.

DiSEqC™ COMPONENTS

If DiSEqC™ switching matrices are cascaded, the master receiver must transmit the DiSEqC™ signal several times, so that all DiSEqC™ multi-switches in the cascade receive their commands.

These days, DiSEqC™ components (slaves) must be reverse compatible, i.e. respond to the analogue switching criteria from receivers that are only equipped with H/V and 22 kHz control signals.

A DiSEqC™ switching matrix will work with analogue switching criteria until the DiSEqC™ command from the master is received. All analogue switching criteria are then ignored.

DVB MPEG-2

DVB is the abbreviation for Digital Video Broadcasting. DVB-S refers to the transmission method (S = satellite). MPEG is the abbreviation for Moving Picture Experts Group, a working group that formulates internationally applicable standards for the digital compression of video and audio. MPEG-2 has established itself as the standard for compression of digital TV signals. MPEG-2 works up to a data rate of 100 MB/s.

EB/NO RATIO

The Eb/No ratio is a measure of the signal to noise ratio of a digital signal. The value is not identical to the C/N value familiar from analogue reception technology. At Eb/No values below 5 dB no reception is normally possible.

FEC

FEC is the abbreviation for "Forward Error Correction". The FEC error rate corresponds to the Viterbi rate.

OTR

One Touch Recording

SHORT TECHNICAL GUIDE

PID

The PID (Packet IDentification) number is an identification number for video signals and audio signals in the digital data stream of DVB-MPEG-2 signals. The receiver uses the PID number to create a unique assignment for the video and audio data transmission. The PCR-PID is the identification number for the synchronisation signal. The PID-PCR is normally identical to the video PID. For programmes broadcast in multiple languages, the audio PD can be entered manually to assign a different language to the TV programme. After the PID is entered, the digital receiver automatically selects the audio data identified by the PID number from the data stream and assigns it to the video signal.

PIP

Picture In Picture function

SYMBOL RATE

The symbol rate describes the quantity of data that is transmitted per second. The symbol rate is measured in MSymbols/s and is equal to the number of symbols received per second.

TRANSPONDER

A transponder is a frequency converter which receives TV and radio signals broadcast from the earth, converts them and the rebroadcasts them to the earth at a different frequency. A satellite carries several transponders.

Analogue transponders transmit only one TV channel and possibly multiple radio channels on a single transmission frequency.

Digital transponders transmit several TV and several radio programmes simultaneously on a single transmission frequency. If a programme provider is broadcasting several TV channels via a digital transponder, we refer to the provider's channel package. The terms "digital transponder" and "channel package" have the same meaning.

VIDEO-BIT-RATE

The video bit rate describes the quantity of data from the digitised video signal that is transmitted per second.

VITERBI RATE

The Viterbi rate (code rate, error rate) characterises the error protection used by the programme provider. The DVB standard provides the following values: 1/2 - 2/3 - 3/4 - 5/6 - 7/8

SHORT TECHNICAL GUIDE

GLOSSARY

AC 3	Output for Dolby Digital signal
Audio output	Sound output on the receiver
AV programme pos.	Preferred programme position on TV set for Scart input
CA	Conditional Access (for decoding of encrypted programmes)
CI	Internationally standardised interface for CA modules
Decoder	Decoder for Pay TV
DiSEqC™	Control system between receiver and LNB, multi-switch
DVB	Digital Video Broadcasting
Eb/No [dB]	Power density per unit of information
Eb/No ratio	Digital signal to noise ratio
LED display	Display on receiver
LNB	Low Noise Block Converter
Mute	Muting of sound
OSD	On Screen Display
PAL	Analogue TV standard
Pay TV	Television channels available on subscription (e.g. PREMIERE)
PCMCIA	Standard for internal decoder interface for pay TV
PID	See "Short technical guide"
PIN	Personal Identification Number
PIP	See "Short technical guide"
Receiver	Satellite receiver
RGB	Video signal made up of three individual colour signals (red, green, blue)
Satellite IF signal	Receiver input signal
Scart cable	21-pin connecting cable (e.g. receiver/TV)
Smartcard	Card from Pay TV provider to decode its channels
Stand-by	Standby mode
S-VHS	Super Video Home System (video recorder standard)
Symbol rate	Rate of data transmission of satellite signal
Timer function	Clock function for pre-programmed switch on and off times
Timeshift function	Timeshifted playback
Transponder	See Short technical guide
UFO®<i>micro</i> and UFO®<i>mini</i>	Kathrein-specific satellite signal processing systems
VCR connection	Video recorder connection
Viterbi rate	See "Short technical guide"

TROUBLESHOOTING

In the event of a malfunction, first check all the cable connections and operating states:

1. Receiver and TV set power plugs are connected to the wall socket
2. Antenna cables are located on the receiver input
3. Receiver and TV set correctly interconnected by a Scart or cinch cables
4. Audio connections are made to hi-fi or Dolby Digital system as appropriate (see previous page)
5. Receiver and TV set (Hi-Fi/Dolby Digital system) are switched on (check power indicators)
6. Receiver is responding to remote control

A selection of troubleshooting tips is offered below.

Problem	Cause	Remedy
"No signal!" warning appears on some or all channels	Antenna signal of satellite reception system missing or faulty. Incorrect oscillator frequencies set in "LNB Configuration" menu. Only one cable connected from the satellite system	Consult an antenna specialist to have it checked and repaired as necessary. On "Installation" menu check LNB configuration for satellite in question: High L.O. "10.600" GHz and Low L.O. "9.750" GHz, and change as necessary. Connect tuner input "LNB2 IN" with second cable (connect coaxial cable with F connection) of satellite socket. OR: On "Installation" menu change LNB configuration tuner input to "#1" (if only one satellite being received)
Remote control no longer responding	Receiver or remote control command set may have been unintentionally changed	Set infrared code 1, as described in operating manual under "Remote Control RC 660"; check batteries
Wrong time being displayed	The "Summer Time" setting is wrong. An incorrect time was imported from the reception signal	On "System set-up" - "Time set-up" menu check "Summer Time enabled" and change as necessary. Switch off receiver at mains switch from current channel, e.g. ARD or ZDF, wait 10 seconds and then switch back on
The following channels cut out or "Poor signal or no signal!" appears: ProSieben, SAT1, Cable 1, DSF, N 24, Tele 5, 9 Live, HSE 24 and Sonnenklar TV	DECT telephones are operating on the same frequency as these channels. Interference may occur due to inadequate level or poor shielding of cable	Consult your antenna specialist
Black or blue screen, no on-screen displays	Scart connection to TV deactivated by accidentally pressing the 0 button	Keep pressing the 0 button until the TV picture reappears on-screen

SUBJECT INDEX

AC 3	82
ACCESSING THE TVTV EPG	68
ACCESSING THE TVTV EPG FOR THE FIRST TIME	68
ACCESSORIES	137
ALPHANUMERIC INPUTS	30
ANTENNA SETTINGS	115
TUNER 1 SETUP	116
APPLICATIONS	111
AUDIO CONNECTION.....	11
EDIT RECORDINGS/FOLDERS	92
DELETING RECORDINGS/FOLDERS	94
COPY	95
CUT	97
DELETION BLOCK	101
LOCK.....	101
MERGE.....	100
CREATE NEW FOLDER	94
RENAME	95
USB	99
MOVE (RECORDINGS TO A FOLDER)	95
PLAY RECORDINGS (NORMAL VIEW).....	89
PLAY RECORDINGS (FOLDER VIEW)	88
BACKUP OPERATION	133
BLOCKED RECORDINGS	92
BOOKMARKS.....	102
DELETING BOOKMARKS.....	103
SETTING BOOKMARKS.....	102
CHANNEL INFORMATION.....	31
CHANNEL INFORMATION.....	31
RADIO CHANNEL INFORMATION	31
TV CHANNEL INFORMATION.....	31
CHANNEL LIST	70
CHANNEL LIST	80
CHANNEL LIST DOWNLOAD	134
CHANNEL LIST UPDATE.....	129
CHANNEL SEARCH.....	117
ADVANCED CHANNEL SEARCH	120
AUTOMATIC SEARCH	118
MANUAL SEARCH.....	119
CHANNEL SELECTION IN THE MAIN PICTURE	65
CHANNEL SELECTION IN THE PIP	65
CHANNEL SWITCH BETWEEN MAIN PICTURE AND PIP	65
COMMON INTERFACE	42
CONNECTING THE UNIT (SAT-IF CONNECTIONS)	9
CONNECTION EXAMPLES	138
CONNECTION EXAMPLES FOR THE NETWORK-FUNCTION	141
“CURRENT” VIEW	69
CURRENT SW VERSION	129

SUBJECT INDEX

DECODING A RECORDING.....	92
DETAILED INFORMATION.....	74
ONE-TOUCH RECORDING ON EXTERNAL USB STORAGE MEDIA	5
DISPLAY SETTINGS.....	53
DISPLAYING THE VOLUME BAR	54
INFOBOX DURATION.....	53
INFOBOX POSITION.....	54
PLAY INDICATOR DURATION	54
RADIO BACKGROUND.....	54
STANDBY VFD.....	54
VFD DISPLAY CONTROL	54
DISPOSAL INSTRUCTION	12
DOWNLOAD INFORMATION TEXT	129
DOWNLOAD OPERATING SYSTEM	134
EDIT RADIO CHANNELS	62
EDIT RADIO FAVORITES	64
EDIT SATELLITE	123
EDIT TRANSPONDERS	124
EDIT TV CHANNELS.....	60
DELETE CHANNELS.....	62
LOCK CHANNELS	60
REARRANGE CHANNELS.....	61
RENAME CHANNELS.....	60
SKIP CHANNELS	61
EDIT TV FAVORITES	63
ADD/REMOVE CHANNELS (FAVORITE LIST)	64
CREATE FAVORITE LIST	63
DELETE FAVORITES LIST.....	63
RENAME FAVORITE LIST	63
EPG GRABBING SETUP.....	56
DYNAMIC SI HANDLING	57
INVALIDATE TVTV-DATA.....	57
RECORDING FOLLOWING OFFSET.....	57
RECORDING LEADING OFFSET	57
ERROR SIGNALLING	32
ETHERNET SETUP	48
EXAMPLES SINGLE-CABLE SYSTEM	139
EXTERNAL RECORDINGS.....	113
FIRST INSTALLATION.....	115
GAMES.....	111
GLOSSARY.....	149
HDD MANAGEMENT	45
FORMAT MP3 ARCHIVE	45
FORMAT PHOTO ARCHIVE	46
FORMAT RECORDING LIST	45
USB HDD SETUP	46
HIGHLIGHTS.....	70

SUBJECT INDEX

IMPORTANT ADDITIONAL INFORMATION	79
IMPORTANT INFORMATION	34
INFORMATION ABOUT ANTENNA CONNECTION AND “LOOP THROUGH” OPERATION	10
INSERTING BATTERIES INTO THE REMOTE CONTROL	12
INSERTING THE SMARTCARD AND THE CA MODULE	34
KEY TO SYMBOLS	79
LANGUAGE SELECTION - OSD	30
LANGUAGE SETTINGS	51
MENU CONCEPT	29
MOTORIZED ANTENNA	121
TUNER SETTINGS	122
MP3 PLAYER	105
ORGANISING MP3 FILES	106
MULTIPLE DECODING.....	36
MUTING.....	81
ON AIR DOWNLOAD.....	126
ONE-TOUCH RECORDING	66
OPTICAL DIGITAL OUTPUT	11
OPTIONAL CHANNELS.....	31
OPTIONS MENU FOR AUDIO AND SUBTITLES.....	81
FOLDER VIEW	88
CREATE NEW FOLDER AND SAVE TO FOLDER.....	88
PARENTAL CONTROL	51
AGE RATING CONTROL	52
CHANGE PIN	53
INSTALLATION LOCK.....	52
RECEIVER LOCK	52
STB MANAGEMENT LOCK.....	52
PHOTO ALBUM	108
ORGANISING PHOTO FILES	110
PICTURE-IN-PICTURE (PIP)	65
PREPARATION.....	134
PRODUCT PACKAGE	7
PROGRAMMES SORTED BY CATEGORY	71
PROGRAMMING A RECORDING	75
DIRECT DECODING OF TVTV TIMERS	77
PVR SETUP	55
AUTOMATIC TIMESHIFT.....	55
DEFAULT RECORD DURATION.....	56
ONE-TOUCH RECORDING INFO WINDOW.....	56
DISK MANAGEMENT	55
SAVE	56
TIMESHIFT BUFFER SIZE.....	55
RADIO TEXT	48
RECEPTION REQUIREMENTS.....	9
RECEPTION SYSTEM PRESETS	9
RECORDING DIRECT TO HARD DISK (STORE TIMESHIFT RECORDING)	83
RECORDING DIRECT TO HARD DISK IMMEDIATELY/LATER.....	85

SUBJECT INDEX

REMOTE CONTROL BUTTONS AND THEIR FUNCTIONS IN PLAY-BACK MODE	90
REMOTE CONTROL RC 660	14
SCART SOCKET ASSIGNMENT	137
SEARCH FUNCTION	72
SEARCH STORAGE.....	73
SETTING BOOKMARKS DURING THE RECORDING	87
SETTING THE VOLUME.....	81
SLEEP TIMER	51
START DOWNLOADING	129
STB MANAGEMENT	43
CHANGE PVR NAME	44
FACTORY DEFAULT	43
REMOTE CONTROL CODE	44
SATCO-DX.....	44
SYSTEM INFORMATION.....	43
TRANSFER CHANNEL DATA	43
TRANSFER FIRMWARE.....	43
SYMBOL CODES FOR THE RECEIVER DISPLAY	30
TECHNICAL FEATURES	135
TIMER LIST.....	78
TIME SETUP	39
TIMESHIFT	66
TIMESHIFT	67
TRANSPONDER INFO	129
TV/RADIO CHANNEL LIST	32
TV AND VIDEO RECORDER CONNECTION.....	11
TV SETTINGS	38
AV SETTINGS.....	38
HDMI MODE.....	39
OSD POSITION SETUP	39
TV STANDARD	39
UPDATE OPERATING SOFTWARE.....	129
VHS/S-VHS SWITCHING.....	137
VIDEO/PVR RECORDER PLAYBACK.....	127
VIDEO/PVR RECORDER RECORDING.....	127
VIEW OF FRONT PANEL (FLAP FOLDED DOWN)	8
VIEW OF REAR PANEL.....	8
VLC STREAMING	112

SERVICE

If, despite studying this operating manual, you still have questions about getting started with the unit or using it correctly, or if unexpected problems occur, please contact your specialist dealer.

Internet: <http://www.kathrein.de>

KATHREIN-Werke KG • Anton-Kathrein-Straße 1 - 3
P.O. Box 100 444 • 83004 Rosenheim • GERMANY

KATHREIN
Antennen • Electronic

936.3283/A/0408/ZWT - Technical data subject to change.

Free Manuals Download Website

<http://myh66.com>

<http://usermanuals.us>

<http://www.somanuals.com>

<http://www.4manuals.cc>

<http://www.manual-lib.com>

<http://www.404manual.com>

<http://www.luxmanual.com>

<http://aubethermostatmanual.com>

Golf course search by state

<http://golfingnear.com>

Email search by domain

<http://emailbydomain.com>

Auto manuals search

<http://auto.somanuals.com>

TV manuals search

<http://tv.somanuals.com>