

Operating manual
- Englisch -

DVB Satellite Receiver UFS 740sw



KATHREIN
Antennen · Electronic

PREFACE

Dear customer,

This operating manual is intended to help you make the fullest use of the extensive range of functions offered by your new satellite receiver.

We have tried to make the operating instructions as easy as possible to understand, and to keep them as concise as possible. To help you understand particular specialist terms that cannot be translated, we have added a short glossary at the end of the manual.

The power switch is an environmentally friendly feature. If you will not be using your receiver for a longer period, you should use the power switch to disconnect it from the power supply and save energy. For shorter breaks, you can use the remote control to switch the receiver to standby, which uses only a minimal amount of energy.

We wish you good reception and much pleasure using your new DVB satellite receiver.

Your
KATHREIN team

DISPOSAL INSTRUCTIONS



Electronic equipment is not domestic waste - in accordance with directive 2002/96/EC OF THE EUROPEAN PARLIAMENT AND THE COUNCIL dated 27th January 2003 on used electrical and electronic appliances, it must be disposed of properly.

At the end of its service life, take this unit for disposal to an appropriate official collection point.

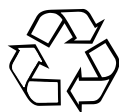

Used batteries are special waste!

Do not throw spent batteries into your domestic waste; take them to a collection point for old batteries!

IMPORTANT INFORMATION

The channels available on the satellites and transponders are subject to continual change. If changes do occur, the new channels have to be set in the receiver because the factory preset programming corresponds to the status on the date of manufacture. The information for these settings can be found on the Internet or in relevant magazines.

Your receiver is factory fitted with the latest software version. We are, however, constantly working on adapting the software in response to the wishes of our customers and to developments in technology. The "Service Menu" section provides more information on this.

The information in this operating manual was correct at the time of going to press.

We reserve the right however to make changes at any time and without prior notice.

If new software is released for your receiver, and this affects the information in the operating manual (e.g. changes to the menus and/or functions), if we believe it necessary we will make available a new operating manual for download under "www.kathrein.de".

Please keep the original packaging in case you need to return the product at any time!

If the product is not properly packed, the warranty claim is invalidated.

Make a note of the receiver's basic settings, so as to be able to restore them if necessary!

Make a note of the receiver's basic settings (these are set during the first installation), so you can restore them if necessary!

The term DiSEqC™ used in this operating manual is a registered trade mark of the European Telecommunication Satellite Organisation (EUTELSAT).

SWITCHING OFF THE RECEIVER AND UPDATING THE EPG

By pressing the  button you can switch the receiver out of TV mode and into standby mode. Pressing any of the numeric buttons returns it from standby mode into operating mode.

Every night at 03:00 the receiver automatically starts to update the EPG data. This updates the EPG data for the first 25 channels of the overall channel list. This update happens however only if the receiver is in standby mode. If the receiver is completely switched off (at the mains) or if it is in operation, the update will be delayed. The receiver will update the EPG data when it is next switched from operating mode into standby mode. After updating the data, the receiver automatically switches back to standby. You can however by

pressing the  button break off the update before it is finished; the receiver then switches immediately into standby mode.

REFERENCE NOTE ON AUDIO MPEG INC. AND S.I.SV.EL, S.P.A:

This device employs legally protected technologies which are protected by patents in the USA as well as by intangible property laws in other countries.

Audio MPEG Inc. and Societa' Italiana per lo sviluppo dell'elettronica, S.I.SV.EL, S.P.A, have granted KATHREIN-Werke KG rights of use which are subject to certain restrictions. These restrictions must also be observed by you as a customer.

According to these, this device is only to be used by end customers for private, non-commercial purposes and for licensed content. Use for commercial purposes is not authorised. Utilisation of products or procedures sold or used with this device are not comprehended. With reference to licensed technologies, application of reversible procedures as well as dismantling of the device are both not permitted.

CONTENTS

PREFACE	2
IMPORTANT INFORMATION	3
CONTENTS	4
SAFETY INSTRUCTIONS - IMPORTANT NOTES	6
RECEIVER FEATURES/SCOPE OF SUPPLY	7
CONTROLS, DISPLAYS AND CONNECTIONS	8
CONNECTION AND SET-UP	9
SUSPENDED INSTALLATION	11
INSTALLATION ON A FIXED FLAT SURFACE	11
REMOTE CONTROL	12
FIRST INSTALLATION	14
OPERATING INSTRUCTIONS	32
MENU CONCEPT	32
MENU TREE	33
ALPHANUMERIC INPUTS	34
LANGUAGE SELECTION - OSD	34
ON-SCREEN DISPLAYS (OSD)	35
CHANNEL MESSAGES	35
CHANNEL INFORMATION.....	35
OPTION SELECTION	35
ERROR SIGNALLING	36
CHANNEL LIST - TV/RADIO	36
EPG - ELECTRONIC PROGRAMME GUIDE	38
CALL UP EPG	38
"CURRENT" VIEW	39
"COMING UP" VIEW (PROGRAMME LISTINGS)	40
CATEGORIES VIEW	41
SCAN FUNCTION	42
ADDITIONAL INFORMATION (i-BUTTON).....	43
REMINDER FUNCTION (CHANGE OVER TO PROGRAMME).....	44
RECORDING (TIMER).....	44
RECORD ONCE	45
RECORD DAILY	46
RECORD WEEKLY	46
RECORD USER-DEFINED.....	47
SERIES RECORDING	48
VIEW RECORDING SCHEDULE	49
COMMON INTERFACE	50
IMPORTANT INFORMATION	50
INSERTING THE SMARTCARD AND THE CA MODULE	50
VIDEOTEXT (TELETEXT)	52

CONTENTS

EDIT CHANNEL LIST	53
SELECTION OF THE LIST/CHANNELS TO BE EDITED	53
EDITING LISTS/CHANNELS	54
"LAST FUNCTION" MEMORY	55
MOVE CHANNELS	55
DELETE CHANNELS	55
SKIP CHANNELS	55
BLOCK CHANNELS	56
COPY CHANNELS TO THE FAVOURITES LIST	56
START BLOCK HIGHLIGHTING (HIGHLIGHTING SEVERAL CHANNELS)	56
EDIT FAVOURITES LISTS	57
REMOVE FROM THE FAVOURITES LIST	57
BLOCK CHANNELS	58
RENAME FAVOURITE LIST	58
START BLOCK HIGHLIGHTING (HIGHLIGHTING SEVERAL CHANNELS)	58
CHANNEL SEARCH (CHANNEL SCAN)	59
AUTOMATIC (CHANNEL) SCAN	59
MANUAL (CHANNEL) SCAN.....	61
CHANNEL SCAN WITH SERVICE ID.....	63
PARENTAL CONTROL	65
BLOCKING THE MAIN MENU	65
BLOCKING THE RECEIVER	65
SETTING A NEW CODE (PIN).....	65
SETTINGS	66
TV SETTINGS	67
CONFIGURING THE ON-SCREEN MENU	68
DATE AND TIME	70
COMMON INTERFACE	70
ANTENNA CONFIGURATION	70
SERVICE MENU	71
UPDATING SOFTWARE	71
FACTORY DEFAULT	73
CONNECTING UP THE VIDEO/PVR	74
USING THE FRONT PANEL	75
TECHNICAL APPENDIX	76
FEATURES	76
SCART SOCKET ASSIGNMENT	78
VHS/S-VHS SWITCHING.....	78
CONNECTION EXAMPLE.....	79
EXAMPLES single-cable systems	80
SHORT TECHNICAL GUIDE	84
GLOSSARY	86
TROUBLESHOOTING	87
SERVICE	87

SAFETY INSTRUCTIONS - IMPORTANT NOTES

This page contains important information about the operation, installation location and connection of the unit.

Read these instructions carefully before starting to use the unit.



Mains cable

Make sure that the mains cable (power supply cable) is not damaged. Units with a damaged mains cable must be disconnected from the mains (disconnect mains connector) and repaired by a qualified engineer before setup. Only use the power pack supplied (if available).

Risk of death due to electric shock.

Cleaning

Disconnect the mains connector before cleaning the unit. Only use a dry cloth for cleaning and only clean the outer surface. Never open the unit.

Touching the parts inside the unit carries a risk of death due to electric shock.

Playing children

Make sure that children do not push any objects into the ventilation slots.

Risk of death due to electric shock.



Earth connection

The antenna system must be earthed as specified or equipotentially bonded. EN 60728/11 and any national regulations must be complied with.

Danger due to surge voltages, lightning strikes.

Mains voltage

Only operate the unit with the specified mains voltage (marked on the rear of the unit or on the external power pack). The unit may only be connected to the mains and turned on once it has been connected to the antenna and to the TV set or the cable network and PC.

If the mains voltage is too high, there is a risk of fire.

Repairs

Ensure that any repairs to your unit are carried out by qualified personnel. Opening the unit and attempting to repair it yourself voids all warranty claims.

Improper work on the unit can jeopardise the electrical safety of the unit.

The manufacturer accepts no liability for accidents caused by the user opening the unit.



Connections

Incorrect wiring of the connections can lead to malfunctions or defects on the unit.

Long periods of absence / storms

Always turn off the unit at the mains switch if you will be absent for a long time or there is a storm. If your unit does not have a mains switch, you can disconnect it from the mains by unplugging the mains connector. This also applies to the other equipment connected to the unit. Isolation from the cable network is also recommended. Note any timer programs (receiver) and turn the unit on again promptly before the recording time.



Installation location

All electronic equipment generates heat. However, the heating of this unit lies within the permissible range. Sensitive furniture surfaces and veneers may become discoloured by the effects of constant heat over time. The feet of the unit can also cause colour changes to treated furniture surfaces. If necessary, place the unit on a suitable stable and flat base.



Ventilation

The heat generated in this unit is adequately dissipated. However, the unit should never be installed in a cupboard or on shelves with inadequate ventilation. Never cover the cooling slots on the unit (e.g. with other equipment, magazines, tablecloths or curtains).

Do not place any objects on top of the unit and maintain a clearance of at least 10 cm above the unit, so that the heat generated can be dissipated with no obstructions.

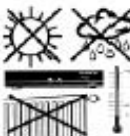

Moisture, sunlight, heat

Protect the unit against moisture, dripping and splashed water (do not place any filled objects such as vases on top of the unit). Do not place the unit close to a heater or expose it to direct sunlight and do not operate it in damp locations. Only use the unit in a moderate climate, not in tropical conditions.

RECEIVER FEATURES/SCOPE OF SUPPLY

The receiver UFS 740sw is suitable for the reception of digital satellite TV and radio channels.

The integral Common Interface has slots for two CA modules for decrypting Pay-TV programmes.

In addition to providing high-quality pictures and sound, UFS 740 units also feature an attractive design and 16-character display.

The external power supply unit means that the unit can be operated on both 12 V and on 230 V. A mounting kit for flat or suspended mounting of the receiver is supplied.

The UFS 740sw can be used to control the CAP 900, CAP 700 and CAP 600.

PRODUCT PACKAGE

- UFS 740sw (black)
- Remote control RC 660
- TV connection cable 3 x Cinch to Scart
- Mounting kit (2 pieces)
- 2 Batteries AAA 1.5 V
- IR sensor
- Power supply cable
- 12-V connection cable with fused universal plug (cigar lighter and standard 12V plug-in socket)
- Power supply unit 230 V/12 V
- Operating manual

SIGNAL STRENGTH DISPLAY AND SEARCH TONE OUTPUT VIA THE TV SET

Before using the search tone to align the antenna, you must have completed the first installation.

Press the **i** button for three seconds to switch on the search tone. The current signal strength (at the input to the receiver) is displayed simultaneously on your receiver. The higher the tone, the better the

signal strength. Press the **i** button again for three seconds to switch off the search tone.

CONTROLS, DISPLAYS AND CONNECTIONS

This section provides a brief description of all the controls, displays and connections.

VIEW OF FRONT PANEL (FLAP FOLDED DOWN)

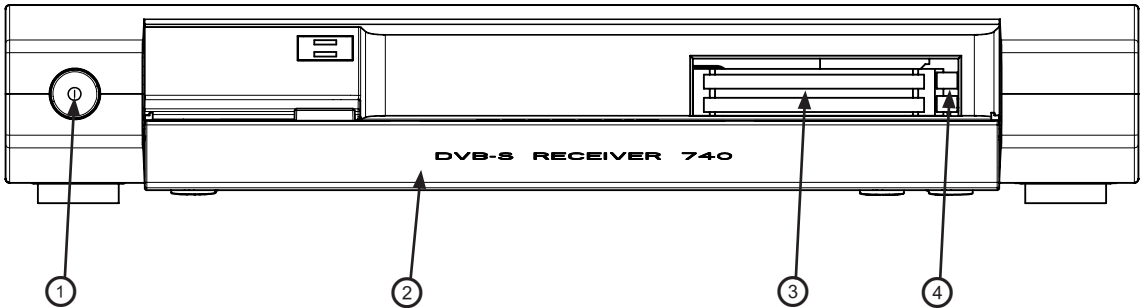

VIEW OF REAR PANEL

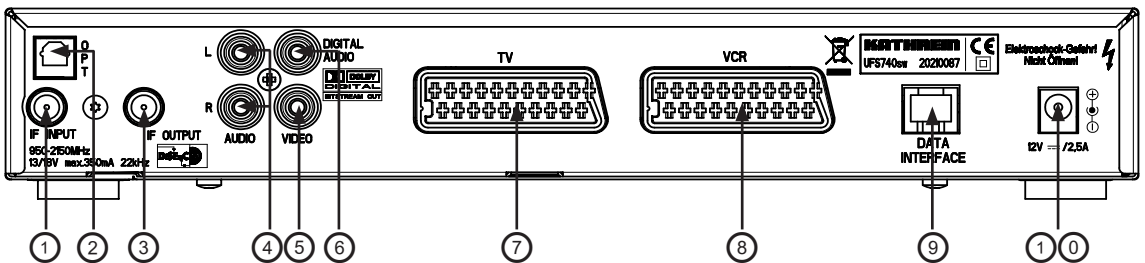

Front panel controls and displays

1. On/Off switch (with mains disconnect)
2. Display (cover folded down)
3. Common Interface for two CA modules for Pay-TV cards *)
4. Ejection button for CA modules

In addition there are three further buttons on the front of the display

- TV/R button for switching between TV and radio mode
- Channel select buttons (▼ ▲)

Rear panel controls and displays

1. LNB input
2. Optical data stream output (SPDIF/Sony Philips Digital Interface Format) for Dolby Digital AC 3 audio
3. LNB loop-through input
4. Audio outputs (L/R) cinch sockets
5. Video output (composite colour)
6. Electrical data stream output (SPDIF/Sony Philips Digital Interface Format) for Dolby Digital AC 3 audio
7. Scart socket for TV connection
8. Scart socket for VCR/AUX connection
9. RJ 11 data interface
10. Mains power cable

*) CA modules and Pay TV cards (smart cards) are not included

CONNECTION AND SET-UP

The following section is intended specifically for specialist dealers. You only need to pay attention to this section if you are carrying out the installation yourself.

The "Connection Examples" section provides a sample configuration.

Do not connect the unit to the power supply until all installation work has been properly carried out. Refer to the information in the "Safety Instructions" section.



The receiver must be connected to no other power supply than 12 V DC. The receiver's earth connection must be connected to the negative pole of the motor home or caravan battery!

CONNECTING THE UNIT (SAT-IF CONNECTIONS)



Connect the Sat IF inputs on the receiver to the satellite reception system. Use a coaxial cable with a standard F connector.

If the F standard connectors are not yet fitted on the cable, strip the insulation from the cable as shown in the following illustration and carefully twist the F standard connectors on to the ends of the cables until they are securely seated.

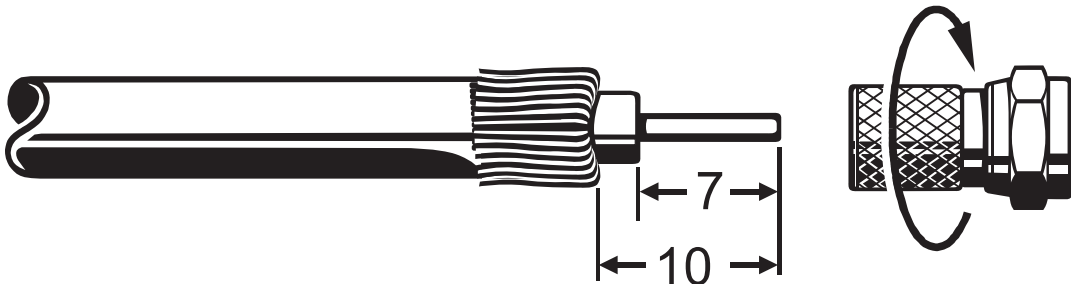

When fitting the connector, make sure that no wires from the braid are touching the inner conductor, so no short circuit can occur.

The quality of the reception signal depends on this connection!

RECEPTION REQUIREMENTS



Make sure that your own satellite antenna system is equipped at least with a universal LNB for digital reception in the high-band range.

RECEPTION SYSTEM PRESETS

The presets for the control signals have been made for standard reception systems, i.e. 14/18 V for polarity reversal and 22 kHz switching signal for low/high band changeover on multi-feed reception systems.

CONNECTION AND SET-UP

TV AND VIDEO RECORDER CONNECTION

Connect the satellite receiver (Cinch socket) and the TV set (Scart socket) using the Cinch to Scart cable supplied, or connect both units (Scart sockets) using a Scart cable (see "Connection Example"). If your TV has a stereo feature, you can receive the sound in stereo via the Scart connection. Use a further Scart cable to connect the satellite receiver (VCR/Scart socket) to the video recorder/PVR. For system reasons, the same video signals are to be found at the TV Scart socket as at the video cinch output.



If you are recording using an external video recorder, remember not to operate the receiver during recording, otherwise all the on-screen displays will appear on your recording.

AUDIO CONNECTION

If you want to play the sound on your hi-fi system, connect the audio cinch sockets to the input sockets on the hi-fi system, using an appropriate cable (see "Connection Example").

OPTICAL/ELECTRICAL DIGITAL OUTPUT

The fibre-optic output and the electrical digital output are intended for the connection of a Dolby Digital system (see "Connection Example").

INSERTING BATTERIES INTO THE REMOTE CONTROL

Remove the cover on the rear of the remote control.
Insert the two supplied batteries into the remote control. Ensure correct polarity of the batteries; the + and - markings are indicated inside the battery compartment.
Slide the cover back into the housing until it locks in place.

INSTALLING THE UFS 740sw USING THE MOUNTING KIT

The mounting kit supplied offers you the option not only of placing the receiver on a solid flat surface, but also of fixing it in place and of suspending it (e.g. underneath a shelf).



When selecting the mounting location, take care that it conforms to the instructions in the chapter "Safety Instructions"! Note the need to access the connection sockets at the rear of the receiver and allow sufficient space for the cables once connected!

CONNECTION AND SET-UP

SUSPENDED INSTALLATION

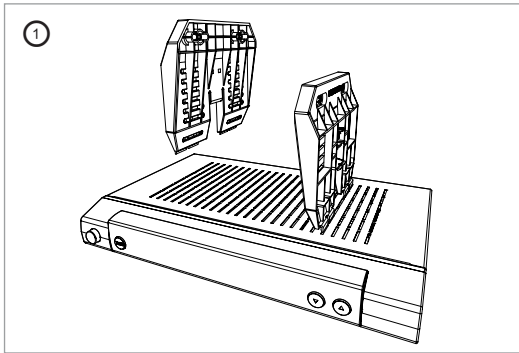

Remove the wood screws supplied from their transport attachment on the underside of the respective mounting piece (2 pieces).

Vertically insert each mounting piece into the fifth slot from the edge, as shown in Fig. 1.

Then push each mounting piece downwards and outwards (see Fig. 2) until they lie flat on the receiver casing (see Fig. 3).

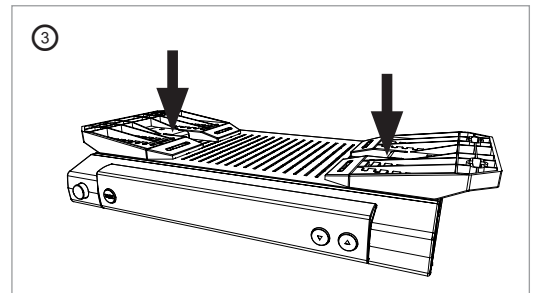
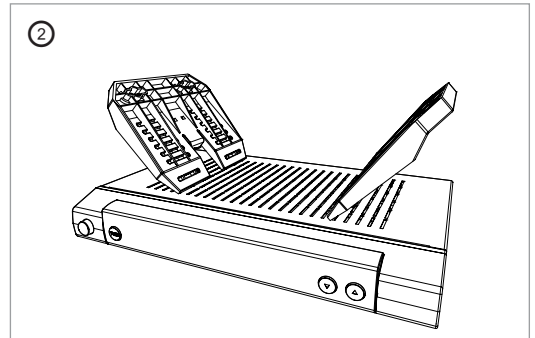

Now press the mounting pieces firmly against the receiver casing at the points shown arrowed in Fig. 3), until the catch audibly snaps home in the receiver casing.

Now hold the receiver, with the mounting kit attached, at the installation location. Screw in the wood screws supplied, through the smaller positions in the screw attachment area (4 x) (see Fig. 4). Wherever possible, use the wood screws supplied. If these are unsuitable, other screws of adequate size and strength can be used. **Under no circumstances however use countersunk wood screws, since these can damage the attachment area (see Fig. 5).**

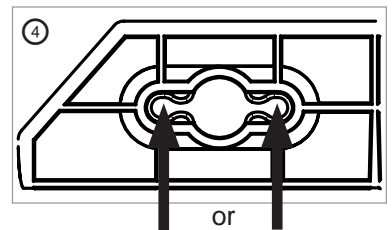

Then screw all four screws fully home, so that the mounting kit is no longer able to work loose.

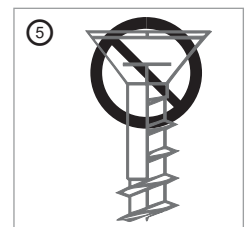



INSTALLATION ON A FIXED FLAT SURFACE

So as to prevent the receiver slipping or falling, the mounting kit can also be attached to the underside of the receiver. Assembly is the same as for suspended installation, except that the mounting kit is hooked into the underside of the receiver.

REMOTE CONTROL

 Sound on/off

 Switch on/input digits for channels, timer etc.

 Call up the main menu, exit the menu and return to the TV picture

 Call up favourites selection

 "Current" view in the EPG

 Volume

 Exit menu step by step

 Changing channel in the programme guide (EPG)

 Transparent videotext

 Currently not used

 Recording in EPG, editing in channel list



 Stand-by

 Videotext (Teletext)

 Call up channel options sound/subtitles selection

 Switch between TV/radio

 Call up channel messages channel information

 AV mode

 Channel selection up/down

 Input confirmation call up channel list

 Cursor buttons

 Call up EPG (programme guide)

 Changing channel in the programme guide (EPG)

 Stop recording/playback

The button symbols shown here can also be found in the description of the operating steps.

REMOTE CONTROL

REMOTE CONTROL RC 660

The RC 660 remote control supports up to four devices (which are supplied with the RC 660 as standard) as well as the receivers of the UFD 5xx (not UFD 552, 554, 558) and UFD 4xx families.









First switch all receivers off (at the power switch).

To configure a receiver to an infrared code:

Switch on the relevant receiver.

On the remote control simultaneously press









Address 1 =  +  + .



Then switch the receiver off again at the power switch and do the same for the other units ( +  + 
for the second receiver;  +  +  for the third receiver and  +  +  for the fourth receiver).

Make sure only one receiver is on at a time!

To switch the remote control to an infrared code:

When you have configured all receivers to their infrared code, to switch between units on the remote control do the following:

For the first receiver's remote (address 1) press  +  for the second receiver  + , for the third receiver  +  and for the fourth receiver  + .

 +  (red) = Kathrein UFD 5xx code for remote control RC 400

The RC 600 and RC 650 remote controls cannot be replaced!

FIRST INSTALLATION

Before using your unit for the first time, read the “Safety Instructions” and “Connection and Set-Up” sections.



The “Connection Examples” section provides a sample configuration.

Do not connect the unit to the power supply until all installation work has been properly carried out.

The guidance given in the “First Installation” section assumes that the receiver has been properly connected, as per the “Safety Instructions” and “Connection and Set-Up” sections.

First switch your TV set on and select the AV channel slot. Switch on your receiver at the power switch on the front of the unit. The following display appears:



Also pay attention to the bars at the bottom of the on-screen display! This provides hints on what to do next.

Select the menu language you want using the   buttons. Available options: German, English, French, Italian, Spanish, Czech, Dutch and Turkish.

Press the  (green) button to move to the next menu.

Note: *If you are unsure whether you chose the right option from a previous menu, you can go back a step at any time during the first installation process by pressing the  (red) button.*

The following display appears:

FIRST INSTALLATION



Use the ◀ ▶ buttons to select whether to replace the default channel list with one pre-sorted for Germany, Austria, Switzerland or Italy. If you want to use the default channel list, choose “No”

under “Restore Channellist”. Press the  (green) button to move to the next menu. The following display appears:



Use the ▲ ▼ ◀ ▶ buttons here to select the settings for your TV set.

When doing this, refer to the operating instructions for your TV set!

TV format

Select the TV's picture format. Either

4:3 or
16:9

FIRST INSTALLATION

Screen display

Here you select the type of screen display, depending on the setting of your TV format:

- TV format "4:3": Pan & Scan or Letterbox
- TV format "16:9": Always 16:9 or automatic

TV Scart signal output



Select the type of video signal at the TV Scart socket here. Select the signal that your TV set can process.

- CVBS – Colour Video Baseband Signal
- RGB – Red/Green/Blue signal or
- Y/C – S-Video signal (luminance/chrominance)

Press the  (green) button to move to the next menu.

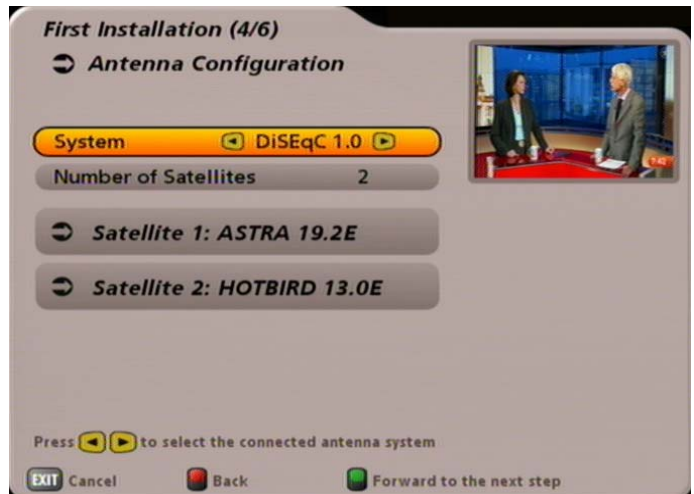
The following display appears:



Select the setting here to match your reception system using the   buttons. You have the following options:

- DiSEqC™1.0
- LNB only
- One cable or
- CAP (see installation and operating instructions for your CAP unit)

Now continue with the first installation chapter that applies to your reception system.



When selecting the LNB type in the setting that applies to you, note that "Wideband" is available only for the "single-cable system" setting!

FIRST INSTALLATION



When selecting the satellite(s), make sure that your reception position is aligned to the desired satellite(s)!

The first installation with a CAP 900 automatic turntable unit is explained in the installation manual supplied with the turntable unit.



System

Select the setting here to match your reception system using the buttons. If your reception system is DiSEqC™-capable, at System select “DiSEqC™ 1.0” (allows switch-over from receiving one satellite to receiving another one). If your reception system is DiSEqC™-capable, select the setting “LNB only”.

Press the button to move to the next menu item.

For ease of understanding, the further explanations of the first installation are split into two columns.

The description on the left refers to installation of a non-DiSEqC™-capable system and on the right to installation of a DiSEqC™-capable system.



Satellite and position

Use the buttons to select the desired satellite whose signal is to be received by the tuner.

When you have selected your desired satellite,

use the buttons to switch to the selection of the “LNB Type”.



Number of satellites

Press the button to select the satellite to be received.

The following display appears:

FIRST INSTALLATION



LNB settings

Here use the buttons to select the LNB type used in your system. The choice is between "Universal" and "User-defined".

Universal:

No further input required, since all necessary frequency ranges are covered by a universal LNB.

User-defined:

If you choose not to use a universal LNB, you must here set the frequency ranges for which your LNB was configured.

Use the buttons to select the frequency range to be changed (low, high or limit frequency).

Use the buttons or the digital input buttons to set the exact frequency for which your LNB was configured.

Test transponder

To check whether the settings that you have made are correct, use the buttons to move to the "Test transponder" field.

Use the buttons to select the required transponder from the various ones listed. If your settings are correct, you will see at the top right of the screen the live signal of a channel for the currently selected transponder.

If you are not receiving a signal, check your settings again and if necessary call for expert help.



Use the buttons to select how many satellites (max. 4) you would like to receive with your reception system. The following display appears (example):





Use the buttons to select the first satellite slot. Press to access the menu for the satellite settings. The following display appears (example):





FIRST INSTALLATION

Satellites and position

Use the   buttons to set the desired satellite (selection from 17 pre-programmed options).

LNB settings



Here use the   buttons to select the LNB type used in your system. The choice is between “Universal” and “User-defined”.



Universal:

No further input required, since all necessary frequency ranges are covered by a universal LNB.



User-defined:



If you choose not to use a universal LNB, you must here set the frequency ranges for which your LNB was configured.

Use the   buttons to select the frequency range to be changed (low, high or limit frequency).

Use the   buttons or the digital input buttons to set the exact frequency for which your LNB was configured.

Test transponder

To check whether the settings that you have made are correct, use the   buttons to move to the “Test transponder” field.

Use the   buttons to select the required transponder from the various ones listed. If your settings are correct, you will see at the top right of the screen the live signal of a channel for the currently selected transponder.



If you are not receiving a signal, check your settings again and if necessary call for expert help.

You have now completed all settings for the first satellite. Press the  button to return to the “Satellite Selection Menu” and perform the settings in the same way for the remaining satellites.

The notes on first installation are unified once again from this point!

When you have finished configuring the satellite press the  (green) button. The receiver then automatically calls up the selection menu for the channel search:

FIRST INSTALLATION: One cable



Use the   buttons here to select “One cable” as the “System”. Press the  button to move to the next menu item. The following display appears:



The various options for a single-cable system with Kathrein components are summarised at the end of this manual in the “Technical Appendix” section under “Examples of Single-Cable Systems”.



Number of satellites

Use the   buttons to select how many satellites (max. 2) you would like to receive with your reception system. Press the  button to move to the next menu item.

Configure satellites

Press the  button to open the menu. The following display appears:



Satellite and Position

Use the   buttons to select the first satellite (satellite 1 of 2, depending on the setting) as shown on the screen.

LNB settings

Here use the   buttons to select the LNB type used in your system. The choice is between “Universal”, “Wideband” and “user-defined”.

If in your reception system you use a single-cable LNB (e.g. UAS 481 from Kathrein), please select here the setting “Wideband”. If you use a single-cable matrix (EXU 908) or a single-cable switching matrix (EXR 551 or EXR 552) from Kathrein, the LNB you use must be a “Universal LNB”!

FIRST INSTALLATION: One Cable

Universal:

No further input is required, since all necessary frequency ranges are covered by a universal LNB.

Wideband:

No further input is necessary, since all frequency ranges are set by the Wideband LNB.

User-defined:

If you are not using a Universal or a Wideband system, you must set the frequencies here. You can find the necessary information in the documentation supplied with your system.



Use the   buttons to select the frequency range to be changed (low, high or limit frequency).

Use the   buttons or the keypad to set the exact frequency for which your LNB was configured.



When you have completed all setting for the currently selected satellite, press the  button. If you have selected more than one satellite, repeat the previous “Satellite and Position” and “LNB Type” processes for the number of satellites you selected.

When you have completed the settings for all the satellites, the following display appears:

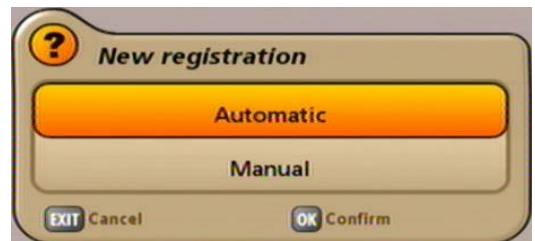

Use the  button to select the next menu item “New registration” and press the  button. The following display appears:



Use the   buttons to select the desired type of installation and confirm your selection using the  button. For clarity, we have split further details into two sections.



Firstly we give details of “Automatic” installation, then details of “Manual” installation.

FIRST INSTALLATION: One cable (automatic)



If one or more receivers are already present on the system and an additional receiver is to be connected, when assigning the transmission frequency for the new receiver make sure that no transmission frequencies are duplicated. No frequency can be used by more than one receiver.

The receiver searches for the transmission channels on your single-cable system and shows in the next display the available transmission channels (transmission channels already in use by other receivers are also displayed).

Use the   buttons to select the transmission channel you want and confirm the selection with the  button.



No frequency can be used by more than one receiver.
The receivers would interfere with each other.

The receiver now reads the existing system data for your single-cable system and configures itself.

The receiver has been successfully registered on your single-cable system. Confirm the display with the  button.

Now press the  (green) button. The receiver will automatically display the menu for the channel search. Continue with the section (Execute channel search).

If no connection to the single-cable system could be established, you will receive the message "Registration was abortive!". Check your settings and if necessary call for expert help.





FIRST INSTALLATION: One cable (manual)

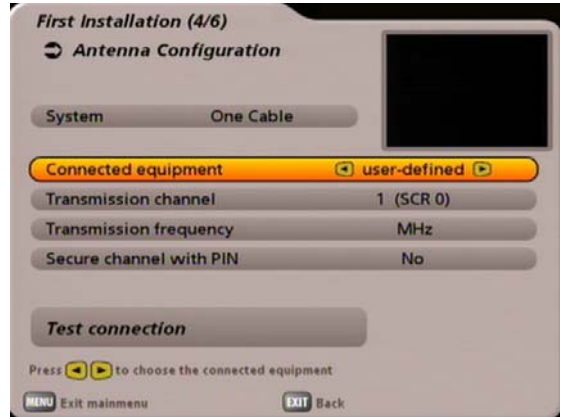

If one or more receivers are already present on the system and an additional receiver is to be connected, you must assign the new receiver a transmission frequency that is not already in use (otherwise the receivers will interfere with each other). Depending on the system to which they are connected, a maximum of four or eight receivers may be connected to a single-cable system (a twin receiver counts as two receivers).



Connected equipment

Use the   buttons to select the type of system to which they are connected or the single-cable system components fitted (refer to the manuals, instructions and notes for the system and the system components). Available options:

- User-defined
- KATHREIN UAS 481 (single-cable feed system, max. four receivers)
- KATHREIN EXR 551 (single-cable switching matrix, max. four receivers)
- KATHREIN EXR 552 (single-cable switching matrix, max. two receivers)
- KATHREIN EXU 908 (single-cable matrix, max. eight receivers)
- EXR 4 Subscribers (for future Kathrein single-cable switching matrices, max. four receivers)
- EXR 8 Subscribers (for future Kathrein single-cable switching matrices, max. eight receivers)

Selection “user-defined”

Transmission channel

Use the   buttons to select a free available transmission channel.

Transmission frequency

Use the number buttons to input the four-digit transmission frequency.





No frequency can be used by more than one receiver. The receivers would interfere with each other. You can find the necessary information (transmission frequencies) in the documentation supplied with your system.

FIRST INSTALLATION: One cable (manual)

Secure channel with PIN

If your single-cable system allows the transmission frequency to be protected by inputting a PIN, this is the menu where that can be done. No other receiver can then use that transmission frequency unless the PIN is input.







Select the setting "Yes" using the   buttons. A line with the text "Password PIN" is then displayed.

Press the   buttons to select this line. You can now use the number buttons to enter a PIN (0-255).

Test connection

When you have completed all the settings, press the   buttons to switch to the "Test connection"

selection field and press the  button. The receiver now tests whether a connection to the single-cable system can be established or not. As soon as the receiver has established a connection to the single-cable system, you will see the following display:

Confirm this display with the  button. Then press the  button. You will be asked whether you wish to save the changes. Use the   buttons to select "Yes, save changes" and confirm by pressing the  button. Now press the  (green) button.

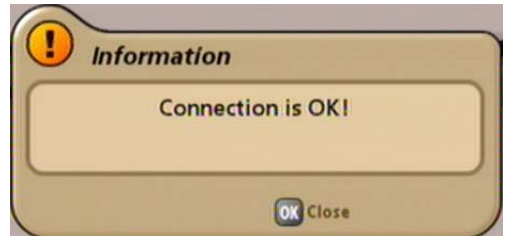

The receiver will automatically display the menu for the channel search. Continue with the section (Execute channel search).

If no connection to the single-cable system could be established, the following display appears:

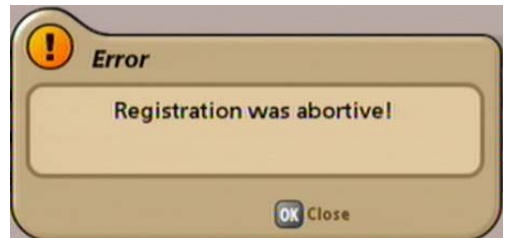

Check your settings (frequency and transmission channel) and if necessary call for expert help.

FIRST INSTALLATION: One cable (manual)

Selection “UAS 481” or “EXR 551”



When the “UAS 481” single-cable feed system is being used, it is essential that the LNB is set to “Wideband”!
When the “EXR 551” single-cable switching matrix is being used, it is essential that the LNB is set to “Universal”!



Transmission channel

Use the buttons to select a free available transmission channel. A maximum of four transmission channels are available (1400, 1516, 1632 and 1748 MHz).

Test connection

When you have set a free transmission channel, press the buttons to switch to the “Test connection” selection field and press the button. The receiver now tests whether a connection to the single-cable system can be established or not. As soon as the receiver has established a connection to the single-cable system, you will see the following display:

Confirm this display with the button. Then press the button. You will be asked whether you wish to save the changes. Use the buttons to select “Yes, save changes” and confirm by pressing the button. Now press the (green) button.

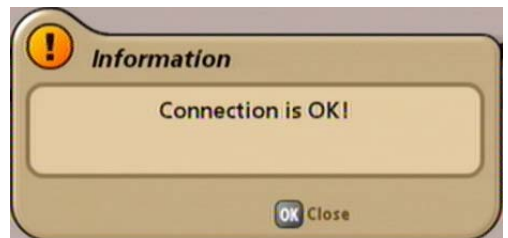

The receiver will automatically display the menu for the channel search. Continue with the section (Execute channel search).

If no connection to the single-cable system could be established, the following display appears:

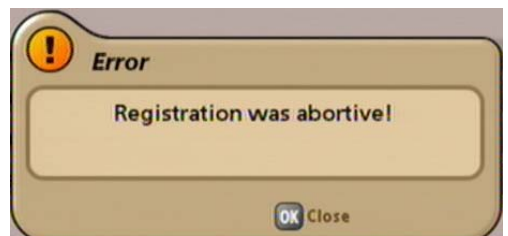

Check your settings and if necessary call for expert help.

FIRST INSTALLATION: One cable (manual)

Selection "EXR 552"



When the "EXR 552" single-cable switching matrix is being used, it is essential that the LNB is set to "Universal"!



Transmission channel

Use the [Left] [Right] buttons to select a free available transmission channel. A maximum of two transmission channels are available (1400 and 1516 MHz).

Test connection

When you have set a free transmission channel, press the [Up] [Down] buttons to switch to the "Test connection" selection field and press the [OK] button. The receiver now tests whether a connection to the single-cable system can be established or not. As soon as the receiver has established a connection to the single-cable system, you will see the following display:

Confirm this display with the [OK] button. Then press the [EXIT] button. You will be asked whether you wish to save the changes. Use the [Up] [Down] buttons to select "Yes, save changes" and confirm by pressing the [OK] button. Now press the ^{PP} (green) button.

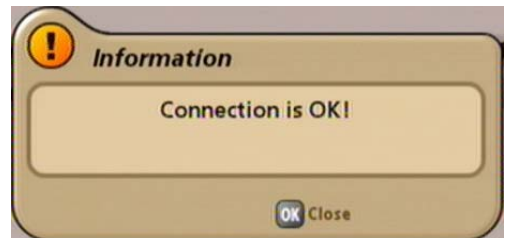

The receiver will automatically display the menu for the channel search. Continue with the section (Execute channel search).

If no connection to the single-cable system could be established, the following display appears:

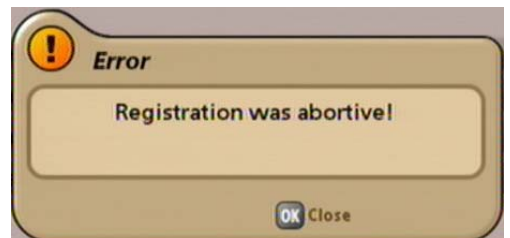

Check your settings and if necessary call for expert help.

FIRST INSTALLATION: One cable (manual)

Selection "EXU 908"



When the "EXU 908" single-cable matrix is being used, it is essential that the LNB is set to "Universal"!



Transmission channel

Use the buttons to select a free available transmission channel. A maximum of eight transmission channels are available (1284, 1400, 1516, 1632, 1748, 1864, 1980 and 2096 MHz).

Secure channel with PIN

The EXU 908 single-cable matrix allows the transmission frequency to be protected by inputting a PIN. No other receiver can then use that transmission frequency unless the PIN is input.

Select the setting "Yes" using the buttons. A line with the text "Password PIN" is then displayed.

Press the buttons to select this line. You can now use the number buttons to enter a PIN (0-255).

Test connection

When you have set a free transmission channel, press the buttons to switch to the "Test connection"

selection field and press the button. The receiver now tests whether a connection to the single-cable system can be established or not. As soon as the receiver has established a connection to the single-cable system, you will see the following display:

Confirm this display with the button. Then press the button. You will be asked whether you wish to save the changes. Use the buttons to select "Yes, save changes" and confirm by pressing the button. Now press the (green) button.

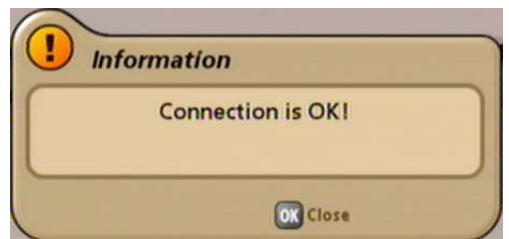

The receiver will automatically display the menu for the channel search. Continue with the section (Execute channel search).

If no connection to the single-cable system could be established, you will receive the message "Registration was abortive!".

Check your settings and if necessary call for expert help.

FIRST INSTALLATION: One cable (manual)

Selection "EXR 4 Subscribers"



When a Kathrein single-cable switching matrix is used for four subscribers, it is essential the LNB is set to "Universal"!



Transmission channel

Use the buttons to select a free available transmission channel. A maximum of four transmission channels are available (1284, 1400, 1516 and 1632 MHz).

Test connection

When you have set a free transmission channel, press the buttons to switch to the "Test connection" selection field and press the button. The receiver now tests whether a connection to the single-cable system can be established or not. As soon as the receiver has established a connection to the single-cable system, you will see the following display:

Confirm this display with the button. Then press the button. You will be asked whether you wish to save the changes. Use the buttons to select "Yes, save changes" and confirm by pressing the button. Now press the (green) button.

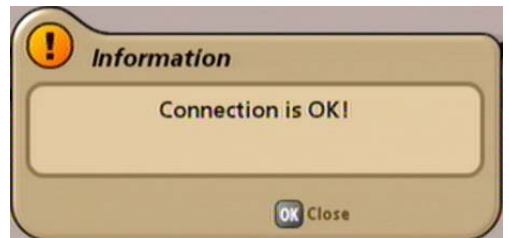

The receiver will automatically display the menu for the channel search. Continue with the section (Execute channel search).

If no connection to the single-cable system could be established, the following display appears:

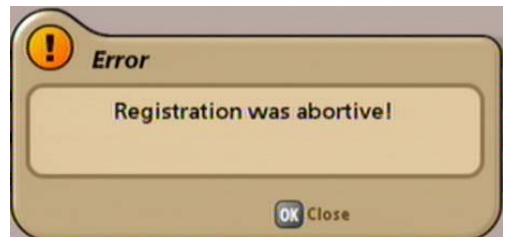

Check your settings and if necessary call for expert help.

FIRST INSTALLATION: One cable (manual)

Selection "EXR 8 Subscribers"



When a Kathrein single-cable switching matrix is used for eight users, it is essential that the LNB is set to "Universal"!



Transmission channel

Use the [Left] [Right] buttons to select a free available transmission channel. A maximum of eight transmission channels are available (1284, 1400, 1516, 1632, 1748, 1864, 1980, 2096).

Test connection

When you have set a free transmission channel, press the [Up] [Down] buttons to switch to the "Test connection" selection field and press the [OK] button. The receiver now tests whether a connection to the single-cable system can be established or not. As soon as the receiver has established a connection to the single-cable system, you will see the following display:

Confirm this display with the [OK] button. Then press the [EXIT] button. You will be asked whether you wish to save the changes. Use the [Up] [Down] buttons to select "Yes, save changes" and confirm by pressing the [OK] button. Now press the  (green) button.

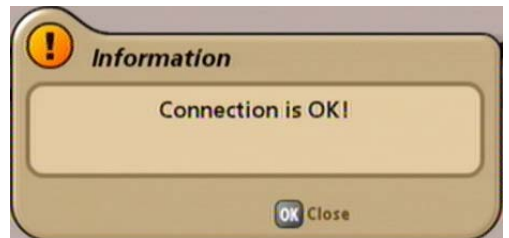

The receiver will automatically display the menu for the channel search. Continue with the section (Execute channel search).

If no connection to the single-cable system could be established, the following display appears:

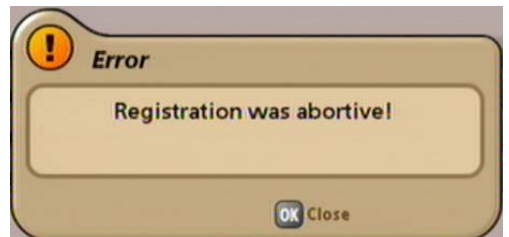

Check your settings and if necessary call for expert help.

FIRST INSTALLATION



Perform channel scan

Use the [Left] [Right] buttons to select (yes or no) whether you wish to start a channel scan. It is not essential to start a channel scan; instead you can use the factory pre-programmed channels. However the channels do change from time to time (e.g. their frequencies change), which the receiver does not automatically detect, and can then be found only by performing a channel scan.

If you selected "No", you can press the  (green) button to skip directly to the next item of the first installation.

If you selected "Yes", you can press the  button to progress to the next selection item.

Channel scan mode

Use the [Left] [Right] buttons to select whether you wish to scan "free & scrambled", "only free" or "only scrambled" channels.

To view encrypted channels you need the appropriate CA (Conditional Access) module and a valid smart card together with a valid subscription to a Pay-TV provider.

Press the  button to move to the next selection item.

Network scan

If you set the network search to "Off", only the factory stored transponders of the satellites you previously selected will be scanned for new and as yet unlisted channels.

If you set the network scan to "On", the transponder network enables additional transponders that have not yet been stored to be located. They are then stored and scanned for new channels in the same way as the existing transponders.

Press the  (green) button to start the channel scan, or if you set channel scan to "Off" you are guided straight to the next item in the first installation process.

When the scan has been completed, you will see the following message (example):

FIRST INSTALLATION

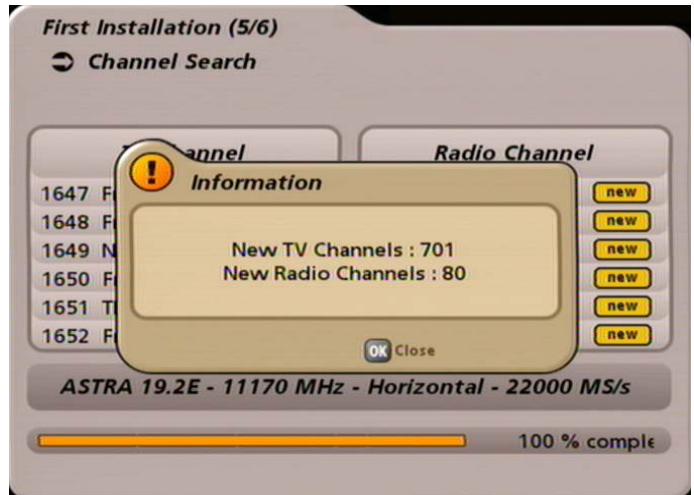

Use the **OK** button to move to the next step of the first installation. The following display appears:



Set Local Time

Use the **◀ ▶** buttons to set the time zone variation from UTC (formerly GMT) (e.g. for Germany +1 hour).

Use the **▲ ▼** buttons to switch to the “Automatic clock change” field. Use the **◀ ▶** buttons to select whether the receiver should automatically change over to and from summer and winter time. If “On” is selected, the receiver automatically sets itself to the right time. If “Off” is selected, the field for manual selection of summer and winter time is displayed below. Use the **◀ ▶** buttons to perform the setting.

Press the **PP** (green) button to close first installation and return to the main menu.

OPERATING INSTRUCTIONS

MENU CONCEPT

The structure of the menu concept is based on logical operating sequences. The programme showing on the current selected channel always appears in the top right-hand corner of the screen.

You will find detailed descriptions of the selected menu items in the relevant sections of the operating manual!

Note: *The selected menus, sub-menus and positions, as well as the parameters to be set, are each highlighted in colour. The menus are self-explanatory.*



Pay attention to the bar at the bottom of the on-screen display! This provides hints on what to do next.

Press the **MENU** button to access the main menu, and use the **▲▼** buttons to select the sub-menus.

Press the **OK** button to access the sub-menus. Use the **▲▼** buttons to select the sub-menu options.

The settings under the various options are made either by pressing the **◀▶** buttons or using the numeric pad. You can exit the main menu and sub-menus, and the various options, step-by-step by pressing

the **EXIT** button (the settings/changes you made are saved). Press **MENU** to return directly from one of the menus to the TV picture (the settings/changes you made are saved).

OPERATING INSTRUCTIONS

MENU TREE

Mainmenu

Call up the menu by pressing the  button



OPERATING INSTRUCTIONS

ALPHANUMERIC INPUTS

Use the displayed keypad (see figure to the right) for entry of favourites names or search terms by selecting numerals for the desired letters/digits. You can write

with upper or lower case letters (MENU button). Use the numeric pad to select the desired character. About two seconds after selection of the character, the cursor

moves automatically to the next position. The ◀ button allows you to delete your entry character by character.



When you have selected all the characters, press the OK button to save your entry and start a scan to find the desired expression.

LANGUAGE SELECTION - OSD

The language for the on-screen display is set as follows:

MENU → ▲ ▼ → Language selection → OK → ▲ ▼ → German → OK

Available options: German, English, Italian, French, Dutch, Spanish, Czech and Turkish.

After you have performed the settings, press the MENU or EXIT button to exit the main menu. You will then return to the TV picture.

ON-SCREEN DISPLAYS (OSD)

CHANNEL MESSAGES

TV CHANNEL MESSAGES

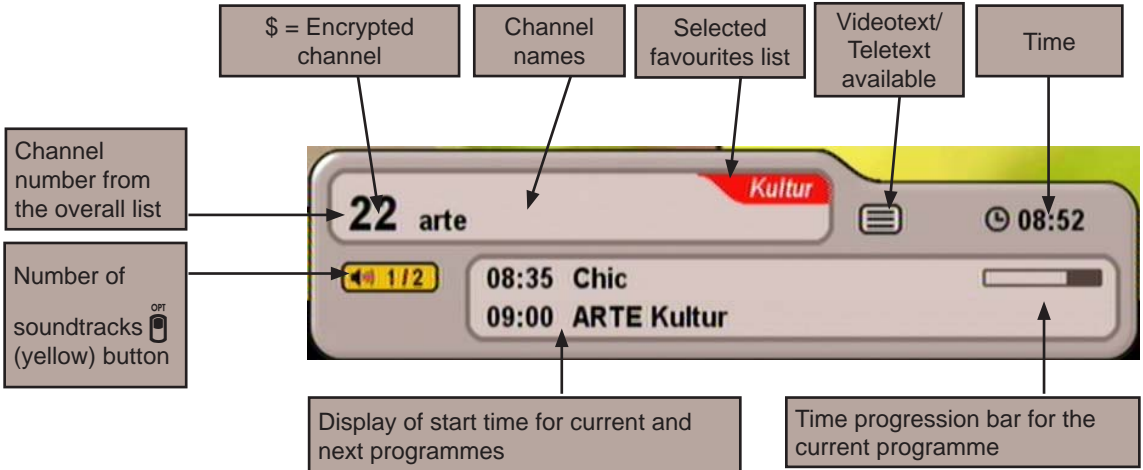

Channel information is shown for a few seconds each time the channel is changed (this can be changed under "Settings", "Adjust Displays") or displayed continuously by pressing the **i** button.

RADIO CHANNEL MESSAGES

The information for the current radio channel has the same layout.

CHANNEL INFORMATION

Press **i** twice to view information on the current channel, if transmitted by the channel provider. Use the **▲▼** buttons to scroll through the pages. By pressing the **◀▶** buttons you can obtain information on the next following programmes on the current channel. Press the **i** or **EXIT** button to exit the display.

OPTION SELECTION

Press the **i** (yellow) button once to view further soundtrack selection options, if these are transmitted by the channel provider. Use the **▲▼** buttons to scroll through the available selection options. Press the **i** (yellow) button again, or press the **EXIT** button to exit this display again.

ON-SCREEN DISPLAYS (OSD)

ERROR SIGNALLING

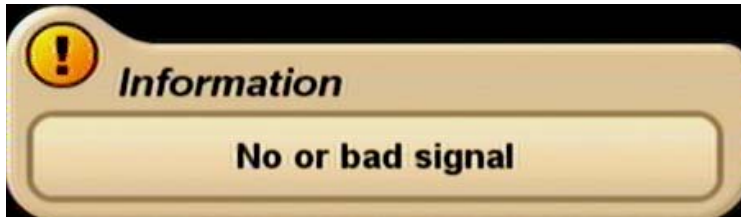

"No or bad signal" indicates that an error has occurred in the reception system or in the receiver settings, or that the transponder is not sending.

Check the Sat IF connection and the LNB configuration. If you have changed settings, compare them against the basic settings (provided you had made a note of them as suggested).

CHANNEL LIST - TV/RADIO



Also pay attention to the bars at the bottom of the on-screen display! This provides hints on what to do next.

Press the **OK** button to access the channel list.

Calling this up displays the channel selection/sorting list from which you selected the last channel. At the top right you will see the selected channel list (TV or radio channels) displayed.









Press the **TV/R** (blue) button to switch between the TV and radio channel lists.

To the right of it you see the current channel list sort order as selected by you.

ON-SCREEN DISPLAYS (OSD)

The channel list can show channels sorted by various selection and sorting criteria.

Selection and sorting options:

- Press the  (red) button to call up the favourites list selection. The   buttons allow you to scroll through the existing favourites lists
- Press the  (green) button to return to the overall list (all satellites). Use the   buttons to choose between the received satellites (display all channels from a satellite) and the list of "New channels" (provided by channel scan).
- Press the  (yellow) button to see an alphabetic listing. This shows all the channels sorted alphabetically, or the ones beginning with the selected initial letter. Use the   buttons to make the selection.

Search function:

- Press the  button to start the search. The numeric pad buttons allow you to input the desired search expression for the channel that is sought (see also "Operating Instructions", "Alphanumeric Input").

Press the  button to start the search.

Info on:

Press the  button to view the following items of information on a program:

By pressing the  button once you can obtain the following additional information:

- Signal strength
- Signal quality
- Transmitting satellite
- Frequency (MHz)
- Polarisation
- Symbol Rate







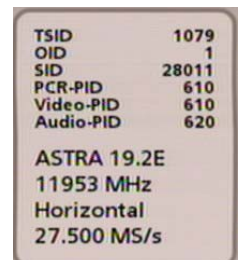

By pressing the  button twice, instead of the signal strength and quality you can display the following identification numbers (IDs) for the current signal:

- TSID (Transponder identification number)
- OID (Network identification number)
- SID (Program-related service identification number)
- PCR PID (Identification number for the synchronisation signal)
- Video PID (Identification number for video signals)
- Audio PID (Identification number for audio signals)



You can hide the additional information by pressing the  button again.

The cursor buttons (   ) are used to navigate within the respective channel list view to select the desired channel. The selection of the desired channel is confirmed by pressing the  button. You will now hear and view the currently selected channel in the small window at the top right. To exit the channel list and return to the TV picture, press the  button again, or press the  button.

EPG - ELECTRONIC PROGRAMME GUIDE

CALL UP EPG



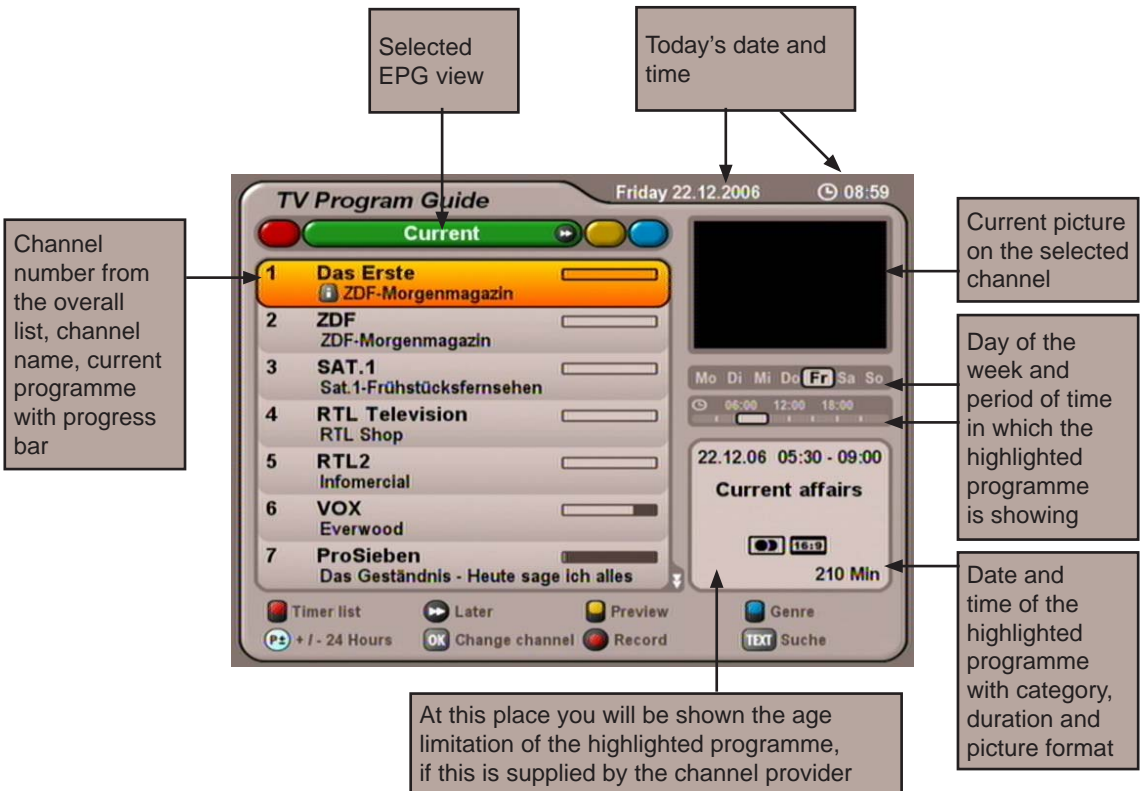







The EPG is called up by pressing the  button. Each time the EPG is called up, you will automatically be shown the "Current" view, irrespective of which view you were shown the last time you exited the EPG. The following display appears (example):











Note: *If you had selected a favourites list before calling up the EPG, you will see in the EPG only the data for the channels that are included in your channel list. Press the  button a second time to view the EPG for all channels.*

EPG - ELECTRONIC PROGRAMME GUIDE

Selection options:

-  (red) button Calls up the recording schedule (display of all pre-programmed recordings)
-  button Jump the "Current" view forwards by 15 minutes
-  (yellow) button Call up a preview of the currently highlighted channel
-  (blue) button Call up the category selection (sorting the programmes by categories such as movies, sport, series ...)
-  button (P+) jump forwards 24 hours in the EPG, (P-) jump backwards 24 hours in the EPG (e.g. into "Current" and into "Coming up")
-  button Selects the currently highlighted channel in all views. Pressing the  or  button again closes the EPG and the selected channel is shown again on the TV screen
-  (red dot) button Adds a programme to the recording settings
-  button Search for a particular programme or programme content (input the search expression using the numeric pad on the remote control, see also the sections "Operating Instructions", "Alphanumeric Input")
-  button If present, shows further information on the selected programme

Navigation within each view is always performed using the cursor buttons (, , , ). The ,  buttons allow you to select individual channels/programmes, and the ,  buttons allow you to scroll from page to page of the currently selected list.

Pressing the  or  button exits the EPG again and returns to the TV picture.







You see information on the current or next following programmes in the EPG only if it is supplied by the channel provider. If no EPG data are available the receiver, instead of showing information on the current programme, shows the message "No data available".



"CURRENT" VIEW



The "Current" view can be called up at any time in EPG by pressing the  (green) button. This is then automatically displayed every time the EPG is started (see screenshot "Calling up EPG").

In the "Current" view you see all channels displayed in the order of the overall channel list. Provided that EPG data has been supplied by the channel provider, the receiver shows for each channel the current programme being shown, with start time, finish time, and progression bar.

You can use the cursor buttons (, , , ) or the keypad buttons to select the desired channel and if available you can use the  button to call up further information on the desired programme.

EPG - ELECTRONIC PROGRAMME GUIDE

The  button allows you to look ahead in 15-minute steps to future programmes for the channels (press the  button to return to the current time).

If you wish to view the programme currently being shown on a channel, you need not exit the EPG, just select the desired channel and press the  button. At the top right of the screen you will see the current TV picture for the selected channel. The picture however only appears once the  button has been pressed. Previously what you saw was the picture of the old channel that had previously been selected, even though the EPG was no longer set to that channel.





“COMING UP” VIEW (PROGRAMME LISTINGS)



The “Coming up” view (programme listings) can be called up at any time in EPG by pressing the  (yellow) button.

Also pay attention to the bars at the bottom of the on-screen display! This provides hints on what to do next.



In the “Coming up” view you will see all the programmes that will be shown in the previous “Current” list of selected channels. Provided that EPG data has been supplied by the channel provider, the receiver shows the programmes that will be shown on the selected channel for several days in advance.

You can use the cursor buttons (, , , ) to select the desired programme and if available you can use the  button to call up further information on the desired programme.

You can use the ,  buttons to scroll through the channels in the order of the overall channel list (the channels can also be selected by inputting digits with the keypad); you remain however in “Coming up”.

The  button allows you to scroll backwards and forwards a day at a time.

Using the  (red dot) button you can load the selected programme into the recording settings (see item “Recording”).

EPG - ELECTRONIC PROGRAMME GUIDE







CATEGORIES VIEW

The “Categories” view can be called up at any time in EPG by pressing the  (blue) button.



In the “Categories” view you can see all programmes sorted by category and starting time. The following categories are available for selection: Movies, Series, Sport, Children’s programmes, Chat shows, News, Magazines/Reportage, Art/Culture, Science/Education, Music, Leisure and Adult programmes.

Programmes can be assigned to the above categories only if the EPG data has been supplied by the channel provider.

Select the required category using the   buttons. You can then use the cursor buttons (, , , ) to select the desired category and if available you can use the  button within each category to call up further information on the desired programme.

The  button allows you to scroll backwards and forwards a day at a time.

Using the  (red dot) button you can load the selected programme into the recording settings (see item “Recording”).

EPG - ELECTRONIC PROGRAMME GUIDE

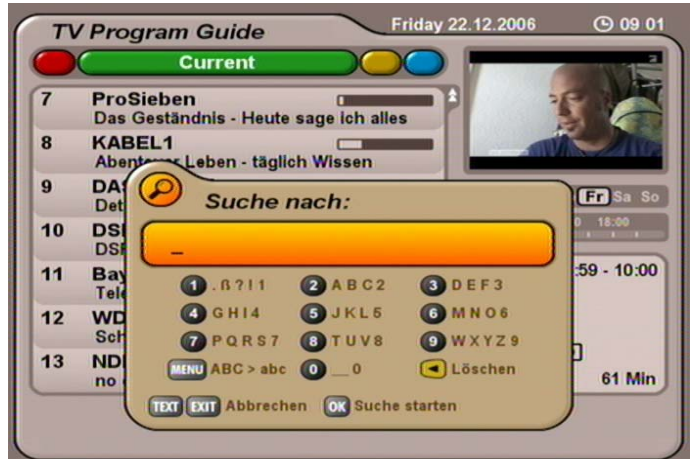

SCAN FUNCTION

The scan function can be called up at any time in EPG by pressing the  button.



The scan function allows you to search for programmes based on their additional information or their name. Use the keypad to input the desired search expression (see also "Operating Instructions" "Alphanumeric Input").

When you have input the desired search expression, press the  button to start the scan.

You can then use the cursor buttons () to select the desired programme from the search result and if available you can use the  button to call up further information on the desired programme.

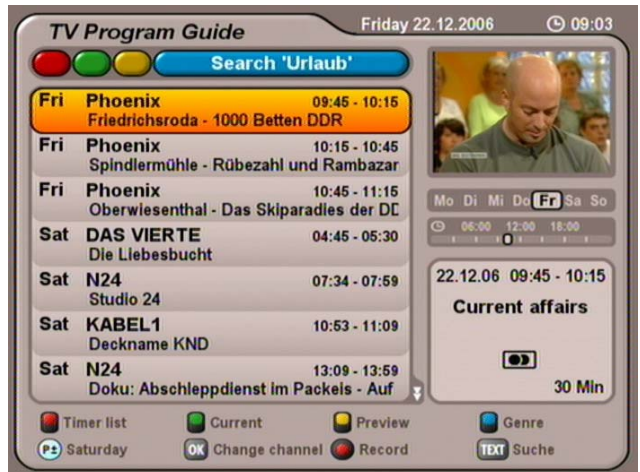

Using the  (red dot) button you can load the selected programme into the recording settings (see item "Recording").

EPG - ELECTRONIC PROGRAMME GUIDE

ADDITIONAL INFORMATION (i-BUTTON)

The additional information can always be called up by pressing the **i** button whenever the “i symbol” appears in front of the program name (see screenshot on the right). First however the channel must be selected. The following display appears (example):

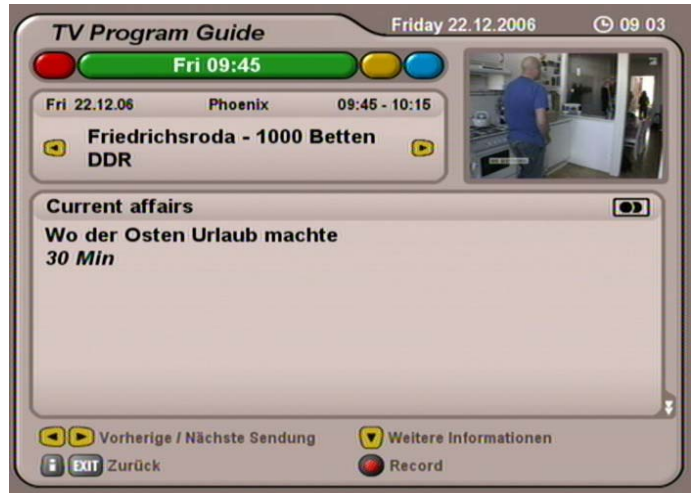

The additional information available for a programme is displayed in its own window. By pressing the **i** button, if available, you can call up further additional information on the selected programme.

The **◀▶** buttons enable you to display the additional information for the preceding or following programmes in the order of the previously selected list (see header). This always assumes that the data has been supplied by the channel provider.

Using the **●** (red dot) button you can load the selected programme into the recording settings (see item “Recording”).

Press the **i** or **EXIT** button to exit the additional information.

EPG - ELECTRONIC PROGRAMME GUIDE

REMINDER FUNCTION (CHANGE OVER TO PROGRAMME)

If you wish to be reminded at the start of a programme, you can activate the reminder function for the desired programme. The reminder function is set up in exactly the same way as programming a recording. The only difference is that in the "Target" line the entry must be "Reminder (just switch over)". Select the desired settings for your reminder (see "Recording (timer)" for the setting options) and then confirm the setting of

the reminder function by pressing the **OK** button. The programme is marked in the Programme Guide with a green dot and the receiver will automatically switch over to the pre-selected channel at the start of the programme.



RECORDING (TIMER)



When using the UFS 740sw on a CAP 900 turntable unit, please follow the timer programming instructions in the installation and operating manual supplied with the CAP 900.

The **●** (red dot) button allows you to set up a programme at any time for recording on an external recorder.

The programme to be recorded can be selected in any of the EPG views, provided the **●** (red dot) button appears at the bottom of the screen display.

Programme present in the EPG:

Select the desired programme and press the **●** (red dot) button. The following display appears (example):

Programme not present in the EPG:

Select any programme on the channel on which the desired programme is to be transmitted at a later time and press the **●** (red dot) button (starting and finishing times together with the recording date must be input manually). The following display appears (example):

EPG - ELECTRONIC PROGRAMME GUIDE

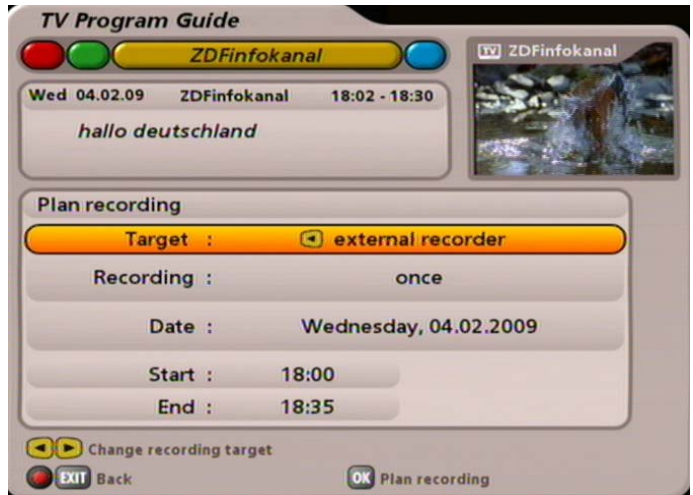
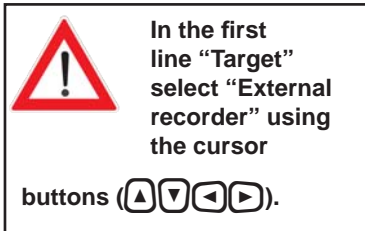

Use the (◀▶) buttons to select the desired recording mode. The recording mode options available are:

- **Once:** The recording will be performed once
- **Daily:** The recording will be performed daily at a time specified by you
- **Weekly:** The recording will be performed once a week on the same day and at the same time
- **User-defined:** The recording will be performed on days specified by you at times specified by you
- **Series recording:** The selected programme will be set up by the EPG for recording every time it is transmitted (may even be on different channels). This function does however require a daily update of the EPG data (the data are updated automatically when switching off into stand-by mode).

Use the cursor buttons (▲▼◀▶) to select the further items and use the keypad to complete the settings.

When all settings have been made, press the (OK) button to save the recording settings. You can view the scheduled recordings in the recording schedule view of the EPG (see item "Recording schedule").

RECORD ONCE

Use the (◀▶) buttons to select the recording mode "once" (see screenshot item "Recording (timer)").

Use the (▲▼) buttons to switch to the selection field "Date" and use the (◀▶) buttons to select the desired recording date.

Use the (▲▼) buttons to switch to the selection field "Start" and use the (◀▶) buttons to select the desired recording starting time.





Use the (▲▼) buttons to switch to the selection field "End" and use the (◀▶) buttons to select the desired recording finishing time.





When all settings have been made, press the (OK) button to save the recording settings. You can view the scheduled recording in the recording schedule view of the EPG (see item "Recording schedule").

EPG - ELECTRONIC PROGRAMME GUIDE

RECORD DAILY

Use the   buttons to select the recording mode “daily” (see screenshot below).

Use the   buttons to switch to the selection field “Start” and use the   buttons to select the desired recording starting time.

Use the   buttons to switch to the selection field “End” and use the   buttons to select the desired recording finishing time.



When all settings have been made, press the  button to save the recording settings. You can view the scheduled recording in the recording schedule view of the EPG (see item “Recording schedule”).





RECORD WEEKLY







Remember that the day of the week for the desired programme is loaded in the recording schedule and you can make no further manual corrections to it!

Therefore before pressing the  (red dot) button, select the programme on the day of the week that in future you will wish to make the weekly recording.

Use the   buttons to select the recording mode “weekly” (see screenshot below).

Use the   buttons to switch to the selection field “Start” and use the   buttons to select the desired recording starting time.

Use the   buttons to switch to the selection field “End” and use the   buttons to select the desired recording finishing time.

EPG - ELECTRONIC PROGRAMME GUIDE



When all settings have been made, press the **OK** button to save the recording settings. You can view the scheduled recording in the recording schedule view of the EPG (see item "Recording schedule").

RECORD USER-DEFINED

Use the **◀▶** buttons to select the recording mode "user-defined" (see screenshot below).

Use the **▲▼** buttons to switch to the selection field "Day" and use the **◀▶** buttons to select the desired recording day. Press the **OK** button to fix the selection (the day will be shown in red letters). If necessary the receiver will suggest some days to you; you can accept these suggestions or deactivate them again using the cursor buttons and pressing the **OK** button once.

Use the **▲▼** buttons to switch to the selection field "Start" and use the **◀▶** buttons to select the desired recording starting time.

Use the **▲▼** buttons to switch to the selection field "End" and use the **◀▶** buttons to select the desired recording finishing time.

EPG - ELECTRONIC PROGRAMME GUIDE

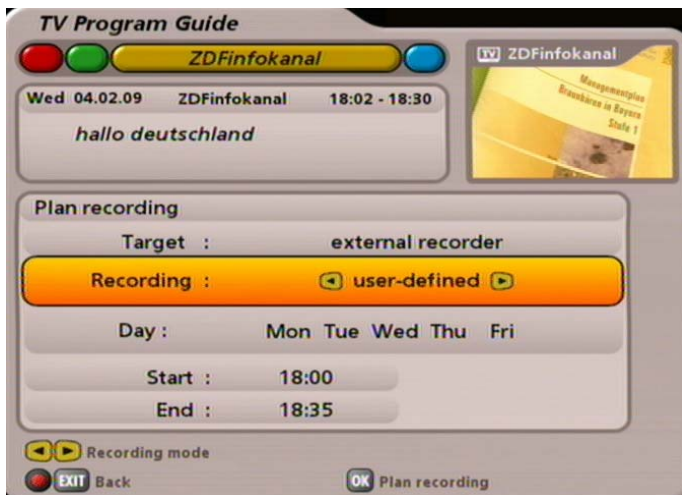

When all settings have been made, press the **OK** button to save the recording settings. You can view the scheduled recording in the recording schedule view of the EPG (see item "Recording schedule").

SERIES RECORDING



Series recording depends on the EPG data being kept up to date at all times. The receiver automatically updates the EPG data when the unit is switched off by pressing the **⏻** button. Updating is important because it enables the receiver to recognise for purposes of recording any changes to scheduled transmission times of the series, provided these were incorporated in the EPG data supplied by the channel provider in advance of the latest EPG update.

Use the **◀▶** buttons to select the recording mode "Series recording".

In series recording the start and finish of recording are taken automatically by the receiver from the EPG data. You can only specify a lead-in and run-out time to be sure to record the complete programme even if transmission times may vary slightly. The setting of lead-in and run-out time is done

using the **◀▶** buttons or the keypad.

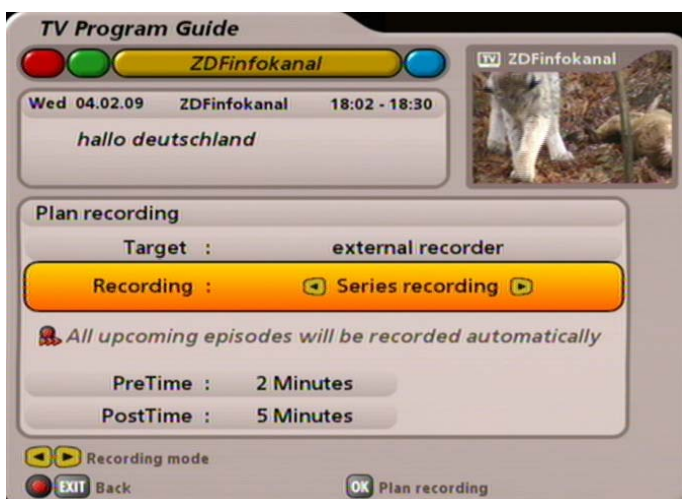

When all settings have been made, press the **OK** button to save the recording settings. You can view the scheduled recordings in the recording schedule view of the EPG (see item "Recording schedule").

EPG - ELECTRONIC PROGRAMME GUIDE



VIEW RECORDING SCHEDULE

The recording schedule view can be called up at any time in EPG by pressing the red  button.



The recording schedule view shows you all the recordings that are scheduled.

The  buttons allow the recordings to be sorted into “once-only recording” or “Repeating” recordings.

The cursor buttons () allow you to select a recording. The  button allows you to switch over the channels on which the recording is scheduled.

The  (red dot) button allows you to delete a recording that had been scheduled. If this is a series recording you will additionally be asked whether you wish to cancel the recording of only one episode or whether you wish to record no further episodes of this series (see screenshot). Selection is performed using

the  buttons and is confirmed using the  button.



The  button allows you to skip backwards and forwards through the future scheduled recordings, a day at a time.

COMMON INTERFACE

IMPORTANT INFORMATION

Always follow the operating instructions from your Pay-TV provider and the instructions supplied with the Smartcard and the CA module!

Smartcards and CA modules are not included with this product!

The cards and modules are issued by the respective Pay TV providers, and contain the subscriber data and details of the channels for which the subscriber has paid. These channels are always encrypted.

Contact the Pay TV provider if you are interested in subscribing to a particular Pay TV channel.

You are responsible for the use of the Smartcard in the CA!

The Smartcard sold by the Pay TV provider, specific to a particular encryption technology, is inserted into the CA module.

Store your card and PIN code securely when not in use!



INSERTING THE SMARTCARD AND THE CA MODULE

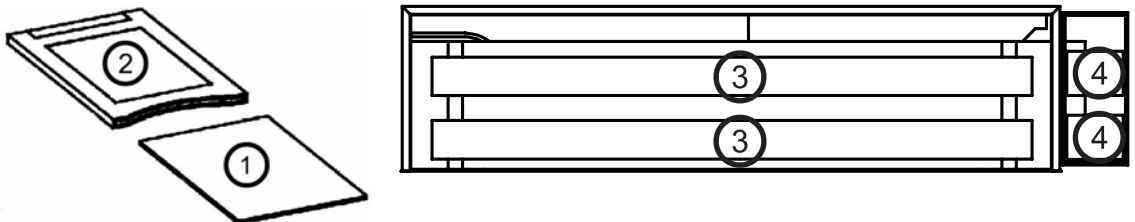

The Common Interface (CI) (3) on the UFS 740 is suitable for the use of two CA (Conditional Access) modules. These two CI slots are on the front right behind the display.

The CA module (2) receives Smartcard (1) (chip contacts pointing upwards and towards socket strip) and is then inserted into one of the two CI slots (3).

The Smartcard should be inserted into the CA module without exerting too much force. This also applies to inserting the CA module into the CI slot!

Do not force the card in; and follow the instructions supplied with the Smartcard and the CA module.

To remove the module, press the relevant eject button (4).

COMMON INTERFACE

You can find out which Conditional Access modules are in the CI slots on the UFS 740sw and which Smartcard is in which CA module from the “Mainmenu” under “Settings”, and the “Common Interface” menu.

Confirmation is by pressing the **OK** button.

Use the **▲▼** buttons to select one of the two slots in which the CA module is located (“Module inserted”) and then press the **OK** button. You will then see the menu generated by the CA module.

The screenshots below depend on the specific module and card, and so are only intended as examples:

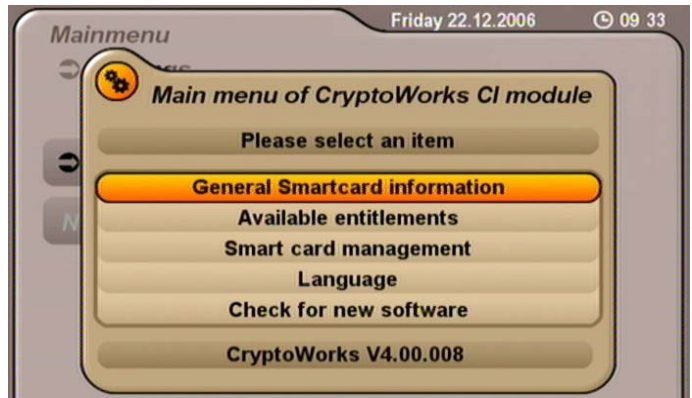

From this menu, your card and your PIN code allow you to access various channels from your Pay-TV provider.

“CryptoWorks” has been selected as an example here. The details can be different for each CA module. Always follow the instructions supplied by your Pay-TV provider!

Note: *The module displays may be shown in English, even if you have selected German as the menu language, because the menu is generated directly by the module!*



Information for Conax, SECA, Viaccess and CryptoWorks users:

Note that with monthly activation intervals, the channel providers have different procedures for activating Pay TV cards. Activation may therefore be a few days before or after the beginning of a new month. During this activation period, the CA module and card must be in the slot, and the receiver must be turned on a set to the booked Pay TV channel. Follow the instructions from the Pay TV provider.

If your Pay TV card is then still not enabled, we recommend you briefly withdraw the CA module with the card out of the slot, with the receiver switched on, and then re-insert it.

This information has nothing to do with the properties of the unit; it is merely intended to assist you.

The various items can be selected using the **▲▼** buttons and called up using the **OK** button. Press the **EXIT** button to exit the menu again.

VIDEOTEXT (TELETEXT)

This symbol  in the channel notification shows you whether Videotext/Teletext is available for the selected channel.







When you press the  button, the receiver processes the videotext/Teletext service data for your TV set to display, even when the signal is encrypted.





During the scan, the page which is being searched for is displayed in the top left-hand corner with the time and date displayed at the top right.



When the scan is finished, the videotext/Teletext being broadcast by the relevant encrypted provider appears:





You have several options for calling up the desired pages:

- Input with number pad
- Page-by-page using the   buttons
- Selection using the options indicated by the coloured buttons  (red),  (green),  (yellow) and  (blue)

By pressing the  button you can double the size of the displayed text. Pressing the  button once enlarges the upper part of the display, pressing  twice enlarges the lower part of the display (pressing the  button again returns the display to normal size).

Press the  or  button to exit videotext/Teletext.

EDIT CHANNEL LIST

Select the "Edit TV-Channellist" menu using the menu button , the   buttons on the main menu and .

Also pay attention to the bars at the bottom of the on-screen display! This provides hints on what to do next.







When the menu is called up, the standard setting is for the receiver to show the "All Satellites" channel list with all channels available on the satellites that are being received.











SELECTION OF THE LIST/CHANNELS TO BE EDITED

Press the  (blue) button to switch between the TV and radio channel lists. Radio channels are edited in the same way as TV channels.

Editing favourites lists is explained as a separate item.

Selection options:

-  (blue) button Switch between radio and TV channels
-  (green) button Call up satellite channel lists
-  (yellow) button Call up the channel lists, sorted alphabetically
-  button Search for a specific channel (input the search expression using the numeric pad on the remote control, see also the sections "Operating Instructions" "Alphanumeric Input")

The channel list chosen is generally that sorted by categories (satellites, favourites and alphabetic) using the   buttons (the standard list shown on calling up is the "All Satellites" channel list). Selection of channels in the list is performed using the cursor buttons (   ). The   buttons allow you to select individual channels, and the   buttons allow you to scroll from page to page of the currently selected list.

EDIT CHANNEL LIST



EDITING LISTS/CHANNELS



When you have selected the channel or channel list to be edited, press the  (red dot) button to call up the edit menu. You have the following edit options:



- **Move:**
Channel can be moved within the current list to another channel slot
- **Delete:**
Delete the channel from the current list
- **Skip:**
Channel will be skipped when zapping through the channels
- **Lock:**
Channel can be viewed only by inputting a PIN
- **To Favorite:**
Channel can be assigned to any favourites list
- **Start Blockselection:**
Several channels can be highlighted at the same time and edited together















As soon as you exit the menu under which you made the edit changes, you will be asked if you wish to save the changes. Use the   buttons to select either "Yes, save changes" or "No, discard changes". Confirm your selection with the  button.

EDIT CHANNEL LIST







“LAST FUNCTION” MEMORY

The last editing action performed is saved on the  button, so by pressing the  button for other channels you will repeat the action without having to all up the edit menu again. As soon as you leave the current display, this option lapses and becomes available again only after the edit menu has been called up and an action selected.

MOVE CHANNELS

Use the   buttons to select the channel to be moved from the current channel list (use the  (green) button to switch to the overall list, use the  (yellow) button to switch to the alphabetically sorted list). Press the  button to call up the edit menu and use the   buttons to select the “Move” function. Confirm the command by pressing the  button. The channel you previously selected will now be shown inset slightly from the left. Now use the cursor buttons (   ) or the keypad to select the new desired position for the channel, and confirm the new channel slot by pressing the  button.

DELETE CHANNELS







Use the   buttons to select the channel to be deleted from the current channel list. Press the  button to call up the edit menu and use the   buttons to select the “Delete” function. Confirm the command by pressing the  button.



A deleted channel can be rediscovered only by performed another channel scan (see section “Channel scan”)!

The channel you previously selected will be deleted (from the favourites lists also!).







SKIP CHANNELS

Use the   buttons to select the channel to be skipped from the current channel list. Press the  button to call up the edit menu and use the   buttons to select the “Skip” function. Confirm the command by pressing the  button.

The channel you previously selected is now shown in grey text. When zapping the channels this channel will in future be skipped and no longer shown in the channel list (called up using the  button). This function can be restored again using the edit menu (select: “Restore to zap list”).









EDIT CHANNEL LIST

BLOCK CHANNELS

Use the   buttons to select the channel to be blocked from the current channel list. Press the  button to call up the edit menu and use the   buttons to select the “Lock” function. Confirm the command by pressing the  button. you are now prompted to enter the PIN code (factory default setting: 0000).

The channel you previously selected is now shown with a padlock to its right. In future this channel can be viewed only by inputting the four-digit PIN code.
This function can be restored again using the edit menu (select: “Remove lock”).







COPY CHANNELS TO THE FAVOURITES LIST



Use the   buttons to select the channel to be copied from the current channel list. Press the  button to call up the edit menu and use the   buttons to select the “To Favorite” function. Use the   buttons to select the favourites list into which the channel is to be copied. The channel remains in the satellite channels list. Confirm the command by pressing the  button.

The channel you previously selected is now shown with an “F” and a yellow field in the channels list. The “F” shows that it is a favourite channel; the black dot in the yellow field shows in which of the eight favourites lists the channel can be found.

See the item “Editing favourites lists” for information on how to delete a channel from a favourites list.

START BLOCK HIGHLIGHTING (HIGHLIGHTING SEVERAL CHANNELS)

Use the   buttons to select the channel from which you want to highlight further channels. You can only select channels that are listed in succession in your selected channel list. Press the  button to call up the edit menu and use the   buttons to select the “Start Blockselection” function. Use the   buttons to highlight the desired channels, starting from the previously highlighted channel and working upwards or downwards. The highlighted channels will be highlighted in yellow and marked with a tick at the left side.

When you have highlighted the channels that you wish to select, press the  button to call up the edit menu once again and use the   buttons to select the desired function (“Move”, “Delete”, “Skip”, “Lock” or “To Favorite”).

The selected function can now be used in the same way as described for the respective items in this section for a single channel.

EDIT CHANNEL LIST

EDIT FAVOURITES LISTS



When you have selected the favourite list to be edited (called up using the ^{FAV} (red) button and selected using the buttons), press the (red dot) button to call up the edit menu. You have the following edit options:

- **Remove from the Favourites List:**
The channel will be removed from the Favourites List
- **Lock:**
Channel can be viewed only by inputting a PIN
- **Rename Favourites List:**
The Favourites List can be renamed
- **Start Blockselection:**
Several channels can be highlighted at the same time and edited together

REMOVE FROM THE FAVOURITES LIST



Use the buttons to select the channel to be removed from the Favourites List you have selected. Press the button to call up the edit menu and use the buttons to select the "Remove from Favourites List" function. Confirm the command by pressing the button.

The channel you previously selected is now removed from the Favourites List (but not deleted from the overall satellite list).

EDIT CHANNEL LIST

BLOCK CHANNELS

Use the   buttons to select the channel to be blocked in the Favourites List you have selected.

Press the  button to call up the edit menu and use the   buttons to select the “Lock” function.

Confirm the command by pressing the  button. you are now prompted to enter the PIN code (factory default setting: 0000).

The channel you previously selected is now shown with a padlock to its right. In future this channel can be viewed only by inputting the four-digit PIN code.

The channel is also blocked on all other channel lists. You need not additionally block the channel in the other channel lists.

This function can be restored again using the edit menu (select: “Remove lock”).



RENAME FAVOURITE LIST

Use the   buttons to select the Favourites List to be renamed. Press the  button to call



up the edit menu and use the   buttons to select the “Rename Favourites List” function. Confirm



the command by pressing the  button. A keypad will now be displayed with which you can enter the desired name alphanumerically using the numeric pad on the remote control. See also the section “Operating Instructions”, “Alphanumeric Input”.

START BLOCK HIGHLIGHTING (HIGHLIGHTING SEVERAL CHANNELS)

Use the   buttons to select the channel from which you want to highlight further channels. You can only select channels that are listed in succession in your selected Favourites List. Press the  button





to call up the edit menu and use the   buttons to select the “Start blockselection” function. Now use

the   buttons to highlight the desired channels, starting from the previously highlighted channel and working upwards or downwards. The highlighted channels will be highlighted in yellow and marked with a tick at the left side.

When you have highlighted the channels that you wish to select, press the  button to call up the edit menu once again and use the   buttons to select the desired function (“Remove from the Favourites List” or “Remove lock”).

The selected function can now be used in the same way as described for the respective items in this section for a single channel.

CHANNEL SEARCH (CHANNEL SCAN)

Select the "Search Channels" menu using the menu button , the   buttons on the main menu and the  button.



Also pay attention to the bars at the bottom of the on-screen display! This provides hints on what to do next.



You have three options for a channel scan:

- Automatic scan - all transponders for the satellite you selected will be scanned
- Manual scan - only the selected transponder for the satellite you selected will be scanned
- Channel scan with service ID - Search for a specific channel using its service ID

Select the scan type you want to rename using the   buttons and confirm with .



AUTOMATIC (CHANNEL) SCAN



The   buttons allow you to select different sets of parameters for the scan.



CHANNEL SEARCH (CHANNEL SCAN)

Satellite

Select the satellite to be scanned, using the   buttons. Make sure your reception system is aligned to the selected satellite. You can scan only one satellite at a time. If you have connected a multi-feed reception system (e.g. reception of ASTRA 19.2° East and HOTBIRD 13° East), you must repeat this procedure once for each satellite. You can however start the first installation again, in the course of which a channel scan of all the satellites you selected is performed.

Press the  button to move to the next selection item.



Channel scan mode

Use the   buttons to select whether you wish to scan “free & scrambled”, “only free” or “only scrambled” channels.





To view encrypted channels you need the appropriate CA (Conditional Access) module and a valid smart card together with a valid subscription to the respective Pay-TV provider.

Press the  button to move to the next selection item.

Network scan

Use the   buttons (On/Off) to select whether a network scan should be performed. If you set the network scan to “Off”, only the factory stored transponders of the satellites you previously selected will be scanned for new as yet unlisted channels.

If you set the network scan to “On”, the transponder network enables additional transponders that have not yet been stored to be located. They are then stored and scanned for new channels in the same way as the existing transponders.

When you have made your settings, use the   buttons to select “Start Search” and press the  button to start scanning. You can cancel the scan at any time by pressing the  button. During the scan you will see the following message (example):

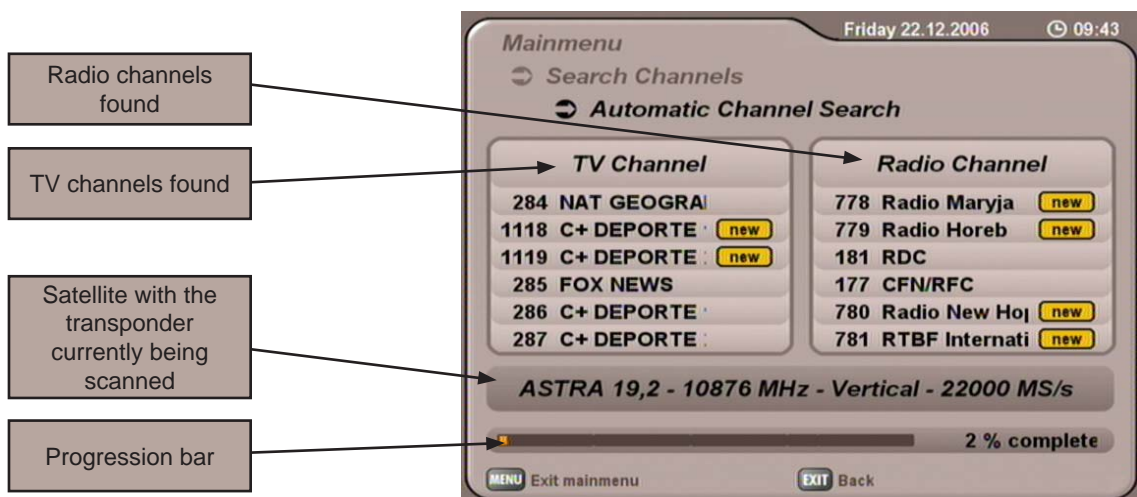

CHANNEL SEARCH (CHANNEL SCAN)

Newly found channels are identified with the designation “New” after the channel name. After completion of the scan, you will see the following message (example):



Press the **OK** button. You will be asked whether you wish to save the changes or not. Selection is performed using the **▲▼** buttons and is confirmed using the **OK** button. If you select “Yes, save changes”, the newly found channels will be added to the end of the channel list. Then press the **EXIT** button to exit the menu. The channel list is called up on to the TV screen by pressing the **OK** button (see also section “On-screen displays” “Channel list TV/Radio”).





After a scan (of whatever type) the receiver shows all newly found channels in the channel list under the rubric “New Channels”. You will find this rubric in the Channel List at the end of the green satellite channel lists (selection using the **◀▶** buttons).



MANUAL (CHANNEL) SCAN



CHANNEL SEARCH (CHANNEL SCAN)



The   buttons allow you to select different sets of parameters for the scan.

Satellite



Use the   buttons to select the satellite on which the transponder you wish to scan is located. Make sure your reception system is aligned to the selected satellite. You can scan only one transponder at a time. If you wish to scan several transponders on a satellite, you should start an automatic scan of the transmitting satellite.

Press the  button to move to the next selection item.

Transponder frequency

Select the transponder to be scanned, using the   buttons or the keypad. At the bottom right of the screen display, the receiver shows the current signal strength and signal quality of the selected transponder. Press the  button to move to the next selection item.



Channel scan mode

Use the   buttons to select whether you wish to scan “free & scrambled”, “only free” or “only scrambled” channels.



To view encrypted channels you need the appropriate CA (Conditional Access) module and a valid smart card together with a valid subscription to the respective Pay-TV provider.

Press the  button to move to the next selection item.

Network scan

Use the   buttons (On/Off) to select whether a network scan should be performed. If you set the network scan to “Off”, only the factory stored transponders of the satellites you previously selected will be scanned for new as yet unlisted channels.

If you set the network scan to “On”, the transponder network enables additional transponders that have not yet been stored to be located. They are then stored and scanned for new channels in the same way as the existing transponders.

When you have made your settings, use the   buttons to select “Start Search” and press the  button to start scanning. You can cancel the scan at any time by pressing the  button.

During the scan you will see a display that shows you the progress of the scan and the channels found so far. Newly found channels are identified with the designation “New” after the channel name.

After completion of the scan, you will see the following message (example):

CHANNEL SEARCH (CHANNEL SCAN)



Press the **OK** button. You will be asked whether you wish to save the changes or not. Selection is performed using the **▲▼** buttons and is confirmed using the **OK** button. If you select "Yes, save changes", the newly found channels will be added to the end of the channel list. Then press the **EXIT** button to exit the menu.

The channel list is called up on to the TV screen by pressing the **OK** button (see also section "On-screen displays" "Channel list TV/Radio").

CHANNEL SCAN WITH SERVICE ID



The **◀▶** buttons allow you to select different sets of parameters for the scan.



Satellite

Use the **◀▶** buttons to select the satellite that is transmitting the channels to be scanned. Make sure your reception system is aligned to the selected satellite.

CHANNEL SEARCH (CHANNEL SCAN)



Press the  button to move to the next selection item.





Transponder frequency

Use the   buttons or the keypad to select the transponder frequency on which the channel being sought is transmitted. At the bottom right of the screen display, the receiver shows the current signal strength and signal quality of the selected transponder.

Press the  button to move to the next selection item.

Service ID





Using the   buttons or the keypad, enter here the service ID of the channel being sought.

When you have made your settings, use the   buttons to select "Start Search" and press the  button to start scanning. You can cancel the scan at any time by pressing the  button.

During the scan you will see a display that shows you the progress of the scan.





After completion of the scan, you will see the following message (example):



Press the  button. You will be asked whether you wish to save the changes or not. Selection is performed using the   buttons and is confirmed using the  button. If you select "Yes, save changes", the newly found channels will be added to the end of the channel list. Then press the  button to exit the menu.

The channel list is called up on to the TV screen by pressing the  button (see also section "On-screen displays" "Channel list TV/Radio").

PARENTAL CONTROL



Select the "Parental Control" menu using the menu button , the   buttons on the main menu and . You are now prompted to enter the PIN code (factory default setting: 0000). After entering the PIN using the keypad you are shown the following display:





Also pay attention to the bars at the bottom of the on-screen display! This provides hints on what to do next.

Select the parameters to be changed using the   buttons.

BLOCKING THE MAIN MENU



Use the   buttons (On/Off) to select whether the main menu should be blocked. If the menu is blocked, changes can be made only by entering the four-digit PIN code.

BLOCKING THE RECEIVER

Use the   buttons (On/Off) to select whether the receiver should be blocked. If the receiver is blocked, it can be operated only by entering the four-digit PIN code after it is switched on (factory setting: 0000).

Press the  button to exit the menu again.

SETTING A NEW CODE (PIN)

Press  to replace the old PIN with a new one. Enter the new (four-digit) PIN. For security you must repeat the new PIN code once again. Confirm the change of PIN code by pressing the .



**Keep your password in a safe place, so that you always have access to your channels even if you might have forgotten it.
If you have forgotten your password, you must contact your dealer, who will be able to unlock your receiver for you.**

SETTINGS

The selected menus, sub-menus and positions, as well as the parameters to be set, are each highlighted in colour. The menus are self-explanatory to a great extent.

Pay attention to the bar at the bottom of the on-screen display! This provides hints on what to do next.



Select the "Settings" menu using the menu button **MENU**, the **▲▼** buttons on the main menu and **OK**.



Press **OK** to access the "TV, Video and Audio" menu. The following display appears (see next page):

Use the **▲▼** buttons to select the further options. If there is another sub-menu layer, press the **OK** button to open it. If there are no more sub-menus, make the settings using the **◀▶▲▼** or number pad.

Press the **EXIT** button to save your settings and return to the previous menu. Press the **MENU** button to return directly to the TV picture, the changes will also be saved.

SETTINGS

TV SETTINGS



TV TYPE

Here you can use the buttons to select the picture format for your TV. Either

4:3 or
16:9 format.

DISPLAY FORMAT

Use the buttons here to select the type of screen display:

- Pan & Scan
- Letterbox
- Automatic (only if the "16:9" TV format was selected)
- Always 16:9 (only if the "16:9" TV format was selected)



TV SCART SIGNAL OUTPUT

Here you can use the buttons to select the type of video signal at the TV Scart socket. Select the signal that your TV set can process. **When doing this, refer to the operating instructions for your TV set!**

- Composite baseband signal
(colour/picture/blanking/synchronous signal)
- RGB – Red/Green/Blue signal or
- Y/C – S-Video signal (luminance/chrominance)

SETTINGS

VCR SCART SIGNAL OUTPUT

Here you can use the   buttons to select the type of video signal at the VCR Scart socket. Select the signal that your external recorder can process. **When doing this, refer to the operating instructions for your recorder!**



- Composite baseband signal (colour/picture/blanking/synchronous signal)
- Y/C – S-Video signal (luminance/chrominance)

TV STANDARD



Here, you can use the   buttons to specify whether your TV set is a

- PAL or
- NTSC set.

AUTOM. DOLBY DIGITAL OUTPUT

Here you can use the   buttons to select whether the receiver should automatically output the Dolby Digital signal (if this is transmitted).

AUDIO DELAY

Here you can use the   buttons to set a delay in milliseconds, if the sound output from your receiver is out of synch with the TV picture (lip synchronicity). The delay can be set in 10 millisecond steps from 10 ms up to 200 ms.



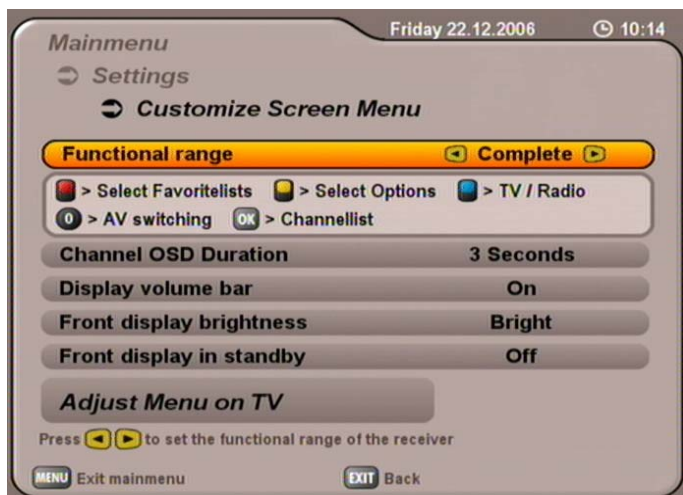

CONFIGURING THE ON-SCREEN MENU





SETTINGS

FUNCTIONAL SCOPE



Here you can configure the functional scope of your receiver. You can choose between “High”, “Normal” and “Low”. The following table shows which functions are available at each configuration step.

	FAV  (red) button	OPT  (yellow) button	TV/R  (blue) button	 button	 button
High	Select favourites	Select options	TV/Radio	AV changeover	Channel list
Low	Not assigned	Not assigned	Not assigned	Not assigned	Programme Guide
Normal	Select favourites	Select options	TV/Radio	Not assigned	Programme Guide



DISPLAY DURATION OF CHANNEL MESSAGE

Use the   buttons to select the time after which you want the on-screen channel message display to be automatically cancelled. The selections available are “Off”, 1, 2, 3, 4, 5 or 6 seconds.



DISPLAY VOLUME BAR

Use the   buttons (On/Off) to specify whether the volume bar is displayed when adjusting the volume.

RECEIVER FRONT DISPLAY BRIGHTNESS





Use the   buttons to set the brightness of the receiver front display. Select the most comfortable setting for the ambient lighting.

RECEIVER FRONT DISPLAY IN STANDBY

Use the   buttons to set whether the receiver front display should be switched on or off in stand-by mode (display of time).

OSD POSITION ALIGNMENT

Press the  button to align the on-screen displays on the TV screen. Now you can use the cursor buttons

(   ) to determine the position of the on-screen display. When you have achieved the desired position, press the

 button to fix the selected position.



SETTINGS

DATE AND TIME



Set Local Time

Use the [left] [right] buttons to set the time zone variation from UTC (formerly GMT) (e.g. for Germany +1 hour).

Use the [up] [down] buttons to switch to the "Automatic clock change" field.

Automatic time setting

Use the [left] [right] buttons to select whether the receiver should automatically change over to and from summer and winter time. If "On" is selected, the receiver automatically sets itself to the right time. If "Off" is selected, the field for manual selection of summer and winter time is displayed below.

Use the [left] [right] buttons to perform the setting.

Press the [EXIT] button to exit the menu again.

COMMON INTERFACE

See "Common Interface" section

ANTENNA CONFIGURATION

See "First Installation" section, pages 15ff

SERVICE MENU

Select the "Service" menu using the menu button **MENU**, the **▲▼** buttons on the main menu and **OK**. The following display appears:

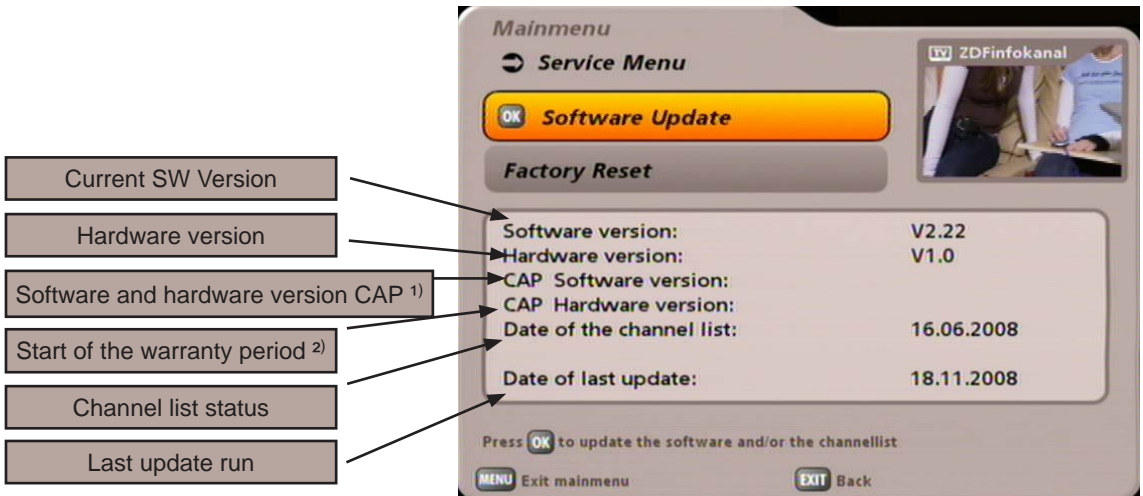

UPDATING SOFTWARE

The receiver checks in standby mode whether a new software version is available and, if it is, displays the following message the next time the receiver is started up:



Use the **▲▼** buttons to select from the displayed options and press **OK** to confirm your selection:

- **"Load in standby"**: When the receiver is switched to "Standby" mode the new software is loaded
- **"Remind later"**: The message reappears the next time the receiver is started up
- **"Don't load"**: The software is not loaded and the download must be launched manually.

To load the software manually:

Use the **▲▼** buttons to switch to "Software Update" and to call it up press the **OK** button. The following display appears (next page):

¹⁾ Displayed only if the UFS 740 is operated with a CAP unit (Kathrein turntable unit)

SERVICE MENU

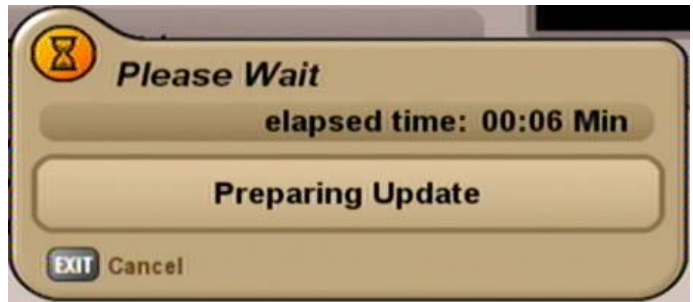

Also pay attention to the bars at the bottom of the on-screen display! Messages here provide information on what to do next.

UPDATE Software

Use the buttons (No/Yes) to select whether you wish to load the new software that is available. If you are unsure whether you wish to load the new software, you can initially set the reply to "No". If you do agree to the changes, you can then proceed to download the software.

Channel list

Select the required satellite using the buttons. Available options:

- **"only update"**: Your existing list will only be updated, any new channels found will be added at the end of the channel list. The sort sequence of your channel list remains unchanged; the only change is that the channel data (transmission frequency etc.) are updated
- **"do not load"**: Your existing list will not be edited (nor updated nor overwritten)
- **"overwrite"**: Your existing channel list will be completely superseded by a new list of available channels. Your personal channel sorting will be lost. If you select "overwrite", you will additionally see displayed the line "pre-sorted for". Use the buttons to switch to this line and use the buttons to select the desired pre-sorting. Your available options are: Germany, Austria and Switzerland.

SERVICE MENU

When you have made your settings, use the **▲▼** buttons to select “Start Update” and press the **OK** button to start updating.

The following display appears:

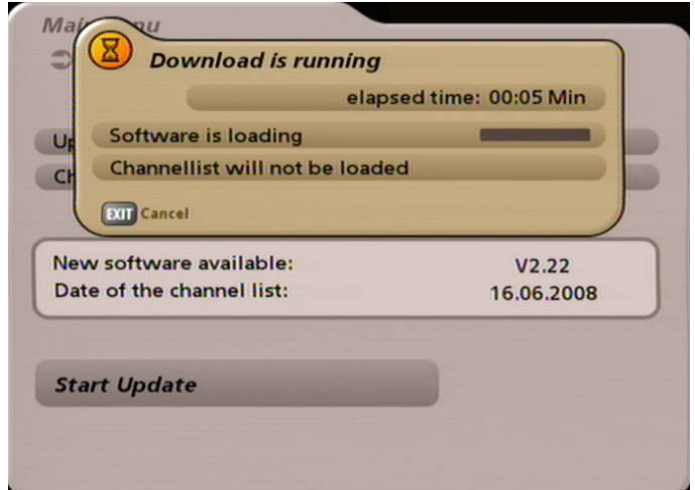

FACTORY DEFAULT

You can select the “Service” menu using the **MENU** menu button, the **▲▼** buttons in the main menu and **OK**. Use the **▲▼** buttons to switch to “Load factory default settings” and to call them up, press the **OK** button. The following display appears:

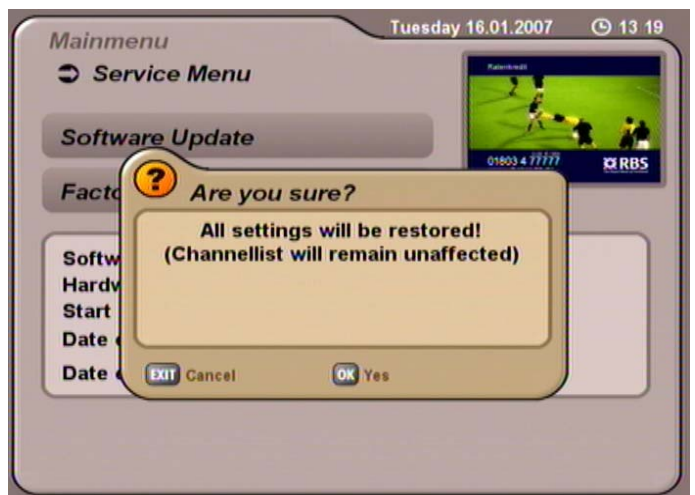

Press the **OK** button to load the factory default settings. The channels and favourites lists remain unchanged.

CONNECTING UP THE VIDEO/PVR

For details of how to connect your external recorder to the receiver refer to the connection diagram provided at the end of this manual and the instructions for the external recorder.

RECORDING

In order to make a PVR recording (Record), the satellite receiver must be switched on or the timers must be pre-programmed (see "EPG" "Recording (timer)" section).

PLAYBACK

For VCR/PVR playback you must have previously set the UFS 740sw Scart socket to "VCR mode"

(Scart changeover), using the **OK** button, so that the signal path is set up from the VCR or PVR/AUX Scart socket to the TV Scart socket.

In this setting, the picture from the external recorder is switched through to the TV set during playback.

Pressing the **OK** button again restores priority to the UFS 740sw "Scart → Sat" signal. In the setting "Scart → TV" (TV mode) the internal tuner of the TV set has priority and you cannot then see the signal from the receiver on the screen if you switch the TV set to the AV channel.

The settings "VCR mode" and "TV mode" are shown in the display on the receiver.

USING THE FRONT PANEL

If you have misplaced your remote control, or if the batteries are empty, you can still operate your receiver from the front panel.

BACKUP OPERATION

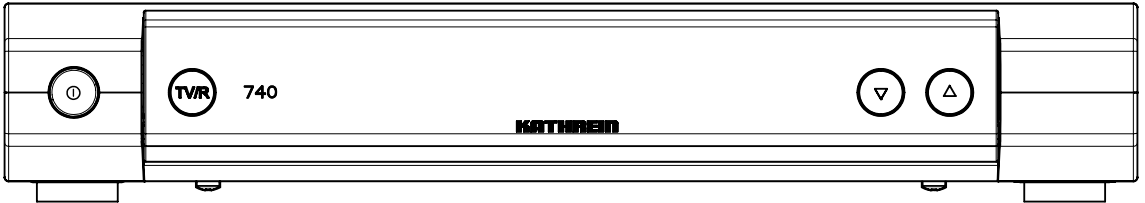

There are three buttons on the front of the receiver.

TV/R button:

Pressing the TV/R button switches the receiver from TV mode to radio mode. Pressing the TV/R button a second time switches the receiver from radio mode back into TV mode.

▼ button:

The channel down button switches to the next channel down in the currently selected channel list.

▲ button:

The channel up button switches to the next channel up in the currently selected channel list.



Because there are no number buttons, no password/PIN-protected functions can be displayed.

TECHNICAL APPENDIX

FEATURES

- Reception of digital TV and radio satellite programmes
- 4,000 channel memory positions
- 16-character alphanumeric display with status icons for indication of channel names and transmitter information
- Common interface for two CA modules ¹⁾
- Kathrein Convenience EPG with timer programming ²⁾
- Guided first installation with country setting
- Pre-programmed channel list
- 31 satellites pre-programmed
- 12V power supply for mobile use
- 230V power supply for stationary use
- Mounting accessories for flat or suspended mounting
- Antenna level indication via TV set (optical and acoustic) for the manual alignment of a satellite antenna (Sat finder)
- Suitable for software download via satellite and PC
- 8 favourite channel lists for TV and 8 for radio
- Automatic date and time generation via DVB data stream
- On-screen display (OSD) in 8 languages (D, GB, F, I, E, CZ, L, TR)
- 1000 timers (series and interval timers)
- Language selection for multilingual broadcasts
- Optical and electrical audio output for Dolby Digital data stream (AC 3)
- Composite colour, Y/C and RGB signal output programmable via the Scart socket
- Cinch sockets for AV signal
- Videotext decoder with 800 page memory capacity and videotext generation
- Automatic 4:3 and 16:9 format recognition (choice of viewing format)
- Channel search
- Programme position sort function
- DiSEqC™1.0, CAP command set and SCR single-cable system control signals
- Integrated electronic reverse polarity protection
- Infrared remote control with command set switching
- On/Off switch (disconnection from the 12 V supply)
- External infrared sensor, allows receiver to be hidden (included with the receiver)

¹⁾ CA module is not included in the delivery scope

²⁾ Display of information only if broadcast by the programme provider

TECHNICAL APPENDIX

Type		UFS 740sw
Order no./colour		20210087/black
RF properties		
Input frequency range	MHz	950-2150
Input level range	dB μ V	44-83
Reception threshold (EB/NO)	dB	< 4.5
TV system, video		
Modulation, FEC, demultiplexer		DVB-S standard
Video resolution		CCIR 601 (720 x 576 lines)
Input data rate	MSymb/s	2-45
Video decryption		MPEG-1 and -2 compatible
Bit rate	MBit/s	1.5-15
Frequency range	MHz	0.02-5
Output voltage	V _{pp}	1
S/N	dB	> 53
TV system, audio		
Audio decoding		MPEG-1 and -2, layer 1 and 2
Sampling rate	kHz	32/44.1/48
Frequency range	kHz	0.04-20
Output voltage	mV _{pp}	Type 770
S/N	dB	> 65
Memory		
Flash-RAM/SDRAM	MB	8/32
Processor clock speed	MHz	221
Power Supply		
Mains voltage (external power supply)	V _{AC} /Hz	230 (\pm 15 %)/50
DC	V _{DC}	12
Power consumption (power/standby)	W	< 26/< 2.5
LNB supply vert./horiz.	V/mA	14/18/Max. 350
control signal	kHz	22; DiSEqC™1.0; CAP command set; SCR single-cable system
Connections		
Sat-IF input/output (loop-through)		2 x F sockets
TV/VCR output		2 x Scart socket
Video output		Cinch socket
Audio output (analogue)		2 x Cinch socket
Audio digital output electrical/optical		Cinch socket/standard fibre-optic (SPDIF)
Data interface		RJ 11 socket
Common Interface		2
General Information		
Permissible ambient temperature	°C	+5 to +40
Unit dimensions/weight	mm/kg	280 x 45 x 185/< 2

TECHNICAL APPENDIX

SCART SOCKET ASSIGNMENT

Signal	Pin no.	TV	VCR/AUX
Right audio output	1	X	X
Right audio input	2		X
Left audio output	3	X	X
Audio earth	4	X	X
Blue earth	5	X	X
Audio left input	6		X
Blue signal	7	X	X
Switching voltage	8	X	X
Green earth	9	X	X
Data signal	10		
Green signal	11	X	X
Data signal	12		
Red earth	13	X	X
Data earth	14		
Red signal (C)	15	X	X
Blanking signal	16	X	X
Video earth	17	X	X
Blanking signal earth	18	X	X
Video output (FBAS/Y)	19	X	X
Video input	20		X
Connector shield	21	X	X

VHS/S-VHS SWITCHING

The Scart sockets are switchable between VHS and S-VHS. The switch is made by selecting "Mainmenu", "Settings", "TV, Video and Audio".

VHS (RGB): The red signal is connected to terminal 15, the composite colour output to terminal 19.
For S-VHS (C/Y): The Y output is connected to pin 19, the C output to pin 15.

TECHNICAL APPENDIX

CONNECTION EXAMPLE

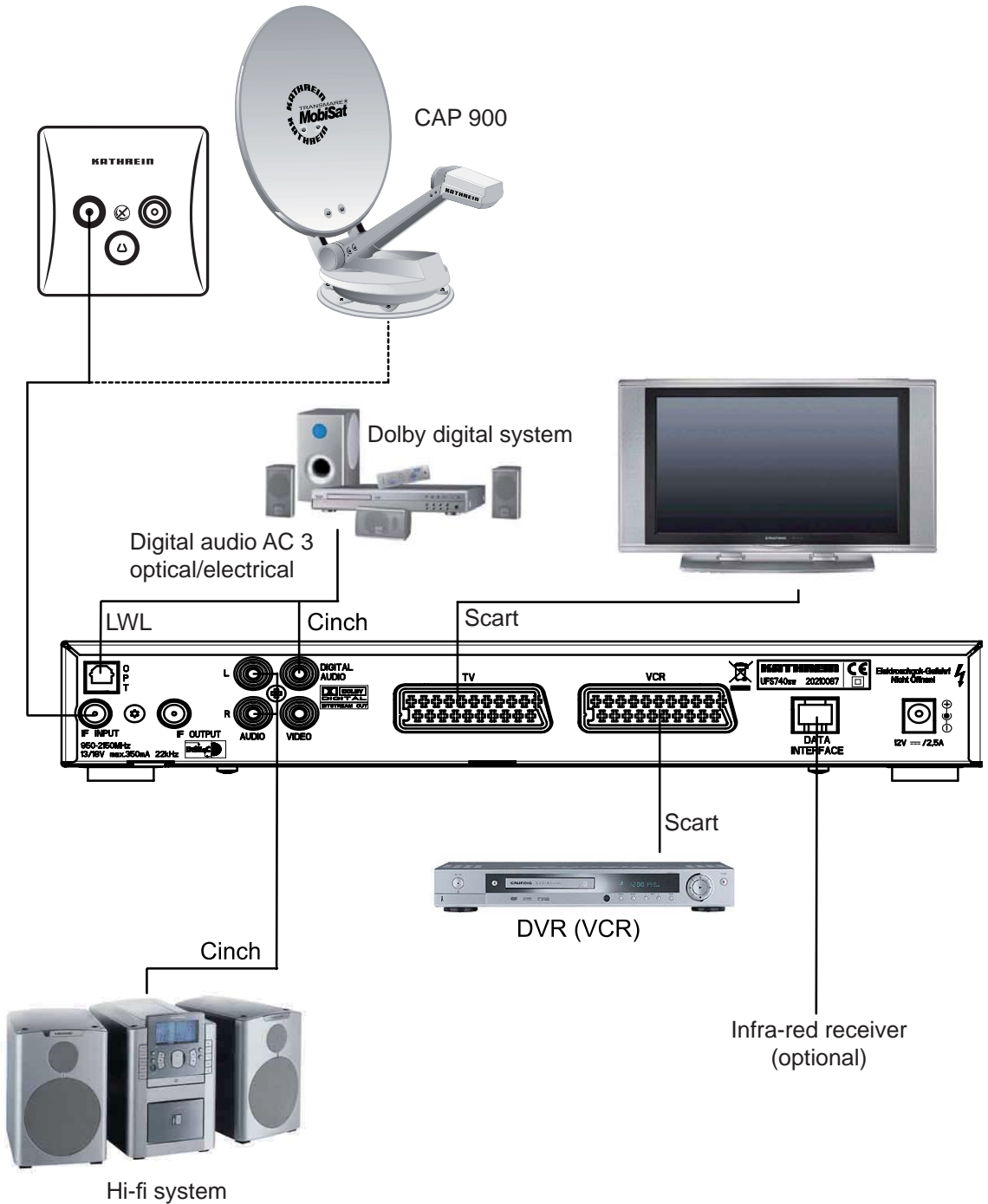

TECHNICAL APPENDIX

EXAMPLES single-cable systems

EXR 501/551/552

Single-cable switching matrices

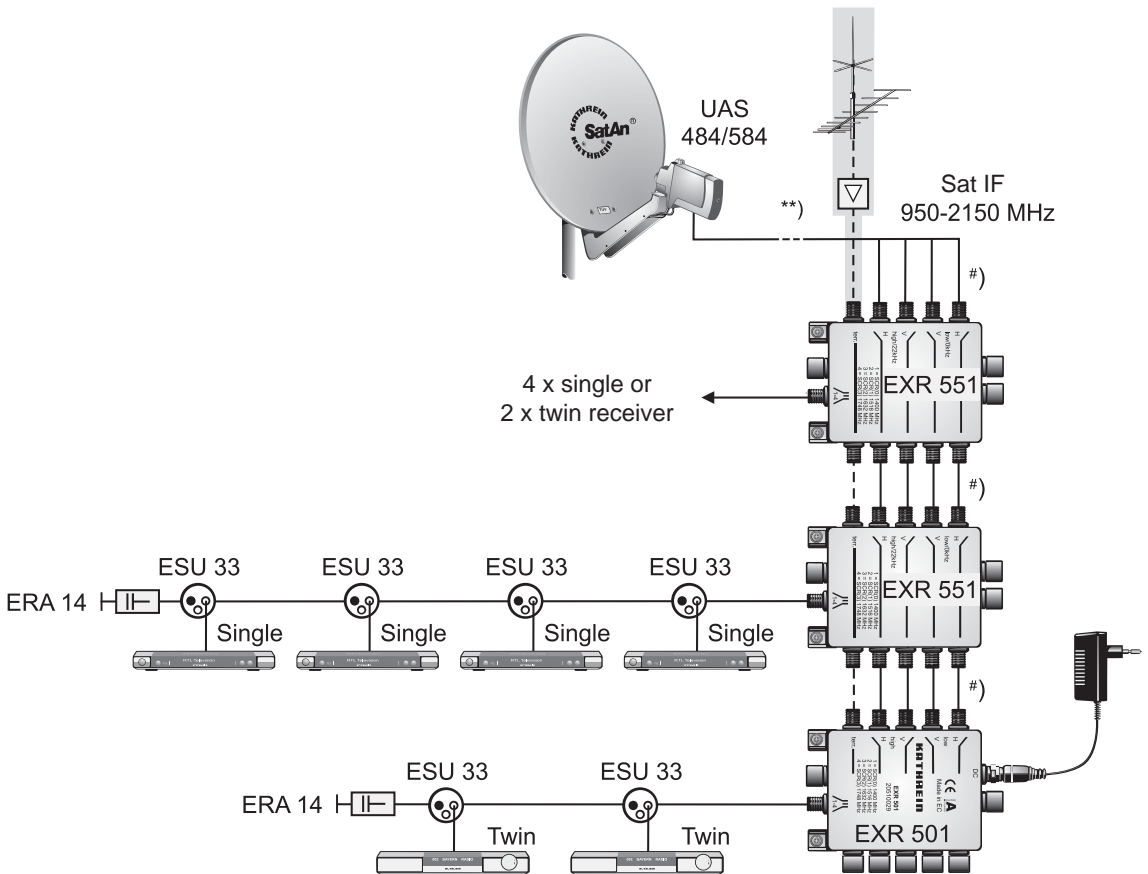

*) The receiver must be programmed for single-cable commands

**) Overvoltage protection KAZ 11/KAZ 12

EXU 908

Single-cable matrix

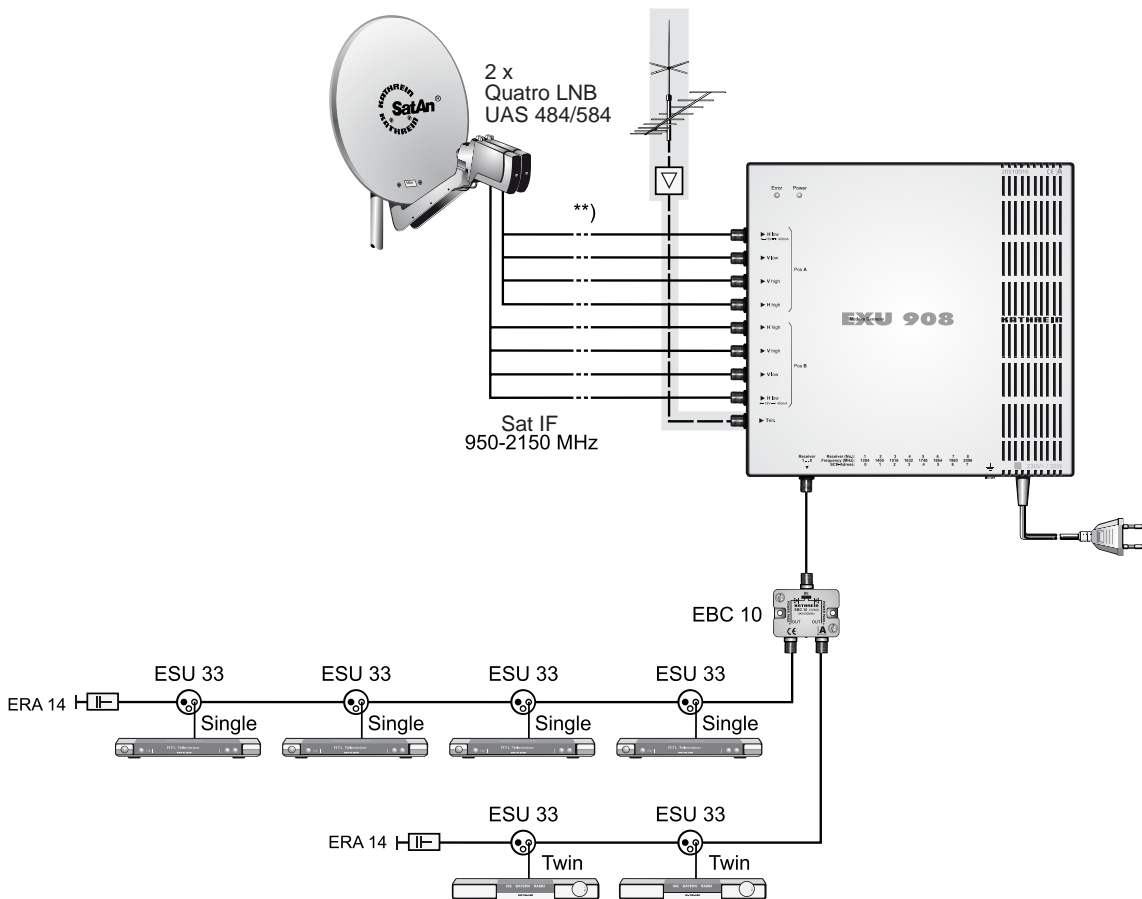

*) The receiver must be programmed for single-cable commands

**) Overvoltage protection KAZ 11/KAZ 12

UAS 481

Single-cable feed system

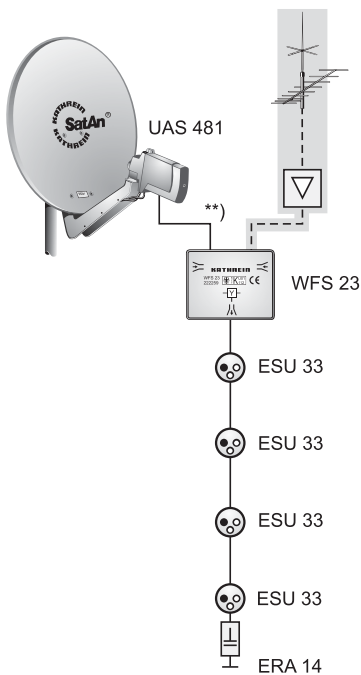
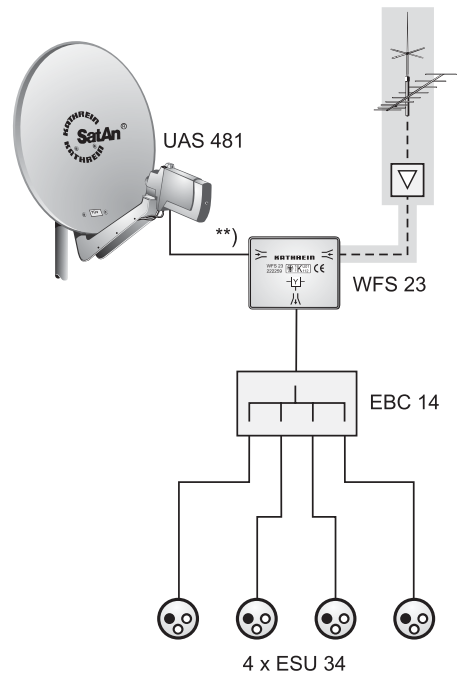
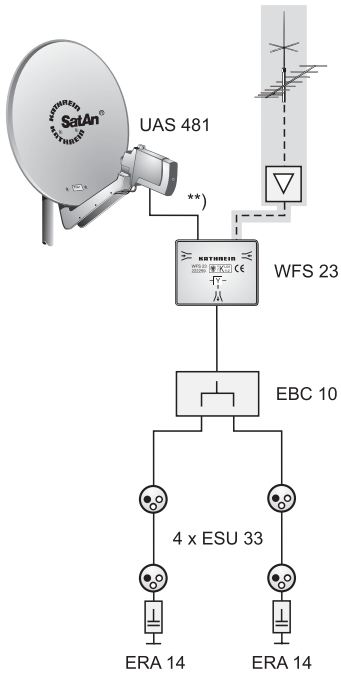

- *) The receiver must be programmed for single-cable commands
- **) Overvoltage protection KAZ 11/KAZ 12

EXR 1581/2581

Single-cable matrices

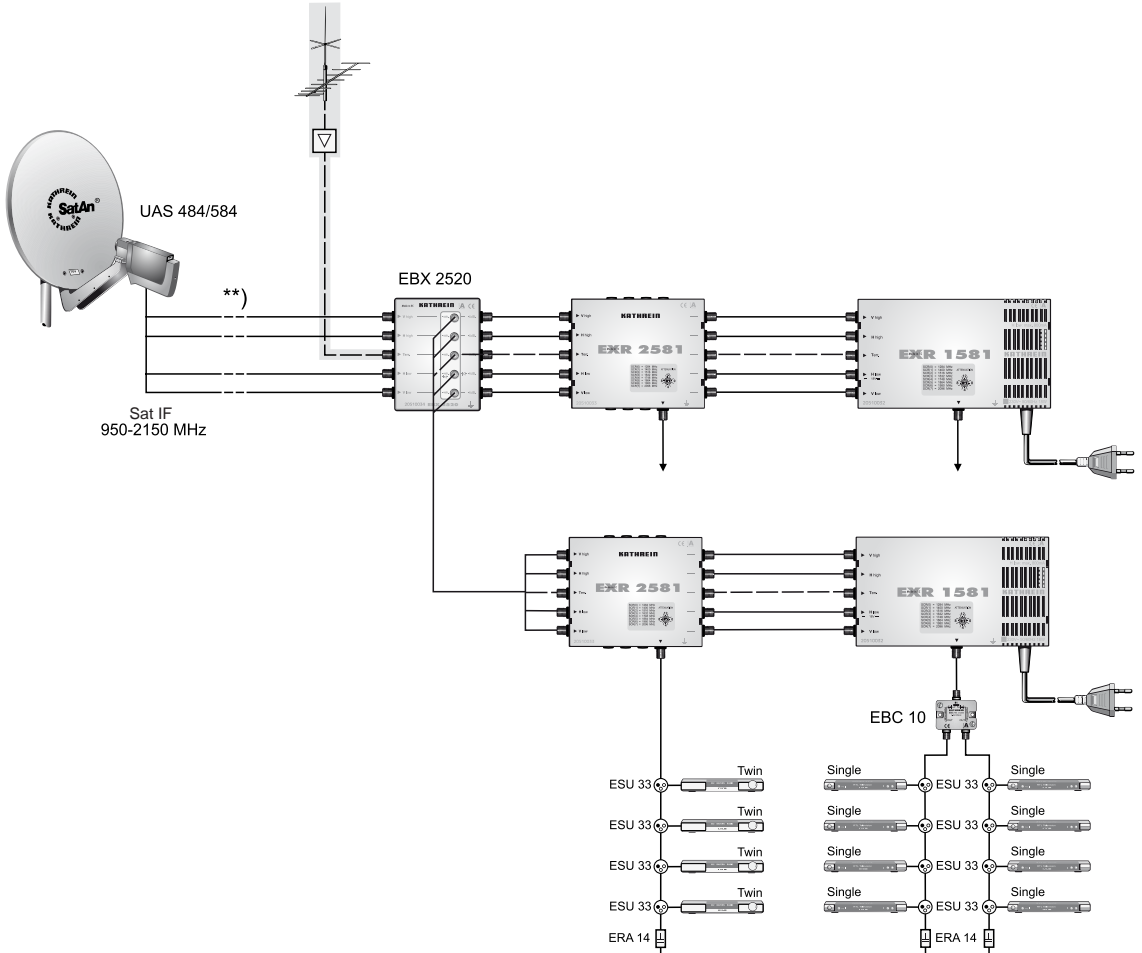

*) The receiver must be programmed for single-cable commands

***) Overvoltage protection KAZ 11/KAZ 12

SHORT TECHNICAL GUIDE

CHANNEL PACKAGE

The channel package for a digital transponder normally includes several TV and radio channels. Each channel package has a fixed assignment for the transponder transmission frequency, for polarisation (horizontal or vertical), for the symbol rate and for the Viterbi rate or error rate.

DISEQC™

DiSEqC™ (Digital Satellite Equipment Control) is a communication system between a satellite receiver (master) and the peripheral satellite components (slaves), such as LNBs, multi-switches, rotating antenna systems.

It is a single master/multi-slave system, i.e. there is only ever one master in the satellite system. All activities start from the master.

DISEQC™ COMPONENTS

If DiSEqC™ switching matrices are cascaded, the master receiver must transmit the DiSEqC™ signal several times, so that all DiSEqC™ multi-switches in the cascade receive their commands.

These days, DiSEqC™ components (slaves) must be reverse compatible, i.e. respond to the analogue switching criteria from receivers that are only equipped with H/V and 22 kHz control signals.

A DiSEqC™ switching matrix will work with analogue switching criteria until the DiSEqC™ command from the master is received. All analogue switching criteria are then ignored.

DVB MPEG-2

DVB is the abbreviation for Digital Video Broadcasting. DVB-S refers to the transmission method (S = satellite). MPEG is the abbreviation for Moving Picture Experts Group, a working group that formulates internationally applicable standards for the digital compression of video and audio. MPEG-2 has established itself as the standard for compression of digital TV signals. MPEG-2 works up to a data rate of 100 Mbit/s.

EB/NO RATIO

The E_b/N_0 ratio is a measure of the signal to noise ratio of a digital signal. The value is not identical to the C/N value familiar from analogue reception technology. At E_b/N_0 values below 5 dB no reception is normally possible.

FEC

FEC is the abbreviation for Forward Error Correction. The FEC error rate corresponds to the Viterbi rate.

SHORT TECHNICAL GUIDE

PID

The PID (Packet IDentification) number is an identification number for video signals and audio signals in the digital data stream of DVB-MPEG-2 signals. The receiver uses the PID number to create a unique assignment for the video and audio data transmission. The PCR PID is the identification number for the synchronisation signal. The PCR PID is normally identical to the video PID. For programmes broadcast in multiple languages, the audio PD can be entered manually to assign a different language to the TV programme. After the PID is entered, the digital receiver automatically selects the audio data identified by the PID number from the data stream and assigns it to the video signal.

SYMBOL RATE

The symbol rate describes the quantity of data that is transmitted per second. The symbol rate is measured in MSymbols/s and is equal to the number of symbols received per second.

TRANSPONDER

A transponder is a satellite channel which transmits TV and radio signals. A satellite has several transponders.

Analogue transponders transmit only one TV channel and possibly multiple radio channels on the transmission frequency.

Digital transponders simultaneously transmit several TV and several radio programmes at a transmission frequency. If a channel provider is broadcasting several TV channels via a digital transponder, we refer to this as the provider's channel package. The terms "digital transponder" and "channel package" have the same meaning.

VIDEO-BIT-RATE

The video bit rate describes the quantity of data from the digitised video signal that is transmitted per second.

VITERBI RATE

The Viterbi rate (code rate, error rate) characterises the error protection used by the programme provider. The DVB standard provides the following values: 1/2 - 2/3 - 3/4 - 5/6 - 7/8

SHORT TECHNICAL GUIDE

GLOSSARY

AC 3	Output for Dolby Digital signal
Audio output	Sound output on the receiver
AV programme pos.	Preferred programme position on TV set for Scart input
CA	Conditional Access (for decoding of encrypted programmes)
CI	Internationally standardised interface for CA modules
Decoder	Decoder for Pay TV
DiSEqC™	Control system between receiver and LNB, multi-switch
DVB	Digital Video Broadcasting
Eb/No [dB]	Power density per unit of information
Eb/No ratio	Digital signal to noise ratio
LED display	Display on receiver
LNB	Low Noise Block Converter
Mute	Muting of sound
OSD	On Screen Display
PAL	Analogue TV standard
Pay TV	Television channels available on subscription (e.g. PREMIERE)
PCMCIA	Standard for internal decoder interface for pay TV
PID	See "Short technical guide"
PIN	Personal Identification Number
Receiver	Satellite receiver
RGB	Video signal made up of three individual colour signals (red, green, blue)
Satellite IF signal	Receiver input signal
Scart cable	21-pin connecting cable (e.g. receiver/TV)
Smartcard	Card from Pay TV provider to decode its channels
Stand-by	Standby mode
S-VHS	Super Video Home System (video recorder standard)
Symbol rate	Rate of data transmission of satellite signal
Time-shift function	Time-shifted playback
Timer function	Clock function for pre-programmed switch on and off times
Transponder	See "Short technical guide"
UFO®<i>micro</i> and UFO®<i>mini</i>	Kathrein-specific satellite signal processing systems
VCR connection	Video recorder connection
Viterbi rate	See "Short technical guide"

TROUBLESHOOTING

In the event of a malfunction, first check all the cable connections and operating states:

1. Receiver and TV set power plugs are connected to wall socket
2. Antenna cables on receiver input
3. Receiver and TV set correctly connected by a Scart or cinch cable
4. Audio connections are made to Hi-Fi or Dolby Digital system as appropriate
5. Receiver and TV set (Hi-Fi/Dolby Digital system) are switched on (check power indicators)
6. Receiver is responding to remote control

A selection of troubleshooting tips is offered below.

Problem	Cause	Remedy
"No or bad signal" warning appears on some or all channels	Antenna signal of satellite reception system missing or faulty. Incorrect LNB frequencies set in "Antenna Configuration" menu.	Consult an antenna specialist to have it checked and repaired as necessary. On "Installation" menu check LNB configuration for the satellite in question: High L.O. "10,600" GHz, Low L.O. "9,750" GHz, and Limit frequency L.O. "11,700 MHz", and change as necessary.
Remote control no longer responding	Receiver or remote control command set may have been unintentionally changed	Set infrared code 1, as described in operating manual under "Remote Control RC 660"; check batteries
Wrong time being displayed	"Summer Time" setting wrong. An incorrect time was imported from the reception signal	On "Settings" - "Date and Time Setup" menu check "Summer Time Enabled" and change as necessary Switch off receiver at mains switch from current channel, e.g. ARD or ZDF, wait 10 seconds and then switch back on
The following channels cut out or "No or bad signal" appears: PRO 7, SAT1, Cable 1, DSF, N 24, Tele 5, 9 Live, HSE 24 and Sonnenklar TV	DECT telephones operate on the same frequency as these channels. Interference may occur due to inadequate level or poor shielding of cable	Consult your antenna specialist
Black or blue screen, no on-screen displays	Scart connection to TV deactivated by accidentally pressing the 0 button	Keep pressing the 0 button until the TV picture reappears on-screen

SERVICE

If, despite studying this operating manual, you still have questions about getting started with the unit or using it correctly, or if unexpected problems occur, please contact your specialist dealer.

Internet: <http://www.kathrein.de>

KATHREIN-Werke KG • Anton-Kathrein-Straße 1 - 3

P.O. Box 100 444 • 83004 Rosenheim • Germany
Downloaded from www.Somanuals.com. All Manuals Search And Download.

KATHREIN
Antennen • Electronic

Free Manuals Download Website

<http://myh66.com>

<http://usermanuals.us>

<http://www.somanuals.com>

<http://www.4manuals.cc>

<http://www.manual-lib.com>

<http://www.404manual.com>

<http://www.luxmanual.com>

<http://aubethermostatmanual.com>

Golf course search by state

<http://golfingnear.com>

Email search by domain

<http://emailbydomain.com>

Auto manuals search

<http://auto.somanuals.com>

TV manuals search

<http://tv.somanuals.com>