

Operating Manual

# DVB Satellite Receiver UFD 505



Order no.: 260 494

**KATHREIN**  
Antennen · Electronic



# Safety Instructions

Dear Customer,

The following operating manual will help you obtain the best optimal use from the extensive features of your new satellite receiver.

We have written this operating manual as comprehensibly as possible and as concise as necessary. A brief lexicon containing specialised terms not easily translatable has been appended at the end of this manual. To further assist you in your search for a specific term, we have also added an index.

We have taken the environment into account with the mains switch. Therefore, during longer pauses separate your receiver from the mains, in order to save energy. During short pauses, you should switch the receiver to standby with the remote control, so the least amount of energy is used.

We wish you a great reception and much enjoyment with your new satellite receiver.

Your,

KATHREIN-Team

If you have any unexpected problems with your receiver, please contact your specialist supplier through our hotline.

Tel: (08031) 18 47 00

Fax: (08031) 18 46 76

## **Important Notes:**

*With regard to the programme allocation of the satellites and transponders, changes always occur. In such cases, it is necessary to carry out new programme settings, although factory pre-programming is always in accordance with the respective, newest developments.*

*You can gather the details for the new setting from teletext on SAT 1, the internet, or respective magazines. Refer to the section "Changing frequency" for more information.*

*Your receiver has been equipped with the newest respective Software at the factory. We are always trying to adjust the Software to the desires of our customers and the state-of-the-art technology. Refer to section "Software and programme lists update", for more information.*

# Safety Instructions

<b>Preface</b> .....	<b>3</b>
<b>Contents</b> .....	<b>4</b>
<b>Safety Instructions</b> .....	<b>7</b>
Important notes regarding operation .....	7
Extended absence / thunderstorms .....	7
Mains lead .....	7
Cleaning .....	7
Children-at-play .....	7
Repairs .....	7
Connections .....	7
Place of installation .....	8
Ventilation .....	8
Humidity, exposure to sunlight, heat .....	8
Mains voltage .....	8
Grounding .....	8
<b>Operating elements, displays and connections</b> .....	<b>9</b>
View of front panel .....	9
View of rear panel .....	9
Front panel controls and displays .....	9
Rear panel controls and displays .....	9
Remote control handset keys .....	10
<b>Remote control features</b> .....	<b>11</b>
Menu concept .....	12
Button functions .....	12
Alphanumeric entries .....	12
Alphanumeric assignments of number buttons on the remote control .....	13
Language selection- OSD .....	13
<b>Connection and putting into operation</b> .....	<b>14</b>
To connect receiver .....	14
Sat-IF connection .....	14
Preconditions for receiving digital signals .....	14
Presetting of receiving system .....	14
LNB-supply voltage .....	15
TV and video recorder connection .....	15
Audio connection .....	15
Inserting batteries in the remote control .....	15
<b>First time operation</b> .....	<b>16</b>
The first steps .....	16
Factory setting of receiver .....	16
<b>On-screen displays On Screen Display</b> .....	<b>17</b>
Important on-screen displays .....	17
TV channel identifier .....	17
Radio channel indicator .....	17
Error message .....	17
TV programme list .....	17
Radio programme list .....	18
Selecting a TV programme .....	18
Reception status .....	18
Selecting a TV programme by number entry .....	19
Switching over to radio programme .....	19
Reception status - radio .....	19
Selecting a radio programme by number entry .....	20
<b>Timer-settings</b> .....	<b>21</b>
VPS signal .....	21

# Safety Instructions

<b>Programme overview</b> .....	<b>22</b>
EPG .....	22
Full EPG.....	22
EPG timer programming.....	22
<b>Sound settings</b> .....	<b>23</b>
Setting the volume.....	23
Stereo and two-channel sound reproduction.....	23
AC3.....	23
<b>Programme lists</b> .....	<b>24</b>
Selecting programmes last received .....	24
Favourite programmes.....	24
To sort the channels .....	25
To delete a programme .....	25
To add a programme manually.....	26
<b>Satellites add/remove</b> .....	<b>28</b>
Setting up a satellite .....	28
To enter a name .....	28
To remove satellite .....	28
<b>Password</b> .....	<b>29</b>
Factory setting.....	29
Entering a password.....	29
Parental lock .....	29
<b>Operation from the front panel</b> .....	<b>31</b>
Backup operation.....	31
<b>Setting system parameters</b> .....	<b>32</b>
System parameters.....	32
Parental lock.....	32
System information.....	32
Local time/Timer.....	32
Timer menu .....	32
Summer time .....	33
TV type .....	33
Picture format .....	33
Screen .....	33
A/V mode.....	33
OSD colour .....	34
OSD trans .....	34
<b>Installation menu</b> .....	<b>35</b>
LNB configuration .....	35
Oscillator frequency L.O. ....	35
Changing the oscillator frequency .....	36
Operation .....	36
Standby.....	36
Receiving two satellites .....	36
DiSEqC setting.....	37
Antenna settings.....	37
Satellite search .....	37
TP set-up/search .....	38
Transponder selection .....	38
DiSEqC (UFO) Set-up .....	39
22-kHz signal .....	39
Tone-burst and DiSEqC signal .....	39
Tone burst.....	40
DiSEqC .....	40
DiSEqC Repeat.....	40
UFO mini.....	40

# Safety Instructions

Remote frequency.....	40
UFO micro.....	40
Factory setting .....	41
<b>Video recorder connection .....</b>	<b>42</b>
Recording .....	42
Playback .....	42
<b>Software and programme lists update .....</b>	<b>43</b>
<b>Data transfer from receiver to receiver .....</b>	<b>44</b>
Preparation .....	44
Transferring programme lists .....	44
Transferring operating software .....	44
<b>Technical annex.....</b>	<b>45</b>
Technical features .....	45
Technical data .....	46
Accessories .....	47
Scart socket assignments.....	47
Connection examples .....	48
Connection arrangement 1:.....	48
Connection arrangement 2:.....	49
<b>Glossary, abbreviations .....</b>	<b>50</b>
<b>Service .....</b>	<b>53</b>

# Safety Instructions

## Important notes regarding operation



The following section contains important information relating to the operation, place of installation and connecting-up of the receiver.

Read these notes carefully before putting the unit into operation.

### Extended absence / thunderstorms



Always switch the unit off via its mains switch (at front left on unit) during periods of extended absence or at the onset of thunderstorms. This also applies to any other equipment that is connected to the receiver.

However, take into account any possible timer programming and switch the unit on again in good time prior to the recording time.

### Mains lead



Make certain that the mains lead (power supply lead) is undamaged. Never put the unit into operation if the mains lead is damaged.

### Cleaning



Withdraw the mains plug before cleaning the unit. Use a dry cloth for cleaning. Clean the surface only and nothing else.

On no account open the housing. There is a risk of electric shock if components within the unit are touched.

### Children-at-play



Pay attention that children do not insert objects into the ventilation slots. There is a risk of mortal danger due to electric shock.

### Repairs



If your receiver needs repairing or changes to settings, get qualified specialists to carry this out. Unauthorised opening and attempts at repairs entail loss of guarantee.

The unit's electrical safety can be affected by improper tampering with it.

The manufacturer's liability excludes accidents occurring to the user when the unit is opened.

### Connections



The unit may be rendered inoperative or not work properly if the connections are not wired up properly.

# Operating elements, displays and connections

Important notes for siting and installation.

## Place of installation

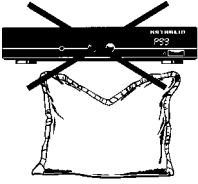

Every electronic device generates heat. The rise in temperature, however, lies within a safe range. Slight colour changes may occur to sensitive furniture surfaces and veneers over the course of time due to the constant effect of heat. In conjunction with treated furniture surfaces, the unit's rubber feet can likewise give rise to changes in colour. Where necessary place the unit on a suitable pad.

## Ventilation

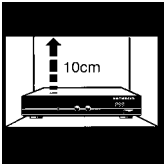

The heat that is generated in this unit is dissipated quite adequately. Never install the receiver in a cabinet, shelf or rack with inadequate ventilation. Never close off the cooling slots on the unit.

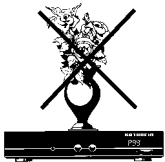

Do not place objects on top of the unit. Maintain a clearance of at least 10 cm above the unit so that the heat generated within the unit is conducted away without obstruction.

## Humidity, exposure to sunlight, heat

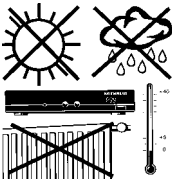

Protect the unit against humidity, drips and splashing.

Do not place the unit close to radiators nor expose it to direct sunlight.

## Mains voltage

Operate the receiver only from a 230V / 50 Hz mains voltage.

The unit must not be connected to the mains and switched on until after the connections have been set up for the antenna and TV set.

## Grounding

The parabolic antenna is to be grounded in accordance with regulations. The relevant local and/or German VDE regulations are to be complied with here.



# Operating elements, displays and connections

This section contains a brief description of all the control elements, displays and connections. The key symbols presented here are also used when describing operating sequences.

## View of front panel

(Flap folded down)

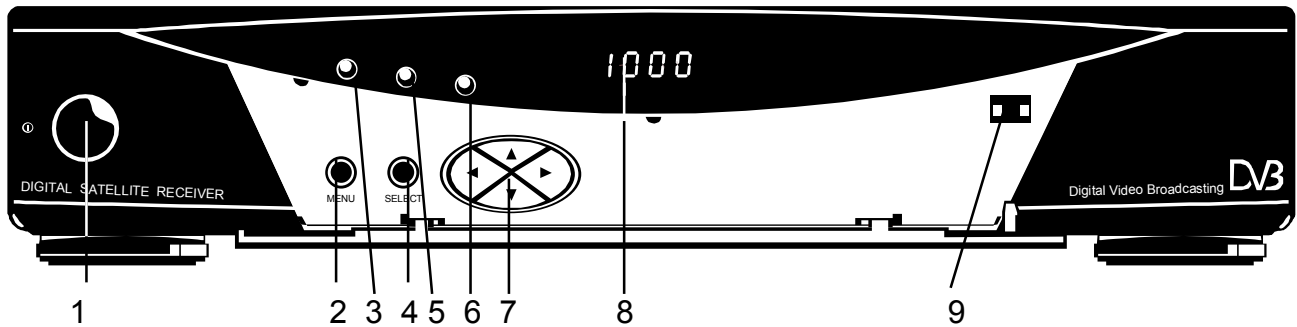

## View of rear panel

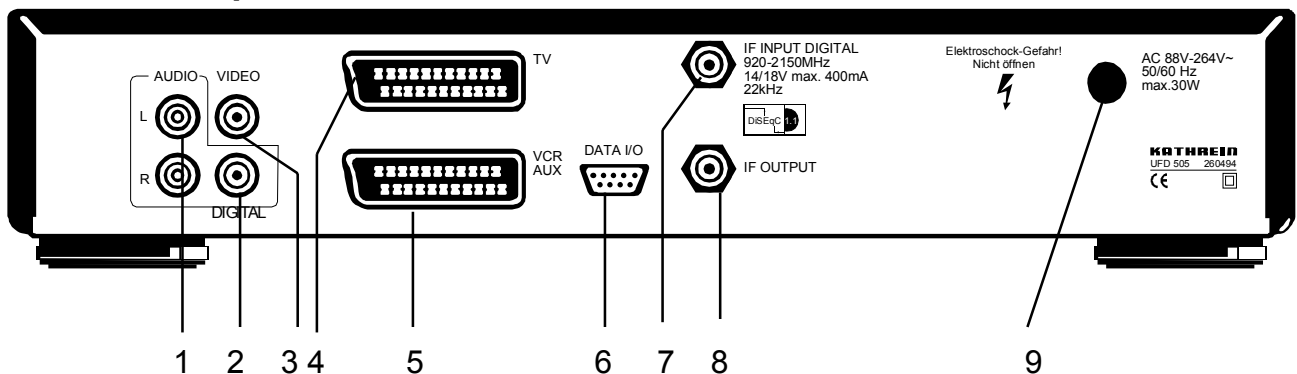

### Front panel controls and displays

- 1 On/Off switch (with mains separation)
- 2 Menu button to call up or exit from menus or submenus
- 3 Indicator to confirm remote control signal
- 4 Select-button to confirm a selection
- 5 Power indicator
- 6 Standby indicator
- 7 Cursor keys to step through menus and programmes, and for adjustment of the volume (corresponds to the remote control)
- 8 LED display (4-character 7-segment display) for display of programme position and time
- 9 Pressure catch for front flap  
Open by lightly applying pressure on the upper right-hand side

### Rear panel controls and displays

- 1 Audio output
- 2 Cinch sockets, left and right channel
- 2 Dolby Digital-output (AC3)
- 3 Video output (FBAS)
- 4 Scart socket TV connection
- 5 Scart socket VCR/AUX connection
- 6 DATA socket  
Interface for serial data transmission (Service)
- 7 Satellite IF signal input  
Output of the LNB supply voltage and control signals (22-kHz and DiSEqC 1.1)
- 8 Satellite IF signal output  
Output for an analogue secondary receiver. The Sat IF signal is looped through.
- 9 Mains voltage supply line

# Operating elements, displays and connections

## Remote control handset keys

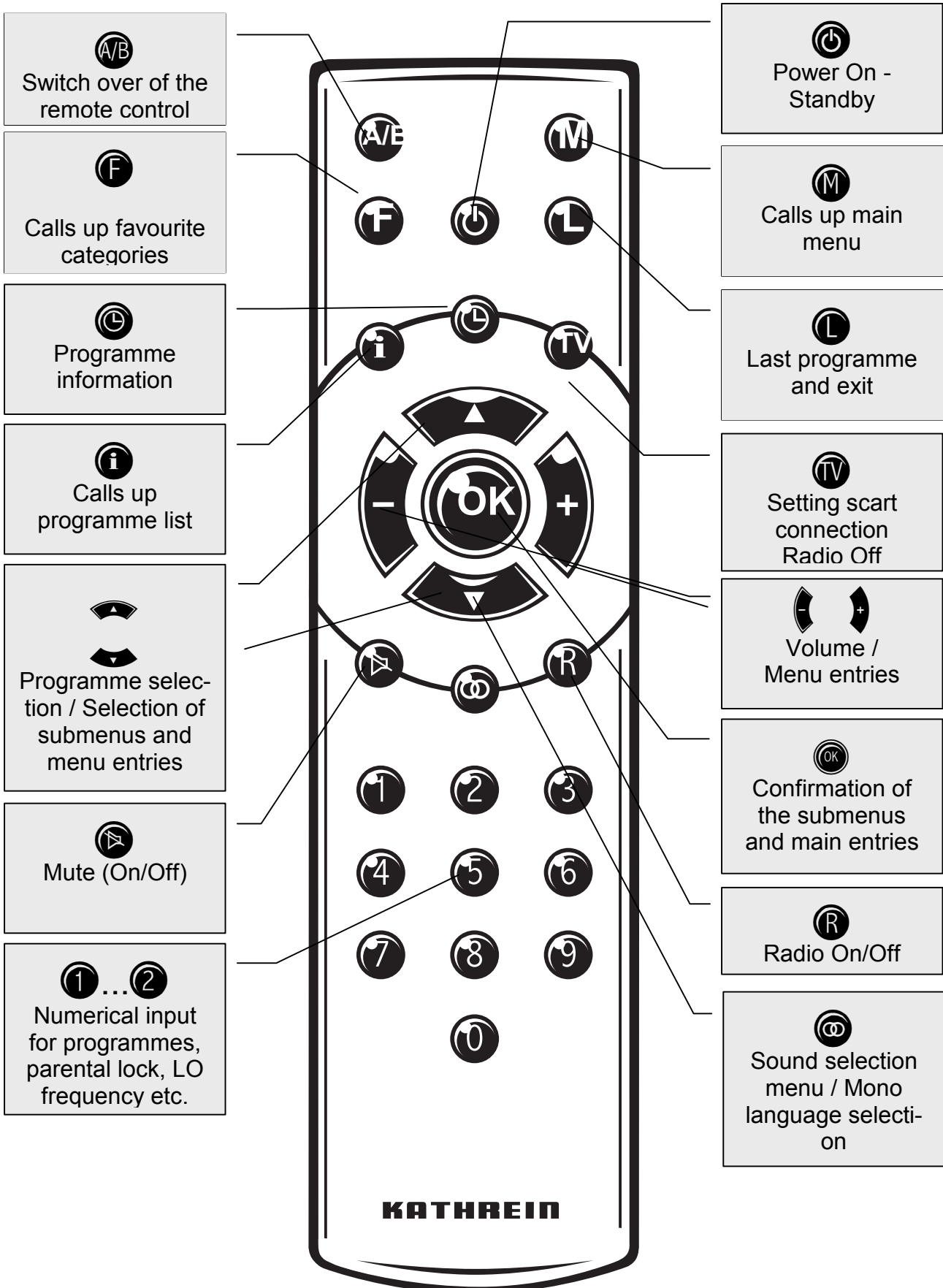

## Connection and putting into operation

The remote control features 2 command sets, making it possible to operate 2 receivers independently of each other in one room (not together with a twin receiver).

### Note

*For this purpose, program one receiver on the command set 1 and the second receiver on the command set 2.*

- Switch on receiver 1 and receiver 2 off with the power switch

⇒ Press and hold the  button.

⇒ Enter "901" with the number buttons.

- To adopt the code, press the  button to switch receiver 1 to standby and then switch off the device at the power switch.

- Switch on receiver 2.

⇒ Press and hold the  button.

⇒ Enter "902" with the number buttons.

⇒ To adopt the code, press the  button to switch receiver 2 to standby and then back into operation. Now switch on receiver 1 again.

⇒ Press and hold the  button.

⇒ Enter "903" with the number buttons.

### Note

When carrying out the first two settings, the remote control must be directed at the respective receiver (when switched on).

By pressing the  button, you can now switch between the two command sets A and B (toggle function) and alternately operate both receivers.

Command set 1 is always active as the on-delivery setting.

### Note

*If you are operating only one receiver and the active command set is switched over by mistake so that this receiver can no longer be operated, the remote control can be easily switched back to command set 1. For this purpose, follow the procedure described above.*



# Connection and putting into operation

## Menu concept

Note:

Coloured backgrounds are used to emphasise the selected menus, submenus and menu items as well as the parameters to be set. The menus are to a large extent self-explanatory. You will find information relating to the selected menu point in the information box displayed under the menu.

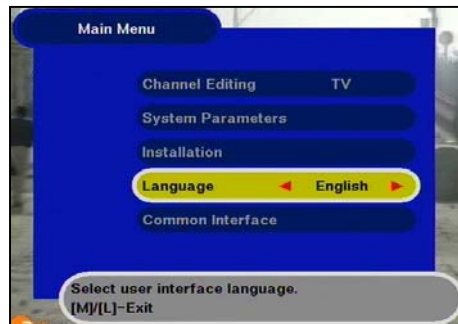

Press the **M** to select the main menu and press the **▲** **▼** - buttons to select the submenus.

Press **OK** to access the submenus. The items in the submenus are selected

by pressing the **▲** **▼** buttons.

The settings allocated to specific menu

items are executed either by pressing the **←** **→** buttons or the number buttons.

Press **L** or **M** to exit the main menu, submenu and menu items.

## Button functions

**i** is a changeover button (main channel list or favourite list) with menu function.

**TV** is a changeover button. Identifier self-deleting.

**⊗** is a switch-on button with menu functions. Press the button again to exit

**⊕** is a switch-on button with menu functions. Press the button again to exit.

**F** is a switch-on button with menu functions. Press the button again to exit.

**R** is a function selection button. Press once again to change function.

**▶** is a function selection button. Press once again to change function.

## Alphanumeric entries

Use the number buttons to enter the programme and satellite names. They produce numbers and letters in the name fields of the corresponding menus. Position the bar cursor on the name field. The first position automatically assumes a dark background. You can now also enter letters with the number buttons by pressing the corresponding button several times. For example, Q, Z and — are additionally allocated to the "1" button (see table on next page).

# Operating instructions

## Alphanumeric assignments of number buttons on the remote control

Button	1 X	2 X	3 X	4 X
①	1	Q	Z	-
②	2	A	B	C
③	3	D	E	F
④	4	G	H	I
⑤	5	J	K	L
⑥	6	M	N	O
⑦	7	P	R	S
⑧	8	T	U	V
⑨	9	W	X	Y
⑩	0	SPACE		

## Language selection- OSD

To select the language for the on-screen menus press:



The available languages are German, English, French, Italian, Spanish, Portuguese, Dutch, Greek and Turkish.

# Operating instructions

The following section is specifically intended for the specialist dealer. You only need to read this section if you are carrying out the installation yourself.

You will find sample configurations in the section "Connection examples".

First carry out all installation work before connecting the receiver to the mains power supply.

Refer to the information provided in the section "Safety instructions".

## To connect receiver

### Sat-IF connection

Connect the Sat-IF input of the receiver to the satellite receiving system (satellite dish).

*Use a coaxial cable with a standard F connector for this purpose.*

If you need to fit the F-connector onto the cable,

- strip the cable insulation as shown in the diagram (you will need to fold back the braid) and
- slide the F-connector onto the cable, then turn it clockwise until it locks.

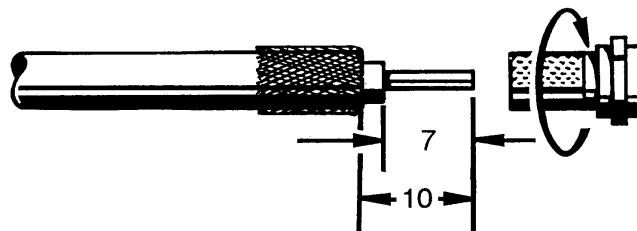

*When fitting the connector make sure that no wires of the shield braid make contact with the inner conductor. This could otherwise cause a short-circuit.*

*The quality of the reception signal depends on a good connection!*

### Preconditions for receiving digital signals



*Make sure that your satellite antenna system is equipped with at least one universal LNB to facilitate digital reception in the high band range.*

### Presetting of receiving system

The control signals for conventional receiving systems (satellite dishes) are preset, i.e. 14/18 V for polarisation changeover and 22 kHz switching signal for LOW/HIGH band changeover on multifeed reception systems.

The presetting will need to be changed in the installation menu, menu point "DiSEqC" if UFO or tone burst switching matrices are used in the receiving system.

Refer to the section "Installation menu, DiSEqC menu" for this purpose.

It is important that you observe the application information provided for the matrix used.

# Operating instructions

## LNB-supply voltage

If the feed system (LNB) is powered by an external supply voltage and the LNB supply voltage is not used for switching over polarity (e.g. Kathrein feed system UAS 330), the LNB supply of the receiver must be set to "OFF" (see section "Installation menu, LNB configuration").

## TV and video recorder connection

- Use a SCART cable to connect the satellite receiver (TV SCART) and TV set.

If your TV set is equipped for stereo output, you can receive the sound in stereo via the SCART connection.

- Also use a SCART cable to connect the satellite receiver (VCR/AUX SCART) and the video recorder.

## Audio connection

If you wish to reproduce the sound via a hi-fi system, connect a corresponding Cinch cable from the audio Cinch sockets on the receiver to the input sockets on your hifi system.

The digital output is designed to facilitate connection to a Dolby Digital System.

## Inserting batteries in the remote control

Remove the cover on the battery compartment on the underside of the remote control.

- Insert the two supplied batteries in the remote control. Ensure correct polarity of the batteries, the + and – markings are indicated inside the battery compartment.
- Slide the cover back into the casing and lock in position.



*Used batteries are special waste! Therefore do not throw batteries into the household waste but rather deposit them at a collection depot for old batteries!*

# Operating instructions

## The first steps

Connect the receiver to the mains power supply.

Switch on the receiver by pressing the power button at the front of the unit.

You will see "- - -" in the LED display, afterwards "0000."

The operation indicator LED lights red, the receiver is now in standby mode.

Switch on your TV set.





Switch on the receiver by pressing the  button on the remote control.

*The yellow LED at the front end of the receiver flashes every time a button on the remote control is pressed.*

You will see the factory preset programme on your TV screen. An information bar indicating the programme provider, the time, the timer settings, the programme status and the programme title will be displayed in the bottom section of the screen provided the corresponding data are transmitted. The number of the programme memory appears in the LED display.

The red standby indicator goes out.

You can now receive the TV and radio programme preset at the factory and select

them by pressing the   buttons. Press the  and   buttons to

select radio programmes. Press the  or  button to return to TV programmes.

Refer to the section " Programme lists – TV/radio" for information on how to set up and save other TV and radio programmes.

*The reception status last set always reappears when the receiver is switched on.*

If the message "bad or no signal" appears on the screen in addition to an on-screen display indicating the programme last received, you will need to check the system installation and/or the receiver settings. If this problem only applies to individual programme slots, the problem may be due to an interruption in the transmission signal or a fault in the receiving system (cable or satellite system).

In this case, first check the connection configuration and then check whether the basic settings of your receiver are correct for your system. In the case of doubt, have a specialist do this for you.

## Factory setting of receiver

*Your receiver is pre-programmed to receive the ASTRA and HotBird satellites. You will normally need to make no further settings. To receive both satellite systems or other satellites you will require a multifeed arrangement with at least two LNBS in front of the satellite dish if you are not connected to a communal or party system. Please ask your dealer.*

*Before you change the basic settings of your receiver, note down the settings in the form provided at the end of this User's Guide. In this way, you will be able to restore the original settings at any time.*



# Programme selection

## Important on-screen displays

The receiver functions are controlled by a microprocessor and extensive software. The following explanations are intended to improve understanding of all procedures and to minimise the risk of mistakes.

### TV channel identifier

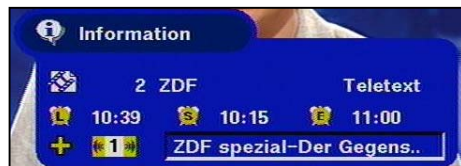

The film symbol indicates a TV channel with the selected programme shown next to it and whether teletext is received. The current time, start time and end time of the current programme are shown on the next line provided these data are transmitted. The + in the third line stands for the programme selection from the main programme list. If the favourite list is selected, you will see the "apple" symbol at this point. This is followed by the set sound reproduction mode (depending on the direction of the symbolised sound waves, mono left, mono right or stereo can be set, the digit indicates the number of sound channels). The programme title is shown in the box on the right.

The channel identifier is displayed for several seconds every time the channel is

changed or by pressing the  button.

The  indicates that a channel is received even if no picture can be seen (e.g. radio).

### Radio channel indicator



the signal.

The identifier for the set radio channel has the same configuration. A music note appears in the upper right-hand corner indicating a radio channel. Programme times and text are displayed only if the corresponding data are transmitted with

### Error message



the list of service settings provided at the end of this User's Guide.

"Bad or no signal" indicates that there is a fault in the reception system or in the receiver settings or the transponder is not transmitting. Instead of the  the channel identifier shows a satellite antenna together with the message "bad or no signal". Check the SAT-IF connection and the LNB configuration. As an aid, refer to

### TV programme list



contains information relating to the channel, the programme provider and whether

Press the  button to show the programme list. A + for the main programme list or the "apple" symbol is indicated at the top left. The list can be changed by pressing the button again. Information relating to the received satellites, the polarisation, the symbol rate, scrambling, favourite or standard programme and the parental control is provided in the column below the symbol. The column on the left

# Programme selection

the programme is normally scrambled. The required programme can be selected with the bar cursor and confirmed by pressing the  button.

## Radio programme list

See above. The same applies to the radio programme list. Programme selection

This section describes how you select analogue and digital TV programme with your receiver and how you can set the required volume. This description of the functions assumes that the receiver has been connected correctly.



If you wish to connect the receiver yourself, please read the section "Connection and start-up" beforehand.

## Selecting a TV programme

### Reception status

The following information describes how to select other channels and shows what the on-screen displays look like.



After switching on the receiver, simply press the   buttons in order to select other TV programmes in their ascending or descending order in the channel memory.

Every time you press the button, an on-screen display shows you the selected programme together with the time, the programme start and end times as well as the programme title in the information box provided these data are transmitted together with the signal.



By pressing the  button, you can leave this information box permanently displayed or switch it off by pressing the button once again.

You will receive the "channel scrambled" message for scrambled channels.





*You cannot view a scrambled channel. However, some broadcasters occasionally*

*transmit unscrambled programme blocks.*



A further option of selecting a different

programme is to press the  button. The TV channel list is now displayed. In the left column, it will provide information relating to the received satellites, the transponder and its transmission frequency, the polarisation, the symbol rate and the scrambling. The programme number, the programme broadcaster and the type of reception signal (free to-air/scrambled) is shown on the right.

With the   buttons you jump to the next programme, with the   buttons you jump to the neighbouring page or with the buttons on the remote control enter

the programme number (Ch). Confirm your selection by pressing the  button.

Press the  button to exit the programme list and remain in the already programme set.

# On-screen displays On Screen Display

## Selecting a TV programme by number entry

You can select a different TV programme during a current TV programme by entering the programme location number.

Use the number buttons **1** to **0** for the purpose of entering the programme locations.

Example

You wish to select the TV channel "DSF". This programme is stored under the programme location number 015. (The order of TV programmes is defined in the programme memory and therefore only serves as an example here.)

To select this programme, press the numbers **1** and **5** one after the other. The receiver waits for about 3 seconds for entry of the next number.

Follow the same procedure for all other programmes – i.e. also programmes with three-digit programme location numbers. You do not have to enter leading zeros.

## Switching over to radio programme

You can switch over from a TV programme to a radio programme.

Press the **R** button on the remote control for this purpose.

The receiver switches over to the programme location of the radio programmes last

set. You can return to the TV programme by pressing the same button or **TV**. The corresponding display relating to the received programme, i.e. as when selecting the TV programmes, appears on the screen. The LCD display shows a small "r" together with the programme location number.



The screen will be blanked out after several seconds.

## Reception status - radio



After switching over the receiver, simply

press the **▲** **▼** buttons to select other radio channels in their ascending or descending order in the channel memory.

Every time you press the button, an on-screen display shows you the selected channel together with the time, the programme start and end times as well as the programme title in the information box provided this data is transmitted together with the signal.





By pressing the **OK** button, you can leave this information box permanently displayed or switch it off by pressing the button once again.



A further option of selecting a different

programme is to press the **i** button. The radio programme list is now displayed. In the left column it will provide information relating to the received satellites, the transponder and its transmission frequency, the polarisation, the symbol rate and the scrambling. The right side shows the programme number, the programme broadcaster and the type of reception signal (free-to-air/ scrambled). By pressing the **▲** **▼** buttons you jump to the next

## On-screen displays On Screen Display



programme and by pressing the  buttons you jump to the neighbouring page or enter-in the channel number with the buttons on the remote control. Confirm your programme selection by pressing the  button, press the  button to exit the programme list and remain in the programme already set.

### Selecting a radio programme by number entry

You can select a different radio programme during a current radio programme by entering the programme location number. Use the number buttons  to  for the purpose of entering the programme location number.

#### Example

You wish to select the radio programme "DLR-Berlin". This programme is stored under the programme location number 015. (The order of radio programmes is defined in the programme memory and therefore only serves as an example here.)

To select this programme, press the numbers  and  one after the other. The receiver waits for about 3 seconds for entry of the next number.

Follow the same procedure for all other programmes – i.e. also programmes with three-digit programme location numbers. You do not have to enter leading zeros.

# Timer-settings

You can use the timer for recording a programme with a video recorder on time. Seven timers are available which you can set to different programmes as well as start and end times.

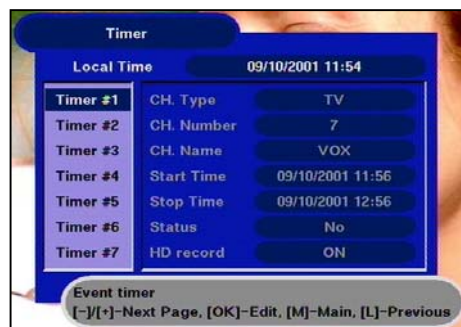

To access the timer setting, press **M** to enter the main programme menu,

**▼** **▲** to go to system parameters,

followed by **OK** and **▼** **▲** to local time

/ timer and **OK**. The screen in the margin appears.

Press the **▲** **▼** buttons to move the

cursor to the timer you require and confirm it by pressing **OK**. Press **L** to exit the timer again.

Incorrect time settings will be rejected.

You can select and set

- the programme type (TV, radio or software download),
- the programme location (numerical via the remote control),
- the start time (date, month, year, hour, minute)
- the stop time and
- the timer status (inactive/once/daily/weekly)

for seven timers. You must enter leading zeros for the time settings.

You can also carry out the presetting via the EPG (Electronic Program Guide). Refer to section „Programme overview – Full EPG.“

Use the **-** or **+** and the number buttons to make the required setting.

The current time that you must re-enter appears under the start time. If no other setting is entered, the end time will be set automatically to the same date and one hour after the start time.

Finally confirm the settings by pressing **M** or **L** 3 times.

**If you have preset a download per timer, the following timer settings are ignored after a successful download!**



## VPS signal



Make certain, that no VPS signal is included in the digital television signal.

Therefore, you will need to programme your video recorder corresponding to the timer settings.



# Programme overview

## EPG



With the **[C]** button, you receive an overview of the programmes (see on-screen display) currently received from the transponder with time and duration, provided that they are broadcast with electronic programme guide (EPG), for example, with ARD and ZDF. In the right-hand column, the programme title is given in abbreviated form, and the complete title appears in the last two

lines. In the left-hand column, the **[▲]** **[▼]** keys can be used to move the cursor to a programme which should be switched to with

the **[OK]** button. Use **[L]** to exit the on-screen display again.



The time scale can be altered with the **[←]** **[→]** buttons, so the other course of programmes can be called up.

Use the Info button **[i]** to receive further information about the currently running programme with up to 254 symbols.

## Full EPG



With the **[C]** and **[F]** buttons, you receive the programme overview of the currently received transmitter with time and duration (see on-screen display), provided that they broadcast the electronic programme guide (EPG).

The length of the programme list depends on each programme provider and can amount to several days.

It lasts a few seconds for the list to download.

## EPG timer programming



Afterwards, you can move the coloured bar in the list with the **[▲]** **[▼]** buttons and select a programme for timer programming.

The timer is selected with the **[R]** button and confirmed with **[OK]**. The programme is recorded at the set time.

Press the **[L]** three times to leave this position without a timer setting.



# Sound settings

## Setting the volume

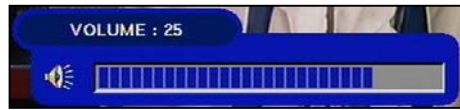

on the screen to show the set volume.

Set the required volume level by pressing the buttons on the remote control of the receiver. A bar indicator is displayed

## Stereo and two-channel sound reproduction



in the box on the right. Press the button to call up the audio menu for sound and language selection. You can now make the required settings, e.g. language selection, provided the corresponding data are contained in the reception signal (sound track), Dolby Digital (5.1 CH). Select the menu points by pressing the

buttons and select the required setting with the buttons. Press the button once again to exit the menu.

The channel identifier that you can display

by pressing the button shows the set sound reproduction. (Depending on the direction of the symbolised sound waves – under the displayed time – mono left, mono right or stereo can be set. The digit indicates the number of transmitted sound channels). The programme title is shown

## AC3

The receiver can process sound transmissions in AC3 format (Dolby Digital) providing you with the opportunity of listening to cinema sound quality in your living room. The digital sound output is provided for this purpose. You will need to connect it to a corresponding system.

*Please refer to the instructions manual of your Dolby Digital system.*

In order to reproduce the AC3 format, set your receiver in the audio menu under "stereo" to "2 of 2" or "2 of 2 (2ch)". The corresponding transmission – "5.1 Ch" (5 channels + 1 subwoofer channel) is then indicated at "Dig. output".

If AC3 format is not transmitted, you will only be able to select the standard stereo or mono settings or select the broadcast language.



## Mute

Press the button on the remote control to mute the sound. This symbol appears on the screen.

Press the button again to restore the sound. The standard volume display bar is then shown for several seconds.

Although you can change the programme while in mute mode, it will remain muted until this mode is cancelled or you correct the volume.

# Programme lists

The programmes /channels set at the factory can be changed in the "programme list" menu. Select the menu by pressing the **M** button, the **▲▼** buttons as well as **◀▶** for TV or radio and **OK**. If stored, a password must be additionally entered.

## Selecting programmes last received

Press the **F** button to show on the screen the four programmes you last received.

The arrows correspond to the cursor buttons **▲▼** **◀▶**. The allocated programme can then be selected by pressing these buttons.



Select this function to call up the on-screen display shown opposite.

## Favourite programmes

You can arrange and sort your favourite TV and radio programmes, e.g. all German-language programmes or programmes that have no commercial breaks. These programmes are identified by the "apple" symbol in the TV or radio programme lists.



Select the "apple" symbol by pressing the **◀▶** buttons, confirm your selection with **OK** and the line with the current channel will be highlighted by a coloured bar in the list. The bar can be shifted page-by-page or line-by-line by pressing the **▲▼** and **◀▶** buttons.

You can now mark the highlighted line with the "apple" symbol by pressing the

**OK** button.

The symbol can be cancelled by pressing the **OK** button once again. Press the **M** button 3 times to return to the TV screen. Confirmation is given that your changes have been saved and the information display of the programme currently

received appears for several seconds on the screen. Press the **i** button twice to call up the favourites list. You can now select your preset favourite programmes by

pressing the **◀▶** or **▲▼** buttons and **OK** ..



# Programme lists

## To sort the channels

You can sort programmes as desired. The programmes are sorted by shifting the entries in the programme lists.



Press the **M** button to access the main menu. Select " programme list" by pressing the **Left** **Right** buttons. With the **Left** **Right** buttons you can now choose whether you wish to edit the TV or radio list and confirm your selection with **OK**.

You now see the desired programme list on the screen. Press the **Left** **Right** buttons to

select the item "E", confirm your selection with **OK** and the line with the current channel will be highlighted by a coloured bar in the list. The bar can be moved page-by-page or line-by-line with the **Left** **Right** and **Left** **Right** buttons. The highlighted line can now be "captured" by pressing the **OK** button and shifted to the required position with the **Left** **Right** and **Left** **Right** buttons and saved in the corresponding programme slot by pressing **OK**.

Press the **M** button 3 times to return to the TV screen. Confirmation is given that your changes have been saved and the information display of the programme currently received appears for several seconds on the screen.

## To delete a programme



Basically follow the same procedure for sorting in order to delete a programme.

Press the main menu button **M** to access the main menu:

Select " programme list" by pressing the **Left** **Right** buttons.

With the **Left** **Right** buttons you can determine whether you wish to edit the TV or radio list and confirm your selection with **OK**.

The selected programme list appears on the screen.

Press the **Left** **Right** buttons to select the item „X“, confirm your selection with **OK** and the first line in the list is highlighted by a coloured bar.

The bar can be moved page-by-page or line-by-line with the **Left** **Right** and the **Left** **Right** buttons or enter in the programme location with the numerical buttons.

# Programme lists

The highlighted line can now be prepared for deletion by pressing the  button. The control programme now asks: "Do you want to delete this channel?"

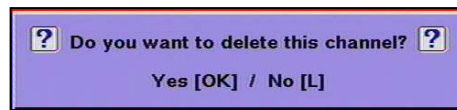

Confirm your desired selection by pressing the corresponding button.

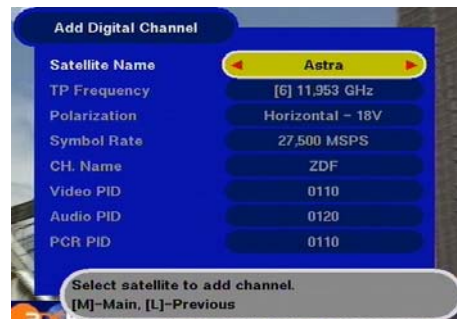

Press the  button to delete the programme slot. If necessary, you can now continue to delete the next programme slot.



Press the  button 3 times to return to the TV screen. Confirmation is given that your changes have been saved and the information display of the programme currently received appears for several seconds on the screen.

## To add a programme manually

Basically follow the same procedure for sorting in order to add a channel.

Press the main menu button  to access the main menu:

Select "programme list" by pressing the  buttons.

With the  buttons you can now choose whether you wish to edit the TV or radio list and confirm your selection with .

The screen now shows the menu for adding a programme.

Press  or  to select the position „+“ and confirm with .

A new menu is now displayed where you can enter the details of the new programme.

The first line in the list is highlighted by a coloured bar.

Press the  buttons to move the bar vertically to the desired position.

Press the  buttons or numerical buttons to edit the relevant position, i.e. to make the necessary entries.

It is possible to set

- the received satellite,
- the transponder, the transponder frequency,
- the polarisation and
- the symbol rate

This procedure is only useful for transmitters, which don't send DVB signals. Otherwise, please use the search function.

## Programme lists

Only alphanumerical and decimal entries are accepted at the positions

- name,
- video PID (programme identification),
- audio PID,
- PCR PID (PCR = Programme Clock Reference) and
- audio PID dig.

Incorrect PID entries are rejected with the displayed message.

**incorrect parameter**

Press the **L** button 3 times to return to the TV screen. Confirmation is given that your changes have been saved and the information display of the programme currently received appears for several seconds on the screen. The new programme is added to the end of the existing programme list.

*You can obtain the necessary PIDs from relevant TV and satellite magazines, the internet as well as from SAT 1 video text. Refer to section "Operating instructions" for information on how to make alphanumeric entries.*

*The entry is only required for programmes, which are not broadcast in conformity with DVB.*

*Never change the PIDs without good reason as they affect the identification of the reception signal.*

# Satellites add/remove

## Setting up a satellite

The LNB can naturally also accommodate new satellites.

For this, the orbit position that you need to take a bearing on must be known. The "Antenna settings" menu entry in the installation menu can be used as an aid for alignment of the antenna.



Arrive to the menu item "LNB configuration" via the main menu **M** and the „Installation“ - submenu with the **▲** **▼** and **OK** buttons (plus password). You select it with **OK** and can then enter or select a new satellite.

Remember that your system must be set-up accordingly!



In the next step, move with **▲** **▼** to e.g. the entry „User1“.

After pressing the **-** or **+** button, the shown on-screen display appears.

Confirm it with **OK**.

The following message appears

Changes are being saved  
One moment please

You can now make the entries appropriate to your receiving system in the corresponding positions using the **▲** **▼** and **-** or **+** buttons and quit the menu by pressing **L** button three times. At the same time the new station data is stored.

Make the alphanumerical entries using the numerical buttons on the remote control. For information see section "operating instructions."

## To enter a name

You can change the satellite name in the LNB configuration menu using the number buttons. Refer to section "operating instructions" for information about the exact procedure.

## To remove satellite

To remove a satellite, select the "LNB configuration" menu, move the cursor bar

with **▲** or **▼** and confirm by pressing the **-** or **+** button. You will now be asked whether you wish to remove the satellite. You can either confirm your selection with **OK** or cancel with **L**.

# Password

You can prevent your satellite receiver to be used by unauthorised persons by means of a password. With this password, you can ensure your reception settings are not changed by other persons. At the same time, you can activate the parental control function to lock out various programmes.



Keep your password in a safe place so that you always have access to your channels should you ever forget it.



## Factory setting

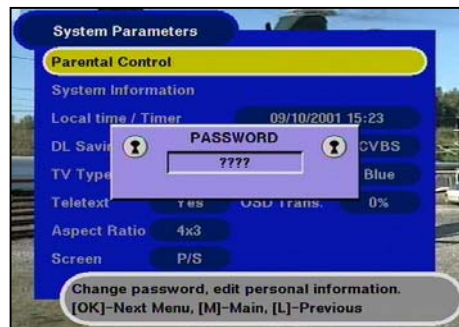

The password „0000“ is inactively set in the factory.

## Entering a password

Call up the mains menu by pressing the  button:



In this menu, press the   buttons to select the "system parameters" and confirm by pressing .

Now press the   buttons to select the "parental control" function and confirm by pressing . You may be asked to enter a password.



Carry out the following settings in this on-screen display:

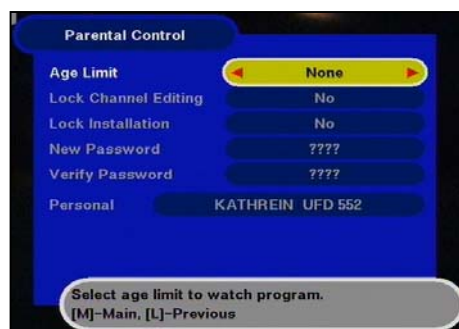

**Age limit:** This setting is only effective if the corresponding lock-out signals are sent together with the transmission.

**Lock list:** Yes/No. With this option you can lock or unlock the editing function for channel lists.

**Lock installation:** Yes/No. With this option you can lock or grant access to the installation menu.

**New password:** Here you can enter your (new) password with the aid of the number buttons.

**Confirm password:** Here you enter your (new) password once again with the number buttons to serve as a confirmation.

**Personal:** Here, enter the receiver identification which is displayed when the receiver is turned on. This is useful for identification in case of theft. See section "operating instructions" for information on how to use the numerical buttons on the remote control for alphanumerical entry. The factory setting is „UFD 505“.



You have now undertaken all the settings for safeguarding and identifying your satellite receiver.



## Parental lock

You can set parental lock in a manner similar to that used for marking favourite programmes by means of the "Apple" symbol. This denies children access to unsuitable programmes. The "Padlock" symbol is used to identify the programmes in the "TV" or "radio" programme lists.



Arrive at the main menu by pressing the main menu button .





# Password

Here, use the   buttons to select the "Programme list" entry.



Using the   buttons, you can now specify whether you want to edit the TV or radio list. Confirm your selection with .

The desired programme is now displayed on the screen.

Use the   buttons to select the "Padlock" symbol, confirm the selection with  and the line with the currently running programme is highlighted in the list with a yellow bar.

Use the   and the   buttons to move the bar pagewise or line-by-line.

Using the  button, the highlighted line can be marked with the "Padlock" symbol.

Press  two times to confirm the memory modifications, and after pressing the  button once more, you are requested to enter the password, provided that none has been entered yet (please enter a four-digit number here).

Finally, the programme originally received appears and for a few seconds the on-screen info display is displayed.

Press the  button once again in the same line and the symbol is removed.



Remember that some programmes can be received several times over on different satellites. In this case, each incidence needs to be locked.

*The same accounts for transponder exchange.*

# Operation from the front panel

If you have misplaced the remote control or the batteries are empty, you can still operate your receiver from the front panel.



## Backup operation



On the front panel, there are 6 buttons at your disposal.

The On/Off button, menu, select, and the cursor buttons with horizontal and vertical arrows.

The unit is switched on and off with the On/Off button.

The menu button, like the  button, brings you to the main menu.

The vertical arrow buttons have the same function as the   buttons and bring you to the submenus.

The horizontal arrow buttons have the same function as the   buttons.

The select button has the function of the  buttons.

*Since there are no numerical buttons, no functions protected by the password can be called up.*



# Setting system parameters

The following settings should not be altered without good reason, since they are factory presets or operational settings, matched specifically to your receiving system.









Only extensions to the receiving systems or modifications call for new settings.

The selected menus, submenus, entries, and parameters are highlighted. The menus are mainly self-explanatory. In the bar displayed below the menu, information is to be found for the particular menu entry.

The main menu comprises of the following submenus:

- Programme lists,
- System parameters,
- Installation and
- Language.

## System parameters



Select the menu "System parameters" with the  menu button, the   buttons in the main menu and . The   buttons are used to select further entries.

### Parental lock

The basic settings that can be implemented here are described under the setting up of parental lock in chapter "Password."

### System information

Under the „System information“ entry, you will find the factory presets, which cannot be altered, and are intended solely for service personnel.

Press the  or  button to return to the submenu system parameters.

### Local time/Timer



The receiver displays the UTC time transmitted with the data stream (United Time Coordinate, former Greenwich Mean Time). Therefore in Germany, the time must be corrected by +1 hour.

*A correction for summer time may possibly be required so that the timers turn on and off at correct times.*

You can make this correction yourself using the numerical buttons. Move the cursor

bar with the  button to the entry Local time/Timer. The first digit in the time entry is shadowed. You can now correct date and time with the numerical buttons.

After each entry, the cursor jumps to the next position. Press the  two times to end the entry. The receiver saves the new setting.

*Afterwards, do not switch off the receiver with the mains switch but rather with the remote control, otherwise the settings will be lost.*

### Timer menu

See section "Timer settings."



# Setting system parameters

## Summer time

See above. Changeover in spring or fall.

Confirm by pressing  two times.

## TV type

Use the  buttons to specify whether your TV set is a

- PAL,
- Multi-standard
- NTSC unit

Confirm by pressing  two times.

## Picture format

Use the  buttons to select the type of picture format, either

- 4 : 3 format or
- 16 :9 format.

Confirm by pressing  two times.

## Screen

Use the  buttons to select the type of screen display:

- conventional (P/S) = standard representation for 4:3 units or
- widescreen picture (letter box display off) - in this settings, the widescreen is required for the 16:9 unit.

Confirm by pressing  two times.

## A/V mode

Here, you use the  buttons to select the type of video signal which is present on the Scart socket. Select the signal which your TV set is able to process.

Observe the operating instructions of your television set!

- FBAS –composite baseband signal (colour-/picture-/blanking-/synchronising-signal)
- RGB – red-/green-/blue-signal
- Y/C – S-VHS signal (luminance/chrominance).

Confirm by pressing  two times.

## Setting system parameters

### OSD colour

Use the  buttons to select the background colour of the on-screen display.

Confirm by pressing  two times.

### OSD trans

Use the  buttons to select the transparency of the background colour.







Confirm by pressing  two times.

# Installation menu

You should not change the following settings without good reason as they represent factory settings or operational settings that are adapted to your receiving system.

New settings are only required when changes or expansions are made to the reception system.

The main menu consists of the following submenus:

Select the "Installation" menu with the menu button , the   buttons in the main menu and . If set, you must also enter the password. Select the menu points with the   buttons.

## LNB configuration

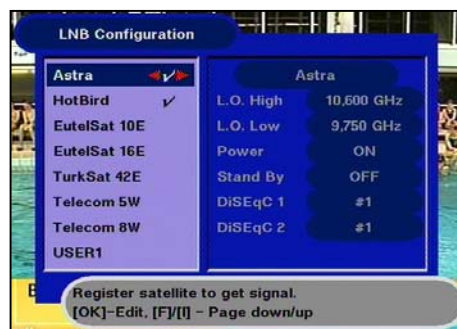

The first submenu is the "LNB

configuration". Press  to open this menu. Normally, you should not make any changes in this submenu. Before making any changes, however, you should make a note of the settings in the form provided at the end of this User's Guide.

Your receiver is set at the factory to the satellites of the ASTRA and HotBird systems.

The other basic settings are shown in the illustration opposite.

## Oscillator frequency L.O.

Satellite receiver systems consist of the parabolic antenna (satellite dish) with the actual receiving system mounted in front of it (LNB – Low Noise Block Converter or LNC - Low Noise Converter) which converts the RF signals of the satellite to a lower frequency so it can be processed by a satellite receiver.

The satellite transmission frequencies are within the following ranges:

10,7...11,7 GHz	Low-band ( Low-band / analogue transmission)
11,7...12,75 GHz	High-band (High-band / digital transmission) (valid for ASTRA satellites at 19,2° E)

The reception frequency of the receiver, however, is in the range from 950 to 2150 MHz. The high frequencies are therefore stepped down with the aid of the oscillator frequency (LO frequency / LO = Local Oscillator of the LNB) to a lower frequency. Various oscillator frequencies are used for this purpose depending on the satellite frequency range and the type of system.

For ASTRA and Eutelsat receiver systems, this frequency is normally 9.75 GHz (9750 MHz) for the lower frequency range (low-band) and 10.6 GHz (10600 MHz) for the upper frequency (high-band). Older receiver systems still operate in the low-band range with a 10 GHz oscillator frequency.

The receiver generates its required frequency by subtracting the oscillator frequency from the satellite transmission frequency stored for each channel. You only need to set the oscillator frequencies that your receiver system actually uses. Therefore, before changing the LO frequency make sure that this is at all necessary.

The oscillator frequencies shown at the top of the picture are factory settings.

# Installation menu

## Changing the oscillator frequency

Move over to the right-hand side in the LNB configuration menu by pressing  and the setting for LO High will be highlighted in colour. Using the number buttons, you can now enter a frequency matching your system. The same also applies for

the LO Low setting. Press the   buttons to go to this setting.

Press the  4 times to exit the menu. At the same time, the receiver will confirm that the values have been saved.

If a setting is incorrect, you will see the following message on the screen

**Bad or no signal**

## Operation



Factory setting "ON".

Normally, the supply voltage should always be switched on.

For communal or party systems, you must check whether the supply voltage must be switched off!

## Standby

Under this menu point the supply voltage for the LNB in receiver standby mode can be switched on and off. It can be switched off for individual and communal systems. The factory setting is "OFF".

## Receiving two satellites

If your receiver is connected to a multifeed antenna that is also aligned with the HotBird satellites for instance, you will need to change the receiver settings for the DiSEqC signal. The same, of course, also applies to other satellites. (DiSEqC = Digital Satellite Equipment Control).

Different control signals are required for the purpose of selecting the satellite signals. To date, the LNB supply voltages 14/18 V and the 22 kHz signal (superimposed on the LNB supply voltage) have been sufficient for signal selection in the majority of applications. With these four switching signals it is possible to switch between horizontally and vertically polarised signals as well as between satellites (multifeed reception).

However, additional control signals are now required for LNB activation and signal selection in view of the expansion of the frequency range to 12 GHz (high-band range) and for receiving more than two satellites.





The "DiSEqC" control signal is responsible for this task. This signal represents a special modulation of the already existing 22 kHz signal.

# Installation menu

## DiSEqC setting



The precondition for this setting is that you have made no changes in the DiSEqC (UFO) set-up, refer to the section "DiSEqC (UFO) Set-up".

When you are in the LNB configuration menu (see above), press the   buttons to move the coloured bar to the "HotBird" position, press the  or  button and by pressing  confirm that you wish to add a satellite. The transponder data are now stored and a tick appears after "HotBird" to confirm the setting. You can now set the DiSEqC signal. It serves the purpose of switching between the two

aligned satellites. Press the   buttons to go to the DiSEqC-1 setting.

Set #1 for ASTRA and #2 for HotBird. Both positions are already pre-programmed. You can pre-program up to four satellites (16 settings: 4x H and V as well as 4x High and Low).

Press the  button 4 times to exit the menu. At the same time, the receiver will confirm that the set parameters have been saved. If a setting is incorrect, you will see the following message on the screen:

**Bad or no signal**



*With cascaded switches, a total of 16 satellite positions can be stored under DiSEqC 2. With H/V as well as High/Low this results in a total of 256 settings. You should have a specialist carry out these settings and set-up such a system.*

## Antenna settings

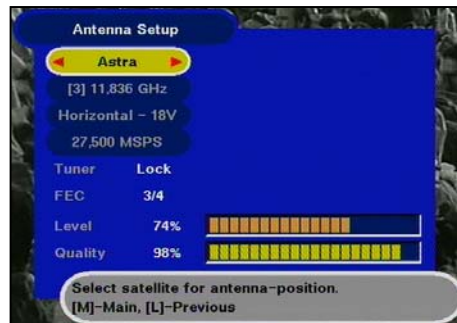

This menu is intended solely for service purposes and, if need be, i.e. if no measuring instrument is available, it can be used to align the antenna (satellite dish).

The satellite can be defined in the first line and the transponder in the second.

The polarisation of the received signal and the transmitted symbol rate are shown in the next line.

The bar displays provide an indication of the strength (relative level) of the signal and its quality. However, no conclusions relating to the quality of the antenna system or of the cable connection can be derived from this signal.

## Satellite search



In the satellite scan menu you can instruct the receiver to search for channels on the

satellite. Use the  or  button to select the required satellite. Start the search by

pressing .

*If you wish to set your system to a completely new satellite, you will need to enter manually at least one known transponder in order to start the search (see Section "TP set-up/scan"). You can obtain the necessary information from the corresponding TV and satellite magazines or Internet pages.*

# Installation menu

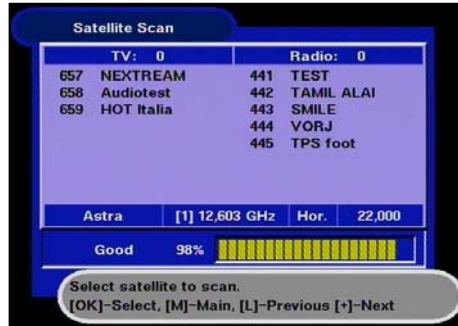

The signal quality and the search progress are indicated during the search.

The message appears at the end of the search.

**The search is complete  
Press (OK) button**

All new programmes are added to the existing programme list.

You can interrupt the search by pressing the **(L)** button.

## TP set-up/search

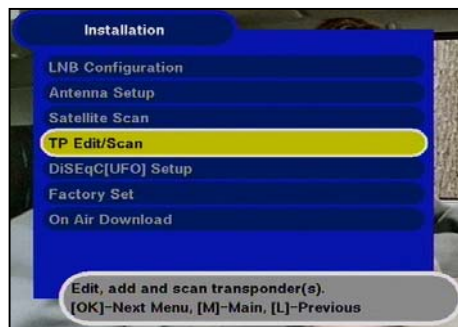

In this menu you can scan through the transponders for specific programmes, e.g. when new programmes are offered in the package of a specific broadcaster. You can obtain this information from SAT 1 teletext or corresponding TV and satellite magazines as well as from the Internet.

Press **(OK)** to open the menu.

## Transponder selection

The following settings are now possible (select positions with **(▲)** **(▼)**):



- Required satellite with **(▲)** or **(▼)**, the transponder frequency with numerical buttons,

- the polarisation with **(-)** or **(+)** button,

- the symbol rate with the numerical buttons and

- search mode for free-to-air or free and encrypted programmes with the **(-)** or **(+)** button.

The bar diagram indicates the relative signal strength and is not an indication for the quality of the receiving system.

Start the search by pressing **(OK)** in the "search" position.



The shown on-screen display appears as the result of the search.

Exit this menu by pressing **(OK)** and go to the previously highlighted programme (here ZDF).

Press the **(L)** to return again to this menu to continue searching for further transponders.

# Installation menu

After an unsuccessful search the following message appears:

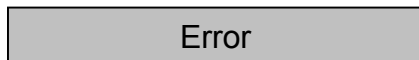

**All new programmes are added to the existing programme list.**

Under the menu item „Delete TP“ you can remove the transponder from the programme memory by pressing . You will be requested to confirm that you wish to remove the transponder before it is deleted.



## DiSEqC (UFO) Set-up

You should only make changes in this menu when the receiver is to be connected to another receiving system with different features or if changes have been made to the receiving system.

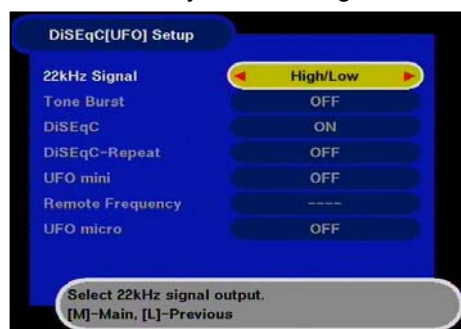

*Therefore, take particular note of the information relating to your Sat-IF system. Before making any changes, you should make a note of these settings on the form provided at the end of this User's Guide.*



Press the menu buttons ,  and  and  to open the DiSEqC menu.

## 22-kHz signal

In this menu point you can determine whether the 22 kHz signal is to be used to switch over between the low and high frequency range of a satellite or between 2 satellite positions.

## Tone-burst and DiSEqC signal

A DiSEqC control signal is necessary if more than four control criteria are required in a receiving system.

Which of the setting options, i.e. tone burst or DiSEqC, is required depends on the components of the receiving system.

Therefore refer to the description of the components (switchover matrices) of the receiving system.





# Installation menu

## Tone burst

Under this menu point, the 22 kHz signal can be set as follows:

Switching statuses of setting:			Switching statuses of setting:			Switching statuses of setting:		
22-kHz signal		→ High/Low	22-kHz signal		→ Pos. A/B	22-kHz signal		→ Pos. A/B
and			and			and		
Tone Burst		→ Pos. A/B:	Tone burst		→ Opt. A/B	Tone Burst		→ High/Low
Low	22-kHz	Off	Pos	Tone burst	22-kHz	Low	Tone burst	0
High	22-kHz	On				High	Tone burst	1
Pos. 1	Tone burst	0	1	0	Off	Pos. 1	22-kHz	Off
Pos. 2	Tone burst	1	2	0	On	Pos. 2	22-kHz	On
			3	1	Off			
			4	1	On			

## DiSEqC

If the receiver is connected to a DiSEqC switchover matrix, you will need to set this menu point to ON.

The switching criteria and the input assignments of the DiSEqC switching matrix must be maintained. Therefore, refer to the description of the switching matrices or contact the installer of the receiving system.



### DiSEqC Repeat

The DiSEqC command must be repeated if the receiver is operated (cascaded) together with a receiving system with two or more series connected DiSEqC switching matrices.

In this case, switch the menu point "DiSEqC repeat" to 1 or 2.

Factory preset: OFF

## UFO mini

The input frequency of the receiver is fixed in a "user-controlled processing system". The signals from the "user-controlled processing system" are transmitted on this frequency. The reception parameters for programme selection are transferred to the receiving system by means of a DiSEqC command and set accordingly.

The relevant setting that needs to be selected depends on the type of "user-controlled processing system".

The setting should be made according to the data provided in the installation instructions for the "user-controlled processing system".



### Remote frequency

If you have set the UFO mini menu point to ON, you will need to set the transmission frequency under this menu point.

Refer to the installation instructions of the "user-controlled processing system" for the set transmission frequency.

It is therefore important that you refer to the information provided in the installation instructions of the "user-controlled processing system".



## UFO micro

The setting under this menu point is also designed for operation of the receiver together with a processing system.

Control and communication between the receiver and the Kathrein UFO micro system takes place on the return of the coaxial cable.

ON must be set under the UFO micro menu point if the receiver is operated together with a UFO micro receiving system.

During installation, the receiving system then assigns a special address to the receiver so that the control instructions that are sent from the receiver to the receiving system for signal selection are also recognised by this system.



## Installation menu

A remote frequency must not be set in this operating mode, because it is defined by the UFO micro system as part of the addressing procedure.

You will need to delete the previously allocated address when using the receiver for the first time together with a UFO*micro* receiving system. You can do this under

the UFOmicro menu point by selecting "Reset" with the  buttons and pressing



The original factory setting is then allocated to the receiver. It must then be reset to ON. The receiver will then receive a new address from the new system.

The pre-programming is not deleted with "Reset".

Preset: OFF.



### Factory setting

Under this menu point, you can reset all the settings to the factory setting by press-

ing .

The factory settings need not necessarily correspond to the settings required for your system!

After the reset, it may be necessary to repeat all settings.



## Installation menu

The connection diagram provided at the end of this User's Guide and the description of the video recorder will show you how you should connect your video recorder to the receiver.

### Recording

In order to make a VCR recording, the satellite receiver must be switched on or the timer must be pre-programmed (see section "Timer settings").

### Playback

For VCR playback, the satellite receiver must be set to "standby" so that the signal route is switched through from the VCR/AUX SCART socket to the TV SCART socket.

You must set the SCART socket of the Sat receiver to "VCR" with the  button for your TV set to automatically play back the picture of the video recorder.



In this setting, the picture of the video recorder is switched through to the TV set during playback.



If you set "SAT" by pressing the  button, the Sat receiver will have priority.





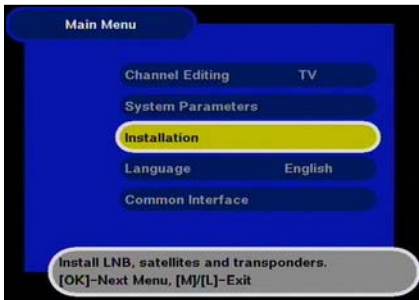

In the "TV" setting, the video signal of the TV set has priority.

# Installation menu



Thanks to digital technology, the software and programme list of your receiver can also be updated via satellite. Find out if a new software or programme list is available under the submenu software download. Your satellite receiving system must be aligned to ASTRA 19,2° east.

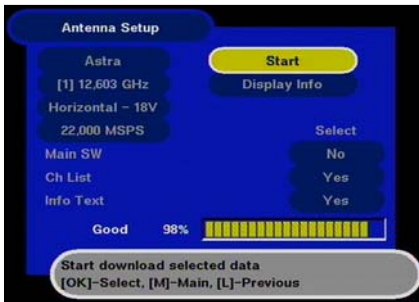

Select the submenu "Installation" with the main menu button , the   buttons and . Move the cursor bar now to the menu item „Software download“ and select it by pressing .





Now, your receiver automatically searches for the ASTRA transponder, which transmits the current software and programme list.

If no new versions exist, you will be notified with an appropriate on-screen display.

The light cursor bar in "Software download" can be moved with the

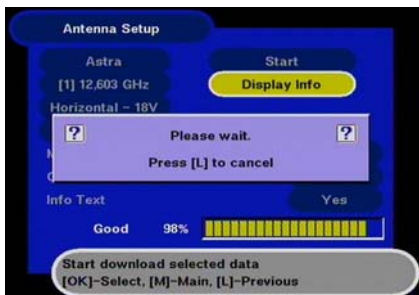
  buttons. Press  in the menu item "Display info" to receive information about the transmitted software and programme list. The menu items "Info text," "programme list" and "operating software" are automatically set to "active," when new information and contents are available. The lower bar displays the relative signal level. You can determine with the light cursor bar which menu item you want to deactivate. Inactive menu items cannot be changed. In the case, that you only update the software, but not the programme list, deactivate the field "programme list" and vice versa.



For updating, move the cursor bar to "Start" and confirm it with . Afterwards, the receiver begins with the update and a message appears on the screen. After the update is complete, the receiver is newly initialised and returns to operation. If an error or incorrect signal occurs, a message appears "Download error".

Never switch the receiver off during the update procedure, or the entire software will be lost. If this should occur, the receiver must be newly installed at the factory or per PC and zero modem cable. During the download, the following message flashes:

„Please wait“



*After the request  
„Display info,“  
the on-screen display appears with the notice of the new software and the respective changes.*

Observe the on-screen display!

After a software update, you must set the time again!

The updates are also available in the internet under the address:  
[www.esc-kathrein.de/download/ufd/](http://www.esc-kathrein.de/download/ufd/).

Here, you will also find instructions for downloading.



# Installation menu

Your receiver is able to accept data from another receiver via the RS232C socket. For this purpose, the two receivers are mutually connected via a zero modem cable. The transmitting receiver is the master, the receiving receiver the slave.

## Preparation

The master and slave are first switched to standby mode and then disconnected from the mains by pressing the power switch.

The data sockets (Item 6, rear of receiver, Page 8) of both receivers are connected with the zero modem cable.

The master is then switched on again.

## Transferring programme lists

Simultaneously press the ← button (arrow left) and SELECT under the front panel of the master to transfer the channel list.

The slave can now be switched on. The transfer procedure begins.

While loading, the display of the master shows "t001 t002 .. t00n" while the slave correspondingly shows "r001 r002..r00n".

The LED display shows "----" during block transfer.

The loading procedure was successful if both receivers show the message "Succ."

## Transferring operating software

Follow the same procedure as described above for the purpose of transferring operating software.

Start transfer of the operating software by simultaneously pressing the → button (arrow right) and SELECT under the front panel of the master.

While loading, the display of the master shows "t001 t002 .. t00n" while the slave correspondingly shows "r001 r002..r00n".

The LED display shows "----" during block transfer.

The loading procedure was successful if both receivers show the message "Succ.". Should transfer problems occur, "F \* \* \*" will appear in the master display where \* stands for a numerical value. In this case, check the cable connection and start a new transfer attempt.



*The data transfer from receiver to receiver as described above must only be carried out with devices of the same type as otherwise malfunctions or total loss of the operating software may occur.*

*On no account must the receivers be switched off or the connection interrupted during data transfer. This may otherwise result in data loss, malfunctions or total failure of the operating system.*

*In all cases wait until the "Succ." or "F \* \* \*" message appears on the display.*

*You can download new operating software as well as a new channel list at our website [www.kathrein.de](http://www.kathrein.de) where you will also find the corresponding instructions. Refer to the section "System information" to establish the status of your receiver.*

## Technical features

The receiver UFD 505 is equipped with the following features:

- Reception of all digital TV channels (free-to-air receiver)
- Reception of all DVB radio channels (free-to-air receiver)
- Loop-through Sat IF input
- Teletext processing for TV set
- 1800 channel memory positions
- Satellite reception frequency range from 950 MHz to 2150 MHz
- Freely selectable oscillator frequencies, therefore suitable for all feed systems
- Timer programmable for 7 events (once/daily/weekly)
- Mains switch with mains separation
- Automatic settings for date and time via DVB data stream
- On-screen display in 9 languages (German, English, French, Greek, Italian, Dutch, Spanish, Turkish, Portuguese)
- 4-digit LED display
- 22 kHz programmable control signal
- DiSEqC 1.1 and tone burst control signal
- Operation with UFOmini and UFOmicro
- LNB supply voltage, disconnectible
- Connection socket for data copying function RS232
- Programme assortment function
- Picture format recognition 4:3 and 16:9 with selectable output format
- Mute feature
- Volume control
- Radio keys
- Infrared remote control
- 2 SCART sockets (TV and VCR/AUX connection)
- Additional audio outputs via Cinch sockets
- Dolby Digital output (AC3)
- RF level display
- EPG (Electronic programme guide)
- Additional information about current programme (Full EPG)
- Software download via satellite

# Technical annex

## Technical data

### RF features

Sat-IF frequency range	950 to 2150 MHz
Input level range	43 to 83 dB $\mu$ V
IF frequency	479,5 MHz
Receiving threshold (Eb/No dig.)	$\leq 4,8$ dB
Sat-IF input	F-socket with loop-through output
Input impedance	75 $\Omega$

### Video

Modulation, FEC, demultiplexer	DVB-S-Standard
Video resolution	CCIR 601 (720 x 576 lines)
Frequency range	20 Hz to 5 MHz
Input data rates	2-45 MSymbols/s
Video decoding	MPEG-1/2- compatible
Bit rate	1.5-15 MB/s
Output voltage	1 V <sub>ss</sub> / 75 $\Omega$
S/N	$\geq 53$ dB typ.

### Audio

Audio decoding	MPEG-1/2, Layers 1 and 2
Bit rate	32/44,1/48 kb/s
Frequency range	40 Hz to 15 kHz
Output voltage	typ. 770 $\pm$ 50 mV an 10 k $\Omega$ (TV-Scart and Cinch)
S/N	$\geq 65$ dB

### Power supply

Mains voltage	230 V $\pm 10\%$ , 50 Hz
Power consumption	<30 W
Power consumption in standby	<9 W
LNB voltage supply	0, +14 V (vert.), +18 V (hor.)
LNB supply current	400 mA max.
Control signals	22-kHz-square-wave 0,6 V <sub>ss</sub> tone burst DiSEqC 1.1 UFOmicro UFOmini

### Connections

TV connection	SCART socket, 21-pin
VCR/AUX connection	SCART socket, 21-pin
Audio output	2 x Cinch socket
Dolby Digital output (AC3)	Cinch-socket
Data interface for service purposes	RS 232 Sub D 9-pin

### General

Dimensions (W/H/D)	335 / 63 / 280 mm <sup>3</sup>
Weight approx.	ca. 2,4 kg

### Temperature range

Ambient temperature	+5 $^{\circ}$ C to + 40 $^{\circ}$ C
---------------------	--------------------------------------



# Technical annex

## Accessories

- 1 Infrared remote control
- 2 Batteries 1.5 V, type: LR 03, size: AAA (Micro)
- 1 SCART cable
- 1 Set of operating instructions

## Scart socket assignments

Signal	Connection no.	TV	VCR/AUX
Audio output, right	1	X	X
Audio input, right	2		X
Audio output, left	3	X	X
Audio earth	4	X	X
Blue earth	5	X	X
Audio input, left	6		X
Blue signal	7	X	X
Switching voltage	8	X	X
Green earth	9	X	X
Data signal	10		
Green signal	11	X	X
Data signal I	12		
Red earth	13	X	X
Data earth	14		
Red signal (C)	15	X	X
Blanking signal	16	X	X
Video earth	17	X	X
Blanking signal earth	18	X	X
Video output (FBAS/Y)	19	X	X
Video input	20		X
Connector shield	21	X	X

## Connection examples

### Connection arrangement 1:

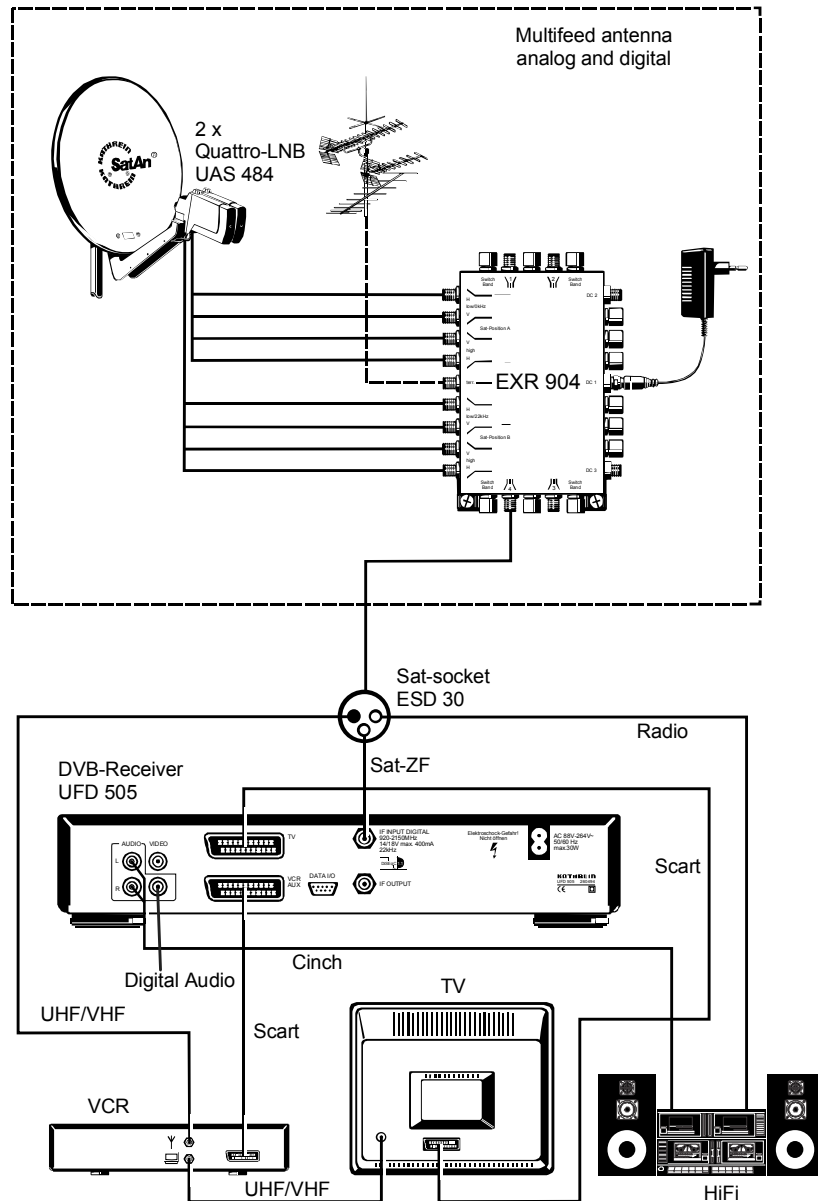

Connection of the DVB-S receiver to a TV set, a VCR and a hi-fi system for receiving and recording digital satellite TV and radio channels. The digital sound output can be connected to a Dolby Digital System.

The connection requires two SCART cables and one Cinch cable. If your TV is equipped for stereo, the stereo sound can also be reproduced via the stereo speakers of your TV set.

The UHF/VHF input of the TV set is connected via the UHF/VHF output and input sockets of the video recorder to the UHF/VHF output of the Sat socket. This connection makes it possible to receive terrestrial regional TV channels with the antenna system correspondingly aligned.

By connecting the antenna input socket of the hi-fi system to the radio output of the Sat socket you can receive terrestrial radio stations.



# Technical annex

## Connection arrangement 2:

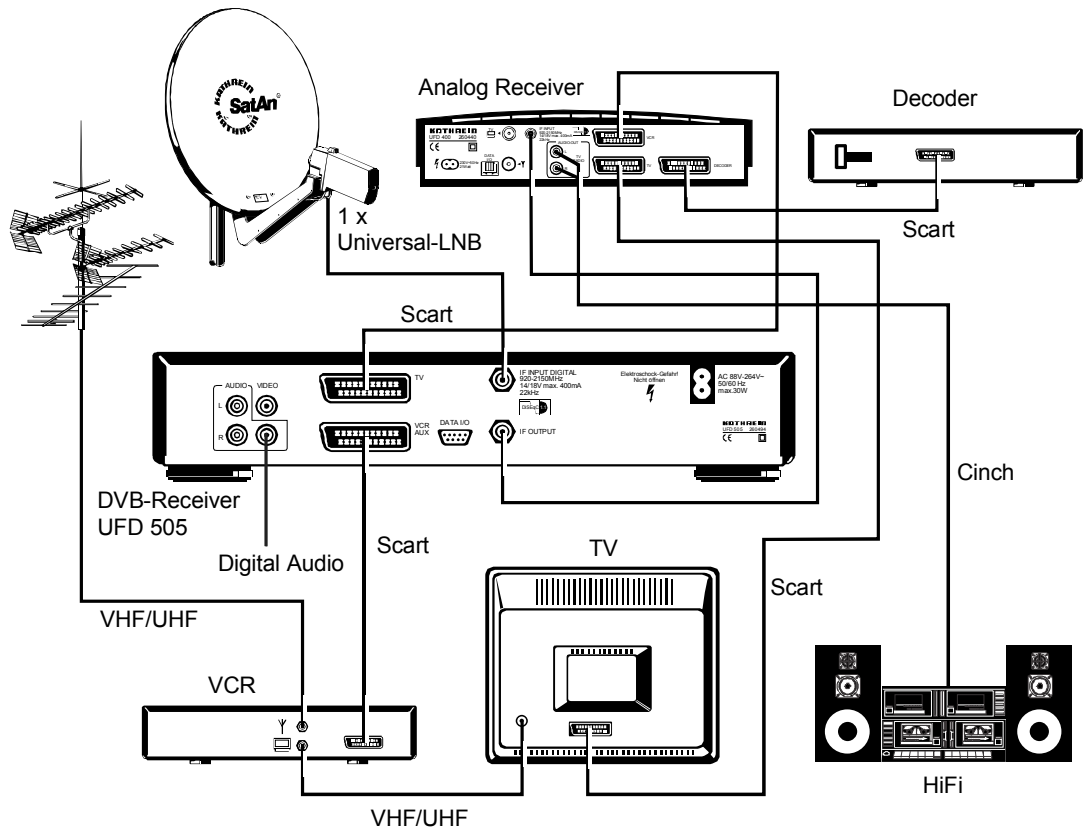

Connection of a DVB receiver to an analogue Sat receiver and the complete TV and hi-fi system. The digital sound output can be connected to a Dolby Digital System.

The roof antenna connected via the video recorder to the TV permits the reception and recording of terrestrial programmes.

## Technical annex

Audio output	Receiver sound output
AV channel slot	Preferential channel location of TV set for SCART input
Decoder	Decoder Unscrambling unit for pay-TV
DiSEqC	Control system between receiver and LNB, multi-switch
DVB	Digital Video Broadcasting
Eb/No [dB]	Power density per unit of information
Eb/No ratio	Digital signal-to-noise ratio
LED-Display	Receiver display
LNB	Low Noise Block Converter
Mute	Mute switch
OSD	On-screen display
PAL	Analogue television standard
Pay-TV	Pay-TV (e.g. DF1, Premiere)
PCMCIA	Standard of internal decoder interface for pay-TV
PIN	Personal identification number
Receiver	Receiver
RGB	Video signals made up of 3 individual colour signals (red, green, blue)
Satellite-IF signal	Receiver input signal
SCART cable	21-pin connecting cable
Standby	Standby
S-VHS	Super Video Home System (Video recorder-Standard)
Symbol rate	Transmitted data rate of satellite signal
Timer function	Clock function for pre-programmed switch-on and switch-off times
Transponder	See glossary
VCR connection	Video recorder connection
Viterbirate	See glossary

## Short technical lexicon

### AC3

Audio Coding MPEG 2/Layer 3 – the coded digital sound signal for Dolby Digital. It transmits 5 sound channels and one reduced sound channel for the subwoofer.

### DiSEqC

DiSEqC (Digital Satellite Equipment Control) is a communication system between the Sat receiver (master) and the peripheral Sat components (slaves), such as LNBS, multi-switch, motorised antenna systems.

This is a single master/multi-slave system, i.e. there is always only one master in the Sat system. All activities emanate from the master.

### DiSEqC components

When DiSEqC switchover matrices are cascaded, the master receiver must send out the DiSEqC signal several times so that all DiSEqC multi-switches in the cascade receive their commands.

Nowadays, DiSEqC components (slaves) must be retrocompatible, i.e. they must also respond to the analogue switching criteria of receivers which are only equipped with the control signals H/V and 22 kHz.

A DiSEqC switchover matrix operates with analogue switching criteria until the DiSEqC command is received from the master. All analogue switching criteria are then ignored.

### DVB MPEG-2

DVB is the abbreviation for digital video broadcasting. DVB-S refers to the type of transmission (S=satellite). MPEG is the abbreviation for Moving Picture Experts Group, a working group which draws up internationally valid standards for the digital compression of video together with audio. MPEG-2 has been promoted to the standard for the compression of digital TV signals. MPEG-2 operates at a data rate of up to 100 MBit/s.

### Eb/No ratio

The Eb/No ratio is a measure for the signal-to-noise ratio of the digital signal. This value is not identical to the C/N value as known from analogue reception technology. As a rule, reception is no longer possible at Eb/No levels below 5 dB.

### FEC

FEC is the abbreviation for Forward Error Correction. The FEC error rate corresponds to the viterbirate.

### PID

The PID number (Package Identification) is an identification number for video signals and audio signals in the digital data stream of DVB MPEG-2 signals. The receiver uses the PID number to establish distinct allocation of the video and audio data transmission. PID-PCR is the identification number for the synchronisation signal. PID-PCR is normally identical to PID video. In the case of multi-language channel transmissions, by means of manual entry of the audio PID, it is possible to allocate another language to the TV broadcast. After entering the PID, the digital receiver automatically selects audio data from the data stream identified by the PID number and allocates these data to the video signal.

### Programme package

The programme package of a digital transponder mostly contains several TV and radio channels. Each channel package has a fixed allocation with regard to the

## Short technical lexicon

transponder transmit frequency, the polarisation (horizontal or vertical), the symbol rate and the viterbrate or error rate.

### Symbol rate

The symbol rate describes the amount of data transmitted per second. The symbol rate is measured in MSymbols/s and is equal to the number of symbols that are received per second.

### Transponder

A transponder is a satellite transmitter which transmits TV and radio signals. A satellite has several transponders.

Analogue transponders transmit only one TV channel and possibly several radio channels on their transmit frequencies.

Digital transponders simultaneously transmit several TV and several radio channels on their transmit frequencies. When a channel provider broadcasts several TV channels via a digital transponder this is referred to as the channel package of the channel provider. The terms "digital transponder" and "channel package" therefore have the same meaning.

### Video bit rate

The video bit rate describes the quantity of data of the digitised video signal that is transmitted per second.

### Viterbrate

The viterbrate (code rate, error rate) characterises the type of error protection used by the channel provider. The DVB standard stipulates the following values:  $1/2$  -  $2/3$  -  $3/4$  -  $4/5$  -  $5/6$   $6/7$  -  $7/8$ .

# Service

## OSD-Language

- German
- 

## Picture format

- 4:3
- 16:9

## LNB supply

- Operation: Standby:
- ON
  - OFF

## Satellite 1

Satellite: \_\_\_\_\_

LO1:  9750 \_\_\_\_\_

LO2:  10600 \_\_\_\_\_

Satellite \_\_\_\_\_

## Satellite 2

Satellite: \_\_\_\_\_

LO1:  9750 \_\_\_\_\_

LO1:  10600 \_\_\_\_\_

Satellite \_\_\_\_\_

## Satellite 3

Satellite: \_\_\_\_\_

LO1:  9750 \_\_\_\_\_

LO1:  10600 \_\_\_\_\_

Satellite \_\_\_\_\_

## DiSEqC menu

- 22-kHz:  High/low  PosA/B  OFF
- Tone burst:  High/low  PosA/B  Opt.A/B  OFF
- DiSEqC  ON  OFF
- DiSEqC repeat  ON  OFF
- UFOMini  ON  OFF
- Remote frequency \_\_\_\_\_ MHz
- UFOMicro  ON  OFF

## Other settings

- 
- 
- 
- 
-

998.6246/1001/ZWT/ Subject to technical changes!

internet <http://www.kathrein.de>

KATHREIN-Werke KG · Telephone (0 80 31) 18 40 · Fax (0 80 31) 18 43 06  
Anton-Kathrein-Straße 1-3 · Postfach 10 04 44 · D-83004 Rosenheim

**KATHREIN**  
Antennen · Electronic

## Free Manuals Download Website

<http://myh66.com>

<http://usermanuals.us>

<http://www.somanuals.com>

<http://www.4manuals.cc>

<http://www.manual-lib.com>

<http://www.404manual.com>

<http://www.luxmanual.com>

<http://aubethermostatmanual.com>

Golf course search by state

<http://golfingnear.com>

Email search by domain

<http://emailbydomain.com>

Auto manuals search

<http://auto.somanuals.com>

TV manuals search

<http://tv.somanuals.com>