

Operating Manual

Satellite / TV / Radio Test Receiver MSK 24



Order No. 208 323

KATHREIN

Antennen · Electronic

Preface

Dear Customer,

Kathrein-Werke KG has made every effort to ensure that this manual is correct and complete. No liability can be assumed for any mistakes that may still be contained in the manual or for any damage resulting from such mistakes.

This manual may not be copied in full or in part nor reproduced nor distributed in any other form without written permission from Kathrein KG.

We reserve the right to make alterations to this manual without prior notice. This applies in particular to alterations required for technical improvement.

All product names and trademarks used in this manual are the property of the relevant companies.

All rights reserved.

Validity of this manual

This manual is valid for MSK 24, order no. 208 323

As of August 2000

Contents

Preface	3
Validity of this manual.....	3
Contents	4
General Notes	6
Explanation of symbols	6
Safety instructions	6
How it operates	7
Overview of functions	8
Block diagram of MSK 24	9
Technical Data	10
Operating and display elements	12
Display elements	12
LC display	12
TFT colour screen	12
Connections (right side)	12
Overview of the keyboard commands	13
Connections	14
RF input socket	14
External DC voltage supply	14
Scart output.....	14
Starting up	15
Switching on the receiver	15
Switching off the receiver	15
Setup menu.....	16
Factory settings	16
Settings in the setup menu.....	16
Calling up the setup menu	16
Mains and battery operation	17
Mains operation	17
Battery operation.....	17
Sat measurement	18
Standard Switch-Over	18
Frequency Display and Entering Frequency	19
Overview of commands in Entering Frequency (SAT)	19
Level Measurement	20
Level Overflow and Underflow.....	20
Tracking Satellites	21
Tracking for Single Frequencies	22
Audio Carrier Frequency	23
LNB Voltage and 22 kHz / 60 Hz Switch-Over.....	24
DiSEqC (Digital Satellite Equipment Control)	26
Overview of commands in Framing Byte.....	27
Overview of commands in Address Byte.....	28
Overview of commands in Command Byte.....	29
Overview of commands in Data Byte.....	31
Simple Tone Burst DiSEqC	31
V-SEC (Vario-Satellite Equipment Control).....	33
TV measurement	34
Standard Switch-Over	34
Channel Display and Entering Channel	35
Frequency Display and Entering Frequency	36
Level Measurement (TV).....	37
Level Overflow and Underflow.....	37
Tracking for Single Frequencies	38
Audio Carrier Distance and Level.....	39
Measuring the Audio Carrier Distance and Level of Nicam Audio Carriers:.....	40
NICAM – Measuring Audio Bit Error Rates	40
Calling up Measuring Audio Bit Error Rates:	40

Contents

FM measurement	41
Frequency Display and Entering Frequency	41
Level Measurement	41
Level Overflow and Underflow.....	41
Tracking for Single Frequencies	42
Spectrum measurement	43
Sat Spectrum	43
TV Spectrum	43
FM Spectrum.....	44
Maintenance	45
Changing the battery.....	45
Customer service.....	45
Technical Appendix	46
Signal-to-noise distance.....	46
DiSEqC commands for Kathrein matrices	47
Command set for Kathrein matrix 9xx-series	47
Command set for Kathrein matrix EXR 20.....	47
Command set for Kathrein matrix EXR 22.....	47
Channel tables	48
Channel and frequency table for B/G standard (frequency in MHz).....	48
Channel and frequency table for L standard (frequency in MHz).....	49
Channel and frequency table for D/K standard (frequency in MHz).....	50
Channel and frequency table for I standard (frequency in MHz).....	51
Channel and frequency table for M1 Japan standard (frequency in MHz).....	52
Channel and frequency table for M/N standard (frequency in MHz).....	53
Channel and frequency table for M/N standard (frequency in MHz).....	54
Notes	55

General Notes

This manual has been written for persons with a basic knowledge of electrical engineering. At every step users who have already worked with measuring instruments can find the necessary commands in an overview. In addition, the following examples help to explain the operating steps.

Explanation of symbols



Instructions shown with the warning symbol must be observed as otherwise the MSK 24 may be damaged or destroyed.



This symbol provides information on measuring functions and refers you to chapters containing further information on a subject.



This symbol is followed by an example of the measuring function just explained.



Here you will find an overview of the commands for the button combinations for the relevant measuring function.

[Button]

The button to be pressed on the receiver.

Safety instructions



Always observe VDE safety regulations!

Use only fuses that have the same cutout characteristics.

Observe the following upper limits when supplying signals:

- HF input: max. 120 dB μ V (60dBmV)
- Do not apply a DC voltage >22 V to the HF socket
- Do not apply a low-frequency AC voltage to the HF socket

The receiver is also live when disconnected.

Use only the power supply unit supplied to power the MSK 24.

A voltage of between 10 V and 20 V is available at the RF input socket depending on the programming. The source can supply up to 500 mA.

Parts supplied

- 1 plug-in power supply unit
- 1 BNC measuring cable
- 1 adapter for BNC socket to F socket
- 1 adapter for BNC socket to F plug
- 1 adapter for BNC socket to IEC socket
- 1 adapter for BNC socket to IEC plug

How it operates

The MSK 24 is designed as a universal portable test receiver for TV, SAT and FM radio for both battery and mains operation. A built-in lead battery with 2.8 Ah and a plug-in power unit for 230 V AC are included with the receiver.

A microcontroller is responsible for controlling the unit, scanning the keyboard and displaying frequency and level on the LC display. Receiving frequencies are indicated in MHz. Levels are measured with a peak or average value detector and indicated digitally in dB μ V or dBmV. Correction values are determined when levels are calibrated for the MSK 24. They are stored in an EEPROM. Precise level measurements can thus be made.

There is a bar display on the front display to help find transmitters. In addition, there is an audio tracking signal to facilitate aligning of the antenna as the display does not have to be observed.

The audio section with its built-in loudspeaker is capable of processing and reproducing various audio frequency satellite signals, audio frequency TV signals complying with the B/G, D/K, I, M1 (Japan) and M/N standards, as well as FM audio. NICAM and AM audio reproduction (L standard) is also possible.

All currently known requirements are covered thanks to an LNB supply voltage of 10-20 V / max. 500 mA with steps of 0.1 V, the superimposition of 22 kHz / 60Hz and the facility of sending DiSEqC or V-SEC commands.

The built-in TFT colour screen allows pictures to be assessed locally.

Overview of functions

Function	SAT mode	TV mode	FM mode
Mains and battery operation	*	*	*
Level measurement by entering frequency	*	*	*
Level measurement by entering channel		*	
Level-dependent acoustic signal	*	*	*
Loudspeaker for acoustic check	*	*	*
Reception of multiple standards (B/G, D/K, I, L, Nicam, M/N, M1) Nicam audio reception and L standard	*	*	*
Audio carrier setting	*	*	
Audio carrier measurement		*	
Adjustable LNB voltage supply LNB current measurement	*		
22 kHz / 60 Hz switch-over	*		
DiSEqC, V-SEC	*		
DVB measurement (QPSK, QAM)	*	*	
Scart output (video and audio)	*	*	* (audio only)
Nicam audio, reception and bit error rate measurement		*	

Block diagram of MSK 24

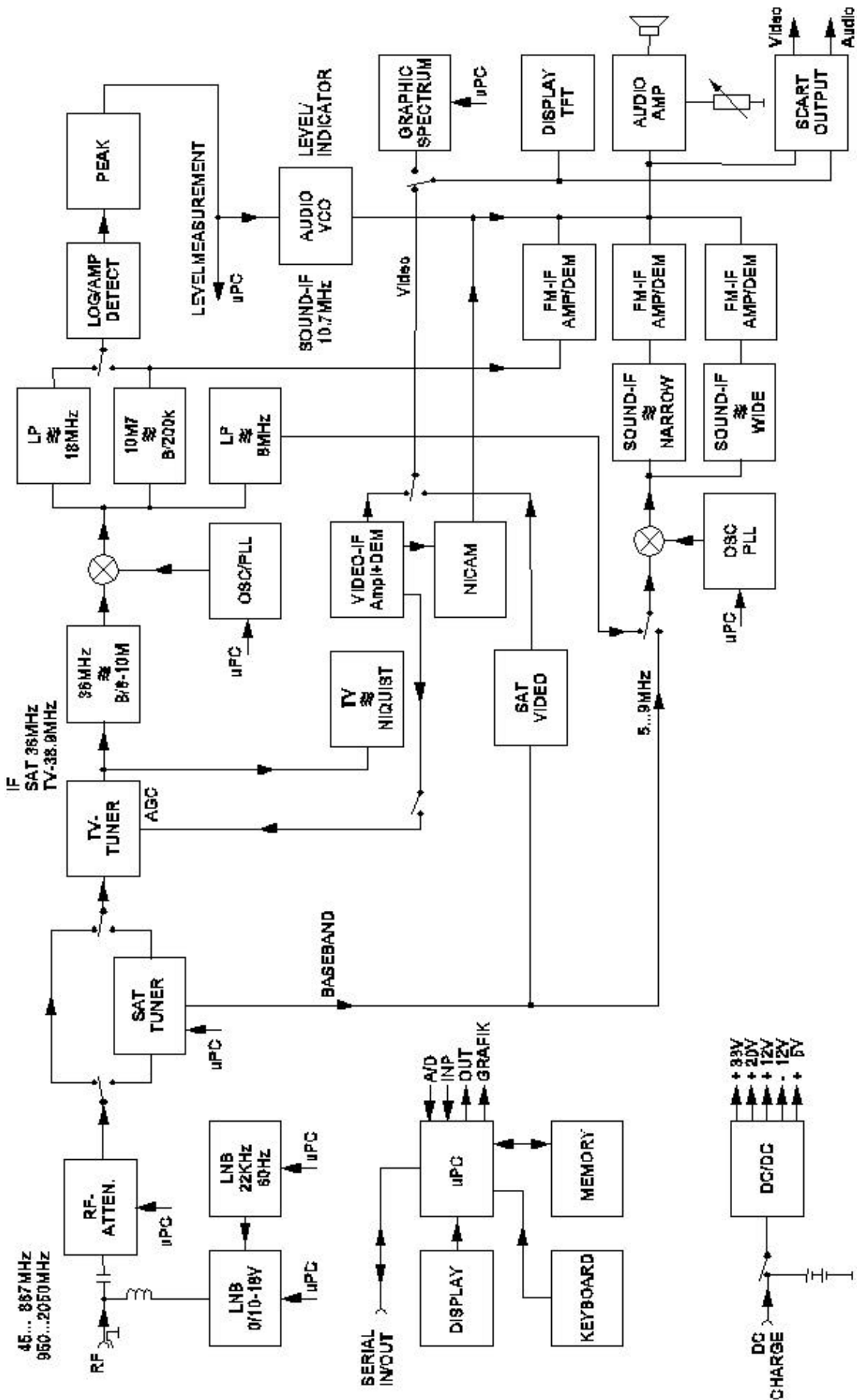

Technical Data

Power supply		230 VAC 50/60 Hz		
Mains operation		12 V / 2.8 Ah lead battery		
Battery operation				
Capacity				
Dimensions		width 260 mm, height 90 (120) mm, depth 165 mm incl. accessories (plus bag)		
Weight		4 kg (incl. bag)		
Safety standards		CE label Protection class II VDE EN61010		
Display		TFT screen, alphanumerical LCD with 2 x 16 characters, bar display, background illumination		
Temperature range		+5 °C to +45 °C		
Frequency range	SAT TV FM	920 MHz...2150 MHz 45 MHz...867 MHz 88 MHz...108 MHz (45 MHz...867 MHz)		
Channel allocation	TV	B standard D/G/I/K standard M/N/M1 standard	7 MHz 8 MHz 6 MHz	
Frequency tuning	SAT TV FM	in 0.125 MHz steps in 50 kHz steps in 50 kHz steps		
Measuring errors	SAT TV/FM	max. ±2 dB max. ±2 dB		
RF input		coaxial socket, BNC, 75Ω		
RF input separator		0 – 60 dB in 4 dB steps		
Level measurement range		30 dB _i V – 120 dB _i V		
Measuring bandwidth	SAT TV FM	6 MHz 250 kHz 250 kHz	SAT DVB TV DVB	6 MHz 6 MHz
Measuring detector	SAT TV FM	average value display peak value display average value display		
Return loss		>6 dB		
FM threshold	SAT	<9 dB		
Audio IF bandwidth	SAT TV FM	230 kHz / 150 kHz 230 kHz 230 kHz		
Audio deemphasis	SAT TV/FM	50 μs 50 μs		

Technical Data

Audio processing	SAT	FM audio processing	5.0 MHz...8.99 MHz in steps of 10 kHz
	TV	FM + Nicam in quasi parallel audio mode AM in parallel mode (only L standard)	
	TV	B/G standard	Audio carrier 1 = 5.5 MHz, Audio carrier 2 = 5.74 MHz
		D/K standard	Audio carrier 1 = 6.5 MHz, Audio carrier 2 = 6.26 MHz
		I standard	Audio carrier 1 = 6.0 MHz
		M/N standard	Audio carrier 1 = 4.5 MHz, Audio carrier 2 = 4.72 MHz
		M1 standard	Audio carrier 1 = 4.5 MHz
		L standard	AM 6.5 MHz. Nicam = 5.85 MHz
		B/G standard	Nicam = 5.85 MHz
		I standard	Nicam = 6.552 MHz
	FM	FM audio processing	45 MHz...867 MHz
Audio carrier measurement	TV	B/G standard	5.5 MHz, 5.74 MHz, 5.85 MHz
		D/K standard	6.5 MHz, 6.26 MHz
		I standard	6.0 MHz, 6.552 MHz
		L standard	6.5 MHz, 5.85 MHz
		M/N standard	4.5 MHz, 4.72 MHz
		M1 standard	4.5 MHz
Nicam decoder			
Audio carrier distance	TV	5.58 MHz with B/G, D/K, and L standards 6.552 MHz with I standard	
Nicam bit error rate	TV	0 - 4 x 10 ⁻²	
LNB voltage supply	SAT	0, 10 V...20 V, max. 500 mA	
LNB control	SAT	22 kHz, 60 Hz, DiSEqC, Simple DiSEqC, V-SEC	
Scart output		1 V _{SS} / 75 Ohm	

Operating and display elements

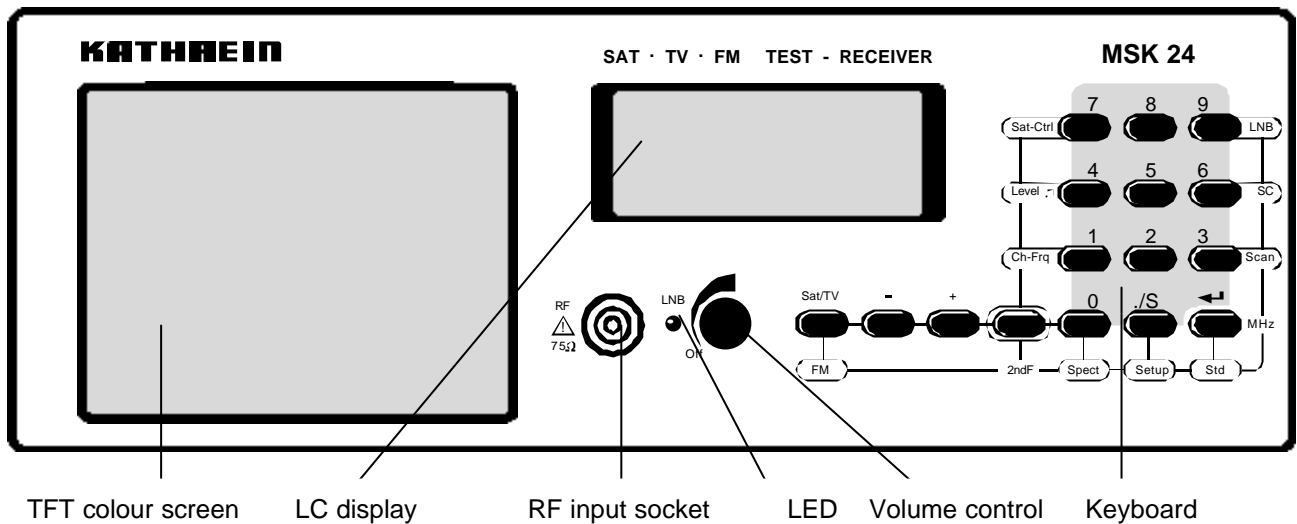

Display elements

LC display

Depending on the mode the following information is shown in the LC display:

- the set channel,
- the set frequency,
- the function called up,
- the mode,
- the level measured and
- the measured values.

FR: 954.0 MHz	SAT
LEV: 40.0 dBuV	

TFT colour screen

The colour screen has a diagonal of 4" and a resolution of 238 x 480 pixels. The light intensity is 250 cd/m².

Connections (right side)

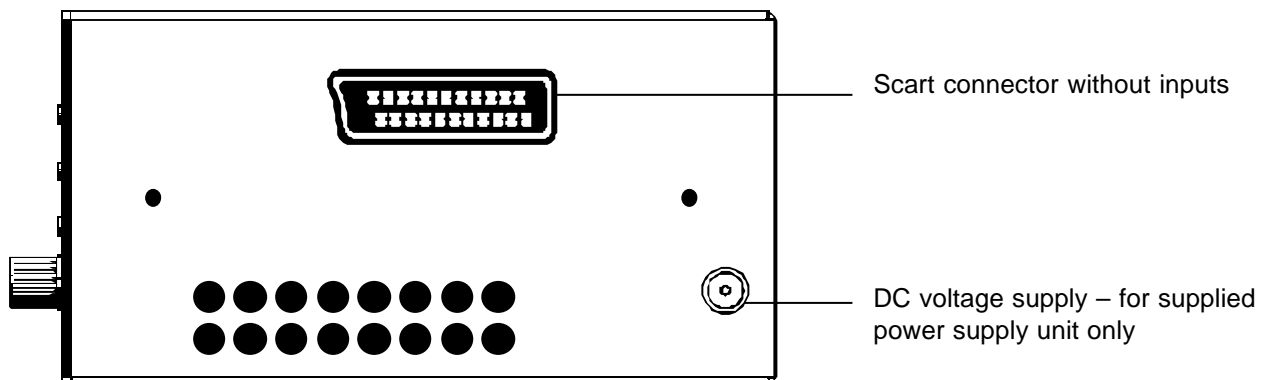

Overview of the keyboard commands

Button	Brief description of the function for		
	SAT	TV	FM
SAT/TV	Switch-over to TV reception	Switch-over to SAT reception	Switch-over to SAT reception
-	Decrease current values		
+	Increase current values		
0...9	Enter numbers		
.S	Decimal point for numerical entries	<ul style="list-style-type: none"> Decimal point for numerical entries Call up special channel 	Decimal point for numerical entries
ENTER	Confirm numerical entries		

2ndF + button	Call up second command level		
FM	Switch-over to FM		No function
Sat-Ctrl	Call up the DISEqC/ V-SEC menu / LNB	No function	
LNB	LNB voltage menu and current measurement		
Ch-Freq	No function	<ul style="list-style-type: none"> Call up the frequency menu Switch-over from channel to frequency display and vice versa. 	
Std	DVB/analogue switch-over	<ul style="list-style-type: none"> DVB/analogue switch-over Standard switch-over 	
SC	(Subcarrier) Audio carrier menu		
Scan	Search for a satellite irrelevant of frequency		
Level	Switch on level-dependent acoustic signal with bar display		
Spect	Spectrum analysis		
Setup	Define receiver settings		

Keyboard of MSK 24:

See above for details

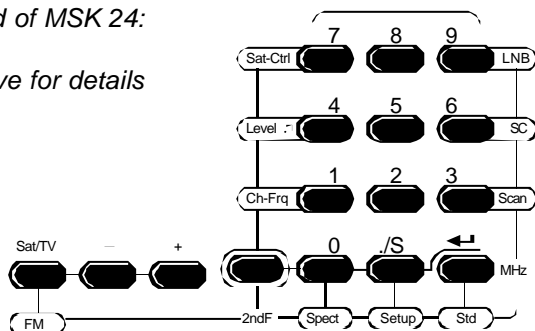

Connections

RF input socket

The signal received from the antenna system or the cable network is fed in here (BNC coaxial socket).

The remote powering voltage (for LNB) can be adjusted from 10 to 20 V_{DC} and can be switched off. When the LNB voltage is switched on, the LED next to the RF input socket lights up.

Make sure that there is

- no voltage level over 120 dB μ V,
- no positive DC voltage over 22 VDC,
- no negative DC voltage and
- no AC voltage.

on the RF input socket.

The input circuit can be seriously damaged if this warning is not heeded.



External DC voltage supply

The MSK 24 can be powered from the mains or its built-in battery. Voltage is supplied externally from the supplied power supply and recharging unit through the DC socket on the right side of the housing of the MSK 24.

Make sure that

- only the supplied power supply unit is used,
- the power supply unit is only connected to the receiver when it is to be used to supply power. Otherwise the battery of the MSK 24 will be discharged!



Scart output

The visual and audio signals are available at the Scart socket on the right side of the MSK 24 for assessment on an external monitor.

No outputs are available!



Wrongly wired connectors may damage or destroy the receiver.

Starting up

Switching on the receiver

- Connect the receiver with the battery charger/power supply unit to the mains supply.
- Turn the on/off switch towards the right.
- Set the desired volume.

Software V1.0
SN: 000222

The LC display shows the software version and serial number of the MSK 24 for approx. 1 second.

ACCU []

Then the LC display indicates the capacity of the battery for approx. 3 seconds.

One segment is equivalent to approx. 20% of the total capacity (2.8 Ah).

Now apply the receiving signal from the receiver system into the RF input socket.

CH: .02. TV
LEV: 48.5dBuV

LC display:

- channel
- mode
- level.

Use the **[TV/SAT]** button to select the required mode.

Switching off the receiver

Turn the on/off switch towards the left.

Starting up

Setup menu

The default setting (status of the MSK 24 when it is switched on) can be set in the setup menu.

Factory settings

Parameter	Setting
POWER ON	TV
LNB DC	OFF
LEVEL	dB μ V
Low Level Mute	ON

Settings in the setup menu

Calling up the setup menu

Press the **[2ndF]** and **[SETUP]** buttons.

POWER ON
TV=1 SAT=2 FM=3

Press button **[1]**, **[2]** or **[3]** to select the appropriate TV, SAT or FM mode. Press **[ENTER]** to retain the current setting.

1. Setup menu

LNB DC
OFF=1 ON=2

The following request appears:

Press button **[1]** or **[2]** to switch the LNB voltage supply on or off. Press **[ENTER]** to retain the current setting.

2. Setup menu

Level
dB μ V=1 dBmV=2

In the next menu press button **[1]** or **[2]** to set the measuring unit in which the level should be displayed. Press **[ENTER]** to retain the current setting.

3. Setup menu

CH: .07. TV
LEV: ____ dB μ V

In the next menu you are requested to set the mute function by pressing button **[1]** or **[2]**. Select "ON" to mute the MSK 24 as long as the input signal on the RF input is below 30 dB μ V.

4. Setup menu

LOW LEVEL MUTE
OFF=1 ON=2

Press **[ENTER]** to retain the current setting.

If you have not altered the factory default setting, the information shown on the left is displayed.

Default setting

As soon as you have set the low level mute, setup menu 4 is exited automatically and the default setting displayed.

Starting up

Mains and battery operation

The MSK 24 can be powered from the mains or the built-in battery.

Mains operation

Use only the battery charger/power supply unit supplied for mains operation. Connect the power supply unit to the voltage supply socket on the right side of the receiver.

If the receiver is not used for long periods, connect the receiver to the mains supply now and then (maintenance charging).

Make sure that the power supply unit is not connected to the receiver if it is not to be used to supply voltage as otherwise the battery will be discharged.

Battery operation

Battery operation is only possible if the battery is sufficiently charged. Otherwise the MSK 24 cannot be switched on.

If the battery has been fully discharged, recharge it immediately as otherwise it may be damaged or destroyed.

Charging begins automatically as soon as the receiver has been connected to the mains supply. A protective circuit prevents the battery from being overcharged.

The capacity of the battery is displayed for approx. 3 seconds after the receiver has been switched on.

With a charged battery the maximum period of operation is approx. 2.5 hours for an LNB supply current of 150 mA.

Sat measurement

Standard Switch-Over

In the SAT mode the MSK 24 can be set to receive the following types of signal:

- analogue and
- digital (DVB).

Overview of commands in Standard Switch-Over in SAT



[2ndF] [STD] Call up standard switch-over menu:

[1]...[2] Select the standard

1 = analogue

2 = digital (DVB)

Example



Call up digital (DVB) standard:

Press **[2ndF] [STD]**

LC display:

- 1 = analogue standard
- 2 = digital (DVB) standard

1=ANALOG 2=DIGITAL(DVB)
--

Standard menu

FR:1288.0MHz	SAT
LEV: 66.5dBuV	D

Display for DVB measurement

If you press button **[2]**, you will leave the standard menu and the receiver will be set to DVB measurement.

A "D" appears in the display.

Sat measurement

Frequency Display and Entering Frequency

To measure the level of a received signal, you must first enter the desired frequency. The LC display shows the frequency and the measured level. You can enter frequency values from 920 MHz to 2150 MHz in steps of 100 kHz.

Overview of commands in Entering Frequency (SAT)



[SAT/TV] Switch over to SAT reception

[0]...[9] Enter frequency

[+] [-] You can alter frequency in steps of 100 kHz

[ENTER] Confirm entry

FR:1288.0MHz	SAT
LEV: 66.5dBuV	

LC display:

- Frequency: 1288 MHz
- Mode: SAT
- Level: 66.5 dB μ V

Example

Enter frequency 1508 MHz

Press **[1] [5] [0] [8] [ENTER]**

FR:1508.0MHz	SAT
LEV: 86.5dBuV	

LC display:

- Frequency: 1508 MHz
- Mode: SAT
- Level: 86.5 dB μ V

A + or – in the display means that MSK 24 has not been tuned in exactly to the desired carrier. Use the **[+]** and **[-]** buttons to adjust the frequency for the best possible reception. When a vertical line appears in the display, the frequency has the best possible setting.

Note



Press **[ENTER]** to complete the frequency entry.

The last frequency setting is retained even when the MSK 24 is switched off provided it was made using "numerical entries" and concluded with "MHz".

Sat measurement

Level Measurement

Once you have set a frequency, the level is measured automatically and displayed in dB μ V or dBmV (depending on the basic configuration) on the LC display. The input level can be measured in the range of 30 dB μ V to 120 dB μ V (-30 dBmV to 60dBmV).

LC display:

FR:1508.0MHz	SAT
LEV: 86.5dB μ V	

- Frequency: 1508MHz
- Mode: SAT
- Measured level: 86.5dB μ V

Level Overflow and Underflow

FR:1508.0MHz	SAT
LEV: __. __dB μ V	

The LC display indicates unterflow at a level <30 dB μ V, e.g.

- Frequency: 1508 MHz
- Mode: SAT
- Level: underflow

FR:1508.0MHz	SAT
LEV: dB μ V	

The LC display indicates overflow at a level >120 dB μ V.

The following information appears in the display:

- Frequency: 1508 MHz
- Mode: SAT
- Level: overflow

Note



Levels of DVB-S signals can be measured in the digital reception setting only.

Sat measurement

Tracking Satellites

The "SCAN" function can search for satellites whose exact transponder frequencies are unknown. The frequency range from 1000 to 2100 MHz is scanned continuously to detect signals. If signals are received, the reception level is indicated in a bar display. The measuring range can be set to three different sensitivity levels.

The level can be monitored with an audio tracking signal, the volume being proportional to the level of the signal received. The volume of the audio tracking signal can be set with the volume control.

Overview of commands in SCAN



[2ndF] [SCAN] Switch over to SCAN operation.

[-] [+] Change the measuring range of the bar display.

Level range 1: high input level

Level range 2: medium input level

Level range 3: low input level

Exit SCAN by pressing **[2ndF]** twice.

LC display:

- Level range 2: medium input level
- SAT mode
- Bar display

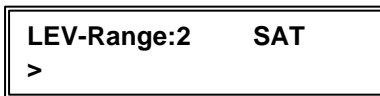

Example



Calling up the SCAN function

- Press the **[2ndF]** and **[SCAN]** buttons.
- Rotate the antenna until a level tendency is visible on the bar display.
- Rotate the antenna until the bar display has reached its maximum.
- If necessary, decrease or increase the sensitivity with the **[-]** and **[+]** buttons.

Exit SCAN by pressing **[2ndF]** twice.

Sat measurement

Tracking for Single Frequencies

In the "LEVEL" function you can align an antenna by tracking to receive the maximum signal. The level tendency can be indicated in the bar display. The measuring range can be set to three different sensitivity levels.

The level can be monitored with an audio tracking signal, the volume being proportional to the level of the signal received. The volume of the audio tracking signal can be set with the volume control.

Overview of commands in Tracking



[2ndF] [LEVEL] Switch over to the tracking mode

[-] [+] Change the measuring range of the bar display. The measuring range is preselected automatically.

Level range 1: high input level

Level range 2: medium input level

Level range 3: low input level

Exit the LEVEL mode by pressing **[2ndF]** twice.

LC display:

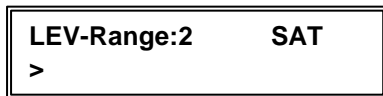

- Level range 2: medium input level
- SAT mode
- Bar display

Example



Call up the "LEVEL" function.

Press the **[2ndF]** and **[LEVEL]** buttons.

Rotate the antenna until the maximum bar display is reached.

If necessary, decrease or increase the sensitivity with the **[-]** and **[+]** buttons.

Repeat this procedure until you have reached the maximum level.

Exit the LEVEL menu by pressing **[2ndF]** twice.

Sat measurement

Audio Carrier Frequency

A video signal has several audio carrier frequencies assigned to it. With the MSK 24 you can select the main carrier and subcarrier frequencies to hear them separately. The audio carrier frequency can be set in steps of 10 kHz from 5.0 MHz to 8.99 MHz. The audio carrier bandwidth is automatically switched over from "wide" (280 kHz) to "narrow" (150 kHz) at 7.00 MHz

The following factory settings for the audio carrier frequencies are stored in the receiver when it leaves the factory:

Button	Frequency in MHz	Bandwidth in kHz
[1]	5.80	280
[2]	6.50	280
[3]	6.65	280
[4]	7.02	150
[5]	7.20	150
[6]	7.38	150
[7]	7.56	150
[8]	7.74	150
[9]	7.92	150

Overview of commands in Audio Carrier Frequencies (SAT)



- [2ndF] [SC] Call up audio carrier menu
- [1]...[9] Select audio subcarrier
- [-] or [+] Change audio carrier frequency in 10 kHz steps
- [ENTER] Manually switch audio carrier bandwidth
wide = 280 kHz, narrow = 150 kHz

Exit audio carrier menu by pressing [2ndF] twice.

Example

Call up audio carrier with 7.38 MHz



Press [2ndF] [SC] [6]

LC display:

SC: 7.38MHz	SAT
BW:NARROW	

- Audio subcarrier: 7.38 MHz
- Audio carrier bandwidth: narrow = 150 kHz
- Mode: SAT

Note



After the SAT mode has been called up, the MSK 24 is always set to the audio carrier 7.02 MHz. Changes made to the frequency of the audio carrier are only retained until you exit the SAT mode.

Sat measurement

LNB Voltage and 22 kHz / 60 Hz Switch-Over

The LNB supply voltage is available at the RF socket. This is confirmed by the LED next to the RF socket which lights up when the voltage supply is switched on. The current consumed by the connected LNB is indicated in the LC display.

The 22 kHz or 60 Hz square wave signal that can be added is superimposed on the LNB voltage. It is needed to switch multifeed systems or high/lowband LNBs.

The LNB voltage can be

- switched off = 0V
- set from 10 V to 20 V in steps of 0.1 V
- short-circuit protected (max. current 500 mA)

The following voltages can be called up by pressing the relevant button:

LNB voltage	Button
0V	[0]
12V	[1]
14V	[2]
18V	[3]

Overview of commands in LNB Voltage



- [2ndF] [LNB]** Call up the LNB menu
- [0]...[3]** Select the LNB voltage
- [-] or [+]** Change the LNB voltage in 0.1 V steps
- [7]** 60 Hz signal on/off
- [8]** 22 kHz signal on/off

Exit the LNB menu by pressing **[2ndF]** twice.

Example



Call up the LNB voltage 14 V:
Press buttons **[2ndF] [LNB] [2]**

LNB:14,0V 150mA

LC display:

- LNB voltage: 14 V
- Current consumption: 150 mA

Note



By pressing the **[+]** or **[-]** buttons you can change the LNB voltage in steps of 0.1 V.

By calling up another function, e.g. **[2ndF] [CH-FRQ]**, you can exit the LNB menu automatically.

Sat measurement

Example



Switch on the 22 kHz signal.

Press button **[8]**.

LNB:14,0V	22kHz
150mA	

LC display:

- LNB voltage 14 V
- Current consumption 150 mA
- The 22 kHz signal is switched on.

Note



By pressing button **[8]**, you can switch off the 22 kHz signal.

By calling up another function, e.g. **[2ndF] [CH-FRQ]**, you can exit the LNB menu automatically.

Sat measurement

DiSEqC (Digital Satellite Equipment Control)

The DiSEqC system is used to control systems with extended control facilities. DiSEqC uses serial, bidirectional transmission with one master and one or more slaves. The data bits are formed by modulation of the pulse width of the available 22 kHz carrier and are superimposed with 600 mV_{ss} of the LNB remote voltage. The digital code words are made up of 8 data bits and one additional parity bit to detect transmission errors. Several code words form a DiSEqC command. Input of the code words is in hexadecimal code.

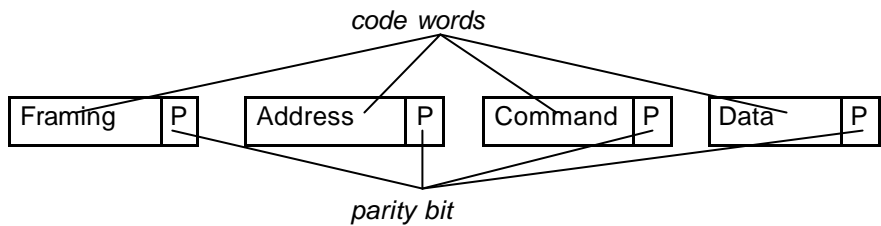

The MSK 24 can also transmit signals to DiSEqC 1.0 but it cannot receive them.

Overview of commands in DiSEqC



[2ndF] [SAT-CTRL] Call up the DiSEqC menu

[0]...[9] Enter the code words in hexadecimal code 0...9

[.] [0]...[5] Enter the code words in hexadecimal code A...F

Button	Hex Code
[.] [0]	A
[.] [1]	B
[.] [2]	C
[.] [3]	D
[.] [4]	E
[.] [5]	F

[-] or [+] Move the cursor among the various code words: Framing, Address, Command and Data

[.] [6] Delete the entire command string up to the cursor position

[ENTER] Send the command string

Exit the DiSEqC menu by pressing **[2ndF]** twice.

Sat measurement

Example



You want to test the Kathrein matrix EXR 22. The command set for the matrix EXR 22 is E0 00 24 (LNB High) and E0 00 20 (LNB Low).

SAT-CTRL	LNB=1
V-SEC=2	DiSEqC=3

SAT-CTRL menu

Call up DiSEqC:

Press buttons **[2ndF] [SAT-CTRL]**

Press button **[3]** to call up the DiSEqC control.

DiSEqC-Framing

You can now enter the data bits for each code word using the buttons **[0]** to **[9]** and **[./S]**. Send the control command by pressing **[ENTER]**. The **>** symbol indicates that the control command has been sent.

DiSEqC-COMMAND
E0 00 24 >

DiSEqC menu

The command set to control the Kathrein matrix EXR 22 has been entered and sent.

Note



You can find the DiSEqC command sets for the Kathrein matrices EXR 20, EXR 22 and the 9xx series in the Technical Appendix.

Overview of commands in Framing Byte



HEX Byte	Description
E0	Command from master, single transmission
E1	Command from master, repetitive transmission
E2	Command from master, answer expected, first transmission
E3	Command from master, answer expected, repeated transmission
E4	Answer from slave, "OK", no error detected
E5	Answer from slave, command not supported by slave
E6	Answer from slave, parity error detected
E7	Answer from slave, command not detected

Sat measurement

Overview of commands in Address Byte



Hex byte	Description
00	All equipment
10	Every LNB, matrix or SMATV
11	LNB
12	LNB with loop-through
14	Matrix (switcher)
15	Matrix (switcher) with loop-through
18	SMATV
20	Every polarizer
21	Maximum rotation (full skew) with lineal polarization
22	Set polarizer in steps
30	Every positioner
31	Polar / Azimuth positioner
32	Elevation positioner
33	Combined positioner
34	LNB positioner
40	Installation help
41	Help to set signal strength
60	Reserved for allocated addresses
70	"Intelligent slave interface" for "Proprietary multi-master bus"
71	Interface for users and checked head stations
Fx	OEM expansion

Sat measurement

Overview of commands in Command Byte



The MSK 24 can send commands in accordance with DiSEqC 1.0 but it cannot receive them. All commands that require DiSEqC 2.0 (to send and receive) are shown in **grey** in the table.

Commands shown in bold type are used preferentially for Kathrein switching matrices.

Hex byte	Command	Description	Number of data bytes
00	Reset	Reset DiSEqC microcontroller	-
01	Clr Reset	Clear reset flag	-
02	Standby	Switch off the peripheral power supply unit	-
03	Power on	Switch on the peripheral power supply unit	-
04	Set Content	Set the contention flag	-
05	Contend	Feedback only if the contention flag has been set	-
06	Clr Content	Clear contention flag	-
07	Address	Feedback only if the contention flag has not been set	-
08	Move C	Change address if contention flag has been set	1
09	Move	Change address if contention flag has not been set	1
10	Status	Read status register flags	-
11	Config	Read configuration flags	-
14	Switch 0	Read switching status flags (Committed Port)	-
15	Switch 1	Read switching state flags (uncommitted port)	-
16	Switch 2	Expansion option	-
17	Switch 3	Expansion option	-
20	Set LO	Call up the low local oscillator frequency	-
21	Set VR	Call up vertical polarization or circular polarization with right rotation	-
22	Set Pos A	Select satellite position A	-
23	Set S0A	Select switch option A	-
24	Set Hi	Call up the high local oscillator frequency	-
25	Set HL	Call up vertical polarization or circular polarization with left rotation	-
26	Set Pos B	Select satellite position B	-
27	Set S0B	Select switch option B	-
28	Set S1A	Call up matrix S1 input A (input B inactive)	-
29	Set S2A	Call up matrix S2 input A (input	-

Sat measurement

		B inactive)	
2A	Set S3A	Call up matrix S3 input A (input B inactive)	-
2B	Set S4A	Call up matrix S4 input A (input B inactive)	-
2C	Set S1B	Call up matrix S1 input B (input A inactive)	-
2D	Set S2B	Call up matrix S2 input B (input A inactive)	-
2E	Set S3B	Call up matrix S3 input B (input A inactive)	-
2F	Set S4B	Call up matrix S4 input B (input A inactive)	-
30	Sleep	All bus commands are ignored except for "Awake".	-
31	Awake	Bus commands are accepted again.	-
38	Write N0	Set port group 0	1
39	Write N1	Set port group 1	1
3A	Write N2	Expansion option	1
3B	Write N3	Expansion option	1
40	Read A0	Read analogue value A0	-
41	Read A1	Read analogue value A1	-
48	Write A0	Set analogue value A0	1
49	Write A1	Set analogue value A1	1
4F	Write A7	Set analogue value A7	1
50	LO string	Read current frequency	-
51	LO now	Read current frequency (table entry number)	-
52	LO Lo	Read Lo frequency table entry number	-
53	LO Hi	Read Hi frequency table entry number	-
58	Write Freq	Write channel frequency	2 or 3
59	Ch.No.	Set the selected channel number (receiver)	2
60	Halt	Stop positioner	-
61	Go E	Move positioner towards east	-
62	Go W	Move positioner towards west	-
64	P Status	Read positioner status register	-
65	Read Pos	Read positioner counter	-
6C	Goto	Move positioner motor to counter value, Hi, Lo	2
6D	Write Pos	Set positioner counter, Hi, Lo	2

Sat measurement

Overview of commands in Data Byte



An appropriate data byte only needs to be sent when the command byte requires data byte(s). You can see this in the above command byte table. You can find out which data byte has to be sent to which command byte in the data sheets for the relevant receiver.

Orbit position	Switch position H/V	Switch position LNB	Data byte
	V	Lo	F0
1	V	Hi	F1
	H	Lo	F2
	H	Hi	F3
	V	Lo	F4
2	V	Hi	F5
	H	Lo	F6
	H	Hi	F7
	V	Lo	F8
3	V	Hi	F9
	H	Lo	FA
	H	Hi	FB
	V	Lo	FC
4	V	Hi	FD
	H	Lo	FE
	H	Hi	FF

Simple Tone Burst DiSEqC

A simplified form of DiSEqC control is the Simple Tone Burst DiSEqC procedure. In this Simple DiSEqC two switching states are possible: tone burst and data burst.

Overview of commands in Simple DiSEqC



[2ndF] [SAT-CTRL] Call up the SAT-CTRL menu

[3] Call up the DiSEqC menu

[0] Enter tone burst

[1] Enter data burst

[ENTER] Send the command string

Exit the DiSEqC menu by pressing **[2ndF]** twice.

Sat measurement

Example



Call up Simple DiSEqC:

SAT-CTRL	LNB=1
V-SEC=2	DiSEqC=3

SAT-CTRL menu

Press buttons **[2ndF] [SAT-CTRL]**

Press button **[3]** to call up DiSEqC control.

DiSEqC-Framing

DiSEqC menu

The cursor must be positioned on the left with the **[←]** button. Press button **[0]** or **[1]** to call up the Simple DiSEqC menu.

DiSEqC-SIMPLE	
0 Tone BURST	>

Simple DiSEqC menu

Press **[ENTER]** to send the control command. The **>** symbol indicates that the control command has been sent. Press button **[1]** to switch to data burst.

Sat measurement

V-SEC (Vario-Satellite Equipment Control)

V-SEC provides unidirectional communication between satellite receivers and peripheral components in a satellite receiving system and serves to control intelligent multiswitches with several inputs, coaxial relays or rotation systems.

V-SEC uses 8-bit data transfer by pulse width modulation of the 22 kHz carrier frequency. There is 8-bit data transfer from the test receiver to the peripheral equipment through the existing coaxial cable. The V-SEC control signals are assigned to the components by destination addresses. After output of the V-SEC data, standard signals of 14 V/18 V and 0/60 Hz/22 kHz are still available. Input of the code word is in hexadecimal code..

Overview of commands in V-SEC



[2ndF] [SAT-CTRL] Call up the V-SEC menu

[0]...[9] Enter the figures 0 to 9

[.] [0]...[5] Enter the letters A...F

Button	Hex code
[.] [0]	A
[.] [1]	B
[.] [2]	C
[.] [3]	D
[.] [4]	E
[.] [5]	F

[-] or **[+]** Position cursor

[ENTER] Send the data packet

Exit the V-SEC menu by pressing **[2ndF]** twice.

Example



Call up V-SEC and enter the A5 control command:

Press buttons **[2ndF] [SAT-CTRL]**

By pressing button **[2]** you can all up the V-SEC control.

SAT-CTRL	LNB=1
V-SEC=2	DiSEqC=3

Enter the data word in hexadecimal code, e.g. A5:

Press buttons **[./S] [0] [5]**

SAT-CTRL	LNB=1
V-SEC=2	DiSEqC=3

Press **[ENTER]** to send the control command. The **>** symbol indicates that the control command has been sent. The cursor can be positioned using the **[-]** and **[+]** buttons.

V-SEC menu

Overview of commands in V-SEC

See manufacturer's documentation on peripheral equipment.

TV measurement

Standard Switch-Over

In the TV mode the MSK 24 can measure the following standards:

- B/G standard
- L standard
- D/K standard
- I standard
- M/N standard
- M1 standard (Japan)

Overview of commands in Standard Switch-Over (TV)



[2ndF] [STD] Call up standard switch-over menu

[0]...[6] Select standard

Example



Call up B/G analogue standard:

Press **[2ndF] [STD]**.

LC display:

1=ANALOG
2=DIGITAL(DVB)

- 1 = Analogue reception
- 2 = DVB reception

1. Standard menu

1=BG	2=L	3=DK
4=I	5=MN	6=M1

Press button **[1]**.

The following menu now appears:

- 1 = B/G Standard - 2 = L standard - 3 = D/K standard D/K, etc.

2. Standard menu

Press button **[1]**. The receiver is now set to analogue reception for B/G standard.

Note



Make sure that the selected standard is retained when the receiver is switched off.

TV measurement

Channel Display and Entering Channel

To measure the level of a received TV signal, you must first enter the desired channel.

The following channels can be set:

- Band I / III CH 01 to CH 12 in the 7 MHz raster
- Band IV / V CH 21 to CH 70 in the 8 MHz raster
- Special channel S 01 to S 20 in the 7 MHz raster
- Special channel S 21 to S 41 in the 8 MHz raster

The information refers only to the factory-preset B/G standard. You can find information for other standards in the Technical Appendix.

Overview of commands in Entering Channel (TV)



[SAT/TV]	Switch over to TV reception
[0]...[9]	Enter the channel
[./S]	Switch to special channel
[+] and [-]	Alter the channels gradually

Example



Enter channel S11:

Press **[./S] [1] [1]**.

LC display:

CH:S.11.	TV
LEV: 62.5dBuV	

- Special channel: S 11
- Level: 62.5 dBuV
- Mode: TV

Note



Make sure that the correct standard has been set. The B/G standard is the default setting.

TV measurement

Frequency Display and Entering Frequency

To measure the level of a received TV signal, you must first enter the desired video carrier frequency.

You can enter the frequency in steps of 50 kHz from 45 MHz to 867 MHz.

Overview of commands in Entering Frequency (TV)



[SAT/TV]	Switch over to TV reception
[CH-FRQ]	Switch-over between channel and frequency
[0]...[9]	Enter frequency
[ENTER]	Confirm entry
[+] and [-]	Change frequency gradually

Example



Enter frequency of 175.25 MHz:

Press **[2ndF] [CH/FRQ]**(Call up the frequency menus)

Then **[1] [7] [5] [./S] [2] [5] [ENTER]** ..(Entering frequency)

LC display:

CH:175,25	TV
LEV: 65,0dBuV	

- Frequency: 175.25 MHz
- Level: 65.0 dBuV
- Mode: TV

Note



Once you have called up the frequency menu, you only need to enter the figures to enter the frequency again.

The last frequency setting is retained even when the MSK 24 is switched off provided it was made using "numerical entries" and concluded with "MHz".

TV measurement

Level Measurement (TV)

Once you have set a channel or a frequency, the level is measured automatically and indicated in dB μ V or dBmV (depending on the configuration of the receiver) on the LC display. The input level can be measured in the range of 30 dB μ V to 120 dB μ V (-30 dBmV to 60 dBmV).

CH: .05.	TV
LEV: 86.5dB μ V	

LC display:

- Channel: CH 05
- Mode: TV
- Measured level: 86.5 dB μ V

Level Overflow and Underflow

The LC display shows an underflow level of <30 dB μ V.

CH: .05.	TV
LEV: ____ dB μ V	

LC display:

- Channel: CH 05
- Mode: TV
- Level: underflow

The LC display shows an overflow level of >120 dB μ V.

CH: .05.	TV
LEV: . dB μ V	

LC display:

- Channel: CH 05
- Mode: TV
- Level: overflow

Note



The level of DVB-C signals can only be measured in the digital reception mode. See Standard Switch-Over.

TV measurement

Tracking for Single Frequencies

In the "LEVEL" function you can align an antenna by tracking to receive the maximum signal. The level tendency can be indicated in the bar display. The measuring range can be set to three different sensitivity levels.

The level can be monitored with an audio tracking signal, the volume being proportional to the level of the signal received. The volume of the audio tracking signal can be set with the volume control.

Overview of commands in Tracking



[2ndF] [LEVEL] Switch over to the tracking mode

[-] [+]

Switch among the measuring ranges of the bar display. The measuring range is automatically preselected.

Level range 1: high input level

Level range 2: medium input level

Level range 3: low input level

Exit the LEVEL mode by pressing **[2ndF]** twice.

LC display:

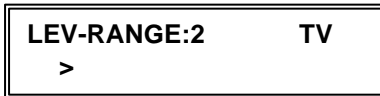

- Level range 2: medium input level
- Mode: TV
- Bar display

Example



Call up the "LEVEL" function:

Press buttons **[2ndF] [LEVEL]**.

Rotate the antenna until the bar display has reached its maximum.

If necessary, decrease or increase the sensitivity with the **[-]** and **[+]** buttons.

Repeat this procedure until you have reached the maximum level.

Exit the LEVEL menu by pressing **[2ndF]** twice.

TV measurement

Audio Carrier Distance and Level

TV transmitters can use a second audio carrier to transmit information using FM modulation (analogue) or in Nicam format (digital). Different frequencies are allocated to the audio carriers depending on the standard being used (see table). Audio carrier 1 is always the default setting after you have entered the channel or frequency.

Standard	Audio carrier 1	Audio carrier 2	Nicam
B/G	5.5 MHz	5.74 MHz	5.85 MHz
D/K	6.5 MHz	6.26 MHz	5.85 MHz
I	6.0 MHz	-----	6.552 MHz
M/N	4.5 MHz	4.72 MHz	-----
L	AM 6.5 MHz	-----	5.85 MHz
M1 (Japan)	4.5 MHz	-----	-----

When the audio carrier is measured, first the signal distance between the audio and the visual carriers is measured in dB. Then the absolute audio carrier level is measured in dB_{iV}. During the measurement the loudspeakers are muted. After measurement the modulation of the audio carrier last measured can be heard.

Overview of commands in Measuring Audio Carrier Frequency



- [2ndF] [SC]** Switch over to the Audio Carrier menu
- [1]...[2]** Switch between audio carrier 1 and audio carrier 2 (see table).
With the Measuring Audio Carrier Level button pressed,
- [3]** Switch over to Nicam reception

Example



SC: 5.50MHz	TV
LEV: -13.0dB	

Measure the audio carrier distance and level of audio carrier 1:
Press **[2ndF] [SC]**,
Now press **[1]** and keep the button pressed.
The LC display shows the following values for approx. 1 second:
Audio carrier distance frequency: 5.5 MHz
Audio carrier video carrier distance: -13 dB
After approx. 1 second the audio carrier level is displayed.

SC: 5.50MHz	TV
LEV: 58.5dBuV	

LC display:
Audio carrier distance frequency: 5.5 MHz
Audio carrier level: 58.5 dB_{iV}
Release button **[1]**.
Measure audio carrier distance and level of audio carrier 2:

TV measurement

As above. Press button **[2]** during the audio carrier display.

Measuring the Audio Carrier Distance and Level of Nicam Audio Carriers:

As above. Press button **[3]** during the audio carrier display.

Note



The audio carrier frequency cannot be set. It is switched over depending on the standard being used.

The audio carrier level is only displayed as long as one of the buttons **[1]**, **[2]** or **[3]** is pressed.

NICAM – Measuring Audio Bit Error Rates

To assess the audio quality of Nicam signals, you can measure the bit error rates (BER).

Example



Calling up Measuring Audio Bit Error Rates:

Press buttons **[2ndF]** **[SC]**

Press button **[3]**

SC: 5.85 MHz	TV
BER=2.145E-05	

BER=0.000 is displayed if the quality of the Nicam signal is so good that no bit errors are detected,.

OVERFLOW is displayed if the Nicam signal is too bad or if no signal is received.

FM measurement

Frequency Display and Entering Frequency

To measure the level of a received FM signal, you must first enter the desired frequency.

You can enter the frequency in steps of 50 kHz from 45 MHz to 867 MHz.

Overview of commands in Entering Frequency (FM)



- [2ndF] [FM]** Switch over to FM reception
- [0]...[9]** Enter frequency
- [ENTER]** Confirm entry
- [+]** and **[-]** Change the frequency gradually in steps of 50 kHz

Example



Enter frequency of 99.25 MHz

Press **[2ndF] [FM]**..... (Call up the FM menu)

Then **[9] [9] [./S] [2] [5] [ENTER]**(Enter frequency)

LC display:

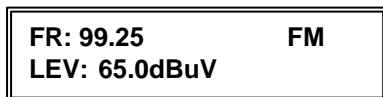

- Frequency: 99,25 MHz
- Level: 65,0 dBiV
- Mode: FM

Note



Once you have called up the FM menu, you only need to enter the figures to enter the frequency again.



The last frequency setting is retained even when the MSK 24 is switched off provided it was made using "numerical entries" and concluded with "MHz".

Level Measurement

Once you have set a frequency, the level is measured automatically and displayed in dBiV. The input level can be measured in the range of 30 dBiV to 120 dBiV.

LC display:

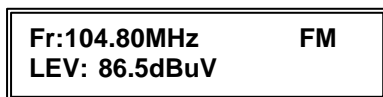

- Frequency: 104.8 MHz
- Mode: FM
- Measured level: 86.5 dBiV

Level Overflow and Underflow

The LC display shows an underflow level of <30 dBiV.

Example

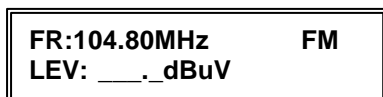

- Frequency: 104.8 MHz
- Mode: FM
- Level: underflow

FM measurement

The LC display shows an overflow level of >120 dB μ V.

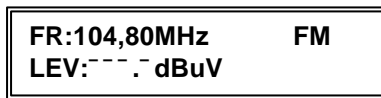

- Frequency: 104.8 MHz
- Mode: TV
- Level: overflow

Tracking for Single Frequencies

In the "LEVEL" function you can align an antenna by tracking to receive the maximum signal. The level tendency can be indicated in the bar display. The measuring range can be set to three different sensitivity levels.

The level can be monitored with an audio tracking signal, the volume being proportional to the level of the signal received. The volume of the audio tracking signal can be set with the volume control.

Overview of commands in Tracking



[2ndF] [LEVEL] Switch over to the tracking mode

[-] [+] Switch among the measuring ranges of the bar display. The measuring range is automatically preselected.

Level range 1: high input level

Level range 2: medium input level

Level range 3: low input level

Exit the LEVEL mode by pressing **[2ndF]** twice.

LC display:

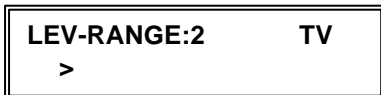

- Level range 2: medium input level
- Mode: TV
- Bar display

Example



Call up the "LEVEL" function:

Press buttons **[2ndF] [LEVEL]**.

Rotate the antenna until the bar display has reached its maximum.

If necessary, decrease or increase the sensitivity with the **[-]** and **[+]** buttons.

Repeat this procedure until you have reached the maximum level.

Exit the LEVEL menu by pressing **[2ndF]** twice.

Spectrum measurement

To assess a receiving system you can display the frequency spectrum for Sat, TV and FM on the screen.

You can call up Spectrum Measurement from the relevant mode (Sat, TV or FM).

Command for Spectrum Measurement: **[2ndF] [Spect]**.

Return to the normal LC display: 2 x **[2ndF]**.

You can use the buttons **[-]** and **[+]** to move a cursor on to the level graph to measure certain minimum and maximum levels. The frequency and the measured value are indicated in the upper line on the screen. The measuring range is indicated in dB μ V on the axis on the left of the screen. The level measurement range is set automatically.

The peak value of the level is measured in spectrum analysis.

Sat Spectrum

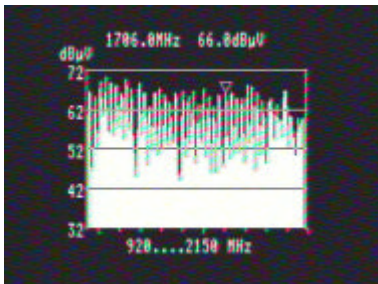

In the SAT mode (see relevant chapter) the entire Sat spectrum from 920 to 2150 MHz can be displayed.

SAT-Full

LC display

TV Spectrum



The TV range (see relevant chapter) is subdivided into four sections, which can be selected by pressing buttons **[1]**, **[2]**, **[3]** or **[4]**. See screen and explanation shown below.

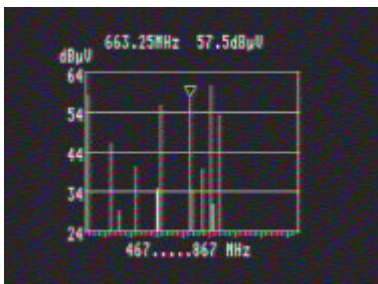

Example for UHF

Spectrum measurement

Overview of commands in TV Spectrum

LC displays and ranges:



TV full	[1]	FULL SPAN = entire TV range (44...867 MHz)
VHF	[2]	VHF (44...467 MHz)
UHF	[3]	UHF (467...867 MHz)
TV narrow	[4]	NARROW (e.g. 634...659 MHz)

FM Spectrum

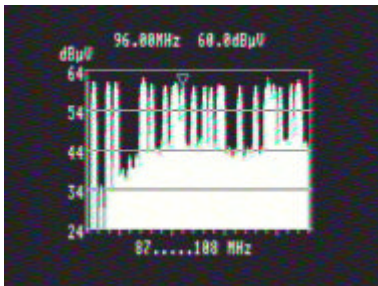

You can select and measure the FM spectrum as described above. It covers 87...108 MHz.

FM CCIR

LC display

Maintenance

Changing the battery

- Unscrew the two screws holding the straps of the leather case. Then unscrew the screw in the leather cover. Pull the receiver out of the leather case.
- Now unscrew all screws on the top, bottom and sides of the metal housing. Pull the receiver out of the metal housing.
- Remove the terminal clip from the battery. When changing the battery, beware of causing a short circuit between the terminal clips and the battery compartment.
- Unscrew the four screws of the battery compartment from the underside of the frame.
- Pull the battery out of the receiver from the back.
- Insert the new battery and screw the receiver together in the reverse sequence. Beware that the polarity of the battery is correct.

Battery: YUASA NP2.8-12 12V / 2.8Ah

Customer service

Send the receiver to the following address for any service work:

ESC - GmbH
Bahnhofstr.108
83224 Grassau

Tel.: +49 (0)8641 / 9545-0
Fax: +49 (0)8641 / 9545-35

Internet: www.esc-kathrein.de

Technical Appendix

Signal-to-noise distance

The following values must be known in order to calculate the carrier-to-noise distance (C/N) for analogue transponders.

- background noise level (set parabola antenna so that no satellite signal is received)
- max. receiving level
- bandwidth correction.

This gives the following formula:

C/N = receiving signal level - background noise level - bandwidth correction

$$\text{Bandwidth correction value} = 10 \log \frac{\text{Measured bandwidth of MSK 24.6 MHz}}{\text{RF bandwidth of receiving signal}}$$

Bandwidth correction value = 6.37 dB at 26 MHz bandwidth (Astra)

Bandwidth correction value = 7.78 dB at 36 MHz (Eutelsat, Intelsat, Kopernikus)

Example



Receiving signal level	+75.5 dB	with satellite signal
Background noise level	<u>-55.0 dB</u>	without satellite signal
Carrier-to-noise distance C/N	+20.5 dB	
Bandwidth correction	<u>- 6.4 dB</u>	for 26 MHz bandwidth
C/N of the receiving system	<u>+14.1 dB</u>	

Note



To calculate C/N exactly, it is essential that you take the RF bandwidth of the receiving signal into account.

Technical Appendix

DiSEqC commands for Kathrein matrices

Command set for Kathrein matrix 9xx-series

Range	POS. A (Satellite 1)			
	Low band		High band	
	Vert.	Hor.	Vert.	Hor.
DiSEqC command	E0 00 38 F0	E0 00 38 F2	E0 00 38 F1	E0 00 38 F3

Range	POS. B (Satellite 2)			
	Low band		High band	
	Vert.	Hor.	Vert.	Hor.
DiSEqC command	E0 00 38 F4	E0 00 38 F6	E0 00 38 F5	E0 00 38 F7

Command set for Kathrein matrix EXR 20

Range	EXR 20	
	POS. A	POS. B
DiSEqC command	E0 00 22	E0 00 26

Command set for Kathrein matrix EXR 22

Range	EXR 22	
	High band	Low band
DiSEqC command	E0 00 24	E0 00 20

Technical Appendix

Channel tables

Channel and frequency table for B/G standard (frequency in MHz)

VHF-CCIR			UHF-CCIR			UHF-CCIR		
Pilot frequency	01	80.15	21	21	471.25	46	46	671.25
E2	02	48.25	22	22	479.25	47	47	679.25
E3	03	55.25	23	23	487.25	48	48	687.25
E4	04	62.25	24	24	495.25	49	49	695.25
E5	05	175.25	25	25	503.25	50	50	703.25
E6	06	182.25	26	26	511.25	51	51	711.25
E7	07	189.25	27	27	519.25	52	52	719.25
E8	08	196.25	28	28	527.25	53	53	727.25
E9	09	203.25	29	29	535.25	54	54	735.25
E10	10	210.25	30	30	543.25	55	55	743.25
E11	11	217.25	31	31	551.25	56	56	751.25
E12	12	224.25	32	32	559.25	57	57	759.25
A	13	53.75	33	33	567.25	58	58	767.25
B	14	62.25	34	34	575.25	59	59	775.25
C	15	82.25	35	35	583.25	60	60	783.25
D	16	175.25	36	36	591.25	61	61	791.25
E	17	183.75	37	37	599.25	62	62	799.25
F	18	192.25	38	38	607.25	63	63	807.25
G	19	201.25	39	39	615.25	64	64	815.25
H	20	210.25	40	40	623.25	65	65	823.25
			41	41	631.25	66	66	831.25
			42	42	639.25	67	67	839.25
			43	43	647.25	68	68	847.25
			44	44	655.25	69	69	855.25
			45	45	663.25	70	70	863.25
USB / OSB			ESB					
S01	S01	105.25	ES21	S21	303.25			
S02	S02	112.25	ES22	S22	311.25			
S03	S03	119.25	ES23	S23	319.25			
S04	S04	126.25	ES24	S24	327.25			
S05	S05	133.25	ES25	S25	335.25			
S06	S06	140.25	ES26	S26	343.25			
S07	S07	147.25	ES27	S27	351.25			
S08	S08	154.25	ES28	S28	359.25			
S09	S09	161.25	ES29	S29	367.25			
S10	S10	168.25	ES30	S30	375.25			
S11	S11	231.25	ES31	S31	383.25			
S12	S12	238.25	ES32	S32	391.25			
S13	S13	245.25	ES33	S33	399.25			
S14	S14	252.25	ES34	S34	407.25			
S15	S15	259.25	ES35	S35	415.25			
S16	S16	266.25	ES36	S36	423.25			
S17	S17	273.25	ES37	S37	431.25			
S18	S18	280.25	ES38	S38	439.25			
S19	S19	287.25	ES39	S39	447.25			
S20	S20	294.25	ES40	S40	455.25			
			ES41	S41	463.25			
Channel raster: 7 MHz for VHF and USB/OSB - 8 MHz for UHF and ESB The channel, display on the MSK 24 and frequency are shown in the table.								

Technical Appendix

Channel and frequency table for L standard (frequency in MHz)

VHF			UHF			UHF		
	01	80.75	21	21	471.25	46	46	671.25
* LB	02	55.75	22	22	479.25	47	47	679.25
* LC	03	60.50	23	23	487.25	48	48	687.25
* LC1	04	63.75	24	24	495.25	49	49	695.25
L1	05	176.00	25	25	503.25	50	50	703.25
L2	06	184.00	26	26	511.25	51	51	711.25
L3	07	192.00	27	27	519.25	52	52	719.25
L4	08	200.00	28	28	527.25	53	53	727.25
L5	09	208.00	29	29	535.25	54	54	735.25
L6	10	216.00	30	30	543.25	55	55	743.25
	11	308.75	31	31	551.25	56	56	751.25
	12	441.75	32	32	559.25	57	57	759.25
	13	861.75	33	33	567.25	58	58	767.25
K _{1,4}	14	175.25	34	34	575.25	59	59	775.25
K _{1,5}	15	183.25	35	35	583.25	60	60	783.25
K _{1,6}	16	191.25	36	36	591.25	61	61	791.25
K _{1,7}	17	199.25	37	37	599.25	62	62	799.25
K _{1,8}	18	207.25	38	38	607.25	63	63	807.25
K _{1,9}	19	215.25	39	39	615.25	64	64	815.25
	20	223.25	40	40	623.25	65	65	823.25
			41	41	631.25	66	66	831.25
			42	42	639.25	67	67	839.25
			43	43	647.25	68	68	847.25
			44	44	655.25	69	69	855.25
			45	45	663.25	70	70	863.25
Special channels								
			S01	S01	120.00	S21	S21	280.00
			S02	S02	128.00	S22	S22	288.00
			S03	S03	136.00	S23	S23	303.25
			S04	S04	144.00	S24	S24	315.25
			S05	S05	152.00	S25	S25	327.25
			S06	S06	160.00	S26	S26	339.25
			S07	S07	168.00	S27	S27	351.25
			S08	S08	176.00	S28	S28	363.25
			S09	S09	184.00	S29	S29	375.25
			S10	S10	192.00	S30	S30	387.25
			S11	S11	200.00	S31	S31	399.25
			S12	S12	208.00	S32	S32	411.25
			S13	S13	216.00	S33	S33	423.25
			S14	S14	224.00	S34	S34	435.25
			S15	S15	232.00	S35	S35	447.25
			S16	S16	240.00	S36	S36	459.25
			S17	S17	248.00			
			S18	S18	256.00			
			S19	S19	264.00			
			S20	S20	272.00			
<p>Video and audio assessment and level measurement of the audio carrier are not possible for the channels marked with *.</p> <p>The channel, display on the MSK 24 and frequency are shown in the table.</p>								

Technical Appendix

Channel and frequency table for D/K standard (frequency in MHz)

VHF			UHF			UHF		
R-I	01	49.75	21	21	471.25	46	46	671.25
R-II	02	59.75	22	22	479.25	47	47	679.25
R-III	03	77.25	23	23	487.25	48	48	687.25
R-IV	04	85.25	24	24	495.25	49	49	695.25
R-V	05	93.52	25	25	503.25	50	50	703.25
R-VI	06	175.25	26	26	511.25	51	51	711.25
R-VII	07	183.25	27	27	519.25	52	52	719.25
R-	08	191.25	28	28	527.25	53	53	727.25
R-IX	09	199.25	29	29	535.25	54	54	735.25
R-X	10	207.25	30	30	543.25	55	55	743.25
R-XI	11	215.25	31	31	551.25	56	56	751.25
R-XII	12	223.25	32	32	559.25	57	57	759.25
	13	50.00	33	33	567.25	58	58	767.25
	14	60.00	34	34	575.25	59	59	775.25
	15	70.00	35	35	583.25	60	60	783.25
	16	75.00	36	36	591.25	61	61	791.25
	17	80.00	37	37	599.25	62	62	799.25
	18	90.00	38	38	607.25	63	63	807.25
	19	175.00	39	39	615.25	64	64	815.25
	20	200.00	40	40	623.25	65	65	823.25
			41	41	631.25	66	66	831.25
			42	42	639.25	67	67	839.25
			43	43	647.25	68	68	847.25
			44	44	655.25	69	69	855.25
			45	45	663.25	70	70	863.25
Special channels								
			S01	S01	111.25	S21	S21	311.25
			S02	S02	119.25	S22	S22	319.25
			S03	S03	127.25	S23	S23	327.25
			S04	S04	135.25	S24	S24	335.25
			S05	S05	143.25	S25	S25	343.25
			S06	S06	151.75	S26	S26	351.25
			S07	S07	159.25	S27	S27	359.25
			S08	S08	167.25	S28	S28	367.25
			S09	S09	100.25	S29	S29	375.25
			S10	S10	105.25	S30	S30	383.25
			S11	S11	231.25	S31	S31	391.25
			S12	S12	239.25	S32	S32	399.25
			S13	S13	247.25	S33	S33	407.25
			S14	S14	255.25	S34	S34	415.25
			S15	S15	263.25	S35	S35	423.25
			S16	S16	271.25	S36	S36	431.25
			S17	S17	279.25	S37	S37	439.25
			S18	S18	287.25	S38	S38	447.25
			S19	S19	295.25	S28	S28	455.25
			S20	S20	303.25	S40	S40	463.25
The channel, display on the MSK 24 and frequency are shown in the table.								

Technical Appendix

Channel and frequency table for I standard (frequency in MHz)

VHF			UHF			UHF		
I A	01	45.75	21	21	471.25	46	46	671.25
I B	02	53.75	22	22	479.25	47	47	679.25
I C	03	61.75	23	23	487.25	48	48	687.25
I D	04	175.25	24	24	495.25	49	49	695.25
I E	05	183.25	25	25	503.25	50	50	703.25
I F	06	191.25	26	26	511.25	51	51	711.25
I G	07	199.25	27	27	519.25	52	52	719.25
I H	08	207.25	28	28	527.25	53	53	727.25
I J	09	215.25	29	29	535.25	54	54	735.25
	10	223.25	30	30	543.25	55	55	743.25
	11	231.25	31	31	551.25	56	56	751.25
	12	239.25	32	32	559.25	57	57	759.25
	13	247.45	33	33	567.25	58	58	767.25
	14	50.00	34	34	575.25	59	59	775.25
	15	60.00	35	35	583.25	60	60	783.25
	16	70.00	36	36	591.25	61	61	791.25
	17	75.00	37	37	599.25	62	62	799.25
	18	80.00	38	38	607.25	63	63	807.25
	19	90.00	39	39	615.25	64	64	815.25
	20	175.00	40	40	623.25	65	65	823.25
			41	41	631.25	66	66	831.25
			42	42	639.25	67	67	839.25
			43	43	647.25	68	68	847.25
			44	44	655.25	69	69	855.25
			45	45	663.25	70	70	863.25
			Special channels					
			S01	S01	111.25	S21	S21	311.25
			S02	S02	119.25	S22	S22	319.25
			S03	S03	127.25	S23	S23	327.25
			S04	S04	135.25	S24	S24	335.25
			S05	S05	143.25	S25	S25	343.25
			S06	S06	151.75	S26	S26	351.25
			S07	S07	159.25	S27	S27	359.25
			S08	S08	167.25	S28	S28	367.25
			S09	S09	100.25	S29	S29	375.25
			S10	S10	105.25	S30	S30	383.25
			S11	S11	231.25	S31	S31	391.25
			S12	S12	239.25	S32	S32	399.25
			S13	S13	247.25	S33	S33	407.25
			S14	S14	255.25	S34	S34	415.25
			S15	S15	263.25	S35	S35	423.25
			S16	S16	271.25	S36	S36	431.25
			S17	S17	279.25	S37	S37	439.25
			S18	S18	287.25	S38	S38	447.25
			S19	S19	295.25	S28	S28	455.25
			S20	S20	303.25	S40	S40	463.25
The channel, display on the MSK 24 and frequency are shown in the table.								

Technical Appendix

Channel and frequency table for M1 Japan standard (frequency in MHz)

VHF			UHF			UHF		
J01	01	91.25	13	13	471.25	38	38	621.25
J02	02	97.25	14	14	477.25	39	39	627.25
J03	03	103.25	15	15	483.25	40	40	633.25
J04	04	171.25	16	16	489.25	41	41	639.25
J05	05	177.25	17	17	495.25	42	42	645.25
J06	06	183.25	18	18	501.25	43	43	651.25
J07	07	189.25	19	19	507.25	44	44	657.25
J08	08	193.25	20	20	513.25	45	45	663.25
J09	09	199.25	21	21	519.25	46	46	669.25
J10	10	205.25	22	22	525.25	47	47	675.25
J11	11	211.25	23	23	531.25	48	48	681.25
J12	12	217.25	24	24	537.25	49	49	687.25
			25	25	543.25	50	50	693.25
			26	26	549.25	51	51	699.25
			27	27	555.25	52	52	705.25
			28	28	561.25	53	53	711.25
			29	29	567.25	54	54	717.25
			30	30	573.25	55	55	723.25
			31	31	579.25	56	56	729.25
			32	32	585.25	57	57	735.25
			33	33	591.25	58	68	741.25
			34	34	597.25	59	59	747.25
			35	35	603.25	60	60	753.25
			36	36	609.25	61	61	759.25
			37	37	615.25	62	62	765.25
Special channels								
S 1	S01	223.25	S20	S20	337.25	S39	S39	451.25
S 2	S02	231.25	S21	S21	343.25	S40	S40	457.25
S 3	S03	237.25	S22	S22	349.25	S41	S41	463.25
S 4	S04	243.25	S23	S23	355.25			
S 5	S05	249.25	S24	S24	361.25			
S 6	S06	253.25	S25	S25	367.25	M 1	S42	109.25
S 7	S07	259.25	S26	S26	373.25	M 2	S43	115.25
S 8	S08	265.25	S27	S27	379.25	M 3	S44	121.25
S 9	S09	271.25	S28	S28	385.25	M 4	S45	127.25
S10	S10	277.25	S29	S29	391.25	M 5	S46	133.25
S11	S11	283.25	S30	S30	397.25	M 6	S47	139.25
S12	S12	289.25	S31	S31	403.25	M 7	S48	145.25
S13	S13	295.25	S32	S32	409.25	M 8	S49	151.25
S14	S14	301.25	S33	S33	415.52	M 9	S50	157.25
S15	S15	307.25	S34	S34	421.25	M10	S51	165.25
S16	S16	313.25	S35	S35	427.25			
S17	S17	319.25	S36	S36	433.25			
S18	S18	325.25	S37	S37	439.25			
S19	S19	331.25	S38	S38	445.25			
The channel, display on the MSK 24 and frequency are shown in the table.								

Technical Appendix

Channel and frequency table for M/N standard (frequency in MHz)

VHF		UHF			UHF		
01	72.00	14	14	471.25	47	47	669.25
A02	02 55.25	15	15	477.25	48	48	675.25
A03	03 61.25	16	16	483.25	49	49	681.25
A04	04 67.25	17	17	489.25	50	50	687.25
A05	05 77.25	18	18	495.25	51	51	693.25
A06	06 83.25	19	19	501.25	52	52	699.25
A07	07 175.25	20	20	507.25	53	53	705.25
A08	08 181.25	21	21	513.25	54	54	711.25
A09	09 187.25	22	22	519.25	55	55	717.25
A10	10 193.25	23	23	525.25	56	56	723.25
A11	11 199.25	24	24	531.25	57	57	729.25
A12	12 205.25	25	25	537.25	58	58	735.25
A13	13 211.25	26	26	543.25	59	59	741.25
		27	27	549.25	60	60	747.25
		28	28	555.25	61	61	753.25
		29	29	561.25	62	62	759.25
		30	30	567.25	63	63	765.25
		31	31	573.25	64	64	771.25
		32	32	579.25	65	65	777.25
		33	33	585.25	66	66	783.25
		34	34	591.25	67	67	789.25
		35	35	597.25	68	68	795.25
		36	36	603.25	69	69	801.25
		37	37	609.25	70	70	807.25
		38	38	615.25	71	71	813.25
		39	39	621.25	72	72	819.25
		40	40	627.25	73	73	825.25
		41	41	633.25	74	74	831.25
		42	42	639.25	75	75	837.25
		43	43	645.25	76	76	843.25
		44	44	651.25	77	77	849.25
		45	45	657.25	78	78	855.25
		46	46	663.25	79	79	861.25

The channel, display on the MSK 24 and frequency are shown in the table.

Technical Appendix

Channel and frequency table for M/N standard (frequency in MHz)

Special channels			Special channels		
A-5 95	S01	91.25	OO 51	S43	385.25
A-4 96	S02	97.25	PP 52	S44	391.25
A-3 97	S03	103.25	QQ 53	S45	397.25
A-2 98	S04	109.25	RR 54	S46	403.25
A-1 99	S05	115.25	SS 55	S47	409.25
A 14	S06	121.25	Audio	S48	415.25
B 15	S07	127.25	UU 57	S49	421.25
C 16	S08	133.25	VV 58	S50	427.25
D 17	S09	139.25	WW 59	S51	433.25
E 18	S10	145.25	AAA 60	S52	439.25
F 19	S11	151.25	BBB 61	S53	445.25
G 20	S12	157.25	CCC 62	S54	451.25
H 21	S13	163.25	DDD 63	S55	457.25
I 22	S14	169.25	EEE 64	S56	463.25
J 23	S15	217.25	65	S57	469.25
K 24	S16	223.25	66	S58	475.25
L 25	S17	229.25	67	S59	481.25
M 26	S18	235.25	68	S60	487.25
N 27	S19	241.25	69	S61	493.25
O 28	S20	247.25	70	S62	499.25
P 29	S21	253.25	71	S63	505.25
Q 30	S22	259.25	72	S64	511.25
R 31	S23	265.25	73	S65	517.25
S 32	S24	271.25	74	S66	523.25
T 33	S25	277.25	75	S67	529.25
U 34	S26	283.25	76	S68	535.25
V 35	S27	289.25	77	S69	541.25
W 36	S28	295.25	78	S70	547.25
AA 37	S29	301.25	79	S71	553.25
BB 38	S30	307.25	80	S72	559.25
CC 39	S31	313.25	81	S73	565.25
DD 40	S32	319.25	82	S74	571.25
EE 41	S33	325.25	83	S75	577.25
FF 42	S34	331.25	84	S76	583.25
GG 43	S35	337.25	85	S77	589.25
HH 44	S36	343.25	86	S78	595.25
II 45	S37	349.25	87	S79	601.25
JJ 46	S38	355.25	88	S80	607.25
KK 47	S39	361.25	89	S81	613.25
LL 48	S40	367.25	90	S82	619.25
MM 49	S41	373.25	91	S83	625.25
NN 50	S42	379.25	92	S84	631.25
			93	S85	637.25

The channel, display on the MSK 24 and frequency are shown in the table.

936.1997/ZWT/PF Technical data subject to change

internet <http://www.kathrein.de>

KATHREIN-Werke KG · Telephone +49 (0) 80 31 18 40 · Fax +49 (0) 80 31 18 43 06
Anton-Kathrein-Strasse 1-3 · Postfach 10 04 44 · D-83004 Rosenheim

KATHREIN

Antennen · Electronic

Free Manuals Download Website

<http://myh66.com>

<http://usermanuals.us>

<http://www.somanuals.com>

<http://www.4manuals.cc>

<http://www.manual-lib.com>

<http://www.404manual.com>

<http://www.luxmanual.com>

<http://aubethermostatmanual.com>

Golf course search by state

<http://golfingnear.com>

Email search by domain

<http://emailbydomain.com>

Auto manuals search

<http://auto.somanuals.com>

TV manuals search

<http://tv.somanuals.com>