



UFX 314 data bus de-multiplexer

(BN 20610071)

Contents

	Page
General	3
1. Features	3
2. Mechanical layout	4
2.1 Rear view	4
2.2 Front view	4
2.3 Status LEDs	4
3. Installation	
3.1 Installation	5
3.2 UFO [®] compact controller	7
3.3 Network configuration	7
3.4 USB installation	8
3.4.1 Microsoft Windows	8
3.4.2 Linux	11
4. Software Update	11
5. Web interface	
5.1 The main page	12
5.1.1 The device group box	12
5.1.2 The system group box	12
5.2 Log page	12
5.3 Status page	13
5.4 Update page	13
6. Modem access	
6.1 Setting up in Microsoft Windows	13
6.2 Setting up in Linux	19
7. Open source	22



General

The UFX 314 data bus de-multiplexer (BN 20610071) is used for the central control of all channel units installed in a UFG 412 base unit. Each channel unit is connected using a separate cable. Several demultiplexers can be connected to a system over a network.

1. Features

- Facilitates the use of the USW 30 control software
- Required on the use of certain functions for some channel units, e. g. for NIT generation
- Can be used to update older UFO[®]*compact* systems
- Control of individual channel units using UFO[®]*compact* controller (from software version 9.20) or PC with control software USW 30 (version 3.2)
- Feature for remote maintenance over LAN as well as analogue, ISDN or GSM modem
- Up to eight UFX 314 can be configured over LAN to form a group
- Up to 256 groups can be controlled independently of each other in a LAN segment

2. Mechanical layout

The points are described in the plan view from left to right.

2.1 Rear view

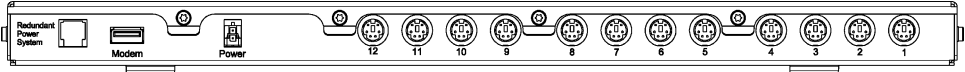

- Redundant Power System** Expansion connection for monitoring a redundant power supply, currently has no function
- Modem** USB port for connecting a modem (see section 6) or a USB stick
- Power** Power connection 12.5 V/approx. 200 mA (without controller or USB device), max. 900 mA
- 12 x Mini-DIN sockets** For the connection of up to 12 UFO®compact channel units

2.2 Front view

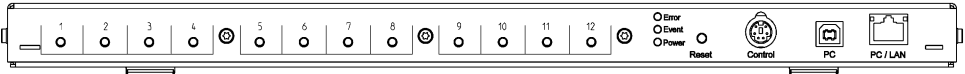

- 12 x port LEDs** These LEDs are used to indicate the channel unit to which a control unit is currently connected
- 3 status LEDs** Error (red), Event (yellow), Power (green)
- Reset button** For manually re-starting the device
- Mini-DIN socket** For the connection of a handheld controller
- USB device port** For the connection to a PC, with USW 30
- RJ45 socket** 10/100 Mbit Ethernet, for connecting several UFX 314 and a control PC

2.3 status LEDs

The Power LED illuminates as soon as the UFX 314 is supplied with power. The status is indicated using the Error LED and Event LED. The Event LED illuminates during the start phase and extinguishes as soon as the UFX 314 is ready. The Error LED and Event LED illuminate continuously during a software update. At the end of the update, the Event LED extinguishes. When the device is then re-started, the Error LED also extinguishes, and the Event LED illuminates at the start.

In normal operation, the Error LED and Event LED signal the presence of messages. An illuminated Event LED signifies that information has been written to the log. If the Event LED is flashing, a warning has been generated, it should still be possible to continue to operate the UFX 314. The flashing Error LED signifies that an error has occurred and the correct operation of the UFX 314 is no longer assured. If the Error and Event LED flash alternately, a serious error has occurred making normal operation more or less impossible.

3. Installation

3.1 Installation

The demultiplexer is installed in the 1 HU fan unit that is mounted above the base unit.

For this purpose the following steps are required:

- Fit the UFX 314 into the 19" front panel (1 HU) supplied
- Remove the pre-assembled blanking plate
- Connect straight connectors on connecting cables to the demultiplexer (mini-DIN sockets 1 ... 12)
The angled version is to be connected to the modules
- If a modem is being used, an RS 232 adapter must be connected (special accessory, not included with the UFX 314). The modem operates independently of the demultiplexer to which it is connected
- Now push the demultiplexer into the 1-HU front unit from the front and screw into place
- Then connect the power supply unit power cable to the blue terminals (black = ground, brown = 12 V 5)
- The channel unit → UFX 314 connecting cables should always be laid to the right along the related channel unit (exception: channel unit on the extreme right)

Where the following text refers to a switch, a hub can also be used as an alternative. It is also possible to connect the control PC to the switch. If only two UFX 314 are to be connected together, a crossed Ethernet cable can be used - however in this case a control PC can then only be connected using USB.

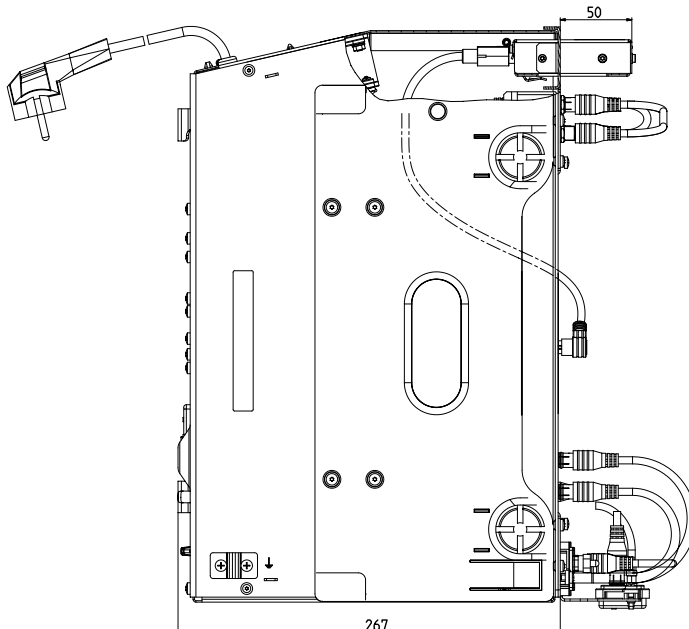

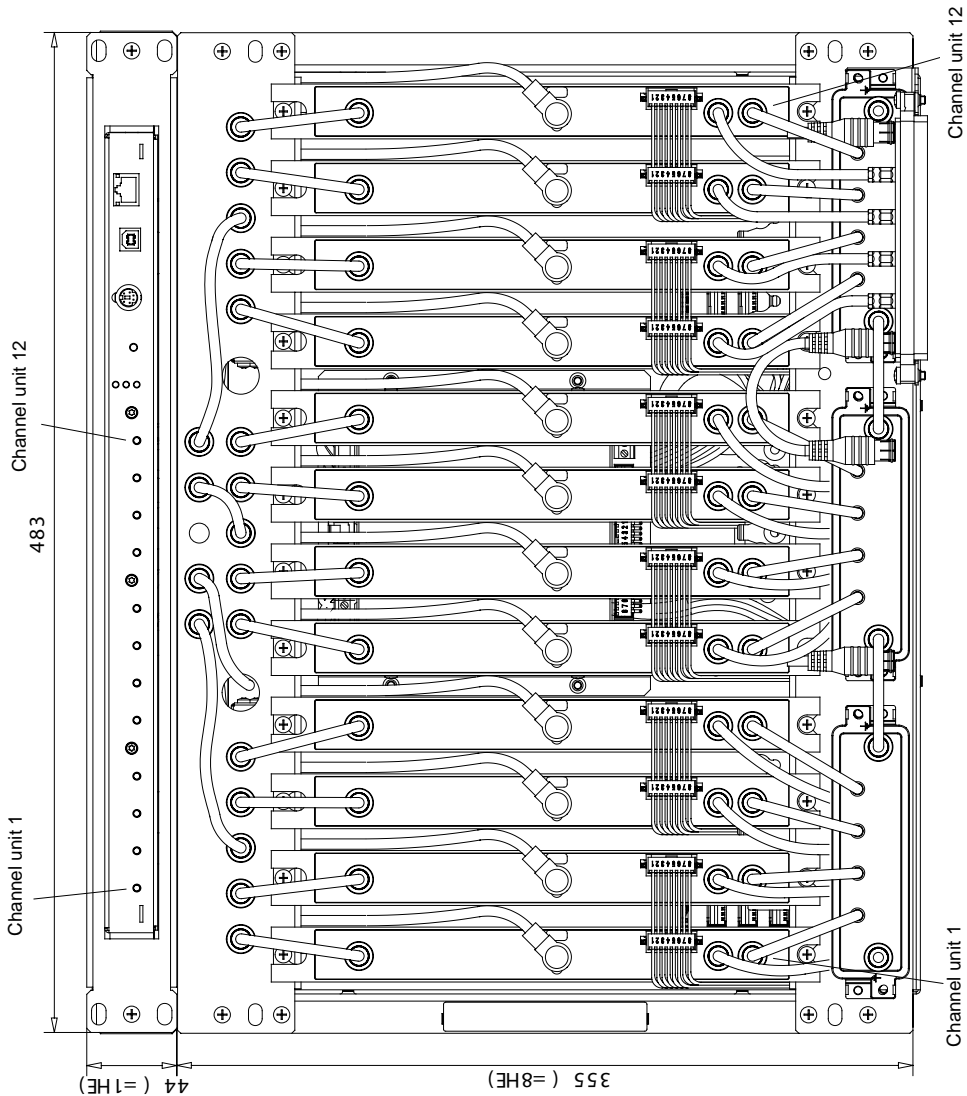

Connect the power cable for the UFX 314 to the screw terminals in the power supply for the base unit

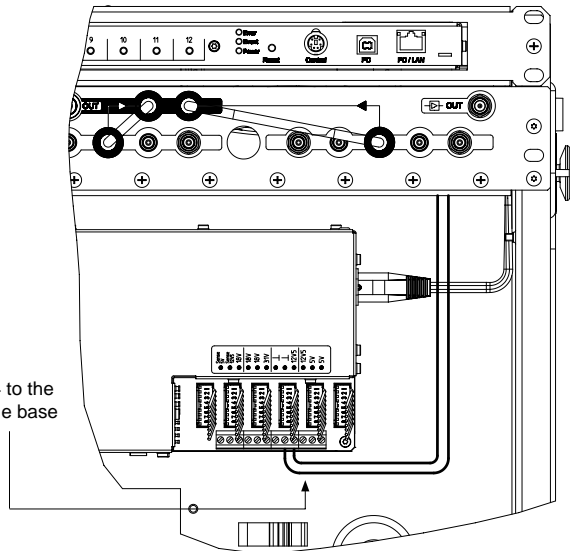

3.2 UFO[®]compact controller

The UFO[®]compact controller can be connected to any of the demultiplexers. However, it is to be noted that the controller only operates with the demultiplexers that belong to the same group to which it is connected. The usage of an older UFO[®]compact controller prior to software version 9.20 is in principle possible, however there may be connection problems with the channel units.

Only one control system can be active per group, this means that you can only access the group using one UFO[®]compact controller or with one USW 30. As the groups are independent of each other, several groups in a network can be controlled at the same time.

3.3 Network configuration

Connect several UFX 314 using a network. If you want to integrate the devices into an existing network, you should consult the responsible network administrator to prevent problems from the start. Firewall and antivirus applications may adversely affect the function.

The network configuration for the UFX 314 can only be undertaken using the controller software USW 30 and is described in section 7 of the manual provided with the software.

In the delivery status, every demultiplexer is set to "Zeroconf". Microsoft Windows also uses this method if a fixed IP address has not been defined and a DHCP server is not available.

The related standard was published by the IETF under "RFC 3927"¹⁾. The devices in the network select a spare IP address from the range 169.254.1.0 to 169.254.255.0 and use the network mask 255.255.0.0.

The USW 30 connects with a demultiplexer in the group using TCP port 9312 and can then communicate with all other multiplexers in this group over this connection. It does not matter to which device in a group the USW 30 connects. Between the UFX 314 a TCP connection on port 9313 is used.

To establish a connection via a router, the router must forward port 9312 to a UFX 314.

The UFX 314 does not have any access protection for Ethernet or USB access, for this reason instead of simple port forwarding, the usage of a virtual private network (VPN) should be considered. You will find information on VPN in the related specialist literature and on the Internet.

The "Multicast DNS"²⁾ and "DNS Service Discovery"³⁾ protocols used for the network search use Multicast packets on UDP port 5353. The network is searched by each UFX 314 to find other devices in its group.

¹⁾ <http://files.zeroconf.org/rfc3927.txt>

²⁾ <http://www.multicastdns.org/index.html>

³⁾ <http://www.dns-sd.org/index.html>

3.4 USB installation

3.4.1 Microsoft Windows

You will find the driver for the connection of a PC using USB on the USW 30 control software CD (not included). To install the driver, you will need administrator permissions on the PC. The installation is described based on the English version of Windows XP.

If the UFX 314 indicates an error after connecting/changing connections, or if it is not correctly detected by Windows, disconnect it from the PC and restart it using the Reset button. Before reconnecting to the PC, wait until the demultiplexer has started completely (see 2.3 Status LEDs).



After the UFX 314 is connected, a wizard for installing new hardware appears.

Choose "No, not this time" and click "Next" to open the next page in the wizard.



Select "Install from a list or specific location".



Select "Search for the best driver in these locations" and "Include this location in the search:".

By clicking "Browse" you can open a dialog box where you can open the folder "UFX314\drivers" on the USW 30 CD.

In the event of an update to the USW 30, the drivers can be found in the software installation folder.



Ignore this message by clicking "Continue Anyway".

The driver is now installed.

Note:

After driver installation has been completed, a new network connection will be available (name "USB Ethernet/RNDIS") which can be configured and used as a standard (Ethernet) network connection.

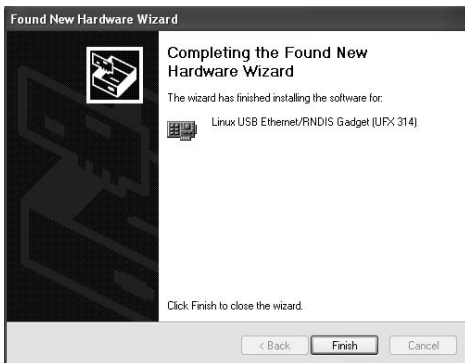

The driver installation is now complete.

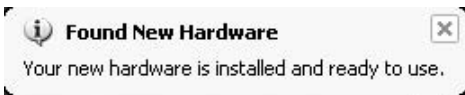

Windows confirms again that the driver has been installed.

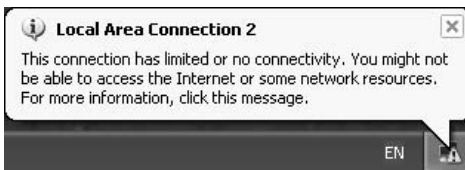

If this message does not appear or if you have selected "Zeroconf" (factory setting) as the address for UFX 314 network configuration, you do not have to take any further steps.

Otherwise, double-click the network symbol in the task bar or select the respective network connection (name "USB Ethernet/RNDIS") in the Control Panel under "Network connections".

Important note:

The warning message (network symbol with an exclamation point on the task bar) can be ignored in this case. This warning only means that Windows has assigned an automatically determined configuration ("Zeroconf") to the network connection, and therefore may be the reason why there is no connection to the Internet or to other network resources. It is, however, possible to activate the UFX 314 via USB without any restrictions, as long as the the mode "Zeroconf" was selected for address allocation (factory setting).



Click "Properties".

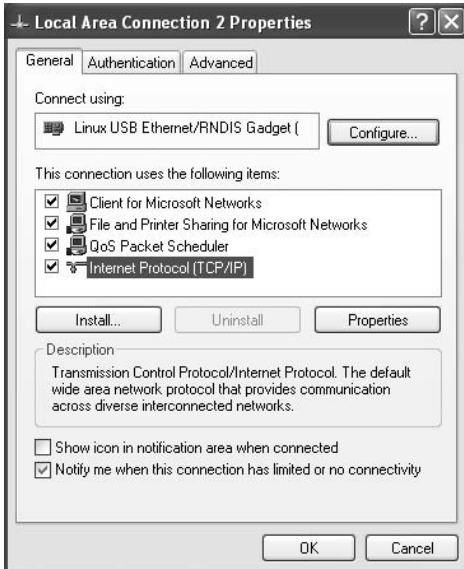

Select "Internet Protocol (TCP/IP)" and then click "Properties".

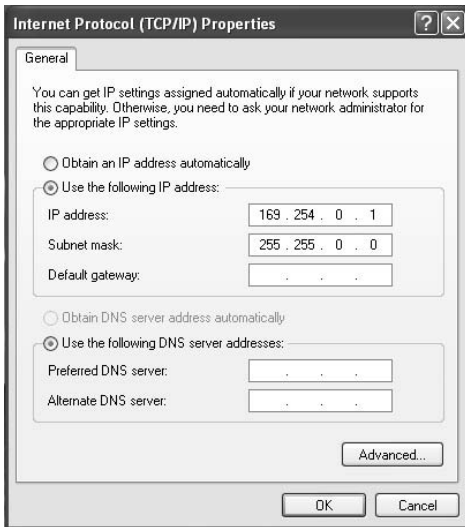

The connection has now been setup.
If there are still problems, contact your network administrator.

3.4.2 Linux

The driver is included in Linux from version 2.6, you may need to re-compile the kernel to activate the support. On the USB the UFX 314 is identified by Linux as "USB Communication Class Ethernet device".

4. Software update

You will find software updates for your UFO®compact software at "http://www.kathrein.de/esc-kathrein/download/ufo/ufo_compact_select.cfm". The updates for the UFX 314 are loaded using the Kathrein service tool (KUBdate) from version 1.1.2. All demultiplexers in a group must be updated.

In KUBdate, first select in "Supported devices" UFO Compact → Demultiplexer → UFX 314.

In "Selected device", you can open the connection settings using "Device settings", here you can select the group to be updated using "Search in the network". Using "Software update" you can select an update bundle and start the update. For further information, please refer to the KUBdate manual.

If the update fails, e. g. due to a power failure, the software can be repaired using a web browser or a USB stick. Updating using a web browser is described in section 5.4.

For an update using a USB stick, you will need the actual update archive.

You can extract the update archive from the Kathrein update bundle using a ZIP application; then save the update archive on a USB stick. The name of the file on the stick must start with "UFX314_" and have the same ending as the file in the bundle, e. g. ".tar.gz".

Should the bundle contain several archives, the file "bundle_info.xml" will provide information on which archive is for which hardware. Insert the stick in the demultiplexer to be repaired and then press the Reset button. The port LEDs may flash while the USB stick is searched. The demultiplexer copies the archive before it starts the update. As soon as the actual update starts, indicated by the illumination of Error LED and Event LED, the USB stick can be removed. After the update, the demultiplexer will re-start. If the stick is still inserted at this time, the process will start again from the beginning. Updating using a USB stick is only for problem cases and only the one demultiplexer is updated.

Select "Use the following IP address".

You must complete "IP address" and "Subnet mask" to suit the address of your demultiplexer.

If the UFX 314 is operated with DHCP, ask the person responsible for the DHCP server for the correct settings - in most cases "Obtain an IP address automatically" works.

If "Zeroconf" (factory setting) is used on the UFX 314, select "Obtain an IP address automatically". If the UFX 314 is set to "Manual", you must set an IP and subnet mask suitable for the device.

Alternatively, you can also assign an address from the range 169.254.0.1 to 169.254.0.254, the related subnet mask is 255.255.0.0.

Leave both dialog boxes using "OK".

5. Web interface

Every UFX 314 has a web interface that can be reached by entering the IP address for the demultiplexer in a web browser. You can determine the address using USW 30 or KUBdate.

5.1 The main page

The main page is divided into two areas, at the top the serial number, IP address and other links for the demultiplexer and below a list of all demultiplexers found, sorted by groups. All the links for a demultiplexer can be password-protected. The password is the same as for the PPP access and can be set using USW 30. As supplied, no password is set and access is therefore open.

5.1.1 The device group box

You can open the log using "View Log". Using the "Switch Debuglog" command you can enable and disable the storage of debug messages in the log. However, only new messages will be affected. You can clear the log using "Clear Log" and reset the status LEDs on the device. The "View Unit Status" link opens a page with more detailed information. You can re-start the UFX 314 using "Restart Unit". Using "Tagging on" you can make the 12 port LEDs flash for around one minute so that the unit can be identified.

You can open the web update using "Update Unit". With "Informations about used Opensource Licences" you can open an overview of the open source used in the device and the text for the related licences.

You will also find both these items here in the manual in section 7.1 or in the appendix.

5.1.2 The system group box

The devices are sorted by groups. For each group the number in hexadecimal notation and the comment defined by the user are displayed. The group number is a link to the base unit in each system. Each demultiplexer is displayed in a dedicated line. The serial number is also a link to the main page for the related unit. If you are already on the main page for a unit, the related links are not available. After the serial number there is a schematic diagram of the demultiplexer.

The diagram is divided into three parts. The three status LEDs can be seen on the right. The port LEDs are at the bottom left. The channel units connected are shown at the top left using blue squares. The information on the diagram refreshes automatically if JavaScript is enabled, or when the page is reloaded. Beside the diagram there is a link to the log, a link for re-starting the unit and links to enable and disable the flashing of all 12 port LEDs.

5.2 Log page

At the top the Log window contains a list of all error messages that have occurred. These error messages are stored in non-volatile memory by the UFX 314 and can also still be read after a reset. The time information in the error message is also a link to the related message in the bottom part of the window. The UFX 314 does not have a dedicated clock, the time is therefore calculated from each start starting from 1.1.1970 at 0:00 hours.

Old error messages are not deleted automatically. For this reason the user should delete the messages using the link on the main page, once they are no longer required. The bottom part of the window contains the current messages. The current messages are deleted each time the device is started. Older messages are also automatically deleted if there is not enough space. Error messages are listed here again so that they can be analysed in context. All messages are colour-coded:

Grey font on white background	Debug messages
Black font on white background	Normal information
White font on green background	Message that the device is ready for operation after a restart.
White font on blue background	Message that the device is shutting down for a restart or an update
Black font on yellow background	Warnings
Red font on yellow background	Error messages
Yellow font on red background	Fatal error

5.3 Status page

The Status page contains information on network addresses, software and hardware versions as well as the time and capacity utilisation.

5.4 Update page

On this page you can update the device's software. Normally the software is updated using the application KUBdate. You can extract the update archive from the Kathrein update bundle using a ZIP application; then upload it using this page. Should the bundle contain several archives, the file "bundle_info.xml" will provide information on which archive is for which hardware.

Updating using this web page is only for problem cases and only this one demultiplexer is updated.

6. Modem access

Any modem supported by the operating system can be used in the PC.

To connect the modem to the demultiplexer, a USB-RS232 adapter is necessary.

Currently the following modems are supported by the UFX 314:

Manufacturer	Model	Type
Develo (formerly Elsa)	Microlink 56k Fun II	Analogue
	MicroLink ISDN i	ISDN
3Com US Robotics	Sporster Flash	Analogue
Siemens	MC 35	GSM

The modem installed must be set to a speed of 115200 Baud or to automatic baud rate detection. You will find the instructions for making this setting in the manual for your modem. To ensure correct initialisation of the modem, the modem should be switched on and connected to the adapter before the adapter is connected to the UFX 314. Initialisation is automatic after connection, or, if an adapter is connected when the demultiplexer is started.

6.1 Setting up in Microsoft Windows

Setting up the connection is described based on the English version of Windows XP. In the following it is assumed that the modem is already installed in the PC. If this is not the case, consult the manual for your modem or your system administrator. To setup a new connection, on the Start menu select the "Control Panel" command and double-click "Network connections" in the window that appears. Now select "New Connection Wizard".



Open the next page in the wizard by clicking "Next".



Select here "Connect to the Internet" and then click "Next".



Now select "Set up my connection manually".



After selecting "Connect using a dial-up modem", use "Next" to open the dialog box for the connection's name.

New Connection Wizard

Connection Name
What is the name of the service that provides your Internet connection?

Type the name of your ISP in the following box.

ISP Name
Kathrein UFX 314

The name you type here will be the name of the connection you are creating.

< Back Next > Cancel

Enter a meaningful name for the connection to this demultiplexer as the name for the Internet service provider.

New Connection Wizard

Phone Number to Dial
What is your ISP's phone number?

Type the phone number below.

Phone number:
08031 184 123

You might need to include a "1" or the area code, or both. If you are not sure you need the extra numbers, dial the phone number on your telephone. If you hear a modem sound, the number dialed is correct.

< Back Next > Cancel

Enter here the telephone number to which the demultiplexer is connected.

New Connection Wizard

Internet Account Information
You will need an account name and password to sign in to your Internet account.

Type an ISP account name and password, then write down this information and store it in a safe place. (If you have forgotten an existing account name or password, contact your ISP.)

User name: ppp-user

Password: ●●●●●●

Confirm password: ●●●●●●

Use this account name and password when anyone connects to the Internet from this computer

Make this the default Internet connection

< Back Next > Cancel

Enter here the same user name and password as you have set using USW 30.

A check mark must also be set at "Make this the default Internet connection".

If you have not entered a password using USW 30, or have entered a blank password, the UFX 314 will accept any login, irrespective of user name and password. So anybody who knows the telephone number can dial into the system.

For this reason, it is strongly recommended to assign a user name and password.



The “New Connection Wizard” is completed with this dialog box.

If you want, you can select “Add a shortcut to this connection to my desktop” to be able to make the connection in future directly from the desktop. Otherwise, you will find the connection in the network connections where you have just opened the wizard.

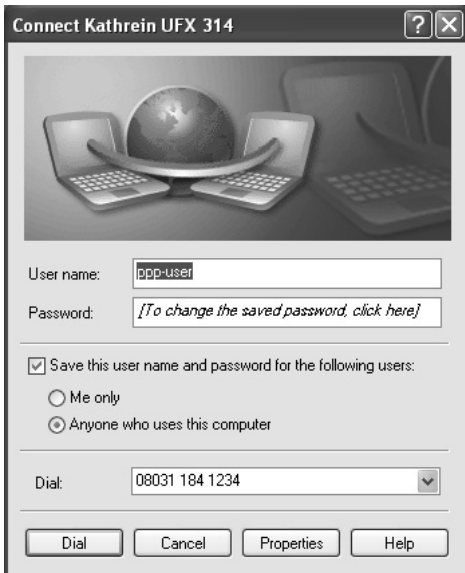

This window always appears when you want to establish a connection with the UFX 314.

The first time this window is opened, it is necessary to make a few further settings. For this purpose click “Properties”.



If you are using an ISDN modem, click "Configure". Otherwise select the "Security" tab.

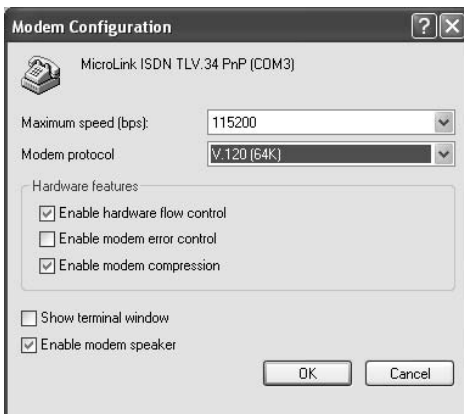

With an ISDN modem you must change the "Modem protocol" setting to "V.120 (64K)".

After accepting your changes using "OK", select the "Security" tab.



If "Show terminal window" or "Run script" is selected, clear the selection.

Click "Advanced" and then click "Settings" to change the advanced security settings.



In this dialog box, select as "Data encryption" "No encryption allowed" and then "Allow these protocols". Only "Unencrypted password" is to be selected. After leaving this dialog box using "OK", also leave the "Properties" dialog box using "OK".

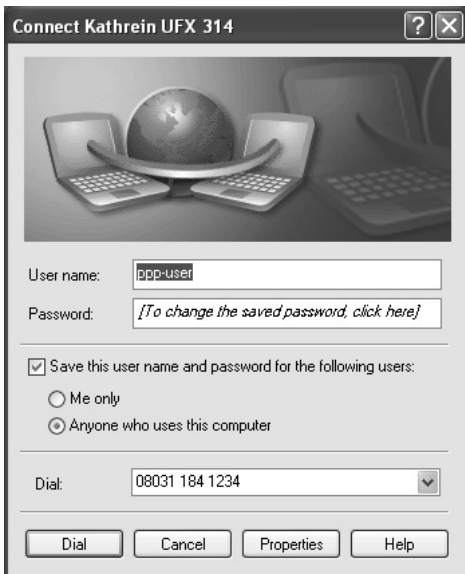

Now click "Dial" to establish the connection. The settings made are saved and do not need to be made again next time.

6.2 Setting up in Linux

It is recommended to use a terminal program with a graphic interface such as KPPP. It should be noted that all modems currently available with a USB interface have been primarily developed for Windows and they may therefore be difficult or impossible to use with Linux.

It is significantly easier to use serial modems, if necessary also with USB-RS 232 adapter.

Start KPPP. Normally this is in "KDE-Menu" → Internet → Dial in.

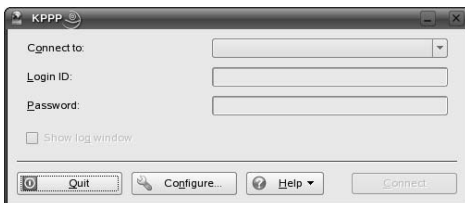

Click "Configure ..." to open the Configuration dialog box.

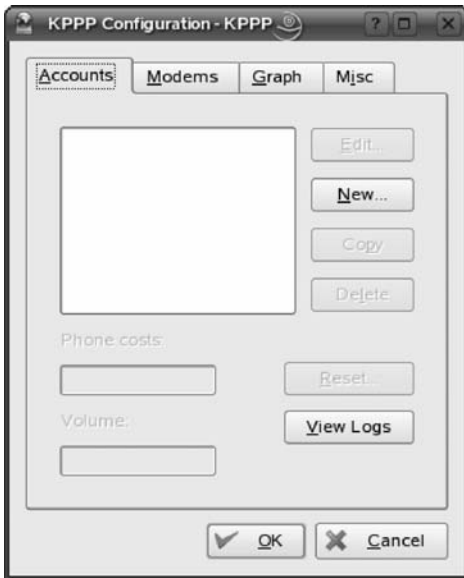

Select the "Accounts" tab and click "New ...".



Select "Manual Setup" at the prompt.

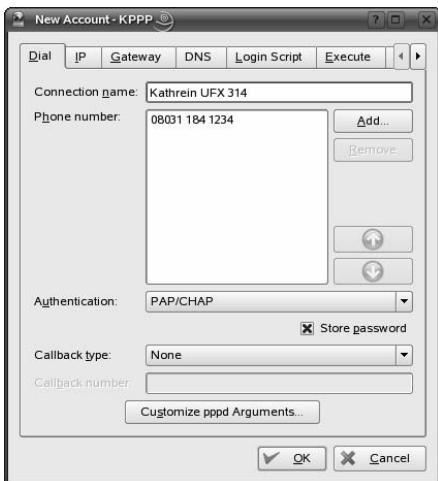

Enter a meaningful name for your connection in the "Connection name" box. Click "Add ..." to open a dialog box for entering the demultiplexer's telephone number. On the other tabs you can leave all the default settings.

The default settings should be as follows:

IP	Dynamic IP address
Gateway	Standard gateway and standard route on this gateway
DNS	Automatically
Login Script	Blank
Execute	Blank
Invoicing	Nothing selected

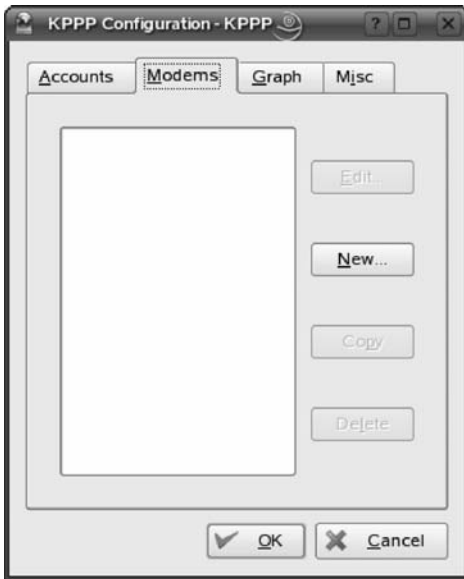

Select the "Modems" tab and click "New ...".

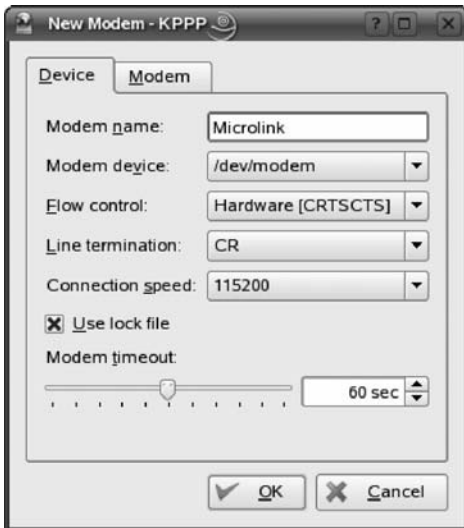

Assign a name to your modem and select the appropriate connection in "Modem device".

Ensure the speed is not too high. On the "Modem" tab you can poll the modem to check whether you have selected the right connection and an appropriate speed.

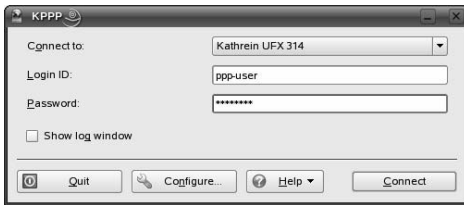

Choose the connection you have just setup and, if you are using several modems, the correct modem. Then enter the same user name and password as you have set using USW 30. The connection is established using "Connect".

If you have not entered a password using USW 30 or have entered a blank password, the UFX 314 will accept every login, independent of user name and password. So anybody who knows the telephone number can dial into the system.

For this reason, it is strongly recommended to assign a user name and password.

7. Open Source

This product contains software components that are covered by open source licences. These licences give you additional rights.

7.1 Open source applications and libraries included

Name	Version	Licence
Linux Kernel	2.6.22.1	GPL
Das U-Boot	1.1.4	GPL
Bridge utils	1.2	GPL
Busybox	1.2.1	GPL
betaftpd	0.0.8pre17	GPL
libstdc++	6.0.4	GPL with exception
glibc	2.3.5	LGPL
linuxthreads	0.10	LGPL
Avahi	0.6.17	LGPL
FTPLib	3.1-1	LGPL
pppd	2.4.4b1	PPPD

The text for the licences is given in the appendix.

7.2 Availability

For all software packages listed above that are licensed under GPL/LGPL, we grant you the right to receive the related source code, including the changes we have made, on CD-ROM/DVD.

This offer is valid from now up to three (3) years after the last device with this software has been delivered.

If the device's software changes, this offer will remain valid for all GPL/LGPL components in this future release.

The costs for preparing the data carrier and postage will be charged to you.

7.3 Acknowledgements

Some authors of free software require that their name be mentioned.

“This product includes software developed by Computing Services at Carnegie Mellon University (<http://www.cmu.edu/computing/>).”

7.4 Contact address

If you have any questions related to the open source software included, or to order the source code, contact the following address:

KATHREIN-Werke KG
Abteilung Software-Entwicklung (EM)
Anton-Kathrein-Straße 1-3
P.O. Box 100 444
83004 Rosenheim / Germany

Subject: Open Source Software

Free Manuals Download Website

<http://myh66.com>

<http://usermanuals.us>

<http://www.somanuals.com>

<http://www.4manuals.cc>

<http://www.manual-lib.com>

<http://www.404manual.com>

<http://www.luxmanual.com>

<http://aubethermostatmanual.com>

Golf course search by state

<http://golfingnear.com>

Email search by domain

<http://emailbydomain.com>

Auto manuals search

<http://auto.somanuals.com>

TV manuals search

<http://tv.somanuals.com>