



SmartStar[®] R-80 Telescope

Instruction Manual

Table of Content

Table of Content	2
1. SmarStar® R-80 Overview	4
1.1. SmartStar® R-80 Features	4
1.2. SmartStar® R-80 Assembly Terms	5
2. Telescope Assembly	6
3. GOTONOVA™ 8405 Hand Controller	8
3.1. Key Description	8
3.2. The LCD Screen	8
4. Getting Started	10
4.1. Level and Align the Mount	10
4.1.1. Level the Mount	10
4.1.2. Initial Positions	10
4.2. Setting Up the Mount	10
4.2.1. Time and Site Set Up	10
4.2.2. Using your telescope	12
4.2.3. Go to the Moon	12
4.2.4. Initial Star Alignment	12
4.3. Turn Off the Mount	13
5. Use SmartStar® R-80	14
5.1. Manual Operation of the Telescope	14
5.2. Slew to an Object	14
5.2.1. Planets, Sun, Moon	14
5.2.2. Deep Sky Objects	14
5.2.3. Comets	14
5.2.4. Asteroids	14
5.2.5. Stars	14
5.2.6. User RA&DEC JD2000 Objects	14
5.2.7. Enter Position	14
5.2.8. Watch List	14
5.2.9. Watch List Auto	15
5.3. Land Objects	15
5.4. Sync to Target	15
5.5. Set Up Controller	15
5.5.1. Set Display Info	15
5.5.2. Set Key Beep	16
5.5.3. Set Azi Work Mode	16
5.5.4. Reset All	16
5.6. Align	16
5.6.1. Solarsys Align	16
5.6.2. One Star Align	16
5.6.3. Two Star Alignment	16
5.7. Modify Star Catalog	17
5.7.1. User RA&DEC JD2000	17
5.7.2. Comets	18
5.7.3. Asteroids	19

5.8. Watch List.....	19
5.9. Set Telescope Coord.	19
5.10. Park Scope	19
6. Maintenance and Servicing.....	20
6.1. Maintenance.....	20
6.2. Storage and Transport.....	20
6.3. Troubleshooting	20
6.4. iOptron Customer Service.....	21
Appendix A. Technical Specifications	22
Appendix B. GOTONOVA™ 8405 HC MENU STRUCTURE.....	23
Appendix C. GOTONOVA™ Star List.....	25
IOPTRON ONE YEAR LIMITED WARRANTY.....	38



WARNING!

NEVER USE A TELESCOPE TO LOOK AT THE SUN!
Looking at or near the Sun will cause instant and irreversible damage to your eye.
Children should always have adult supervision while observing.

1. SmarStar® R-80 Overview

1.1. SmartStar® R-80 Features

Introducing our SmartStar® R-80 computerized GOTO telescope system. Designed with the latest technology the 80 mm lens is crafted with a fluorite based, low dispersion glass that is ground and polished to exact specifications. The precision design is excellent for viewing bright stars, planets and their moons, as well as for bird watching and other land objects. Two eye pieces come standard to allow for flexibility in viewing either a wider field or a single focused object.

Alt-Azimuth Mount– The Cube™

The SmartStar® R-80 refractor telescope comes with our patented Alt-Azimuth Mount, *a.k.a.* The Cube™. This compact mount design is one of the most functional and flexible units on the market. *Sky & Telescope* magazine named it “Hot Product 2008”. Both axis motors are built into a small single unit with optical encoders that provide accurate GOTO and tracking. The mount is universally compatible with all telescopes using a dove-tail connector plate. With an optional DC adaptor you can plug your telescope mount into your car if you’re camping or at any other remote location.

Easy to understand controller

The GOTONOVA™ hand controller is much easier to use than other similar products. The hand controller is more intuitive with menu categories better organized. It also has a larger LCD screen with more lines of content compared with the competition. Using the hand controller and its large LCD screen you can quickly set up your telescope and select where you want to go.

More precise speed control for viewing objects

The control system also allows you to slew the telescope at 5 different drive speeds, keeping the object within the telescope’s viewfinder for as long as you wish.

GOTONOVA™ Computerized Control System

The revolutionary GOTONOVA™ computerized control system is by far the most technologically advanced automated tracking system available on the market today. With a database of 10,000+ celestial objects including all of the more famous galaxies, nebulae, star clusters— not to mention the planets—you’ll be able to enjoy star gazing with the simple push of a button.

Package Contents¹

- (1) SmartStar® Mount with built-in GPS Receiver (*Models #9801 & #9802*)
- or
- (1) SmartStar® Mount (*Models #9501 & #9502*)

- (1) Refractor Telescope (80mm)
- (1) GOTONOVA™ Hand Controller (Part # 8405)
- (1) Controller Cable
- (1) Diagonal (45°)
- (2) Eyepieces (K 10mm & K 25mm)
- (1) Tripod





¹ Package contents may vary slightly

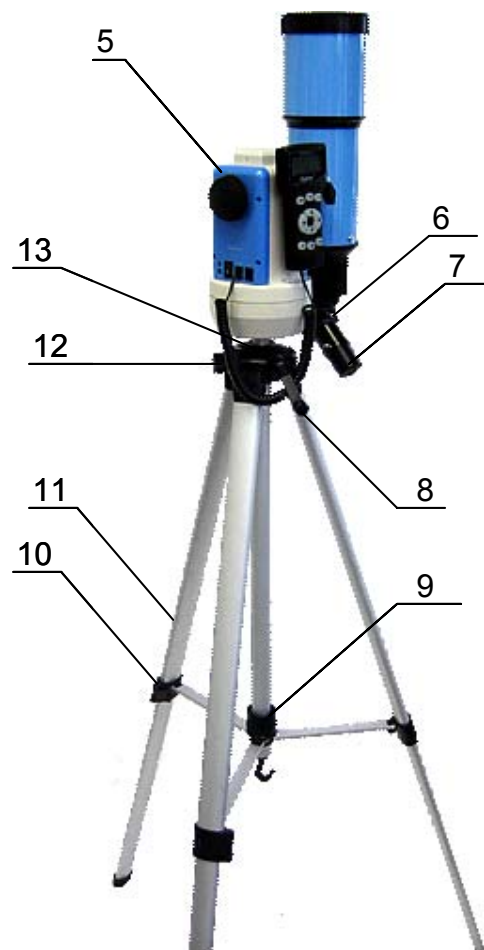
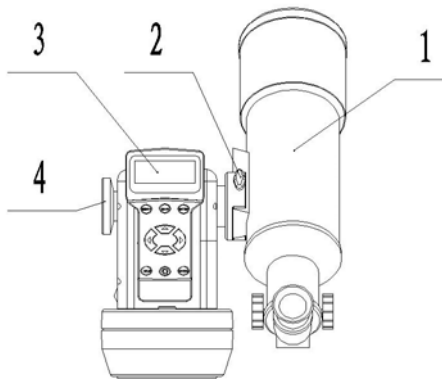

1.2. SmartStar[®] R-80 Assembly Terms

1. Telescope
2. Dovetail Lock
3. Hand Controller
4. Altitude Lock
5. Mount (GPS model)
6. Diagonal
7. Eyepiece
8. Height Adjustment Handle
9. Tripod Lock Knob
10. Tripod Leg Lock
11. Tripod
12. Height Extender Lock
13. Height Extender

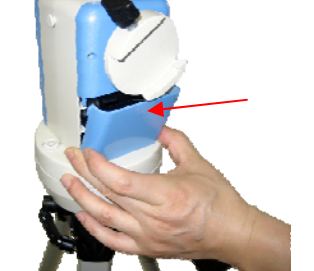

2. Telescope Assembly

	<p>Step 1. Preparing the Tripod</p> <p>Unlock the tripod leg locks (#10). Extend tripod legs. Lock the leg locks afterwards.</p>
	<p>Step 1a.</p> <p>Pull tripod legs apart to a fully opened position. Tighten the center tripod lock knob (#9) to a firm feel to secure the tripod legs.</p> <p><i>Caution: Make sure you loosen this lock knob before collapsing the tripod to store away.</i></p>
	<p>Step 2. Attaching the Mount</p> <p>Position center of the mount base to the threaded bolt of height extender (#13) on tripod. Turn the mount until it is securely fastened to the tripod. Use height adjustment handle (#8) to adjust the height of the mount if needed. (<i>Caution: Do not extend beyond 6 inches.</i>) Make sure to tighten the tripod height extender lock (#12).</p>
	<p>Step 3. Installing Batteries (not included)</p> <p>Pull the batteries compartment cover (shown) open. Gently pull the batteries holder (shown next) out of the compartment to avoid breaking the attached wires.</p>
	<p>Step 3a.</p> <p>Insert 8 AA batteries (not included) according to the diagrams on the holder.** Replace the holder back into the batteries compartment and replace the cover.</p> <p><i>Note: fit the batteries holder back into the compartment with the attached wires at the bottom right corner (see arrow in the photo).</i></p> <p>** Use only fresh batteries; do not mix fresh and old batteries; insufficient battery power may cause error messages; optional AC Adapter and Car Charger accessories are available at www.ioptron.com</p>

	<p>Step 4. Attaching Telescope Attach telescope to mount using the dovetail lock knob (#2).</p>
	<p>Step 5. Attaching Optics Insert 45° diagonal: Insert diagonal (#6) into the eyepiece side of the telescope. Tighten the thumbscrews to a firm feel only. Insert the eyepiece: Remove the supplied K 25mm eyepiece (#7) from its container and slide it into the open end of the diagonal. Tighten the thumbscrews to a firm feel only. Remove the round dust cover lid from the end of telescope. Use the focus knob to bring objects into focus. You may need to turn the focus knob quite a few turns to focus your telescope for the first time. Always start observing using a lower power eyepiece (such as the K25mm eyepiece) to get a wider field of view. Later on you can change to higher powers. (Eyepieces of higher powers have narrower field of views; it's more difficult to locate objects using high-power eyepieces.)</p>
	<p>Step 6. Connecting Hand Controller Plug hand controller into any one of the HBX (handbox) ports on the mount. Turn on power. Now you are ready to observe. Use the 4 Arrow keys (▲▼◀▶) to rotate the scope Up, Down, Left, and Right. Use the SPEED key to change the slew speed from the slowest (2X) to the fastest (MAX).</p>

3. GOTONOVA™ 8405 Hand Controller



Figure 1. GOTONOVA 8405 Hand Controller

GOTONOVA™ 8405 hand controller (HC) is the standard controller for a SmartStar R-80 telescope, as shown in Figure 1.

3.1. Key Description

- MENU: Press “MENU” to enter the Main Menu.
- BACK: Move back to the previous screen, or end/cancel current operation, such as slewing.
- ENTER: Confirm an input, go to the next menu, select a choice, slew the telescope to a selected object, or stop/start tracking.
- Arrow (▲▼▶◀): Press ▲▼ buttons to move a telescope along the altitude direction, ▶◀ to move a telescope along the azimuth direction. Brows the menu or move the cursor in operating menu.

- SPEED Key: To select slow speed (2X, 8X, 64X, 256X, and MAX)
- Light Key (☀): Turns on/off the red LED reading light on the back of the controller.
- HELP Key: For help and display more information on an object.
- HBX (handbox) port: connect the HC to SmartStar mount using a 6-wire RJ11 cable.

3.2. The LCD Screen

The 8405 HC consists of a large 4-line LCD screen, which displays all the information as shown in Figure 2. The user interface is simple and easy to learn.



Figure 2. #8405 Hand Controller LCD Information Screen

1. Target Name: displays the name of the target that telescope is currently pointed to.

- Park Position: A default position when the mount is turned on, *i.e.*, the telescope is pointed to zenith (altitude is 90°) and the mount is facing south (azimuth is 180°);
- An object name, such as “Mercury” or “Andromeda Galaxy”: Name of the Star or celestial object currently that is currently slewing, gotoing or tracking;
- LandMark #: The telescope is working in Land mode and is pointing to a land mark # (note: telescope does not track in land mode)
- User Position: The mount has been manually slewed to an object; or an R.A and DEC value of an object was manually entered; or a goto or tracking process has been interrupted.

2. Mount/GPS Status: display current status of the mount. If the mount equipped with a GPS (integrated GPS receiver or external GPS module), it also indicates GPS status, when the mount is turned on.

Stop (Mount Status): the telescope is in a standby position;

- Slew (Mount Status): the telescope is manually slewing to the target;
- Goto (Mount Status): the telescope is going to the target;
- Track (Mount Status): the telescope is tracking a target;
- Align (Mount Status): the telescope is in align mode;

- G-ON (GPS Status): GPS is on and trying to lock on to a satellite;
- G-OK (GPS Status): The connection between GPS receiver and satellites has been established (This status will be replaced by Mount Status after a few minutes).

3. R: Right Ascension of the telescope, or R.A.

4. D: Declination of the telescope, or DEC.

5. A: Altitude of the telescope (zenith is 90°).

6. Z: Azimuth of the telescope (north is 0°, east 90°, south 180°, and west 270°).

7. Local Date and Time: display local time in a format of YY-MM-DD HH:MM:SS.

8. Slew speed: There are 5 speeds: 2X, 8X, 64X, 256X (1°/sec), MAX(4°/sec). Press the SPEED key to change the speed while slewing.

4. Getting Started

In order to experience the full GOTO capability of GOTO technology it is important to set up the mount correctly before observation.

4.1. Level and Align the Mount

4.1.1. Level the Mount.

Leveling is critical for good GOTO and tracking accuracy.

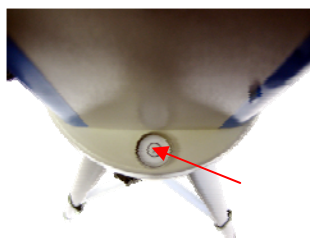

Level the mount by observing the bubble (shown) on the base of the mount by adjusting the tripod legs. The bubble should be in the center of

the circle. It is also recommended to use additional levelers (such as a torpedo leveler) to assure precise leveling. Turn the mount around by pressing ► or ◀ button to make sure it is always leveled during movement.

4.1.2. Initial Positions

Each time the mount is turned on the default position is Park Position, (*i.e.*, its altitude is $90^{\circ}0.0'$ and azimuth is $180^{\circ}0.0'$) which means the "SOUTH" mark is pointing to south and the telescope is pointing straight up at the Zenith. To set the Park Position you can:

1. Align the mount to south by moving the mount so that the South mark faces south. An additional compass is needed. Unlock the altitude lock (#4) and rotate the telescope to point straight up at the Zenith. A torpedo level may help. Make sure the mount is leveled. Then turn the mount power on.

or

2. Turn the mount power on. Press the SPEED button to select a slew speed (MAX for fast slew and 2X for fine tuning). Turn the SOUTH mark pointing to south using ► or ◀ button. An additional compass is needed. Rotate the telescope to point to zenith using the ▲ or ▼ buttons. A torpedo level may help. Then turn the mount power off and turn it on. Or you can press MENU. Scroll down to "Set Telescope Coord." Press ENTER. The default number is "Alt: $90^{\circ}00.0'$ and Azi: $180^{\circ}00.0'$ ". Press ENTER to complete the initialization.

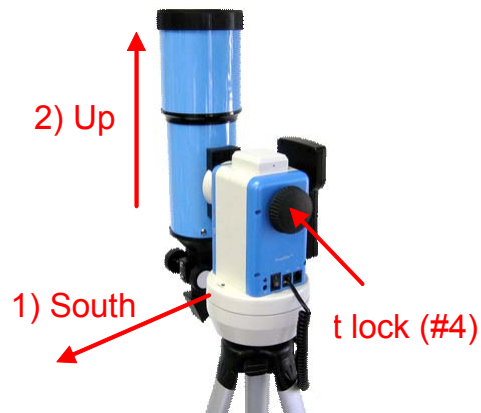

4.2. Setting Up the Mount

For a SmartStar[®] telescope equipped with a GPS receiver, the local time, longitude and latitude information will be received from satellites after a link is established. For units without a GPS receiver this information can be entered manually. Regardless, manual input is still needed for the time zone and Daylight Time Saving settings for all models.

A clear sky outside is needed for GPS to communicate well with the satellites.

4.2.1. Time and Site Set Up

This is critical to ensure the telescope will point to the right direction.

Press MENU button. From the main menu scroll down and select "Set Up Controller"

```
Select and slew
Land Objects
Sync. to Target
Set Up Controller
```

Press ENTER. Select “Set Up Time and Site”

```
Set Up Time and Site
Set Display Info
Set Key Beep
Set Azi Work Mode
```

Press ENTER. The Set Local Time screen will show:

```
Set Local Time:
2009-06-01 11:55:09
DaylightTime Saving Y
```

Set local time:

Use the ◀ or ▶ key to move the cursor, and the ▲ or ▼ button to change the numbers.

Set daylight saving time:

Use ▲ or ▼ button to toggle the DaylightTime Saving between Y and N. Press ENTER to go to Setup Site Info screen:

```
Setup Site Info:
Longi: W071d27m47s
Lati : N42d15m40s
300 Min. behind UT
```

“W/E” means west/east hemisphere; “N/S” means north/south hemisphere; “d” means degree; “m” means minute; and “s” means second.

Set site coordinates:

Use the ◀ or ▶ key to move the cursor, and the ▲ or ▼ button to change the numbers or toggle between “W” and “E”, “N” and “S”.

The site coordinates information can be found online at sites such as GPSVisualizer <http://www.gpsvisualizer.com/geocode>). Simply enter a city name or address.

Set time zone

Press ◀ or ▶ key. Move the cursor to the bottom of the screen to set the **time zone** information (add or subtract 60 minutes per time zone). Enter minutes “ahead” or “behind” of UT (universal time). The minimum time difference is 15 minutes.

- New York City is 300 minutes “behind” UT
- Los Angeles is 480 minutes “behind” UT
- Rome is 60 minutes “ahead” of UT
- Beijing is 480 minutes “ahead” of UT
- Sydney is 600 minutes “ahead” of UT

Time Zone	Hours behind UT	Enter Minutes
Hawaii	-10	600
Alaska	-9	540
Pacific	-8	480
Mountain	-7	420
Central	-6	360
Eastern	-5	300

All time zones in North America are *behind* UT as shown in the following table (Be sure it shows “behind” instead of “ahead of” UT).

To adjust minutes, use the ◀ or ▶ keys to move the cursor and the ▲ or ▼ keys to change the numbers. To change the “behind” or “ahead of” UT, move the cursor to “ahead of” and using ▲ or ▼ keys to toggle between “behind” and “ahead of”. When the number is correct press ENTER and go back to the previous screen.

For other parts of the world, time zone information can be found online such as <http://www.timeanddate.com/worldclock/>.
DO NOT COUNT DAYLIGHT SAVING TIME.

If your mount is equipped with a GPS receiver only Daylight Time Saving and Time Zone settings are needed. However, the local time and site info can still be manually entered (in case the GPS signal is too weak from clouds or buildings). It is always recommended to get the GPS coordinates before traveling to a new observation site.

4.2.2. Using your telescope

Selecting an Eyepiece:

1. Always begin viewing with the lowest power eyepiece. (Note: a 25 mm focal length eyepiece has a lower power than a 10 mm one.) A formula can be used to determine the power of each eyepiece: Telescope focal length divided by eyepiece focal length equals magnification. Ex. $400\text{mm} \div 25\text{mm} = 16\text{X}$ (magnification)

2. Included with this telescope is a 45° Erecting Diagonal Prism. The Erecting Diagonal Prism is used to erect the image you will see. Astronomical telescopes are designed in such a way that the image you see may be UPSIDE DOWN and REVERSED. This is acceptable for viewing celestial bodies. However, it will feel strange when observing a land object or a bird.

Focusing Telescope:

1. After selecting the desired eyepiece aim the telescope tube at a land-based target at least 200 yards away (e.g. A telephone pole or building). Fully extend focusing tube by turning the focus knob.

2. While looking through selected eyepiece, slowly retract focusing tube by turning focusing knob until object comes into focus.

4.2.3. Go to the Moon

After performing these setups, the mount is ready to GOTO and track objects. The most common object will be Moon.

Press MENU button, select "Select and Slew" by press ENTER button. Select "Planets, Sun, Moon", and using ▲ or ▼ button to select Moon. Press ENTER. The telescope will automatically slew to the Moon and lock on. Press BACK key to stop GOTO. It will automatically begin to track once it locks on to it. Use the arrow keys to center the Moon in your eyepiece, if it is not centered. Press ENTER key to stop the tracking.

4.2.4. Initial Star Alignment

A simple alignment/synchronization can be performed to improve the GOTO and tracking accuracy. To do so, press MENU button, scroll down to "Align", select "Solarsys Align" and press ENTER. The screen will list Moon, Sun and other planets for you to select from. Select an object using ▲ or ▼ key. Then press ENTER. The mount will slew to the object. Use ◀ ▶ ▲ or ▼ key to center the object in your eyepiece. Press SPEED button to change the slew speed if needed. Then press ENTER to complete the alignment. Or press the BACK key to cancel the process.

An alternate way is performing "Sync to Target". To do so, press MENU button, select "Select and Slew" and press ENTER. Then select a known sky object, such as Moon from "Planets, Sun, Moon" menu and press ENTER. The mount will slew to the Moon. When the mount stopped slewing, the Moon could be just inside your eyepiece or way off. Press MENU button and scroll down the menu to "Sync to Target" and press ENTER. Follow the instruction, use ◀

► ▲ and ▼ keys to move the Moon in the center of your eyepiece and press ENTER.

4.3. Turn Off the Mount

When finishing observing, always move the mount to Park Position. If the mount is not moved, no initial set up is needed when powered on the next time. To do so, press the MENU button, scroll down to “Park Telescope” and press ENTER. Turn the power off.

5. Use SmartStar® R-80

5.1. Manual Operation of the Telescope

You may observe land and astronomical objects using GOTONOVA's arrow keys.

After the telescope was assembled (referring to Section 2. Telescope Assembly), flip the ON/OFF switch on the telescope mount to the ON position. Use ►, ◀, ▼ or ▲ buttons to point the telescope to desired object. You may need using SPEED key to change the slewing speed.

5.2. Slew to an Object

Press MENU button, from the main menu, select "Select and Slew." Select an object you would like to observe and press ENTER key.

The GOTONOVA™ 8405 hand controller has a database consists of over 10,000 objects. Use ► or ◀ button to move the cursor and ▼ or ▲ button to change the number. "◊" indicates the object is above the horizon, and "◊" means it is below the horizon. Only those objects above the horizon can be observed. In some catalogs, those stars below the horizon may not display.

5.2.1. Planets, Sun, Moon

There are 9 objects in Solar system.

5.2.2. Deep Sky Objects

- Named Deepsky Objects: It consists of 137 deep sky objects with their common names. More information will be available by pressing HELP key. A list of named deep sky objects is also attached in Appendix C.
- Messier Catalog: It consists of all 110 objects in Messier catalog. More information will be available by pressing HELP key.

- NGC Catalog: It consists of 7840 objects in NGC catalog. Use ► or ◀ button to move the cursor and ▼ or ▲ button to change the number.

5.2.3. Comets

It contains up to 64 comets. This database is customer upgradeable.

5.2.4. Asteroids

It contains up to 64 asteroids. This database is customer upgradeable.

5.2.5. Stars

- Named Stars: It consists of 191 stars with their common names. They are listed alphabetically. A list is attached in Appendix C.
- Constellations: It consists of 88 modern constellations with their names. They are listed alphabetically. A list is attached in Appendix C.
- Double Stars: It consists of 211 double stars. A list is attached in Appendix C.
- SAO Bright Stars: It consists of 5000+ bright SAO catalog objects. They are listed numerically.

5.2.6. User RA&DEC JD2000 Objects

It can consist up to 256 user predefined objects. These objects need to be entered before they can be selected for slewing (Refer to 5.7.1 User RA&DEC JD2000).

5.2.7. Enter Position

Go to a target by entering its R.A. and DEC numbers.

5.2.8. Watch List

A watch list is a list of your favorite celestial objects in the database. It can be selected for slewing. User can add, delete and browse the watch list. (Refer to 5.7. Watch List).

5.2.9. Watch List Auto

This function will set the mount automatically slew to all the objects listed in Watch List at a preset time interval. The time interval can be set to from 10 seconds to 1200 seconds by using ▼ or ▲ button, with 10 seconds increment.

5.3. Land Objects

Up to 4 your favorite land objects can be stored in the hand controller. Press MENU, select "Land Objects" and press ENTER, the Land Objects screen will show.

```
Goto saved      1 2 3 4
Save new        1 2 3 4
Input Coord.    1 2 3 4
A 10° 0.0'   Z 10° 0.0'
```

Goto saved (land object):

Use ▼ or ▲ button to move the cursor to "Goto saved" line, use ► or ◀ button to a saved land object and press ENTER. The mount will automatically slew to the target.

This function only works if a land object has been stored in database.

Save new (land objects)

Use ▼ or ▲ button to move the cursor to "Save new" line, use ► or ◀ button to select the object number you want to store, and press ENTER. A landmark screen will show:

```
LandMark 1      Stop
A 13° 0.0'   Z 25°58.8'
09-05-04  15:43:27  2X
```

Use ◀ ► ▲ and ▼ keys to slew the telescope to the target you want to observe, press ENTER to save the target. Press SPEED button to change the slew speed if needed.

Input coordinates (of a land object)

Use ▼ or ▲ button to move the cursor to "Input coord." line, use ► or ◀ button to object number you want to store, and press ENTER. A coordinate setting screen will show:

```
Enter Alt. Azi.
Alt: 13° 0.0'
Azi: 25°58.8'
```

Use ► or ◀ button to move the cursor, and ▼ or ▲ button to change the number. Press ENTER to finish land object coordinates setting.

Press BACK to back to main menu.

5.4. Sync to Target

This operation will match the telescope's current coordinates to Target Right Ascension and Declination. After slew to an object, move the cursor to "Sync to Target" and press ENTER. Follow the screen to do the sync. Using this function can improve the GOTO accuracy in nearby sky. Multiple syncs can be performed if needed.

"Sync to Target" will only work after "Select and slew" was performed. You may need using SPEED key to change the slewing speed to make the centering procedure easier. A default slew speed is 2X.

5.5. Set Up Controller

5.5.1. Set Display Info

- Adjust LCD Contrast

Use arrow keys to adjust LCD display contrast. Press ENTER.

```
Adjust LCD Contrast
████████████████████
```

- LCD Back Light.

Use arrow keys to adjust LCD screen back light intensity. Press ENTER.

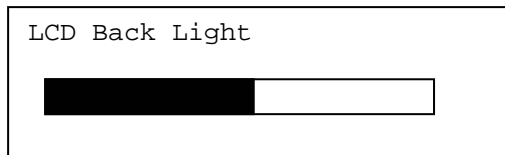

- Keypad Backlight.

Use arrow keys to adjust keypad backlight. Press ENTER.

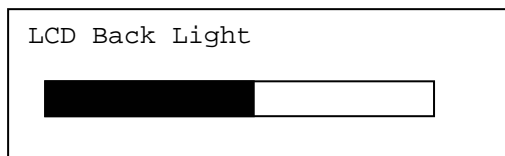

5.5.2. Set Key Beep

Turn the key beep on/off.

5.5.3. Set Azi Work Mode

This function will set the mount azimuth mode while performing GOTO. There are two modes for selection:

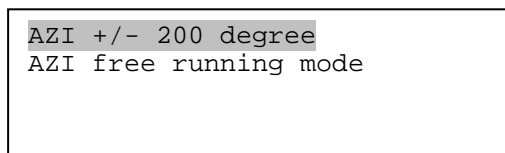

The “AZI +/- 200 degree” will rotate the mount between -200° and $+200^{\circ}$ in azimuth direction to avoid AC/DC power line wrapping. However, the mount may take a longer path to slew to an object. The “AZI free running mode” will take a shortest path while rotating along the azimuth direction, which is best for battery operation. The default setting is “AZI +/- 200 degree” mode.

5.5.4. Reset All

Reset all settings to factory default data.

5.6. Align

This function is used for align the telescope. Before star alignment, please make sure the mount is well leveled. In addition to “Solarsys Align,” the system also provides “One Star Align” and “Two Star Align”. Either one can be selected for telescope alignment.

5.6.1. Solarsys Align

Press “MENU”, scroll down the menu and select “Align”. Press ENTER and select “Solarsys Align”. Select any one of the listed solar system object as your alignment target, such as Moon. Press ENTER. If the Moon is above the horizon, the telescope will auto slew to it. If the Moon is not in the center of you eyepiece, use ◀ ▶ ▲ or ▼ key to center the object in your eyepiece. Press SPEED button to change the slew speed if needed. Then press ENTER to complete the alignment.

5.6.2. One Star Align

From the main menu, select “Align”. Select “One Star Align” and press ENTER. A list of bright align stars that are above the horizon is computed based on your local time and location. These stars are listed alphabetically. Use ▲ or ▼ button to select a star and press ENTER. The mount will slew to it automatically. Use ◀ ▶ ▲ or ▼ key to center the object in your eyepiece. Press SPEED button to change the slew speed if needed. Then press ENTER to complete the alignment. Or press the BACK key to cancel the process.

If you have a very good initial setup, one star alignment should be sufficient for good GOTO accuracy. To increase the accuracy you may choose to do two star alignment.

5.6.3. Two Star Alignment

Two star alignment will increase the GOTO accuracy of the mount. It is suggested to do two star alignment after one star alignment.

Select "Two Star Align" in the Align menu. Use ▲ or ▼ button to select a star and press ENTER. The mount will slew to it automatically. Use ◀ ▶ ▲ or ▼ key to center the object in your eyepiece. Press SPEED button to change the slew speed if needed. Then press ENTER to complete the alignment. After you finish the first star, the system will prompt you to choose the second star. Repeat the process to finish the second star alignment. An "Align OK!" screen will show briefly. To obtain a better alignment effect, it is suggested to choose two align stars far apart.

"Two Star Align" result will be overridden if "Solarsys Align", "One Star Align" or "Sync. to Target" is performed after "Two Star Align."

5.7. Modify Star Catalog

Besides various star lists available in the hand controller, users can add, edit or delete their own defined objects. The comets and asteroids list also can be edited. Up to 256 user objects can be added or modified. For comets and asteroids, the maximum number is 64, which includes the preloaded objects.

To modify a star catalog, press MENU, use ▲ or ▼ button move the cursor to "Modify star catalog" and press ENTER. A following screen will show:

```
User RA&DEC JD2000
Comets
Asteroids
```

Use ▲ or ▼ button to select user objects, comets or asteroids.

5.7.1. User RA&DEC JD2000

Select "User RA&DEC JD2000" and press ENTER, a menu like following will show:

```
Add a new object
Edit one data
Delete one data
Delete all
```

Add a new object:

Use ▼ or ▲ button to move the cursor to "Add a new object" line, and press ENTER. Enter the name of your object by using ▲ or ▼ key to change the display from 1 to 9, space, - and A to Z, and ◀ or ▶ key to move the cursor. Press ENTER when you are done. A screen will display to ask you to enter R.A. and DEC. numbers:

```
Enetr R.A. DEC
RA: 00h00.0m
DEC: +00d00.0m
```

Use◀ or ▶ key to move the cursor and ▲ or ▼ key to change the numbers of your object. RA ranges from 0 hour to 24 hour and DEC from -90 degree to +90 degree. Press ENTER when it is done. A confirmation screen will show:

```
Save to No. 1 ?
Press "ENTER" to
Confirm
Press, "BACK" cancel
```

Press ENTER to confirm. The user object will be stored in the hand controller in sequence. Up to 256 objects can be added. Press BACK to back to Modify Star Catalog menu.

Edit one data

Use ▼ or ▲ button to move the cursor to "Edit one data" line, and press ENTER. A user object screen will show:

```
No. 001 ☉
BX
R: 4h38.7m D:19°56.8'
A -31°10.2' Z303°44.1'
```

The first line shows the number of

the user object and if it is above the horizon. The second line shows the name of the user object, here is "BX". The third line shows target's current RA and DEC coordinates. The bottom line shows object's altitude and azimuth position. Use ◀ or ▶ move the cursor position and ▲ or ▼ key change the number to adjust the object you want to edit. Press ENTER when it is right.

Follow the same procedure as "Add a new object" to edit it. Press BACK to back to Modify Star Catalog menu.

Delete one data

Use ▼ or ▲ button to move the cursor to "Delete one data" line, and press ENTER. A user object screen will show:

```
No. 001 ☉
BX
R: 4h38.7m D:19°56.8'
A -31°10.2' Z303°44.1'
```

Use ▶ or ◀ button to move the cursor, and ▼ or ▲ button to change the number. Press ENTER to delete selected object.

Press BACK to back to Modify Star Catalog menu.

Delete all

Use ▼ or ▲ button to move the cursor to "Delete all" line, and press ENTER to delete all User RA&DEC JD2000 data.

5.7.2. Comets

Select "Comets" and press ENTER, a menu like following will show:

```
Add a new comet
Edit one comet
Delete one comet
Reset all comets
```

Add a new comet:

The hand controller has 64 preloaded comets. Before a new user comet can be added, a existing comet record has to be deleted. (See **Delete one comet**)

Select "Add a new comet" and press ENTER. Enter the name of your object by using ▲ or ▼ key to change the display from 1 to 9, space, - and A to Z, and ◀ or ▶ key to move the cursor. It will then ask the following information: Year, Month, Day, e, q, w, Omega and i. After entering all these parameters, A confirmation screen will show:

```
Save to No.          1 ?
Press "ENTER" to
Confirm
Press, "BACK" cancel
```

Press ENTER to confirm. **The user object will be stored in previous deleted comet position.** It can be selected and slewed from Comets menu. Press BACK to back to Modify Star Catalog menu.

Edit one comet

Use ▼ or ▲ button to move the cursor to "Edit one comet" line, and press ENTER. A user object screen will show:

```
No. 01 ☉
6P d'Arrest
R: 5h31.2m D:10°20.8'
A 31°49.5' Z253°39.9'
```

The first line shows the number of this comet and if it is above the horizon. The second line shows the name of the comet, here is "6P d'Arrest". The third line shows comet's current RA and DEC coordinates. The bottom line shows its altitude and

azimuth position. Use ◀ or ▶ move the cursor position and ▲ or ▼ key change the number to adjust the object you want to edit. Press ENTER when it is right.

Follow the same procedure as “Add a new comet” to edit it. Press BACK to back to Modify Star Catalog menu.

Delete one comet

Use ▼ or ▲ button to move the cursor to “Delete one comet” line, and press ENTER. A screen consists comet information will show:

```
No. 01 ☉
6P d'Arrest
R: 5h31.2m D:10°20.8'
A 31°49.5' Z253°39.9'
```

Use ▶ or ◀ button to move the cursor, and ▼ or ▲ button to change the number. Press ENTER to delete selected object.

Press BACK to back to Modify Star Catalog menu.

Reset all comets

Use ▼ or ▲ button to move the cursor to “Reset all comets” line, and press ENTER to restore all deleted or modified comets data to factory default setting.

5.7.3. Asteroids

Select “Asteroids” and press ENTER, a menu like following will show:

```
Add a new asteroid
Edit one asteroid
Delete one asteroid
Reset asteroids data
```

Refer to 5.7.2 Comets to set the Asteroids.

5.8. Watch List

A watch list is a list of your favorite celestial objects in the database. User can add, delete and browse the watch list. All celestial objects, include User Defined object, can be compiled into the list. Up to 20 objects can be added to the watch list.

To setup/modify a Watch List, press MENU, use ▲ or ▼ button move the cursor to “Watch List” and press ENTER. A following screen will show:

```
Add a watch object
Delete one data
Delete all
Browse the list
```

Select “Add a watch object” and press ENTER. Browse the celestial object list and select the one you want to watch by press ENTER. Follow the screen prompt to confirm the selection. After you are done, press BACK to back to Watch List menu.

You also can delete one or all objects in your watching list. After the watch list is set, it can be observed through “Select and Slew” operation, either w atching them manually or automatically using Watch List Auto.

5.9. Set Telescope Coord.

Set the current Altitude and Azimuth of your telescope.

5.10. Park Scope

Park your telescope. Return the telescope to its initial position, *i.e.*, its altitude is 90°0.0' and azimuth is 180°0.0'.

6. Maintenance and Servicing

6.1. Maintenance

The SmartStar® R-80 telescope is a precision optical instrument designed to yield a lifetime of rewarding applications. Given the care and respect due any precision instrument, your telescope will rarely require factory servicing or maintenance. Maintenance guidelines include:

1. Using wet cloth to clean the mount and hand controller. Do not use the solvent.
2. Leave the dust cap on while not operating the telescope. Avoid cleaning the telescope's optics. A little dust on the front surface of the telescope's correcting lens causes virtually no degradation of image quality and should not be considered a reason to clean the lens.
3. When absolutely necessary, dust on the front lens should be removed with gentle strokes of a camel hair brush, a soft glass clean cloth or blown off with an ear syringe (available at any pharmacy). Do not use a commercial photographic lens cleaner.
4. Organic materials (e.g., fingerprints) on the front lens may be removed with a solution of 3 parts distilled water to 1 part isopropyl alcohol. Use soft, white facial tissues or cotton balls and make short, gentle strokes. Change tissues often. Do not use scented, colored, or lotioned tissues as damage could result to the optics.
5. If your telescope is used outdoors on a humid night, telescope surfaces may accumulate water condensation. While such condensation does not normally cause any damage to the telescope, it is recommended that wait the entire telescope be dried before being packed away. Do not wipe any of the optical surfaces. In addition, the dust cap should not be placed back on

to the optical tube until the telescope is thoroughly dry.

6. If your telescope is not to be used for an extended period, perhaps for one month or more, it is advisable to remove the batteries from battery holder, if they are installed. Batteries left installed for prolonged periods may leak, causing damage to the telescope's electronic circuitry.

7. Do not leave your telescope outdoors on a warm day or inside a sealed car for an extended period of time. Excessive ambient temperatures can damage the telescope's internal lubrication and electronic circuitry.

6.2. Storage and Transport

When not in use, store the telescope in a cool, dry place. Do not expose the instrument to excessive heat or moisture. It is best to store the telescope in its original box with the altitude lock knob unlocked. If shipping the telescope, use the original box and packing material to protect the telescope during shipment.

When transporting the telescope, take care not to bump or drop the instrument; this type of abuse can damage the optics or affect the GOTO tracking accuracy.

6.3. Troubleshooting

The following suggestions may be helpful with operation of the SmartStar R-80.

The power indicator light on the mount does not come on or there is no response when pressing hand controller's arrow keys:

- (1) Verify that the power switch on the mount is in the ON position.
- (2) Verify that the hand controller cord is firmly connected to the HBX port on

the mount, or switch the cord to the other HBX port.

- (3) Check the power source, which include:
 - Using the battery? Are the batteries installed correctly? Are the batteries fresh? How long have they been used? (frequent slew and GOTO will deplete battery power very quickly)
 - Using AC or DC adapter? Check the plugs to the mount and to the power outlet.
 - Using extension cord? Make sure the cord is in good condition. Power drop along the extension cord was known to cause the problem. Also check all the plugs and connections.
- (4) If the telescope does not respond to commands, set the power switch to OFF and then back to ON.
- (5) If the telescope does not slew after power is applied or if the motor quits or stalls, verify that there are no physical obstructions that would impede telescope movement.

Cannot seem to focus (No image appears in the eyepiece):

- (1) Confirm that the dust cap has been removed from the telescope.
- (2) Keep turning the focus knob. Your telescope has a fine focusing mechanism which allows you to focus an image very precisely. However, this means that you may have to rotate the focus knob 20 to 40 complete turns to achieve focus, particularly the first time you use your telescope. After that, fewer turns will be needed.

Images through the eyepiece appear unfocused or distorted:

- (1) The magnification used may be too high for the seeing conditions. Back off to a lower power eyepiece.
- (2) If inside a warm house or building, move outside. Interior air conditions may distort terrestrial (land) or celestial images, making it difficult, if not impossible, to obtain a sharp focus. For

optimal viewing, use the telescope outside in the open air instead of observing through an open or closed window or screen.

- (3) If viewing a land object on a warm day, heat waves distort the image.
- (4) The optics within the telescope need time to adjust to the outside ambient temperature to provide the sharpest image. To "cool down" the optics, set the telescope outside for 10 to 15 minutes before observing begins.

Error Message "Warning! Motor driver overloaded."

- (1) Check the hand controller cord. Unplug it and re-plug into, or plug it into another HBX port.
- (2) Check the power source.

The telescope does not GOTO the right object, or the alignment is always wrong:

- (1) Leveling (very important).
- (2) Site information (minutes ahead or behind UT, DST).
- (3) Check the power source.

6.4. iOptron Customer Service

If you have a question concerning your telescope, contact the iOptron Customer Service Department. Customer Service hours are 9:00 AM to 5:00 PM, Eastern Time, Monday through Friday. In the unlikely event that the telescope requires factory servicing or repairs, write or call the iOptron Customer Service Department first, before returning the telescope to the factory, giving full particulars as to the nature of the problem, as well as your name, address, and daytime telephone number. The great majority of servicing issues can be resolved by telephone, avoiding return of the telescope to the factory.

It is also suggested to send technical questions to support@ioptron.com.

Appendix A. Technical Specifications

Mount	AltAzimuth Mount
Body Materials	Die-cast Aluminum
Motor	Dual-Axis DC Servo motor with encoders
Gear	POM worm wheel/Nylon 6 worm gear
Bearing	4 steel ball bearings
Speed	Dual-Axis, 5-Gear, Electronic (2×,8×,64×,256×,MAX)
GPS	32-channel GPS (GPS model only)
GOTO System	GOTONOVA™ 8405
Processor	32bit ARM
Object in Database	10,000+
GOTO accuracy	1 Arc Min. (Typical)
Tracking	Automatic
Payload	7.5 lb
Optical Design	Achromatic Refractor
Clear Aperture	80 mm
Focal Length	400mm
Focal Ratio	f/5
Resolution Power	1.4 arc sec
Optical Tube Materials	Aluminum
Battery	AA x 8 (Not Included)
Power Requirement	DC 12V±2V, >1.2A
Operating Temperature	0 ~ 40°C
Weight with tripod	5.5 lbs (without OTA)
Weight w/ Tripod, OTA	7.7 lbs

Appendix B. GOTO NOVA™ 8405 HC MENU STRUCTURE

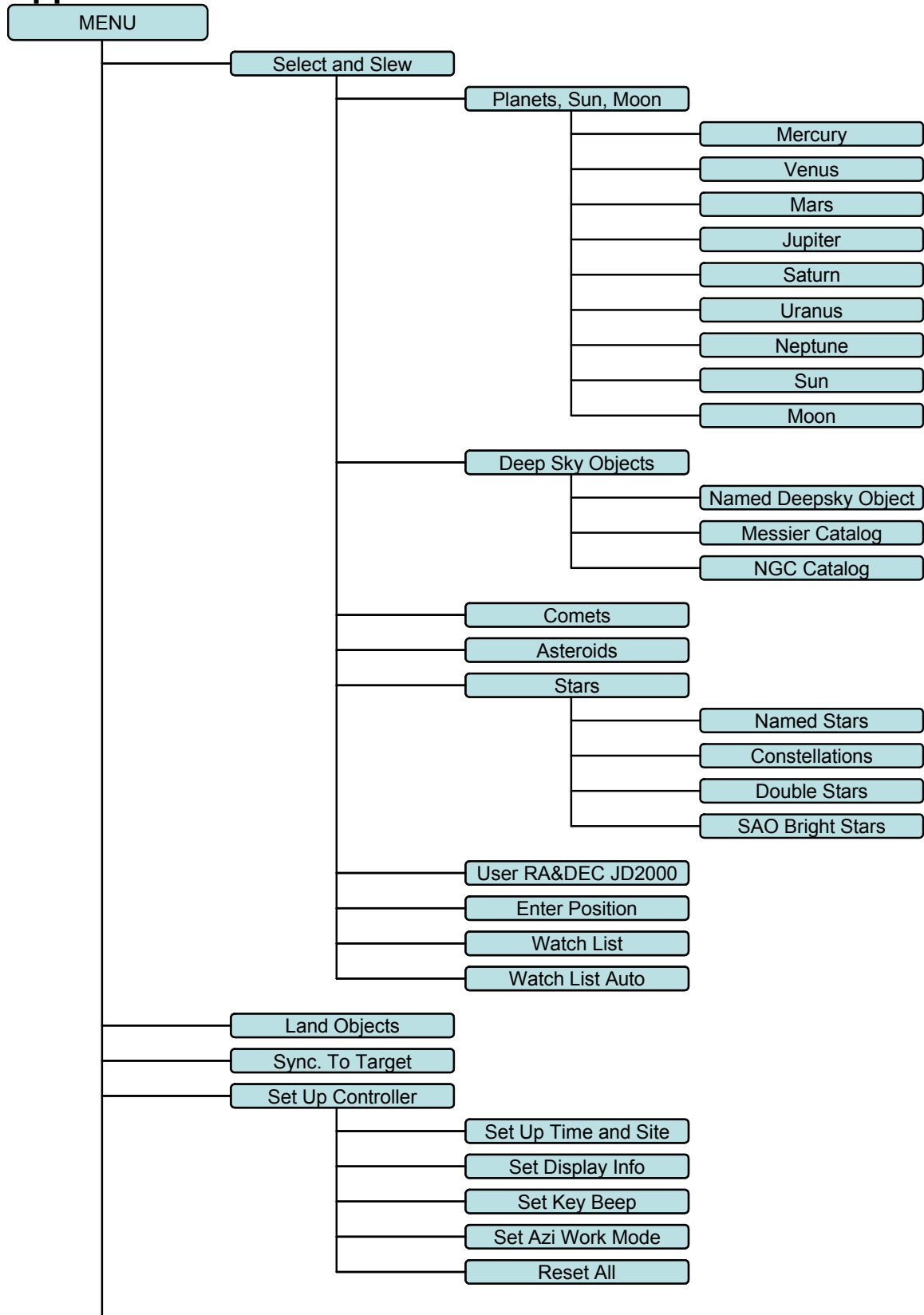

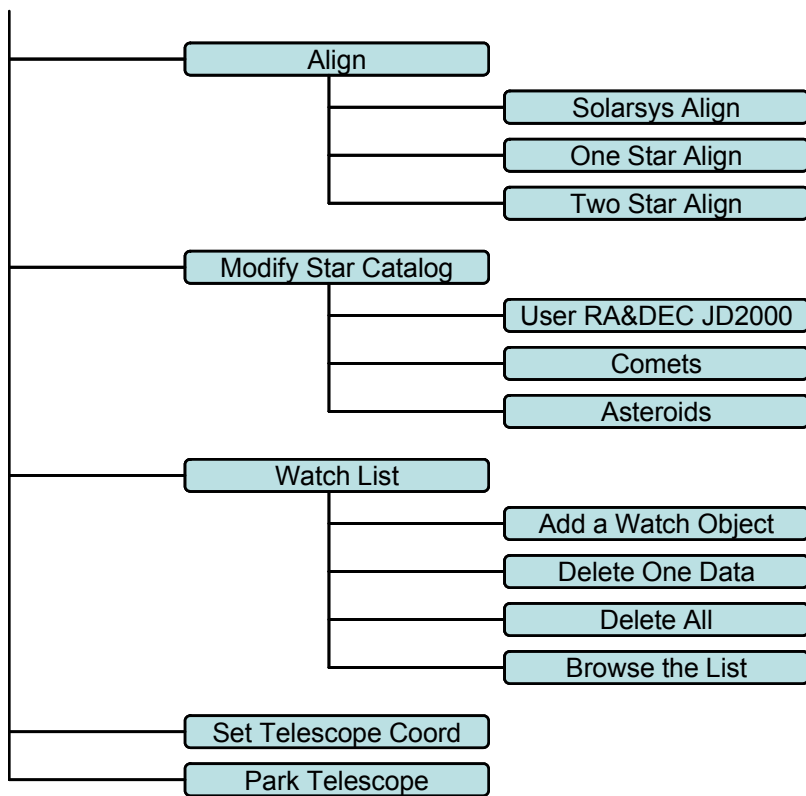

Appendix C. GOTONOVA™ Star List

Modern Constellations

for 8405

No.	Constellation	Abbreviation
1	Andromeda	And
2	Antlia	Ant
3	Apus	Aps
4	Aquarius	Aqr
5	Aquila	Aql
6	Ara	Ara
7	Aries	Ari
8	Auriga	Aur
9	Boötes	Boo
10	Caelum	Cae
11	Camelopardalis	Cam
12	Cancer	Cnc
13	Canes Venatici	CVn
14	Canis Major	CMa
15	Canis Minor	CMi
16	Capricornus	Cap
17	Carina	Car
18	Cassiopeia	Cas
19	Centaurus	Cen
20	Cepheus	Cep
21	Cetus	Cet
22	Chamaeleon	Cha
23	Circinus	Cir
24	Columba	Col
25	Coma Berenices	Com
26	Corona Australis	CrA
27	Corona Borealis	CrB
28	Corvus	Crv
29	Crater	Crt
30	Crux	Cru
31	Cygnus	Cyg
32	Delphinus	Del
33	Dorado	Dor
34	Draco	Dra
35	Equuleus	Equ
36	Eridanus	Eri
37	Fornax	For
38	Gemini	Gem
39	Grus	Gru
40	Hercules	Her
41	Horologium	Hor
42	Hydra	Hya
43	Hydrus	Hyi
44	Indus	Ind

No.	Constellation	Abbreviation
45	Lacerta	Lac
46	Leo	Leo
47	Leo Minor	LMi
48	Lepus	Lep
49	Libra	Lib
50	Lupus	Lup
51	Lynx	Lyn
52	Lyra	Lyr
53	Mensa	Men
54	Microscopium	Mic
55	Monoceros	Mon
56	Musca	Mus
57	Norma	Nor
58	Octans	Oct
59	Ophiuchus	Oph
60	Orion	Ori
61	Pavo	Pav
62	Pegasus	Peg
63	Perseus	Per
64	Phoenix	Phe
65	Pictor	Pic
66	Pisces	Psc
67	Piscis Austrinus	PsA
68	Puppis	Pup
69	Pyxis	Pyx
70	Reticulum	Ret
71	Sagitta	Sge
72	Sagittarius	Sgr
73	Scorpius	Sco
74	Sculptor	Scl
75	Scutum	Sct
76	Serpens	Ser
77	Sextans	Sex
78	Taurus	Tau
79	Telescopium	Tel
80	Triangulum	Tri
81	Triangulum Australe	TrA
82	Tucana	Tuc
83	Ursa Major	UMa
84	Ursa Minor	UMi
85	Vela	Vel
86	Virgo	Vir
87	Volans	Vol
88	Vulpecula	Vul

Messier

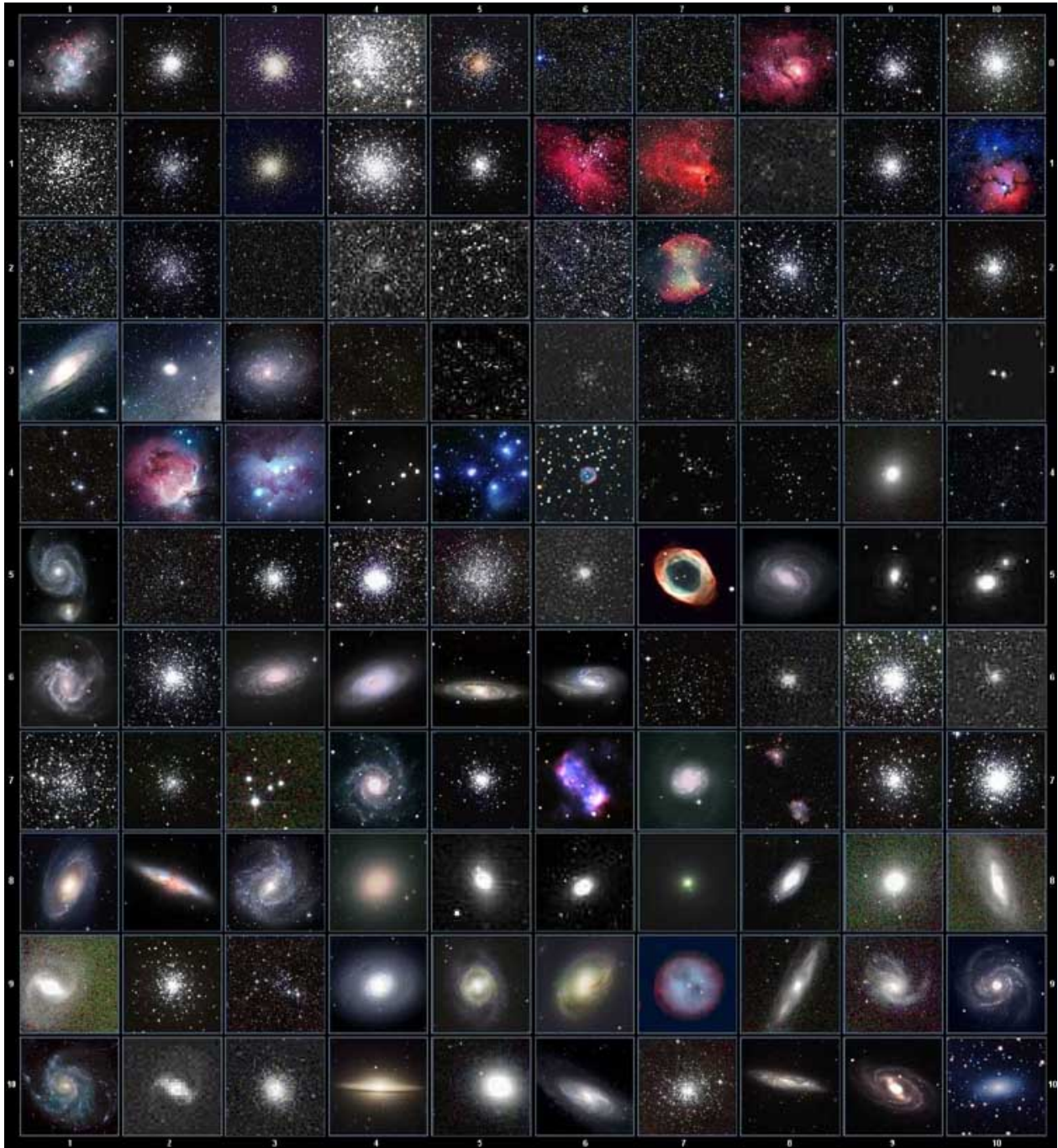

This table is licensed under the [GNU Free Documentation License](https://www.gnu.org/licenses/fdl.html). It uses material from the [Wikipedia article List of Messier objects](https://en.wikipedia.org/wiki/List_of_Messier_objects).

GOTONOVA Deep Sky Object List for 8405

ID No.	OBJECT	ID No.	OBJECT
1	47 Tucanae	48	Fornax A
2	Andromeda Galaxy	49	gamma Cas Nebula
3	Antennae	50	gamma Cyg Nebula
4	Arp's Spiral	51	Gem Cluster
5	Atom for Peace Galaxy	52	Ghost of Jupiter
6	Barnard's Galaxy	53	Grus Quartet/Galaxy
7	Baxendell's Nebula	54	h Persei/Open cluster
8	Bear Claw Nebula	55	Helix Nebula
9	Beehive Cluster	56	Helix
10	Bipolar Nebula	57	Hercules Cluster
11	Blackeye Galaxy	58	Herschel's Ray
12	Blinking Planetary	59	Hind's Variable Nebula
13	Blue Flash Nebula	60	Hubble's Variable Nebula
14	Blue Planetary	61	Intergalactic Wanderer
15	Blue Snowball Nebula	62	Jewel Box Cluster
16	Bode's Nebula	63	kappa Crucis Cluster
17	Box Nebula	64	Keenan's System
18	Bubble Nebula	65	Keyhole Nebula
19	Bug Nebula	66	Kidney Bean Galaxy
20	Butterfly Cluster	67	Lagoon Nebula
21	Butterfly Nebula	68	lambda CEN Cluster
22	California Nebula	69	Little Dumbbell
23	Carafe Group	70	Little Gem Nebula
24	Cat's Eye Nebula	71	Little Gem
25	Centaurus A	72	Little Ghost Nebula
26	Cetus A	73	Markarian's Chain
27	chi Persei	74	Mice Galaxies/N4676A
28	Christmas Tree Cluster	75	Miniature Spiral
29	Clown Face Nebula	76	Mirach's Ghost
30	Cocoon Nebula	77	mu NOR Cluster
31	Coddington's Nebula	78	North America Nebula
32	Cone Nebula	79	Nubecula Minor
33	Copeland's Septet	80	omega Centuri
34	Cork Nebula	81	Omega Nebula
35	Crab Nebula	82	omicron Velorum Cluster
36	Crescent Nebula	83	Orion Nebula
37	Double Cluster	84	Owl Nebula
38	Duck Nebula	85	Pancake
39	Dumbbell Nebula	86	Papillon
40	Eagle Nebula (SER)	87	Pelican Nebula
41	Eagle Nebula	88	Perseus A
42	Eight-Burst Nebula	89	Phantom Streak Nebula
43	epsilon Orionis Nebula	90	Pinwheel Galaxy
44	Eskimo Nebula	91	Pleiades Nebula (Maia)
45	eta Carinae Nebula	92	Pleiades Nebula (Merope)
46	Flame nebula	93	Polarissima Australis
47	Flaming Star Nebula	94	Polarissima Borealis

95	Praesepe	117	Sunflower Galaxy
96	Ptolemy's Cluster	118	Swan Nebula
97	rho Ophiuchi Nebula	119	Table of Scorpius
98	Ring Nebula	120	Tank Track Nebula
99	Ringtail Galaxy	121	Tarantula Nebula
100	Rosette Nebula	122	Taurus A
101	Running Chicken Nebula	123	Tempel's Nebula
102	Saturn Nebula	124	The Box
103	Sculptor Galaxy Group	125	The Eyes
104	Sculptor Galaxy	126	The Mice
105	Seyfert's Sextet	127	Toby Jug Nebula
106	Siamese Twins	128	Tom Thumb Cluster
107	Silver Dollar	129	Triangulum Galaxy
108	Small Magellanic Cloud	130	Trifid Nebula
109	Sombrero Galaxy	131	Ursa Major A
110	Southern Integral Sign	132	Veil Nebula
111	Southern Pleiades	133	Virgo A
112	Spindle Galaxy	134	Whirlpool Galaxy
113	Spindle	135	Wild Duck Cluster
114	Star Queen Nebula	136	Witchhead Nebula
115	Stephan's Quintet	137	Zwicky's Triplet
116	Struve's Lost Nebula		

GTONOVA Named Star List

for 8405

001 Acamar	049 Ascella	097 Kaus Australis	145 Rassalas
002 Achernar	050 Asellus Australis	098 Kaus Borealis	146 Rasagethi
003 Acrux	051 Asellus Borealis	099 Kaus Media	147 Rasalhague
004 Acubens	052 Aspidiske	100 Keid	148 Rastaba
005 Adhafera	053 Atik	101 Kitalpha	149 Regulus
006 Adhara	054 Atlas	102 Kochab	150 Rigel
007 Al Na'ir	055 Atria	103 Kornephoros	151 Rigel Kentaurus
008 Albali	056 Avoir	104 Kurhah	152 Ruchbah
009 Alberio	057 Azha	105 Lesath	153 Rukbat
010 Alchibar	058 Baten Kaitos	106 Maia	154 Sabik
011 Alcor	059 Beid	107 Marfik	155 Sadachbia
012 Alcyone	060 Bellatrix	108 Markab	156 Sadalbari
013 Aldebaran	061 Betelgeuse	109 Matar	157 Sadalmelik
014 Alderamin	062 Biham	110 Mebsuta	158 Sadalsuud
015 Alfirk	063 Canopus	111 Megrez	159 Sadr
016 Algedi	064 Capella	112 Meissa	160 Saiph
017 Algenib	065 Caph	113 Mekbuda	161 Scheat
018 Algiebra	066 Castor	114 Menkalinan	162 Schedar
019 Algol	067 Celabrai	115 Menkar	163 Seginus
020 Algorab	068 Celaeno	116 Menkent	164 Shaula
021 Alhena	069 Chara	117 Menkib	165 Sheiak
022 Alioth	070 Chertan	118 Merak	166 Sheratan
023 Alkaid	071 Cor Caroli	119 Merope	167 Sirius
024 Alkalurops	072 Cursa	120 Mesartim	168 Skat
025 Alkes	073 Dabih	121 Miaplacidus	169 Spica
026 Almach	074 Deneb	122 Mintaka	170 Sterope
027 Alnasl	075 Deneb Algedi	123 Mira	171 Sulafat
028 Alnilam	076 Deneb Kaitos	124 Mirach	172 Syrma
029 Alnitak	077 Denebola	125 Mirfak	173 Talitha
030 Alphard	078 Dubhe	126 Mirzam	174 Tania Australis
031 Alphecca	079 Edasich	127 Mizar	175 Tania Borealis
032 Alpheratz	080 Electra	128 Muphrid	176 Tarazed
033 Alrakis	081 Elnath	129 Muscida	177 Taygeta
034 Alrescha	082 Eltanin	130 Nashira	178 Thuban
035 Alshain	083 Enif	131 Nekkar	179 Unukalhai
036 Altair	084 Errai	132 Nihal	180 Vega
037 Altais	085 Fomalhaut	133 Nunki	181 Vindemiatrix
038 Alterf	086 Furud	134 Nusakan	182 Wasat
039 Aludra	087 Gacrux	135 Peacock	183 Wazn
040 Alula Australis	088 Giasuar	136 Phact	184 Yed Posterior
041 Alula Borealis	089 Gienah	137 Phecda	185 Yed Prior
042 Alya	090 Gomeisa	138 Pherkad	186 Zaniah
043 Ancha	091 Graffias	139 Pleione	187 Zaurak
044 Ankaa	092 Groombridge 1830	140 Polaris	188 Zavijava
045 Antares	093 Grumium	141 Pollux	189 Zosma
046 Arcturus	094 Hamal	142 Porrima	190 Zubenelgenubi
047 Arkab	095 Homan	143 Procyon	191 Zubeneschamali
048 Arneb	096 Izar	144 Propus	

GOTONOVA Double Star List

For 8405

No.	Object	Const	Sep.	Magitude	SAO	Comm. Name
1	Gam	And	9.8	2.3 / 5.1	37734	Almaak
2	Pi	And	35.9	4.4 / 8.6	54033	
3	Bet	Aql	12.8	3.7 / 11	125235	Alshain
4	11	Aql	17.5	5.2 / 8.7	104308	
5	15	Aql	34	5.5 / 7.2	142996	
6	E2489	Aql	8.2	5.6 / 8.6	104668	
7	57	Aql	36	5.8 / 6.5	143898	
8	Zet	Aqr	2.1	4.3 / 4.5	146108	
9	94	Aqr	12.7	5.3 / 7.3	165625	
10	41	Aqr	5.1	5.6 / 7.1	190986	
11	107	Aqr	6.6	5.7 / 6.7	165867	
12	12	Aqr	2.5	5.8 / 7.3	145065	
13	Tau	Aqr	23.7	5.8 / 9.0	165321	
14	Gam	Ari	7.8	4.8 / 4.8	92681	Mesartim
15	Lam	Ari	37.8	4.8 / 6.7	75051	
16	The	Aur	3.6	2.6 / 7.1	58636	
17	Nu	Aur	55	4.0 / 9.5	58502	
18	Ome	Aur	5.4	5.0 / 8.0	57548	
19	Eps	Boo	2.8	2.5 / 4.9	83500	Izar
20	Del	Boo	105	3.5 / 7.5	64589	
21	Mu 1	Boo	108	4.3 / 6.5	64686	Alkalurops
22	Tau	Boo	4.8	4.5 / 11	100706	
23	Kap	Boo	13.4	4.6 / 6.6	29046	
24	Xi	Boo	6.6	4.7 / 6.9	101250	
25	Pi	Boo	5.6	4.9 / 5.8	101139	
26	lot	Boo	38	4.9/7.5/13	29071	
27	E1835	Boo	6.2	5.1 / 6.9	120426	
28	44	Boo	2.2	5.3 / 6.2	45357	
29		Cam	2.4	4.2 / 8.5	24054	
30	32	Cam	21.6	5.3 / 5.8	2102	
31	Alp 2	Cap	6.6	3.6 / 10	163427	Secunda giedi
32	Alp 1	Cap	45	4.2 / 9.2	163422	Prima giedi
33	Pi	Cap	3.4	5.2 / 8.8	163592	
34	Omi	Cap	21	5.9 / 6.7	163625	
35	Alp	Cas	64.4	2.2 / 8.9	21609	Shedir
36	Eta	Cas	12.9	3.5 / 7.5	21732	Achird

No.	Object	Const	Sep.	Magitude	SAO	Comm. Name
37	lot	Cas	2.3	4.7/7.0/8.2	12298	
38	Psi	Cas	25	4.7 / 8.9	11751	
39	Sig	Cas	3.1	5.0 / 7.1	35947	
40	E3053	Cas	15.2	5.9 / 7.3	10937	
41	3	Cen	7.9	4.5 / 6.0	204916	
42	Bet	Cep	13.6	3.2 / 7.9	10057	Alfirk
43	Del	Cep	41	3.5 / 7.5	34508	
44	Xi	Cep	7.6	4.3 / 6.2	19827	Al kurhah
45	Kap	Cep	7.4	4.4 / 8.4	9665	
46	Omi	Cep	2.8	4.9 / 7.1	20554	
47	E2840	Cep	18.3	5.5 / 7.3	33819	
48	E2883	Cep	14.6	5.6 / 7.6	19922	
49	Gam	Cet	2.8	5.0 / 7.7	110707	Kaffaljidhma
50	37	Cet	50	5.2 / 8.7	129193	
51	66	Cet	16.5	5.7 / 7.5	129752	
52	Eps	CMA	7.5	1.5 / 7.4	172676	Adhara
53	Tau	CMA	8.2	4.4/10/11	173446	
54	145	CMA	25.8	4.8 / 6.8	173349	
55	Mu	CMA	2.8	5.0 / 7.0	152123	
56	Nu 1	CMA	17.5	5.8 / 8.5	151694	
57	lot	Cnc	30.5	4.2 / 6.6	80416	
58	Alp	Cnc	11	4.3 / 12	98267	Acubens
59	Zet	Cnc	6	5.1 / 6.2	97646	
60	24	Com	20.6	5.0 / 6.6	100160	
61	35	Com	1.2	5.1/7.2/9.1	82550	
62	2	Com	3.7	5.9 / 7.4	82123	
63	Zet	CrB	6.1	5.0 / 6.0	64833	
64	Gam	Crt	5.2	4.1 / 9.6	156661	
65	Del	Crv	24.2	3.0 / 9.2	157323	Algorab
66	Alp	CVn	19.4	2.9 / 5.5	63257	Cor caroli
67	25	CVn	1.8	5.0 / 6.9	63648	
68	2	CVn	11.4	5.8 / 8.1	44097	
69	Gam	Cyg	41	2.2 / 9.5	49528	Sadr
70	Del	Cyg	2.5	2.9 / 6.3	48796	
71	Bet	Cyg	34.4	3.1 / 5.1	87301	Albireo
72	Omi 1	Cyg	107	3.8 / 6.7	49337	

No.	Object	Const	Sep.	Magitude	SAO	Comm. Name
73	52	Cyg	6.1	4.2 / 9.4	70467	
74	Ups	Cyg	15.1	4.4 / 10	71173	
75	Mu	Cyg	1.9	4.7 / 6.1	89940	
76	Psi	Cyg	3.2	4.9 / 7.4	32114	
77	17	Cyg	26	5.0 / 9.2	68827	
78	61	Cyg	30.3	5.2 / 6.0	70919	
79	49	Cyg	2.7	5.7 / 7.8	70362	
80	E2762	Cyg	3.4	5.8 / 7.8	70968	
81	E2741	Cyg	1.9	5.9 / 7.2	33034	
82	Gam	Del	9.6	4.5 / 5.5	106476	
83	Eta	Dra	5.3	2.7 / 8.7	17074	
84	Eps	Dra	3.1	3.8 / 7.4	9540	Tyl
85	47	Dra	34	4.8 / 7.8	31219	
86	Nu	Dra	61.9	4.9 / 4.9	30450	
87	Psi	Dra	30.3	4.9 / 6.1	8890	
88	26	Dra	1.7	5.3 / 8.0	17546	
89	16&17	Dra	90	5.4/5.5/6.4	30012	
90	Mu	Dra	1.9	5.7 / 5.7	30239	
91	40/41	Dra	19.3	5.7 / 6.1	8994	
92	1	Equ	10.7	5.2 / 7.3	126428	
93	The	Eri	4.5	3.4 / 4.5	216114	Acamar
94	Tau 4	Eri	5.7	3.7 / 10	168460	
95	Omi 2	Eri	8.3	4.4/9.5/11	131063	Keid
96	32	Eri	6.8	4.8 / 6.1	130806	
97	39	Eri	6.4	5.0 / 8.0	149478	
98	Alp	For	5.1	4.0 / 6.6	168373	Fornacis
99	Ome	For	10.8	5.0 / 7.7	167882	
100	Alp	Gem	3.9	1.9 / 2.9	60198	Castor
101	Del	Gem	5.8	3.5 / 8.2	79294	Wasat
102	Lam	Gem	9.6	3.6 / 11	96746	
103	Kap	Gem	7.1	3.6 / 8.1	79653	
104	Zet	Gem	87	3.8/10/8.0	79031	Mekbuda
105	38	Gem	7.1	4.7 / 7.7	96265	
106	Del	Her	8.9	3.1 / 8.2	84951	Sarin
107	Mu	Her	34	3.4 / 9.8	85397	
108	Alp	Her	4.6	3.5 / 5.4	102680	Rasalgethi
109	Gam	Her	42	3.8 / 9.8	102107	
110	Rho	Her	4.1	4.6 / 5.6	66001	

No.	Object	Const	Sep.	Magitude	SAO	Comm. Name
111	95	Her	6.3	5.0 / 5.2	85647	
112	Kap	Her	27	5.0 / 6.2	101951	
113	E2063	Her	16.4	5.7 / 8.2	46147	
114	100	Her	14.3	5.9 / 5.9	85753	
115	54	Hya	8.6	5.1 / 7.1	182855	
116	HN69	Hya	10.1	5.9 / 6.8	181790	
117	Eps	Hyd	2.7	3.4 / 6.8	117112	
118	The	Hyd	29.4	3.9 / 10	117527	
119	N	Hyd	9.4	5.6 / 5.8	179968	
120		Lac	28.4	4.5 / 10	72155	
121	8	Lac	22	5.7/6.5/10	72509	
122	Gam 1	Leo	4.4	2.2 / 3.5	81298	Algjeba
123	lot	Leo	1.7	4.0 / 6.7	99587	
124	54	Leo	6.6	4.3 / 6.3	81583	
125	Gam	Lep	96	3.7 / 6.3	170757	
126	lot	Lep	12.8	4.4 / 10	150223	
127	Kap	Lep	2.6	4.5 / 7.4	150239	
128	h3752	Lep	3.2	5.4 / 6.6	170352	
129	lot	Lib	57.8	4.5 / 9.4	159090	
130		Lib	23	5.7 / 8.0	183040	
131	Mu	Lib	1.8	5.8 / 6.7	158821	
132	Eta	Lup	15	3.6 / 7.8	207208	
133	Xi	Lup	10.4	5.3 / 5.8	207144	
134	38	Lyn	2.7	3.9 / 6.6	61391	
135	12	Lyn	1.7	5.4/6.0/7.3	25939	
136	19	Lyn	14.8	5.8 / 6.9	26312	
137	Bet	Lyr	46	3.4 / 8.6	67451	Sheliak
138	Zet	Lyr	44	4.3 / 5.9	67321	
139	Eta	Lyr	28.1	4.4 / 9.1	68010	Aldafar
140	Eps	Lyr	208	5.0 / 5.2	67310	Double dbl
141	Eps 1	Lyr	2.6	5.0 / 6.1	67309	Double dbl1
142	Eps 2	Lyr	2.3	5.2 / 5.5	67315	Double dbl2
143	Alp	Mic	20.5	5.0 / 10	212472	
144	Zet	Mon	32	4.3 / 10	135551	
145	Eps	Mon	13.4	4.5 / 6.5	113810	
146	Bet	Mon	7.3	4.7/4.8/6.1	133316	
147	15	Mon	2.8	4.7 / 7.5	114258	
148	70	Oph	4.5	4.0 / 5.9	123107	

No.	Object	Const	Sep.	Magitude	SAO	Comm. Name
149	67	Oph	55	4.0 / 8.6	123013	
150	Lam	Oph	1.5	4.2 / 5.2	121658	Marfic
151	Xi	Oph	3.7	4.4 / 9.0	185296	
152	36	Oph	4.9	5.1 / 5.1	185198	
153	Tau	Oph	1.7	5.2 / 5.9	142050	
154	Rho	Oph	3.1	5.3 / 6.0	184382	
155	39	Oph	10.3	5.4 / 6.9	185238	
156	Bet	Ori	9.5	0.1 / 6.8	131907	Rigel
157	Del	Ori	53	2.2 / 6.3	132220	Mintaka
158	lot	Ori	11.3	2.8 / 6.9	132323	Nair al saif
159	Lam	Ori	4.4	3.6 / 5.5	112921	Meissa
160	Sig	Ori	13	3.8/7.2/6.5	132406	
161	Rho	Ori	7.1	4.5 / 8.3	112528	
162	E747	Ori	36	4.8 / 5.7	132298	
163	1	Peg	36.3	4.1 / 8.2	107073	
164	Eps	Per	8.8	2.9 / 8.1	56840	
165	Zet	Per	12.9	2.9 / 9.5	56799	Atik
166	Eta	Per	28.3	3.3 / 8.5	23655	Miram in bevar
167	The	Per	18.3	4.1 / 10	38288	
168	E331	Per	12.1	5.3 / 6.7	23765	
169	Del	PsA	5.1	4.2 / 9.2	214189	
170	lot	PsA	20	4.3 / 11	213258	
171	Bet	PsA	30.3	4.4 / 7.9	213883	
172	Gam	PsA	4.2	4.5 / 8.0	214153	
173	Eta	PsA	1.7	5.8 / 6.8	190822	
174	Alp	Psc	1.8	4.2 / 5.2	110291	Alrisha
175	55	Psc	6.5	5.4 / 8.7	74182	
176	Psi	Psc	30	5.6 / 5.8	74483	
177	Zet	Psc	23	5.6 / 6.5	109739	
178	Kap	Pup	9.9	4.5 / 4.7	174199	
179	Eta	Pup	9.6	5.8 / 5.9	174019	
180	Eps	Scl	4.7	5.4 / 8.6	167275	

No.	Object	Const	Sep.	Magitude	SAO	Comm. Name
181	Bet	Sco	13.6	2.6 / 4.9	159682	Graffias
182	Sig	Sco	20	2.9 / 8.5	184336	Alniyat
183	Nu	Sco	41	4.2 / 6.1	159764	Jabbah
184	2	Sco	2.5	4.7 / 7.4	183896	
185		Sco	23	5.4 / 6.9	207558	
186	Hn39	Sco	5.4	5.9 / 6.9	184369	
187	12	Sco	3.9	5.9 / 7.9	184217	
188	Bet	Ser	31	3.7 / 9.0	101725	
189	Del	Ser	4.4	4.2 / 5.2	101624	
190	Nu	Ser	46	4.3 / 8.5	160479	
191	The	Ser	22.3	4.5 / 5.4	124070	Alya
192	59	Ser	3.8	5.3 / 7.6	123497	
193	Zet	Sge	8.5	5.0 / 8.8	105298	
194	Eta	Sgr	3.6	3.2 / 7.8	209957	
195		Sgr	5.5	5.2 / 6.9	209553	
196	Phi	Tau	52	5.0 / 8.4	76558	
197	Chi	Tau	19.4	5.7 / 7.6	76573	
198	118	Tau	4.8	5.8 / 6.6	77201	
199	6	Tri	3.9	5.3 / 6.9	55347	
200	Zet	UMa	14	2.4 / 4.0	28737	Mizar
201	Nu	UMa	7.2	3.5 / 9.9	62486	Alula borealis
202	23	UMa	23	3.6 / 8.9	14908	
203	Ups	UMa	11.6	3.8 / 11	27401	
204	Xi	UMa	1.8	4.3 / 4.8	62484	Alula australia
205	Sig 2	UMa	3.9	4.8 / 8.2	14788	
206	57	UMa	5.4	5.4 / 5.4	62572	
207	Alp	UMi	18.4	2.0 / 9.0	308	Polaris
208	Gam	Vir	1.4	3.5 / 3.5	138917	Porrina
209	The	Vir	7.1	4.4 / 9.4	139189	
210	Phi	Vir	4.8	4.8 / 9.3	139951	
211	84	Vir	2.9	5.7 / 7.9	120082	

GTONOVA Comet List

for 8405

No.	Name	Year	Month	Day	e	q	ω	Ω	i	H	G
1	6P d'Arrest	2008	8	14.9663	0.612767	1.353724	178.1336	138.9339	19.5151	7.5	16
2	7P Pons-Winnecke	2008	9	26.6083	0.634826	1.253104	172.3139	93.4179	22.3096	10	6
3	8P Tuttle	2008	1	26.8949	0.819561	1.028148	207.5248	270.349	54.9668	8	8
4	9P Tempel	2011	1	12.2668	0.516901	1.50924	178.9296	68.9277	10.5245	5.5	10
5	10P Tempel	2010	7	4.8723	0.536264	1.423146	195.6229	117.8315	12.0227	5	10
6	14P Wolf	2009	2	27.2831	0.357869	2.724147	158.9974	202.1187	27.9444	5.5	12
7	15P Finlay	2008	6	22.5945	0.721504	0.969941	347.5067	13.7983	6.8171	12	4
8	16P Brooks	2008	4	12.6566	0.562913	1.466397	219.4839	159.3684	4.2591	7.5	10
9	17P Holmes	2007	5	4.8086	0.432857	2.053122	24.3224	326.8536	19.1161	10	6
10	19P Borrelly	2008	7	22.3351	0.624532	1.354434	353.3657	75.4365	30.3244	4.5	10
11	22P Kopff	2009	5	25.4013	0.544394	1.577587	162.8156	120.8986	4.7239	3	10.4
12	24P Schumacher	2009	8	9.6289	0.7036	1.213924	58.0011	79.7185	11.7293	6.5	14
13	29P Schwassmann-Wachmann	2004	7	3.1617	0.045115	5.717498	48.3485	312.6347	9.3945	4	4
14	30P Reinmuth	2010	4	19.5968	0.500791	1.884042	13.2241	119.7532	8.1225	9.5	6
15	31P Schwassmann-Wachmann	2010	9	30.3312	0.192205	3.423778	18.0697	114.1879	4.5475	5	8
16	33P Daniel	2008	7	20.3006	0.461966	2.169362	18.958	66.5621	22.3747	10	12
17	36P Whipple	2011	12	31.6411	0.258516	3.088107	201.8996	182.395	9.9357	8.5	6
18	43P Wolf-Harrington	2010	7	1.5473	0.595103	1.357198	191.2932	250.0422	15.9772	8	6
19	44P Reinmuth	2008	2	18.4132	0.428497	2.106896	58.1213	286.602	5.9043	8.3	6
20	46P Wirtanen	2008	2	2.4602	0.658121	1.056931	356.3185	82.1665	11.7403	9	6
21	47P Ashbrook-Jackson	2009	1	31.9991	0.319063	2.799127	357.693	356.9828	13.0531	1	11.2
22	49P Arend-Rigaux	2011	10	18.9016	0.60189	1.414468	333.0283	118.9371	19.1063	11.3	4.4
23	54P de Vico-Swift-NEAT	2009	11	28.5135	0.42703	2.171755	1.9406	358.8616	6.067	10	6
24	57P du Toit-Neujmin-Delporte	2008	12	25.9437	0.500102	1.723741	115.2831	188.8247	2.8485	12.5	6
25	59P Kearns-Kwee	2009	3	7.6295	0.475156	2.355532	127.5273	313.0361	9.3412	7	6
26	61P Shajn-Schaldach	2008	9	6.1338	0.426722	2.108045	221.6446	163.1114	6.0091	6	10
27	64P Swift-Gehrels	2009	6	14.2956	0.689544	1.37701	96.3046	300.7414	8.9514	8.5	12
28	65P Gunn	2010	3	2.0144	0.319539	2.440529	196.5992	68.3597	10.3857	5	6
29	67P Churyumov-Gerasimenko	2009	2	28.3641	0.640213	1.246496	12.6998	50.1958	7.0408	11	4
30	68P Klemola	2009	1	20.9663	0.640457	1.759031	153.9745	175.3289	11.1448	10	4
31	74P Smirnova-Chernykh	2009	7	30.439	0.147587	3.55766	87.2572	77.1026	6.6474	5	6
32	77P Longmore	2009	7	7.8488	0.358113	2.310327	196.6948	14.9167	24.3983	7	8

33	81P Wild	2010	2	22.7485	0.537369	1.597838	41.8137	136.0972	3.2375	7	6
34	82P Gehrels	2010	1	12.4773	0.121921	3.633291	226.3166	239.5183	1.1264	5	8
35	85P Boethin	2008	12	16.3724	0.775348	1.147441	53.5862	343.4491	4.2172	6.5	8
36	86P Wild	2008	5	19.5532	0.366349	2.299076	179.0341	72.5235	15.4397	11	6
37	88P Howell	2009	10	12.4726	0.561968	1.363503	235.9597	56.758	4.3818	11	6
38	89P Russell	2009	8	17.1771	0.39932	2.279933	249.3226	42.3911	12.0321	11.5	6
39	94P Russell	2010	3	29.8581	0.36301	2.239971	92.8775	70.9216	6.1829	9	6
40	97P Metcalf-Brewington	2011	8	23.0708	0.459505	2.584877	228.7909	185.3042	17.8718	5.5	6
41	99P Kowal	2007	1	27.2463	0.229783	4.732823	174.2474	28.2479	4.3327	4.5	6
42	100P Hartley	2009	12	6.1406	0.418754	1.982377	181.7049	37.8476	25.6527	9	8
43	110P Hartley	2008	2	3.1773	0.312487	2.487409	167.7069	287.7388	11.6791	1	12
44	113P Spitaler	2008	3	23.3787	0.423255	2.127804	49.8243	14.4619	5.7762	13.5	4
45	116P Wild	2009	7	18.8676	0.374617	2.174942	173.5919	21.0335	3.6129	2.5	10
46	117P Helin-Roman-Alu	2005	12	21.0788	0.255423	3.04239	222.9909	58.9391	8.7034	2.5	8
47	118P Shoemaker-Levy	2010	1	2.3171	0.427227	1.984014	302.1383	151.8073	8.5094	12	4
48	119P Parker-Hartley	2005	5	22.6848	0.290508	3.039586	181.1136	244.0744	5.1905	3.5	8
49	124P Mrkos	2008	4	27.3311	0.542493	1.469458	181.4997	1.2852	31.3603	13.5	2.8
50	126P IRAS	2010	2	22.8394	0.696401	1.7133	356.7469	357.7654	45.8278	6	8
51	127P Holt-Olmstead	2009	10	21.3259	0.362704	2.195724	6.5239	13.6877	14.3194	11	6
52	128P Shoemaker-Holt	2007	6	13.3448	0.320257	3.0666	210.3766	214.3784	4.3566	8.5	4
53	131P Mueller	2012	1	8.3197	0.342517	2.419686	179.6422	214.218	7.354	11	4
54	136P Mueller	2007	10	22.6772	0.293483	2.961155	224.9585	137.5513	9.4277	11	4
55	137P Shoemaker-Levy	2009	5	13.5701	0.574498	1.915285	140.813	233.1209	4.8537	11	4
56	139P Vaisala-Oterma	2008	4	19.4574	0.247039	3.402648	165.5401	242.4436	2.329	9.5	4
57	142P Ge-Wang	2010	5	31.032	0.49931	2.487014	175.853	176.5414	12.3014	8.5	6
58	143P Kowal-Mrkos	2009	6	12.1982	0.409802	2.538199	320.7603	245.3684	4.6899	13.5	2
59	144P Kushida	2009	1	26.8501	0.627795	1.438946	216.0919	245.5568	4.1092	8.5	8
60	145P Shoemaker-Levy	2009	3	26.6162	0.542157	1.891352	10.1421	26.9025	11.2992	13.5	4
61	147P Kushida-Muramatsu	2008	9	22.8809	0.27611	2.756234	346.8579	93.7395	2.3671	14	4
62	148P Anderson-LINEAR	2008	5	22.7006	0.537838	1.702227	6.6478	89.7988	3.6784	16	2
63	149P Mueller	2010	2	19.2809	0.38863	2.650716	43.7897	145.2662	29.7354	8	8
64	150P LONEOS	2008	11	25.9864	0.545721	1.76773	245.6687	272.4279	18.5004	13.5	4

GTONOVA Asteriod List for 8405

No.	Name	Year	Month	Day	M	a	e	ω	Ω	i	H	G
1	Ceres	2008	11	30	344.5453	2.766792	0.079475	72.8956	80.4045	10.5857	3.34	0.12
2	Pallas	2008	11	30	327.9744	2.77265	0.230878	310.2565	173.1321	34.8377	4.13	0.11
3	Juno	2008	11	30	256.8166	2.672153	0.255933	247.9335	169.9608	12.968	5.33	0.32
4	Vesta	2008	11	30	144.8639	2.361269	0.089055	149.8554	103.9148	7.1352	3.2	0.32
5	Astraea	2008	11	30	97.0412	2.573519	0.192256	357.5568	141.6733	5.3691	6.85	0.15
6	Hebe	2008	11	30	174.9948	2.424804	0.202221	239.4972	138.7389	14.754	5.71	0.24
7	Iris	2008	11	30	204.0208	2.384906	0.231427	145.2963	259.7192	5.5274	5.51	0.15
8	Flora	2008	11	30	127.9925	2.201234	0.15659	285.4267	110.9601	5.8891	6.49	0.28
9	Metis	2008	11	30	340.9833	2.386203	0.121977	6.3177	68.9614	5.5748	6.28	0.17
10	Hygiea	2008	11	30	197.9649	3.138648	0.117332	313.1924	283.4507	3.8422	5.43	0.15
11	Parthenope	2008	11	30	24.7386	2.452451	0.099693	194.7959	125.6097	4.6264	6.55	0.15
12	Victoria	2008	11	30	162.874	2.33469	0.220269	69.6765	235.531	8.3623	7.24	0.22
13	Egeria	2008	11	30	1.7704	2.576374	0.08588	80.7823	43.2844	16.5416	6.74	0.15
14	Irene	2008	11	30	346.0152	2.585491	0.16756	96.306	86.4552	9.1069	6.3	0.15
15	Eunomia	2008	11	30	132.5299	2.643423	0.187649	97.8333	293.2659	11.7384	5.28	0.23
16	Psyche	2008	11	30	260.2872	2.920993	0.13925	227.4924	150.325	3.096	5.9	0.2
17	Thetis	2008	11	30	59.2784	2.470101	0.134917	135.8301	125.5998	5.589	7.76	0.15
18	Melpomene	2008	11	30	270.5753	2.295635	0.218678	227.8463	150.5229	10.1268	6.51	0.25
19	Fortuna	2008	11	30	296.078	2.443171	0.15795	181.8835	211.2813	1.5721	7.13	0.1
20	Massalia	2008	11	30	196.7074	2.411074	0.141797	255.9576	206.3904	0.7063	6.5	0.25
21	Lutetia	2008	11	30	78.6783	2.435445	0.162944	250.0326	80.912	3.0641	7.35	0.11
22	Kalliope	2008	11	30	162.5628	2.907406	0.102782	355.7259	66.2278	13.7112	6.45	0.21
23	Thalia	2008	11	30	176.0898	2.630841	0.232993	59.9907	67.118	10.1185	6.95	0.15
24	Themis	2008	11	30	39.6102	3.129503	0.131562	107.8254	35.991	0.7595	7.08	0.19
25	Phocaea	2008	11	30	245.3675	2.399863	0.255762	90.261	214.2438	21.5831	7.83	0.15
26	Proserpina	2008	11	30	320.0877	2.65561	0.086669	193.5194	45.87	3.5617	7.5	0.15
27	Euterpe	2008	11	30	13.121	2.346729	0.172864	356.8066	94.8057	1.5837	7	0.15
28	Bellona	2008	11	30	184.1954	2.78127	0.148745	343.7149	144.3457	9.4233	7.09	0.15
29	Amphitrite	2008	11	30	87.1578	2.554712	0.072951	63.2084	356.4852	6.0961	5.85	0.2
30	Urania	2008	11	30	79.8986	2.365855	0.126799	87.0183	307.7439	2.0987	7.57	0.15
31	Euphrosyne	2008	11	30	138.0881	3.148599	0.225332	61.9397	31.2316	26.3152	6.74	0.15
32	Pomona	2008	11	30	212.5172	2.586608	0.082978	339.1133	220.5602	5.5293	7.56	0.15

33	Polyhymnia	2008	11	30	291.3457	2.864372	0.338273	338.2115	8.5843	1.871	8.55	0.33
34	Circe	2008	11	30	357.3366	2.686037	0.108253	329.9188	184.5186	5.5028	8.51	0.15
35	Leukothea	2008	11	30	210.9581	2.990727	0.227795	213.9588	353.8097	7.9351	8.5	0.15
36	Atalante	2008	11	30	198.7502	2.745856	0.303496	47.0352	358.4703	18.4346	8.46	0.15
37	Fides	2008	11	30	190.2175	2.641461	0.176024	62.5955	7.3927	3.073	7.29	0.24
38	Leda	2008	11	30	258.4882	2.739764	0.153551	169.6907	295.793	6.9731	8.32	0.15
39	Laetitia	2008	11	30	208.1856	2.767148	0.114802	209.4385	157.1627	10.3862	6.1	0.15
40	Harmonia	2008	11	30	90.4497	2.267479	0.046348	269.7366	94.2864	4.2566	7	0.15
41	Daphne	2008	11	30	37.4718	2.765469	0.272064	46.3609	178.1346	15.7666	7.12	0.1
42	Isis	2008	11	30	302.7259	2.441053	0.22337	236.6529	84.3936	8.5296	7.53	0.15
43	Ariadne	2008	11	30	73.2044	2.202968	0.168091	15.8319	264.9291	3.4677	7.93	0.11
44	Nysa	2008	11	30	170.7123	2.425341	0.147657	342.7508	131.5792	3.7041	7.03	0.46
45	Eugenia	2008	11	30	286.3938	2.720994	0.081644	85.5622	147.9191	6.6099	7.46	0.07
46	Hestia	2008	11	30	217.3722	2.524407	0.172783	176.8484	181.1561	2.3432	8.36	0.06
47	Aglaja	2008	11	30	6.8168	2.879575	0.135015	314.043	3.1473	4.9838	7.84	0.16
48	Doris	2008	11	30	102.4412	3.108642	0.074784	257.133	183.7354	6.5555	6.9	0.15
49	Pales	2008	11	30	274.6896	3.09392	0.230324	109.804	286.1346	3.1802	7.8	0.15
50	Virginia	2008	11	30	10.6337	2.651387	0.283688	200.0845	173.6319	2.8324	9.24	0.15
51	Nemausa	2008	11	30	145.8796	2.365855	0.06723	3.2243	176.0995	9.9753	7.35	0.08
52	Europa	2008	11	30	269.0613	3.094958	0.105853	344.0615	128.7541	7.4816	6.31	0.18
53	Kalypso	2008	11	30	259.669	2.618282	0.204793	313.3827	143.5885	5.1684	8.81	0.15
54	Alexandra	2008	11	30	258.1198	2.711412	0.196803	345.7216	313.437	11.8071	7.66	0.15
55	Pandora	2008	11	30	265.9608	2.759307	0.144664	3.9396	10.5166	7.1839	7.8	0.15
56	Melete	2008	11	30	72.9013	2.595268	0.237971	103.5363	193.4492	8.0701	8.31	0.15
57	Mnemosyne	2008	11	30	191.8584	3.147948	0.118166	212.5563	199.3297	15.2023	7.03	0.15
58	Concordia	2008	11	30	171.8732	2.698995	0.044675	33.2036	161.1913	5.0605	8.86	0.15
59	Elpis	2008	11	30	40.6966	2.713766	0.116815	211.4276	170.1613	8.6326	7.93	0.15
60	Echo	2008	11	30	276.6632	2.392828	0.183056	271.1452	191.6475	3.6011	8.21	0.27
61	Danae	2008	11	30	263.5451	2.980351	0.168521	13.751	333.7722	18.2254	7.68	0.15
62	Erato	2008	11	30	286.4868	3.130932	0.173412	273.2412	125.5826	2.229	8.76	0.15
63	Ausonia	2008	11	30	209.2939	2.395977	0.12571	295.8189	337.8964	5.7856	7.55	0.25
64	Angelina	2008	11	30	264.9106	2.681069	0.125643	179.5963	309.2127	1.31	7.67	0.48

GOTONOVA SAO Bright Star List For 8405

GOTONOVA™ hand controller consists of 5103 SAO bright stars, with there magnitude less than 6. A separate list is provided. (SAO_Bright_Star.pdf)

IOPTRON ONE YEAR LIMITED WARRANTY

A. iOptron warrants your telescope, mount, or controller to be free from defects in materials and workmanship for one year. iOptron will repair or replace such product or part which, upon inspection by iOptron, is found to be defective in materials or workmanship. As a condition to the obligation of iOptron to repair or replace such product, the product must be returned to iOptron together with proof-of-purchase satisfactory to iOptron.

B. The Proper Return Authorization Number must be obtained from iOptron in advance of return. Call iOptron at 1.866.399.4587 to receive the number to be displayed on the outside of your shipping container. All returns must be accompanied by a written statement stating the name, address, and daytime telephone number of the owner, together with a brief description of any claimed defects. Parts or product for which replacement is made shall become the property of iOptron.

The customer shall be responsible for all costs of transportation and insurance, both to and from the factory of iOptron, and shall be required to prepay such costs.

iOptron shall use reasonable efforts to repair or replace any telescope, mount, or controller covered by this warranty within thirty days of receipt. In the event repair or replacement shall require more than thirty days, iOptron shall notify the customer accordingly. iOptron reserves the right to replace any product which has been discontinued from its product line with a new product of comparable value and function.

This warranty shall be void and of no force of effect in the event a covered product has been modified in design or function, or subjected to abuse, misuse, mishandling or unauthorized repair. Further, product malfunction or deterioration due to normal wear is not covered by this warranty.

IOPTRON DISCLAIMS ANY WARRANTIES, EXPRESS OR IMPLIED, WHETHER OF MERCHANTABILITY OF FITNESS FOR A PARTICULAR USE, EXCEPT AS EXPRESSLY SET FORTH HERE. THE SOLE OBLIGATION OF IOPTRON UNDER THIS LIMITED WARRANTY SHALL BE TO REPAIR OR REPLACE THE COVERED PRODUCT, IN ACCORDANCE WITH THE TERMS SET FORTH HERE. IOPTRON EXPRESSLY DISCLAIMS ANY LOST PROFITS, GENERAL, SPECIAL, INDIRECT OR CONSEQUENTIAL DAMAGES WHICH MAY RESULT FROM BREACH OF ANY WARRANTY, OR ARISING OUT OF THE USE OR INABILITY TO USE ANY IOPTRON PRODUCT. ANY WARRANTIES WHICH ARE IMPLIED AND WHICH CANNOT BE DISCLAIMED SHALL BE LIMITED IN DURATION TO A TERM OF TWO YEARS FROM THE DATE OF ORIGINAL RETAIL PURCHASE.

Some states do not allow the exclusion or limitation of incidental or consequential damages or limitation on how long an implied warranty lasts, so the above limitations and exclusions may not apply to you.

This warranty gives you specific legal rights, and you may also have other rights which vary from state to state.

iOptron reserves the right to modify or discontinue, without prior notice to you, any model or style telescope.

If warranty problems arise, or if you need assistance in using your telescope, mount, or controller contact:

iOptron Corporation
Customer Service Department
6X Gill Street
Woburn, MA 01801
www.ioptron.com
Tel. (866)399-4597
Fax. (781)935-2860
Monday-Friday 9AM-5PM EST

NOTE: This warranty is valid to U.S.A. and Canadian customers who have purchased this product from an authorized iOptron dealer in the U.S.A. or Canada or directly from iOptron. Warranty outside the U.S.A. and Canada is valid only to customers who purchased from an iOptron Distributor or Authorized iOptron Dealer in the specific country. Please contact them for any warranty

Free Manuals Download Website

<http://myh66.com>

<http://usermanuals.us>

<http://www.somanuals.com>

<http://www.4manuals.cc>

<http://www.manual-lib.com>

<http://www.404manual.com>

<http://www.luxmanual.com>

<http://aubethermostatmanual.com>

Golf course search by state

<http://golfingnear.com>

Email search by domain

<http://emailbydomain.com>

Auto manuals search

<http://auto.somanuals.com>

TV manuals search

<http://tv.somanuals.com>