



CTV 29-100 ST



**Bedienungsanleitung
Operating Instructions**

List of contents

Special features	2
Safety instructions	3
Getting started	4
Aerial connection.....	4
Switching on.....	4
Battery fitting.....	4
Control unit.....	5
Front and rear panel.....	5
External connections table.....	6
Remote control	6
Using the TV	7
Tuning the TV.....	8
Automatic tuning.....	8
Manual tuning.....	9
Program organising.....	11
TV setup	12
Sound menu	12
Sound Features	13
Picture menu.....	14
Features Menu	15
Picture format.....	17
Subwoofer.....	17
Other features.....	18
Using teletext.....	19-20
Connecting external equipment	21-25
Help and service tips	26
Technical specifications table	27

Television

Thank you for buying this television which is designed to give you many years of satisfactory service.

You may already be familiar with using a television but do please take time to read these instructions. They are designed to familiarise you with the unit's many new features and to ensure you get the very best out of your purchase.

Special features

- 100 Hz digital scan.
- 9 page teletext.
- Fasttext and/or Toptext (Optional).
- Letterbox, Subtitle 1 & 2, 16:9, 14:9 picture formats (for Widescreen TV sets) (Optional).
- Digital Colour Transition Improvement (DCTI).
- Digital Comb Filter (DCF) (Optional).
- Digital Luminance Transition Improvement (DLTI).
- Manual degaussing (Optional).
- Scan Velocity Modulation (SVM.) (Optional).
- Dynamic Focus (Optional).
- 3 step Zoom function (Optional).
- Picture freeze function
- Automatically switch to stand by in five minutes after a channel ceases to transmit or selecting a channel which has no transmission (Auto off function).
- Virtual Dolby surround (Optional).
- Subwoofer (optional).
- Dynamic Bass Enhancement (Optional).
- Back audio out.
- 5 band graphic equaliser.
- Automatic Volume Limiting (AVL).
- Programme Editing Table.
- Naming the channels.
- Your TV can receive stereo channels directly (NICAM optional).
- Automatic tuning system with country selection (ATS).
- 100 Programme Memory.
- Cable/Hyperband tuner.
- Manual Fine Tuning.
- Child Lock.
- Return to the last channel viewed (SWAP).
- Normalisation system to recall the setting in memory after the volume, colour, contrast, brightness settings have been changed (PP).
- Picture adjustment using one button (Picture Smart Control).
- Sound adjustment using one button (Sound Smart Control).
- Advanced On Screen Display.
- Infrared Remote Control.
- Programmable on/off timer.
- Multi language menu system (10).
- Stereo headphone socket.
- 2 Scart Sockets: Video cassette recorder, satellite receiver, video disc player, DVD, TV games or a home computer can be connected to this AV socket with an appropriate connecting cable (3rd Scart socket is optional).
- S-Video connection.
- Audio/Video RCA sockets.

ITT is a registered trademark of ITT manufacturing Enterprises, Inc., a subsidiary of ITT Industries, Inc., and is used under license.

www.itt-deutschland.de

Safety is Important

Your safety and the safety of others is important. Please, therefore, ensure you read the Safety instructions **before** you operate this television.

Safety instructions

! Read all the safety instructions before first use of your TV.



- Position the television so that direct light does not fall on the screen. Excessive light will cause a washed out effect.



- Position the power supply lead and other leads so that they are not likely to be walked on or pinched by things placed on or against them.



- Do not place objects filled with liquid such as vase or flower pot on the television top.

Do not expose the TV to dripping or splashing of liquids.

Do not place naked flame sources such as lighted candles on the TV set.



- Make sure that no naked flame sources, such as lighted candles, are placed on top of the appliance.

- Do not place the television near heat sources such as radiators, ovens, stoves, etc.



- Do not use the television near any apparatus that produces a magnetic field such as HI-FI speakers or electric motors otherwise colourpurity may be affected.



- The heat built up in the set escapes through ventilation holes, so do not cover the set by drapes, clothes etc. that may block air circulation. Do not place the television on carpet or soft furnishings.

- NEVER let children push anything into the holes or slots on the case.



- Clean the TV Screen using a slightly damp cloth or chamois leather. Never use abrasive cleaning agents like liquid or aerosol cleaners.

- Remove the mains plug from the socket outlet while cleaning.



- If you wish to place the television on a shelf or in a wall unit always ensure there is a minimum air gap of 8 cm around the top, sides and rear of the television, to assist ventilation.



- Your TV set is designed to operate with mains voltages 230V AC; 50Hz. Do not connect your TV set to power sources other than the mains supply.

Getting started

Remove your Television carefully from the box. You may wish to store the packaging for future use.

In the box

Inside your this package you should have:

- Television
- Remote control
- User guide
- AAA batteries x 2

4

Read these instructions before use.

Aerial connection

To connect an aerial, plug the aerial lead into the aerial socket on the rear of the TV.

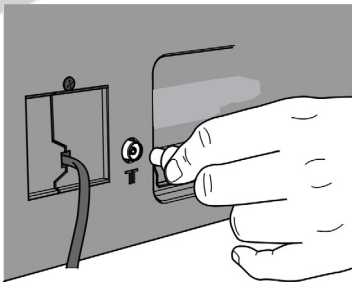

You can use an outdoor or indoor aerial. However, if you use an indoor aerial the quality of the reception may be reduced and adjustment of the aerial may be required when changing programs.

Please note

If you live in a poor reception area or use an indoor aerial you may experience loss or corruption of teletext transmissions.

Switching on

Mains power

Connect the mains plug into the mains socket and switch on.

Connect the TV mains plug into your domestic mains socket outlet (230 V 50 Hz AC).

Please Note

When not in use disconnect the plug from the mains power supply.



Press the **Power** button on the front of the TV. The standby indicator will illuminate.



Press a **Numeric** button or the **Program up** or **Program down** button on the remote handset or **Program up** or **Program down** button on the front panel to switch the TV on.

The standby indicator remains on. The picture will appear after a few seconds.



Press the **Standby** button to switch the TV to standby. The standby indicator will brighter.

Please Note

Do not leave the television on standby unattended or overnight.

Switching the TV on for the first time

To install your TV, please read the sections "TV controls" and "Tuning the television".

Battery fitting

Insert the 2 AAA Batteries supplied into the compartment on the rear of the remote control, ensure you follow the polarity diagram inside the compartment.

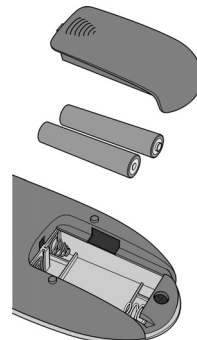

Control Unit

Front panel

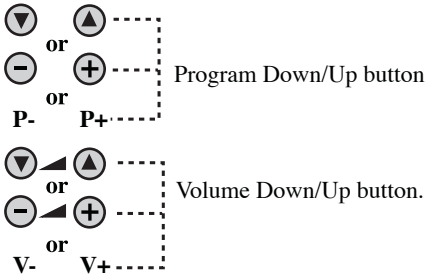

General

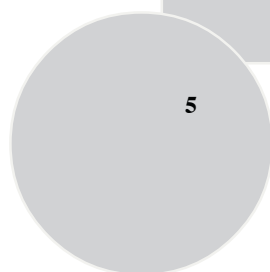
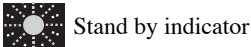

External Connections: (Front or side) (External connections: (Rear)



Right audio RCA (Red)

Left audio RCA (White)

Video RCA (Yellow)

S-Video connection

Headphone socket



AV1 scart (RGB)



AV2 scart (Composite)



AV3 scart (RGB) (Optional)

Power cable



Aerial socket

Optional

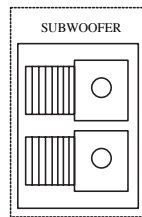

It is used for external subwoofer in 33" televisions

You may wish to connect audio amplifier or any similar devices to audio out. The output is always the current channel you are watching.

Please note

- See the external connections table on next page for available connections depending the size and model of your TV set.
- Do not use Video RCA and S-Video connections at the same time, otherwise they will effect the picture each other.
- RGB inpuks from scart will give you better picture quality.

External connections table

Picture tube size/type	28" 4:3	28" 16:9	29" 4:3	32" 16:9	33" 4:3
AV1 Scart	STD.	STD.	STD.	STD.	STD.
AV2 Scart	STD.	STD.	STD.	STD.	STD.
AV3 Scart	OPT.	OPT.	OPT.	OPT.	OPT.
Headphone socket	STD.	STD.	STD.	STD.	STD.
Audio/Video RCA	OPT.	OPT.	OPT.	OPT.	OPT.
S-Video socket	OPT.	OPT.	OPT.	OPT.	OPT.
Back audio out	OPT.	OPT.	OPT.	OPT.	OPT.

STD : Standart

OPT : Optional

N/A : Not available

Please note:

The Audio/Video RCA, S-Video and Headphone socket can be placed on the front panel or on the right-hand side of the cabinet depending to the model of your TV.

Remote control

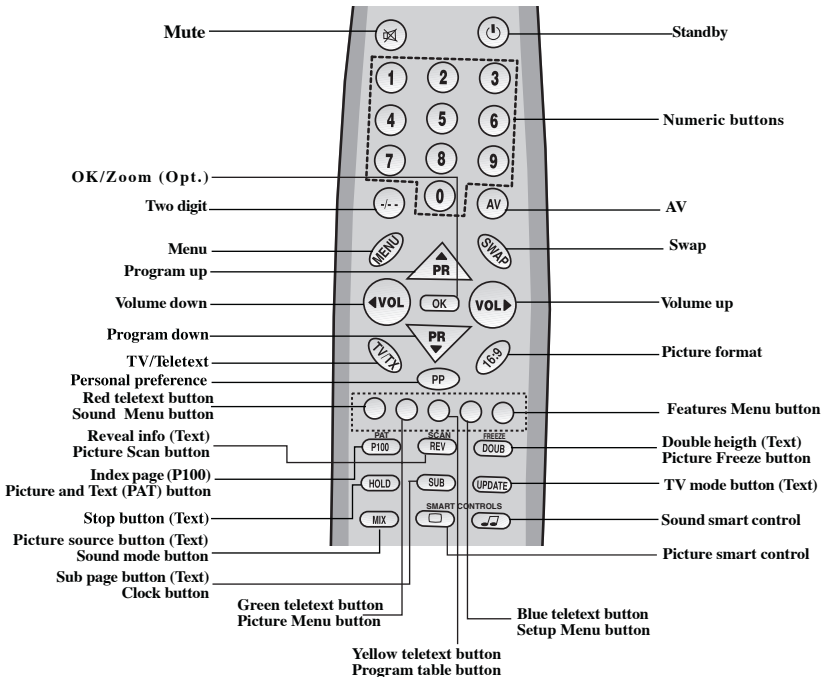

Using the TV

Turning on for the first time and Tuning

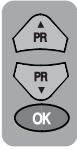

When you first turn your TV on, “Language” menu will appear. To search on the languages, use the **Program up** or **Program down**. **Volume up** or **Volume down** buttons and choose your desired language and press “**OK**” button.



Then “Country Selection” menu will appear. Choose your country using **Program up** or **Program down**. **Volume up** or **Volume down** and press “**OK**” button. “Autoprogram” process will begin and all the channels will be searched and stored.

TV controls

Stand-By mode



When your TV is working on, press the red “STAND-BY” button on the right upper corner of your remote control to switch off and the Stand-By indicator (Led) will be brighter. To turn on your TV again, press one off the numeric buttons, **Program up** or **Program down**.

Please Note: If you will not use your TV for a long time, do not leave it on Stand-By mode, instead switch it off from the power button on the front panel of the TV set. If you always leave your TV on Stand-By mode, demagnetization process will not occur and that will cause coloring problems. If you occurs, press the power button to switch off your TV and wait until it cools off.

Programme selection



Press the **Program up** or **Program down** buttons on the TV or remote control or press a **Numeric** button to select a programme.



To select a programme whose number is greater than 9 using the numeric buttons, press the **-/--** button first and then press the two **Numeric** buttons. For example, to select programme 12, press the **-/--** button followed by **1** and then **2**.

You can also select a program by pressing in the Yellow button to see the Program Table.

PROGRAM TABLE		
P00 ----	P005	P010
P01 ITU	P006	P011
P02 TU4	P007	P012
P03 CNN	P008	P013
P04 BBC1	P009	P014

SKIP DELETE MODE NAME



Use the **Program up** and **Program down** buttons to scroll through the programme numbers. When you find the program number you want press the **OK** button again.

Press the **TV/TX** button to close the Program Table.

Volume

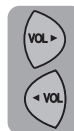

Press the **Volume +** or **Volume -** button on the TV or the **Vol <** or **Vol >** button on the remote control. A sound level bar will appear on the screen.

Mute



To mute the sound press the **Mute** button on the remote control. A loudspeaker symbol will appear on the screen.



Press the **Mute** button again to restore the sound. The symbol will disappear.



Pressing **Volume up** buttons will also restore the sound. But pressing the **Volume down** button will increase the volume without restoring.



PP



Personal preference. Press the **PP** button to revert to the default settings for the TV. (See TV setup).

Swap



Select the programme you would like to recall by pressing **SWAP** button. Selected programme number will appear on the upper left side of the screen. While watching any programme, you can recall the selected one by pressing **SWAP** button again. If you press swap button again you can recall the last programme you watched. You can cancel **SWAP** function by pressing **MENU** button.

PR 01 ➔ PR 11 ➔ PR 12 ➔ PR 13... ➔ PR 01

AV



Your TV has 2 (3. scart opt.) scarts so every time you press your AV button, your input will change as follows:

- 1 AV1 when using SCART socket 1 (RGB support) (Option).
- 2 AV2 when using SCART socket 2.
- 3 AV3 when using SCART socket 3 (RGB support) (Optional).
- 4 AV3-S for S-Video equipment to scart 3 (S-VHS/Scart adapter is needed).
- 5 AV4 when using the RCA sockets of the TV.
- 6 AV4-S when using the S-video socket.



Press the **AV** button again to return to TV.

Tuning the television

There are two ways of tuning your television: Manual, where you control the tuning process or

Autoprogram where the television does it all automatically.

Your TV will sort all the channels with the **ATS**. Sorting will be performed in the following order:

- a- Selected country's channels with teletext and channel names.
- b- Selected country's channels with teletext and without channel names.
- c- Selected country's channels without teletext.
- d- Foreign channels with teletext and channel names.

Please Note

If the TV is set to a channel with no signal the TV will return to standby in 5 minutes. The last minute remaining is displayed on the screen.

Automatic tuning (Autoprogram)

There are two ways to access the **SETUP** menu:

Press the blue **Setup** button.
or
Press the **Menu** button and use the **Program down** button to select **SETUP**. Press the **OK** button to enter the **SETUP** menu.

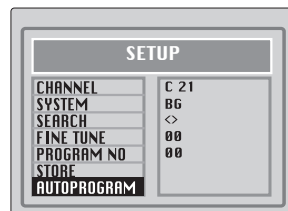
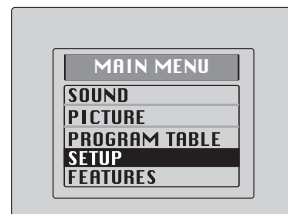

Please note

The system will displayed automatically on SYSTEM row i.e.BG, L, I, DK depending the receiving broadcasting system of the country. In some countries the broadcasting system can be both in BG/DK or BG/LL´. Only the TV sets produced with Pal Secam BG/DK or Pal Secam BG/LL´ systems can receive both BG/DK or BG/LL´ broadcasts. In this case the user can select the required SYSTEM using **Volume up/down** buttons.

Please note

If you do not press any buttons for 15 seconds the TV will exit the menu system.



Use the Program down button to select AUTOPROGRAM and press the OK button. A list of countries will appear. Select the desired country using **Program** and **Volume** buttons.



When you are sure the aerial is connected properly press the **OK** button. Autoprogram will start. AUTOPROGRAM will flash.

To cancel Autoprogram whilst it is working press the **Menu** button repetitively.

As Autoprogram stores a channel it will appear briefly on the screen before the search continues.

Manual tuning

If you want to tune manually:



In the Setup menu select PROGRAM NO using the **Program down** button and use the **Volume up** button to change the Program No to 01.

Starting with Program 01, tune in the first channel as follows:

Use the **Program down** button to select SEARCH.

Press the **Volume up** or **Volume down** button to start the tuning search.

When the search finds a strong channel signal it will stop searching. The picture will appear.

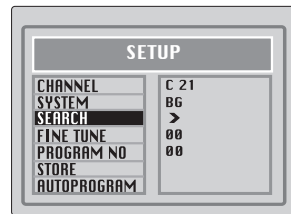

Use the **Program down** button to select PROGRAM NO.

Use the **Volume up/down** or numeric buttons to select the desired programme number.

Use the **Program down** button to select STORE. Press the **OK** button and STORED will appear on the STORE line.

You have now stored the first channel.

Use the **Program up** button to select again SEARCH and continue the tuning procedure until you have tuned in all the programmes you want or the television can receive.

Your TV is now tuned and ready to use.

Please note:

If auto sort fails to arrange the programmes in the required sequence please refer to programme organising.

Tuning with channel numbers

Enter the SETUP menu by pressing the blue button.



Press **OK** button when CHANNEL row is blue.



Use OK button to select "S" for cable channels and "C" for terrestrial broadcast.

7

Enter the channel number using the Numeric buttons or use the **Volume up/down** buttons on your remote control.



Use the **Program down** button to select PROGRAM NUMBER.



Use the **Volume up/down** or numeric buttons to select the desired programme number.



Use the **Program down** button to select STORE. Press the **OK** button and STORED will appear on the STORE line.



You have now stored the first channel.



Use the **Program up** button to select again CHANNEL and continue the tuning procedure until you have tuned in all the programmes you want or the television can receive.

Fine tuning

Although the search and Autoprogram will automatically try and tune to the best reception, in areas of poor reception a bit of fine tuning may be required.



In the SETUP menu use the Program up/down buttons to select FINE TUNING. Use the Volume up and Volume down buttons to fine tune.

When you have finished use the **Program down** button to select STORE and press the **OK** button.

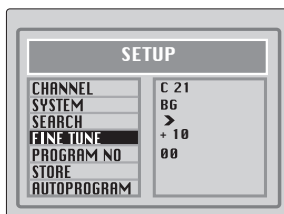

To exit the SETUP menu press the TV/TX button.

Program organising

Once you have tuned in all the channels you want, you can change their programme number, if required, and name them.

To enter the PROGRAM TABLE menu press the **Menu** button and select PROGRAM TABLE and press the **OK** button or press directly the **Yellow** button.



PROGRAM 01 will be selected and the channel stored under PROGRAM 01 will be shown on the screen.

The details of the program will be shown across the top of the screen i.e. P1 CH31.

The buttons used to edit the programs are shown at the bottom of the display:

Blue button	-	Name
Green button	-	Move
Pink button	-	Delete
Red button	-	Skip

To name the programmes

Press the **Blue** button, the selected line will turn blue and the CH will be highlighted.

Use the **Program up** and **Program down** buttons to select the letters and numbers and the **Volume up** and **Volume down** buttons to move through the name.

Press the **Blue** button again to store the name.

Repeat this process to name all the programmes.

Please Note

Some TV channels may send their names with teletext transmission. In this case their names will be automatically shown on the name line.

To move the programmes

You can move the programmes around the programme list to the order you want

Select the programme you want to move and press the **Green** button. The programme will turn to yellow. Select the number you want to move and press the **Green** button again and the programme will be moved to that number.

All the following programmes are shifted down by one place.

To delete a programme

To delete a programme, select it and press the **Pink** button. The programme will be deleted.

All the following programmes are shifted up by one position.

To skip programmes

Skipped programmes will not appear when you move through the program list using the **Program up/Program down** buttons.

They can still be selected using the numeric buttons or the OK button.

Select the programs you want to skip and press the **Red** button. The program will turn red. To unskip the program press the **Red** button again.

To exit the PROGRAM EDIT press the **TV/TX** button once or the **Menu** button twice.

When you select a programme, the information you entered in the PROGRAM EDIT menu will appear on the top of the screen i.e. P1 BBC1. This will disappear after about three seconds.

TV set up

The TV set up is accessed through a menu system.

Once you have stored your set up, this is the set up the TV will default to when you switch it on.

To enter the MAIN menu press the **Menu** button.

Once in the MAIN menu use the **Program up** and **Program down** buttons to select items in the menu and the **OK** to access sub menus or use the coloured fastext buttons for quick access.

Red button - SOUND
Green button - PICTURE
Pink button - FEATURES

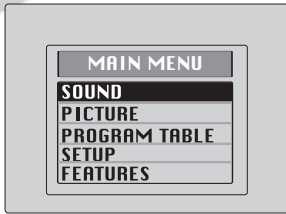

Please note

If you do not press any buttons for 15 seconds the TV will exit the menu system.

Sound menu (red button)

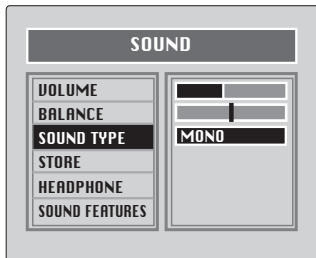

Select the required item in the menu using the **Program up/down** buttons and make the changes pressing **Volume up/down** buttons. Use the **OK** button to enter HEADPHONE and SOUND FEATURES sub menus.

Volume

Sets default volume using the **Volume up** and **down** buttons.



To save your settings, select **STORE** and press the **OK** button. **STORED** will be displayed. Press the **Menu** button to go back to the previous menu.

Balance

Sets the sound balance mode using the **Volume up** and **down** buttons



To save your settings, select **STORE** and press the **OK** button. **STORED** will be displayed. Press the **Menu** button to go back to the previous menu.

Sound type

This item shows **STEREO** when receiving stereo transmission and **MONO** for mono transmissions.

The TV can be produced to receive the **NICAM** broadcasts as a optional feature.

If the channel you are watching is in **Nicam** stereo the **On Screen Display** will show **NICAM STEREO** for a while.

Please Note

If, while watching a **nicam** stereo channel, the signal strength drops and the system cannot receive **nicam** stereo the **OSD** will show **MONO**. If the signal strength increases again and **nicam** stereo can be received again, the **OSD** will show **NICAM STEREO**.

Dual I/II

Some broadcasters supply the programmes in two languages. To able to listen the second language select **DUAL II** by **SOUND TYPE** using **Volume up/down** buttons.



To save your settings, select **STORE** and press the **OK** button. **STORED** will be displayed. Press the **Menu** button to go back to the previous menu.

Headphone

You can set up the volume, balance, bass, treble and sound type (stereo or mono) of the headphone output. Use **OK** button to enter the HEADPHONE menu.



To save your settings, select STORE and press the **OK** button. STORED will be displayed. Press the **Menu** button to go back to the previous menu.

Sound Features

You can set up the Sound Mode, AVL Mode, Dynamic Bass (Optional), Subwoofer (Optional) and Equalizer from **Sound Features** menu.

To access the **Sound Features** menu press the **Red** button on the remote control and press **Volume down** button to select **Sound Features**.

Press **OK** to enter the Sound Features.

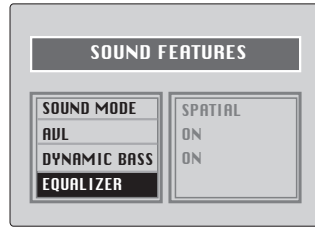

Sound mode

You can select NORMAL, SPATIAL or DOLBY VIRTUAL (optional) using the **Volume up/down** buttons.

SPATIAL sound is an 'expanded stereo'. It gives the impression that the two speakers in the TV are further apart than they really are.

"Virtual Dolby Surround sound is based on Dolby Pro Logic decoding for the reproduction of Left, Right, Centre and Surround channels using two loudspeakers.

Manufactured under license from Dolby Laboratories.

"Dolby", "Pro Logic" and the double-D symbol are trademarks of Dolby Laboratories.

Please Note

To get the surround effects in "Dolby Virtual" mode, you must apply a Dolby Pro Logic coded input to the TV. You can't adjust the AVL and EQUALIZER in DOLBY VIRTUAL mode.

AVL

TV transmitters have different sound levels. AVL (automatic volume limiting) maintains the same sound level as you switch from program to program.

To apply this press **Volume up or down** button and select **ON** for AVL in **Sound Features** menu.

Dynamic Bass (Optional)

To give depth effect to bass sound you can select **Dynamic Bass** as **ON**.

To supply this press **Volume up or down** button and select **ON** for **Dynamic Bass** in **Sound Features** menu.

Note: If you select Dynamic Bass as ON Subwoofer will also be automatically ON. (If the set has subwoofer option).

Equalizer

To access the 5 band equalizer menu press **Volume up** or **down** button and press **OK** on the **Equalizer** line.

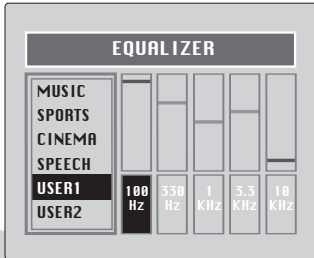







14

In this menu there are a series of preset equalizer settings for different types of sound output.

There are four music settings - MUSIC, SPORTS, CINEMA, SPEECH and USER1 & USER2 modes.

USER modes allow you to set your own sound outputs as follows:



-  Press the **OK** button to enter the **EQUALIZER** menu.
-  Use the **Program down** button to select **USER1**.
-  Press **OK** button to adjust the frequency band levels.
-  Use the **Volume up** button to select the **KHz** column you want to change.
-  Use the **Program up/down** buttons to make the changes.
-  To save your settings, press the **OK** button. Press the **Menu** button to go back to the previous menu.
- 

You can also adjust the settings of **USER2** by the same method.

You can change the equalizer setting whilst watching the TV using the sound **Smart control**.

-  Press the sound **Smart control** to page through the different equalizer settings and select the one you want.

Once you have switched the TV off the equalizer setting will revert to the stored setting.



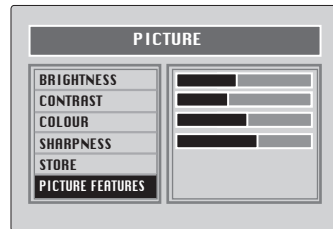

-  When you have finished in the **Sound** sub-menu select **STORE** and press the **OK** button.
-  To exit the sub-menu press the **Menu** button and return to the main menu.

Picture menu (Green button)



The picture menu allows you to set up the following:

BRIGHTNESS
CONTRAST
COLOUR
SHARPNESS
and the other **PICTURE FEATURES**

-  To change, for example, the colour, select it using **Program up** and **down** buttons.
-  Use the **Volume up** and **Volume down** buttons to change the setting.
-  To save your settings, select **STORE** and press the **OK** button. **STORED** will be displayed.
- 
-  These settings are stored as **USER** picture type.

You can change the picture type whilst watching the TV using the picture **Smart control**.

-  Press the picture **Smart control** to page through the different picture types and select the one you want: **SOFT**, **NATURAL**, **RICH** or **USER**.

Picture Features



In the picture menu use the **Program down** button to select **PICTURE FEATURES** and press OK.

In this menu you can adjust the picture quality features.

Use the **Program up** and **down** buttons to select your desired picture feature and use **Volume up** and **down** buttons to adjust this feature.

NOISE REDUCTION: You can reduce the noise effects in the pictures by selecting low, medium or high.

CTI (Colour Transient Improvement):

You can improve the colour transitions in the picture by selecting ON or OFF.

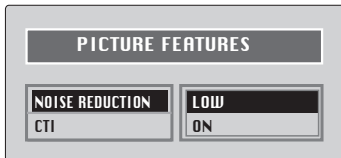

IMPORTANT NOTE: Your TV has Digital Comb Filter and DLTI (Digital Luminance Transient Improvement) features to improve picture quality. These features are set ON and they can not be changed by the end user.

Features Menu (Purple button)



To select **Features** menu press the menu button and using the **Program up** and **down** buttons select **Features**.

You can also select the **Features** menu directly by pressing the **purple** button on the remote control.

The **Features** menu allows you to set up the following:

CHILD LOCK
BLUE BACK
DEGAUSS (opt.)
AV OUT
LANGUAGE
TIMER

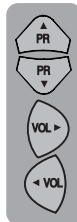

Use the **Program up** and **down** buttons to select the feature you wish to change and use **Volume up** and **down** buttons to adjust this feature.

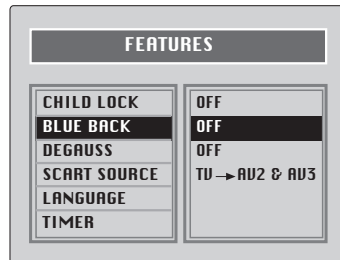



Child Lock: Using the **Child Lock**, you can lock any Program you want so that adult channels can not be watched by children.

You can cancel child lock any time you want. To cancel **Child Lock**, select **Child Lock** as OFF when you are watching that program.



Blue Back (Optional): When there is no broadcast, you can select the background purely blue instead of snowy picture.

Select **blue back** as ON.

Degauss (Optional): If you leave your TV on stand-by mode for a long time or because of strong electro-magnetic field sources, there may be cloudy effects over the picture.

To prevent such effects select **DEGAUSS** and press **Volume up** button.

DEGAUSS will be ON for a short time, the screen will be cleaned and **DEGAUSS** will be OFF again.

Scart Source: You can select the output from your TV to the devices connected to your 2nd and 3rd scarts. So if you want to record or copy the program you are watching, you should output this program to AV2 or AV3, inputs.

The following options are possible

- TV→AV2 & AV3: The current program you are watching,
- TUNER →AV2 & AV3: The program you have last selected,
- AV1, AV2, AV3, AV3-S, AV4, AV4-S→AV2 & AV3: The devices connected to these inputs; are output to the 2nd and 3rd scarts.

Note: 3rd. Scart is optional.

Language: You can select one of the 10 languages by pressing OK button in the language selection.

Timer: Use **Program up** and **down** buttons to select **Timer** in the features menu. Using the Timer function, you can switch to a specific programme at a pre-programmed time or you can turn your TV off at the time you want your TV to be turned off.

Press OK to access the **Timer** menu.

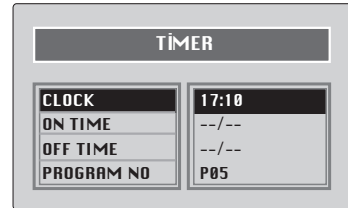

Clock: Use the numeric buttons to set the real time.

On Time: Use the numeric buttons to set the time that you want your TV to be turned on (TV should be on stand-by mode).

Off Time: Use the numeric buttons to set the time that you want your TV to be turned off (Stand-by mode).

Program No: Use the numeric buttons to set the programme number that will be shown when you set the **On Time**.

Picture format



You can adjust the picture format of your TV according to the program format you are watching. Press the “16:9” button to change the Picture format.

Available formats are 16:9, 14:9, 4:3, Letterbox, Subtitle1, Subtitle2 (Optional).

16:9 and **14:9** are the screen formats of widescreen TV sets (28” SF/PF, 32” SF/PF). The TV will automatically switch to this format if it detects 16:9 format from the SCART inputs.

16:9 Colour television

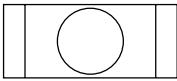

4:3 TV picture format.

4:3 Colour television

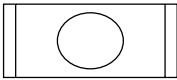
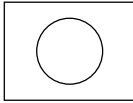

14:9 TV picture format.

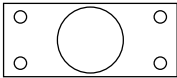
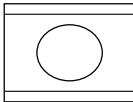

16:9 TV picture format.

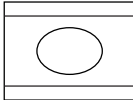

L Box (Letter box), Useful for watching video, some film formats and Pal-Plus format.

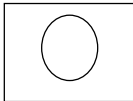
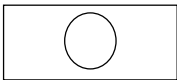

Subtitle1: If you can not see subtitles at the bottom of the screen, especially when watching 4:3 pictures in Letter box format, select Subtitle1.

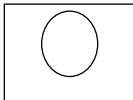
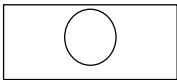

Subtitle2: When Subtitle1 is not enough, select the picture format as Subtitle2.

Subwoofer (optional)

A sub woofer speaker can be fitted within the TV case as an option depending to the model.

For 33”(84cm) TV sets there is an external subwoofer (optional) to be fixed as shown below.

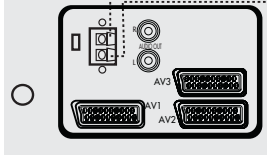
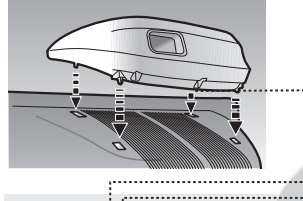

17

Select Sound menu and press **Program down** button to access Sound Features menu. Press **Program down** button and select SUBWOOFER line.

Press the **Volume up** button to switch the Subwoofer on or off.

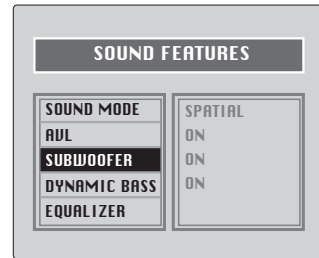

Note: If your TV has Subwoofer and if you turn on the Dynamic Bass, the subwoofer will also automatically turn on. You can not turn your subwoofer off when Dynamic Bass is on.

Setup menu (blue button)

Program table menu (yellow button)

These two menus are explained under “Tuning the TV” and “Program Organising”.

OTHER FEATURES

Picture freeze

FREEZE
DOUB

When you press "FREEZE" key on your remote control, the picture on the screen becomes fixed. To get out of the position, press the same key again.

Picture scan (Optional)

SCAN
REV

OK

You can scan the programmes starting from the current programme you have been watching, on the screen within twelve frames. Press "SCAN" key on your command for this.

To view the desired one from these programmes, press "OK" during scanning. The programme you chose will appear on the screen. To exit, press "SCAN" key.

Blank programmes will not be scanned.

Zoom Function (Optional)

OK

Pressing OK button zooms in to the picture. Zoom function is performed towards the center of the picture.

There are 3 steps Zoom, each time you press the OK button.

ZOOM1, ZOOM2, ZOOM3.

You can also scroll on the picture by pressing **Program up** or **down** and **Volume up** and **down** buttons.

PAT (Picture and Text)

In the double window function, you can also display the teletext screen in the second window. Press the PAP button to see the double window function and then press the purple button on the remote control to see the PAT mode.



Teletext
Mode

Using Teletext

Teletext is an information system that displays text on your TV screen. Using the teletext control buttons you can view pages of information that are listed in the teletext index.

Please Note

No on screen display is available in text mode. The contrast, brightness and colour cannot be changed but the volume control is still available.

To enter Text mode

Please Note

Make sure the TV channel you are watching transmits teletext.



Press the **TV/TXT** button. The text page will appear, normally the index page.

To exit Text mode



Press the **TV/TXT** button. The TV will return to the channel you were watching.

To select a page of text

0

9

Find the number of the page in the index and enter it using the **Numeric** buttons. The number of the page will appear in the top left hand corner of the screen.

The page counter will search for your page. When it finds it, the page will be displayed.



To move to the next page of text press the **Program up** button.



To move to the previous page press the **Program down** button.



To return to the index page press the **P100** button.

TV/text mix



To view a page of text whilst watching a TV programme press the **MIX** button. The text will be superimposed over the TV programme.



Press the **MIX** button again to return to the text page.

Page search whilst watching TV



In Text mode press the **Update** button. The TV will return to TV mode with the text page number in the top left hand corner of the screen.

0

9

Enter the page number you want using the **Numeric** buttons.

The top line of the text page will appear whilst the text searches for your page. When the page is found the number will remain in the top left hand corner of the screen.



Press the **Update** button to view your selected page of text.

Double height text



If you have difficulty reading the text on the TV you can double the height of the text.



Press the **Double height** button. The top half of the page will be displayed in double height text.



Press the **Double height** button again. The bottom half of the page will be displayed in double height text.



Press the **Double height** button again to return to the full page.

Page Stop

If the page of text you have selected contains sub pages, these sub pages will automatically be displayed in order with a delay to allow you to read the page.



To stop the move to the next sub page press the **HOLD** button. STOP will appear in the top left hand corner.



To continue moving through the sub pages press the **HOLD** button again.

To select a sub page

If the page of text you are viewing contains sub pages, the number of the sub page you are on and the total number of sub pages is displayed on the right of the screen i.e. 1/7.



To select a sub page press the **SUB** button. The number in the top left hand corner will be replaced by S followed by 4 asterisks.



Enter the number of the sub page, using the **Numeric** buttons in the format S0001 for sub page 1.

The teletext will search for the sub page. This may take some time. To return to the TV whilst the teletext is searching press the **Update** button.

When the page number is found it will appear in the top left hand corner of the screen.



Press the **Update** button again to view the text page.

To reveal information



Press the **Rev** button to reveal concealed information (quiz answers etc.).



Press the **Rev** button again to conceal the information again.

Clock



Press the **Sub** button, whilst watching a TV program, to display the time.

Fast text

At the bottom of the teletext screen is a row of subject headings in red, green yellow and blue.

The remote control has a row of coloured buttons corresponding to the row of coloured subjects on the screen.

Pressing one of the coloured buttons will take you directly to the page corresponding to the subject heading.

Toptext (optional)

At the bottom of the teletext screen is a row of subject headings in yellow and blue. Pressing yellow or blue buttons on the remote control, selects the related Subject. Next page can be selected by pressing the red button and previous page can be selected by pressing the green button.

Note: Fasttext and Toptext features are not available in every program.

Connecting external equipment

You can connect a wide range of audio and video equipment to your TV.

Connecting a video recorder

① Via SCART

Make sure the TV and video recorder are both switched off.

Plug one end of the SCART lead (not supplied) into the back of the video recorder and the other end into one of the SCART sockets on the back of the TV.

Switch on the video recorder and the TV.

 Press the **AV** button on the remote control to select AV1, AV2 or AV3 (optional) to correspond with SCART socket you are using on the back of the TV.

Please note:

You can connect a RGB external equipment via Scart 3 (optional) or Scart 1. It is necessary to you use full Scart cable for this purpose.

Select the video outputs of external device by using its menu to RGB if it's available.

② Via RCA lead (optional)

Make sure the TV and video recorder are both switched off.

Plug one end of the RCA lead into the video and audio out sockets on the back of the video recorder and plug the other end into the video and audio in sockets of the TV.

If the sound is in mono use the Audio Input L. In the SOUND menu select MONO.

 Press the **AV** button repetitively and select the AV3 (AV4 optional) mode.

Please note:

When using RCA lead, you should select AV4 in 3 Scart models and AV3 in 2 Scart models.

③ Via aerial socket

Make sure the TV and video recorder are both switched off.

Unplug the aerial lead from the TV and plug it into the aerial socket on the video recorder (if fitted).

Plug a coaxial plug into the RF out socket on the rear of the video recorder and plug the other end into the aerial socket of the TV.

Switch on the video recorder and the TV.

If your video recorder has a test signal, switch it on. (Refer to the video recorder user guide).

See 'Tuning the TV' and carry out the tuning procedure for the video recorder test signal. Select a programme number 0.

④ S-Video Player

If you have an S-Video player you can connect it to SCART socket 3 (optional) via an adaptor from scart to S-Video/RCA audio (not supplied).



Press the **AV** button repetitively to select AV3-S.(3 scart models only)

⑤ Via RCA lead and S-Video socket

You can also connect it through the S-Video socket of the TV.

Plug the S-Video plug into the S-Video socket and the audio leads into the audio sockets.



Press the **AV** button repetitively to select AV3-S or AV4-S (optional).

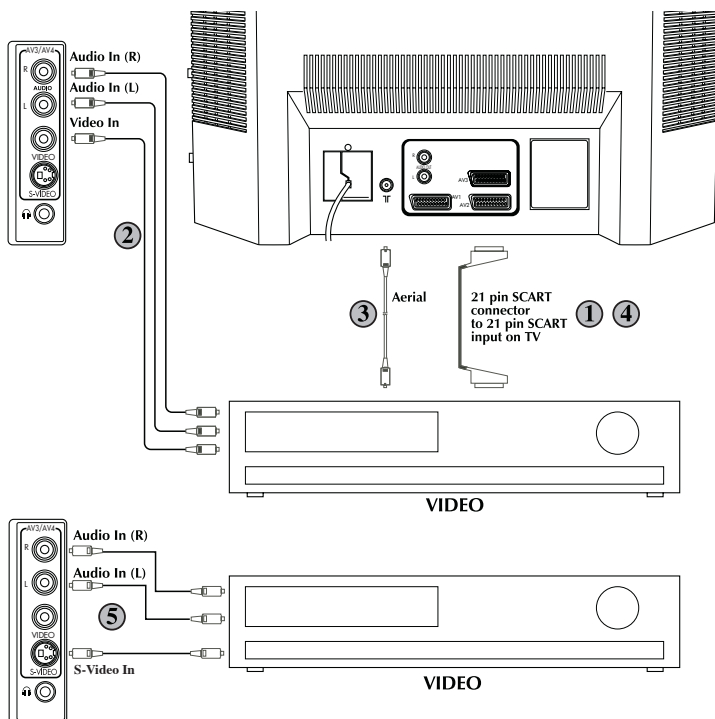

Connecting a DVD player

① Via SCART

Make sure the TV and DVD player are both switched off.

Plug one end of the SCART lead (not supplied) into the back of the DVD player and the other end into one of the SCART sockets on the back of the TV.

Switch on the DVD and the TV.

AV

Press the **AV** button on the remote control to select AV1, AV2 or AV3 correspond with SCART socket you are using on the back of the TV.

Note: Scart 1 and Scart 3 (optional) will give you RGB picture quality. For DVD connections RGB capable scart sockets (AV1 or AV3) are recommended.

② Via RCA lead (optional)

Make sure the TV and DVD player are both switched off.

Plug one end of the RCA lead into the video and audio out sockets on the back of the DVD player and plug the other end into the video and audio in sockets of the TV.

AV

Press the **AV** button repetitively and select the AV3 (AV4 optional) mode.

③ Via RCA lead and S-Video socket

You can also connect it through the S-Video socket of the TV.

Plug the S-Video plug into the S-Video socket and the audio leads into the audio sockets.

AV

Press the **AV** button repetitively to select AV3-S or AV4-S (optional).

23

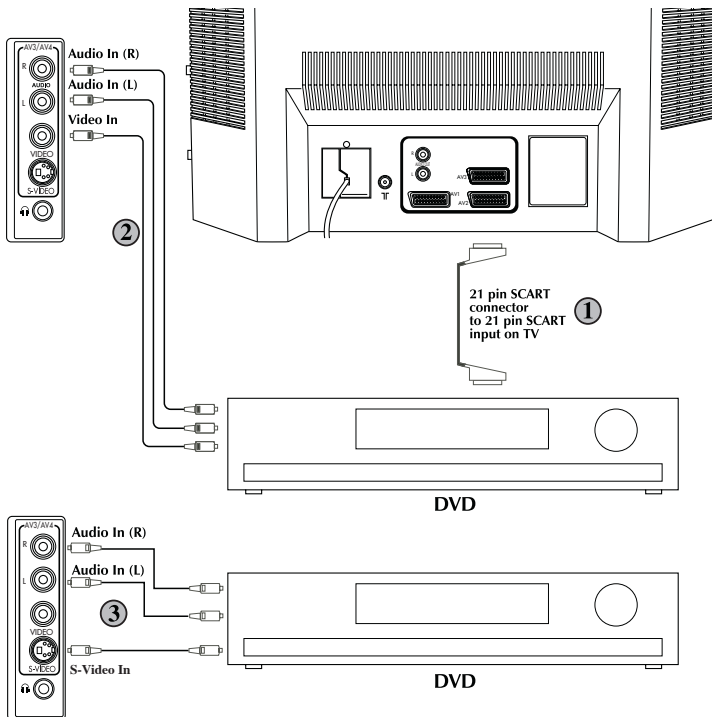

Connecting a decoder

Via SCART

Make sure the TV and decoder are both switched off.

Plug one end of the SCART lead (not supplied) into the back of the decoder and the other end into the SCART 1 on the back of the TV.

Switch on the decoder and the TV.

AV

Press the AV button on the remote control to select AV1.

AV

Press the AV button repetitively and select the AV3 mode (AV4 optional).

Please Note

You can record from one external device to another via scart sockets. You should select the source and destination of video using FEATURES menu. If you select the source as AV3/AV3-S or AV4/AV4-S (optional) you will have a "WARNING: COPY FUNCTION ACTIVE" message on the screen. You will not have picture at AV4/AV4-S if you select source AV3/AV3-S or vice versa.

You can connect NTSC supported equipment to the TV via the SCART sockets and adjusting the colour via the PICTURE menu.

24

2 Via RCA lead

Make sure the TV and decoder are both switched off.

Note: For Decoder connection Via RCA lead your Decoder device should have the tuner built in.

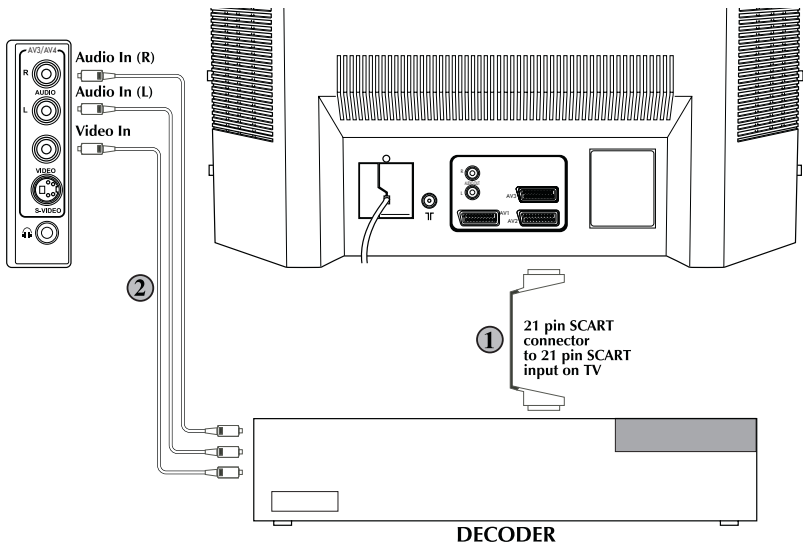

Connecting TV with video and satellite/digital receiver

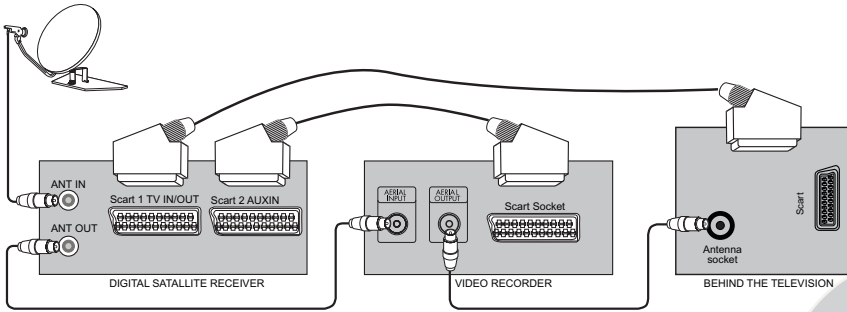

25

Connecting TV with camcorder

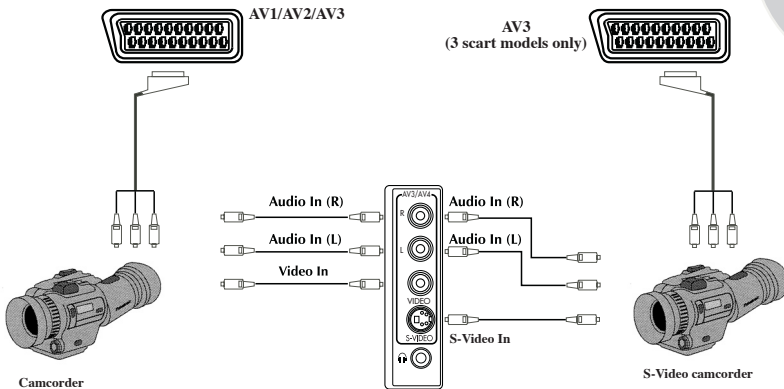

Connecting TV games and computer

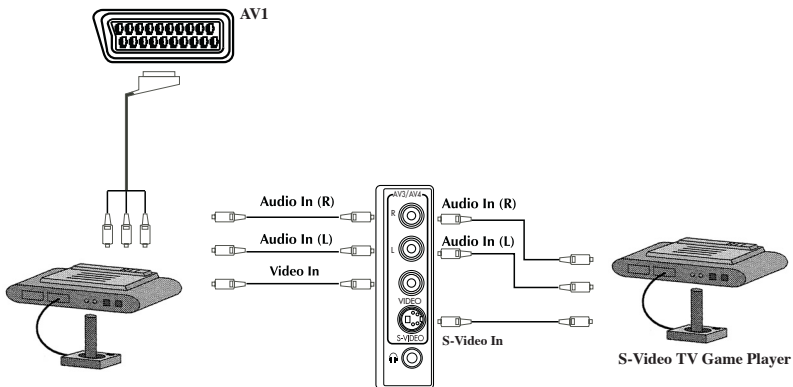

Help and service tips

The TV does not work

Make sure it is plugged into the mains supply and switched on.

Poor picture

- Is the aerial plugged in?
- If you are using a set top aerial is it properly aligned for the best signal.
- Make sure the aerial is not close to neon lights, loudspeakers etc.
- Try changing the direction of the outdoor aerial. High buildings and mountains can cause ghost pictures or double images.
- The picture quality may be reduced by connecting two external sources at once. Disconnect one of the sources.
- Adjust the fine tuning.

No picture

- Is the aerial plugged in properly?
- Is the aerial lead damaged?
- Are all the plugs in the aerial lead fitted correctly?
- Have you pressed the correct buttons on the remote control?

No sound

- Is the sound muted? Press the Mute button.
- Is the volume turned down?
- Are there headphones connected?

Sound coming from only one speaker

- Is the balance set to one side? See the sound menu.
- If you have external speakers, has one of them become disconnected.

No response to the remote control

- Try changing the batteries.
- Is there an obstruction between the remote control and the sensor on the TV.

If nothing works

If you have tried the above solutions and none seem to work, try switching the unit off and on again.

If this does not work contact your supplier or TV repair technician. Never attempt to repair a defective TV yourself.

Symptoms	Solutions	Check if on/off switch is "on"	Try a different channel. If OK, probably station trouble	Check aerial connections on back of set	Check aerial broken wires	Re orientate aerial	Probably local interference, such as an appliance	Adjust fine tuning control	Adjust brightness control	Adjust contrast control	Check if station is broadcasting colour	Adjust colour control	Check batteries in the remote control handset.	Switch the TV set OFF and ON from mains	Move the loudspeakers away from the television	Switch off the television set at the mains and switch on again after 15 minutes
No picture, no sound		✓	✓	✓	✓			✓								
Poor sound, picture OK		✓	✓	✓	✓											
Poor Picture, sound OK		✓	✓	✓	✓				✓							
Weak picture		✓	✓	✓	✓			✓								
Blurred picture		✓	✓	✓	✓			✓								
Double image		✓	✓	✓	✓			✓								
Lines in picture		✓	✓	✓	✓			✓								
Distorted picture		✓	✓	✓	✓			✓								
Weak reception on some channels		✓	✓	✓	✓			✓								
Horizontal bars		✓	✓	✓	✓			✓								
Picture rolls vertically		✓	✓	✓	✓			✓								
Poor colour		✓	✓	✓	✓			✓	✓	✓						
No colour		✓	✓	✓	✓			✓			✓	✓				
Remote control not working													✓	✓		
TV does not accept any command														✓		
Teletext rolling up/down														✓		
Inappropriate colour, color spots															✓	✓

Technical specifications table

Picture tube size/type	28" 4:3	28" 16:9 SF	28" 16:9 PF	29" 4:3 SF	29" 4:3 PF	32" 16:9 SF	32" 16:9 PF	33" 4:3
Screen size	70 cm	70 cm	70 cm	72 cm	72 cm	82 cm	82 cm	84 cm
Visible screen size	66 cm	66 cm	66 cm	68 cm	68 cm	77 cm	77 cm	80 cm
Sound Output (%10 THD)	2x12 W	2x12 W	2x12 W	2x12 W	2x12 W	2x12 W	2x12 W	2x12 W
Power consumption	90 W	100 W	100 W	105 W	105 W	110 W	110 W	125 W
Stand by Power consumption	4 W	4 W	4 W	4 W	4 W	4 W	4 W	4 W
Subwoofer	optional 20 W	optional 20 W	optional 20 W	optional 20 W	optional 20 W	optional 20 W	optional 20 W	optional 20 W
Dolby Virtual	optional	optional	optional	optional	optional	optional	optional	optional

SF : Superflat picture tube

PF : Pureflat picture tube

16:9 : Widescreen TV

4:3 : Conventional TV

Please note:

Using a subwoofer causes 20 W extra power consumption and supplies maximum 20 W extra sound output.

General technical specifications

Power Supply

AC: 230-240V 50Hz

Number of preset programmes 100

RF Aerial input 75 ohm (unbalanced)

Speaker impedance 8 ohm

Sound Systems..... Mono/Stereo/NICAM (optional)

Batteries 2x AAA

Receiving channels VHF (Band I Channels 2-4)

..... VHF (Band III Channels 5-12)

..... UHF (Channels 21-69)

..... Cable TV (S1-S20/S21-S41)

Receiving broadcast system..... PAL BG

PAL SECAM BG

PAL SECAM BG DK/DK´

PAL SECAM BG LL´

PAL I

Please note: Your TV set is produced to receive only “one “ of this colour and sound system options which is based on your country's norms and can not be changed by user except BG/DK and BG/LL´ if both systems are available to receive (BG or DK and BG or LL´). Please refer to “Tuning the TV”.

Free Manuals Download Website

<http://myh66.com>

<http://usermanuals.us>

<http://www.somanuals.com>

<http://www.4manuals.cc>

<http://www.manual-lib.com>

<http://www.404manual.com>

<http://www.luxmanual.com>

<http://aubethermostatmanual.com>

Golf course search by state

<http://golfingnear.com>

Email search by domain

<http://emailbydomain.com>

Auto manuals search

<http://auto.somanuals.com>

TV manuals search

<http://tv.somanuals.com>