

User Guide

INSIGNIA™

Home Theater System

NS-HT511



Contents

Introduction	1
Safety information	1
Ventilation	1
Power cord	1
Important safety instructions	1
Precautions	2
Components	3
Features	3
Package contents	3
Front controls	3
Display	4
Back	4
Subwoofer	4
Front, center, and surround speakers	5
Remote control	5
Setting up your home theater system	6
Finding a location for your home theater system	6
Placing your speakers	6
Connecting your speakers to the receiver	7
Connecting devices	8
Using rubber feet/pads for more stable speakers	11
Wall mounting your speakers	11
Rocketboost Setup	12
Installing batteries in the remote control	15
Using the remote control	15
Configuring speakers (Sp Config menu)	16
Setting speaker distance (Sp Distance menu)	16
Setting the level calibration (Level Cal menu)	17
Operating your receiver	17
Turning your receiver on and off	17
Understanding basic operations	17
Listening to your receiver	18
Listening to the radio	18
Presetting FM or AM stations	19
Using the listening modes	19
Using advanced setup	22
Using on-screen setup menus	22
Setting up HDMI input (HDMI Input menu)	22
Setting up Component input (Component menu)	22
Setting up Digital Audio (Digital Audio menu)	22
Adjusting the audio (Audio Adjust menu)	23
Setting up HDMI (HDMI Setup menu)	24
Changing audio settings	25
Naming inputs (Name Edit menu)	26
Selecting a digital input signal format (Fixed Mode)	26

Controlling other components 27
 Preprogrammed remote control codes 27
 Using the remote control to control other components 27
 Remote control codes 28

Maintaining 31

Troubleshooting 31

Specifications 33
 Amplifier section 33
 Video section 33
 Tuner section 33
 General section 33
 Subwoofer 33
 Front speakers 34
 Center speaker 34
 Surround speakers 34

Legal notices 34
 Dolby TrueHD 35
 DTS HD® 35
 HDMI® 35

One-year limited warranty 37

Insignia NS-HT511

Home Theater System

Introduction

Congratulations on your purchase of a high-quality Insignia product. Your NS-HT511 represents the state of the art in home theater system design and is designed for reliable and trouble-free performance.

Safety information

<p>WARNING: TO REDUCE THE RISK OF FIRE OR ELECTRIC SHOCK, DO NOT EXPOSE THIS APPARATUS TO RAIN OR MOISTURE.</p> <p>CAUTION: TO REDUCE THE RISK OF ELECTRIC SHOCK, DO NOT REMOVE COVER (OR BACK). NO USER-SERVICEABLE PARTS INSIDE. REFER SERVICING TO QUALIFIED SERVICE PERSONNEL.</p>	<p>WARNING RISK OF ELECTRIC SHOCK DO NOT OPEN</p> <p>AVIS RISQUE DE CHOC ELECTRIQUE NE PAS OUVRIR</p>
--	---

The lightning flash with arrowhead symbol, within an equilateral triangle, is intended to alert the user to the presence of uninsulated “dangerous voltage” within the product’s enclosure that may be of sufficient magnitude to constitute a risk of electric shock to persons.

The exclamation point within an equilateral triangle is intended to alert the user to the presence of important operating and maintenance (servicing) instructions in the literature accompanying the appliance.

Ventilation

Caution

Do not block any ventilation openings. Install in accordance with these instructions.

Slots and openings in the cabinet are provided for ventilation and to ensure reliable operation of your system and to protect it from over-heating.

The openings should never be blocked by placing your system on a bed, sofa, rug, or other similar surface. This system should not be placed in a built-in installation such as a bookcase or rack unless correct ventilation is provided or these instructions have been adhered to.

Power cord

Caution

We recommend that most appliances be placed upon a dedicated circuit—a single outlet circuit which powers only that appliance and has no additional outlets or branch circuits. Check the specification page of this manual for power requirements.

Do not overload wall outlets. Overloaded wall outlets, loose or damaged wall outlets, extension cords, frayed power cords, or damaged or cracked wire insulation are dangerous. Any of these conditions could result in electric shock or fire.

Periodically examine the power cord. If its appearance indicates damage or deterioration, unplug it, discontinue use of your system, and have the cord replaced with an exact replacement part by an authorized service provider.

Protect the power cord from physical or mechanical abuse, such as being twisted, kinked, pinched, closed in a door, or walked upon. Pay particular attention to plugs, wall outlets, and the point where the cord exits your receiver.

To disconnect power from the outlet, pull out the plug. When installing your system, make sure that the plug is easily accessible.

Important safety instructions

- 1 Read these instructions.
- 2 Keep these instructions.
- 3 Heed all warnings.
- 4 Follow all instructions.
- 5 Do not use this apparatus near water.
- 6 Clean only with dry cloth.
- 7 Do not block any ventilation openings. Install in accordance with the manufacturer’s instructions.
- 8 Do not install near any heat sources such as radiators, heat registers, stoves, or other apparatus (including amplifiers) that produce heat.
- 9 Do not defeat the safety purpose of the polarized or grounding-type plug. A polarized plug has two blades with one wider than the other. A grounding type plug has two blades and a third grounding prong. The wide blade or the third prong are provided for your safety. If the provided plug does not fit into your outlet, consult an electrician for replacement of the obsolete outlet.
- 10 Protect the power cord from being walked on or pinched particularly at plugs, convenience receptacles, and the point where they exit from the apparatus.
- 11 Only use attachments/accessories specified by the manufacturer.

12 Use only with the cart, stand, tripod, bracket, or table specified by the manufacturer, or sold with the apparatus. When a cart is used, use caution when moving the cart/apparatus combination to avoid injury from tip-over.

PORTABLE CART WARNING



13 Unplug this apparatus during lightning storms or when unused for long periods of time.

14 Refer all servicing to qualified service personnel. Servicing is required when the apparatus has been damaged in any way, such as power-supply cord or plug is damaged, liquid has been spilled or objects have fallen into the apparatus, the apparatus has been exposed to rain or moisture, does not operate normally, or has been dropped.

15 Damage Requiring Service
Unplug the apparatus from the wall outlet and refer servicing to qualified service personnel under the following conditions:

- When the power-supply cord or plug is damaged,
- If liquid has been spilled, or objects have fallen into the apparatus,
- If the apparatus has been exposed to rain or water,
- If the apparatus does not operate normally by following the operating instructions. Adjust only those controls that are covered by the operating instructions as an improper adjustment of other controls may result in damage and will often require extensive work by a qualified technician to restore the apparatus to its normal operation,
- If the apparatus has been dropped or damaged in any way, and
- When the apparatus exhibits a distinct change in performance this indicates a need for service.

16 Object and Liquid Entry

- Never push objects of any kind into the apparatus through openings as they may touch dangerous voltage points or short-out parts that could result in a fire or electric shock.
- The apparatus shall not be exposed to dripping or splashing and no objects filled with liquids, such as vases shall be placed on the apparatus.
- Don't put candles or other burning objects on top of this unit.

17 Batteries

Always consider the environmental issues and follow local regulations when disposing of batteries.

18 If you install the apparatus in a built-in installation, such as a bookcase or rack, ensure that there is adequate ventilation.

Leave 20 cm (8") of free space at the top and sides and 10 cm (4") at the rear. The rear edge of the shelf or board above the apparatus shall be set 10 cm (4") away from the rear panel or wall, creating a flue-like gap for warm air to escape.

The temperature protection operates if the apparatus attains an abnormally high temperature. The apparatus cannot operate until it has cooled down.

Precautions

- 1** Recording copyrighted material—Unless it's for personal use only, recording copyrighted material is illegal without the permission of the copyright holder.
- 2** AC fuse—The AC fuse inside the unit is not user-serviceable. If you cannot turn on the unit, contact your Insignia dealer.
- 3** Care—Occasionally you should dust the unit all over with a soft cloth. For stubborn stains, use a soft cloth dampened with a weak solution of mild detergent and water. Dry the unit immediately afterwards with a clean cloth. Don't use abrasive cloths, thinners, alcohol, or other chemical solvents, because they may damage the finish or remove the panel lettering.

4 Power

Warning

Before plugging in the unit for the first time, read the following section carefully.

AC outlet voltages vary from country to country.

Make sure that the voltage in your area meets the voltage requirements printed on the unit's rear panel (e.g., AC 230 V, 50 Hz or AC 120 V, 60 Hz).

The power cord plug is used to disconnect this unit from the AC power source. Make sure that the plug is readily operable (easily accessible) at all times.

Pressing ON/STANDBY to select Standby mode does not fully shutdown the unit. If you do not intend to use the unit for an extended period, remove the power cord from the AC outlet.

5 Preventing Hearing Loss

Caution

Excessive sound pressure from earphones and headphones can cause hearing loss.

6 Batteries and heat exposure

Warning

Batteries (battery pack or batteries installed) shall not be exposed to excessive heat as sunshine, fire, or the like.

7 Never touch this unit with wet hands—Never handle this unit or its power cord while your hands are wet or damp. If water or any other liquid gets inside this unit, have it checked by your Insignia dealer.

8 Handling notes

- If you need to transport this unit, use the original packaging to pack it how it was when you originally bought it.
- Do not leave rubber or plastic items on this unit for a long time, because they may leave marks on the case.
- This unit's top and rear panels may get warm after prolonged use. This is normal.

Components

Features

- 90 Watts per Channel @ 8 ohms
- Rocketboost™ Expandable Wireless Audio Technology: sends wireless audio for surround sound, subwoofer, and left/right channels; receives wireless audio from Rocketboost devices (Requires Rocketboost Wireless Card, RF-RBCARD, sold separately)
- HDMI (Audio Return Channel, 3D), Deep-Color, x.v.Color*, Lip Sync, DTS-HD Master Audio, DTS-HD High Resolution Audio, Dolby® TrueHD, Dolby® Digital Plus, DSD and Multi-CH PCM
- 4 HDMI Inputs and 1 Output
- 3 Digital Inputs (2 Optical/1 Coaxial)
- Component Video Switching (2 Inputs/1 Output)
- 40 FM/AM Presets
- H.C.P.S. (High Current Power Supply) Massive High Power Transformer
- Direct Mode
- 192 kHz/24-bit D/A Converters
- Powerful and Highly Accurate 32-bit Processing DSP
- Crossover Adjustment (40/50/60/70/80/90/100/120/150/200 Hz)
- A/V Sync Control Function (up to 400 ms)
- On-Screen Display via HDMI

* "x.v.Color" is a trademark of Sony Corporation.

Rocketboost Wireless Card Ready

Installing a Rocketboost Wireless Card (sold separately) enables this product to send and receive wireless audio with your other Rocketboost products.



What is Rocketboost?

Rocketboost is expandable wireless digital audio.

- Products with Rocketboost™ technology let you easily expand your listening experience throughout your home.
- Rocketboost does not interfere with other wireless products in your home.
- Rocketboost is uncompressed digital audio compatible with all audio formats such as Dolby, TrueHD, and DTS-HD Master Audio used with Blu-ray.

When you see the Rocketboost logo on any product, it has been designed to work with other Rocketboost products, no matter who manufactures them.

Package contents

- Receiver
- Front Speakers (2)
- Center Speaker
- Surround Speakers (2)
- Subwoofer
- Remote control
- AA batteries (2)
- FM antenna
- AM antenna

- Color labels for speaker cables
- Speaker cables:
 - 11 ft. (3)
 - 26 ft. (2)
- RCA cable 10 ft.
- Rubber spacers for speakers (30)
- *Quick Setup Guide*
- *User Guide*

Front controls

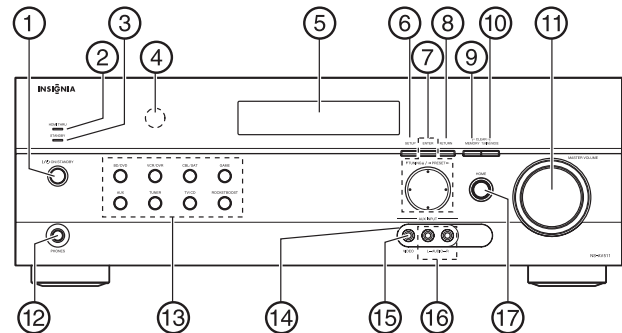

Item	Description	Function
1	/ ON/STANDBY button	Press to turn on your stereo receiver.
2	HDMI THRU indicator	Lights when the HDMI pass-through function is activated in standby mode.
3	STANDBY indicator	Lights red when your stereo receiver is in standby mode.
4	Remote control sensor	Receives the signal from the remote control.
5	Display	See "Display" on page 4 for additional information.
6	SETUP button	Press to open the on-screen menus.
7	TUNING ▲/▼ PRESET ◀/▶ ENTER	Press TUNING ▲/▼ to tune the radio to the next or previous station. Press PRESET ◀/▶ to tune the radio to the next or previous station preset. Press ENTER to confirm a selection.
8	RETURN button	In menu mode, press to return to the main menu.
9	MEMORY button	Press to save a radio station preset. Press with the TUNING MODE button to clear presets.
10	TUNING MODE button	Press to turn on the receiver tuning mode and listen to the radio. Press with the MEMORY button to clear presets.
11	MASTER VOLUME knob	Turn to increase or decrease the volume.
12	Headphone jack	Plug your headphones into this jack.
13	Input selector buttons	Press to select the input signal source you want.
14	Protective cap	A rubber cap protecting the A/V jacks. Remove the cap when using the jacks.
15	AUX INPUT VIDEO jack	Plug an external video source into this jack.
16	AUX INPUT AUDIO L/R jacks	Plug an external sound source into this jack.
17	HOME button	Press to access audio settings. See "Changing audio settings" on page 25.

Display

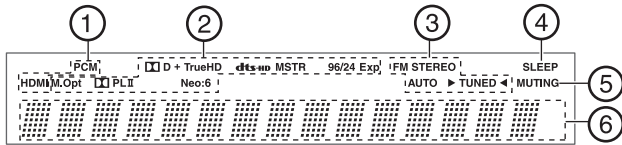

#	Indicator
1	Audio input indicator
2	Listening mode indicator
3	Tuning indicators
4	SLEEP indicator
5	MUTING indicator
6	DIGITAL display

Back

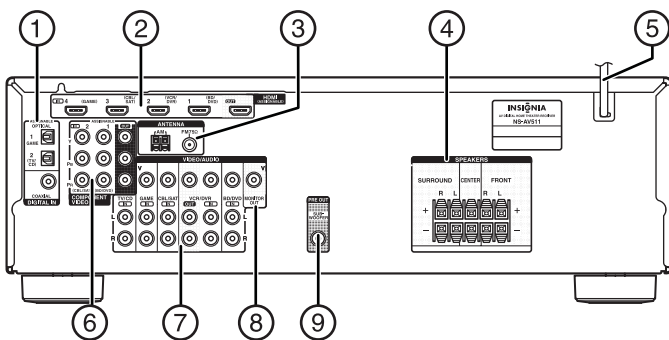

#	Description	Function
1	DIGITAL IN jacks	Plug the optical digital cable from a game (1) or TV/CD (2) into the upper jacks, or the coaxial digital cable from a BD/DVD into the lower jack.
2	HDMI jacks	Plug the HDMI signal input cable from a GAME (IN4), CBL/SAT (IN3), VCR/DVR (IN2), BD/DVD (IN1). Plug the HDMI output signal cable to a TV or monitor into the OUT jack.
3	ANTENNA connectors	Connect a 75 ohm FM antenna to the coaxial connector or an AM loop antenna to the wire connectors.
4	FRONT SPEAKERS SURROUND SPEAKERS CENTER SPEAKER	Connect the front speakers to these jacks. Connect the left and right surround speakers and the center speaker to these connectors. If you use the RF-RBCARD to connect your surround speakers, do not connect them here.
5	AC power cord	Plug this cord into an AC power outlet.
6	COMPONENT video jacks	Plug the cables from a component video source into the #1 (BD/DVD) or #2 (CBL/SAT) jacks. Plug the cables to a component video monitor into the OUT jacks. The jacks are color coded (red, green, and blue) to correspond to the cable connectors.
7	Composite Video and Audio L/R jacks	Plug the composite video and audio L/R output cables from the indicated devices into these jacks. For video recording, plug the composite video and audio L/R input cables to a VCR or DVR into the OUT jacks
8	MONITOR OUT V (Video)	Connect this jack to a TV monitor.
9	SUBWOOFER	Connect the subwoofer to this jack.

Subwoofer

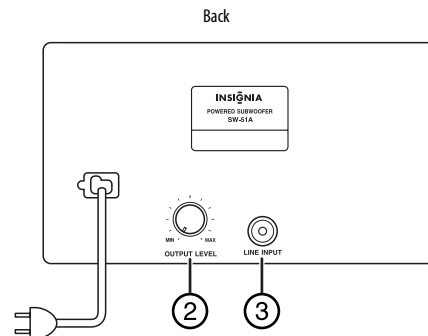
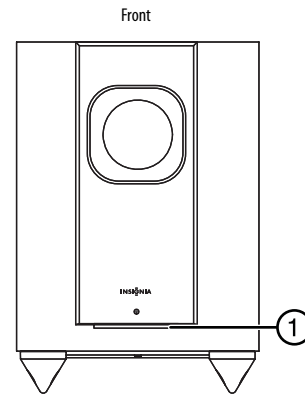

#	Description	Function
1	Standby/On indicator	Red: Subwoofer in standby mode Blue: Subwoofer on With the auto standby function, the subwoofer automatically turns on when an input signal is detected in standby mode. When there is no input signal, the subwoofer automatically enters standby mode. Note: The auto standby function turns the subwoofer on when the input signal exceeds a certain level. If the auto standby function does not work reliably, try slightly increasing or decreasing the subwoofer output level on the receiver
2	OUTPUT LEVEL control	This control is used to adjust the volume of the subwoofer.
3	LINE INPUT jack	This jack should be connected to the subwoofer pre-out on the AV receiver with the supplied RCA cable.

Front, center, and surround speakers

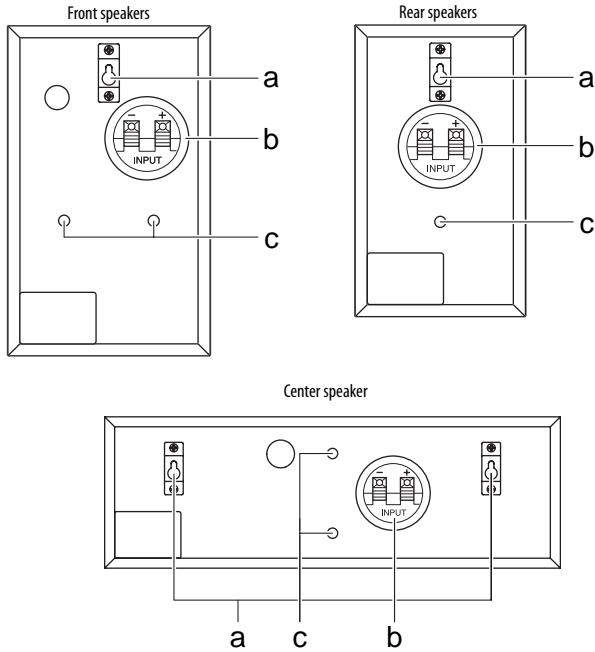

#	Description	Function
1	Keyhole slots	Used to wall-mount the speakers.
2	Speaker terminals	These push terminals are for connecting the speaker to the receiver with the supplied speaker cables.
3	Threaded Inserts	These threaded inserts are for Init®-Home Theater Speaker Mounts NT-SWM series.

Remote control

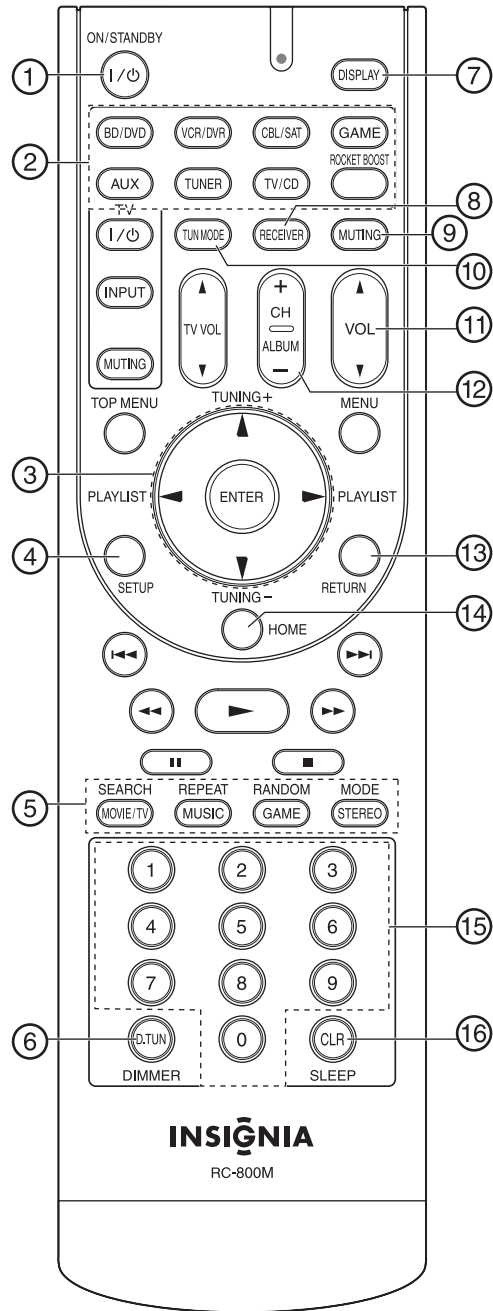

Item	Description	Function
1	ON/STANDBY button	Press to turn the power on to your receiver. Press again to go to standby mode.
2	Remote mode input selector buttons	Press to directly select your receiver input source.
3	ENTER ◀/▶/▲/▼ TUNING+/-	Press the arrow keys to navigate through the on-screen menus. Press ENTER to confirm a selection or setting. In tuning mode, press to tune to the next (TUNING+) or previous (TUNING-) station.
4	SETUP button	Press to open the on-screen menus.
5	LISTENING MODE buttons	Press to select the listening mode you want. See "Using the listening modes" on page 19 for additional information.

Item	Description	Function
6	D.TUN DIMMER	In tuner mode, press D.TUN , then the number buttons to tune directly to a frequency. Press DIMMER to adjust the brightness of the display.
7	DISPLAY button	Press repeatedly to cycle through the available input source information.
8	RECEIVER button	Press to control the receiver.
9	MUTING button	Press to mute the sound output from the receiver.
10	TUN MODE button	Press to toggle between auto and manual tuning modes.
11	VOL ▲ / ▼ buttons	Press to increase or decrease the sound volume.
12	CH +/- buttons ALBUM	In tuner mode, press to go to the next or previous preset channel.
13	RETURN button	In menu mode, press to return to the main menu or previous menu.
14	HOME button	Press to access audio settings. See "Changing audio settings" on page 25.
15	Number buttons	Press to enter a preset number or to manually tune the radio.
16	SLEEP/CLR button	Press repeatedly to select the sleep timer duration. In menu mode, press to clear an entry.

Setting up your home theater system

Finding a location for your home theater system

- Install your home theater system on a stable flat surface. Position your receiver so that it has a direct line of sight to the remote control.
- Do not expose your system to extremes of temperature or humidity.
- Avoid placing your system on a hot surface such as on top of other hot running equipment. Make sure that there is adequate ventilation to your system.

Caution

Do not install the receiver in a confined space such as a bookcase.

Caution

Connect the AC cord only after the speakers, antenna, and all optional equipment have been connected. Never make or change any connections with the power turned on.

Placing your speakers

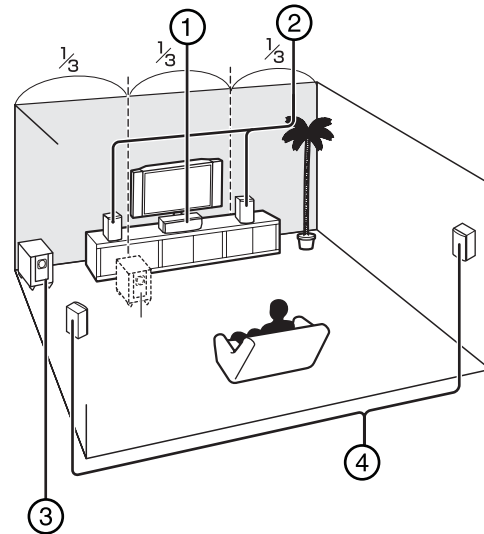

1 - Center speaker

This speaker enhances the front speakers, making sound movements distinct and providing a full-sound image. In movies it is used mainly for dialog. Position it close to your TV facing forward at about ear level, or at the same height as the front speakers.

2 - Front speakers

These provide the overall sound. Their role in a home theater system is to provide a solid anchor for the sound image. They should be positioned facing the listener at about ear level, and equidistant from the TV. Angle them inward so as to create a triangle, with the listener at the apex.

3 - Subwoofer

The subwoofer handles the bass sounds of the LFE (Low-Frequency Effects) channel. The volume and quality of the bass output from your subwoofer depends on its position, the shape of your listening room, and your listening position. In general, a good bass sound can be obtained by installing the subwoofer in a front corner, or at one-third the width of the wall, as shown.

Tip

To find the best position for your subwoofer, while playing a movie or some music with good bass, experiment by placing your subwoofer at various positions within the room, and choose the one that provides the most satisfying results.

4 - Surround speakers

These speakers are used for precise sound positioning and to add realistic ambience. Position them at the sides of the listener, or slightly behind, about two to three feet (60 to 100 cm) above ear level. Ideally they should be equidistant from the listener.

Speaker precautions

- Do not put water or other liquids close to the speakers. If liquid is spilled on the speakers, they may be damaged.
- Speakers should only be placed on sturdy, flat surfaces that are free from vibration. Putting them on uneven or unstable surfaces, where they may fall and cause damage, affects the sound quality.

Connecting your speakers to the receiver

Speaker configuration

The following table indicates the channels you should use depending on the number of speakers that you have. For 5.1-channel surround-sound playback, you need five speakers and a powered subwoofer.

Number of channels	2	3	4	5
Front speakers	2	2	2	2
Center speaker		1		1
Surround speakers			2	2

No matter how many speakers you use, a powered subwoofer is recommended for a really powerful and solid bass.

To get the best from your surround sound system, you need to set the speaker settings.

Attaching the speaker cable labels

The AV receiver's positive (+) speaker terminals are all red. (The negative (-) speaker terminals are all black.)

Speaker	Color
Front left	White
Front right	Red
Center	Green
Surround left	Blue
Surround right	Gray

The supplied speaker cable labels are also color-coded. You should attach them to the positive (+) side of each speaker cable in accordance with the table above. Then all you need to do is to match the color of each label to the corresponding speaker terminal.

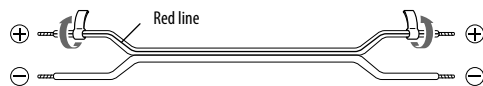

Speaker connection precautions

Read the following before connecting your speakers:

- You can connect speakers with an impedance of between 6 and 16 ohms. If you use speakers with a lower impedance, and use the amplifier at high volume levels for a long period of time, the built-in amp protection circuit may be activated.
- Disconnect the power cord from the wall outlet before making any connections.
- Pay close attention to speaker wiring polarity. In other words, connect positive (+) terminals only to positive (+) terminals, and negative (-) terminals only to negative (-) terminals. If you get them the wrong way around, the sound will be out of phase and will sound unnatural.
- Unnecessarily long, or very thin speaker cables may affect the sound quality and should be avoided.
- Be careful not to short the positive and negative wires. Doing so may damage the receiver.

- Make sure the metal core of the wire does not contact the receiver's rear panel. Doing so may damage the receiver.

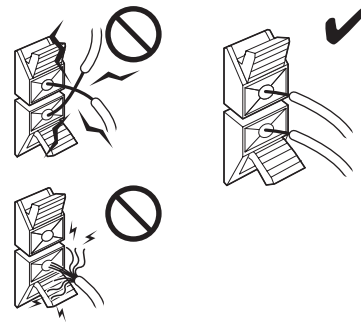

- Don't connect more than one cable to each speaker terminal. Doing so may damage the receiver.
- Don't connect one speaker to several terminals.

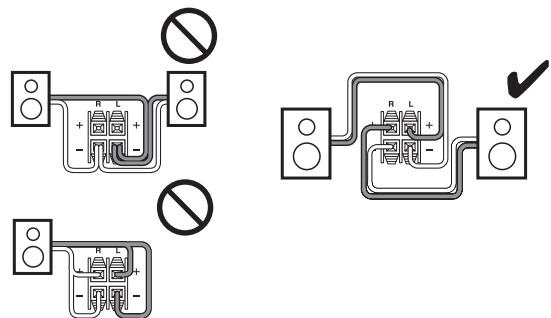

To connect the speaker cables:

- 1 Strip 1/2" to 5/8" (12 to 15 mm) of insulation from the ends of the speaker cables, and twist the bare wires tightly.
- 2 Push in on the speaker terminals on the receiver and insert the speaker wires into the terminals. The following illustration shows which speaker should be connected to each pair of terminals.
- 3 Release the terminals to secure the wire.
- 4 Press and hold the push-terminals on each speaker and insert the speaker wire, then release the push-terminal to secure the wire (black wires go to the negative (-) terminals).

To connect the subwoofer:

- Using the subwoofer RCA cable, connect the AV receiver's **SUBWOOFER PRE OUT** jack to the input on your powered subwoofer, as shown.

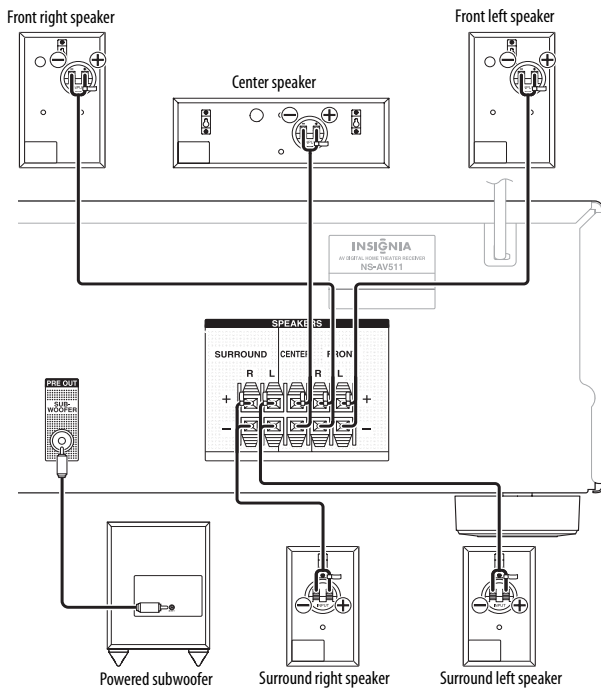

FM Antenna connection

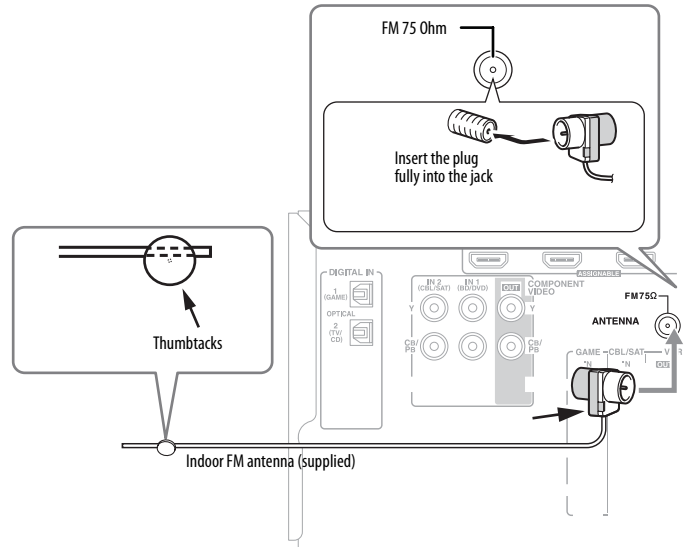

To connect the antennas:

- Connect the FM antenna to your receiver.

Note

If you are using an indoor FM antenna, change the position of the antenna until you get the best reception of your favorite FM stations. To improve reception, use a 75 Ω outdoor antenna instead of an indoor antenna. Disconnect the indoor antenna before replacing it with an outdoor antenna.

Tip

Once your receiver is ready for use, you need to tune into a radio station and position the antenna to achieve the best possible reception. If you cannot achieve good reception with the supplied indoor FM antenna, try a commercially available outdoor FM antenna instead.

- Connect the AM loop antenna to the receiver.

Notes

Place the AM loop antenna as far as possible from the receiver, television, speaker cords, and the AC cord. Change the position of the antenna until you get the best reception of your favorite AM stations. To improve reception, use an outdoor AM antenna instead of a loop AM antenna. Disconnect the indoor antenna before replacing it with an outdoor antenna.

Connecting devices

Warning

Do not plug the AC cord into the AC outlet until all connections are completed.

Notes

- Be sure to observe the color coding when connecting audio and speaker cords.
- Make connections firmly and correctly. Failure to do this can cause loss of sound, add noise to the sound, or damage your receiver.

Connecting the antenna

This section explains how to connect the supplied indoor FM antenna and AM loop antenna. The receiver won't pick up any radio signals without any antenna connected, so you must connect the antenna to use the tuner.

AM Antenna connection

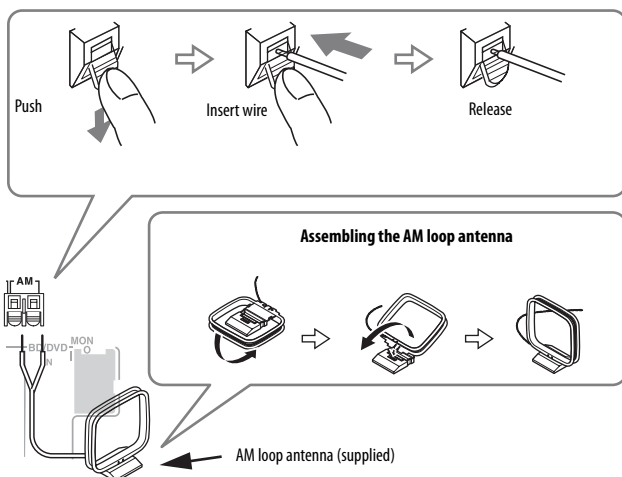

Connecting audio components

HDMI cable

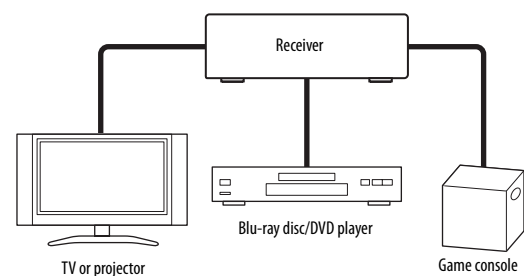

Other cables

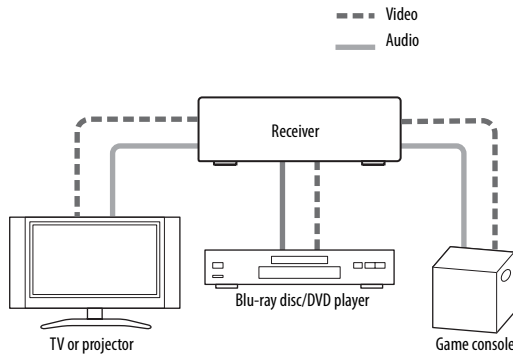

Notes

- Before making any AV connections, read the manuals supplied with your AV components.
- Don't connect the power cord until you've completed and double-checked all AV connections.
- Push plugs in all the way to make good connections (loose connections can cause noise or malfunctions).
- To prevent interference, keep audio and video cables away from power cords and speaker cables.

AV cables and jacks

Signal	Cable	Jack	Description
Video and audio	HDMI	HDMI	HDMI connections can carry digital video and audio.
Video	Component video	Y Pb Pr	Green Blue Red
Video	Composite video	Y	Yellow
Audio	Optical digital audio	OPTICAL	Optical digital connections allow you to enjoy digital sound such as PCM or Dolby Digital. The audio quality is the same as coaxial. Note: The available sampling rate for PCM input signals is 32/44.1/48/88.2/96 kHz. Even 176.4/192 kHz is effective in case of the HDMI connection.
Audio	Coaxial digital audio	DIGITAL	Coaxial digital connections allow you to enjoy digital sound such as PCM or Dolby Digital. The audio quality is the same as optical. Note: The available sampling rate for PCM input signals is 32/44.1/48/88.2/96 kHz. Even 176.4/192 kHz is effective in case of the HDMI connection.
Audio	Analog audio (RCA)	L R	White Red

Notes

The AV receiver's optical digital jacks have shutter-type covers that open when an optical plug is inserted and close when it's removed. Push plugs in all the way.

Caution

To prevent shutter damage, hold the optical plug straight when inserting and removing.

Deciding which connections to use

The receiver supports several connection formats for compatibility with a wide range of AV equipment. The format you choose depends on the formats supported by your components. Use the following sections as a guide.

Notes

- The on-screen setup menus appear only on a TV that is connected to the HDMI OUT. If your TV is connected to the MONITOR OUT V or the COMPONENT VIDEO OUT, use the receiver's display when changing settings.
- The on-screen setup menus are displayed when there is no video input, or the video input is 480p, 720p, 1080i, or 1080p.

Video connection formats

Video components can be connected by using any one of the following video connection formats (shown best first): HDMI, component video, or composite video.

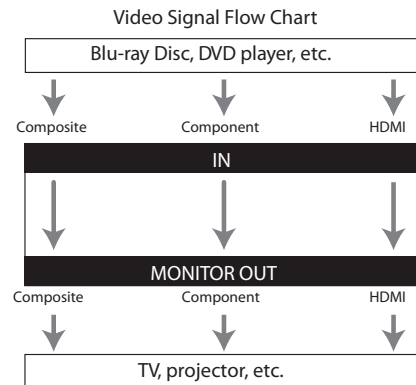

When choosing a connection format, bear in mind that the receiver does not convert between formats, so only outputs of the same format as the input will output the signal.

Audio connection formats

Audio components can be connected by using any of the following audio connection formats (shown best first):

- HDMI
- Optical
- Coaxial
- Analog

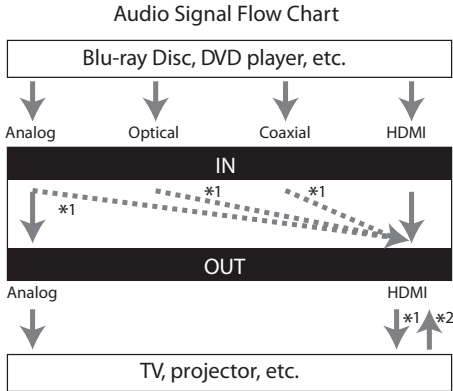

*1 - Depends on the Audio TV Out setting.
 *2 - This setting is available when the Audio Return Ch setting is set to Auto. You must select the TV/CD input selector and your TV must support the ARC function.

When choosing a connection format, note that the receiver does not convert digital input signals for analog line outputs and vice versa. For example, audio signals connected to an optical or coaxial digital input are not output by the analog VCR/DVR OUT.

If signals are present at more than one input, the inputs are selected automatically in the following order of priority:

- HDMI
- Digital
- Analog

Connecting components with HDMI

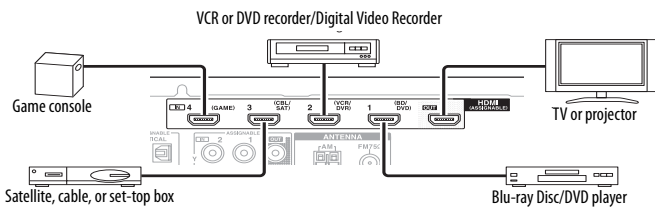

Connect your components to the appropriate jacks. The default input assignments are shown below. To change assignments, see "Setting up HDMI input (HDMI Input menu)" on page 22.

Jack	Signal	Components	Assignable	
Input	HDMI IN 1	Audio/Video	Blu-ray disc/DVD player	X
	HDMI IN 2		VCR/DVR or DVR	X
	HDMI IN 3		Satellite, cable, set-top box	X
	HDMI IN 4		Game console	X
Output	HDMI OUT		TV or projector	

Tip

To listen to audio received by the HDMI IN jacks through your TV's speakers:

- Set the **TV Control** setting to **On** for a CEC-compatible TV.
- Set the **Audio TV OUT** setting to **On** when the TV is not compatible with CEC or the **TV Control** setting is **Off**.
- Set your Blu-ray Disc/DVD player's HDMI audio output setting to **PCM**.
- To listen to TV audio through the receiver, see "Connecting external components" on page 10.

Using the audio return channel (ARC) function

The audio return channel (ARC) function lets an HDMI-capable TV send the audio stream to the receiver's HDMI OUT jack. To use this function, you must select the TV/CD input selector and your TV must support the ARC function.

Connecting external components

Note

The on-screen setup menus appear only on a TV that is connected to the **HDMI OUT** jack. If your TV is connected to the **MONITOR OUT V** jack or the **COMPONENT VIDEO OUT** jack, use the receiver's display when changing settings.

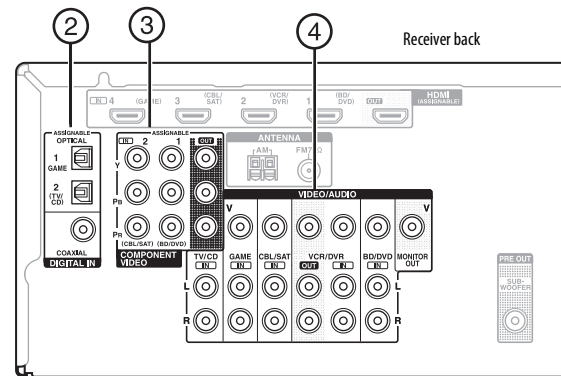
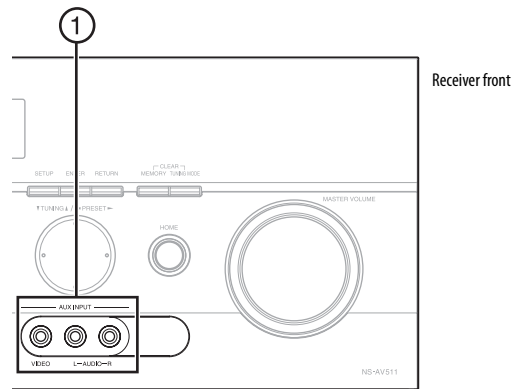

Connect your components to the appropriate jacks. The default input assignments are shown below. To change assignments, see "Setting up Component input (Component menu)" on page 22.

No.	Jack	Signal	Components	Assign.	
1	AUX INPUT	VIDEO	Composite video		
2	DIGITAL IN	AUDIO L/R	Analog audio		
		OPTICAL IN 1 (GAME)	Digital audio	Game console	X
		IN 2 (TV/CD)		TV or CD player	X

No.	Jack	Signal	Components	Assign.
3	COAXIAL IN 1 (BD/DVD)		Blu-ray disc/DVD player	X
	COMPONENT VIDEO IN 1 (BD/DVD)	Component video	Blu-ray disc/DVD player	X
	IN 2 (CBL/SAT)		Satellite, cable, set-top box	X
4	MONITOR OUT	OUT	TV or projector	
		Composite video	TV or projector	
	BD/DVD IN	Analog audio and composite video	Blu-ray disc/DVD player	
	VCR/DVR IN		VCR or DVD recorder/Digital Video recorder	
	CBL/SAT IN		Satellite, cable, set-top box	
	GAME IN		Game console	
	TV/CD IN	Analog audio	TV, CD player, turntable*, cassette tape player, MD, CD-R	

* Connect to a turntable (MM) that has a phono preamp built-in. If your turntable (MM) does not have a built-in preamp, you will need a commercially available phono preamp. If your turntable has a moving coil (MC) type cartridge, you will need a commercially available MC head amp or MC transformer as well as a phono preamp. See your turntable's manual for details.

Notes

- The receiver can output audio and video signals from the **AUX INPUT** jacks to the **VCR/DVR OUT** jacks.
- With connection 2, you can enjoy Dolby Digital and DTS.
- With connection 4, if your Blu-ray Disc/DVD player has both main stereo and multichannel outputs, be sure to connect the main stereo.
- With the connections described above, you cannot record the video through the receiver. To make a connection for video recording, see the following section.

Notes

- The AV receiver must be turned on for recording. Recording is not possible while it's in Standby mode.
- If you want to record directly from your TV or playback VCR to the recording VCR without going through the AV receiver, connect the TV/VCR's audio and video outputs directly to the recording VCR's audio and video inputs. See the manuals supplied with your TV and VCR for details.
- Video signals connected to composite video inputs can be recorded only via composite video outputs. If your TV/VCR is connected to a composite video input, the recording VCR must be connected to a composite video output.
- The surround sound and DSP listening modes cannot be recorded.
- Copy-protected Blu-ray discs and DVDs cannot be recorded.
- Sources connected to a digital input cannot be recorded. Only analog inputs can be recorded.
- DTS signals will be recorded as noise, so don't attempt analog recording of DTS CDs or LDs.

Connecting recording components

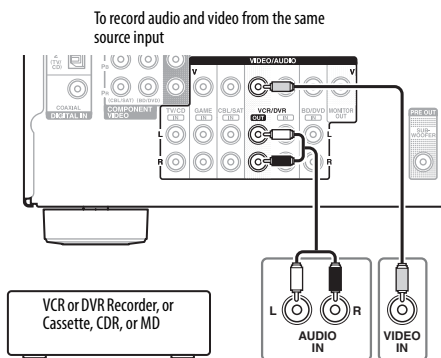

Connecting the power

To connect your receiver to power:

- Plug the power cord into an AC outlet.

Using rubber feet/pads for more stable speakers

We recommend using the rubber feet (provided) to achieve the best possible sound from your speakers. The rubber feet prevent the speakers from moving, providing a more stable platform.

Wall mounting your speakers

The speakers can easily be wall mounted by using the keyhole slots. To mount the front or surround speakers vertically, use the keyhole slot shown to hang each speaker on a screw that is securely screwed into the wall.

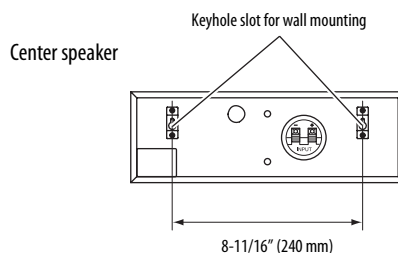
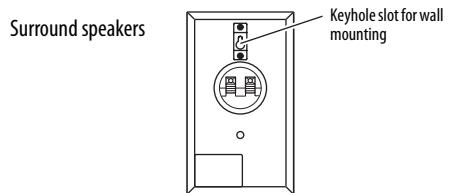
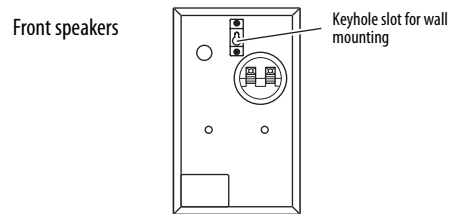

To mount the center speaker horizontally, use the two keyhole slots shown to hang each speaker on two screws that are securely screwed into the wall.

Cautions

- A mounting screw's ability to support a speaker depends on how well it's anchored to the wall. If you have hollow walls, screw each mounting screw into a stud. If there are no studs, or the walls are solid, use suitable wall anchors.
- Use screws with a head diameter of 5/16" (9 mm) or less and a shank diameter of 1/8" (4 mm) or less. With hollow walls, use a cable/pipe detector to check for any power cables or water pipes before making any holes.
- Leave a gap of between 3/16" (5 mm) and 7/16" (10 mm) between the wall and the base of the screw head. (We recommend that you consult a home installation professional.)

AV Recording

Audio sources can be recorded to a recorder (such as a cassette deck, CD-R, MD [MiniDisc]) connected to the **VCR OUT** jacks. Video sources can be recorded to a video recorder (such as a VCR or DVD recorder) connected to the **VCR/DVR Out** jack.

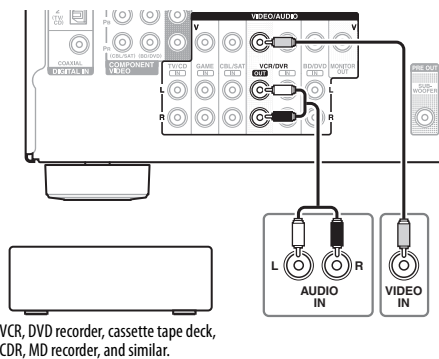

To record an audio source:

- 1 Use the input selector buttons to select the source that you want to record. You can watch the source while recording. The receiver's **MASTER VOLUME** control has no effect on recording.
- 2 Start recording on your recorder.
- 3 On the source component, start playback. If you select another input source during recording, that input source is recorded.

Recording Separate AV Sources

You can record audio and video from completely separate sources, allowing you to overdub audio onto your video recordings. This function takes advantage of the fact that when an audio-only input source (TV/CD) is selected, the video input source remains unchanged.

In the following example, audio from the CD player connected to the **TV/CD IN** jack and video from the camcorder connected to the **AUX INPUT VIDEO** jack are recorded by the VCR connected to the **VCR/DVR OUT** jacks.

To record the audio from one source input and the video from another source input

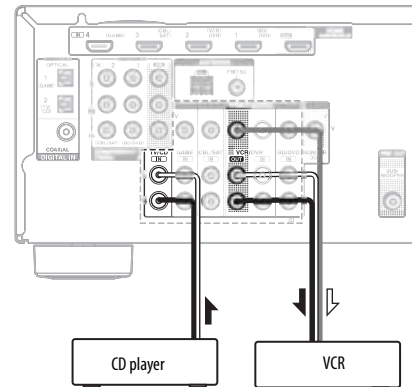
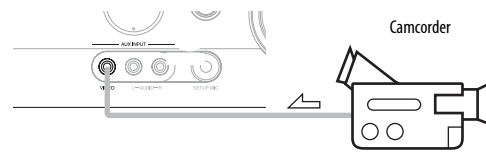

↔ : Video signal
 ↕ : Audio signal

To record separate AV sources:

- 1 Prepare the camcorder and CD player for playback and the VCR for recording.
- 2 Press the **AUX** input selector.
- 3 Press the **TV/CD** input selector. This selects the CD player as the audio source, but leaves the camcorder as the video source.
- 4 Start recording on the VCR and start playback on the camcorder and CD player. The video from the camcorder and the audio from the CD player are recorded by the VCR.

Rocketboost Setup

Rocketboost™ is expandable wireless digital audio.

- Products with Rocketboost™ technology let you easily expand your listening experience throughout your home.
- Rocketboost™ does not interfere with other wireless products in your home.
- Rocketboost™ is uncompressed digital audio compatible with all audio formats like Dolby TrueHD and DTS-HD Master Audio used with Blu-ray.



When you see the Rocketboost logo on any product, it has been designed to work with other Rocketboost products, no matter who manufactures them.

How can I use Rocketboost™ with my Surround Sound Receiver?

A Rocketboost Wireless Card (RF-RBCARD - sold separately) can be used to receive any Rocketboost audio stream from your other Rocketboost products. For example, you can play music from audio sources that are in other rooms. Plus, the RF-RBCARD can be used to send audio from the NS-AV511. For example, you can connect your rear surround sound speakers, or even subwoofer, by using Rocketboost wireless instead of wires. You can even send the front left/right speaker audio signals to Rocketboost receivers in other rooms of your house. Both send and receive functions require additional Rocketboost products. You can learn more about Rocketboost products at www.rocketboost.com.

Typical Rocketboost applications

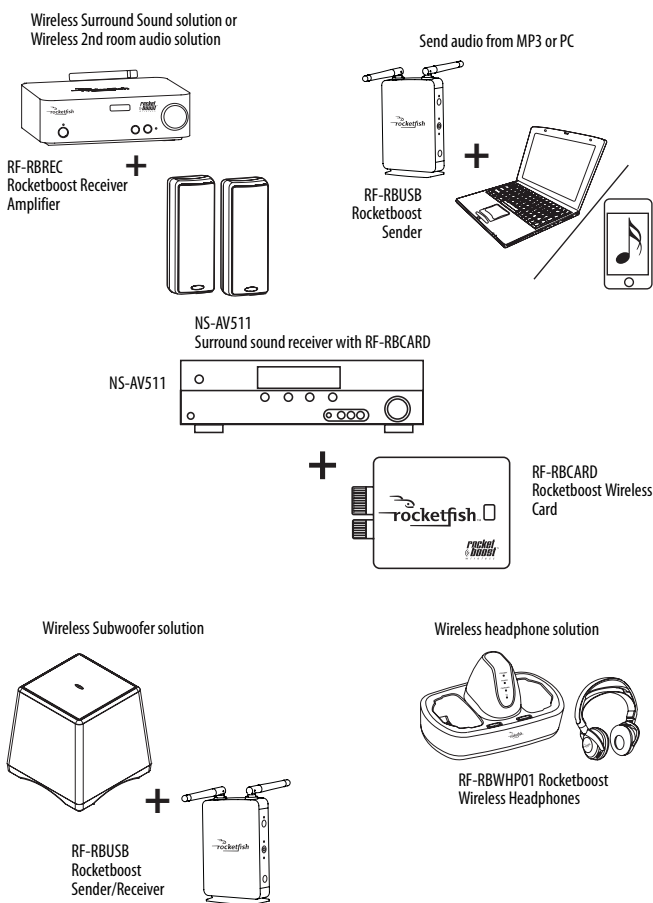

Initial Rocketboost setup

Insert the RF-RBCARD into the Rocketboost Module Slot on the top of NS-AV511 receiver.

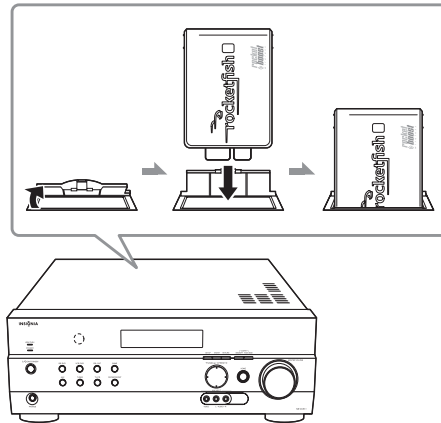

Setting up your surround sound receiver to send audio to other Rocketboost receivers

Note

This is only required if you are using Rocketboost™ for your wireless surround sound, wireless subwoofer, or if you are sending the front left/right speaker audio signals to Rocketboost receivers in other rooms of your house.

To set up your surround sound receiver to send audio to other Rocketboost receivers:

- 1 Press **SETUP**. The *Setup Menu* opens.

Setup Menu

1. HDMI Input
2. Component
3. Digital Audio
4. Sp Config
5. Sp Distance
6. Level Cal
7. Audio Adjust
8. Source Setup
9. Hardware
10. HDMI Setup
11. Rocketboost

- 2 Press **▼** or **▲** to select **11. Rocketboost**, then press **ENTER**. The *Rocketboost* menu opens.

Rocketboost

Send Wireless Audio

Listen to Wireless Audio

Connect to Wireless Network

Hub (Manager) Enable

- 3 Press **▼** or **▲** to select **Send Wireless Audio**, then press **ENTER**. The *Send Audio* menu opens.

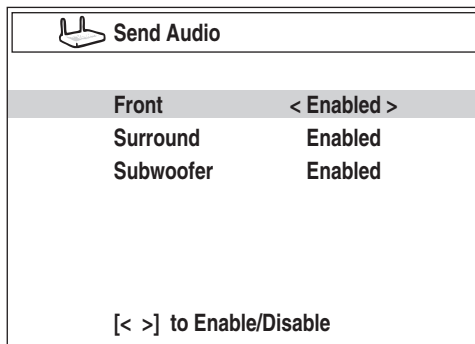

- 4 Press **▼** or **▲** to select the Sender you want (**Front**, **Surround**, or **Subwoofer**), then press **◀** or **▶** to **Enable** or **Disable** the selected sender.

Sender	Signal Status
Front Enabled	Front is ON
Front Disabled	Front is OFF
Surround Enabled	Surround signal is ON
Surround Disabled	Surround signal is OFF
Subwoofer Enabled	Subwoofer signal is ON
Subwoofer Disabled	Subwoofer signal is OFF

Note

- The Front sender should be enabled if you want to send the front left/right audio signals to other Rocketboost receivers (for example Rocketboost headphones or Rocketboost receiver products in other rooms of your house).
- We recommend that you do not enable channels that you will not be using.

Establishing communications with other Rocketboost devices

Note

Every Rocketboost™ network must contain a device called a *Hub*, which directs network data traffic and helps devices join the network. The network can have only one hub. If you are setting up your network for the first time, choose one of your Rocketboost™ senders to be your hub. If you already have a Rocketboost™ network, then set the **Hub (Manager)** setting to **Disable**.

To connect to a Rocketboost wireless network:

- 1 Press the **Power** button on your surround sound receiver to turn it on.
- 2 Press **SETUP**. The *Setup Menu* opens.

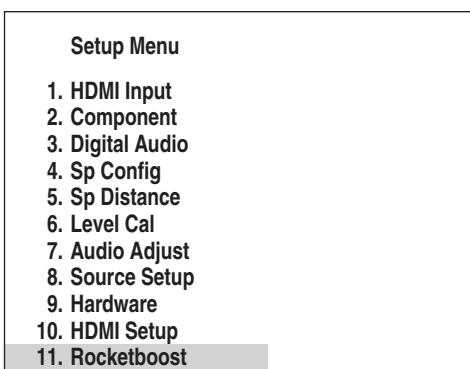

- 3 Press **▼** or **▲** to select **11. Rocketboost**, then press **ENTER**. The *Rocketboost* menu opens.

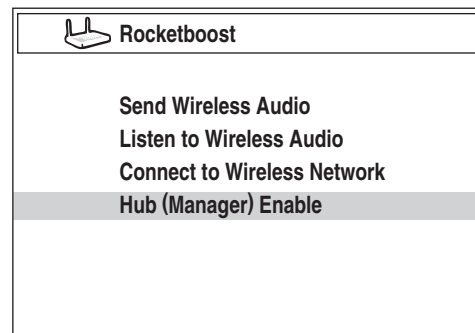

- 4 Press **▼** or **▲** to select **Hub (Manager)**, then press **ENTER**, then press **◀** or **▶** to select **Enable** or **Disable**.

If you are setting up your network for the first time, choose one of your Rocketboost senders to be your hub. If you want the surround sound receiver to be the hub then set the **Hub (Manager)** setting in this menu to **Enable**.

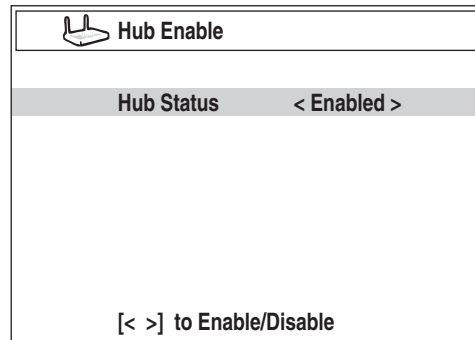

If you already have a Rocketboost network established, set the **Hub (Manager)** setting in this menu to **Disable**.

- 5 Press **RETURN** to go to the previous menu.

Note

Every new Rocketboost device you add to your Rocketboost network must be "joined" to your Rocketboost hub device. If the surround sound receiver is the Hub of your network then repeat the following steps for each of your Rocketboost devices on your network.

- 6 If possible, bring your existing Rocketboost Hub device, or the new Rocketboost device to which you'd like to join, into the same room as the soundbar.
- 7 Press the **Power** button on your other Rocketboost device to turn it on.
- 8 Press and hold the **Power** button on your other Rocketboost device for more than three seconds to put it into joining mode. The power indicator starts blinking rapidly and the unit will stay in joining mode for 30 seconds.
- 9 Press **▼** or **▲** to select **Connect to Wireless Network**, then press **ENTER**.
- 10 The display on your surround sound receiver shows "Connecting." When connected to your other Rocketboost device, the display shows "Connected."

- When successfully joined, the power indicator LED on your other Rocketboost device will stop blinking and stay on.
- If joining fails after 30 seconds, the display on your surround sound receiver shows "Timeout." If this occurs, repeat the above steps.

Listening to music from other Rocketboost™ products

To listen to music:

- 1 Press the **Power** button on your surround sound receiver to turn it on.
- 2 Press **SETUP**. The *Setup Menu* opens.

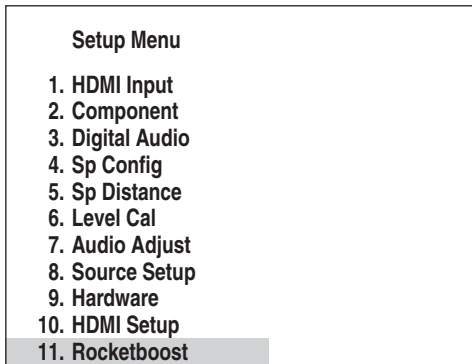

- 3 Press **▼** or **▲** to select **11. Rocketboost**, then press **ENTER**. The *Rocketboost* menu opens.

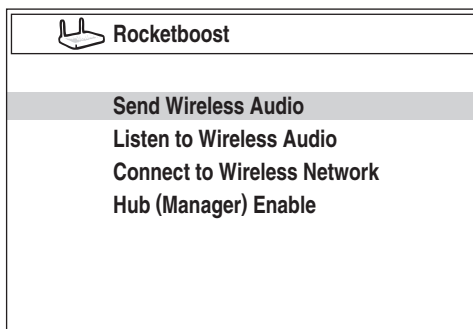

- 4 Press **▼** or **▲** to select **Listen to Wireless Audio**, then press **ENTER**. The *Listen to Audio* menu opens.

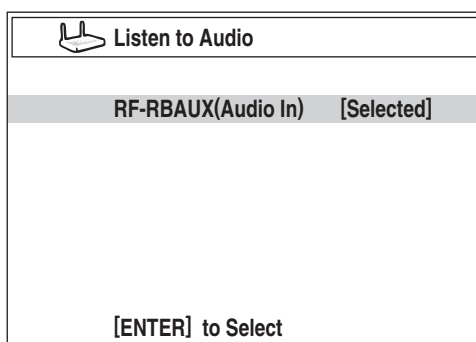

- 5 Press **▼** or **▲** to highlight the Rocketboost device you want to listen to, then press **ENTER** to select it.

Rocketboost Network Capabilities

The maximum number of Rocketboost devices in a Rocketboost Network is nine. If you already have nine and attempt to join an additional device, joining will fail for the new device.

Note

If you want to remove a device from your Rocketboost network you need to rejoin it to a different hub device (this basically creates a 2nd Rocketboost network).

The maximum number of audio streams that can be sent simultaneously on the Rocketboost network is five (stereo CD quality).

Installing batteries in the remote control

Cautions

- If the remote control doesn't work reliably, try replacing the batteries.
- Don't mix new and old batteries or different types of batteries.
- If you intend not to use the remote control for a long time, remove the batteries to prevent damage from leakage or corrosion.
- Remove expired batteries as soon as possible to prevent damage from leakage or corrosion.

To install the batteries:

- 1 Remove the cover.

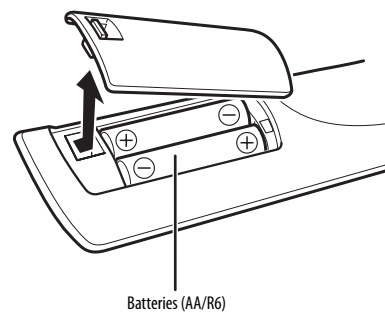

- 2 Insert two AA batteries into the compartment matching the polarity indicated.
- 3 Replace the cover.

Using the remote control

Use the remote control by pointing it towards the receiver's remote sensor window. Objects between the remote control and sensor window may prevent proper operation.

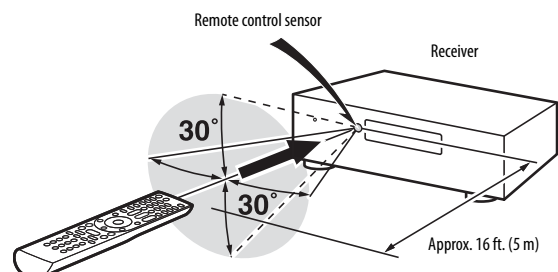

Use the remote control within about 16 feet (5 meters) of the receiver and within 30 degrees of perpendicular to the front of the receiver.

Cautions

- Do not expose the remote control to shock. In addition, do not expose the remote control to liquids, and do not place in an area with high humidity.
- Do not place the remote control under direct sunlight. The heat may cause deformation of the remote control.
- The remote control may not work properly if the remote sensor window of the receiver is under direct sunlight or strong lighting. In such a case, change the angle of the lighting or receiver, or operate the remote control closer to the remote sensor window.

Configuring speakers (*Sp Config* menu)

This section explains how to specify which speakers are connected and defines their sizes.

For speakers with a cone diameter larger than 6.5 inches (16 cm), specify **Large** (full band). For those with a smaller diameter, specify **Small** (default crossover 120 Hz).

The crossover frequency can be changed in the *Crossover* submenu.

See “Using on-screen setup menus” on page 22 for information on accessing and using the menus.

Note

Speaker Configuration, Crossover Frequency, and Double Bass settings are disabled while headphones are connected, or when **Audio TV OUT** is set to **On**.

Speaker(s)	Configuration
Subwoofer	Yes —If a subwoofer is connected. No —If no subwoofer is connected.
Front	Small —If speaker cone is 6.5 inches (16 cm) or less in diameter. Large —If speaker cone is larger than 6.5 inches (16 cm) in diameter. Note: If the Subwoofer setting is No , the default setting for this is Large and cannot be changed.
Center and Surround	Small —If speaker cone is 6.5 inches (16 cm) or less in diameter. Large —If speaker cone is larger than 6.5 inches (16 cm) in diameter. None —If no center speaker is connected. Note: If the Front setting is Small , the Large option cannot be selected.

Setting the crossover frequency (*Crossover Frequency* submenu of *Sp Config* menu)

This setting is recommended for the speakers that you specify as **Small**. To get the best bass performance from your speaker system, you need to set the crossover frequency according to the size and frequency response of your speakers. Options include **40Hz, 50Hz, 60Hz, 70Hz, 80Hz, 90Hz, 100Hz, 120Hz, 150Hz, and 200Hz**.

Use the diameter of the smallest speaker in your system when choosing the crossover frequency.

See “Using on-screen setup menus” on page 22 for information on accessing and using the menus.

Speaker cone diameter	Recommended Crossover Frequency
Over 8 in. (20 cm)	40/50/60 Hz
6-1/2 to 8 in. (16 to 20 cm)	70 Hz, 80 Hz, 90 Hz
5-1/4 to 6-1/2 in. (13 to 16 cm)	100 Hz
3-1/2 to 5-1/4 in. (9 to 13 cm)	120 Hz
Under 3-1/2 in. (9 cm)	150/200 Hz

Notes

- For a more accurate setting, look up your speaker's specifications.
- Choose a higher crossover frequency if you want more sound from your subwoofer.

Using the Double Bass setting (*Double Bass* submenu of *Sp Config* menu)

Lets you boost bass output by feeding bass sounds from the front left, right, and center channels to the subwoofer. Optional settings are **On** and **Off**.

Note

This function can only be set if the **Subwoofer** setting is **Yes**, and the **Front** setting is **Large**.

Setting wireless (*This setting appears only when RF-RBCARD is inserted*)

This menu is used if you are connecting your home theater front left/right, surround, or subwoofer channels using Rocketboost wireless (see “Rocketboost Setup” on page 12 for more details about Rocketboost).

The **On** menu option results in the wired and wireless channels in your home theater to be synchronized in time.

If any of these channels in your home theater are connected with Rocketboost wireless, then set those channels to **On**. For example, if you are using Rocketboost for wireless surround sound and wireless subwoofer in your home theater, then set **Wireless Sur** and **Wireless SW** to **On**.

If you are using Rocketboost Wireless to send the front left/right speaker audio signals to Rocketboost receivers in other rooms of your house, and not for your left/right home theater speakers, then set **Wireless Front** to **Off**.

Option	Configuration
Wireless Front	On or Off
Wireless Sur	On or Off
Wireless SW	On or Off

Setting speaker distance (*Sp Distance* menu)

Lets you specify the distance from each speaker to the listening position so that the sound from each speaker arrives at the listener's ears as the sound designer intended.

See "Using on-screen setup menus" on page 22 for information on accessing and using the menus.

Option	Configuration
Unit	Feet (default) —Distances can be set from 1 to 30 feet, in one foot increments. Meters —Distances can be set from 0.3 to 9.0 meters, in 0.3 meter increments.
Left, Center, Right, Surround Right, Surround Left, Subwoofer	Specify the distance from each speaker to your listening position.

Notes
<ul style="list-style-type: none"> The speaker distance setting is disabled while headphones are connected, or when Audio TV OUT is set to On. Speakers that you set to No or None in the speaker configuration (<i>Sp Config</i> menu) cannot be selected. The Center, Right, and Subwoofer distances can be set up to 5 ft. (1.5 m) more or less than the Left distance. For example, if the Left distance is set to 20 ft. (6 m), the Center, Right, and Subwoofer distances can be set between 15 and 25 ft. (4.5 and 7.5 m). The Surround distances can be set up to 5 ft. (1.5 m) more or 15 ft. (4.5 m) less than the Left distance. For example, if the Left distance is set to 20 ft. (6 m), the SurrRight and SurrLeft distances can be set between 5 and 25 ft. (1.5 and 7.5 m).

Setting the level calibration (*Level Cal* menu)

Lets you adjust the level of each speaker with the built-in test tone so that the volume of each speaker is the same at the listening position. See "Using on-screen setup menus" on page 22 for information on accessing and using the menus.

Option	Configuration
Left, Center, Right, Surround Right, Surround Left	-12 dB to 0 dB to +12 dB, in 1 dB steps.
Subwoofer	-15 dB to 0 dB to +12 dB, in 1 dB steps.

Notes
<ul style="list-style-type: none"> The speaker level setting is disabled while headphones are connected, or the receiver is muted, or the Audio TV OUT setting is set to ON. Speakers that you set to No or None in the speaker configuration (<i>Sp Config</i> menu) cannot be selected. The center speaker and subwoofer level settings made by using AUDIO are saved here as the default settings.

Tip
If you're using a handheld sound level meter, adjust the level of each speaker so that it reads 75 dB SPL at the listening position, measured with C-weighting and slow reading.

Operating your receiver

Turning your receiver on and off

To turn your receiver on and off:

- Press **ON/STANDBY** on the front panel.
- OR -
Press **RECEIVER**, then **ON/STANDBY** on the remote control.
The receiver turns on, the display lights, and the **STANDBY** indicator turns off.
- Press **ON/STANDBY** on the remote control again. The receiver enters standby mode.
To prevent any loud surprises when you turn on the receiver, always turn down the volume before you turn it off.

Understanding basic operations

Notes
<ul style="list-style-type: none"> The on-screen setup menus appear only on a TV that is connected to the HDMI OUT jack. If your TV is connected to the MONITOR OUT V or the COMPONENT VIDEO OUT jacks, use the receiver's display when changing settings. This manual describes the procedure using the remote control unless otherwise specified.

Playing a connected component

To play a connected component:

- Press **RECEIVER**, then press **INPUT SELECTOR** buttons to select the input source.
- Start playback on the source component.
- To adjust the volume, use the **MASTER VOLUME** control.
- Select a listening mode and enjoy!
See also "Using the listening modes" on page 19.

Displaying source information

To display source information:

- Press **RECEIVER**, then press **DISPLAY** repeatedly to cycle through the available information.

The following information can typically be displayed:

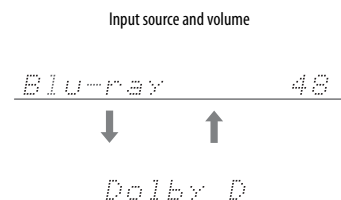

Notes

- When AM or FM radio is used, the band, preset number, and frequency are displayed.
- If the input signal is analog, no format information is displayed. If the input signal is PCM, the sampling frequency is displayed. If the input signal is digital but not PCM, the signal format is displayed. Information is displayed for about three seconds, then the previously displayed information reappears.
- The input source is displayed with the default name even when you have selected a name. See "Setting up HDMI (HDMI Setup menu)" on page 24.

Using the music optimizer

The music optimizer enhances the sound quality of compressed music files.

To use the music optimizer:

- 1 Press **AUDIO**, then press **▲** or **▼** to select **M.Optimizer**.
- 2 Press **◀** or **▶** to select **On**.

The **M.Opt** indicator lights on the display.

Notes

- The music optimizer function only works with PCM digital audio input signals with a sampling rate below 48 kHz and analog audio input signals. The music optimizer is disabled when the direct listening mode is selected.
- The setting is stored individually for each input selector.

Setting the display brightness

You can adjust the brightness of the receiver's display.

To set the display brightness:

- Press **RECEIVER**, then press **DIMMER** repeatedly to select: **Dim**, **Dimmer**, or **Normal** brightness.

Muting the receiver

To mute the receiver:

- Press **RECEIVER**, then press **MUTING**.

The output is muted and the **MUTING** indicator flashes on the display.

Tip

- To unmute, press **MUTING** again or adjust the volume.
- Muting is also cancelled when the receiver is set to Standby.

Using the sleep timer

With the sleep timer, you can set the receiver to turn off automatically after a specified period.

To use the sleep timer:

- Press **RECEIVER**, then press **SLEEP** repeatedly to select the sleep time you want.

The sleep time can be set from 90 to 10 minutes, in 10 minute steps.

The **SLEEP** indicator lights on the display when the sleep timer has been set. The specified sleep time appears on the display for about five seconds, then the previous display reappears.

Tip

- To cancel the sleep timer, press **SLEEP** repeatedly until the **SLEEP** indicator goes off.
- To check the time remaining until the receiver turns off, press **SLEEP**. If you press **SLEEP** while the sleep time is being displayed, the sleep time is shortened by 10 minutes.

Using headphones

To use headphones:

- Connect a pair of stereo headphones with a standard plug (1/4 in. or 6.3 mm) to the **PHONES** jack.

Tip

- Always turn down the volume before connecting your headphones.
- While the headphones plug is inserted in the **PHONES** jack, the speakers are turned off.
- When you connect a pair of headphones, the listening mode is set to Stereo, unless it is already set to Stereo, Mono, or Direct.
- The listening modes cannot be selected while a pair of headphones is connected.

Listening to your receiver

Important

The procedures described in this section use the buttons on the front panel, unless otherwise specified.

Listening to the radio

With the built-in tuner you can enjoy AM and FM radio stations. You can store your favorite stations as presets for quick selection.

To listen to the radio:

- Press **TUNER** to select either **AM** or **FM** (each time you press **TUNER**, the radio band changes between AM and FM).

In this example, **FM** has been selected.

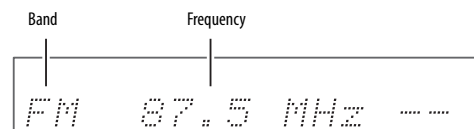

- To automatically tune to a station:
 - Press **TUNING MODE** until the **AUTO** indicator appears on the display.
 - Press **TUNING ▲** or **▼**. The receiver automatically searches for stations and stops when a station is found.

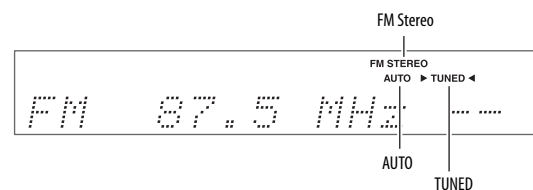

Tip

You can also press the **TUNE MODE** and arrow buttons on the remote control.

- OR -

- To manually tune to a station:
 - Press **TUNING MODE** until the AUTO indicator goes off.
 - Press and hold **TUNING ▲** or **▼**. The receiver tunes up or down the frequency band as long as you hold the button. Press the button repeatedly to tune up or down by steps.

Tip

- In Manual Tuning mode, FM stations are in mono.
- If the signal from a stereo FM station is weak, it may be impossible to get good reception. In this case, switch to Manual Tuning mode and listen to the station in mono.
- You can also press the **TUN MODE** and arrow buttons on the remote control.

- OR -

- To tune to a station by entering the frequency:
 - Using the remote control, press **TUNER** repeatedly to select **AM** or **FM**, then press **D.TUN**.

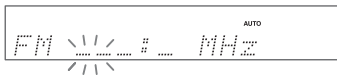

- Within eight seconds, press the number buttons to enter the frequency of the radio station you want. For example, to tune to 87.50, press **8**, **7**, then **5**.

Presetting FM or AM stations

You can store a combination of as many as 40 of your favorite AM or FM stations as presets.

To store a station as a preset:

- Tune to the FM or AM station that you want to store as a preset. See "Listening to the radio" on page 18 for information on tuning your receiver.
- Press **MEMORY**. The preset number flashes.
- While the preset number is flashing (about eight seconds), press **PRESET ◀** or **▶** to select a preset number from one through 40.
- Press **MEMORY** again to store the station or channel. The station or channel is stored and the preset number stops flashing.
- Repeat steps 1 through 4 to preset your favorite radio stations.

Tuning to a preset station

To tune to a preset station:

- To select a preset, press **PRESET ◀** or **▶** on the receiver, or press **CH +/-** on the remote control.

Tip

You can also press the number buttons on the remote control to select a preset station directly.

Deleting preset stations

To delete a preset station:

- Select the preset you want to delete.
- Press **TUNING MODE** while pressing and holding **MEMORY**. The preset is deleted and its number disappears from the display.

Using the listening modes

Notes

- You can only select the Dolby Digital and DTS listening modes if your Blu-ray Disc/DVD player is connected to the receiver with a digital audio connection (coaxial, optical, or HDMI).
- The listening mode you can select depends on the format of the input signal. To check the format, see "Displaying source information" on page 17.
- You can only select **Mono**, **Direct**, and **Stereo** listening modes with a pair of headphones is connected.
- Listening modes cannot be selected while a pair of headphones is connected.

The receiver's listening modes can transform your listening room into a movie theater or concert hall, with high fidelity and stunning surround sound.

The following audio formats are supported by the listening modes:

- MONO**—This is mono (monophonic) sound. All the audio signals are mixed and reproduced through a single speaker.
- STEREO**—This is stereo (stereophonic) sound. Two independent audio signal channels are reproduced through two speakers.
- 5.1ch**—This is 5.1-channel surround sound. This receiver has five main channels of sound and a sixth subwoofer channel (called the point-one channel).
- 7.1ch**—This is 7.1-channel surround sound. This is a further sound enhancement to 5.1 channel sound with two additional speakers that provide greater sound envelopment and more accurate positioning of sounds. The receiver outputs this source in 5.1-channel surround sound.

Selecting a listening mode

To select a listening mode:

- Press one of the following buttons. If you are using the remote control, press the **RECEIVER** button first. See "Listening modes" on page 20, and "Insignia-Original Listening Modes" on page 21 for information on listening modes.
 - MOVIE/TV**—This button selects the listening modes intended for use with movies and TV.
 - MUSIC**—This button selects the listening modes intended for use with music.
 - GAME**—This button selects the listening modes intended for use with video games.
 - STEREO**—This button selects the Stereo listening mode and All Channel Stereo listening mode.

Listening modes

These listening modes become available when one of the buttons described in “Selecting a listening mode” on page 19 are pushed. The optional modes available depend on which button is pushed.

Listening Mode	Description	Input Source	Speaker Layout
Direct (Direct)	In this mode, audio from the input source is output without surround-sound processing. The “Sp Config (Speaker Configuration)” (presence of speakers), “Sp Distance (Speaker Distance)” and “A/V Sync (A/V Sync)” settings are enabled, but much of the processing set via AUDIO is disabled. See “Using advanced setup” on page 22 for more details.	MONO STEREO 5.1ch 7.1ch	2.1, 3.1, 5.1
Stereo (Stereo)	Sound is output by the front left and right speakers and subwoofer.	MONO STEREO 5.1ch 7.1ch	2.1, 3.1, 5.1
Mono (Mono)	Use this mode when watching an old movie with a mono soundtrack, or use it with the foreign language soundtracks recorded in the left and right channels of some movies. It can also be used with DVDs or other sources containing multiplexed audio, such as karaoke DVDs.	MONO STEREO 5.1ch 7.1ch	2.1, 3.1, 5.1
Multichannel (Multich)	This mode is for use with PCM multichannel sources.	5.1ch 7.1ch	3.1, 5.1
Dolby Pro Logic II (PL II Movie) (PL II Music) (PL II Game)	Dolby Pro Logic II expands any 2-channel source for 5.1-channel playback. It provides a very natural and seamless surround-sound experience that fully envelops the listener. As well as music and movies, video games can also benefit from the dramatic spatial effects and vivid imaging. <ul style="list-style-type: none"> Dolby PLII Movie—Use this mode with DVDs and videos that bear the Dolby Surround logo or TV shows that feature Dolby Surround. You can also use this mode with stereo movies or TV shows and the receiver creates a 5.1 surround mix from the 2-channel stereo. Dolby PLII Music—Use this mode to add 5.1 surround to stereo sources such as music CDs and DVDs. Dolby PLII Game—Use this mode when playing game discs. 	STEREO	3.1, 5.1
Dolby Digital (Dolby D)	In this mode, audio from the input source is output without surround-sound processing. Sp Config (Speaker Configuration), (presence of speakers), Crossover (Crossover Frequency), Sp Distance (Speaker Distance), A/V Sync (A/V Sync), and much of the processing set via AUDIO are enabled. See “Using advanced setup” on page 22.	5.1ch	3.1, 5.1
Dolby Digital Plus¹ (Dolby D+)	In this mode, audio from the input source is output without surround-sound processing. Sp Config (Speaker Configuration), (presence of speakers), Crossover (Crossover Frequency), Sp Distance (Speaker Distance), A/V Sync (A/V Sync), and much of the processing set via AUDIO are enabled. See “Using advanced setup” on page 22.	5.1ch 7.1ch	3.1, 5.1
Dolby TrueHD (Dolby TrueHD)	In this mode, audio from the input source is output without surround-sound processing. Sp Config (Speaker Configuration), (presence of speakers), Crossover (Crossover Frequency), Sp Distance (Speaker Distance), A/V Sync (A/V Sync), and much of the processing set via AUDIO are enabled. See “Using advanced setup” on page 22.	5.1ch 7.1ch	3.1, 5.1
DTS (DTS)	In this mode, audio from the input source is output without surround-sound processing. Sp Config (Speaker Configuration), (presence of speakers), Crossover (Crossover Frequency), Sp Distance (Speaker Distance), A/V Sync (A/V Sync), and much of the processing set via AUDIO are enabled. See “Using advanced setup” on page 22.	5.1ch	3.1, 5.1
DTS-HD High Resolution Audio (DTS-HD HR)	In this mode, audio from the input source is output without surround-sound processing. Sp Config (Speaker Configuration), (presence of speakers), Crossover (Crossover Frequency), Sp Distance (Speaker Distance), A/V Sync (A/V Sync), and much of the processing set via AUDIO are enabled. See “Using advanced setup” on page 22.	5.1ch 7.1ch	3.1, 5.1
DTS-HD Master Audio (DTS-HD MSTR)	In this mode, audio from the input source is output without surround-sound processing. Sp Config (Speaker Configuration), (presence of speakers), Crossover (Crossover Frequency), Sp Distance (Speaker Distance), A/V Sync (A/V Sync), and much of the processing set via AUDIO are enabled. See “Using advanced setup” on page 22.	5.1ch 7.1ch	3.1, 5.1
DTS Express (DTS Express)	In this mode, audio from the input source is output without surround-sound processing. Sp Config (Speaker Configuration), (presence of speakers), Crossover (Crossover Frequency), Sp Distance (Speaker Distance), A/V Sync (A/V Sync), and much of the processing set via AUDIO are enabled. See “Using advanced setup” on page 22.	STEREO 5.1ch	3.1, 5.1
DSD² (DSD)	In this mode, audio from the input source is output without surround-sound processing. Sp Config (Speaker Configuration), (presence of speakers), Crossover (Crossover Frequency), Sp Distance (Speaker Distance), A/V Sync (A/V Sync), and much of the processing set via AUDIO are enabled. See “Using advanced setup” on page 22.	5.1ch	3.1, 5.1
DTS 96/24³ (DTS 96/24)	This mode is for use with DTS 96/24 sources. This is high-resolution DTS with a 96 kHz sampling rate and 24-bit resolution, providing superior fidelity. Use it with DVDs that bear the DTS 96/24 logo.	5.1ch	3.1, 5.1
DTS Neo:6 (Neo:6Cinema) (Neo:6Movie)	This mode expands any 2-channel source for up to 5.1-channel playback. It uses seven full-bandwidth channels of matrix decoding for matrix-encoded material, providing a very natural and seamless surround sound experience that fully envelops the listener. <ul style="list-style-type: none"> Neo:6 Cinema—Use this mode with any stereo movie (such as TV, DVD, VHS). Neo:6 Music—Use this mode with any stereo music source (such as CD, radio, cassette, TV, VHS, DVD). 	STEREO	3.1, 5.1

¹ Dolby Digital is used for Blu-ray discs.

² The receiver can use the DSD signal from HDMI IN. Setting the output on the player side to PCM might provide better sound to the player.

³ Depending on the input source, DTS is used.

Insignia-Original Listening Modes

Listening Mode	Description	Input Source	Speaker Layout
Orchestra (Orchestra)	Suitable for classical or operatic music, this mode emphasizes the surround channels in order to widen the stereo image, and simulates the natural reverberation of a large hall.	MONO STEREO 5.1ch	5.1
Unplugged (Unplugged)	Suitable for acoustic instruments, vocals, and jazz, this mode emphasizes the front stereo image, giving the impression of being right in front of the stage.	MONO STEREO 5.1ch	5.1
Studio-Mix (Studio-Mix)	Suitable for rock or pop music, listening to music in this mode creates a lively sound field with a powerful acoustic image, like being at a club or rock concert.	MONO STEREO 5.1ch	5.1
TV Logic (TV Logic)	This mode adds realistic acoustics to TV shows produced in a TV studio, surround effects to the entire sound, and clarity to voices.	MONO STEREO 5.1ch	5.1
Game-RPG (Game - RPG)	Use this mode when playing role playing game discs.	MONO STEREO 5.1ch	5.1
Game-Action (Game - Action)	Use this mode when playing action game discs.	MONO STEREO 5.1ch	5.1
Game-Rock (Game - Rock)	Use this mode when playing rock game discs.	MONO STEREO 5.1ch	5.1
Game-Sports (Game - Sports)	Use this mode when playing sports game discs.	MONO STEREO 5.1ch	5.1
All Ch Stereo (All Ch St)	Ideal for background music, this mode fills the entire listening area with stereo sound from the front, surround, and surround back speakers.	MONO STEREO 5.1ch 7.1ch	3.1, 5.1
Full Mono (Full Mono)	In this mode, all speakers output the same sound in mono, so the sound you hear is the same regardless of where you are within the listening room.	MONO STEREO 5.1ch 7.1ch	3.1, 5.1
T-D (Theater-Dimensional) (T-D)	With this mode you can enjoy a virtual surround sound even with only two or three speakers. This works by controlling how sounds reach the listener's left and right ears. Good results may not be possible if there is too much reverb, so we recommend that you use this mode in an environment with little or no natural reverb.	MONO STEREO 5.1ch 7.1ch	2.1, 3.1, 5.1

Speaker layout

The following shows the speakers that are activated in each type of configuration.

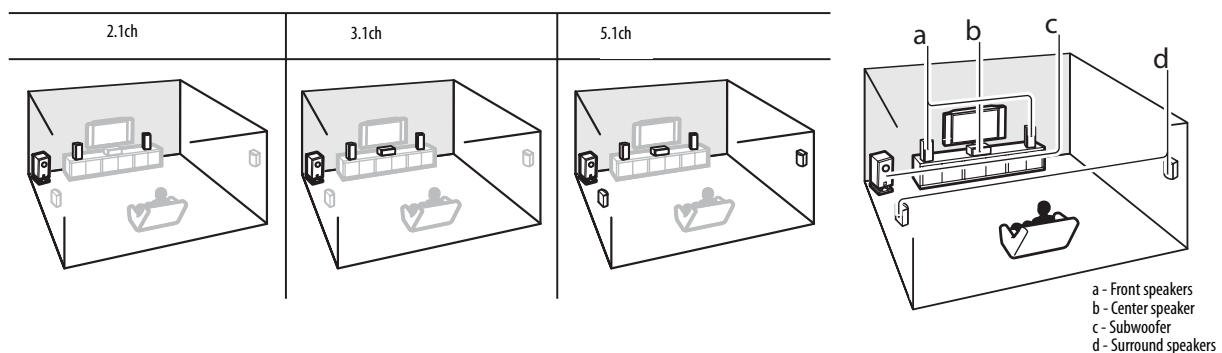

Using advanced setup

Using on-screen setup menus

On-screen setup menus appear on the connected TV and provide a convenient way to change the receiver's various settings. Settings are organized into nine categories on the main menu. You can change the settings by using the on-screen display.

To use the on-screen setup menus:

- 1 Press **RECEIVER**, then press **SETUP**. The *Setup* menu opens.

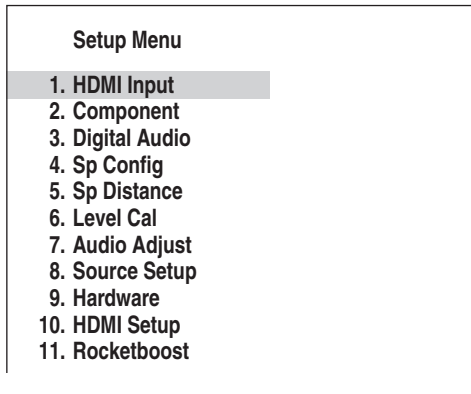

Tip

If the main menu doesn't appear, make sure the appropriate external input is selected on your TV.

- 2 Press **▲** or **▼** to select a menu, then press **ENTER**.
- 3 Press **▲** or **▼** to select an option, then press **◀** or **▶** to change the setting.
- 4 Press **SETUP** to close the menu.
- 5 Press **RETURN** to return to the main menu.

Tip

You can also performed these changes on the receiver by pressing **SETUP**, the arrow buttons, then **ENTER**.

Setting up HDMI input (*HDMI Input menu*)

If you connect a video component to HDMI inputs, you must assign that input to an input selector. For example, if you connect your Blu-ray Disc/DVD player to **HDMI IN 2**, you must assign **HDMI2** to the **BD/DVD** input selector.

Here are the default assignments:

Input selector	Default assignment
BD/DVD	HDMI1
VCR/DVR	HEMI 2
CBL/SAT	HDMI3
GAME	HDMI4
AUX	-----
TUNER	-----
TV/CD	-----

HDMI1, HDMI2, HDMI3, HDMI4—Select the HDMI input to which the video component has been connected.

-----Select if you're not using the **HDMI OUT**.

Each HDMI input can only be assigned to a single input selector. When HDMI1 - HDMI4 have already been assigned, you must first set unused input selectors to "-----," or you cannot assign HDMI1 - HDMI4 to an input selector.

Notes

- When an **HDMI IN** is assigned to an input selector as explained here, the digital audio input for that input selector is automatically set to the same **HDMI IN**.
- Do not assign the component connected with the HDMI input to a **TV/CD** selector when you set the TV Control setting to **On**. Otherwise, the appropriate CEC (Consumer Electronics Control) operation can not be guaranteed.

Setting up Component input (*Component menu*)

If you connect a video component to a component video input, you must assign that input to an input selector. For example, if you connect your Blu-ray Disc/DVD player to **COMPONENT VIDEO IN 2**, you must assign **IN2** to the **BD/DVD** input selector.

Here are the default assignments:

Input selector	Default assignment
BD/DVD	IN1
VCR/DVR	-----
CBL/SAT	IN2
GAME	-----
AUX	-----
TUNER	-----
TV/CD	-----

IN1, IN2—Select the component input to which the video component has been connected.

-----Select if you're not using the **COMPONENT VIDEO OUT**.

Setting up Digital Audio (*Digital Audio menu*)

If you connect a component to a digital audio input, you must assign that input to an input selector. For example, if you connect your CD player to the **OPTICAL IN 1**, you must assign **OPT1** to the **TV/CD** input selector.

Here are the default assignments:

Input selector	Default assignment
BD/DVD	COAX
VCR/DVR	-----
CBL/SAT	-----
GAME	OPT1
AUX	-----
TUNER	OPT2
TV/CD	-----

COAX, OPT1, OPT2—Select the digital audio input to which the video component has been connected.

-----Select if you are using an analog audio input.

Notes

- When an **HDMI IN** is assigned to an input selector as explained here, the digital audio input for that input selector is automatically set to the same **HDMI IN**. In addition to the usual inputs, such as **COAX**, you can also select HDMI inputs.
- The available sampling rate for PCM signals from a digital input (optical and coaxial) is 32/44.1/48/88.2/96 kHz/16, 20, 24 bit.

Adjusting the audio (Audio Adjust menu)

With the audio adjust settings you can adjust the sound and listening modes to your taste.

Setting the Multiplex (Input Ch(Mux) submenu) and Mono (Input Ch(Mono) submenu)

The **multiplex** setting determines which channel of a stereo multiplex source is output. Use it to select audio channels or languages with multiplex sources, multilingual TV broadcasts, and so on.

The **mono** setting specifies the channel to be used for playing any 2-channel digital source, such as Dolby Digital, or 2-channel analog/PCM source in the Mono listening mode.

Option	Settings
Multiplex	Main (default) —The main channel is output.
	Sub —The sub channel is output.
	M/S —Both the main and sub channels are output.
Mono	L+R —Both the left and right channels are output.
	Left —Only the left channel is output.
	Right —Only the right channel is output.

Setting the Dolby options (Panorama, Dimension, and Center Width submenus)

These settings only apply to 2-channel stereo sources.

The **Panorama** setting lets you broaden the width of the front stereo image when using the Dolby Pro Logic II Music listening mode.

The **Dimension** setting lets you move the sound field forward or backward when using the Dolby Pro Logic II Music listening mode. Higher settings move the sound field backward. Lower settings move it forward. If the stereo image feels too wide, or there's too much surround sound, move the sound field forward to improve the balance. Conversely, if the stereo image feels like it's in mono, or there's not enough surround sound, move it backward.

The **Center Width** setting lets you adjust the width of the sound from the center speaker when using the Dolby Pro Logic II Music listening mode. Normally, if you're using a center speaker, the center channel sound is output by only the center speaker. (If you're not using a center speaker, the center channel sound is distributed to the front left and right speakers to create a phantom center). This setting controls the front left, right, and center mix, allowing you to adjust the weight of the center channel sound.

Submenu	Configuration
Panorama	On — Turns the Panorama function on. Off —Turns the Panorama function off.
Dimension	-3 to 0 to +3
Center Width	0 to 3 to 7

Setting the DTS options (Center Image submenu)

The DTS Neo:6 Music listening mode lets you create 6-channel surround sound from 2-channel stereo sources. With this setting, you can specify by how much the front left and right channel output is attenuated in order to create the center channel.

A value **0** is only audible from the center speaker. A value of more than **0** is audible from the left and right speakers as well.

Submenu	Configuration
Center Image	0 to 2 (default) to 5

Adjusting the Theater-Dimensional setting (Listening Angle submenu)

This setting lets you optimize the Theater-Dimensional listening mode by specifying the angle of the front left and right speakers relative to the listening position. Ideally, the front left and right speakers should be equidistant from the listening position and at an angle close to one of the two available settings.

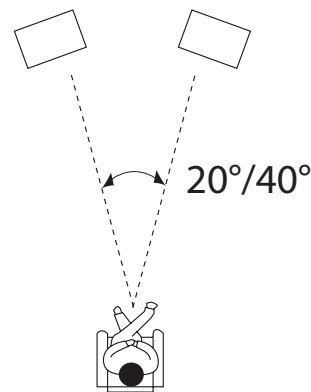

Submenu	Options
Listening Angle	Wide (default) —The listening angle is 40 degrees. Narrow —The listening angle is 20 degrees.

Setting up HDMI (HDMI Setup menu)

Submenu	Configuration
CEC Function	Off (default) —CEC disabled. On —CEC enabled.
HDMI Through	Off (default) —HDMI Through is off. Auto —Detects the signal and automatically selects the input source. BD/DVD, VCR/DVR, CBL/SAT, GAME, AUX, TV/CD —Selects the input source for which the HDMI Through function is enabled. Last —The HDMI Through function is activated on the input source selected when the AV receiver is set to Standby mode.
Audio TV OUT	Off (default) —HDMI audio is not output. On —HDMI audio is output.
Audio Return Ch (ARC)	Off —Select if you don't want to use audio return channel (ARC) function. Auto (default) —The audio signal from your TV tuner can be sent digitally to the HDMI OUT of the receiver.
LipSync	On (default) —Lip sync enabled. Off —Lip sync disabled.

CEC Function (HDMI Control submenu)

This function lets CEC-compatible components connected via HDMI to be controlled by the receiver.

Notes

- When set to **On**, the name of connected CEC-compatible components and **CEC On** are displayed on the receiver when the menu is closed.
- When set to **Off**, **CEC Off** is displayed on the receiver when the menu is closed.
- When a CEC-compatible component is connected to the receiver via HDMI cable, the name of the connected component is displayed on the receiver. For example, when you are watching TV, if you turn on a Blu-ray Disc/DVD player by the receiver's remote control, the name of the Blu-ray Disc/DVD player is displayed on the receiver.
- Set to **Off** when a connected piece of equipment is not compatible or it is unclear whether the equipment is compatible or not.
- If movement is unnatural when set to **On**, change the setting to **Off**.
- Refer to the connected component's instruction manual for details.

HDMI Through

- **Off (default)**—HDMI Through is off.
- **Auto**—Detects the signal and automatically selects the input source.
- **BD/DVD, VCR/DVR, CBL/SAT, GAME, AUX, TV/CD**—Selects the input source for which the HDMI Through function is enabled.
- **Last**—The HDMI Through function is activated on the input source selected when the AV receiver is set to Standby mode.

When enabling the HDMI Through function, regardless of whether the AV receiver is **On** or in **Standby**, both the audio and video streams from an HDMI input will be output to the TV or other components via the HDMI connection. The **HDMI THRU** and **HDMI** indicators light when this is enabled. This setting is set to **Auto** automatically when the above CEC Function is set to **On**.

Notes

- Only the input source assigned to the HDMI IN via "HDMI Input" is enabled.
- The power consumption during standby mode will increase when the HDMI Through function is turned on, however, in the following cases, the power consumption does not increase:
 - The TV is in standby mode.
 - You are watching a TV program.
- Refer to the connected component's instruction manual for details.
- Depending on the connected component, the correct input source may not be selected with the setting set to Auto.
- This setting is set to Off automatically when CEC Function is set to Off.

Audio TV OUT (Audio TV Out submenu)

This setting determines whether audio received by HDMI IN is output by the HDMI OUT. You may want to turn this preference on if your TV is connected to the HDMI OUT and you want to listen to the audio from a component that's connected to an HDMI IN, through your TV's speakers. Normally, this should be set to **Off**.

Notes

- If **On** is selected and the signal can be output by the TV, the receiver outputs no sound through its speakers.
- If **On** is selected, **TV Sp On** appears on the display when you press **DISPLAY**.
- When **TV Control** is set to **On**, this setting default is **Auto**.
- With some TVs and input signals, no sound may be output, even when this setting is **On**.
- When the **Audio TV OUT** or **TV Control** are set to **On**, and you are listening through your TV's speakers, if you turn up the receiver's volume control, the sound is output by the receiver's front left and right speakers. To stop the receiver's speakers from producing sound, change the settings, change your TV's settings, or turn down the receiver's volume.

Audio Return Ch (ARC)(Audio Return Ch submenu)

The audio return channel (ARC) function enables an HDMI 1.4-capable TV to send the audio stream to the HDMI OUT jack of the receiver. To use this function, you must select the TV/CD input and your TV must support the ARC function.

Notes

- The **Audio Return Ch** setting can only be set when **HDMI Control** is **On**.
- This setting is set to **Auto** automatically when **HDMI Control** is set to **On** first time.

LipSync (LipSync submenu)

Lets you set the receiver to automatically correct any delay between the video and the audio, based on the data from the connected monitor.

- To enable, set to **ON**.

- To disable, set to **OFF**.

Notes

- This function only works if your HDMI-compatible TV supports HDMI Lip Sync.
- You can check the amount of delay being applied by the HDMI Lip Sync function on the A/V Sync screen.

Changing audio settings

You can change various audio settings by pressing **HOME** on the remote control.

Note

When **Audio TV OUT** is set to **On**, the **HOME** button is disabled.

To change audio settings:

- 1 Press **RECEIVER** on the remote control, then press **HOME**.
- 2 Press **▲** or **▼** to select an option, then press **◀** or **▶** to change the setting. Repeat this step to change additional settings.

Changing tone control settings

You can adjust the bass and treble for the front speakers, except when the Direct Listening mode is selected. Options include:

- **Bass**—You can boost or cut low-frequency sounds output by the front speakers. **10 dB to 0 dB to +10 dB**, in 2 dB steps
- **Treble**—You can boost or cut high-frequency sounds output by the front speakers. **10 dB to 0 dB to +10 dB**, in 2 dB steps

Notes

- To bypass the bass and treble tone circuits, select the **Direct** listening mode.
- This procedure can also be performed on the receiver by pressing the **TONE-/+** buttons.

Changing the speaker levels

You can adjust the volume of each speaker while listening to an input source. These temporary adjustments are cancelled when the receiver is set to Standby. To save the setting you made here, go to "Setting the level calibration (Level Cal menu)" on page 17, before returning the receiver to Standby. Options include:

- **Subwoofer**—**15 dB to 0 dB to +12 dB**, in 1 dB steps.
- **Center**—**12 dB to 0 dB to +12 dB**, in 1 dB steps.

Notes

- You cannot use this function while the receiver is muted.
- Speakers that are set to **No** or **None** in the *Sp Config* (Speaker Configuration) submenu cannot be adjusted.

Setting the Late Night function

The Late Night function lets you reduce the dynamic range of Dolby Digital material so that you can still hear quiet parts even when listening at low volume levels. This makes it ideal for watching movies late at night when you do not want to disturb anyone. Options are:

- For Dolby Digital and Dolby Digital Plus sources, the options are **Off**, **Low**, and **High**.
- For Dolby TrueHD sources, the options are **Auto**, **Off**, and **On**.

Notes

- The effect of the Late Night function depends on the material that you are playing and the intention of the original sound designer. With some material there is little or no effect when you select the different options.
- The Late Night function can only be used when the input source is Dolby Digital, Dolby Digital Plus, or Dolby TrueHD.
- The Late Night function is set to **Off** when the receiver is set to Standby. For Dolby TrueHD sources, it is set to **Auto**.

Setting the Music Optimizer

The Music Optimizer function enhances the sound quality of compressed music files. Use it with music files that use "lossy" compression, such as MP3. Options are **Off** and **On**.

Notes

- The Music Optimizer function only works with PCM digital audio input signals with a sampling rate below 48 kHz and analog audio input signals. The Music Optimizer is disabled when the Direct listening mode is selected.
- The setting is stored individually for each input selector.
- When the Music Optimizer is on, the **M.OPT** indicator lights.

Setting the CinemaFILTER

The CinemaFILTER lets you soften overly bright movie soundtracks, which are typically mixed for reproduction in a movie theater.

CinemaFILTER can be turned **On** or **Off** for the following listening modes:

- Dolby Digital
- Dolby Digital Plus
- Dolby TrueHD
- Dolby Pro Logic II Movie
- Multichannel
- DTS
- DTS Neo:6 Cinema
- DTS 96/24
- DTS-HD High Resolution
- DTS-HD Master
- DTS Express.

Notes

The CinemaFILTER may not work with some input sources.

Setting the A/V Sync

When using progressive scanning on your Blu-ray Disc/DVD player, you may find that the picture and sound are out of sync. With this setting, you can correct this by delaying the audio signals. Option settings are from **-400 ms** to **400 ms**, in 10 ms steps.

Notes

- A/V Sync is disabled when the Direct listening mode is used with an analog input source.
- The setting is stored individually for each input selector.

Naming inputs (Name Edit menu)

You can enter a preset name for each individual input selector for easy identification. When entered, the preset name appears on the display.

Before selecting a name, press the input selector to select the input source to name.

Submenu	Options
Name Edit	---, Blu-ray, DVD, HD DVD, VCR, DVR, Tivo, CableSTB, SAT STB, PS3, Wii, Xbox, PC, TV, CD, TAPE, and iPod. To reset to the default, select ---.

Notes

- Two different inputs cannot have the same name.
- This menu cannot be used for the **TUNER** input selector.

Setting the Audio Selector

You can set priorities of audio output when there are both digital and analog inputs. Options include:

- **ARC**—The audio signal from your TV tuner can be sent digitally to the **HDMI OUT** of the receiver. With this selection, the TV's audio can automatically be selected as a priority.
- **HDMI**—This can be selected when **HDMI IN** has been assigned as an input source. If both HDMI (**HDMI IN**) and digital audio inputs (**COAXIAL IN** or **OPTICAL IN**) have been assigned, HDMI input is automatically selected.
- **COAX**—This can be selected when **COAXIAL IN** has been assigned as an input source. If both coaxial and optical inputs have been assigned, coaxial input is automatically selected.
- **OPT**—This can be selected when **OPTICAL IN** has been assigned as an input source.
- **Analog**—The receiver always outputs analog signals.

Notes

- The setting is stored individually for each input selector.
- This setting can be made only for the input source that is assigned as HDMI IN, COAXIAL IN, or OPTICAL IN. If both HDMI (HDMI IN) and digital audio inputs (COAXIAL IN or OPTICAL IN) are assigned, HDMI input is selected as a priority by setting to **ARC**. To select the digital audio input, see "Setting up Digital Audio (Digital Audio menu)" on page 22.
- You can select **ARC** if you select the TV/CD input selector. But you cannot select it if you have selected **Off** in the Audio Return Ch setting.

Selecting a digital input signal format (Fixed Mode)

The digital input signal formats are available only for the input sources that you have assigned a digital input jack.

Normally, the receiver detects the signal format automatically. However, if you experience any issues when playing PCM or DTS material, you can manually set the signal format to PCM or DTS.

Notes

- If the beginnings of tracks from a PCM source are cut off, try setting the format to PCM.
- If noise is produced when fast forwarding or reversing a DTS CD, try setting the format to DTS.
- The setting is stored individually for each input selector.
- The setting is reset to **Off** when you change the setting in the Audio Selector.

- **Off**—The format is detected automatically. If no digital input signal is present, the corresponding analog input is used instead.
- **PCM**—Only 2-channel PCM format input signals are heard. If the input signal is not PCM, the PCM indicator flashes and noise may also be produced.
- **DTS**—Only DTS (but not DTS-HD) format input signals is heard. If the input signal is not DTS, the DTS indicator flashes and there is no sound.

OSD Setting

Volume OSD

- **On**
- **Off**

Select **On** when you want to display the volume level on-screen when it is adjusted.

Auto Standby

Auto Standby

- **On**
- **Off**

When Auto Standby is set to **On**, the Surround Sound Receiver automatically returns to Standby when no audio or video signal is received for 30 minutes.

Note

The Auto Standby function may activate during playback of some source.

Controlling other components

You can use your receiver's remote control to control your other AV components. This section explains how to enter the remote control code for a component that you want to control, such as a DVD player, a TV, or a CD player. See "Remote control codes" on page 28.

Preprogrammed remote control codes

Remote control codes for Insignia Blu-ray disc players and Insignia TVs are preprogrammed into the remote control. You do not need to enter a remote control code to control these components.

To enter remote control codes:

- 1 While holding down the **REMOTE MODE** button to which you want to enter a code, press and hold down the **DISPLAY** button until the Remote indicator lights up (about three seconds).
- 2 Within 30 seconds, press the number buttons to enter the 5-digit remote control code. The Remote indicator flashes twice.

To reset a REMOTE MODE button:

- 1 While holding down the **REMOTE MODE** button that you want to reset, press and hold **HOME** until the Remote indicator lights (about three seconds).
- 2 Within 30 seconds, press the **REMOTE MODE** button again.
The Remote indicator flashes twice, indicating that the button has been reset.

Each **REMOTE MODE** button is preprogrammed with a remote control code. When a button is reset, its preprogrammed code is restored.

To reset the remote control:

- 1 While holding down the **RECEIVER** button, press and hold **HOME** until the Remote indicator lights (about three seconds).
- 2 Within 30 seconds, press the **RECEIVER** button again.
- 3 The Remote indicator blinks twice, indicating that the remote control has been reset.

To control other components:

- Press the **REMOTE MODE** button that you have programmed with the remote control code for your component.

Using the remote control to control other components

Press the **REMOTE MODE** button for the component you want to control first.

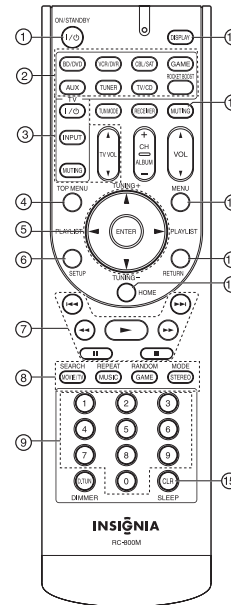

#	Button/Component	TV	DVD player/recorder	Blu-ray disc player	VCR/PVR	Satellite/Cable receiver
1	Power/Standby	X	X		X	X
2	Input selector			X		
3	These buttons can control the TV, regardless of the mode selected.					
4	TOP MENU		X			
5	ENTER	X	X		X	X
	◀/▶ / ▲/▼					
6	SETUP					
7	▶ / / ◀ / ▶▶ / ◀◀ / ▶▶▶	X	X		X	X
8	SEARCH	X*	X	X*		X*
	REPEAT	X*	X	X*		X*
	RANDOM	X*	X	X*		X*
	MODE	X*	X	X*		X*
9	Numbers	X	X		X	X
10	DISPLAY	X	X		X	X
11	MUTING	X	X		X	X
12	MENU		X			
13	RETURN	X	X		X	X
14	HOME	X	X			X
15	CLR	X	X		X	X

Note
Certain buttons may not work as expected with some components, and some may not work at all.

Remote control codes

Insignia Receiver

Default	62472
Tuner	52472

Cable Set Top Box

Bright House	01376, 01877
Cable One	01376, 01877
Cablevision	01006, 01376, 01877
Charter	01376, 01877
Cisco	01877, 01982
Comcast	01376, 01877, 01982
Cox	01376, 01877
Digeo	01187
Insight	01376, 01877
Knology	01877
Mediacom	01376, 01877
Motorola	01187, 01376, 01982
Pace	01376, 01877, 01982
Panasonic	01982
Pioneer	01877
Rogers	01877
Scientific Atlanta	01877
Shaw	01376
Sony	01006
Suddenlink	01376, 01877
Time Warner	01376, 01877
WideOpenWest	01877

Cable/PVR Combination

Bright House	01376, 01877
Cable One	01376, 01877
Cablevision	01006, 01376, 01877
Charter	01376, 01877, 02187
Cisco	01877, 01982
Comcast	01376, 01877, 01982, 02576
Cox	01376, 01877
Digeo	01187, 02187
Insight	01376, 01877
Knology	01877
Mediacom	01376, 01877
Motorola	01376, 01187
Pace	01877
Panasonic	01982
Pioneer	01877
Rogers	01877
Scientific Atlanta	01877
Shaw	01376
Sony	01006
Suddenlink	01376, 01877
Time Warner	01376, 01877, 02187
Tivo	02576

Cable/PVR Combination

WideOpenWest	01877
--------------	-------

CD

Denon	72222
DKK	70000
Insignia	72585
Miro	70000
Optimus	70000, 70468
Pioneer	70468
RCA	70468
Sony	70000
Yamaha	70036

CD-R

Sony	70000
------	-------

Accessory

Insignia	82587
AT&T	00858
Cisco	02345
Motorola	00858, 02378
Scientific Atlanta	00858, 02345
Verizon	02378

Satellite Set Top Box

Bell ExpressVu	00775
DirecTV	00247, 00566, 00639, 00749, 01142, 01377, 01442, 01609, 01749
Dish Network	00775, 01775
Dishpro	00775, 01775
Echostar	00775, 01775
Expressvu	00775, 01775
GE	00566
General Instrument	00869
GOI	00775, 01775
HTS	00775, 01775
Hughes Network Systems	00749, 01142, 01442, 01749
Jerrold	00869
JVC	00775, 01775
Mitsubishi	00749
Motorola	00869
Next Level	00869
Panasonic	00247
Philips	00749, 01142, 01442, 01749
Proscan	00566
RadioShack	00869
RCA	00566
Samsung	01377, 01442, 01609
Sony	00639
Star Choice	00869
Tivo	01142, 01442

Satellite Set Top Box	
Toshiba	00749, 01749
Voom	00869

SAT/PVR Combination	
Bell ExpressVu	00775
DirecTV	00639, 01142, 01377, 01442
Dish Network	00775
Dishpro	00775
Echostar	00775
Expressvu	00775
Hughes Network Systems	01142, 01442
Motorola	00869
Philips	01142, 01442
Samsung	01442
Sony	00639
Star Choice	00869
Tivo	01142, 01442

Television	
Akai	10812, 11675
Dynex	11780, 12049, 12184
Electrograph	11755
Emerson	11394, 11864, 11963
ESA	10812, 11963
Funai	11963
Gateway	11755
GFM	11963
Hisense	11660
Hitachi	11643
Insignia	11204, 11423, 11517, 11564, 11660, 11780, 11892, 11963, 12002, 12049, 12417
JVC	11601
LG	11423, 12358
Magnavox	11454, 11963
Marantz	11454
Maxent	11755
Memorex	11892
Mitsubishi	11250
NEC	11797
NetTV	11755
Olevia	11610
Panasonic	11457, 11480
Petters	11523
Philco	11394, 11963
Philips	11454, 11744
Pioneer	11457
Polaroid	11523, 12002
RCA	11781, 12002, 12187, 12247, 12434
Sampo	11755
Samsung	10812
Sansui	11892

Television	
Sanyo	11142
Sharp	10818
Sony	10810
SVA	11963
Sylvania	11394, 11864, 11963
Syntax	11610
Toshiba	11524, 12006
Viewsonic	10857, 11627, 11755
Vizio	11758
Westinghouse	10889, 11712
Zenith	11423

VCR	
DirecTV	20739
Humax	20739
Philips	20739
Tivo	20739

PVR	
DirecTV	20739
Humax	20739
Philips	20739
Tivo	20739

DVD	
Accurian	33002
California Audio Labs	30490
Denon	30490, 31634, 33010
Disney	33002
Emerson	33002
Funai	33002
GE	30522
GFM	33002
Go Video	33003
GoldStar	33003
Grundig	30539
Hitachi	30573
Insignia	32095, 33002, 33014, 33025
Integra	31634, 32900
JVC	32365
Kenwood	30490
LG	33003
Magnavox	30503, 30539, 33002
Marantz	30539, 33013
Microsoft	30522
NAD	33003
Onkyo	30503, 32900, 32910
Panasonic	30490, 30503, 33005
Philco	33002
Philips	30503, 30539, 32056, 33002, 33007, 33016
Pioneer	30631, 33000, 33017

DVD

Polk Audio	30539
Presidian	33002
Proscan	30522
RCA	30522
Samsung	30490, 30573, 33001, 32329, 32489, 32556
Sharp	33002
Sony	30864, 31033, 31633, 33004
Sylvania	33002
Symphonic	33002
Technics	30490
Toshiba	30503, 32277
Urban Concepts	30503
Xbox	30522
Yamaha	30490, 30539, 30817, 33011
Zenith	30503, 33003

DVD High Definition (Blu-Ray)

Denon	33010
Insignia	33002, 33014, 33025
Integra	32900
JVC	32365
LG	33003
Magnavox	33002
Marantz	33013, 33015
NAD	33024
Olevia	33012
Onkyo	32900, 32910
Oppo	33021
Panasonic	33005
Philips	33007, 33016
Pioneer	33000, 33017
Samsung	33001
Sharp	33009
Sony	33004, 33026, 33008
Sylvania	33002
Viore	33022
Vizio	33023
Yamaha	33011

DVD-R

Accurian	33002
Funai	33002
Go Video	33003
LG	33003
Magnavox	33002
Panasonic	30490
Pioneer	30631
RCA	30522
Samsung	30490
Sharp	33002
Sony	31033
Sylvania	33002
Toshiba	32277

DVD-R

Zenith	33003
--------	-------

TV/DVD Combination

Akai	11675
Dynex	12049, 12184
Emerson	11394, 11864, 11963, 33002
ESA	11963
Funai	11963
GFM	11963
Insignia	11963, 12002, 12049, 12417
LG	11423
Magnavox	11963
Polaroid	11523, 12002
RCA	12002, 12187
Sharp	10818
Sylvania	11394, 11864, 11963, 33002
Toshiba	11524, 12006

Maintaining

To clean this receiver, wipe with a soft, dry cloth. If the surfaces are extremely dirty, use a soft cloth dipped in a soap and water solution or a weak detergent solution.

- Never use alcohol, paint thinner, or benzene to clean this receiver.
- Before using a chemically treated cloth, read the instructions that came with the cloth carefully.

Troubleshooting

If a problem occurs, run through the following table before contacting Insignia.

If the problem persists, attempt to solve it by switching the receiver off and on again. If this fails to resolve the problem, contact Insignia. Under no circumstances should you attempt to repair the receiver yourself as this could void the warranty.

To reset the receiver to its factory defaults, turn it on and, while holding down VCR/DVR, press **ON/STANDBY**. **Clear** appears on the display and the receiver enters Standby mode.

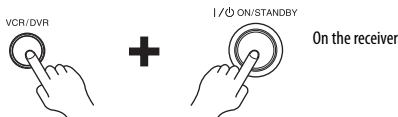

Note that resetting the receiver will delete your radio presets and custom settings.

To reset the remote control to its factory defaults, while holding down **RECEIVER**, press and hold down **AUDIO** until the Remote indicator lights (about three seconds). Within 30 seconds, press **RECEIVER** again.

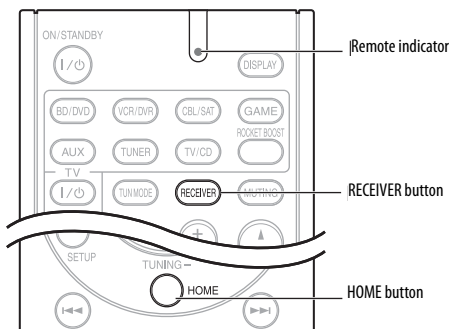

Notes

- The receiver contains a microcomputer for signal processing and control functions. In rare situations, severe interference, noise from an external source, or static electricity may cause it to lockup. If this happens, unplug the power cord from the wall outlet, wait at least five seconds, and then plug it back in again.
- Insignia is not responsible for damages (such as CD rental fees) due to unsuccessful recordings caused by the unit's malfunction.
- Before disconnecting the power cord from the wall outlet, set the receiver to Standby.

Category	Problem/Possible Solution
AUDIO Problems	
No power	<ul style="list-style-type: none"> • Connect the cord securely. • Check the outlet using a lamp or another appliance.
The STANDBY indicator flashes red	<ul style="list-style-type: none"> • Remove the power cord from the wall outlet immediately. Disconnect all speaker cables and input sources, and then leave the receiver with its power cord disconnected for one hour. After that, reconnect the power cord and set the volume to maximum. If the receiver stays on, set then the volume to minimum, disconnect the power cord, and reconnect your speakers and input sources. If the receiver turns off when you set the volume to maximum, disconnect the power cord, and contact your Insignia dealer.
No sound	<ul style="list-style-type: none"> • Make sure that the digital input source is selected properly. • Make sure that all audio connecting plugs are pushed in all the way. • Make sure that the inputs and outputs of all components are connected properly. • Make sure that the polarity of the speaker cables is correct, and that the bare wires are in contact with the metal part of each speaker terminal. • Make sure that the input source is properly selected. • Make sure that the speaker cables are not shorting. • Check the volume. The receiver is designed for home theater enjoyment. It has a wide volume range, allowing precise adjustment. • If the MUTING indicator is flashing on the display, press the remote control MUTING button to unmute the receiver. • While a pair of headphones is connected to the PHONES jack, no sound is output by the speakers. • If there is no sound from a DVD player connected to HDMI IN jack, check the DVD player's output settings, and be sure to select a supported audio format. • Check the digital audio output setting on the connected device. On some game consoles, such as those that support DVD, the default setting is off. • With some DVD-Video discs, you need to select an audio output format from a menu. • If your turntable uses an MC cartridge, you must connect an MC head amp, or an MC transformer. • Make sure that none of the connecting cables are bent, twisted, or damaged. • Not all listening modes use all speakers. • Specify the speaker distances and adjust the individual speaker levels. • The input signal format is set to PCM or DTS. Set it to Auto.
Only the front speakers produce sound	<ul style="list-style-type: none"> • When the Stereo or Mono listening mode is selected, only the front speakers and subwoofer produce sound. • Check the Speaker Configuration.
Only the center speaker produces sound	<ul style="list-style-type: none"> • If you use the Dolby Pro Logic II Movie, Dolby Pro Logic II Music, or Dolby Pro Logic II Game listening mode with a mono source, such as an AM radio station or mono TV program, the sound is concentrated in the center speaker. • Make sure the speakers are configured correctly.
The surround speakers produce no sound	<ul style="list-style-type: none"> • When the T-D (Theater-Dimensional), Stereo, or Mono listening mode is selected, the surround speakers produce no sound. • Depending on the source and current listening mode, not much sound may be produced by the surround speakers. Try selecting another listening mode. • Make sure the speakers are configured correctly.
The center speaker produces no sound	<ul style="list-style-type: none"> • When the Stereo or Mono listening mode is selected, the center speaker produces no sound. • Make sure the speakers are configured correctly.
The subwoofer produces no sound	<ul style="list-style-type: none"> • When you play source material that contains no information in the LFE channel, the subwoofer produces no sound. • Make sure the speakers are configured correctly. • If you are using Rocketboost™ to send audio to the subwoofer, make sure that the RF-RBCARD power is ON

Category	Problem/Possible Solution
There's no sound with a certain signal format	<ul style="list-style-type: none"> Check the digital audio output setting on the connected device. On some game consoles, such as those that support DVD, the default setting is off. With some DVD-Video discs, you need to select an audio output format from a menu. Depending on the input signal, some listening modes cannot be selected.
No 5.1 playback	<ul style="list-style-type: none"> You can not always select all of the listening modes, depending on the number of the speakers connected.
The volume cannot be set to 79	<ul style="list-style-type: none"> Check to see if a maximum volume has been set. After the volume level of each individual speaker has been adjusted, the maximum volume may be reduced. When the levels of each speaker have been adjusted, the maximum possible volume may be reduced.
Noise can be heard	<ul style="list-style-type: none"> Using cable ties to bundle audio cables with power cords, speaker cables, and so on may degrade the audio performance, so don't do it. An audio cable may be picking up interference. Try repositioning your cables.
The Late Night function does not work	<ul style="list-style-type: none"> Make sure that the source material is Dolby Digital, Dolby Digital Plus, and Dolby TrueHD.
DTS signal problems	<ul style="list-style-type: none"> When DTS program material ends and the DTS bitstream stops, the receiver remains in DTS listening mode and the DTS indicator remains on. This is to prevent noise when you use the pause, fast forward, or fast reverse function on your player. If you switch your player from DTS to PCM, because the receiver does not switch formats immediately, you may not hear any sound, in which case you should stop your player for about three seconds, and then resume playback. With some CD and LD players, you won't be able to playback DTS material properly even though your player is connected to a digital input on the receiver. This is usually because the DTS bitstream has been processed (for example, output level, sampling rate, or frequency response changed) and the receiver does not recognize it as a genuine DTS signal. In such cases, you may hear noise. When playing DTS program material, using the pause, fast forward, or fast reverse function on your player may produce a short audible noise. This is not a malfunction.
The beginning of audio received by an HDMI IN can not be heard	<ul style="list-style-type: none"> Since it takes longer to identify the format of an HDMI signal than it does for other digital audio signals, audio output may not start immediately.
VIDEO Problems	
No picture	<ul style="list-style-type: none"> Make sure that all video connecting plugs are pushed in all the way. Make sure that each video component is properly connected. If the video source is connected to a component video input, you must assign that input to an input selector, and your TV must be connected to COMPONENT VIDEO MONITOR OUT. If the video source is connected to a composite video input, your TV must be connected to the corresponding composite video output. If the video source is connected to an HDMI input, you must assign that input to an input selector, and your TV must be connected to the HDMI OUT. On your TV, make sure that the video input to which the receiver is connected is selected.
There is no picture from a source connected to an HDMI IN	<ul style="list-style-type: none"> Reliable operation with an HDMI-to-DVI adapter is not guaranteed. In addition, video signals from a PC are not guaranteed.
The on-screen menus do not appear	<ul style="list-style-type: none"> On your TV, make sure that the video input to which the receiver is connected is selected. When the receiver doesn't connect TV with HDMI, onscreen menus are not displayed.

Category	Problem/Possible Solution
TUNER Problems	
Reception is noisy, FM stereo reception is noisy, or the FM STEREO indicator does not light	<ul style="list-style-type: none"> Relocate your antenna. Move the receiver away from your TV or computer. Listen to the station in mono. When listening to an AM station, operating the remote control may cause noise. Passing cars and airplanes can cause interference. Concrete walls weaken radio signals. If nothing improves the reception, install an outdoor antenna.
WIRELESS Problems	
Cannot connect to a Rocketboost network	<ul style="list-style-type: none"> If the joining process is failing, make sure that only one of your Rocketboost wireless devices has the Hub switch enabled. Make sure that you have installed the RF-RBCARD (sold separately). Make sure that the link is established by Rocketboost setup menu. For more information, see "Establishing communications with other Rocketboost devices" on page 14. The maximum number of Rocketboost devices in a Rocketboost Network is nine. If you already have nine devices and attempt to join another one, then joining will fail for the new device. Remove (power down) one of your devices and try again.
REMOTE CONTROL Problems	
The remote control does not work	<ul style="list-style-type: none"> Before operating this unit, be sure to press RECEIVER. Make sure that the batteries are installed with the correct polarity. Install new batteries. Don't mix different types of batteries, or old and new batteries. Make sure that the remote control is not too far away from the receiver, and that there's no obstruction between the remote control and the receiver's remote control sensor. Make sure that the receiver is not subjected to direct sunshine or inverter-type fluorescent lights. Relocate if necessary. If the receiver is installed in a rack or cabinet with colored-glass doors, the remote control may not work reliably when the doors are closed. Make sure you've selected the correct remote control mode. Make sure you've entered the correct remote control code. Make sure to set the same ID on both the receiver and remote control.
Cannot control other components	<ul style="list-style-type: none"> Make sure that you have selected the correct remote control mode. If you cannot operate it, you need to enter the appropriate remote control code.
RECORDING Problems	
Cannot record	<ul style="list-style-type: none"> On your recorder, make sure the correct input is selected. To prevent signal loops and damage to the receiver, input signals are not fed through to outputs with the same name (for example, VCR/DVR IN to VCR/ DVR OUT).
MISCELLANEOUS Problems	
The sound changes when I connect my headphones	<ul style="list-style-type: none"> When a pair of headphones is connected, the listening mode is set to Stereo, unless it's already set to Stereo, Mono, or Direct.

Category	Problem/Possible Solution
How do I change the language of a multiplex source	<ul style="list-style-type: none"> Use the Multiplex setting on the <i>Audio Adjust</i> menu to select Main or Sub.
The following settings can be made for the composite video inputs	<p>You must use the buttons on the unit to make these settings.</p> <ol style="list-style-type: none"> While holding down the input selector button for the input source that you want to set, press SETUP. Use ◀/▶ to change the setting. Press the input selector button for the input source that you want to set when you have finished. <p>Video Attenuation</p> <p>This setting can be made for the BD/DVD, VCR/DVR, CBL/SAT, GAME, or AUX input.</p> <p>If you have a game console connected to the composite video input, and the picture is not very clear, you can attenuate the gain.</p> <ul style="list-style-type: none"> Video ATT–0: (default). Video ATT–2: Gain is reduced by 2 dB.

Specifications

Note

Design and specifications are subject to change without notice.

Amplifier section

Element	Specification
Rated output power All channels	90 watts minimum continuous power per channel, 8 ohm loads, 1 channel driven at 1 kHz with a maximum total harmonic distortion of 1%.
THD (Total Harmonic Distortion)	0.08% (1 kHz, 1 W)
Input sensitivity and impedance	200 mV/47 kohms (LINE)
Output level and impedance	200 mV/2.2 kohms (REC OUT)
Frequency response	20 Hz - 50 kHz/+1 dB - 3 dB (DSP bypass)
Tone control	±10 dB, 50 Hz (BASS) ±10 dB, 20 kHz (TREBLE)
Signal to Noise ratio	90 dB (LINE, IHF-A)
Speaker impedance	6 ohms - 16 ohms

Video section

Element	Specification
Input sensitivity/ Output level and impedance	1 Vp-p/75 ohms (Component) 0.7 Vp-p/75 ohms (Component PB/CB, PR/CR) 1 Vp-p/75 ohms (Composite)
Component video frequency response	5 Hz - 100 MHz/±0 dB, - 3 dB

Tuner section

Element	Specification
FM tuning frequency range	87.5 MHz - 107.9 MHz
AM tuning frequency range	530 kHz - 1710 kHz
Preset channels	40

General section

Element	Specification
Power supply	AC 120 V, 60 Hz
Power consumption	3.3 A
Standby power consumption	0.2 W
Dimensions (W x H x D)	17-1/8" x 5-15/16" x 12-7/8" 435 mm x 150.5 mm x 327 mm
Weight	17 lbs (7.7 kg)
HDMI	
Input	IN1, IN2, IN3, IN4
Output	OUT
Video Resolution	1080p
Audio Format	Dolby TrueHD, DTS Master Audio, DVD-Audio, DSD
Supported	CEC, 3D, ARC, Deep Color, x.v.Color, LipSync
VIDEO INPUTS	
Component	IN 1, IN 2
Composite	BD/DVD, VCR/DVR, CBL/SAT, GAME, AUX
VIDEO OUTPUTS	
Component	OUT
Composite	MONITOR OUT, VCR/DVR
AUDIO INPUTS	
Digital	Optical: 2 Coaxial: 1
Analog	BD/DVD, VCR/DVR, CBL/SAT, GAME, TV/CD, AUX
AUDIO OUTPUTS	
Analog	VCR/DVR,
Subwoofer Pre Output	¹
Speaker Outputs	Front (L, R), C, SL, SR
Phones	1 (6.3 ø)

Subwoofer

Element	Specification
Type	Bass-reflex
Input sensitivity/ Impedance	140 mV/20 kohm

Element	Specification
Maximum output power	120 W (RMS), driven into 4 ohms
Frequency response	25 Hz-150 Hz
Cabinet capacity	1.34 cubic feet (38L)
Dimensions (W x H x D)	12-1/2" x 18-1/8" x 15-11/16" (317.5 mm x 460 mm x 398 mm)
Weight	24.3 lbs (11 kg)
Drivers unit	10" (25 cm) cone
Power supply	AC 120 V, 60 Hz
Power consumption	163 W
Other	Auto standby function

Front speakers

Element	Specification
Type	2-way bass-reflex
Impedance	6 ohm
Maximum input power	120 W
Sensitivity	81.5 dB/W/m
Frequency response	60 Hz-50 kHz
Crossover frequency	4 kHz
Cabinet capacity	0.049 cubic feet (1.4 L)
Dimensions (W x H x D)	5-5/16" x 8-11/16" x 4-3/16" (135 mm x 220 mm x 107 mm)
Weight	3.3 lbs (1.5 kg)
Drivers unit	4" (10 cm) cone (woofer) 1" (2.5 cm) balanced dome (tweeter)
Terminal	Spring-type, color coded
Keyhole slot	1
Grill	Fixed
Other	Magnetic shielding

Center speaker

Element	Specification
Type	2-way bass-reflex
Impedance	6 ohm
Maximum input power	120 W
Sensitivity	85 dB/W/m
Frequency response	65 Hz-50 kHz
Crossover frequency	6 kHz
Cabinet capacity	0.081 cubic feet (2.3 L)

Element	Specification
Dimensions (W x H x D)	13-9/16" x 4-1/2" x 4-5/8" (344.5 mm x 114.5 mm x 118 mm)
Weight	4.6 lbs (2.1 kg)
Drivers unit	3-1/4" (8 cm) cone (woofer) X 2 1" (2.5 cm) balanced dome (tweeter)
Terminal	Spring-type, color coded
Keyhole slot	2
Grill	Fixed
Other	Magnetic shielding

Surround speakers

Element	Specification
Type	Full-range, closed box
Impedance	6 ohm
Maximum input power	120 W
Sensitivity	81.5 dB/W/m
Frequency response	85 Hz-20 kHz
Cabinet capacity	0.028 cubic feet (0.8 L)
Dimensions (W x H x D)	4-1/2" x 7-11/16" x 3-11/16" (115 mm x 195.5 mm x 93 mm)
Weight	2.0 lbs (0.9 kg)
Drivers unit	3-1/4" (8 cm) cone
Terminal	Spring-type, color coded
Keyhole slot	1
Grill	Fixed

Legal notices

FCC Part 15

This device complies with Part 15 of the FCC Rules. Operation of this product is subject to the following two conditions: (1) this device may not cause harmful interference, and (2) this device must accept any interference received, including interference that may cause undesired operation.

This equipment has been tested and found to comply within the limits for a class B digital device, pursuant to Part 15 of the FCC Rules. These limits are designed to provide reasonable protection against harmful interference in a residential installation. This equipment generates, uses, and can radiate radio frequency energy and, if not installed and used in accordance with the instructions, may cause harmful interference to radio communications. However, there is no guarantee that interference will not occur in a particular installation. If this equipment does cause harmful interference to radio or television reception, which can be determined by turning the equipment off and on, the user is encouraged to try to correct the interference by one or more of the following measures:

- Reorient or relocate the receiving antenna.
- Increase the separation between the equipment and receiver.
- Connect the equipment into an outlet on a circuit different from that to which the receiver is connected.
- Consult the dealer or an experienced technician for help.

FCC warning

Per FCC regulation 47 CFR 15.21: Changes or modifications not expressly approved by the party responsible for compliance with the FCC Rules could void the user's authority to operate this equipment.

Canada ICES-003 statement

This Class B digital apparatus complies with Canadian ICES-003.

Dolby TrueHD

Manufactured under license from Dolby Laboratories. "Dolby", "Pro Logic" and the double-D symbol are trademarks of Dolby Laboratories.

DTS HD®

Manufactured under license under U.S. Patent #'s: 5,956,674; 5,974,380; 6,226,616; 6,487,535; 7,212,872; 7,333,929; 7,392,195; 7,272,567 & other U.S. and worldwide patents issued & pending. DTS-HD, the Symbol, & DTS-HD and the Symbol together are registered trademarks of DTS, Inc. Product includes software. © DTS, Inc. All Rights Reserved.

HDMI®

"HDMI, the HDMI Logo, and High-Definition Multimedia Interface are trademarks or registered trademarks of HDMI Licensing LLC in the United States and other countries."

One-year limited warranty

Insignia Products ("Insignia") warrants to you, the original purchaser of this new **NS-HT511** ("Product"), that the Product shall be free of defects in the original manufacture of the material or workmanship for a period of one (1) year from the date of your purchase of the Product ("Warranty Period"). This Product must be purchased from an authorized dealer of Insignia brand products and packaged with this warranty statement. This warranty does not cover refurbished Product. If you notify Insignia during the Warranty Period of a defect covered by this warranty that requires service, terms of this warranty apply.

How long does the coverage last?

The Warranty Period lasts for 1 year (365 days) from the date you purchased the Product. The purchase date is printed on the receipt you received with the Product.

What does this warranty cover?

During the Warranty Period, if the original manufacture of the material or workmanship of the Product is determined to be defective by an authorized Insignia repair center or store personnel, Insignia will (at its sole option): (1) repair the Product with new or rebuilt parts; or (2) replace the Product at no charge with new or rebuilt comparable products or parts. Products and parts replaced under this warranty become the property of Insignia and are not returned to you. If service of Products or parts are required after the Warranty Period expires, you must pay all labor and parts charges. This warranty lasts as long as you own your Insignia Product during the Warranty Period. Warranty coverage terminates if you sell or otherwise transfer the Product.

How to obtain warranty service?

If you purchased the Product at a retail store location, take your original receipt and the Product to the store you purchased it from. Make sure that you place the Product in its original packaging or packaging that provides the same amount of protection as the original packaging. If you purchased the Product from an online web site, mail your original receipt and the Product to the address listed on the web site. Make sure that you put the Product in its original packaging or packaging that provides the same amount of protection as the original packaging.

To obtain in-home warranty service for a television with a screen 25 inches or larger, call 1-888-BESTBUY. Call agents will diagnose and correct the issue over the phone or will have an Insignia-approved repair person dispatched to your home.

Where is the warranty valid?

This warranty is valid only to the original purchaser of the product in the United States, Canada, and Mexico.

What does the warranty not cover?

This warranty does not cover:

- Customer instruction
- Installation
- Set up adjustments
- Cosmetic damage
- Damage due to acts of God, such as lightning strikes
- Accident
- Misuse
- Abuse
- Negligence
- Commercial use
- Modification of any part of the Product, including the antenna
- Plasma display panel damaged by static (non-moving) images applied for lengthy periods (burn-in).

This warranty also does not cover:

- Damage due to incorrect operation or maintenance
- Connection to an incorrect voltage supply
- Attempted repair by anyone other than a facility authorized by Insignia to service the Product
- Products sold as is or with all faults
- Consumables, such as fuses or batteries
- Products where the factory applied serial number has been altered or removed

REPAIR REPLACEMENT AS PROVIDED UNDER THIS WARRANTY IS YOUR EXCLUSIVE REMEDY. INSIGNIA SHALL NOT BE LIABLE FOR ANY INCIDENTAL OR CONSEQUENTIAL DAMAGES FOR THE BREACH OF ANY EXPRESS OR IMPLIED WARRANTY ON THIS PRODUCT, INCLUDING, BUT NOT LIMITED TO, LOST DATA, LOSS OF USE OF YOUR PRODUCT, LOST BUSINESS OR LOST PROFITS. INSIGNIA PRODUCTS MAKES NO OTHER EXPRESS WARRANTIES WITH RESPECT TO THE PRODUCT, ALL EXPRESS AND IMPLIED WARRANTIES FOR THE PRODUCT, INCLUDING, BUT NOT LIMITED TO, ANY IMPLIED WARRANTIES OF AND CONDITIONS OF MERCHANTABILITY AND FITNESS FOR A PARTICULAR PURPOSE, ARE LIMITED IN DURATION TO THE WARRANTY PERIOD SET FORTH ABOVE AND NO WARRANTIES, WHETHER EXPRESS OR IMPLIED, WILL APPLY AFTER THE WARRANTY PERIOD. SOME STATES, PROVINCES AND JURISDICTIONS DO NOT ALLOW LIMITATIONS ON HOW LONG AN IMPLIED WARRANTY LASTS, SO THE ABOVE LIMITATION MAY NOT APPLY TO YOU. THIS WARRANTY GIVES YOU SPECIFIC LEGAL RIGHTS, AND YOU MAY ALSO HAVE OTHER RIGHTS, WHICH VARY FROM STATE TO STATE OR PROVINCE TO PROVINCE.

Contact Insignia:

For customer service please call 1-877-467-4289
www.insigniaproducts.com

Distributed by Best Buy Purchasing, LLC
7601 Penn Avenue South, Richfield, Minnesota, U.S.A.
55423-3645

© 2011 BBY Solutions, Inc.

All rights reserved. INSIGNIA is a trademark of BBY Solutions, Inc. Registered in some countries. All other products and brand names are trademarks of their respective owners.



www.insigniaproducts.com (877) 467-4289

Distributed by Best Buy Purchasing, LLC
7601 Penn Avenue South, Richfield, MN USA 55423-3645
© 2011 BBY Solutions, Inc.

All rights reserved. INSIGNIA is a trademark of BBY Solutions, Inc. Registered in some countries.
All other products and brand names are trademarks of their respective owners.

SN 29400834

ENGLISH
11-0310

Free Manuals Download Website

<http://myh66.com>

<http://usermanuals.us>

<http://www.somanuals.com>

<http://www.4manuals.cc>

<http://www.manual-lib.com>

<http://www.404manual.com>

<http://www.luxmanual.com>

<http://aubethermostatmanual.com>

Golf course search by state

<http://golfingnear.com>

Email search by domain

<http://emailbydomain.com>

Auto manuals search

<http://auto.somanuals.com>

TV manuals search

<http://tv.somanuals.com>