KODAK EASYSHARE Digital Frame



Extended user guide

P750/P850

www.kodak.com

For help with your digital frame, www.kodak.com/go/digitalframesupport

Kodak

Eastman Kodak Company
Rochester, New York 14650

© Kodak, 2010



All screen images are simulated.

Kodak, EasyShare, and Perfect Touch are trademarks of Eastman Kodak Company.

P/N 4H7103_en

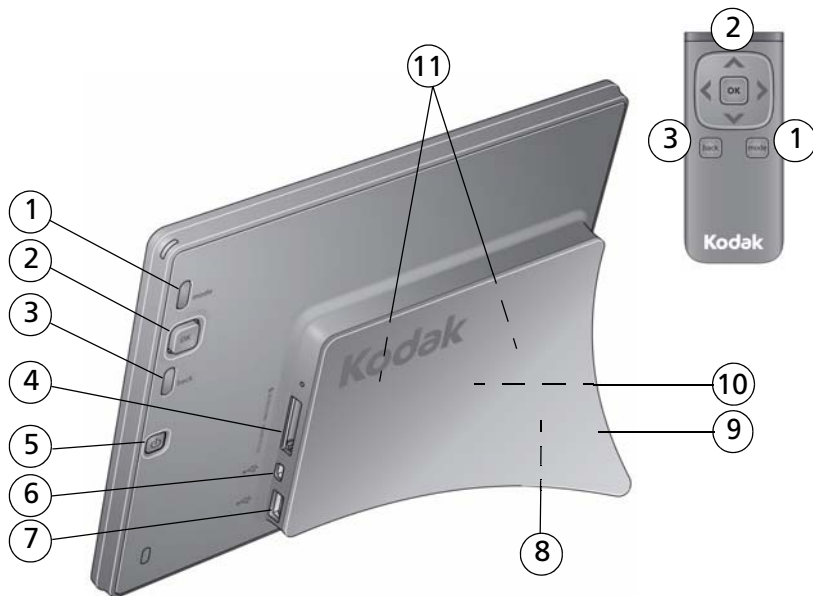
Frame features



- | | |
|--|--|
| 1 mode button | 6 USB high-speed device—connect to computer* |
| 2 OK/4-way navigation | 7 USB high-speed host—connect to USB flash drive or hard drive |
| 3 back button | 8 DC-In 5V  , behind stand (see page 2) |
| 4 Memory card slot - SD/SDHC/MMC/MS/MS Pro/XD | 9 Stand |
| 5 Power button  | 10 Data plate with serial number, behind stand—remove stand to access (see page 1) |
| | 11 Wall mounting holes (2), behind stand—remove stand to access (see page 27) |

* purchase USB cable separately

Main control panel—icons



Play/
Pause



Pictures



Copy/
Delete



Picture
Finder



Transitions



Set
Modes



Settings

- Press **OK** to display the main control panel.
- Press **◀▶** to highlight an icon, then press **OK** to select it.

Icon

Description



Play—start playing a slide show.



Pause—resume a paused slide show (see page 18).



Pictures—find your pictures by: all, date, folders, keywords, people, favorites (see page 11). The Pictures icon changes to indicate your current picture source:  internal memory,  memory card,  USB flash drive or device.



Copy—copy pictures to the frame, appears when a memory card or USB device is inserted (see page 8).



Delete—delete pictures from the frame, appears when no memory card or USB device is inserted (see page 18).



Picture Finder—play similar pictures, those taken on the same day as the picture on the screen (see page 17).



Transitions—choose a transition style between pictures, and how long each picture is displayed (see page 24).



Set Modes—choose your favorite style for collage, clock, and calendar modes. Then play pictures in these modes by pressing the **mode** button on the remote control (see page 25).



Settings—change your frame settings (see page 19).

Table of contents

1 Getting started	1
Attaching/removing the stand	1
Attaching the power cable	2
Navigating with the remote control	3
Storing the remote control.....	3
Setting your language	4
Setting the time, date, and on/off times.....	5
Activity sensors—energy saver	5
Turning your frame on and off	6
Inserting a memory card.....	6
Inserting a USB device.....	7
Copying pictures to your frame	8
2 Viewing pictures	10
Viewing from internal memory.....	10
Viewing from a memory card or USB device.....	10
Searching for and viewing your pictures.....	11
Changing viewing modes	16
Picture Finder—auto-play similar pictures.....	17
Pausing play on a single picture.....	18
Deleting pictures from your frame.....	18
3 Changing settings and more	19
Changing frame settings	19
Settings	20
Setting the time, date, and on/off times.....	22
Setting transitions between pictures	24
Setting viewing modes	25
Upgrading your firmware (recommended).....	26
Changing your frame orientation	27

Hanging your frame on the wall	27
Maintaining your frame	28
Learning more about your frame.....	28
4 Troubleshooting and support	29
Picture frame problems	29
Screen messages.....	30
Re-setting your frame after losing power	31
5 Appendix	32
Digital frame specifications.....	32
Important safety instructions	33
Additional care and maintenance	34
Replacing the remote control battery	34
Limited warranty.....	35
Regulatory compliance and advisory	37

1

Getting started

Welcome to your KODAK EASYSHARE Digital Frame. Viewing and sharing your pictures couldn't be simpler!

Attaching/removing the stand

NOTE: Your frame may have been shipped with the stand already attached.

Attach



Fit the tabs on the back of the stand into the slots on the frame and slide up to lock.

Remove

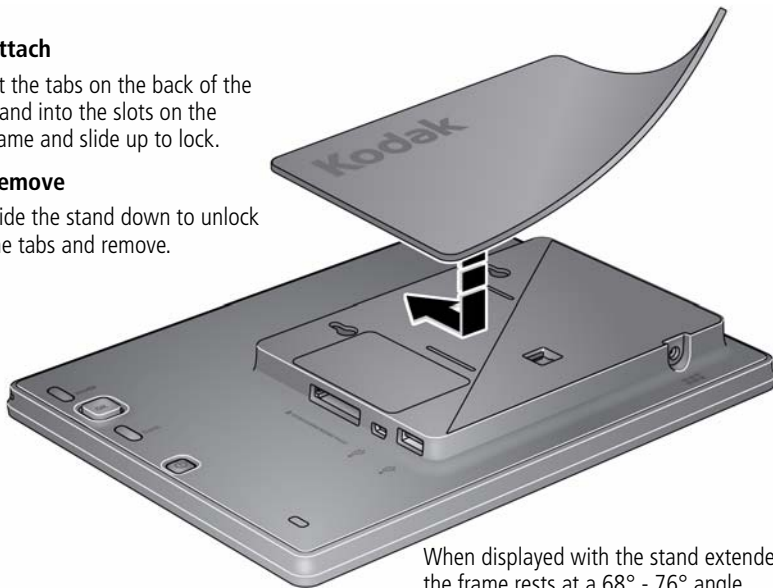
Slide the stand down to unlock the tabs and remove.



When displayed with the stand extended, the frame rests at a 68° - 76° angle.

To change from landscape  to portrait orientation , simply turn the frame on its side, no need to remove the stand.

Attaching the power cable



CAUTION:

Do not use this power cable with other devices, including digital cameras.

If more than one plug is included, use the plug for your type of power outlet.









The frame automatically turns on when you plug it in for the first time.

Navigating with the remote control



Press the button to:

-  Navigate left or view the previous picture
-  Navigate right or view the next picture
-  Navigate up or highlight the previous screen item
-  Navigate down or highlight the next screen item
-  Select or accept the highlighted screen item
-  Navigate to the previous screen
-  Cycle through the available viewing modes

NOTE: The buttons on the remote are also available on the back of the frame and function identically.

Storing the remote control



A magnet holds the remote control to the back of the frame for convenient, out-of-the-way storage.





Setting your language

The language screen appears the first time you turn on your frame.

- Press  to highlight your language, then press **OK**.





To change the language at a later time:

- 1 Press **OK** to pause a slideshow and display the control panel icons.
- 2 Press  to highlight  (Settings), then press **OK**.
- 3 Press  to highlight **Language**, then press **OK**.
- 4 Press  to highlight your language, then press **OK**.

Setting the time, date, and on/off times

The first time you turn on your frame, the Time, Date, and On/Off screens appear automatically after you select your language.

To set the current date and time:

- Press  to change values.
- Press  to move to the next entry.
- When you've entered all the settings, press OK.



For details on setting the 12- or 24-hour clock, current time, date, on/off times, and energy saving activity sensor, see [page 22](#).

Activity sensors—energy saver

The activity sensors turn the frame off if no light or sound is detected in the room; the sensors turn the frame back on when light or sound is detected (this is the default setting).

NOTE: When you first plug in your frame, the activity sensors take about 24 hours to adjust to the typical light and sound levels in your home environment. During the first 24 hours, your frame may turn on and off at unexpected times.

If you prefer, you can turn off the sensors—then turn the frame on and off manually or set daily automatic on/off times. For details, see [page 23](#).

Turning your frame on and off

The frame automatically turns on when it is plugged in for the first time.

-  Power button—to turn the frame on or off, press and hold (for about 2 seconds), then release



Inserting a memory card

- To insert a card, push it firmly into the slot.
- To remove a card, pull it out of the slot.

SD/SDHC (SECURE DIGITAL/SECURE DIGITAL High Capacity)

MMC (MULTIMEDIA Card)

MS (MEMORY STICK)

MS Pro (MEMORY STICK)

XD



Inserting a USB device

- Supported USB devices include a flash drive, card reader, hard drive*, etc.
- USB devices are sold separately.
 - *External hard drives must be self-powered.



Copying pictures to your frame

Copying pictures to your frame's internal memory has never been easier. Each time you insert a memory card or USB device, press **OK** and follow the copy directions.



CAUTION:

Do not remove a card or disconnect a device while copying. Your card, pictures, or device could be damaged.



- 1 Insert a memory card or USB device (flash drive, card reader, hard drive).

The pictures start playing. A copy message appears, "To copy pictures from <inserted source> to the frame's internal memory, press OK."

- 2 Press **OK**.
- 3 Highlight your copy method:

This picture—copy the displayed picture.

All pictures in folder—copy all the pictures in a folder (*folder* represents the folder name, if there are any folders on the inserted card or device).

All pictures in source—copy all of the pictures on the card or USB device (*source* represents the type of card or device that's inserted in the frame).

- 4 Press **OK**.

The slide show plays while pictures are being copied.

NOTE: Copies are automatically resized to a lower resolution (smaller size). Full resolution is unnecessary for viewing and quickly fills up the frame's memory.

Copying from internal memory to a memory card or USB device is not supported.

To copy pictures anytime a slide show is playing, with a card or USB device inserted, press **OK**, highlight  (Copy), and continue with step 3 above.

Copying pictures directly from a computer

Pictures copied from your computer are not resized to a lower resolution on the frame. To save space on your frame, first resize your pictures on your computer (800 x 600 resolution is best).

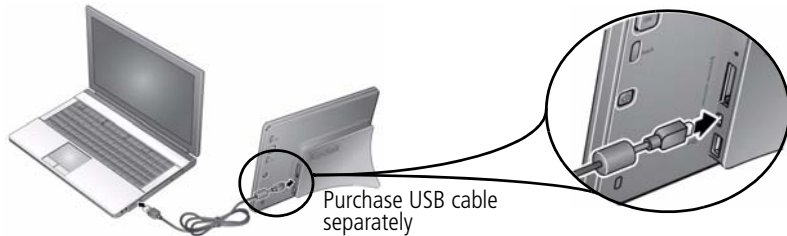

- 1 Connect your frame to the computer with a USB cable (Series mini-B, purchase separately). Your frame appears as a removable USB device on the computer.
- 2 Using your computer operating system, copy or drag pictures to the frame.

NOTE: Your frame does not support copying from the frame to a computer.

Copying pictures from a computer, using memory card

The easiest way to copy a large number of pictures from your computer to your frame's internal memory:

- 1 Insert an empty memory card or USB device into your computer.
- 2 Copy some or all of the pictures from your computer onto the card or USB device.
- 3 Remove the card or USB device from your computer, and insert it into the frame.
- 4 Follow the copy directions on [page 8](#) (highlight All pictures, then press **OK**).

Copying pictures from a digital camera

- 1 Remove the memory card (containing pictures) from your camera, and insert it into the frame.
- 2 Follow the copy directions on [page 8](#).

2

Viewing pictures

View pictures from your frame's internal memory or any connected picture source (memory card, USB device).

- You can change the duration (how long each picture stays on the screen) and transition style between pictures. See [Changing frame settings, page 19](#).

Viewing from internal memory

Pictures play from the frame's internal memory when no card or USB device is inserted.

- Turn on the frame.

All pictures in your frame's internal memory begin to play automatically.

NOTE: Make sure no memory card or USB device is inserted in the frame.

To copy pictures into the frame's internal memory, [see page 8](#).

Viewing from a memory card or USB device

Pictures play from a memory card or USB device whenever one is inserted in the frame.



- Turn on the frame. Insert a memory card, USB flash drive, or other USB device (see [page 6](#)).
Your pictures start playing automatically.
- To copy pictures into the frame's internal memory, press **OK** and follow the screen instructions (see [page 8](#)).

Searching for and viewing your pictures



- 1 Press **OK** to pause a slideshow and display the control panel icons.
- 2 Press **>** to highlight  (Pictures), then press **OK**.

NOTE: The Pictures icon changes to indicate your current picture source (see page ii).



- 3 Press **<>** to highlight the different ways to search for and play your pictures.



All



Date



Folders



Keywords



People



Favorites

All—searching and viewing all pictures

Select  and press **OK**. All of the pictures in the current picture source are displayed as thumbnails.









- 1 Press **▼** to highlight the first thumbnail.
For details on moving through the thumbnails, see [Viewing thumbnails, page 15](#).
- 2 Press **OK** to display the highlighted thumbnail at full-screen.
- 3 Press **OK** again to start the slide show.

Date—searching and viewing by date

Select  and press **OK**. A film strip of the pictures in the current picture source is displayed, organized by date.



- 1 Press  to highlight the current picture in the film strip.
- 2 Press  to navigate through the date strip. To move even faster, press and hold an arrow button.
- 3 To quickly move through many pictures in the film strip, press  to highlight the slider bar. Then press .

4 To search by specific month and year, press  to highlight the date bar. Then press .



5 Press **OK** to display thumbnails of the pictures taken on the date of the selected picture.

For details on moving through the thumbnails, see [Viewing thumbnails, page 15](#).

Folders—searching and viewing by folders

Select  and press **OK**. If there are any folders in the current picture source, they are listed here.



- 1 Press  to highlight the first folder in the list.
- 2 Press  to navigate through the folders. To move even faster, press and hold an arrow button.

A preview slide show plays of the pictures in the highlighted folder.

3 Press **OK** to display thumbnails of the pictures in the folder.



For details on moving through the thumbnails, see [Viewing thumbnails, page 15](#).

- 4 Press **OK** to display the highlighted thumbnail at full-screen.
- 5 Press **OK** again to start the slide show.

Keywords—searching and viewing by keywords

KODAK Digital Cameras (and others) let you tag pictures with keywords. Select  and press **OK**. If there are any pictures tagged with keywords in the current picture source, they are listed here.



- 1 Press  to highlight the first keyword in the list.
- 2 Press  to navigate through the keywords. To move even faster, press and hold an arrow button.
A preview slide show plays of the pictures with the highlighted keywords.

- 3 Press **OK** to display thumbnails of the pictures with that keyword.



For details on moving through the thumbnails, see [Viewing thumbnails, page 15](#).

- 4 Press **OK** to display the highlighted thumbnail at full-screen.
- 5 Press **OK** again to start the slide show.

People—searching and viewing by people

The latest KODAK Digital Cameras let you identify people in your pictures. Select  and press **OK**. If there are any identified people in the current picture source, they are listed here, grouped by person.



- 1 Press  to highlight the first person in the list.
- 2 Press  to navigate through the people. To move even faster, press and hold an arrow button.
A preview picture of the highlighted person is displayed.

- 3 Press **OK** to display thumbnails of pictures of that person.

For details on moving through the thumbnails, see [Viewing thumbnails, page 15](#).

- 4 Press **OK** to display the highlighted thumbnail at full-screen.
- 5 Press **OK** again to start the slide show.

Favorites—searching and viewing favorites

KODAK Digital Cameras let you tag pictures as favorites. Select  and press **OK**. If there are any favorites in the current picture source, they are displayed as thumbnails.





- 1 Press  to highlight the first thumbnail.
For details on moving through the thumbnails, see [Viewing thumbnails, page 15](#).
- 2 Press **OK** to display the highlighted thumbnail at full-screen.
- 3 Press **OK** again to start the slide show.

Viewing thumbnails

View the pictures on your frame as thumbnails when you're searching for pictures (page 11).



- 1 Press  to highlight the first thumbnail.
- 2 Press the arrows to navigate through the thumbnails. To move even faster, press and hold an arrow button.
- 3 To quickly page through the thumbnails, continue to press  to highlight the slider bar. Then press .
- 4 Press **OK** to display the highlighted thumbnail at full-screen.
- 5 Press **OK** again to start the slide show or press the **back** button to return to thumbnails view.

Changing viewing modes

Press the **mode** button to change how you display pictures on your frame.

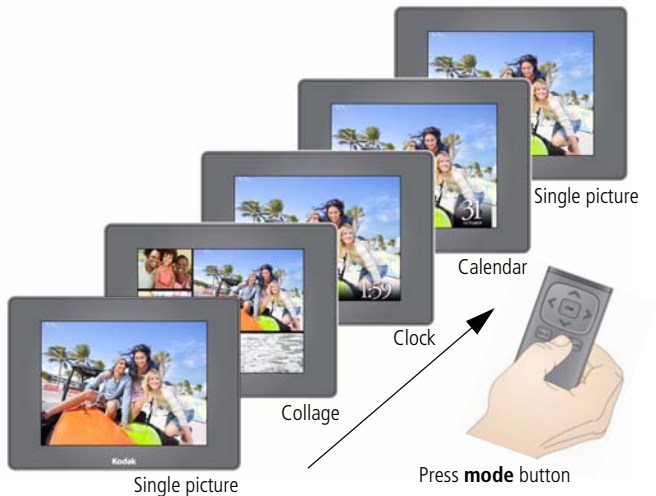



- Each time you press the **mode** button, the frame advances to the next viewing mode.
- Available viewing modes are: single picture, Collage, Clock, and Calendar.
- There are several styles of Clock, Calendar, and Collage modes available. To change the style, highlight the Set Modes icon  from the main control panel. See [Setting viewing modes, page 25](#).

Picture Finder—auto-play similar pictures



Press Picture Finder  to automatically play the pictures that were taken on the same day as the picture on the screen.

Play similar pictures



- 1 While a slide show is playing, press **OK** to pause play and display the main control panel icons.
- 2 Press  to highlight  (Picture Finder), then press **OK**.
Pictures that were taken on the same day as the selected picture begin playing.

Play similar pictures from collage mode

Play similar pictures while in collage mode.

- 1 Press the **mode** button to change to collage mode ([see page 16](#)).
- 2 Press **OK** to pause play and display the main control panel icons.
Picture Finder  is highlighted.
- 3 Press **OK**, then press  to highlight a picture in the collage.
- 4 To highlight a different picture in the collage, press , then press **OK**.
Pictures begin playing that were taken on the same day as the highlighted picture.

Exit Picture Finder

- 1 Press **OK** to pause Picture Finder play and display the main control panel icons.
- 2 Press  to highlight  (Picture Finder), then press **OK**.
Random pictures resume playing.

Pausing play on a single picture



- When a slide show is playing, press **OK**.
The slide show pauses with the picture in view displayed. The main control panel appears with Play highlighted.
- To resume the slide show, press **back** or **OK**.

Deleting pictures from your frame

Delete pictures from your frame's internal memory. Deleting from an inserted memory card or USB device is not supported.



- 1 When a slide show is playing from internal memory, press **OK**.

The main control panel appears.

- 2 Press  to highlight  (Delete), then press **OK**.

- 3 Highlight your delete method:

This picture—delete the displayed picture.

Exit (default)—exit the delete screen without deleting the picture.

All pictures in folder—delete all the pictures in a folder (*folder* represents the folder name, if there are any folders on the frame).

All pictures on frame—delete all of the pictures on the frame.

- 4 Press **OK**.



3

Changing settings and more

Changing frame settings

The options in the Settings menu let you customize and configure your frame.

IMPORTANT: *You may need to keep pressing the up/down arrows  to see the complete list of available options.*

- 1 While a slide show is playing, press **OK** to pause play and display the main control panel icons.
- 2 Press  to highlight  (Settings), then press **OK**.
- 3 Press  to highlight a Setting, then press **OK** to display that setting's options.

Options selected from a list

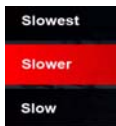

- 4 If the options are displayed in a list (no radio buttons), press  to highlight an option, then press **OK**.

Options selected with radio buttons

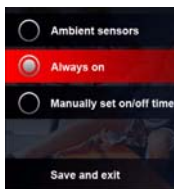

- 5 If the options are selected with radio buttons, highlight your choice, then highlight **Save and exit** and press **OK**.

Settings

To return to the previous screen, press **back** .

Setting	Options
<p>Firmware upgrade This setting is only available if the upgrade file (.img) is present on the frame (on an inserted memory card or flash drive, or copied into internal memory).</p>	<p>Upgrade now—load the latest version of firmware on your frame (see page 26). Exit without upgrading—return to the main menu.</p>
<p>Rotate</p>	<p>90° clockwise (default)—rotate the current picture. Exit—return to slide show without rotating any pictures. 90° counter—rotate the current picture counterclockwise. 180° flip—rotate the current picture.</p>
<p>Time</p>	<p>Set the current time (see page 22).</p>
<p>Date</p>	<p>Set the current date (see page 22).</p>
<p>Time On/Off See Set on/off times, page 23.</p>	<p>Activity sensors (default)—energy saver, the frame turns itself on when it detects light or sound; turns itself off when it detects no light or sound. Always on—the frame is always on. To turn it off, press the Power button or unplug it. Manually set on/off time—set automatic on and off times. Save and exit—highlight, then press OK to save your selections and exit the screen.</p>
<p>Picture Book background</p>	<p>Select a background color or pattern that will be displayed behind your pictures when your frame is in Picture book viewing mode (see page 25).</p>

Setting	Options
Auto enhancements	<p>Red-eye removal—automatically check for red-eye in your pictures and remove it. Default is On.</p> <p>KODAK PERFECT TOUCH Technology—automatically enhance your pictures to look their best on your frame. Default is On.</p> <p>Intelligent zoom and pan—automatically zoom in and center on faces and pan the picture across the screen. Default is On.</p> <p>Fit/Fill—choose how to display pictures: Fit, show the whole picture. Black borders may appear around the image. Fill, the picture fills the entire screen; some of the picture may be cut off (cropped). Default is Fill.</p> <p>Save and exit—highlight, then press OK to save your selections and exit the screen.</p>
<p>Brightness Adjust the screen brightness.</p>	<p>1 (darkest) to 10 (lightest). Change the setting by pressing the arrow  buttons.</p>
<p>Display picture order by Specify the order in which to play your pictures.</p>	<p>Random (default)—play pictures in random order.</p> <p>Oldest to newest—start play with the oldest file date.</p> <p>Newest to oldest—start play with the most recent file date.</p> <p>A - Z—start play alphabetically from A to Z.</p> <p>Z - A—start play alphabetically from Z to A.</p>
Language	Choose your language (see page 4).
About	Check your frame model, serial number, and firmware version.

Setting the time, date, and on/off times

The first time you turn on your frame, the Time, Date, and On/Off screens each appear automatically after you select your language (see page 5).

To change the settings after your frame is set up and running:

1 Press **OK** to pause a slideshow and display the control panel icons.

2 Highlight  (Settings), then press **OK**.

NOTE: Press arrow buttons  to highlight options and change settings.

Set the time



1 Highlight **Time**, then press **OK**.

2 Press  to change time format (12:00 or 24:00 hour clock), hour, minutes and AM/PM.

3 Press  to move to the next entry.

4 Press **OK**.

The Date screen appears.

Set the date



1 Press  to change the date format, month, day, and year.

2 Press  to move to the next entry.

3 Press **OK**.

The On/Off Times screen appears.

Set on/off times

Highlight the option you want, then press **OK** to activate it.

Only one option can be active at a time. For example, if the activity sensors are on and you select **Manually set on/off times**, the activity sensors are deselected.



Activity sensors (default)—energy saver, frame turns on when it detects light (artificial and daylight) or sound, turns off when the room is dark and quiet.

Always on—frame stays on until you press the power button or unplug it.

Manually set on/off time—frame turns itself on and off at the times you specify. See **Manually set auto on/off times**, below.

Manually set auto on/off times

You specify the times you want your frame to automatically turn on and off.



- 1 Press \blacktriangle to change hour, minutes and AM/PM.
- 2 Press \blacktriangleleft to move to the next entry.
- 3 Press **OK** when finished.

Setting transitions between pictures

Choose how long each picture is displayed and a transition style between pictures.

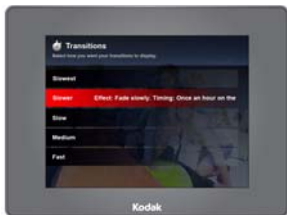

- 1 Press **OK** to pause a slide show and display the control panel icons.
- 2 Press **➤** to highlight  (Transitions), then press **OK**.

- 3 Press **⬅** to highlight a timing and transition option, then press **OK**.

Slowest	pictures change once a day, at midnight; transition effect is a gentle motion to the left.
Slower	pictures change once an hour, on the hour; transition effect is a slow fade.
Slow	pictures change once a minute; transition effect is a slow fade.
Medium 1	pictures change once every 10 seconds; transition effect is pan & zoom.
Medium 2	pictures change once every 10 seconds; transition effect is a slow fade.
Fast	pictures change once every 5 seconds; transition effect is a gentle motion to the left.



Setting viewing modes

There are several styles of clock, calendar, and collage modes available. Preview the available modes and select your choices here.



- 1 While a slide show is playing, press **OK** to pause play and display the main control panel icons.
- 2 Press **>** to highlight  (Set Modes), then press **OK**.



- 3 Press  to highlight a mode.
- 4 With Clock, Calendar, or Collage highlighted, press  to highlight and preview each different style. Leave the highlight on the style you wish to select.

NOTE: Collage styles include Multi-Grid, Single Grid, and Picture Book. You can change the background that is displayed behind Picture Book ([see page 20](#)).

- 5 Press **OK** to exit and save your selections.

Now when you press the mode button ([see page 16](#)), your pictures will be displayed in the style that you've selected.

Upgrading your firmware (recommended)

Firmware is the software that runs on your frame. Download and install the latest version from the Web to keep your frame up to date.

Check your frame's current firmware version

Go to the About screen in the Settings menus (see [Changing frame settings, page 19](#) and [page 21](#)). Note the firmware version on the About screen.

Download the latest firmware

- 1 On your computer, go to www.kodak.com/go/digitalframedownloads.
- 2 Enter your frame model and note the firmware version that's available for download. If it's newer than the version on your frame, follow the screen directions to download the frame firmware to your computer.
- 3 When the firmware is downloaded, copy the IMG file to the root directory (top level, not in a folder or subfolder) of a memory card or USB flash drive.

Upgrade your frame

- 1 Remove the memory card or USB flash drive from your computer, then insert it into the frame.
- 2 Press **OK** to pause the slide show and display the main control panel icons.
- 3 Press **➤** to highlight  (Settings), then press **OK**.
- 4 Highlight **Firmware upgrade**, then press **OK**.

The upgrade may take up to 5 minutes. When the upgrade is complete, your frame automatically restarts.



CAUTION:

Do not turn off the frame or remove the memory card or USB flash drive until the upgrade is complete and the frame has restarted.

Changing your frame orientation

Your frame is set up to display pictures in landscape orientation .

To change the orientation to portrait , simply turn the frame on its side. The picture is automatically displayed in the new orientation.

Turn the frame



Hanging your frame on the wall

To hang your frame on the wall, remove the stand, then use wall anchoring hardware (not included) to securely mount the frame to the wall.

See [Frame features, page i](#) for the location of the mounting holes.

Maintaining your frame

IMPORTANT: *Always disconnect the power before cleaning. Do not use water, cleaning solutions, or other adhesives on the frame or any of its parts.*

Gently wipe the frame and screen with a clean, dry, lint-free cloth. For fingerprints on the frame, apply light pressure.

Learning more about your frame

- www.kodak.com/go/digitalframes Learn more about your frame. Order accessories.
- www.kodak.com/go/digitalframesupport Interactive tutorials
 - Frequently asked questions
 - Downloads
 - Product registration
- www.kodak.com/go/stepbystep Step-by-Step Solutions & Repair

4

Troubleshooting and support

For step-by-step product support, go to www.kodak.com/go/digitalframesupport and select Step-by-Step Solutions & Repair.

Picture frame problems

If...	Try one or more of the following
Frame does not turn on.	<ul style="list-style-type: none">■ Make sure the power cable that was included with your frame is connected securely (see page 2).■ Unplug the power cable for 5 seconds, then reconnect the cable. Press and hold the power button (for about 2 seconds), then release.
Nothing happens when a memory card or USB device is connected.	<ul style="list-style-type: none">■ Insert a certified SD/SDHC/MMC/XD/MS/MS Pro Duo Card, with images, into the card slot, then push to seat it (see page 6).■ Make sure the USB device is connected securely (see page 7).■ Make sure the file format of your pictures and videos are supported. (see page 32).
Remote control doesn't work.	<ul style="list-style-type: none">■ Remove and re-install the battery (see page 34).■ Purchase a new battery (see page 34).
Frame freezes up or doesn't work properly.	<ul style="list-style-type: none">■ Unplug the power cable for 5 seconds, then reconnect the cable. Press and hold the power button (for about 2 seconds), then release.■ Reset the frame. On the back of the frame, press the mode and power buttons (see page i) at the same time. Highlight a reset option, then press OK.<ul style="list-style-type: none">■ Just reset—reset and save all pictures on the frame.■ Reset and delete all pictures—reformat the internal memory and delete all pictures on the frame.■ Return to slide show without doing anything

If...	Try one or more of the following
You set automatic on/off but the frame doesn't turn on and off at the specified times.	If your frame loses power, the clock returns to the factory setting and auto on/off times are disabled. See Re-setting your frame after losing power, page 31 .

Screen messages

Screen message	Try one or more of the following
File is bad. (usually preceded by the file name. For example: <i>xxx_xxxx.JPG file is bad</i>)	The frame cannot display the picture because the file is corrupted or it's an unsupported file format (see page 32). NOTE: Videos are not supported.
Write failed. Select another location.	The frame was unable to copy the picture. ■ Insert a different card or device (page 6).
Error attempting to open file or directory.	■ Turn off the frame, then turn it back on. Press and hold the power button (for about 2 seconds), then release. If the problem persists, contact customer support help, at www.kodak.com/go/digitalframesupport .
Error occurred while closing a file.	
Error invalid filename.	
Error reading from file.	
Error writing from file.	
Error writing a file.	
Error writing to a file.	
File Copy Failed!	
Internal error.	
Parameter is invalid.	
Unknown error.	

Re-setting your frame after losing power

If your frame loses power for an extended period of time (longer than 2 hours), the language, time, date, and on/off times return to the factory default settings.

When the power is restored and the frame turns on, you are prompted to reset language, time, date, and on/off times. See [Setting the time, date, and on/off times, page 5](#).

5

Appendix

Digital frame specifications

For more specifications, go to www.kodak.com/go/digitalframesupport.

KODAK EASYSHARE P750/P850 Digital Frame	
Color display	
P750	17.8 cm (7 in.) diagonal digital LCD, 800 x 600 pixels, 4:3 aspect ratio, 14.2 x 10.6 cm (5.6 x 4.2 in.) viewable area
P850	20.3 cm (8 in.) diagonal digital LCD, 800 x 600 pixels, 4:3 aspect ratio, 16.2 x 12.2 cm (6.3 x 4.8 in.) viewable area
Internal storage capacity (internal memory)	
2 GB (store up to 16,000 pictures)	
Power	
AC adapter	110-240V AC 50/60 Hz AC adapter, 5V DC @ 2 Amp
Battery, remote	Lithium coin type CR2016, Kodak P/N 4H7029
Communication with USB devices	
USB cable High Speed Type A (for connecting a USB device), purchase separately	
USB cable series A to series mini-B (for connecting to a computer), purchase separately	
Other features	
Picture formats	JPEG, EXIF 2.2
Memory cards see page 6	SD, SDHC (SECURE DIGITAL); MMC (MULTIMEDIA Card); MS, MS Pro (MEMORY STICK); XD
Temperature	Operating: 0 to 40° C (32 to 104° F) Storage: -20 to 60° C (-4 to 140° F)

KODAK EASYSHARE P750/P850 Digital Frame	
Size	P750: 14.7 x 19.6 x 2.4 cm (5.8 x 7.7 x 1 in.) P850: 17.1 x 22.8 x 2.5 cm (6.7 x 9 x 1 in.)
Weight	P750: 517 g (1.1 lb.) - includes frame, stand, AC adapter P850: 677 g (1.5 lb.) - includes frame, stand, AC adapter

Important safety instructions



CAUTION:

Do not disassemble this product; there are no user-serviceable parts inside. Refer servicing to qualified service personnel. Do not expose this product to liquid, moisture, or extreme temperatures. The use of controls, adjustments, or procedures other than those specified herein may result in exposure to shock and/or electrical or mechanical hazards. If the LCD breaks, do not touch the glass or liquid. Contact Kodak customer support.

- The use of an accessory that is not recommended by Kodak may cause fire, electric shock, or injury. For approved accessories, go to www.kodak.com/go/accessories.
- Use only the AC adapter that was packaged with your frame. Use of other AC adapters may damage the frame and void your warranties.
- When displayed with the stand extended, the frame rests at a 68 - 76° angle.
- Do not place frame near open flame sources such as lighted candles or heaters.
- When removing the battery from the remote control, allow it to cool; it may be hot.
- Keep batteries out of the reach of children.
- Do not allow batteries to touch metal objects, including coins. Otherwise, a battery may short circuit, discharge energy, become hot, or leak.
- Do not disassemble, install backward, or expose batteries to liquid, moisture, fire, or extreme temperature.

- Remove the battery when the product is stored for an extended period of time. In the unlikely event that battery fluid leaks inside the product, contact Kodak customer support.
- In the unlikely event that battery fluid leaks onto your skin, wash immediately with water and contact your local health provider. For additional health-related information, contact your local Kodak customer support.
- Dispose of batteries according to local and national regulations. Go to www.kodak.com/go/kes.

Additional care and maintenance

- Always disconnect the power before cleaning. Do not use water, cleaning solutions, or other adhesives on the frame or any of its parts. Gently wipe the frame and screen with a clean, dry, lint-free cloth. For fingerprints on the frame, apply light pressure.
- Service agreements are available in some countries. Contact a dealer of KODAK Products for more information.
- For digital frame disposal or recycling information, contact your local authorities. In the US, visit the Electronics Industry Alliance at www.eiae.org or visit www.kodak.com/go/digitalframesupport.

Replacing the remote control battery

Replace the battery with a lithium coin-type CR2015 battery, Kodak part number 4H7032. For proper disposal, go to www.kodak.com/go/kes.

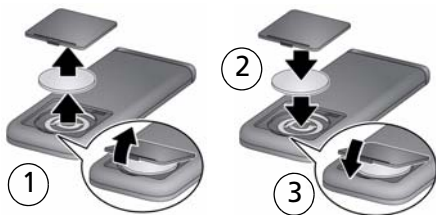

- 1 Remove the battery cover. Remove the old battery.
- 2 Place the new battery in the compartment with the contact side down, printing and + sign up.
- 3 Replace the battery cover. Insert tabs and press the cover down until it clicks into place.

Limited warranty

Kodak warrants KODAK Consumer Electronic Products and Accessories ("Products"), excluding batteries, to be free from malfunctions and defects in both materials and workmanship for one year from the date of purchase. Retain the original dated sales receipt. Proof of the date of purchase will be required with any request for warranty repair.

Limited warranty coverage

Warranty service is only available from within the country where the Products were originally purchased. You may be required to ship Products, at your expense, to the authorized service facility for the country where the Products were purchased. Kodak will repair or replace Products if they fail to function properly during the warranty period, subject to any conditions and/or limitations stated herein. Warranty service will include all labor as well as any necessary adjustments and/or replacement parts. If Kodak is unable to repair or replace a Product, Kodak will, at its option, refund the purchase price paid for the Product provided the Product has been returned to Kodak along with proof of the purchase price paid. Repair, replacement, or refund of the purchase price are the sole remedies under the warranty. If replacement parts are used in making repairs, those parts may be remanufactured, or may contain remanufactured materials. If it is necessary to replace the entire Product, it may be replaced with a remanufactured Product. Remanufactured Products, parts and materials are warranted for the remaining warranty term of the original Product, or 90 days after the date of repair or replacement, whichever is longer.

Limitations

This warranty does not cover circumstances beyond Kodak's control. This warranty does not apply when failure is due to shipping damage, accident, alteration, modification, unauthorized service, misuse, abuse, use with incompatible accessories or attachments (such as third party ink or ink tanks), failure to follow Kodak's operation, maintenance or repacking instructions, failure to use items supplied by Kodak (such as adapters and cables), or claims made after the duration of this warranty. Kodak makes no other express or implied warranty for this product, and

www.kodak.com/go/support

disclaims the implied warranties of merchantability and fitness for a particular purpose. In the event that the exclusion of any implied warranty is ineffective under the law, the duration of the implied warranty will be one year from the purchase date or such longer period as required by law. The option of repair, replacement, or refund is Kodak's only obligation. Kodak will not be responsible for any special, consequential or incidental damages resulting from the sale, purchase, or use of this product regardless of the cause. Liability for any special, consequential or incidental damages (including but not limited to loss of revenue or profit, downtime costs, loss of the use of the equipment, cost of substitute equipment, facilities or services, or claims of your customers for such damages resulting from the purchase, use, or failure of the Product), regardless of cause or for breach of any written or implied warranty is expressly disclaimed.

Your rights

Some states or jurisdictions do not allow exclusion or limitation of incidental or consequential damages, so the above limitation or exclusion may not apply to you. Some states or jurisdictions do not allow limitations on how long an implied warranty lasts, so the above limitation may not apply to you. This warranty gives you specific rights, and you may have other rights which vary from state to state or by jurisdiction.

Outside the United States and Canada

In countries other than the United States and Canada, the terms and conditions of this warranty may be different. Unless a specific Kodak warranty is communicated to the purchaser in writing by a Kodak company, no warranty or liability exists beyond any minimum requirements imposed by law, even though defect, damage, or loss may be by negligence or other act.

Regulatory compliance and advisory

FCC compliance and advisory



This device complies with Part 15 of the FCC Rules. Operation is subject to the following two conditions: (1) this device may not cause harmful interference, and (2) this device must accept any interference received, including interference that may cause undesired operation.

Canadian DOC statement

This Class B digital apparatus complies with Canadian ICES-003.

Cet appareil numérique de la classe B est conforme à la norme NMB-003 du Canada.



Hereby, Eastman Kodak Company declares that this KODAK Product is in compliance with the essential requirements and other relevant provisions of Directive 1999/5/EC.

Waste Electrical and Electronic Equipment labeling



In Europe: For human/environmental protection, it is your responsibility to dispose of this equipment and battery at a collection facility established for this purpose (separate from municipal waste). For more information, contact your retailer, collection facility, or appropriate local authorities; or visit www.kodak.com/go/recycle. (Product weight: P750, 517 g. P850, 677 g.)

Australian C-Tick



Russian GOST-R



Eastman Kodak Company
Rochester, New York 14650

Цифровая фоторамка изготовлена в Китае; остальные элементы - в соответствии с маркировкой

China RoHS

Product Disclosure Table
KODAK Digital Picture Frames
有毒有害物质或元素名称及含量标识表
 table of hazardous substances' name and concentration

部件名称 Component name	有毒有害物质或元素 hazardous substances' name					
	铅 (Pb)	汞 (Hg)	镉 (Cd)	六价铬 (Cr6+)	多溴联苯 (PBB)	多溴二苯醚 (PBDE)
交流变压器电路板元件 AC Adapter circuit board components	x	o	o	o	o	o
数码相架电路板元件 Digital Photo Frame circuit board components	x	o	o	o	o	o
数码相架外壳 Digital Photo Frame Enclosure	o	o	o	o	o	o

○：表示该有毒有害物质在该部件所有均质材料中的含量均在SJ/T 11363-2006规定的限量要求以下。
 ×：表示该有毒有害物质至少在该部件的某一均质材料中的含量超出SJ/T 11363-2006规定的限量要求。
 ○： indicates hazardous substance concentration lower than MCV
 ×： indicates hazardous substance concentration higher than MCV



Battery

ENERGY STAR Product

ENERGY STAR[®] qualified product.

Index

A

- about, frame, 21
- AC adapter, 2, 33
- activity sensors, 23
- all pictures, searching, 11
- appendix, 32
- arrow buttons, 3
- attaching
 - power cable, 2
 - stand, 1
- auto enhancements, setting, 21
- automatic
 - on/off, setting, 23
 - picture finder, 17
- a-z, play alphabetically, 21

B

- back button, 3
- battery
 - disposal, 34
 - replacement type, 32
 - replacing, 34
 - safety information, 33
- brightness, 21
- button, mode, 16
- buttons, i
- buttons, remote control, 3

C

- cable, power, connecting, 2
- calendar, viewing mode, 16
- camera, copying pictures from, 9

- card, memory

- copying from, 9
 - inserting, 6
 - slot, i
 - supported types, 32
 - viewing pictures from, 10

- changing settings, 19—21

- cleaning frame, 28, 34

- clock and on/off times, setting, 5, 22

- clock, resetting after losing power, 31

- clock, viewing mode, 16

- collage mode

- changing styles, 25
 - viewing, 16

- computer, copying pictures from, 9

- control panel icons, ii

- controls, i

- copy pictures, 8, 9

D

- date, searching by, 12

- date, setting, 5, 22

- deleting pictures from frame, 18

- display picture order by, 21

- disposal, recycling, 34

- download firmware, 26

- duration, setting, 24

E

- energy saver, auto on/off, 23

- Energy Star product, 39

- error messages, 30

F

- favorites, searching by, 14
- file formats, picture, 32
- firmware, upgrading, 20, 26
- fit/fill, display, 21
- flash drive
 - inserting, 7
 - viewing pictures from, 10
- folders, searching by, 12
- frame, picture
 - hanging on wall, 27
 - specifications, 32
 - troubleshooting, 29
 - turn on/off, 6

H

- help
 - frame, 29
 - support URLs, 28
 - troubleshooting and support, 29

I

- icons, control panel, ii
- installing
 - flash drive, 7
 - memory cards, 6
 - USB device, 7
- intelligent zoom and pan, 21
- internal memory
 - capacity, 32
 - copying to, 8
 - playing from, 10

K

- keywords, searching by, 13

KODAK PERFECT TOUCH, 21

L

- landscape, change orientation, 27
- language, setting, 4, 21
- light and sound sensors, 23

M

- main control panel, ii
- memory card. See card, memory mode
 - button, i, 3
 - changing, 16
 - setting styles, 25

N

- newest to oldest, display, 21

O

- OK button, 3
- oldest to newest, display, 21
- on/off button, 6
- on/off, energy saver, 23
- order, display by, 21
- orientation, changing, 27

P

- pausing play, 18
- people, searching by, 14
- picture book backgrounds, 20
- picture finder, 17
- pictures
 - copying to frame, 8, 9
 - deleting, 18
 - rotate, 20

- searching, 11—14
- viewing, 10—15
- portrait, change orientation, 27
- power
 - button, i, 6
 - connecting, 2
 - specifications, 32

R

- random display, 21
- recycling, disposal, 34
- red-eye removal, 21
- regulatory compliance, 37
- remote control, 3
- replacing battery, remote control, 34
- reset frame, 29
- reset time after losing power, 31
- rotate pictures, 20

S

- safety information, 33
- screen
 - cleaning, 28, 34
 - error messages, 30
- searching for pictures, 11—14
- set modes icon, 25
- settings, changing, 19—21
 - about
 - auto enhancements
 - brightness
 - date
 - display picture order by
 - firmware upgrade
 - language

- picture book backgrounds
- rotate
- time
- time on/off
- specifications, frame, 32
- stand, attaching, 1
- storage capacity, internal memory, 32
- support, 28

T

- tags, searching by, 13
- thumb drive, 7
- thumbnails, viewing, 15
- time, date, and on/off times, 5, 22
- timer, auto on/off, 23
- transitions, setting, 24
- troubleshooting
 - error messages, 30
 - frame, 29
- turn on frame, 6

U

- upgrade firmware, 20, 26
- USB
 - devices, types, 32
 - inserting, 7

V

- viewing modes
 - changing, 16
 - setting styles, 25
- viewing pictures, 10—15

W

- wall mount, frame, 27

warranty, 35
Web sites, help, 28

Z

z-a, play alphabetically, 21
zoom and pan transition, 21

Free Manuals Download Website

<http://myh66.com>

<http://usermanuals.us>

<http://www.somanuals.com>

<http://www.4manuals.cc>

<http://www.manual-lib.com>

<http://www.404manual.com>

<http://www.luxmanual.com>

<http://aubethermostatmanual.com>

Golf course search by state

<http://golfingnear.com>

Email search by domain

<http://emailbydomain.com>

Auto manuals search

<http://auto.somanuals.com>

TV manuals search

<http://tv.somanuals.com>