

TOTAL SOLUTIONS™





TOTAL SPEAKER SOLUTIONS

TSS-1200
Owner's Guide
(120V)



IMPORTANT SAFETY PRECAUTIONS

Read First!

<h3>CAUTION</h3> <h4>RISK OF ELECTRIC SHOCK</h4> <h4>DO NOT OPEN</h4>
<p>CAUTION: To reduce the risk of electric shock, do not remove cover (or back). No user-serviceable parts inside. Refer servicing to qualified service personnel.</p>
<p>CAUTION: To prevent electric shock, do not use this (polarized) plug with an extension cord, receptacle or other outlet unless the blades can be fully inserted to prevent blade exposure.</p>
<p> The lightning flash with arrowhead symbol, within an equilateral triangle, is intended to alert the user to the presence of uninsulated "dangerous voltage" within the product's enclosure that may be of sufficient magnitude to constitute a risk of electric shock to persons.</p> <p> The exclamation point within an equilateral triangle is intended to alert the user to the presence of important operating and maintenance (servicing) instructions in the literature accompanying the appliance.</p>

1. Read these instructions.
2. Keep these instructions.
3. Heed all warnings.
4. Follow all instructions.
5. Do not use this apparatus near water.
6. Clean only with a dry cloth.
7. Do not block any ventilation openings. Install in accordance with the manufacturer's instructions.
8. Do not install near any heat sources such as radiators, heat registers, stoves or other apparatus (including amplifiers) that produce heat.
9. Do not defeat the safety purpose of the polarized or grounding-type plug. A polarized plug has two blades with one wider than the other. A grounding-type plug has two blades and a third grounding prong. The wide blade or the third prong are provided for your safety. If the provided plug does not fit into your outlet, consult an electrician for replacement of the obsolete outlet.
10. Protect the power cord from being walked on or pinched, particularly at plugs, convenience receptacles and the point where they exit from the apparatus.
11. Only use attachments/accessories specified by the manufacturer.
12. Use only with the cart, stand, tripod, bracket or table specified by the manufacturer or sold with the apparatus. When a cart is used, use caution when moving the cart/apparatus combination to avoid injury from tip-over.



13. Unplug this apparatus during lightning storms or when unused for long periods of time.
14. Refer all servicing to qualified service personnel. Servicing is required when the apparatus has been damaged in any way, such as power-supply cord or plug is damaged, liquid has been spilled or objects have fallen into the apparatus, the apparatus has been exposed to rain or moisture, does not operate normally, or has been dropped.
15. Do not use attachments not recommended by the product manufacturer, as they may cause hazards.
16. This product should be operated only from the type of power source indicated on the marking label. If you are not sure of the type of power supply to your home, consult your product dealer or local power company. For products intended to operate from battery power, or other sources, refer to the operating instructions.
17. If an outside antenna or cable system is connected to the product, be sure the antenna or cable system is grounded so as to provide some protection against voltage surges and built-up static charges. Article 810 of the National Electrical Code, ANSI/NFPA 70, provides information with regard to proper grounding of the mast and supporting structure, grounding of the lead-in wire to an antenna discharge unit, size of grounding conductors, location of antenna-discharge unit, connection to grounding electrodes, and requirements for the grounding electrode. See Figure A.
18. An outside antenna system should not be located in the vicinity of overhead power lines or other electric light or power circuits, or where it can fall into such power lines or circuits. When installing an outside antenna system, extreme

- care should be taken to keep from touching such power lines or circuits, as contact with them might be fatal.
19. Do not overload wall outlets, extension cords, or integral convenience receptacles, as this can result in a risk of fire or electric shock.
 20. Never push objects of any kind into this product through openings, as they may touch dangerous voltage points or short-out parts that could result in a fire or electric shock. Never spill liquid of any kind on the product.
 21. The apparatus shall not be exposed to dripping or splashing, and no objects filled with liquids, such as vases, shall be placed on the apparatus.
 22. Do not attempt to service this product yourself, as opening or removing covers may expose you to dangerous voltage or other hazards. Refer all servicing to qualified service personnel.
 23. When replacement parts are required, be sure the service technician has used replacement parts specified by the manufacturer or that have the same characteristics as the original part.
 24. Upon completion of any service or repairs to this product, ask the service technician to perform safety checks to determine that the product is in proper operating condition.
 25. The product should be mounted to a wall or ceiling only as recommended by the manufacturer.

Figure A.
Example of Antenna Grounding as per
National Electrical Code ANSI/NFPA 70

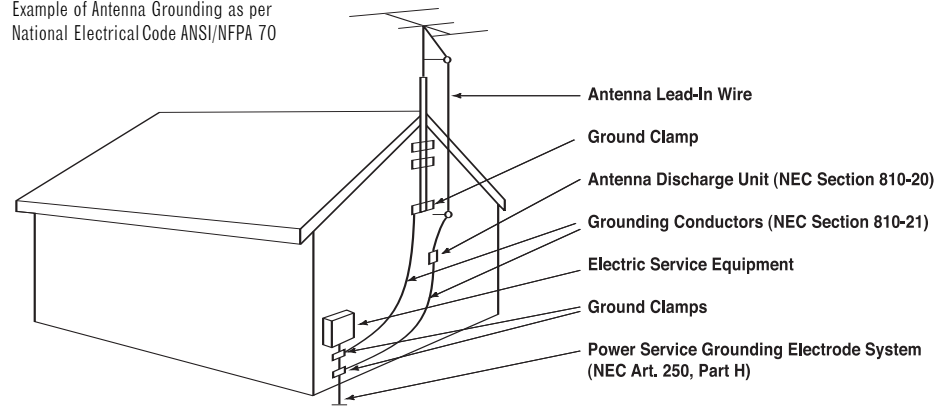

TSS-1200 OWNER'S GUIDE

Table of Contents

2	Important Safety Precautions
4	Introduction
4	Unpacking the System
4	Planning Your System
5	Placement
5	Wall-Mounting the Satellites and Center Channel
7	Center and Satellite Speaker Connections
8	Subwoofer Controls
9	Subwoofer Connections
10	Operation
10	Maintenance and Service
11	Specifications

INTRODUCTION

Infinity Total Solutions™

Infinity Total Solutions continues Infinity's longstanding commitment to accurate sound reproduction. Our proprietary Metal Matrix Diaphragm™ (MMD®) drivers, precision dividing networks and rigid, well-braced enclosures combine to deliver uncompromised performance in any stereo or multichannel home theater system. In addition, these speakers, except for the powered subwoofer, are magnetically shielded for safe placement adjacent to a television.

UNPACKING THE SYSTEM

Carefully unpack the system. If you suspect damage from transit, report it immediately to your dealer and/or delivery service. Keep the shipping carton and packing materials for future use. Open the package and verify the following contents:

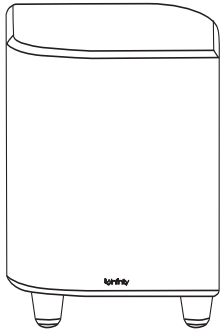

- Wire package, containing:
- (2) 40' (12m) speaker wires
- (3) 20' (6m) speaker wires
- (1) 15' (4.6m) subwoofer cable

(1) Subwoofer



(1) Center with base

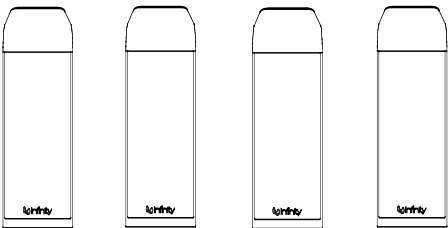

(4) Satellite speakers

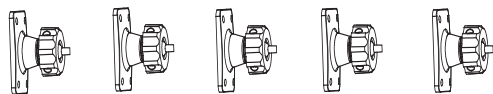

(5) Adjustable wall brackets for satellites and center channel

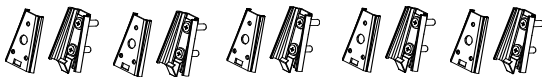

(5) Wall brackets for satellites and center channel

PLANNING YOUR SYSTEM

Before deciding where to best place your speakers, survey your room and study Figures 1 and 2.

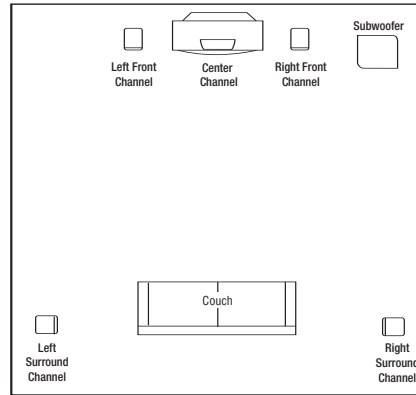

Figure 1. In this overhead view of a typical installation, satellite speakers are used to reproduce sound for the front and surround channels. The center channel reproduces sound and dialogue. The powered subwoofer provides bass for effects and music.

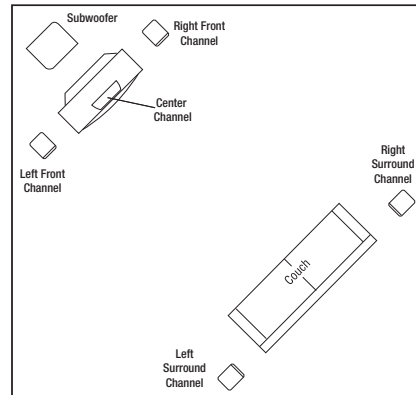

Figure 2. This figure shows an alternative layout, which may be more suitable for some rooms.

PLACEMENT

Left and Right Front Channels

For left and right front channels, place one satellite to the left and another to the right of the television, as shown in Figure 1. Since the speakers are magnetically shielded, you can place them very close to the TV without worrying about the magnetic field distorting the picture.

Center Channel

For the center channel, place the speaker directly on top of, or below, your television. Use a shelf or one of the included wall brackets if the television does not provide a stable platform.

Surround Channels

For left and right surround channels, place one speaker on the left and another on the right, to the side of or slightly behind the listening area. The surround speakers should be mounted at a height of between 5 ft. (1.5m) and 7 ft. (2m).

Subwoofer

Since the installation of a subwoofer can be somewhat more complicated than installing full-range speakers, it is essential that you read this section very carefully prior to connecting the subwoofer to your system. Should you have questions relating to installation, it is advisable to call either your dealer or Infinity's Customer Service Department for advice.

The performance of the subwoofer is directly related to its placement in the listening room and how you align the subwoofer with the satellite speakers. Setting the volume of the subwoofer in relation to the left and right speakers is also of critical importance because it is essential that the subwoofer integrate smoothly with the entire system. Setting the subwoofer's volume level too high will result in an overpowering, boomy bass. Setting the volume level too low will negate the benefits of the subwoofer.

Here are several additional facts on installation that may prove useful. It is generally believed that low frequencies (below 125Hz) are nondirectional and, therefore, placement of a subwoofer within any listening room is not critical. While in theory it is true that the larger wavelengths of extremely low frequencies are basically nondirectional, the fact is that, when installing a subwoofer within the limited confines of a room, reflections, standing waves and absorptions generated within the room will strongly influence the performance of any subwoofer system. As a result, specific location of the subwoofer becomes important, and we strongly recommend that you experiment with placement before choosing a final location. Placement will depend upon your room (for example, whether or not your room permits placement of the subwoofer near either satellite) and the amount and quality of bass required.

Mounting on Floor Stands

Optional TSS-STAND1200 floor stands are available, should you prefer to place your TSS-1200 satellites on the floor; see your dealer or visit www.infinitysystems.com for more information. In addition, there is a 1/4"-20 insert in each satellite that allows the satellite to be mounted to many third-party floor stands. Unscrew the rear foot to reveal the insert.

WALL-MOUNTING THE SATELLITES AND CENTER CHANNEL

The TSS-1200 satellites and center channel are designed to also be mounted on the wall. There is a fixed-mount wall bracket and an adjustable wall bracket provided for each satellite and the center channel. Each speaker bracket will require up to four 1-1/2" #10 wood screws; each screw should be fastened to a wall stud. If a wall stud is unavailable, install an anchor appropriate for a 1-1/2" #10 screw.

IMPORTANT SAFETY NOTE: The customer is solely responsible for proper selection of mounting hardware not included with the speakers, and for proper assembly and installation of the wall brackets, including but not limited to the selection of appropriate weight-bearing supports and proper use of the bracket. Infinity disclaims any liability for the selection of mounting hardware and/or bracket installation. Be sure to follow these bracket assembly and installation instructions carefully. If you have any questions or doubts about your ability to correctly wall-mount the speakers, consult with your authorized Infinity dealer or custom installer.

Fixed-Mount Wall Bracket

Step 1. Remove the rear foot by loosening the screw on the bottom of the satellite.

Step 2. Mark the positions on the wall where you would like to place the mounting screws.

Step 3. Attach the back plate of the bracket to the wall using three screws (not included).

Step 4. Attach the front plate (with the spring tab) of the bracket to the satellite or center channel using the two provided screws.

Step 5. Slide the satellite or center channel speaker with attached bracket front plate onto the back plate of the bracket until the tab locks into place.

To remove speaker from the wall, simply push in the locking tab and slide the speaker up.

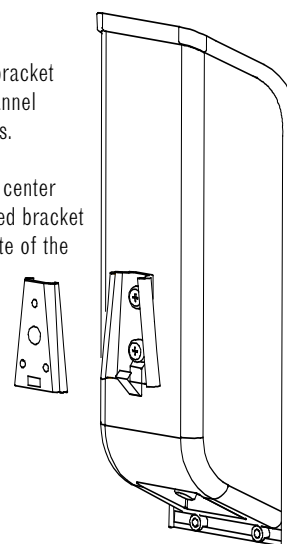

Adjustable Wall Bracket

Step 1. Remove the rear foot by loosening the screw on the bottom of the satellite.

Step 2. Mark the positions on the wall where you would like to place the mounting screws.

Step 3. Place bracket against the wall and fasten four 1-1/2" #10 wood screws through the bracket's screw holes into the wall. If a wall stud is not available, use an appropriate anchor.

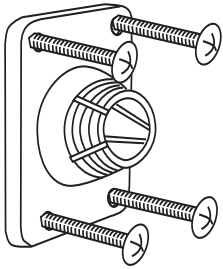

Step 4. Unscrew round collar (C) from bracket (A).

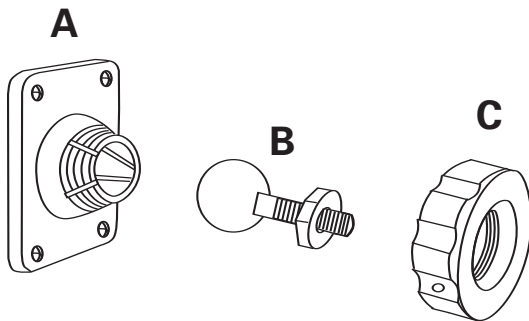

Step 5. Screw the ball and shaft assembly (B) to the lower 1/4"-20 insert on the rear of the satellite, or the upper insert on the rear of the center channel, until it is fully seated. Back out 1/2 of a turn and tighten the nut against the speaker. Securely tightening this nut against the speaker enclosure is very important; otherwise, performing Step 7 may dislodge the threaded insert on the speaker enclosure, rendering it unusable.

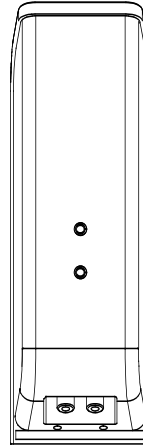

Step 6. Attach speaker wire as shown on page 7.

Step 7. Drop round collar (C) over ball and shaft assembly (B) that is mounted to the speaker with the finished side of the collar facing the rear of the speaker.

Step 8. Carefully push the ball straight into the socket mounted on the wall, angle the speaker as desired and tighten the collar using the enclosed metal bar.

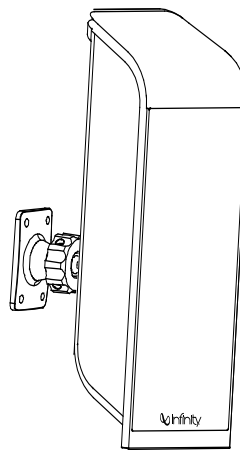

Figure 3. Bracket on wall.

CENTER AND SATELLITE SPEAKER CONNECTIONS

Turn Off All Power

After placing the speakers, you are ready to connect your system. First, turn off all audio-system power. Use high-quality speaker wire to make your connections. #18-gauge speaker wire with polarity coding is included. For longer distances, #16-gauge or heavier wire is recommended. The side of the wire with a ridge or other coding is usually considered positive polarity (i.e., +). Also, consult the owner's manuals that were included with your amplifier or receiver to confirm connection procedures.

Satellites

Observe polarities when making speaker connections, as shown in Figure 4. Connect each + terminal on the back of the amplifier or receiver to the respective + (red) terminal on each speaker. Connect the – (black) terminals in the same way.

Important!

Do not reverse polarities (i.e., + to –, or – to +) when making connections. Doing so will cause poor imaging and diminished bass response. Be certain that positive and negative wire strands are completely isolated to avoid short circuits that may damage your equipment.

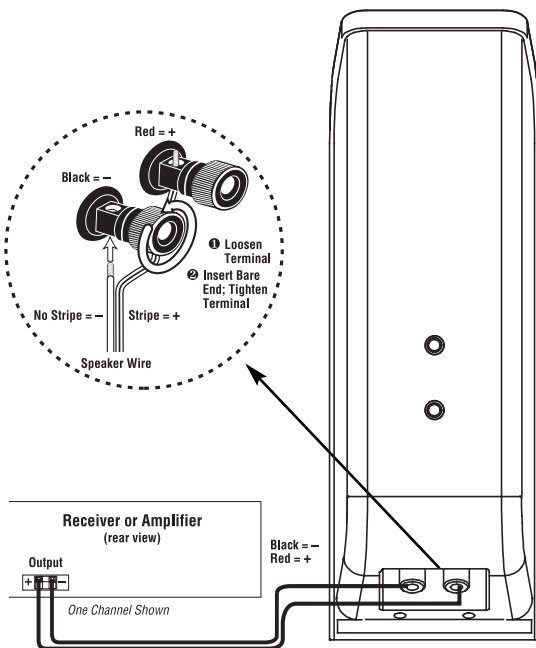

Figure 4. Wiring diagram shows polarity connections for one channel of a home theater system (rear foot not shown for clarity).

Center Channel

Observe polarities when making speaker connections, as shown in Figure 5. Connect each + terminal on the back of the amplifier or receiver to the respective + (red) terminal on the speaker. Connect the – (black) terminals in the same way.

Important!

Do not reverse polarities (i.e., + to –, or – to +) when making connections. Be certain that positive and negative wire strands are completely isolated to avoid short circuits that may damage your equipment.

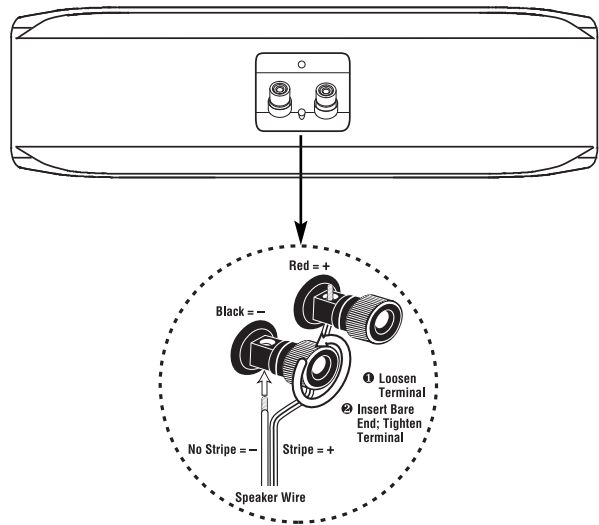
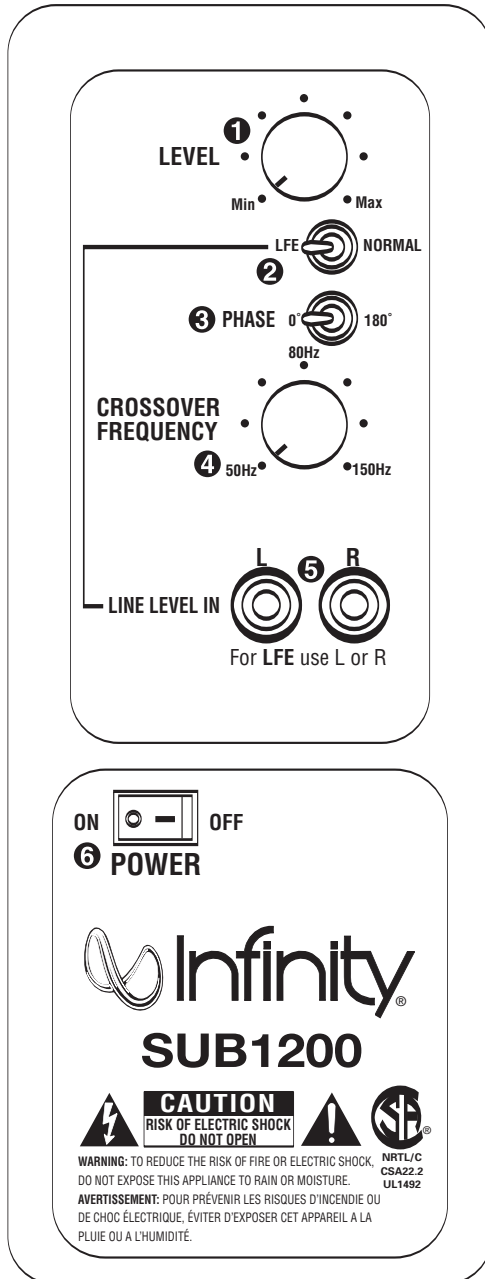

Figure 5. The satellites and center channel speaker feature terminals that can be connected in several different ways – e.g., spade terminals and direct wiring (as shown here).

SUBWOOFER CONTROLS

Rear Panel



- 1 Subwoofer-Level Control
- 2 LFE/Normal Switch
- 3 Phase Switch
- 4 Crossover-Frequency Control
- 5 Line-Level (LFE) Inputs
- 6 Power Switch

A Few Suggestions

We recommend that you do not operate your speakers or subwoofer with the bass, treble and loudness controls set to full boost. This will place undue strain on your electronics and speakers and could damage them.

The volume control setting on your processor/preamp or receiver is not a specific indication of the overall loudness level of the speakers. The only important consideration is the loudness level at which the system can be played, regardless of where the volume control is set.

Always turn down the volume control setting on your processor/preamp or receiver when changing a cassette or CD, or switching inputs to AM or FM operation. Excessively loud transients (clicks or popping sounds) can damage the satellite speakers and possibly the subwoofer.

Important!

Whenever changing cables, pulling plugs, etc., ALWAYS TURN OFF ALL EQUIPMENT, including the subwoofer.

SUBWOOFER CONNECTIONS

If you have a Dolby® Digital or DTS® receiver/processor with a low-frequency-effects (LFE) or subwoofer output:

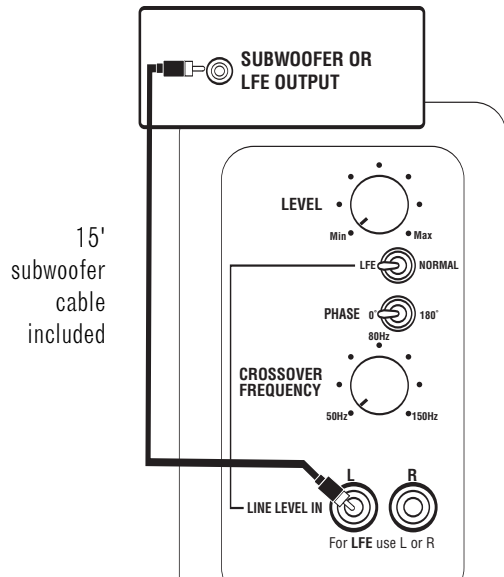

Set line-level/LFE switch to "LFE."

If your receiver/processor does not contain a Dolby Digital or DTS processor but has a subwoofer output:

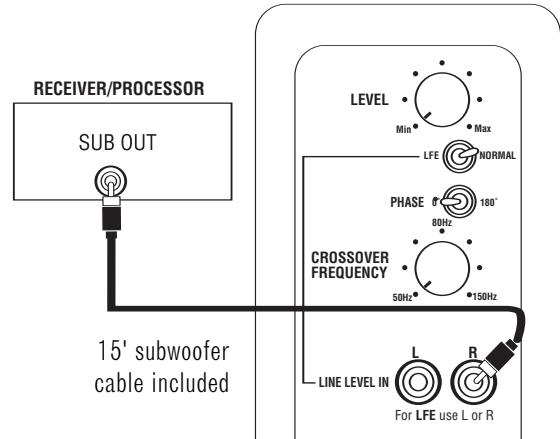

Set line-level/LFE switch to "Normal."

NOTE: If your receiver/processor has only one sub out, you may use either the L or R input.

OPERATION

Surround Modes

When using the system in a Dolby Digital or DTS home theater system, make sure all speakers are set to "Small". When using the TSS-1200 in a Dolby Pro Logic® home theater system, make sure the receiver's center channel mode is set to "Normal."

Some Dolby Digital-equipped receivers/processors offer different setup options for each source or surround mode (e.g., CD-stereo, videotape, Dolby, Pro Logic). In each case, follow your equipment's instructions to ensure that the subwoofer output is turned on and that the speakers are set to "Small" in each mode.

Power On

Plug your subwoofer's AC cord into a wall outlet. Do not use the outlets on the back of the receiver.

Initially set the Subwoofer-Level Control ❶ to the "Min" position.

Turn on the subwoofer by pressing the Power Switch ❷ on the rear panel.

Turn on your entire audio system and start a CD or movie soundtrack at a moderate level.

Auto On/Stand-By

The subwoofer will automatically enter the Stand-By mode after approximately 10 minutes when no signal is detected from your system. The subwoofer will then power on instantly when a signal is detected. During periods of normal use, the Power Switch ❷ can be left on. You may turn off the Power Switch ❷ for extended periods of nonoperation, e.g., when you are away on vacation.

Adjust Level

Turn the Subwoofer-Level Control ❶ up about halfway. If no sound emanates from the subwoofer, check the AC-line cord and input cables. Are the connectors on the cables making proper contact? Is the AC plug connected to a "live" receptacle? Has the Power Switch ❷ been pressed to the "On" position? Once you have confirmed that the subwoofer is active, proceed by playing a CD or DVD. Use a selection that has ample bass information.

Set the overall volume control of the receiver/processor to a comfortable level. Adjust the Subwoofer-Level Control ❶ until you obtain a pleasing blend of bass. Bass response should not overpower the room but rather be adjusted so there is a harmonious blend across the entire musical range. Many users have a tendency to set the subwoofer volume too loud, adhering to the belief that a subwoofer is there to produce lots of bass. This is not entirely true. A subwoofer is there to enhance bass, extending the response of the entire system so the bass can be felt as well as heard. However, overall balance must be maintained or the music will not sound natural. An experienced listener will set the volume of the subwoofer so its impact on bass response is always there but never obtrusive.

Crossover Adjustment

The Crossover-Frequency Control ❹ determines the highest frequency at which the subwoofer reproduces sounds. For the TSS-1200, it is recommended that this control be set at 120Hz (approximately the 3 o'clock position).

NOTE: This control will have no effect if the LFE/Normal Switch ❸ is set to "LFE." If you have a Dolby Digital or DTS receiver/processor, the low-pass frequency is set by the receiver/processor. Set the LFE/Normal Switch ❸ on the subwoofer to "LFE." Consult your owner's manual to learn how to view or change this setting. A setting of 120Hz – 150Hz is recommended.

Phase Control

The Phase Switch ❸ determines whether the subwoofer speaker's piston-like action moves in and out with the main speakers, 0°, or opposite the main speakers, 180°. Proper phase adjustment depends on several variables such as room size, subwoofer placement and listener position. Adjust the Phase Switch ❸ to maximize bass output at the listening position.

Final Positioning

After correctly connecting the TSS-1200 system and verifying that both the subwoofer and all satellite speakers are playing, it is time to optimize the system for your particular listening room. Earlier, you placed the subwoofer in its general location. Finding the exact location for optimum performance sometimes only involves moving the speakers up to a few inches in any direction. We urge you, therefore, to experiment with placement, if possible, until your speakers deliver their full potential.

MAINTENANCE AND SERVICE

The satellite and subwoofer enclosures may be cleaned using a soft cloth to remove fingerprints or to wipe off dust.

All wiring connections should be inspected and cleaned or remade periodically. The frequency of maintenance depends on the metals involved in the connections, atmospheric conditions and other factors, but once per year is the minimum.

If a problem occurs, make sure that all connections are properly made and clean. If a problem exists in one loudspeaker, reverse the connection wires to the left and right system. If the problem remains in the same speaker, then the fault is with the loudspeaker. If the problem appears in the opposite speaker, the cause is in another component or cable. In the event that your TSS-1200 ever needs service, contact your local Infinity dealer or distributor or www.infinitysystems.com for a service center near you.

SPECIFICATIONS

TSS-1200

	Satellites	Center Channel
Frequency Range:	120Hz – 20,000Hz (± 3 dB)	120Hz – 20,000Hz (± 3 dB)
Recommended Amplifier Power Range:	10 – 125 Watts	10 – 125 Watts
Sensitivity: (2.83V @ 1 meter)	89dB	89dB
Nominal Impedance:	8 Ohms	8 Ohms
Crossover Frequency:	3,500Hz, 24dB/Octave	3,500Hz, 24dB/Octave
Midrange Drivers:	Dual 3-1/2" (89mm) MMD, [®] magnetically shielded	Dual 3-1/2" (89mm) MMD, [®] magnetically shielded
High-Frequency Driver:	3/4" (19mm) MMD, [®] magnetically shielded	3/4" (19mm) MMD, [®] magnetically shielded
Dimensions (H x W x D):	12-15/16" x 3-15/16" x 3" (329mm x 100mm x 76mm)	3-15/16" x 13-3/16" x 3" (100mm x 335mm x 76mm)
Weight:	3.9 lb (1.8kg)	3.9 lb (1.8kg)

	Powered Subwoofer
Frequency Range:	29Hz – 150Hz (± 3 dB)
Amplifier Output:	250 Watts RMS 500 Watts peak
Low-Frequency Driver:	12" (305mm)
Crossover Frequency:	50Hz – 150Hz, 24dB/Octave, continuously variable
Dimensions (H x W x D):	18-1/2" x 12-3/4" x 18-1/2" (470mm x 324mm x 470mm)
Weight:	44 lb (20kg)

Infinity continually strives to update and improve existing products, as well as create new ones. The specifications and construction details in this and related Infinity publications are therefore subject to change without notice.



TECHNOLOGY • PERFORMANCE • DESIGN

© 2006 Harman International Industries, Incorporated. All rights reserved.

Infinity Systems, 250 Crossways Park Drive, Woodbury, NY 11797 USA www.infinitysystems.com

Infinity, Harman International and MMD are registered trademarks, and Total Solutions and Metal Matrix Diaphragm are trademarks, of Harman International Industries, Incorporated.

Dolby and Pro Logic are registered trademarks of Dolby Laboratories.

DTS is a registered trademark of DTS, Inc.

Part No. 406-000-05483-1E 8/06

H A Harman International Company

Free Manuals Download Website

<http://myh66.com>

<http://usermanuals.us>

<http://www.somanuals.com>

<http://www.4manuals.cc>

<http://www.manual-lib.com>

<http://www.404manual.com>

<http://www.luxmanual.com>

<http://aubethermostatmanual.com>

Golf course search by state

<http://golfingnear.com>

Email search by domain

<http://emailbydomain.com>

Auto manuals search

<http://auto.somanuals.com>

TV manuals search

<http://tv.somanuals.com>