



INTERMEZZO™ 3.5C

Owner's Guide



CAUTION

RISK OF ELECTRIC SHOCK DO NOT OPEN

WARNING: SHOCK HAZARD, DO NOT OPEN.
AVIS: RISQUE DE CHOC ELECTRIQUE – NE PAS OUVRIR.
CUIDADO: PELIGRO DE CHOQUE ELÉCTRICO – NO ABRIR.

**CAUTION: TO REDUCE THE RISK OF ELECTRIC SHOCK
DO NOT REMOVE COVER (OR BACK)
NO USER SERVICEABLE PARTS INSIDE
REFER SERVICING TO QUALIFIED PERSONNEL**

THIS INFINITY PRODUCT IS DESIGNED FOR 120-VOLT USE ONLY! FOR DETAILED SAFETY PRECAUTIONS, PLEASE SEE FOLLOWING PAGE IN THIS OWNER'S MANUAL FOR "IMPORTANT SAFETY INSTRUCTIONS."

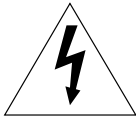

The lightning flash with arrowhead symbol, within an equilateral triangle, is intended to alert the user to the presence of uninsulated "dangerous voltage" within the product's enclosure that may be of sufficient magnitude to constitute a risk of electric shock to persons.



The exclamation point within an equilateral triangle is intended to alert the user to the presence of important operating and maintenance (servicing) instructions in the literature accompanying the product.



L'éclair avec le symbole de la flèche, placé dans les limites d'un triangle équilatéral est prévu pour avertir l'utilisateur de la présence de "tension dangereuse" non isolée dans l'enceinte du produit qui pourrait être d'une importance suffisante pour présenter un risque d'électrocution aux personnes.



Le point d'exclamation dans un triangle équilatéral est prévu pour avertir l'utilisateur de la présence d'instructions importantes pour les opérations et l'entretien (service) dans les manuels fournis avec l'appareil.

ATTENTION: POUR EVITER LES CHOCS ELECTRIQUES, INTRODUIRE LA LAME LA PLUS LARGE DE LA FICHE DANS LA BORNE CORRESPONDANTE DE LA PRISE ET POUSSER JUSQU'AU FOND.



Este destello luminoso con un símbolo de punta de flecha dentro de un triángulo equilátero tiene el objetivo de alertar al usuario sobre la presencia de "voltaje peligroso" no aislado dentro de la caja del producto que puede ser de magnitud lo suficientemente grande para constituir un riesgo de choque eléctrico para las personas.



Este punto de exclamación dentro de un triángulo equilátero tiene el objetivo de alertar al usuario sobre la existencia de instrucciones operativas y de mantenimiento (servicio) importantes en la literatura que acompaña el aparato.

CUIDADO: PARA REDUCIR EL RIESGO DE CHOQUE ELÉCTRICO, NO RETIRE LA CUBIERTA (O RESPALDO). DENTRO NO HAY PEIZAS A LAS QUE EL USUARIO PUEDE DAR SERVICIO. REMITA EL SERVICIO AL PERSONAL DE SERVICIO CALIFICADO.

IMPORTANT SAFETY PRECAUTIONS

Read First!

CAUTION

**RISK OF ELECTRIC SHOCK
DO NOT OPEN**



The lightning flash with arrowhead symbol within an equilateral triangle is intended to alert the user to the presence of uninsulated "dangerous voltage" within the product's enclosure that may be of sufficient magnitude to constitute a risk of electric shock to persons.



The exclamation point within an equilateral triangle is intended to alert the user to the presence of important operating and maintenance (servicing) instructions in the literature accompanying the appliance.

1. **Read Instructions.** All the safety and operating instructions should be read before the product is operated.
2. **Retain Instructions.** The safety and operating instructions should be retained for future reference.
3. **Heed Warnings.** All warnings on the product and in the operating instructions should be adhered to.
4. **Follow Instructions.** All operating and use instructions should be followed.
5. **Cleaning.** Unplug this product from the wall outlet before cleaning. Do not use liquid cleaners or aerosol cleaners. Use a damp cloth for cleaning.
6. **Attachments.** Do not use attachments not recommended by the product manufacturer, as they may cause hazards.
7. **Water and Moisture.** To reduce the risk of fire or electric shock, do not use this product outdoors or near water—for example, near a bathtub, wash bowl, kitchen sink or laundry tub; in a wet basement; near a swimming pool; or the like.
8. **Accessories.** Do not place this product on an unstable cart, stand, tripod, bracket or table. The product may fall, causing serious injury to a child or adult, and serious damage to the product. Use only with a cart, stand, tripod, bracket or table recommended by the manufacturer, or sold with the product. Any mounting of the product should follow the manufacturer's instructions, and should use a mounting accessory recommended by the manufacturer.
9. **A Product and Cart Combination Should Be Moved with Care.** Quick stops, excessive force and uneven surfaces may cause the product and cart combination to overturn. 
10. **Ventilation.** Slots and openings in the cabinet are provided for ventilation and to ensure reliable operation of the product and to protect it from overheating, and these openings must not be blocked or covered. The openings should never be blocked by placing the product on a bed, sofa, rug or other similar surface. This product should not be placed in a built-in installation, such as a bookcase or rack, unless proper ventilation is provided or the manufacturer's instructions have been adhered to.

11. **Power Sources.** This product should be operated only from the type of power source indicated on the marking label. If you are not sure of the type of power supply to your home, consult your product dealer or local power company. For products intended to operate from battery power, or other sources, refer to the operating instructions.
12. **Grounding or Polarization.** This product may be equipped with a polarized alternating-current-line plug (a plug having one blade wider than the other). This plug will fit into the power outlet only one way. This is a safety feature. If you are unable to insert the plug fully into the outlet, try reversing the plug. If the plug should still fail to fit, contact your electrician to replace your obsolete outlet. Do not defeat the safety purpose of the polarized plug.
13. **Power-Cord Protection.** Power-supply cords should be routed so that they are not likely to be walked on or pinched by items placed upon or against them, paying particular attention to cords at plugs, convenience receptacles, and the point where they exit from the product.
14. **Nonuse Periods.** The power cord of the product should be unplugged from the outlet when left unused for long periods of time.
15. **Outdoor Antenna Grounding.** If an outside antenna or cable system is connected to the product, be sure the antenna or cable system is grounded so as to provide some protection against voltage surges and built-up static charges. Article 810 of the National Electrical Code, ANSI/NFPA 70, provides information with regard to proper grounding of the mast and supporting structure, grounding of the lead-in wire to an antenna discharge unit, size of grounding conductors, location of antenna-discharge unit, connection to grounding electrodes, and requirements for the grounding electrode. See Figure A.
16. **Lightning.** For added protection for this product during a lightning storm, or when it is left unattended and unused for long periods of time, unplug it from the wall outlet and disconnect the antenna or cable system. This will prevent damage to the product due to lightning and power-line surges.
17. **Power Lines.** An outside antenna system should not be located in the vicinity of overhead power lines or other electric light or power circuits, or where it can fall into such power lines or circuits. When installing an outside antenna system, extreme care should be taken to keep from touching such power lines or circuits, as contact with them might be fatal.

18. **Overloading.** Do not overload wall outlets, extension cords, or integral convenience receptacles, as this can result in a risk of fire or electric shock.
19. **Object and Liquid Entry.** Never push objects of any kind into this product through openings, as they may touch dangerous voltage points or short-out parts that could result in a fire or electric shock. Never spill liquid of any kind on the product.
20. **Servicing.** Do not attempt to service this product yourself, as opening or removing covers may expose you to dangerous voltage or other hazards. Refer all servicing to qualified service personnel.
21. **Damage Requiring Service.** Unplug this product from the wall outlet and refer servicing to qualified service personnel under the following conditions:
 - a. The power-supply cord or the plug has been damaged; or
 - b. Objects have fallen onto, or liquid has been spilled into, the product; or
 - c. The product has been exposed to rain or water; or
 - d. The product does not operate normally when following the operating instructions. Adjust only those controls that are covered by the operating instructions, as an improper adjustment of other controls may result in damage and will often require extensive work by a qualified technician to restore the product to its normal operation; or
 - e. The product has been dropped or damaged in any way; or
 - f. The product exhibits a distinct change in performance; this indicates a need for service.
22. **Replacement Parts.** When replacement parts are required, be sure the service technician has used replacement parts specified by the manufacturer or that have the same characteristics as the original part. Unauthorized substitutions may result in fire, electric shock or other hazards.
23. **Safety Check.** Upon completion of any service or repairs to this product, ask the service technician to perform safety checks to determine that the product is in proper operating condition.
24. **Wall or Ceiling Mounting.** The product should be mounted to a wall or ceiling only as recommended by the manufacturer.
25. **Heat.** The product should be situated away from heat sources such as radiators, heat registers, stoves or other products (including amplifiers) that produce heat.

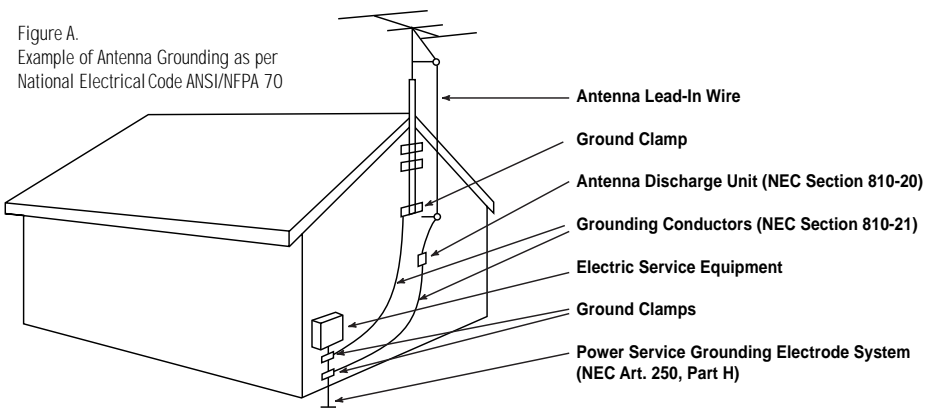

INTERMEZZO 3.5c OWNER'S GUIDE

Table of Contents

ii	Caution
iii	Important Safety Precautions
1	Technology
2	Unpacking the Product/Included Accessories
2	Placement
3	Tilt Adjustment
4	Controls and Connections
6	Maintenance and Service
7	Specifications

TECHNOLOGY

Intermezzo Series loudspeakers incorporate several innovative technologies that, when implemented by exceptional engineering talent after hours upon hours of subjective listening evaluations, result in a loudspeaker that realistically and accurately reproduces the signal source with minimal distortion and coloration.

Ceramic Metal Matrix Diaphragms™ (C.M.M.D.™)

For decades, loudspeaker engineers have known that the ideal transducer should be stiff, yet light, and have high internal damping (damping is a material's ability to absorb energy). Infinity's C.M.M.D. transducer is a significant advance in transducer technology. Ceramic, a class of material new to loudspeakers, offers better performance than other materials. Ceramic is stiffer than metals and lighter than plastics and typical composite materials; it also offers improved damping. These ceramic-based transducers take us a giant step closer to the ever-elusive "ideal transducer."

In tweeters, C.M.M.D. technology offers stiffness and damping superior to that of traditional metals and soft-dome materials. In woofer and midrange applications, it offers accurate pistonic operation over the entire frequency range of the driver, completely eliminating coloration due to cone breakup and dramatically reducing distortion. And when ceramic-metal-matrix diaphragms are exposed to moisture, sunlight or extreme temperatures, their performance does not deteriorate.

In addition to ceramic diaphragms, all the transducers incorporate magnetic shielding and rigid cast-frames that, through our FEA computer modeling and scanning-laser-vibrometer measurements, have been optimized to reduce resonances. This ensures minimal distortion and incomparable performance.

Amplifier

BASH® is an amplifier-power-supply technology that increases efficiency by reducing power dissipation in the output section. The BASH topology uses a high-efficiency, fast-response, switch-mode power supply that provides the main voltage rails for a linear Class-AB amplifier. By varying the output of the power supply with the audio signal being amplified, a constant voltage drop across the output transistors of the linear amplifier can be maintained. This means that the power dissipation in the output transistors is greatly reduced.

The result is an extremely efficient audio amplifier that does not compromise audio performance.

We hope you enjoyed this brief introduction to the technology of Intermezzo loudspeakers. If you would like to further explore their technology and design, please ask your Infinity dealer for the C.M.M.D. White Paper. The White Paper can also be downloaded from Infinity's Web site at www.infinitysystems.com.

PLACEMENT

Unpacking the Product

Finish unpacking the speaker and check the contents. If you suspect damage from transit, report it immediately to your dealer and/or delivery service. Keep the shipping carton and packing materials for future use.

Included Accessories . . .

Grille



Decorative Side Panel

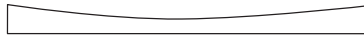

AC Cord

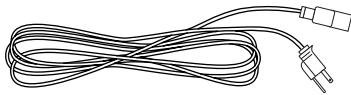

Tilt Adjustment Hardware

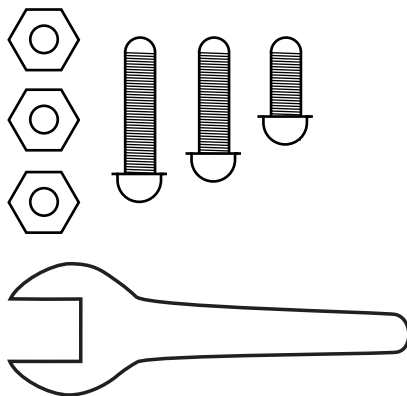

The Infinity Intermezzo 3.5c is designed to offer excellent performance in any home-theater system. However, the following placement guidelines and suggestions will start you on your way to achieving optimum performance. Remember, these are guidelines.

For best results, place the Intermezzo 3.5c center-channel speaker either on top of or below the television. Also, position the speaker so the front grille is even with the TV screen, as shown in Figure 1.

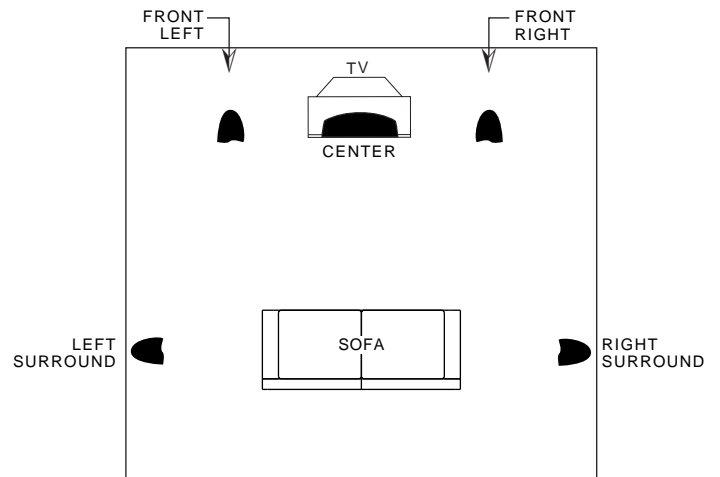

FIGURE 1

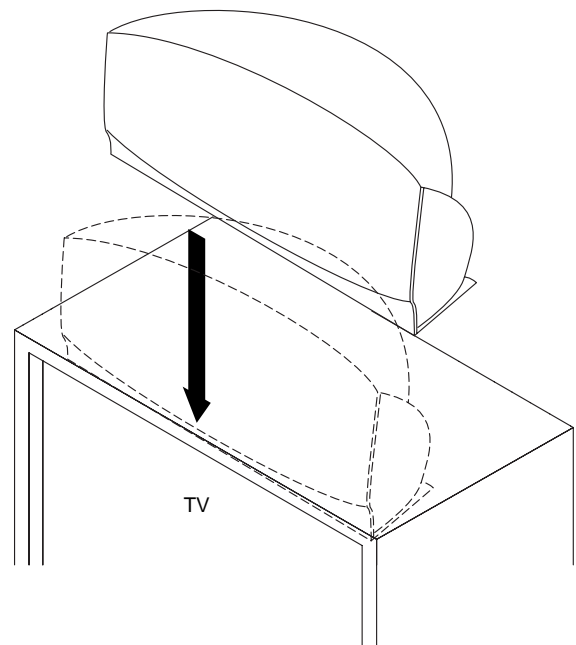

FIGURE 2 – This example shows the Intermezzo 3.5c center-channel speaker being placed on top of a television. The speaker can also be placed below the television.

TILT ADJUSTMENT

For optimum performance, the center-channel speaker should be directed toward the listening area. Since many televisions are installed so that the center-channel speaker is well above ear level, the Intermezzo 3.5c can be tilted downward so it's aimed at the listening area.

If you need to tilt the Intermezzo 3.5c, refer to Figure 3 as you perform the following steps:

1. Open the accessory pack and locate the following items: three feet (of different lengths), three locking nuts and one wrench.
2. Lay the speaker upside down and locate the threaded hole on the bottom.
3. Screw in the appropriate foot for the desired amount of tilt.
4. Tighten the nut with the enclosed wrench.
5. Carefully flip the speaker upright.

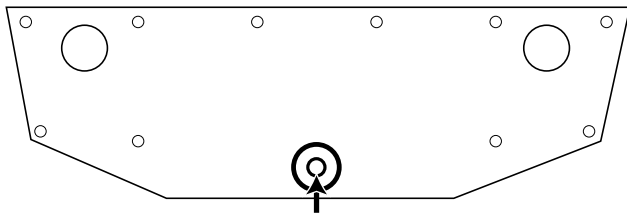
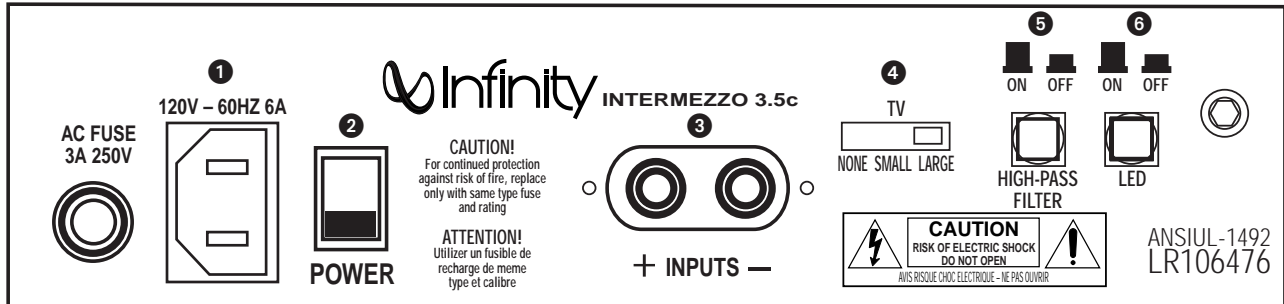

FIGURE 3 – This cross section shows where to install a foot on the bottom of the Intermezzo 3.5c center-channel speaker.

CONTROLS AND CONNECTIONS

Rear Panel



- ❶ AC-Cord Input
- ❷ Power Switch
- ❸ Speaker Input
- ❹ TV Size Selector
- ❺ High-Pass-Filter Selector
- ❻ LED Selector

Front Panel

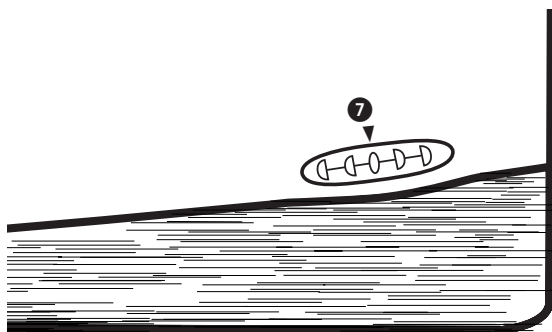

- ❼ Woofer Level Control

Speaker Connections 3

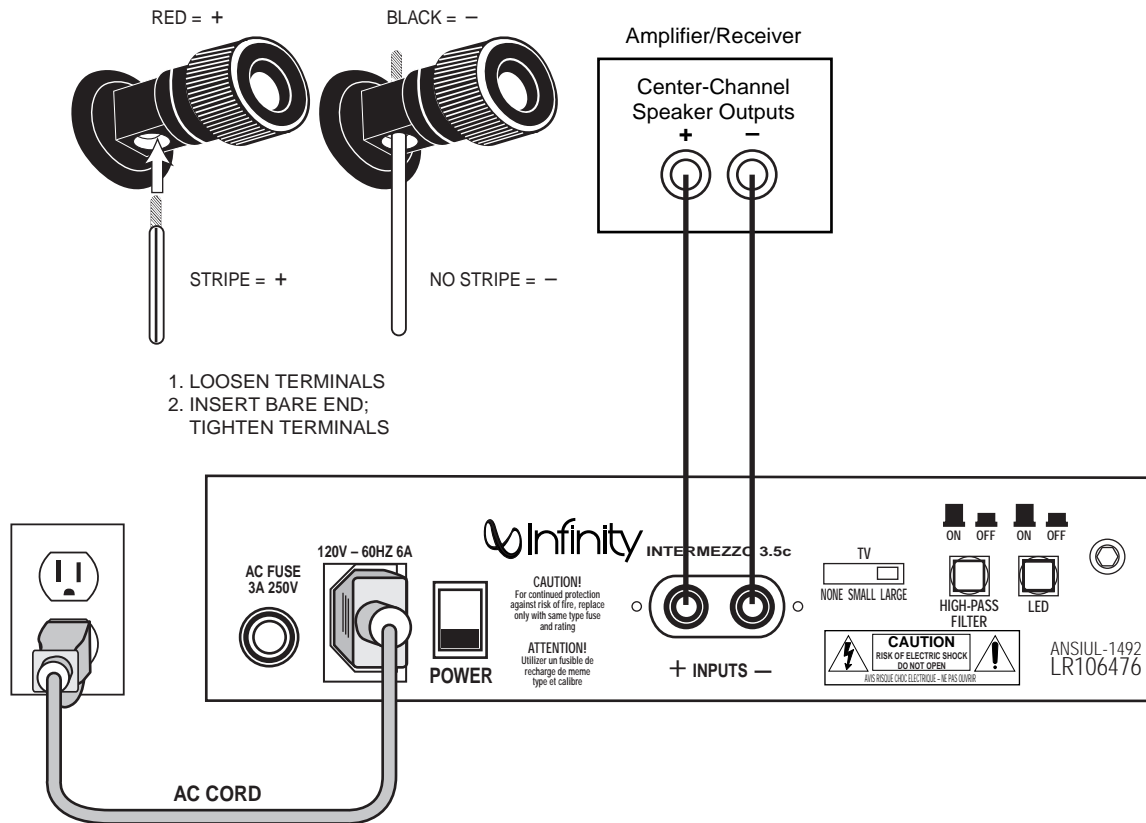

TV Size Selector 4

This control optimizes the performance of the Intermezzo 3.5c based on the size of the TV on which it is placed.

If you are placing the Intermezzo 3.5c behind a perforated screen for a projection TV, set this switch to "None."

If you are placing the Intermezzo 3.5c on top of a TV with a diagonal screen size up to about 36," set this switch to "Small."

If you are placing the Intermezzo 3.5c on top of a TV with a diagonal screen size larger than 36," set this switch to "Large."

High-Pass Filter 5

When set to "On," this control limits the low frequencies that the Intermezzo 3.5c will reproduce and allows you to use your processor's/receiver's bass-management settings for an ideal blend with a subwoofer.

When set to "Off," the Intermezzo 3.5c will reproduce the entire frequency range. Use this setting only if your system does not include a subwoofer.

LED Selector 6

This switch determines whether the green power indicator on the woofer level control 7 will illuminate when the speaker is playing. The setting of this switch does not affect the performance of the speaker in any way.

Setting the Woofer Level Control 7

1. Set the processor's/receiver's center-channel-speaker setting to "Small"

2. Confirm correct setting of Set TV Size selector 4.

3. Using the test tones in your receiver/processor, adjust the center-channel-speaker output (on the processor) to match the left and right speakers.

4. Finally, fine-tune the level adjustment on the Intermezzo 3.5c 7 to most closely match the tonal balance of the main left and right speakers. (For the Intermezzo 4.1t, initially set the center-channel level to "5." For the Intermezzo 2.6, set to the same setting as the Intermezzo 2.6's woofer adjustment.)

MAINTENANCE AND SERVICE

The Intermezzo 3.5c may be cleaned using a soft cloth, dampened with water only, to remove fingerprints or to wipe off dust.

The grille may be gently vacuumed. Stains may be removed with an aerosol cleaner, following its instructions. Do not use any solvents on the grille.

All wiring connections should be inspected and cleaned or remade periodically. The frequency of maintenance depends on the metals involved in the connections, atmospheric conditions, and other factors, but once per year is the minimum.

If a problem occurs, make sure that all connections are properly made and clean. In the event that your Intermezzo 3.5c ever needs service, contact your local Infinity dealer or Infinity directly at 1-800-553-3332 or www.infinitysystems.com.

SPECIFICATIONS

Intermezzo 3.5c

Frequency Response:	80Hz – 20kHz (± 1.5 dB) 60Hz – 22kHz (± 3 dB)
Nominal Impedance:	8 Ω
Sensitivity: (2.83V @ 1 meter)	90dB
Recommended Amplifier Power Range:	25 – 150 Watts
Woofer Amplifier Output: (100Hz with no more than 0.1% THD)	250 Watts RMS
2nd- and 3rd-Order Harmonic Distortion: (20Hz – 20kHz @ 95dB SPL)	< 1%
Crossover Frequencies:	350Hz, 2800Hz; 24dB/Octave
Dimensions:	8-3/4" x 22" x 8" 222mm x 559mm x 203mm
Weight:	27 lb 12.3kg

Infinity continually strives to update and improve existing products, as well as create new ones. The specifications and construction details in this and related Infinity publications are therefore subject to change without notice.



Harman International Company © 2000 Infinity Systems, Inc., 250 Crossways Park Drive, Woodbury, NY 11797 USA (800) 553-3332 (USA Only) www.infinitysystems.com
BASH is a registered trademark of Indigo Corporation. Infinity is a registered trademark of Infinity Systems, Inc. Printed in USA 3/00 Part No. 335717-001

Free Manuals Download Website

<http://myh66.com>

<http://usermanuals.us>

<http://www.somanuals.com>

<http://www.4manuals.cc>

<http://www.manual-lib.com>

<http://www.404manual.com>

<http://www.luxmanual.com>

<http://aubethermostatmanual.com>

Golf course search by state

<http://golfingnear.com>

Email search by domain

<http://emailbydomain.com>

Auto manuals search

<http://auto.somanuals.com>

TV manuals search

<http://tv.somanuals.com>