



 **Electrolux**  
REFRIGERATION

# Use & Care - contents

## 1 - Introduction

Important Safety Instructions.....	3
Location .....	3
Clearances around your refrigerator .....	3

## 2 - Features at a glance

Top Mount (TM) Freezer models .....	4
Bottom Mount (BM) Freezer models.....	5

## 3 - Installation

Installing your new refrigerator .....	6
Ice Station Assembly installation .....	7
Top freezer models.....	7
Bottom freezer models.....	7

## 4 - Operating your refrigerator

Initial start up .....	8
Controlling the Temperature	
Electronic (Digital Display) Models .....	9
Adjusting temperatures.....	9
Changing the freezer temperature .....	9
Changing the refrigerator temperature .....	9
Fast freeze function .....	9
Door alarm .....	10
Freezer temperature alarm.....	10
Vacation mode .....	10
Child Lock.....	10
Wine chill timer .....	10
Normal Mode .....	10
Eco Mode.....	10
Vacation Mode.....	10
Manual (rotary controlled models) .....	11
Top freezer models .....	11

Bottom freezer models .....	11
Dairy compartment .....	13
Door storage bins .....	13
Crisper Bin .....	13
Storing vegetables .....	13
Storing fruit and small goods .....	13
Crisper bin and shelf removal .....	13
Sliding shelf deli-bin (where fitted) .....	14
Split glass shelf (where fitted) .....	14
Deodoriser .....	14
Bottle Snugger (where fitted) .....	14
Freezer baskets (bottom freezer model only) .....	15
Changing the Light Bulb	
Food Compartment.....	15
Freezer Compartment .....	15

## 5 - Care & Maintenance

Cleaning the refrigerator .....	16
Exterior .....	16
Cabinet .....	16
Doors - painted .....	16
Doors - stainless steel.....	16
Interior .....	16
Keep the door seals clean.....	16
Safety .....	16
What to do before calling for service.....	17

### Anti+bac

Several items in your new Electrolux refrigerator have been manufactured with an anti-bacterial additive.

The advantages of the anti+bac additive are:

- Provides Antimicrobial protection.
- Kills harmful bacteria.
- Reduce odours by killing odour causing bacteria.
- Is safe and harmless for humans and animals.
- Works continuously to protect from harmful bacteria and germs.
- Helps protect against cross contamination (the most common cause of food borne illness).
- Protection that's built in during the manufacturing process, it won't wash or wear off. It lasts the life of the product.
- Anti+bac is not a substitute for good hygiene practices.

**All rights in this publication are reserved and no part may be reproduced without the prior written permission of Electrolux Home Products Pty Ltd ("Electrolux"). The contents of this publication are believed to be correct at the time of publication but any information, products or services mentioned may be modified, supplemented or withdrawn at any time. Due to its' policy of continuous product development and improvement Electrolux reserves the right in its' sole discretion to change products specification and materials without notice.**

# 1 - Introduction

## Dear Customer

### Congratulations on the purchase of your new refrigerator.

We at Electrolux Home Products are very proud of our product and we are completely committed to providing you with the best service possible.

Please read this Use & Care Manual very carefully. It contains valuable information on how to properly maintain your new refrigerator. We know you'll enjoy your new refrigerator and thank you for choosing our product. We hope you will consider us for future purchases.

Follow the instructions below to ensure that you install it safely and that it runs efficiently.

### PLEASE READ AND SAVE THESE INSTRUCTIONS

This Use & Care Manual provides specific operating instructions for your model. Use your refrigerator only as instructed in this manual. These instructions are not meant to cover every possible condition and situation that may occur. Common sense and caution must be practiced when installing, operating and maintaining any appliance.

**Important:-** Before you install your refrigerator, PLEASE CHECK FOR ANY DAMAGE OR MARKS. If you find that the refrigerator is damaged or marked, you must report this within 7 days if you wish to claim for damage / marks under the manufacturers warranty. This does not affect your statutory rights.

## Important Safety Instructions



IF PRESSURISED AEROSOL CONTAINERS BEAR THE WORD 'FLAMMABLE' AND/OR A SMALL FLAME SYMBOL, DO NOT STORE THEM INSIDE ANY REFRIGERATOR. IF YOU DO SO YOU MAY CAUSE AN EXPLOSION

## Warning



When you dispose of refrigerators and freezers, remove any doors. Children can suffocate if they get trapped inside.

This refrigerator contains insulation formed with flammable blowing gases. Avoid safety hazards by carefully disposing of this appliance.

- The refrigerator must be plugged into its own dedicated 220-240 Volt, 50 Hz., AC electric outlet.

- Ensure that the electric outlet is properly earthed to ground. Consult a qualified electrician if you are unsure.

- Do not use an extension cord or adapter plug.

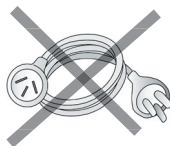

- If the power cord is damaged, it should be replaced by a service technician or a qualified person.



- Unplug the refrigerator before cleaning and before changing any of the light bulbs to avoid electric shock.

- Never unplug the refrigerator by pulling on the power cord. Always grip the plug firmly, and pull straight out of the receptacle to prevent damaging the power cord.

## Location

- Choose a place that is not too cold - the temperature should be above 10°C.



- Put the refrigerator in a dry place, avoiding areas of high moisture or humidity.



- Don't put the refrigerator in frosty or unprotected areas, for example in a garage or on a veranda.

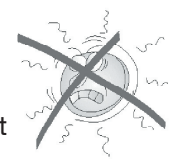

- Don't put the refrigerator in direct sunlight.



- Don't put the refrigerator near stoves, fires or heaters.

When correctly installed, your refrigerator should:

- have adequate clearance to the back and sides for air circulation.
- be aligned to the surrounding cupboards.
- have doors that will self-close from a partially open position.
- have the stability foot in place (see Diagram 4 on page 6) to prevent the refrigerator falling forward when a door with heavy food load is opened.

## Clearances around your refrigerator.

Before you move your refrigerator into the place where it will operate check that it will have adequate clearance. Clearance is required for air circulation and too little clearance may affect your refrigerators performance.

### We recommend minimum clearances of:

- 3cm on each side.
- 9cm above the refrigerator.
- 5cm behind the refrigerator.

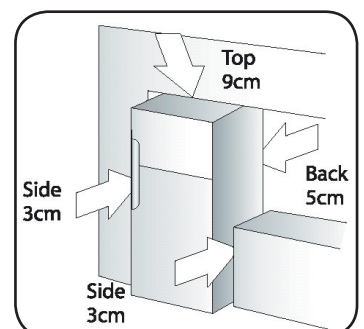

# 2 - Features at a glance

Please look at the diagram below before reading about how to care for your refrigerator

## TOP FREEZER MODELS (TM)

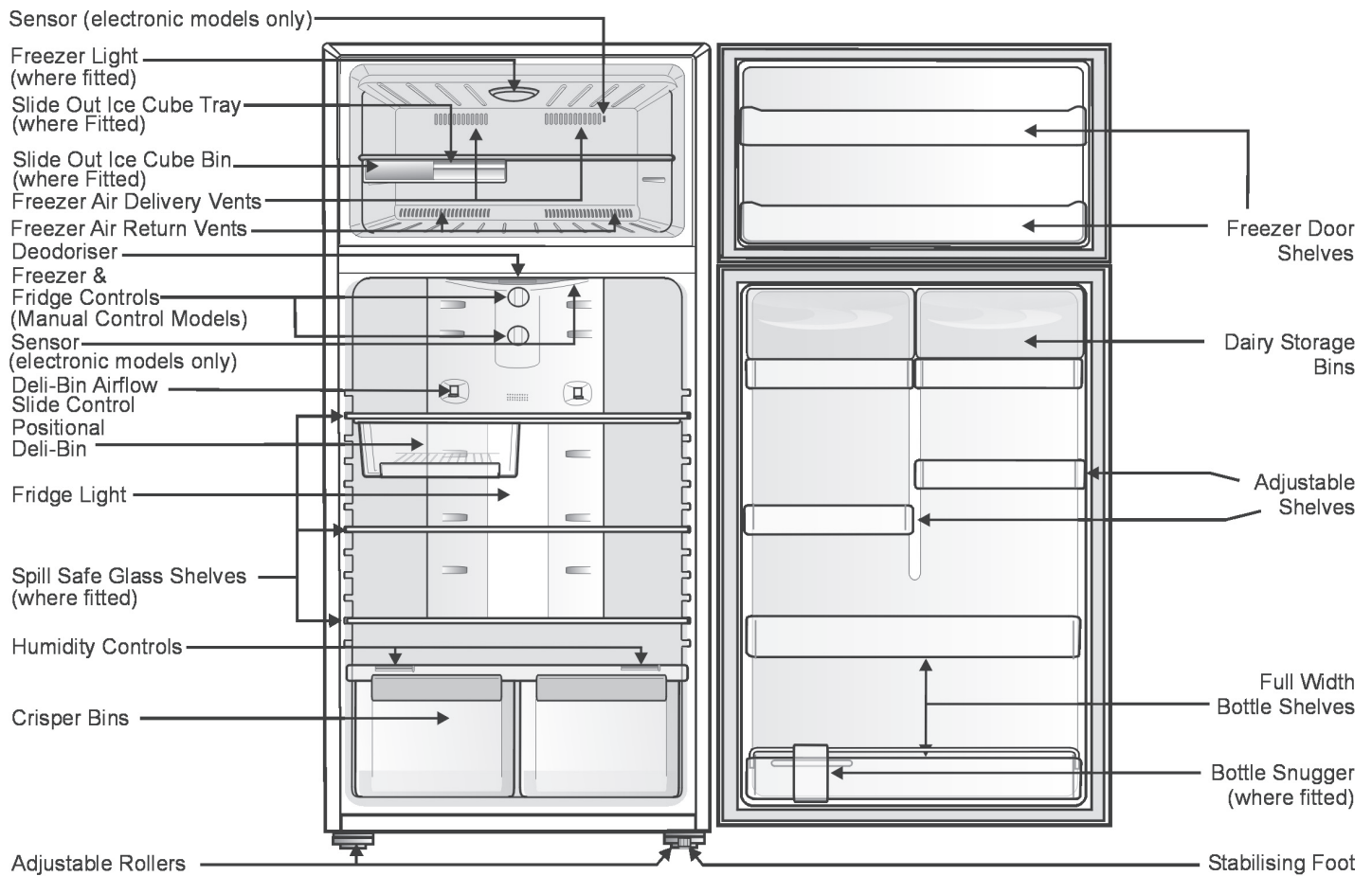

Model shown: N520J

Features may vary according to model

# 2 - Features at a glance

Please look at the diagram below before reading about how to care for your refrigerator

## BOTTOM FREEZER MODELS (BM)

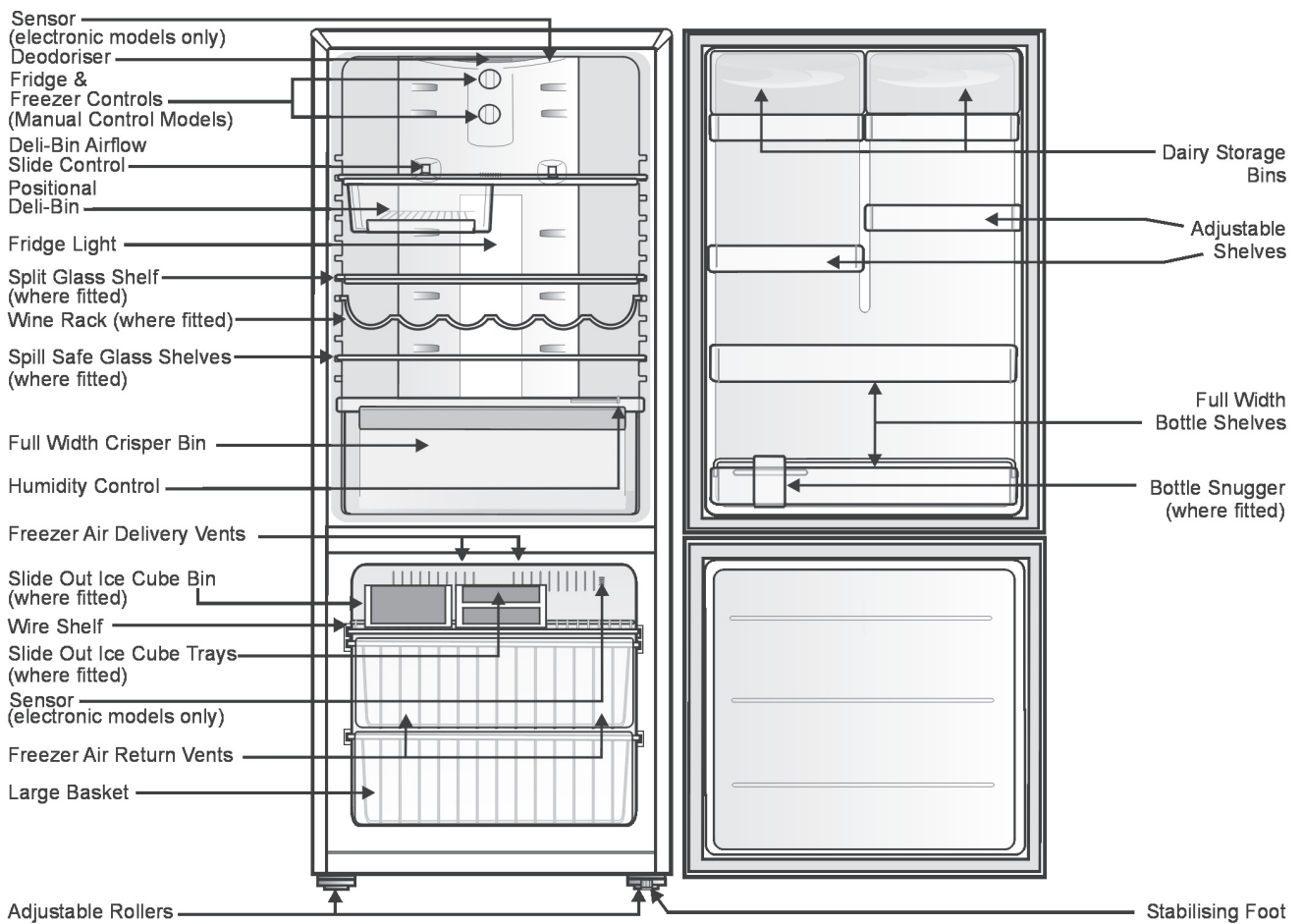

Model shown: NB430J

Features may vary according to model

# 3 - Installation

## Installing your new refrigerator.

The refrigerator should arrive with the front adjustable rollers wound down to tilt the top of the refrigerator backwards by about 10-15mm from upright (See Diagram 1). The stability foot should also be wound fully up so it will not interfere with the operation of the rollers (See Diagram 2).

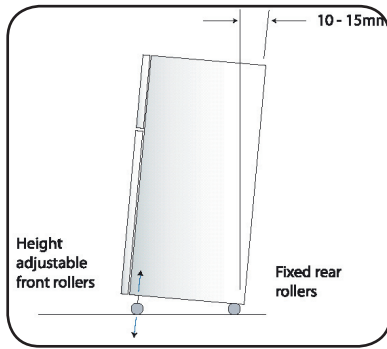

Diagram 1

1. Roll the refrigerator into its final position.

**WARNING: The rollers are designed for forward or backward movement only. They are not castors. Moving the refrigerator sideways may damage your floor and the rollers.**

2. The top of the refrigerator should be tilted back by approximately 10-15mm. This will allow the doors to self-close providing a consistent door seal. (See Diagram 1) It is normal for the freezer door to momentarily open and re-close when the food compartment door is closed firmly. If the freezer stays open you will need to tilt the refrigerator backwards a little further.

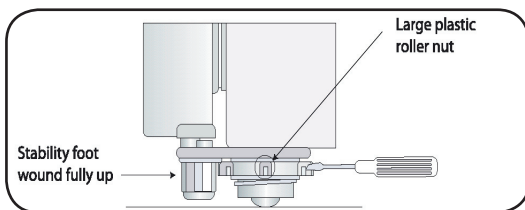

Diagram 2

3. If the refrigerator is not tilted back, you can adjust the two front rollers by turning the large, plastic roller nut (See Diagram 2). This will increase the height of the rollers. One turn of the nut will tilt the refrigerator back approximately 10mm. If you have difficulty turning the roller nut you can have someone tilt the refrigerator back, so that you have better access. Alternatively, you can access the rollers from the side, using a flat screwdriver to help you turn the nut (see Diagram 2).

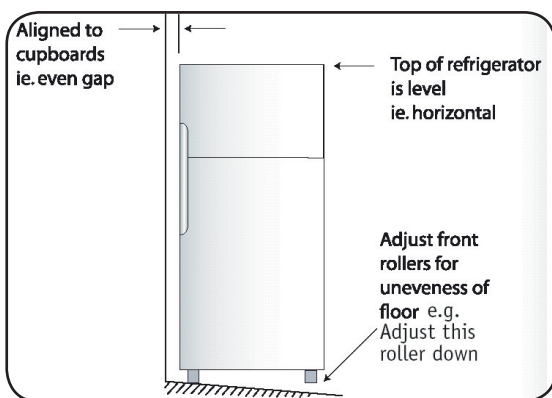

Diagram 3

4. Check the alignment of the refrigerator to the surrounding cupboards. The top of the refrigerator should be level from side to side (see Diagram 3). If you need to adjust the level, use the adjustable rollers as discussed in Step 3.

5. If the refrigerator now rocks from one corner to the opposite rear corner, this means that the floor is uneven; you will need to put some packing under one of the rear rollers. You could use thin pieces of solid material, such as thin board, vinyl floor tiles or laminate. Place the packing so that it will sit under one of the rear rollers when the refrigerator is rolled into position.

6. You may now need to fine-tune the installation by repeating Steps 3, 4 and 5.

7. When you have the refrigerator in final position wind the stabilising foot down until it just makes contact with the floor (see Diagram 4). Whenever you need to move the refrigerator, be sure to wind the foot back up so that the refrigerator can roll freely.

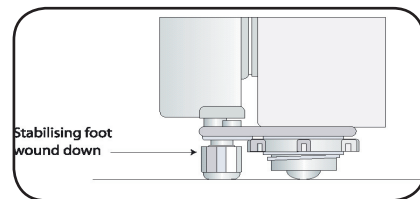

Diagram 4

8. Clean your refrigerator thoroughly following the instructions on page 15 and wipe off any dust that has accumulated during shipping.

9. Plug the refrigerator into the power point. Don't use a double adaptor. If you need to roll the refrigerator out to get at the power point, remember to raise the stabilizing foot before you do so.

10. We recommend that you let your refrigerator run for two to three hours before you put any food in it. This will allow you to check that it is operating properly and that enough cool air is going to the freezer.

**Congratulations! You have successfully installed your refrigerator.**

# 3 - Installation

## Ice Station Assembly Installation

To fit the Ice station assembly to a top freezer model;

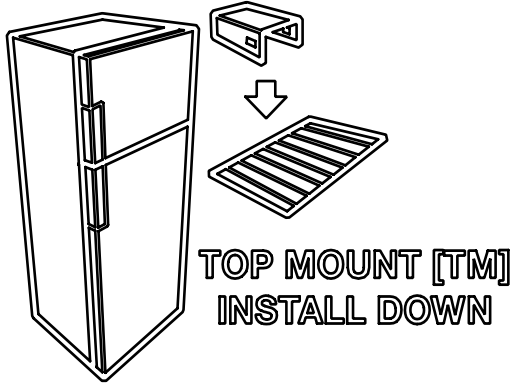

Fit the Ice Station carrier to the wire shelf by aligning the outside of the carrier to the wires as shown in diagram 1.

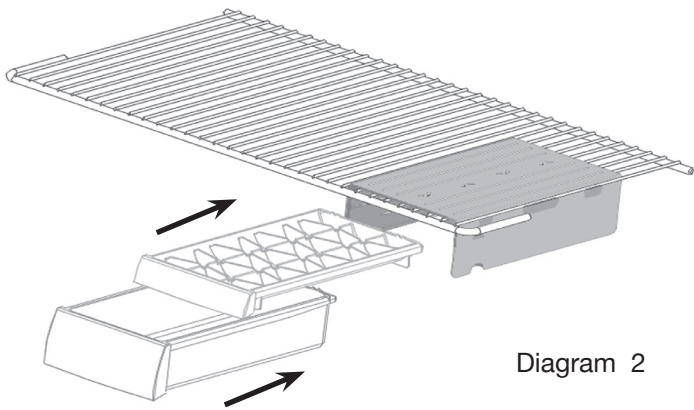
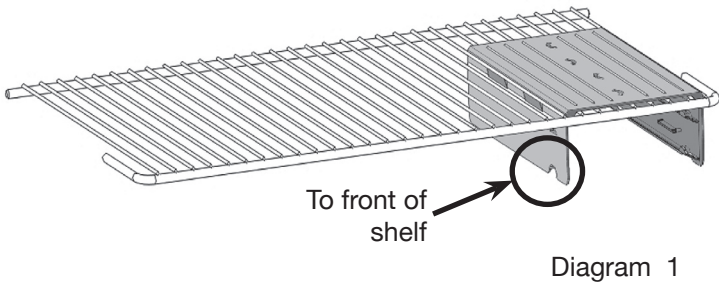

Then push down in the middle of the carrier until it clips into place as shown in diagram 2

Finally, slide the ice cube trays or storage bin into position as shown in diagram 2

To remove, take out the ice cube trays and storage bin and simply lift the carrier off the wire shelf.

To fit the Ice station assembly to a bottom freezer model;

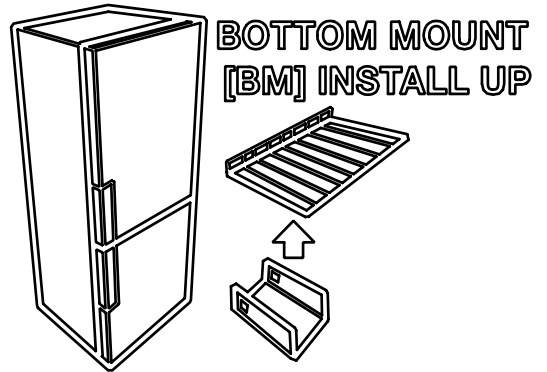

Fit the Ice Station carrier to the wire shelf by aligning the outside of the carrier to the wires as shown in diagram 1.

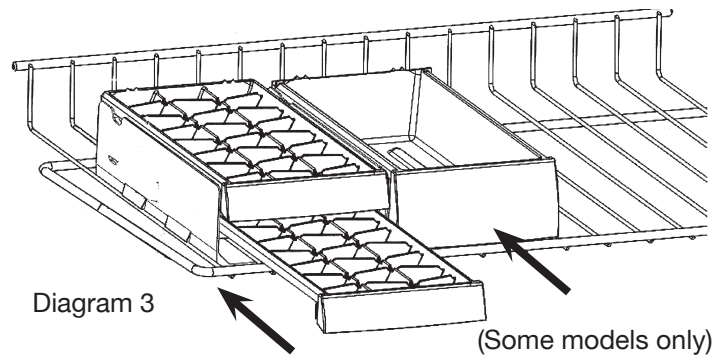
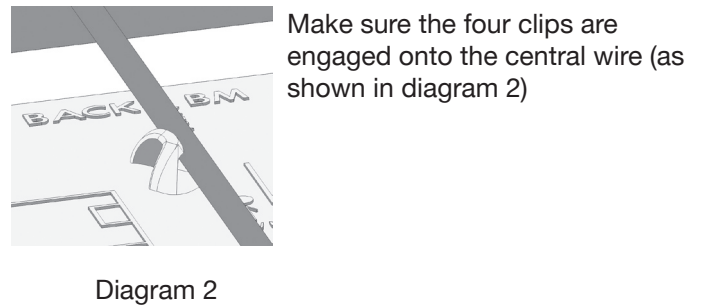
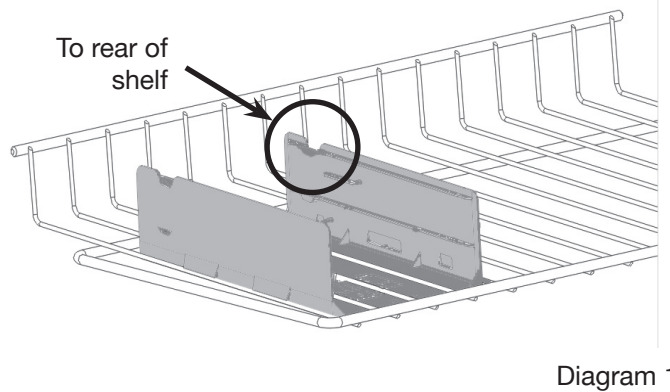

Then push up in the middle of the carrier until it clips into place

Finally, slide the ice cube trays or storage bin into position as shown in diagram 3

To remove, take out the ice cube trays and storage bin and simply pull the carrier off the wire shelf.

# 4 - Operating your refrigerator

## Refrigerator / Freezer operation

### Initial start up

The refrigerator transfers heat from food placed inside the refrigerator to the outside air.

**This process makes the rear, the sides and the area adjacent to the doors, particularly at initial start up, feel warm. This is normal.**

There is a cooling coil located behind the rear wall of the freezer section. This coil cools and removes moisture from the air. A fan at the rear of the freezer section then circulates cold, dry air throughout the refrigerator.

This air circulation means that foods are refrigerated far more quickly than in refrigerators where the air remains relatively static.

**Avoid placing food against air outlets as this will affect air circulation. (see diagram on page 5)**

A light frosting will occasionally occur on the cold interior of the freezer when the door is opened frequently. This is normal and will disappear after a few days in most climates.

Make sure you fully close the freezer and fresh food doors after you load or remove food from these compartments. If the doors are left partly open, a heavy frost will coat the inside of the freezer. If a frost develops, remove it. Take care to properly close the doors and the frost will not reoccur.

Your new energy efficient refrigerator uses a high-speed compressor and other energy efficient components that may produce different noises to your old refrigerator. These sounds are normal and include:

- compressor running noise.
- air movement noise from the small fan motor.
- occasional gurgling, similar to water boiling.
- a popping noise, heard during defrosting.
- a clicking noise, just prior to the compressor starting up.

These noises are normal and not cause for alarm.

Further details can be found on page 17.

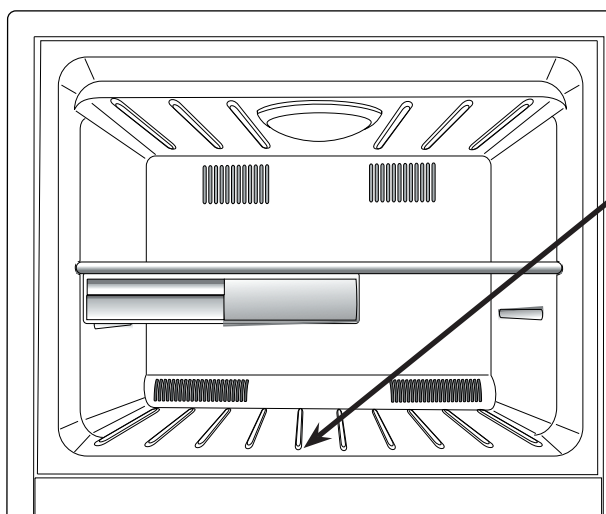

### On a top freezer refrigerator

If food is forward of the ribs on the bottom of the freezer, it will keep the door open. So make sure food is stored behind the ribs.

### On a bottom freezer refrigerator

Ensure freezer baskets and shelves are pushed completely back to prevent them holding the door open.



# 4 - Operating your refrigerator

## Controlling the temperature

### Electronic models

The electronic display panel consists of an LCD display with white backlighting and 6 push buttons. When the power is first turned on, you will see the default settings, with the white backlighting on.

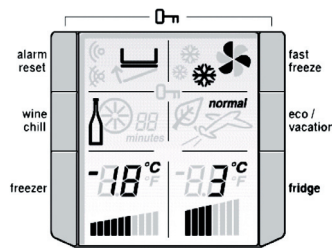

If no buttons have been pressed and the fridge door is closed the backlighting will turn off after 30 seconds.

### Adjusting temperatures

The default temperature for the refrigerator is 3°C, with a default of -18°C for the freezer. If you want to change the temperatures, use the instructions below. You should make only small adjustments and wait 24 hours to see whether you need to make further changes.

Note: When you set a temperature, you set an average temperature for the whole refrigerator cabinet. Temperatures inside each compartment may vary, depending on how much food you store and where you place it. High or low room temperature may also affect the actual temperature inside the refrigerator.

### Changing the freezer temperature

Press the *freezer button* to make the freezer colder in 1°C steps. Once -23°C is reached the display will return to -14°C with the next button press. You'll notice that the bar graph gets smaller with colder freezer settings.

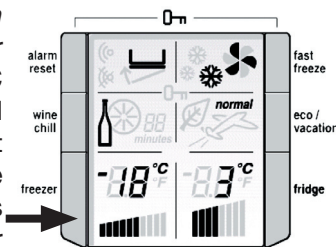

### Changing the refrigerator temperature

Press the *fridge button* to make the fridge colder in 1°C steps. Once 0.0°C is reached the display will return to 7.0°C with the next button press. The bar graph gets smaller with colder settings.

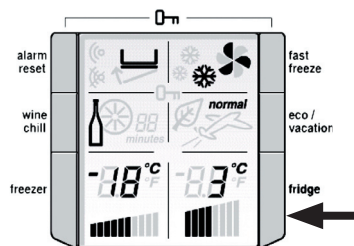

Note: Testing ice cream is a good way to test the freezer temperature. Testing drinking water is a good way to check the refrigerator compartment temperature.

### Fast freeze function.

Use the fast freeze function when you add a large amount of food to the freezer compartment. This freezes the food quickly but does not affect the temperature in the refrigerator compartment.

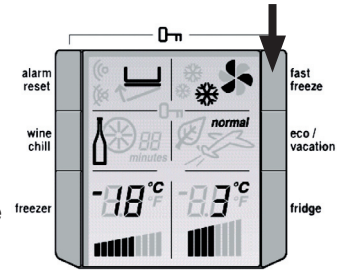

To use this function, press the *fast freeze button* once. An animated icon will light up. The fast freeze function will now operate for 90 minutes. If you want to turn the fast freeze function off before 90 minutes have passed, simply press the fast freeze button again. The icon will disappear and the refrigerator will return to normal operation.

### Freezer temperature alarm.

If the alarm is sounding for no apparent reason, check whether anything is holding the door open. Closing the door resets the alarm for a further 2 minutes.

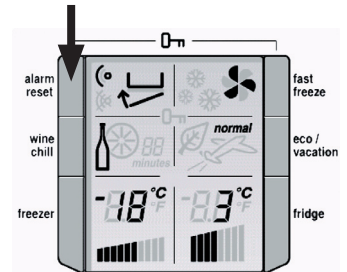

If the freezer becomes too warm due to the freezer door being left open or warm food being placed too close to the temperature sensor in the freezer (see page 4 & 5, Parts of your refrigerator for the sensor location). A buzzer will sound, the icon adjacent to the alarm reset button, the freezer set temperature and bar graph will all flash until the alarm reset button is pressed. Once pressed the alarm disable icon adjacent to the alarm reset button will illuminate for 50 minutes, or until the temperature reaches an acceptable level.

Make sure nothing is holding the freezer door open and move any warm food away from the temperature sensor. See page 5 & 6 (Parts of your Refrigerator) for more information.

If the freezer is still too warm after 50 minutes the alarm will sound again, indicating that something may be wrong with your refrigerator.

Note: The freezer temperature alarm can be reset for 12 hours by pressing the alarm reset button continuously for 10 seconds.

# 4 - Operating your refrigerator

## Door alarm.

If the refrigerator door is left open for longer than 2 minutes a buzzer will sound and an arrow pointing to an open door will flash. The refrigerator temperature settings and bar graph will also flash.

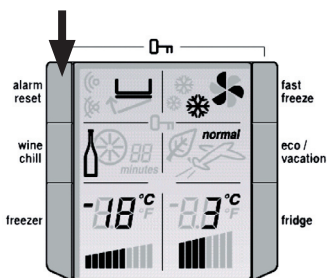

If you want to leave the door open while you load the fridge, you can turn the alarm off for 8 minutes by pressing the *alarm reset* button.

## Child Lock

To activate the child lock, press the *alarm reset* and *fast freeze* buttons together. This will disable the display to prevent accidental changes to settings.

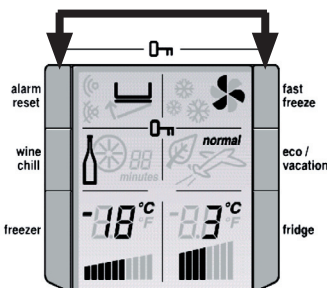

To turn off the child lock press and hold the *alarm reset* and *fast freeze* buttons together.

## Wine chill timer.

To use the timer, press the wine chill button once to set a 10 minute time limit, twice for 20 minutes and three times for 30 minutes. Press four times to turn the timer off.

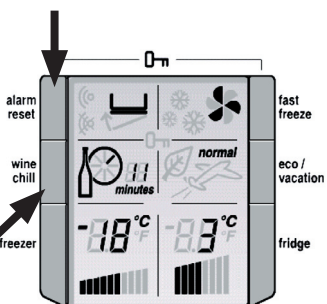

If you set the wine chill timer it will sound an alarm to remind you that you have left drinks in your freezer for quick chilling.

An animated icon appears beside the *wine chill* button with a countdown timer.

Suggested chilling times:

- 10 minutes for cans of drink
- 20 minutes for bottles of wine
- 30 minutes for bottles of soft drink.

When you press the wine chill button, an animated icon will appear beside the wine chill button with a countdown timer. The timer will count down in 1 minute increments; you can change the time or turn the timer off even after the countdown has started. When the countdown is finished a buzzer will sound and the icon beside the alarm will flash until the alarm reset button is pressed.

To stop the alarm and turn off the wine chill timer, press the *Alarm reset* button. If your drink is chilled, take it out of the freezer. If it is not cold enough, reset the wine chill

function (remembering that the drink is already partially chilled).

## Energy Efficiency

Your refrigerator has been designed with energy efficiency in mind and can operate in any of three modes (Normal, Eco, Vacation), depending on the level of efficiency sought.

### Normal Mode

This is the mode which is entered automatically when the refrigerator is first turned on. Normal Mode is the mode most suitable when the refrigerator door is opened often.

### Eco Mode

Eco Mode is a more efficient mode than Normal Mode and can be entered in two ways. Either by manually pressing the Eco / Vacation button once when in Normal Mode, or automatically after 30 hours if the refrigerator door has not been opened. If Eco Mode is entered manually, door openings will not cause the display to revert to Normal Mode, however if Eco Mode is entered automatically, the refrigerator will revert to Normal Mode once the refrigerator door is opened.

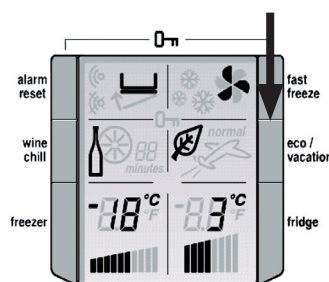

### Vacation Mode

If you think that you will be away from your refrigerator for an extended period and would like to take advantage of maximum energy efficiency. Then, from Normal Mode, press the Eco / Vacation button twice in succession just before you leave and the refrigerator will enter Vacation Mode, as indicated by the aeroplane symbol. (If in Eco Mode a single button press is all that is required to enter Vacation Mode).

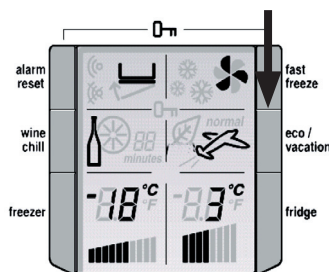

Vacation Mode is exited automatically once the refrigerator door is opened and Normal Mode resumes.

Eco and Vacation Modes minimise defrosting to save energy, while maintaining your temperature settings.

Note: Opening the freezer door has no effect on the operation of Eco and Vacation Modes, except if the freezer temperature alarm sounds.

# 4 - Operating your refrigerator

## Controlling the temperature in your top freezer refrigerator

### Manual (rotary control) model

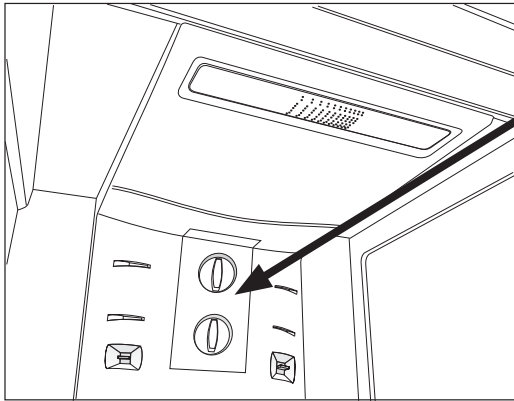

Set the temperature by using the main temperature controls at the rear of the refrigerator compartment. When you first start your refrigerator, set both refrigerator and freezer controls to MID. The refrigerator temperature control is affected by altitude and it is recommended that it be set warmer to compensate. E.g. At 1000 metres above sea level set the refrigerator temperature control to one setting warmer than MID.

**WAIT 24 HOURS AFTER CHANGING SETTINGS:** When you change temperature settings, make small adjustments and wait 24 hours before assessing whether you need to make any further changes.

NB: Testing ice cream is a good way to check the freezer temperature. Testing drinking water is a good way to check the refrigerator compartment temperature.

### ADJUSTING THE FREEZER TEMPERATURE

1. Select the freezer control. (Top knob).
2. Rotate the knob clockwise to set Colder.
3. Rotate the knob anti-clockwise to set Less Cold.

**COLDEST FREEZER SETTING IS NOT RECOMMENDED IN NORMAL AND VERY HOT CLIMATES AS THIS WILL LIMIT THE COOLING TO THE REFRIGERATOR SECTION.**

In very cold climates (where temperatures are below 10°C) the freezer may need to be set colder.

### ADJUSTING THE REFRIGERATOR TEMPERATURE

1. Select the refrigerator control. (Bottom knob).
2. Rotate the knob clockwise to set Colder.
3. Rotate the knob anti-clockwise to set Less Cold.

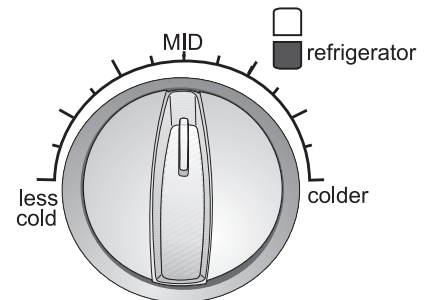
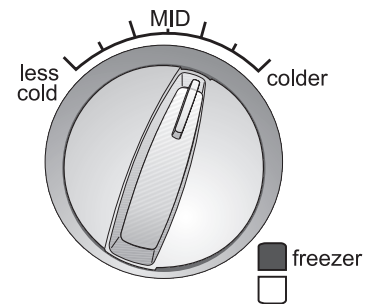

# 4 - Operating your refrigerator

## Controlling the temperature in your bottom freezer refrigerator

### Manual (rotary control) model

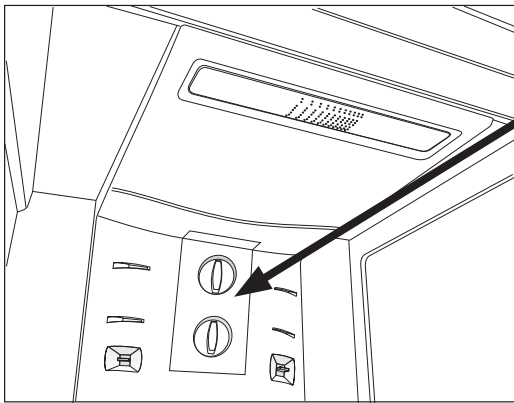

Set the temperature by using the main temperature controls at the rear of the refrigerator compartment. When you first start your refrigerator, set both refrigerator and freezer controls to MID. The refrigerator temperature control is affected by altitude and it is recommended that it be set warmer to compensate. E.g. At 1000 metres above sea level set the refrigerator temperature control to one setting warmer than MID.

**WAIT 24 HOURS AFTER CHANGING SETTINGS:** When you change temperature settings, make small adjustments and wait 24 hours before assessing whether you need to make any further changes.

NB: Testing ice cream is a good way to check the freezer temperature. Testing drinking water is a good way to check the refrigerator compartment temperature.

### ADJUSTING THE REFRIGERATOR TEMPERATURE

1. Select the refrigerator control. (Bottom knob).
2. Rotate the knob clockwise to set Colder.
3. Rotate the knob anti-clockwise to set Less Cold.

### ADJUSTING THE FREEZER TEMPERATURE

1. Select the freezer control. (Top knob).
2. Rotate the knob clockwise to set Colder.
3. Rotate the knob anti-clockwise to set Less Cold.

**COLDEST FREEZER SETTING IS NOT RECOMMENDED IN NORMAL AND VERY HOT CLIMATES AS THIS WILL LIMIT THE COOLING TO THE REFRIGERATOR SECTION.**

In very cold climates (where temperatures are below 10°C) the freezer may need to be set colder.

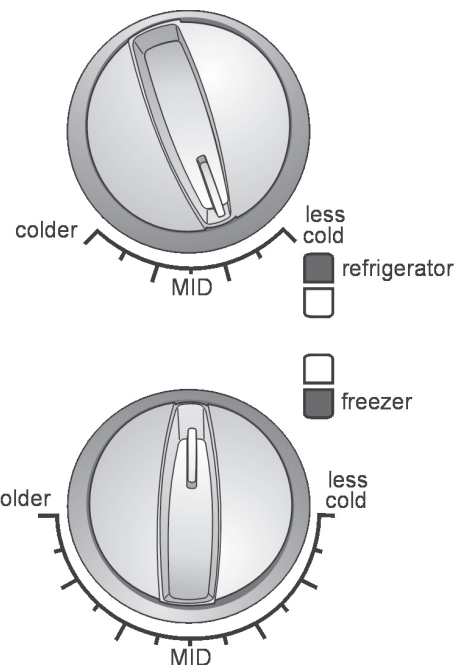

# 4 - Operating your refrigerator

## How to use the features of your refrigerator

This section tells you how to make the most of the refrigerators many useful features and how to clean them.

### Door storage bins (shelves)

Both the refrigerator and freezer have door storage bins. You can adjust the refrigerator bins to meet different storage needs. All the door bins are completely removable for cleaning. If you want to remove or adjust a bin, lift it over the support lugs on the inner door panel. Push the bin down over the support lugs to lock it in place.

### Dairy compartment

You can use the Dairy compartment to store foods such as butter, margarine and cheeses. The compartment is slightly warmer than the rest of the refrigerator compartment.

### Crisper Bin

#### Storing vegetables

You can use the crisper bin to store vegetables, fruit or small goods. You can change the humidity inside the bin by rotating the humidity control.

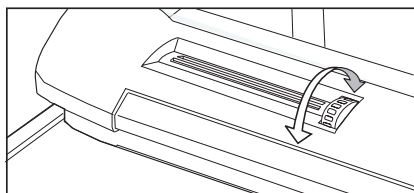

You should store vegetables in the crisper bin remembering to set the humidity control to more humid.

#### Storing fruit & smallgoods

You can also store fruit in the crisper bin remembering to set the humidity control to less humid.

### Crisper Bin and shelf removal

- Remove the crisper bin(s) by pulling forward, then up and forward.
- Remove the glass (if fitted) by flexing the rear of the shelf backward to disengage the clip and allowing the glass to drop out of the plastic frame.
- Remove the crisper shelf by lifting the catches on the underside of the shelf and pulling the shelf forward.

### Sliding Deli Shelf/ Bin (where fitted)

The sliding deli bin allows you to position the deli-bin in any position within the refrigerator. This allows you to conveniently locate it around stored food or to align it with the multi flow vents for direct cooling.

### Usage Instructions:

In order to correctly use the deli bin it should be located fully on the left or right or in a central position. This will align the multiflow vents with the ducting surfaces at the rear of the deli bin. One or both of the vents can be opened to allow cooler air to pass over foodstuffs stored in the deli.

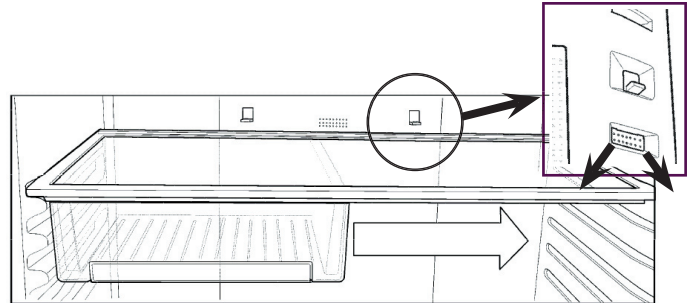

The air from these vents can be very cold, which is useful for the fast chilling of food and drinks. However, items may freeze if left near the vents. To prevent freezing, move items away from the vents after chilling.

Cleaning: The sliding deli shelf can be removed for ease of cleaning. In order to do so a flexible locking mechanism has been incorporated into the rear shelf rail.

- Remove Deli Bin
- Remove the shelf assembly by pulling it past the stops.
- Place the full assembly up side down on a flat surface.
- Slide the sub frame to the left until it engages with the locking mechanism.
- Pull the thumb tag away from the rail to disengage it.
- Slide the sub frame past this and allow it to flex back into position.

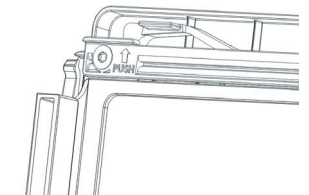

Clean the parts as required and allow to dry. To replace the sub frame repeat this procedure making sure to align the front lip on the front shelf recess.

ALL GLASS IS SAFETY GLASS. HOWEVER CAUTION SHOULD BE TAKEN WHEN REMOVING THE SHELF FOR REPOSITIONING OR FOR CLEANING. AS THE ASSEMBLY IS RELATIVELY HEAVY AND IF HELD IN THE VERTICAL POSITION (AS SHOWN) THE RUNNER ASSEMBLY MAY DROP DOWN.

DO NOT REMOVE ANY SCREWS!

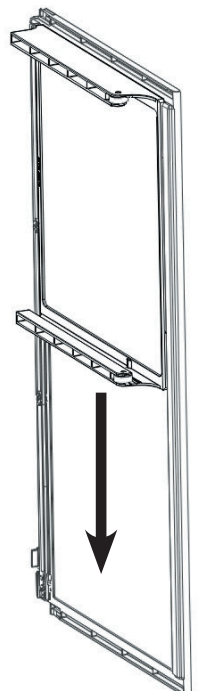

# 4 - Operating your refrigerator

## Spill safe glass shelves (where fitted)

Spill safe glass shelves keep spills on the shelf. A shelf retaining system minimizes accidental movement of shelves. The shelves can be adjusted to many different heights. Spill safe glass shelves are not to be used as slide out shelves.



## Split Glass Shelf (where fitted)

This shelf can be used either as a full depth shelf or when tall items need to be stored at the front of the refrigerator it can be collapsed to half its original depth.

To collapse the shelf:

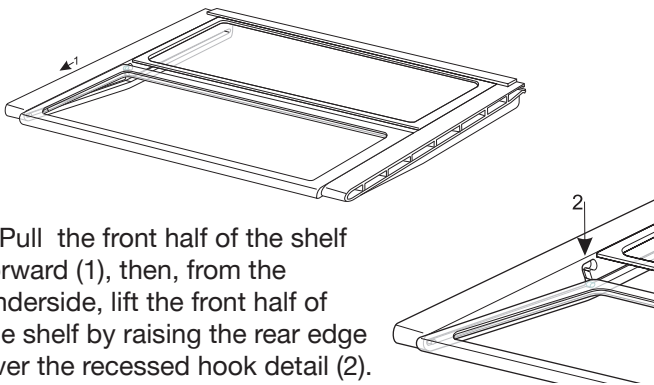

- Pull the front half of the shelf forward (1), then, from the underside, lift the front half of the shelf by raising the rear edge over the recessed hook detail (2).

- Pull the shelf forward and allow the rear to drop into the side channels.

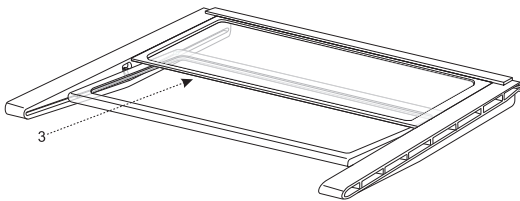

- Push the front shelf backwards (3,4) until it reaches the rear stops.

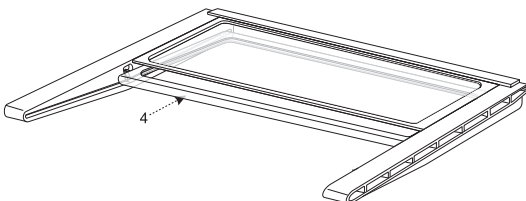

## Repositioning:

The shelf can be repositioned within the refrigerator unit by pulling the whole assembly out until the side panels are free to pivot down, then pivoting the rear of the shelf until the shelf is free from the liner runners. The shelf can then be positioned in any of the runners – this is a very useful feature

if your appliance door happens to have limited access.

## Deodoriser

Your refrigerator is fitted with a catalysing deodoriser to assist with the removal of food odours inside your refrigerator.

It is located at the air return so odours are removed by adsorption through the filter by the normal operation of the refrigerator (see diagram 1). Keeping food covered and wrapping food with plastic wrap will also help to reduce the odours inside your refrigerator.

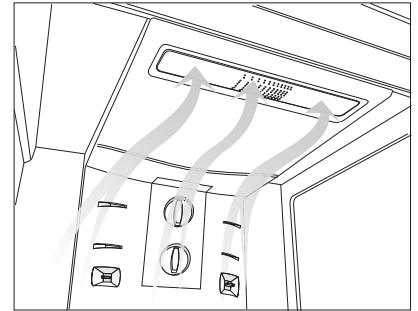

Diagram 1

## Bottle Snugger operation (where fitted)

The bottle snugger is used to prevent bottles from falling over. The snugger consists of two parts, a sliding front, and a rotating retainer ring. The retainer ring can be rotated through 360° but has positive locations for horizontal and vertical positions.

The snugger can be used in two positions:

### Horizontal

When the snugger ring is horizontal (A), any item that fits within the ring can simply be placed inside it.

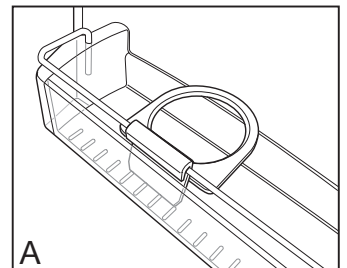

### Vertical

When the snugger ring is vertical (B), it is possible to simply slide the snugger along the bottle retainer bar until it is pushed up against a bottle. Note: the bottle should be constrained on the other side by either the end of the bin or other adjacent bottles.

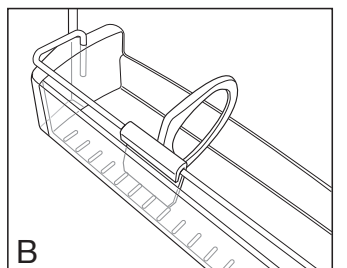

# 5 - Care & Maintenance

## Freezer Baskets (where fitted)

Freezer baskets and a freezer shelf are fitted to bottom freezer refrigerators. Wire baskets are used to provide easy visibility of the contents. Both the baskets and the shelf pull out for easy access and have a stop to prevent the basket and shelf being pulled out to far.

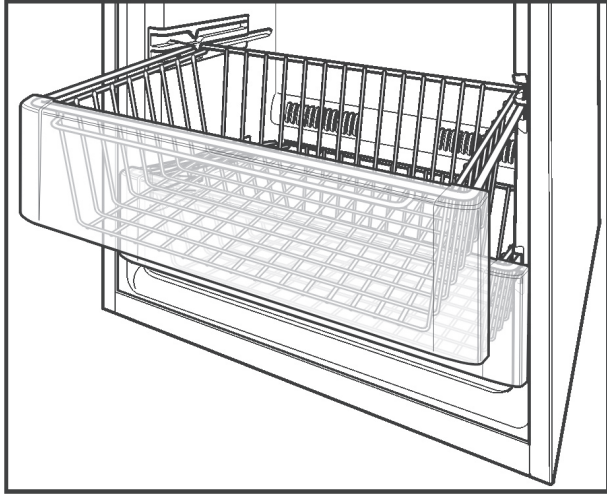

To remove the basket or shelf, pull it out until it hits the stop then lift the front to unhook the stop while continuing to pull forward.

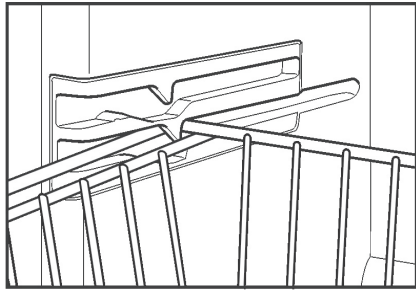

## Changing the Light Bulb

### Food Compartment

Step 1. Switch off the power at the power point and remove the refrigerator's power cord from the power point.

Step 2. Remove shelves.

Step 3. Carefully unclip the light cover. You do this by pulling the upper part of the cover towards the front of the cabinet. (See Diagram below).

Step 4. Unscrew the light bulb and replace it with a bulb that is the same as the original.

Step 5. Replace the light cover by hooking the light cover lugs into the bottom of the housing and pressing the upper part of the cover until it clips in.

Step 6. Replace shelves.

Step 7. Wait 5 minutes to ensure pressures in the refrigeration system are equalized. Then turn the refrigerator on at the power point.

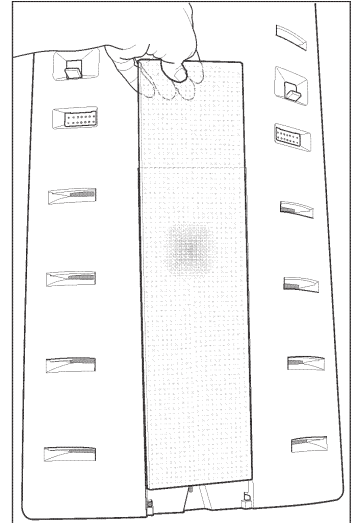

### Freezer Compartment (where fitted)

Step 1. Switch off the power at the power point and remove the refrigerator's power cord from the power point.

Step 2. Carefully unclip the light cover. You do this by pulling the light cover tab at the rear towards the front of the cabinet. (See Diagram below)

Step 3. Unscrew the light bulb and replace it with a bulb that is the same as the original.

Step 4. Replace the light cover by hooking the light cover lugs into the front of the housing and pressing the rear of the cover up until it clips in.

Step 5. Wait 5 minutes to ensure pressures in the refrigeration system are equalized. Then turn the refrigerator on at the power point.

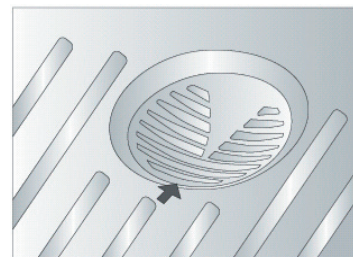

## Cleaning the refrigerator



**BEFORE CLEANING:- REMOVE THE POWER CORD FROM THE POWER SOCKET. THIS WILL MAKE SURE THERE IS NO CHANCE OF GETTING AN ELECTRIC SHOCK.**

### Exterior

#### Cabinet

It is a good idea to polish the cabinet at least once a year, using a high grade wax like the one you use on your car. After that, an occasional wipe over with a clean, damp cloth will help remove finger marks.

**NOTE:** Do not wax plastic parts or decorative trim. Wash these in warm (not hot) water using an unscented detergent.

#### Doors - painted

Clean as described above for the cabinet.

#### Doors - stainless steel

Your stainless steel appliance is manufactured from a mark resistant stainless steel. This stainless steel has a special advanced protective coating that eases the removal of marks such as finger prints and water spots. To keep your stainless steel refrigerator looking at its best, you should clean it regularly. You should only clean the stainless steel doors with luke-warm soapy water and a soft cloth, rinsing with clean water and then wipe the surface with clean water and a soft clean cloth to remove soap residue.

It is important to wipe in the direction of the grain of the stainless steel to avoid undue marking of the surface.



**DONOTUSESTAINLESSSTEELCLEANERS, ABRASIVE PADS OR OTHER CLEANERS AS THEY ARE LIKELY TO SCRATCH THE SURFACE. DAMAGE TO THIS PRODUCT AFTER DELIVERY IS NOT COVERED BY YOUR WARRANTY**

### Interior

You should clean the refrigerator interior regularly. It will be easiest to clean when the food supply is low. Wash the interior with a soft cloth and use an unscented mild soap with luke-warm water. Thoroughly dry all surfaces and removable parts. Avoid getting water on refrigerator controls. If you have taken out any removable parts, replace them and switch the power on before re-stocking the refrigerator with food. Naturally, you should keep the interior of your refrigerator hygienic by promptly and thoroughly wiping up any food spills.

#### Keep the door seals clean

Take care to keep door seals clean. Sticky food and drink can cause seals to stick to the cabinet and tear when you open the door. Wash seal with a mild detergent and warm

water. Rinse thoroughly and dry.

**WARNING:- Never use hot water, solvents, commercial kitchen cleaners, aerosol cleaners, metal polishes, caustic or abrasive cleaners, or scourers to clean this appliance, as they will damage it. Many commercially available cleaning products and detergents contain solvents that will damage your refrigerator. When cleaning, use only a soft cloth with an unscented mild soap and luke warm water.**

## General Information

### Safety

It is important to use your refrigerator safely. This means you need to supervise young children and infirm persons when they use it. You need to make sure that young children do not play with the refrigerator. Follow the tips below.

#### DOs

- Check the power point is properly grounded - if you are not sure get an electrician to check it.
- Switch off the refrigerator at the power point before you clean or move it.
- If the supply cord is damaged you should have it replaced by the manufacturer, it's service agent or similarly qualified person. This will prevent a safety hazard.

#### DON'Ts

- Never let children play with the refrigerator.
- Never store spray cans, explosive liquids or flammable liquids in the refrigerator.
- Never store fizzy drinks in the freezer compartment.
- Never lick icy foods when they first come out of the freezer. This can freeze burn your lips and mouth.
- Never try to repair the refrigerator yourself.
- Never use electric heaters or dryers to defrost the freezer because you can receive an electric shock.
- Never use electrical appliances inside the food storage areas.
- This refrigerator contains insulation formed with flammable blowing gases. For safety reasons, take care when you dispose of it.
- Do not damage the refrigeration circuit.



**WARNING:- When you dispose of your old refrigerator, remove any doors. Children can suffocate if they get trapped inside.**



# Care & Maintenance

## What to do before calling for service

If you think something may be wrong with your refrigerator, you can carry out some easy checks before calling for service. You may locate the problem, sparing yourself from inconvenience and saving time and money.

Problem	Solution
When your appliance is not operating	<ul style="list-style-type: none"> <li>• Check that the power cord is plugged into the power outlet properly and that the outlet is switched 'ON'.</li> <li>• Try running another appliance from the power outlet. If no power is coming from the outlet you may have blown a fuse or tripped a circuit of your household power supply.</li> <li>• Try adjusting the temperature control to a slightly "colder" position.</li> <li>• It is normal for the freezer fan NOT to operate during the automatic defrost cycle, or for a short time after the refrigerator is switched on.</li> </ul>
When there is refrigerator noise	<p>Modern refrigerator/freezers with increased storage capacity use high speed compressors. These can provide a seemingly high level of sound which is quite normal.</p> <p>Normal operational sounds include:</p> <ul style="list-style-type: none"> <li>• occasional gurgling, similar to water boiling.</li> <li>• air flow noise (air circulates because of a small fan).</li> <li>• a popping noise heard during automatic defrost.</li> <li>• a clicking noise heard just before the compressor starts (this is merely the automatic switching action of the temperature control, turning the compressor on or off).</li> </ul> <p>Other strange sounds may mean that you need to check and take action.</p> <p>For example, noises may mean that:</p> <ul style="list-style-type: none"> <li>• the cabinet is not level.</li> <li>• the floor is uneven or weak.</li> <li>• bottles are badly placed and rattling.</li> <li>• there are vibrations from an object on top of or behind or beside the refrigerator.</li> <li>• the back of the refrigerator cabinet is touching the wall.</li> </ul> <p>Remember it is quite normal for noise to seem louder just after the refrigerator starts operating.</p>
If there are odours inside the refrigerator	<ul style="list-style-type: none"> <li>• the interior may need cleaning.</li> <li>• some foods produce odours.</li> <li>• some containers and wrapping can cause odours.</li> <li>• ask yourself if the odour started about the same time you started storing something unusual.</li> </ul>
When the motor seems to run more than expected	<p>Your new refrigerator provides you with large capacities in both the refrigerator section and the separate freezer. It is normal for the motor to operate frequently. However, to keep operation to a minimum, check the following:</p> <ul style="list-style-type: none"> <li>• Are doors kept open too long or too often?</li> <li>• Are controls set too cold? See "CONTROLLING THE TEMPERATURE".</li> <li>• Have large amounts of warm food just recently been stored? Summer, festive seasons and holidays usually mean a lot more work for your refrigerator.</li> <li>• If the day is hot or the room is very warm, the refrigerator will need to run more than normal.</li> <li>• The refrigerator will run more that normal just after you install it or when it has been turned off for a long time.</li> </ul>

# Care & Maintenance

Problem	Solution
If the temperature in the refrigerator is too warm	<ul style="list-style-type: none"> <li>• Check that the refrigerator has enough clearance at the sides, back and top. Refer to the installation Instructions at the front of this booklet.</li> <li>• refer to “CONTROLLING THE TEMPERATURE”.</li> <li>• you may have kept the door open too long or too frequently.</li> <li>• food containers or packaging may be holding a door open.</li> </ul>
If the temperature in the refrigerator is too cold	<ul style="list-style-type: none"> <li>• refer to “CONTROLLING THE TEMPERATURE”.</li> <li>• increase the temperature to avoid high energy consumption.</li> </ul>
If the doors will not close	<ul style="list-style-type: none"> <li>• check whether the top of the refrigerator is tilted back 10-15mm to allow the doors to self close.</li> <li>• check whether something is holding the door open.</li> </ul> <p>It is normal for the freezer door to momentarily open and re-close, when the food compartment door is being closed. If the freezer stays open it indicates that the refrigerator cabinet needs to be tilted backwards a little further. If you call a service person to solve this problem you will be charged for the cost of the service call, as this is not a warranty fault.</p>
If heavy frosting occurs in the freezer	<p>Make sure you fully close the freezer and fresh food doors after you load or remove food from these compartments. If the doors are left partly open a heavy frost will coat the inside of the freezer. If a frost develops, remove it. Take care to properly close the doors and the frost will not reoccur.</p>
If water drips on the floor.	<p>The defrost water tray, (located on the compressor at the back of the cabinet), may not be properly positioned. Otherwise, the drain tube may not be properly positioned to direct water into this tray. You may need to pull the refrigerator away from the wall to check the tray and tube.</p>

## If you still require service

If you have a problem, and the problem persists after you have made the checks mentioned above, contact your nearest Service Centre or the dealer you bought the refrigerator from. Be ready to quote the model number, which is stated on the label on the refrigerator section inner plastic compartment liner wall.



For service and spares please call:

Australia

Service 13 13 49

Spares 13 13 50

New Zealand

Service & spares: 0800 10 66 10



©2004 ELECTROLUX HOME PRODUCTS PTY LTD A.B.N 51 004 762 341

 ***The Electrolux Group. The world's No.1 choice***

***KITCHEN, CLEANING AND OUTDOOR APPLIANCES***

[www.electrolux.com.au](http://www.electrolux.com.au)

EAN barcode:

9314163683620

Piece Number: 1446049  
Date of issue: June 2004

## Free Manuals Download Website

<http://myh66.com>

<http://usermanuals.us>

<http://www.somanuals.com>

<http://www.4manuals.cc>

<http://www.manual-lib.com>

<http://www.404manual.com>

<http://www.luxmanual.com>

<http://aubethermostatmanual.com>

Golf course search by state

<http://golfingnear.com>

Email search by domain

<http://emailbydomain.com>

Auto manuals search

<http://auto.somanuals.com>

TV manuals search

<http://tv.somanuals.com>