

## WE'RE THINKING OF YOU

Thank you for purchasing an Electrolux appliance. You've chosen a product that brings with it decades of professional experience and innovation. Ingenious and stylish, it has been designed with you in mind. So whenever you use it, you can be safe in the knowledge that you'll get great results every time.

Welcome to Electrolux.

Visit our website for:



Get usage advice, brochures, trouble shooter, service information:

**[www.electrolux.com/webselfservice](http://www.electrolux.com/webselfservice)**



Register your product for better service:

**[www.registerelectrolux.com](http://www.registerelectrolux.com)**



Buy Accessories, Consumables and Original spare parts for your appliance:

**[www.electrolux.com/shop](http://www.electrolux.com/shop)**

## CUSTOMER CARE AND SERVICE

Always use original spare parts.

When contacting our Authorised Service Centre, ensure that you have the following data available: Model, PNC, Serial Number.

The information can be found on the rating plate.

 Warning / Caution-Safety information

 General information and tips

 Environmental information

Subject to change without notice.

# CONTENTS

---

<b>1. SAFETY INFORMATION</b> .....	<b>5</b>
1.1 Children and vulnerable people safety.....	5
1.2 General Safety.....	5
<b>2. SAFETY INSTRUCTIONS</b> .....	<b>7</b>
2.1 Installation.....	7
2.2 Electrical connection.....	7
2.3 Use.....	7
2.4 Steam Cooking.....	8
2.5 Care and cleaning.....	9
2.6 Internal lighting.....	9
2.7 Service.....	9
2.8 Disposal.....	9
<b>3. PRODUCT DESCRIPTION</b> .....	<b>10</b>
3.1 General overview.....	10
3.2 Accessories.....	10
<b>4. HOW TO TURN OVEN ON AND OFF</b> .....	<b>12</b>
4.1 Control panel.....	12
4.2 Display.....	12
<b>5. BEFORE FIRST USE</b> .....	<b>15</b>
5.1 Initial Cleaning .....	15
5.2 First Connection.....	15
5.3 Wireless connection.....	15
5.4 Software Licences.....	16
5.5 How to set: Water hardness.....	16
<b>6. DAILY USE</b> .....	<b>18</b>
6.1 How to set: Heating Functions.....	18
6.2 How to use: Water Drawer.....	19
6.3 How to set: Steamify - Steam cooking.....	20
6.4 How to set: SousVide Cooking.....	21
6.5 How to set: Assisted Cooking.....	22
6.6 Heating Functions.....	23
<b>7. CLOCK FUNCTIONS</b> .....	<b>27</b>
7.1 Clock functions description.....	27
7.2 How to set: Clock functions.....	27
<b>8. HOW TO USE: ACCESSORIES</b> .....	<b>31</b>
8.1 Inserting accessories.....	31
8.2 Food Sensor.....	31
8.3 Using Telescopic Runners.....	34
<b>9. ADDITIONAL FUNCTIONS</b> .....	<b>36</b>
9.1 Automatic Switch-off.....	36
9.2 Cooling fan.....	36
<b>10. HINTS AND TIPS</b> .....	<b>37</b>
10.1 Cooking recommendations.....	37
10.2 Moist Fan Baking.....	37

# CONTENTS

---

10.3 Moist Fan Baking - recommended accessories.....	37
10.4 Cooking tables for test institutes.....	38
<b>11. CARE AND CLEANING.....</b>	<b>42</b>
11.1 Notes on cleaning.....	42
11.2 Recommended cleaning products.....	42
11.3 How to remove: Shelf supports.....	42
11.4 How to use: Steam Cleaning.....	43
11.5 How to use: Cleaning Reminder.....	43
11.6 How to use: Descaling.....	44
11.7 How to use: Descaling reminder.....	44
11.8 How to use: Steam generation system - Rinsing.....	44
11.9 How to use: Drying reminder.....	45
11.10 How to use: Drying.....	45
11.11 How to remove and install: Door.....	45
11.12 How to replace: Lamp.....	47
<b>12. TROUBLESHOOTING.....</b>	<b>49</b>
12.1 What to do if.....	49
12.2 How to manage: Error codes.....	51
12.3 Service data.....	52
<b>13. ENERGY EFFICIENCY.....</b>	<b>53</b>
13.1 Product Information Sheet.....	53
13.2 Energy saving.....	53
<b>14. MENU STRUCTURE.....</b>	<b>55</b>
14.1 Menu.....	55
14.2 Submenu for: Cleaning.....	55
14.3 Submenu for: Options.....	56
14.4 Submenu for: Connections.....	56
14.5 Submenu for: Setup.....	56
14.6 Submenu for: Service.....	57
<b>15. IT'S EASY!.....</b>	<b>58</b>
<b>16. TAKE A SHORTCUT!.....</b>	<b>60</b>

# 1. ⚠ SAFETY INFORMATION

---

Before the installation and use of the appliance, carefully read the supplied instructions. The manufacturer is not responsible for any injuries or damages that are the result of incorrect installation or usage. Always keep the instructions in a safe and accessible location for future reference.

## 1.1 Children and vulnerable people safety

- This appliance can be used by children aged from 8 years and above and persons with reduced physical, sensory or mental capabilities or lack of experience and knowledge if they have been given supervision or instruction concerning the use of the appliance in a safe way and understand the hazards involved.
- Children between 3 and 8 years of age and persons with very extensive and complex disabilities shall be kept away from the appliance unless continuously supervised.
- Children of less than 3 years of age should be kept away from the appliance unless continuously supervised.
- Do not let children play with the appliance and mobile devices with My Electrolux.
- Keep all packaging away from children and dispose of it appropriately.
- Keep children and pets away from the appliance when it operates or when it cools down. Accessible parts may become hot during use.
- If the appliance has a child safety device, it should be activated.
- Children shall not carry out cleaning and user maintenance of the appliance without supervision.

## 1.2 General Safety

- Only a qualified person must install this appliance and replace the cable.

## SAFETY INFORMATION

---

- **WARNING:** The appliance and its accessible parts become hot during use. Care should be taken to avoid touching heating elements.
- Always use oven gloves to remove or put in accessories or ovenware.
- Before carrying out any maintenance, disconnect the appliance from the power supply.
- **WARNING:** Ensure that the appliance is switched off before replacing the lamp to avoid the possibility of electric shock.
- Do not use the appliance before installing it in the built-in structure.
- Do not use a steam cleaner to clean the appliance.
- Do not use harsh abrasive cleaners or sharp metal scrapers to clean the glass door since they can scratch the surface, which may result in shattering of the glass.
- If the mains power supply cable is damaged, it must be replaced by the manufacturer, its Authorised Service Centre or similarly qualified persons to avoid an electrical hazard.
- To remove the shelf supports first pull the front of the shelf support and then the rear end away from the side walls. Install the shelf supports in the opposite sequence.
- Use only the food sensor (core temperature sensor) recommended for this appliance.

## 2. SAFETY INSTRUCTIONS

---

### 2.1 Installation

 **WARNING!**

Only a qualified person must install this appliance.

- Remove all the packaging.
- Do not install or use a damaged appliance.
- Follow the installation instructions supplied with the appliance.
- Always take care when moving the appliance as it is heavy. Always use safety gloves and enclosed footwear.
- Do not pull the appliance by the handle.
- Keep the minimum distance from other appliances and units.
- Install the appliance in a safe and suitable place that meets installation requirements.
- The appliance is equipped with an electric cooling system. It must be operated with the electric power supply.

### 2.2 Electrical connection

 **WARNING!**

Risk of fire and electric shock.

- All electrical connections should be made by a qualified electrician.
- The appliance must be earthed.
- Make sure that the parameters on the rating plate are compatible with the electrical ratings of the mains power supply.
- Always use a correctly installed shockproof socket.
- Do not use multi-plug adapters and extension cables.
- Make sure not to cause damage to the mains plug and to the mains cable. Should the mains cable need to be replaced, this must be carried out by our Authorised Service Centre.
- Do not let mains cables touch or come near the appliance door or the niche below the appliance, especially when it operates or the door is hot.
- The shock protection of live and insulated parts must be fastened in such a way that it cannot be removed without tools.
- Connect the mains plug to the mains socket only at the end of the installation. Make sure that there is access to the mains plug after the installation.
- If the mains socket is loose, do not connect the mains plug.
- Do not pull the mains cable to disconnect the appliance. Always pull the mains plug.
- Use only correct isolation devices: line protecting cut-outs, fuses (screw type fuses removed from the holder), earth leakage trips and contactors.
- The electrical installation must have an isolation device which lets you disconnect the appliance from the mains at all poles. The isolation device must have a contact opening width of minimum 3 mm.
- This appliance complies with the E.E.C. Directives.

### 2.3 Use

 **WARNING!**

Risk of injury, burns and electric shock or explosion.

- This appliance is for household use only.

# SAFETY INSTRUCTIONS

---

- Do not change the specification of this appliance.
- Make sure that the ventilation openings are not blocked.
- Do not let the appliance stay unattended during operation.
- Deactivate the appliance after each use.
- Be careful when you open the appliance door while the appliance is in operation. Hot air can release.
- Do not operate the appliance with wet hands or when it has contact with water.
- Do not apply pressure on the open door.
- Do not use the appliance as a work surface or as a storage surface.
- Open the appliance door carefully. The use of ingredients with alcohol can cause a mixture of alcohol and air.
- Do not let sparks or open flames to come in contact with the appliance when you open the door.
- Do not put flammable products or items that are wet with flammable products in, near or on the appliance.
- Do not share your Wi-Fi password.

## **WARNING!**

Risk of damage to the appliance.

- To prevent damage or discoloration to the enamel:
  - do not put ovenware or other objects in the appliance directly on the bottom.
  - do not put aluminium foil directly on the bottom of cavity of the appliance.
  - do not put water directly into the hot appliance.
  - do not keep moist dishes and food in the appliance after you finish the cooking.
  - be careful when you remove or install the accessories.
- Discoloration of the enamel or stainless steel has no effect on the performance of the appliance.
- Use a deep pan for moist cakes. Fruit juices cause stains that can be permanent.
- This appliance is for cooking purposes only. It must not be used for other purposes, for example room heating.
- Always cook with the oven door closed.
- If the appliance is installed behind a furniture panel (e.g. a door) make sure the door is never closed when the appliance is in operation. Heat and moisture can build up behind a closed furniture panel and cause subsequent damage to the appliance, the housing unit or the floor. Do not close the furniture panel until the appliance has cooled down completely after use.

## 2.4 Steam Cooking

### **WARNING!**

Risk of burns and damage to the appliance.

- Released Steam can cause burns:
  - Be careful when you open the appliance door when the function is activated. Steam can release.
  - Open the appliance door with care after the steam cooking operation.



## 2.5 Care and cleaning

### **WARNING!**

Risk of injury, fire, or damage to the appliance.

- Before maintenance, deactivate the appliance and disconnect the mains plug from the mains socket.
- Make sure the appliance is cold. There is the risk that the glass panels can break.
- Replace immediately the door glass panels when they are damaged. Contact the Authorised Service Centre.
- Be careful when you remove the door from the appliance. The door is heavy!
- Clean regularly the appliance to prevent the deterioration of the surface material.
- Clean the appliance with a moist soft cloth. Only use neutral detergents. Do not use any abrasive products, abrasive cleaning pads, solvents or metal objects.
- If you use an oven spray, follow the safety instruction on it's packaging.
- Do not clean the catalytic enamel (if applicable) with any kind of detergent.

## 2.6 Internal lighting

### **WARNING!**

Risk of electric shock.

- The type of light bulb or halogen lamp used for this appliance is for household appliances only. Do not use it for house lighting.
- Before replacing the lamp, disconnect the appliance from the power supply.
- Only use lamps with the same specifications.

## 2.7 Service

- To repair the appliance contact the Authorised Service Centre.
- Use original spare parts only.

## 2.8 Disposal

### **WARNING!**

Risk of injury or suffocation.

- Disconnect the appliance from the mains supply.
- Cut off the mains electrical cable close to the appliance and dispose of it.
- Remove the door catch to prevent children or pets from becoming trapped in the appliance.

# 3. PRODUCT DESCRIPTION

## 3.1 General overview

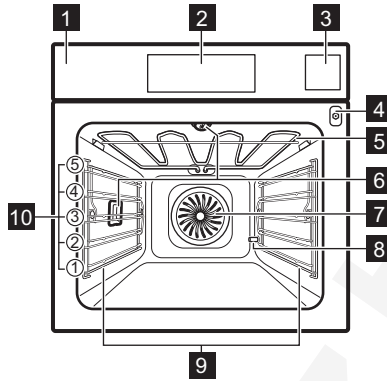

- 1** Control panel
- 2** Display
- 3** Water drawer
- 4** Socket for the food sensor
- 5** Heating element
- 6** Lamp
- 7** Fan
- 8** Descaling pipe outlet
- 9** Shelf support, removable
- 10** Shelf positions

## 3.2 Accessories

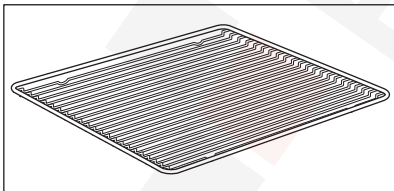

### Wire shelf

For cookware, cake tins, roasts.

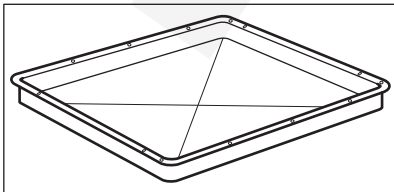

### Baking tray

For cakes and biscuits.

# PRODUCT DESCRIPTION

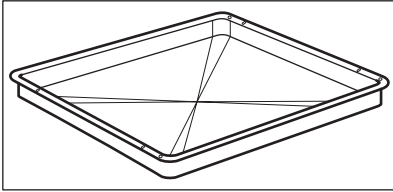

## Grill- / Roasting pan

To bake and roast or as a pan to collect fat.

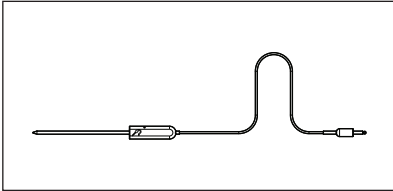

## Food Sensor

To measure the temperature inside food.

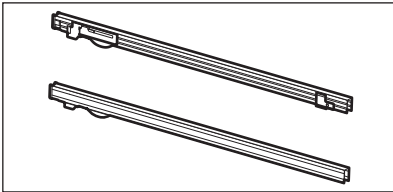

## Telescopic runners

For inserting and removing trays and wireshelf more easily.

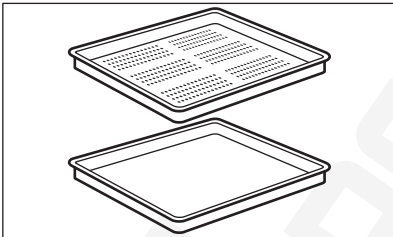

## Steam set

One unperforated and one perforated food container.

The steam set drains the condensing water away from the food during steam cooking. Use it to prepare vegetables, fish, chicken breast. The set is not suitable for food that needs to soak in the water e.g. rice, polenta, pasta.

# 4. HOW TO TURN OVEN ON AND OFF

## 4.1 Control panel

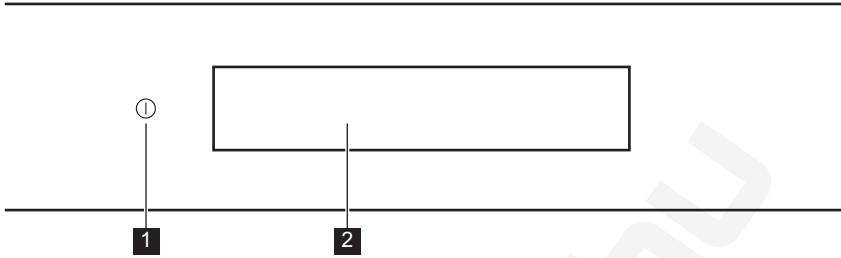

	Function	Comment
<b>1</b>	On / Off	Press and hold to turn the oven on and off.
<b>2</b>	Display	Shows the current settings of the oven.

### Gestures

 <b>Press</b>	 <b>Move</b>	 <b>Press and hold</b>
Touch the surface with fingertip.	Slide fingertip over the surface without losing contact.	Touch the surface for 3 seconds.

## 4.2 Display

	After turning on, the display shows main screen with heating functions and default temperature.
	If you do not use the oven for 2 minutes, the display goes to standby.
	When you cook, the display shows the set functions and other available options.

# HOW TO TURN OVEN ON AND OFF

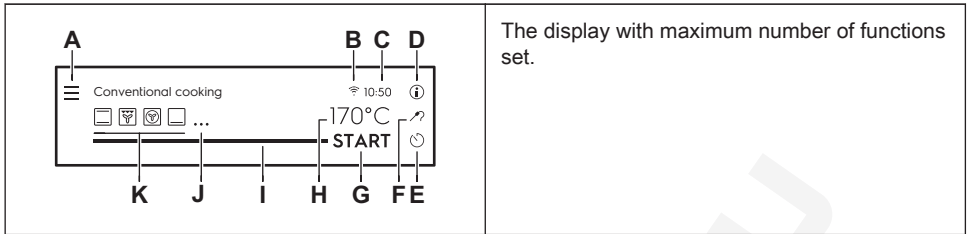





The display with maximum number of functions set.



- A. Menu / Back
- B. Wi-Fi
- C. Time of Day
- D. Information
- E. Timer
- F. Food Sensor
- G. START / STOP
- H. Temperature
- I. Progress Bar / Slider
- J. More
- K. Heating Functions

## Display indicators





**Basic indicators** - to navigate on the display.

 To confirm the selection / setting.	 To confirm the selection / setting or to go one level back in the menu.	 To go one level back in the menu / undo last action.	 To turn the options on and off.
--	--	---	--

**Sound alarm function indicators** - when the set time of cooking ends, the signal sounds.



 The function is on.	 The function is on. Cooking stops automatically.	 Sound Alarm is off.
--	---	--

## Timer indicators

 To set the function: Set start time.	 To cancel the setting.	 The timer starts after closing the oven door.	 The timer starts when the oven reaches the set temperature.	 The timer starts when cooking starts.
---	---	--	--	--

# HOW TO TURN OVEN ON AND OFF

---



<b>Display indicators</b>	
<b>Door function indicators</b>	
 The oven door is locked.	
<b>Wi-Fi indicators</b> - the oven can be connected to Wi-Fi.	
 Wi-Fi connection is turned on.	 Wi-Fi connection is turned off.

## 5. BEFORE FIRST USE

### **WARNING!**

Refer to Safety chapters.

### 5.1 Initial Cleaning

		
<p><b>Step 1</b> Remove all accessories and removable shelf supports from the oven.</p>	<p><b>Step 2</b> Clean the oven and the accessories before the first use. Refer to "Care and cleaning" chapter.</p>	<p><b>Step 3</b> Put the accessories and the removable shelf supports back to their initial position.</p>

### 5.2 First Connection



The display shows welcome message after the first connection.

You have to set: Language, Display Brightness, Buzzer Volume, Water hardness, Time of Day.

### 5.3 Wireless connection

To connect the oven you need:

- Wireless network with the Internet connection.

<p><b>Step 1</b></p>	<p>Turn on the oven.</p>
<p><b>Step 2</b></p>	<p>Press Menu / Settings / Connections.</p>
<p><b>Step 3</b></p>	<p>Slide or press  to turn on Wi-Fi.</p>
<p><b>Step 4</b></p>	<p>Choose wireless network with the Internet connection. The oven wireless module will start within 90 seconds.</p>
<p>To configure the wireless connection at any other time press  on the display.</p>	

#### Take a shortcut!



<p>Frequency</p>	<p>2412 - 2484 MHz</p>
<p>Protocol</p>	<p>IEEE 802.11b DSSS/802.11g/n OFDM</p>

# BEFORE FIRST USE

Max Power	EIRP < 20 dBm (100 mW)
-----------	------------------------

## 5.4 Software Licences

The oven software contains copyrighted software that is licensed under the BSD, fontconfig, FTL, GPL-2.0, LGPL-2.0, LGPL-2.1, libJpeg, zLib/ libpng, MIT, OpenSSL / SSLEAY ISC, Apache 2.0 and others.
Check the full copy of the licence in: Basic Settings / Service / Licence.
You can download the source code of the open source software by following the hyperlink present on the product web page.
Look for the oven model and Wi-Fi Module Software version on <a href="http://electrolux.opensoftware-repository.com">http://electrolux.opensoftware-repository.com</a> inside "NIUX" folder.

## 5.5 How to set: Water hardness

When you connect the oven to the mains you have to set the water hardness level. The table below shows water hardness range (dH) with the corresponding Calcium deposit and the quality of water.



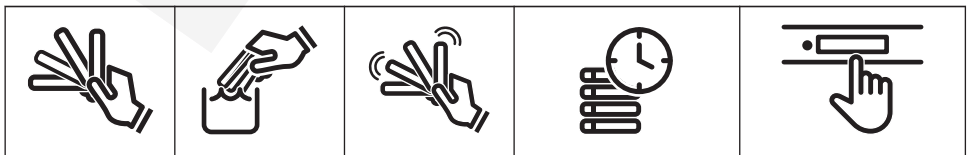

Water hardness		Calcium deposit (mmol/l)	Calcium deposit (mg/l)	Water classification
Class	dH			
1	0 - 7	0 - 1.3	0 - 50	Soft
2	7 - 14	1.3 - 2.5	50 - 100	Moderately hard
3	14 - 21	2.5 - 3.8	100 - 150	Hard
4	over 21	over 3.8	over 150	Very hard

When water hardness exceeds the values in the table, fill the water drawer with bottled water.





<p><b>Step 1</b> Take the four colour test strip supplied with the steam set in the oven.</p>	<p><b>Step 2</b> Put all the reaction zones of the strip into water for about one second. Do not put the strip into running water.</p>	<p><b>Step 3</b> Shake the strip to remove the excess of water.</p>	<p><b>Step 4</b> Wait one minute and check water hardness with the table above. The colours of the reaction zones continue to change. Do not check water hardness later than one minute after test.</p>	<p><b>Step 5</b> Set water hardness: Menu / Settings / Setup / Water hardness.</p>
---	--	---	---	--

Test strip	Water hardness
	1
	2
	3
	4
<p>You can change water hardness in the menu: Settings / Setup / Water hardness.</p>	

## 6. DAILY USE

### **WARNING!**

Refer to Safety chapters.

### 6.1 How to set: Heating Functions

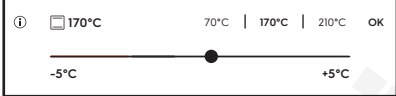
<b>Step 1</b>	Turn on the oven.
<b>Step 2</b>	Select a heating function. The display shows the default heating functions. To see more heating functions press ● ● ● .
<b>Step 3</b>	Press °C. Display goes into the temperature settings. 
<b>Step 4</b>	Move the finger on the slider to set the temperature.
<b>Step 5</b>	Press OK.
<b>Step 6</b>	Press START . Food Sensor can be plugged at any time before or during cooking process.
<b>Step 7</b>	Press STOP to turn off the heating function.
<b>Step 8</b>	Turn off the oven.

#### Take a shortcut!



## 6.2 How to use: Water Drawer

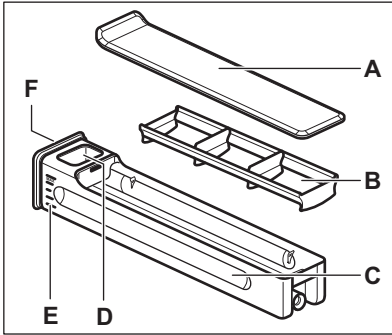

- A. Lid
- B. Wave-breaker
- C. Drawer body
- D. Water-filling hole
- E. Scale
- F. Front button

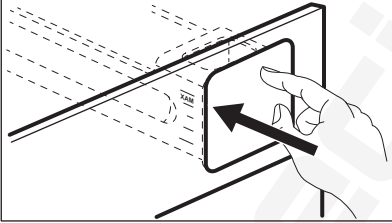
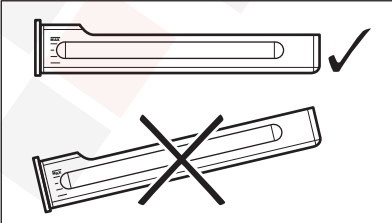
<p><b>Step 1</b></p>	<p>Push the front button of the water drawer. It will pop out of the oven.</p> 	
<p><b>Step 2</b></p>	<p>Fill the water drawer up to the maximum level mark. You can do it in two ways:</p> <p><b>A:</b> Leave the water drawer inside the oven and pour the water from a container,</p> <p><b>B:</b> Remove the water drawer from the oven and fill it from a water tap.</p>	
<p><b>Step 3</b></p>	<p>Carry the drawer in the horizontal position to avoid water spilling.</p> 	
<p><b>Step 4</b></p>	<p>When you fill the water drawer, insert it in the same position. Push the front button until the water drawer is inside the oven.</p>	
<p><b>Step 5</b></p>	<p>Empty the water drawer after each use.</p>	



## CAUTION!

Keep the water drawer away from hot surfaces.

## 6.3 How to set: Steamify - Steam cooking

<b>Step 1</b>	Turn on the oven.
<b>Step 2</b>	Press  to set a steam heating function.
<b>Step 3</b>	Press °C to set the temperature. Display goes into the temperature settings.
<b>Step 4</b>	Move the finger on the slider to set the temperature. Type of the steam heating function depends on the set temperature.
<b>Steam for Steaming</b> 50 - 100 °C	For steaming vegetables, grains, legumes, seafood, terrines and spoon desserts.
<b>Steam for Stewing</b> 105 - 130 °C	For cooking stewed and braised meat or fish, bread and poultry, as well as cheesecakes and casseroles.
<b>Steam for Gentle Crisping</b> 135 - 150 °C	For meat, casseroles, stuffed vegetables, fish and gratin. Owing to the combination of steam and heat the meat gets a juicy and tender texture along with a crusty surface. If you set the timer, grill function turns on automatically in the last minutes of the cooking process to give dish a gentle gratin.
<b>Steam for Baking and Roasting</b> 155 - 230 °C	For roasted and baked dishes meat, fish, poultry, filled puff pastry, tarts, muffins, gratin, vegetables and bakery dishes. If you set the timer and put the food on the first level, bottom heat function turns on automatically in the last minutes of the cooking process to give dish a crispy bottom.
<b>Step 5</b>	Press OK to confirm.



<p><b>Step 6</b></p>	<p>Fill the water drawer with cold water to the maximum level (around 950 ml). The water supply is sufficient for approximately 50 minutes. Use the scale on the water drawer.</p> <div style="border: 1px solid black; padding: 5px; margin-top: 10px;"> <p><b>⚠ WARNING!</b> Use only cold tap water. Do not use filtered (demineralised) or distilled water. Do not use other liquids. Do not pour flammable or alcoholic liquids into the water drawer.</p> </div>
<p><b>Step 7</b></p>	<p>Dry the wet water drawer with a soft cloth. Push the water drawer to its initial position.</p>
<p><b>Step 8</b></p>	<p>Press <b>START</b> . Steam appears after approximately 2 minutes. When the oven reaches the set temperature, the signal sounds.</p>
<p><b>Step 9</b></p>	<p>When the water drawer is running out of water, the signal sounds. Refill the water drawer. At the end of steam cooking, the cooling fan runs quicker to remove steam. The signal sounds at the end of the cooking time.</p>
<p><b>Step 10</b></p>	<p>Turn off the oven.</p>
<p><b>Step 11</b></p>	<p>Empty the water drawer after steam cooking is completed.</p>
<p><b>Step 12</b></p>	<p>Residual water can condensate in the cavity. After cooking, open the door carefully to avoid the water spillage. When the oven is cold, dry the cavity with a soft cloth.</p>

## Take a shortcut!



## 6.4 How to set: SousVide Cooking

<p><b>Step 1</b></p>	<p>Turn on the oven. The display shows the default heating functions. To see more heating functions press ● ● ● .</p>
<p><b>Step 2</b></p>	<p>Press  to set the function: SousVide Cooking.</p>
<p><b>Step 3</b></p>	<p>Press <b>OK</b>.</p>

<b>Step 4</b>	Press  to set the timer.
<b>Step 5</b>	Press OK.
<b>Step 6</b>	Press  to set the temperature and confirm.
<b>Step 7</b>	Press START .
<b>Step 8</b>	Residual water can accumulate on the vacuum bags and in the cavity. After cooking, open the door carefully to avoid water spillage. Use a plate and a towel to take out the vacuum bags. When the oven is cold, remove the water from the bottom of the cavity with a sponge. Dry the cavity with a soft cloth.

### Take a shortcut!





## 6.5 How to set: Assisted Cooking

Every dish in this submenu has a recommended function and temperature. Temperature and time can be adjusted manually according to the user's preference.

For some of the dishes you can also cook with:

- Weight Automatic
- Food Sensor









<b>Step 1</b>	Press  .
<b>Step 2</b>	Press  to enter Assisted Cooking.
<b>Step 3</b>	Choose a dish or food type.
<b>Step 4</b>	Press START .

### Take a shortcut!











## 6.6 Heating Functions

### Standard Heating Functions

Heating function	Application
 <p><b>Grill</b></p>	To grill flat food and to toast bread.
 <p><b>Turbo Grilling</b></p>	To roast larger meat joints or poultry with bones on one shelf position. To make gratins and to brown.
 <p><b>True Fan Cooking</b></p>	To bake on up to three shelf positions at the same time and to dry food. Set the temperature 20 - 40 °C lower than for Conventional Cooking.
 <p><b>Frozen Foods</b></p>	To make convenience food (e.g. french fries, potato wedges or spring rolls) crispy.
 <p><b>Conventional Cooking</b></p>	To bake and roast food on one shelf position.
 <p><b>Pizza Function</b></p>	To bake pizza. To make intensive browning and a crispy bottom.
 <p><b>Bottom Heat</b></p>	To bake cakes with crispy bottom and to preserve food.
 <p><b>Steamify</b></p>	Use steam for steaming, stewing, gentle crisping, baking and roasting.







## Special Heating Functions

Heating function	Application
 Preserving	To preserve vegetables (e.g. pickles).
 Dehydrating	To dry sliced fruit, vegetables and mushrooms.
 Yogurt Function	To prepare yogurt. The lamp in this function is off.
 Plate Warming	To preheat plates for serving.
 Defrost	To defrost food (vegetables and fruit). The defrosting time depends on the amount and size of the frozen food.
 Au Gratin	For dishes such as lasagna or potato gratin. To make gratins and to brown.
 Slow Cooking	To prepare tender, succulent roasts.
 Keep Warm	To keep food warm.





Heating function	Application
 <p><b>Moist Fan Baking</b></p>	<p>This function is designed to save energy during cooking. For the cooking instructions refer to "Hints and tips" chapter, Moist Fan Baking. The oven door should be closed during cooking so that the function is not interrupted and to ensure that the oven operates with the highest energy efficiency possible. When you use this function, the temperature in the cavity may differ from the set temperature. The residual heat is used. The heating power may be reduced. For general energy saving recommendations refer to "Energy Efficiency" chapter, Energy Saving. This function was used to comply with the energy efficiency class according to EN 60350-1. When you use this function the lamp automatically turns off after 30 seconds.</p>

## Steam Oven Functions

Heating function	Application
 <p><b>SousVide Cooking</b></p>	<p>The function name refers to a method of cooking in vacuum sealed plastic pouches at low temperatures. Refer to the section SousVide Cooking below and the chapter "Hints and Tips" with the cooking tables to find more information.</p>
 <p><b>Steam Regenerating</b></p>	<p>Food reheating with steam prevents surface drying. Heat is distributed in a gentle and even way, which allows to recover taste and aroma of food as just prepared. This function can be used to reheat food directly on a plate. You can reheat more than one plate at the same time, using different shelf positions.</p>
 <p><b>Bread Baking</b></p>	<p>Use this function to prepare bread and bread rolls with a very good professional-like result in terms of crispiness, colour and crust gloss.</p>
 <p><b>Dough Proving</b></p>	<p>To speed up the rising of the yeast dough. It prevents dough surface from drying and keeps the dough elastic.</p>
 <p><b>Full Steam</b></p>	<p>For steaming vegetables, side dishes or fish.</p>
 <p><b>Humidity High</b></p>	<p>The function is suitable for cooking delicate dishes like custards, flans, terrines and fish.</p>

# DAILY USE

---

Heating function	Application
 <b>Humidity Medium</b>	The function is suitable for cooking stewed and braised meat as well as bread and sweet yeast dough. Due to the combination of steam and heat the meat gets a juicy and tender texture and yeast dough bakeries get a crispy and shiny surface.
 <b>Humidity Low</b>	The function is suitable for meat, poultry, oven dishes and casseroles. Thanks to the combination of steam and heat, meat gets a tender and juicy texture along with a crusty surface.

# 7. CLOCK FUNCTIONS

## 7.1 Clock functions description

Clock function	Application
Cooking time	To set the length of cooking. Maximum is 23 h 59 min.
Start Criteria	To set when the timer starts counting.
End Criteria	To set what happens when the timer ends counting.
Set start time	To postpone the start and / or end of cooking.
Time Extension	To extend cooking time.
Reminder	To set a countdown. Maximum is 23 h 59 min. This function has no effect on the operation of the oven.

## 7.2 How to set: Clock functions



How to set the clock	
Step 1	Press  on the display.
Step 2	Press: Settings / Setup / Time of Day.
Step 3	Slide and press to set the clock.



How to set cooking time	
Step 1	Choose an oven function and set the temperature.
Step 2	Press  to set the cooking time.
Step 3	Move the dot on the slider or press the preferred time icon.
Step 4	Press <b>OK</b> . Timer starts counting down immediately.



Take a shortcut!



# CLOCK FUNCTIONS

How to choose cooking start / end option	
<b>Step 1</b>	Choose an oven function and set the temperature.
<b>Step 2</b>	Press  to set cooking time.
<b>Step 3</b>	Press ● ● ● .
<b>Step 4</b>	Press Start Criteria / End Criteria.
<b>Step 5</b>	Choose preferred Start Criteria / End Criteria.
<b>Step 6</b>	Press OK or  .
Press  to cancel chosen starting or end option.	

Start criteria	Comment
-	The timer starts when you turn it on.
	The timer starts after closing the door.
→	The timer starts when cooking starts.
	The timer starts when the set temperature is reached.

End action	Comment
	When the set cooking time ends, the signal sounds.
	When the set cooking time ends, the signal sounds. Cooking stops automatically.
	When the set cooking time ends, the display shows message without sound signal.

How to delay start and end of cooking	
<b>Step 1</b>	Press  on the display.



## How to delay start and end of cooking

<b>Step 2</b>	Move the dot on the slider or press the preferred time icon.
<b>Step 3</b>	Press OK.

### Take a shortcut!



## How to delay start without setting the end of cooking

<b>Step 1</b>	Set a heating function and the temperature.
<b>Step 2</b>	Press  .
<b>Step 3</b>	Press  .
<b>Step 4</b>	Press Set start time.
<b>Step 5</b>	Move the left dot to the preferred value.
<b>Step 6</b>	Press OK.

## How to set extra time

When 10% of cooking time is left and the food seems not to be ready, you can extend cooking time. You can also change the oven function.

<b>Step 1</b>	Press the preferred time icon to extend cooking time.
<b>Step 2</b>	Also, press preferred oven function to change it.

### What if it's better to change extra time?

It's possible to reset extra time.

<b>Step 1</b>	Press  .
---------------	---

# CLOCK FUNCTIONS

---

## How to set extra time

<b>Step 2</b>	Move the dot on the slider or press one of the preferred time icons to set the time.
<b>Step 3</b>	Press <b>OK</b> .

## How to change timer settings

<b>Step 1</b>	Move the dot on the slider or use shortcuts to change the timer value.
<b>Step 2</b>	Press <b>OK</b> or press ↶ to reset changes.
You can change the set time during cooking at any time.	

## How to cancel set timer

<b>Step 1</b>	Press ⏪.
<b>Step 2</b>	Press ⊗ to cancel set timer.
<b>Step 3</b>	Press <b>OK</b> .

### Take a shortcut!



## 8. HOW TO USE: ACCESSORIES

### 8.1 Inserting accessories

A small indentation at the top increases safety. The indentations are also anti-tip devices. The high rim around the shelf prevents cookware from slipping of the shelf.

With the telescopic runners you can put in and remove the shelves more easily.

**Wire shelf:**

Push the shelf between the guide bars of the shelf support.

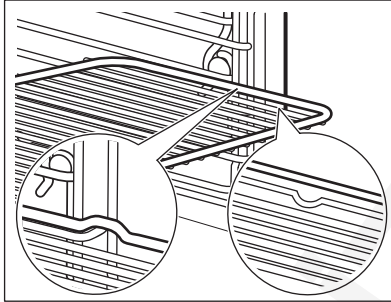

**Baking tray /  
Deep pan:**

Push the baking tray / deep pan between the guide bars of the shelf support.

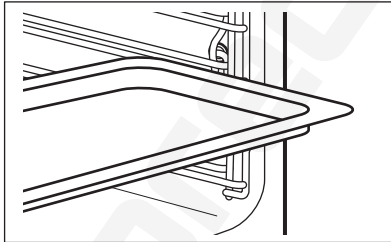

**Wire shelf and  
baking tray /  
deep pan to-  
gether:**

Push the baking tray / deep pan between the guide bars of the shelf support and the wire shelf on the guide bars above.

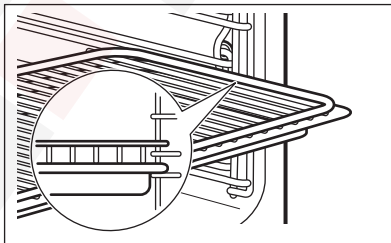

### 8.2 Food Sensor

Food Sensor measures temperature inside the food. You can use the Food Sensor with every cooking function.

There are two temperatures to be set:

- the oven temperature (minimum 120 °C),

# HOW TO USE: ACCESSORIES

---

- the food core temperature.

## CAUTION!

Use only the accessory supplied and the original replacement parts.

Directions for the best results:

- Ingredients should be at room temperature.
- The Food Sensor cannot be used for liquid dishes.
- Use recommended food core temperature settings.

During cooking the Food Sensor must be plugged in the socket and inserted in the dish.

Refer to "Hints and tips" chapter.

The oven calculates an approximate end of cooking time. It depends on the quantity of food, the set oven function and temperature.

## Cooking meat, poultry and fish

How to use: Food Sensor	
<b>Step 1</b>	Turn on the oven.
<b>Step 2</b>	Set a heating function and, if necessary, the oven temperature.
<b>Step 3</b>	Insert the Food Sensor.
<b>Meat, poultry and fish</b>	<b>Casserole</b>



## How to use: Food Sensor

Insert the tip of the Food Sensor into the centre of meat, fish, in the thickest part if possible. Make sure that at least 3/4 of the Food Sensor is inside of the dish.

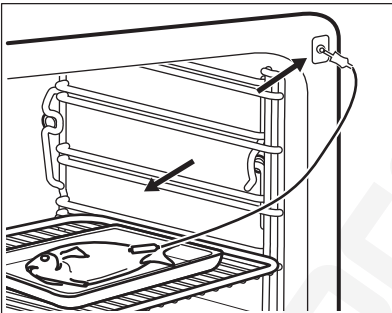
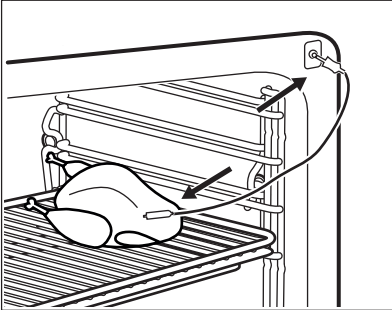

Insert the tip of the Food Sensor exactly in the centre of the casserole. The Food Sensor should be stabilized in one place during baking. Use a solid ingredient to achieve that. Use the rim of the baking dish to support the silicone handle of the Food Sensor. The tip of the Food Sensor should not touch the bottom of a baking dish. Cover the Food Sensor with the remaining ingredients.

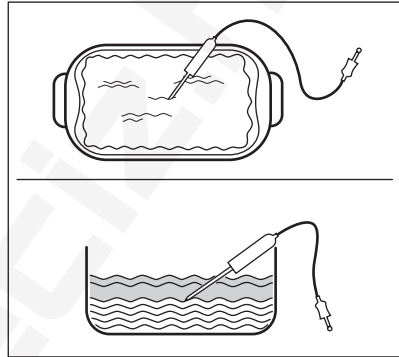

### Step 4

Plug the Food Sensor into the socket at the front of the oven. The display shows the current Food Sensor temperature.

### Step 5

Press the  to set the Food Sensor core temperature.

Press ● ● ● to set the Food Sensor options:

- Sound alarm - when food reaches core temperature, the signal sounds.
- Sound alarm and stop - when food reaches core temperature, the signal sounds and the oven stops.
- Just show temperature - the display shows the current core temperature.

### Step 6

Press the option to select. Press **OK** or .

# HOW TO USE: ACCESSORIES

## How to use: Food Sensor

### Step 7

Press **START** .  
When food reaches the set temperature, the signal sounds. You can choose to stop or to continue cooking to make sure the food is well done.

### Step 8

Remove the Food Sensor plug from the socket and remove the dish from the oven.



#### **WARNING!**

There is a risk of burns as the Food Sensor becomes hot. Be careful when you unplug it and remove it from the food.

### Take a shortcut!



## 8.3 Using Telescopic Runners

Do not oil the telescopic runners.

Make sure you push back the telescopic runners fully in the oven before you close the oven door.

With the telescopic runners you can put in and remove the shelves more easily.

### Wire shelf:

Put the wire shelf face down on the telescopic runners.

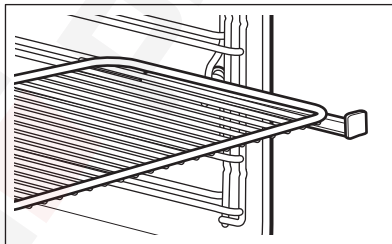

The high rim around the wire shelf is a special device to prevent the cookware from slipping.

## HOW TO USE: ACCESSORIES

**Deep pan:**

Put the deep pan on the telescopic runners.

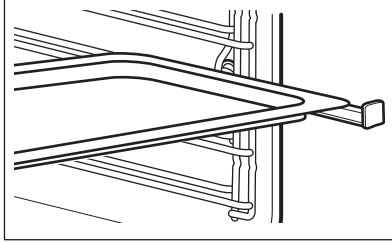

**Wire shelf and deep pan together:**

Place the wire shelf and the deep pan together on the telescopic runner.

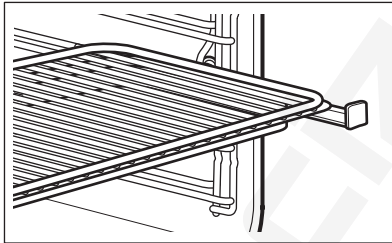



## 9. ADDITIONAL FUNCTIONS

---

### 9.1 Automatic Switch-off

For safety reasons the oven turns off automatically after some time, if a heating function works and you do not change any settings.

 (°C)	 (h)
30 - 115	12.5
120 - 195	8.5
200 - 230	5.5

The Automatic Switch-off does not work with the functions: Light, Food Sensor, Duration, End Time.

### 9.2 Cooling fan

When the oven operates, the cooling fan turns on automatically to keep the surfaces of the oven cool. If you turn off the oven, the cooling fan can continue to operate until the oven cools down.

## 10. HINTS AND TIPS

### **WARNING!**

Refer to Safety chapters.





### 10.1 Cooking recommendations

Your oven may bake or roast differently to the oven you had before. The tables below show recommended settings for temperature, cooking time and shelf position for specific types of the food.

For more cooking recommendations refer to cooking tables on our website. To find the Cooking Hints check the PNC number on the rating plate on the front frame of the oven cavity.

### 10.2 Moist Fan Baking



For the best results follow suggestions listed in the table below.

		 (°C)		 (min)
Sweet rolls, 16 pieces	baking tray or dripping pan	180	2	25 - 35
Swiss roll	baking tray or dripping pan	180	2	15 - 25
Whole fish, 0.2 kg	baking tray or dripping pan	180	3	15 - 25
Cookies, 16 pieces	baking tray or dripping pan	180	2	20 - 30
Macaroons, 24 pieces	baking tray or dripping pan	160	2	25 - 35
Muffins, 12 pieces	baking tray or dripping pan	180	2	20 - 30
Savory pastry, 20 pieces	baking tray or dripping pan	180	2	20 - 30
Short crust biscuits, 20 pieces	baking tray or dripping pan	140	2	15 - 25
Tartlets, 8 pieces	baking tray or dripping pan	180	2	15 - 25

### 10.3 Moist Fan Baking - recommended accessories

Use the dark and non-reflective tins and containers. They have better heat absorption than the light colour and reflective dishes.

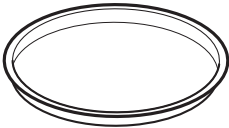
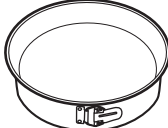





# HINTS AND TIPS

			
<b>Pizza pan</b>	<b>Baking dish</b>	<b>Ramekins</b>	<b>Flan base tin</b>
Dark, non-reflective 28 cm diameter	Dark, non-reflective 26 cm diameter	Ceramic 8 cm diameter, 5 cm height	Dark, non-reflective 28 cm diameter

## 10.4 Cooking tables for test institutes

### Information for test institutes

Tests according to: EN 60350, IEC 60350.





 <b>BAKING ON ONE LEVEL. Baking in tins</b>				
		 (°C)	 (min)	
Fatless sponge cake	True Fan Cooking	140 - 150	35 - 50	2
Fatless sponge cake	Conventional Cooking / Top / Bottom Heat	160	35 - 50	2
Apple pie, 2 tins Ø20 cm	True Fan Cooking	160	60 - 90	2
Apple pie, 2 tins Ø20 cm	Conventional Cooking / Top / Bottom Heat	180	70 - 90	1



## BAKING ON ONE LEVEL. Biscuits







Use the third shelf position.

		 (°C)	 (min)
Short bread / Pastry strips	True Fan Cooking	140	25 - 40
Short bread / Pastry strips, preheat the empty oven	Conventional Cooking / Top / Bottom Heat	160	20 - 30
Small cakes, 20 per tray, preheat the empty oven	True Fan Cooking	150	20 - 35
Small cakes, 20 per tray, preheat the empty oven	Conventional Cooking / Top / Bottom Heat	170	20 - 30



## MULTILEVEL BAKING. Biscuits

		 (°C)	 (min)		
				2 positions	3 positions
Short bread / Pastry strips	True Fan Cooking	140	25 - 45	1 / 4	1 / 3 / 5
Small cakes, 20 per tray, preheat the empty oven	True Fan Cooking	150	23 - 40	1 / 4	-





# HINTS AND TIPS



Preheat the empty oven for 5 minutes.



Grill with the maximum temperature setting.

		 (min)	
Toast	Grill	1 - 3	5
Beef steak, turn halfway through	Grill	24 - 30	4







## Information for test institutes

Tests for the function: Full Steam.

Tests according to IEC 60350.









Set the temperature to 100 °C.

	 Container (Gastro- norm)	 (g)		 (min)	
Broccoli, pre-heat the empty oven	1 x 2/3perforated	300	3	8 - 9	Put the baking tray on the first shelf position.
Broccoli, pre-heat the empty oven	1 x 2/3perforated	max.	3	10 - 11	Put the baking tray on the first shelf position.





Set the temperature to 100 °C.

	 <b>Container (Gastro- norm)</b>	 <b>(g)</b>		 <b>(min)</b>	
Peas, frozen	2 x 2/3 perforated	2 x 1500	2 and 4	Until the temperature in the coldest spot reaches 85 °C.	Put the baking tray on the first shelf position.

# 11. CARE AND CLEANING

## **WARNING!**

Refer to Safety chapters.

### 11.1 Notes on cleaning

 <b>Cleaning Agents</b>	Clean the front of the oven with a soft cloth with warm water and a mild cleaning agent.
	To clean metal surfaces, use a dedicated cleaning agent.
	Clean stubborn stains with a special oven cleaner.
	Use a few drops of vinegar to clean the bottom of the cavity from limescale.

 <b>Everyday Use</b>	Clean the oven cavity after each use. Fat accumulation or other food remains may cause fire. The risk is higher for the grill pan.
	Dry the cavity with a soft cloth after each use.

 <b>Accessories</b>	Clean all accessories after each use and let them dry. Use a soft cloth with warm water and a cleaning agent. Do not clean the accessories in a dishwasher.
	Do not clean the non-stick accessories using aggressive agents, sharp-edged objects or in a dishwasher

### 11.2 Recommended cleaning products

Do not use abrasive sponges or aggressive detergents. It can cause damage to the enamel and the stainless steel parts.

You can buy our products at [www.electrolux.com/shop](http://www.electrolux.com/shop) and at the best retailer shops.

### 11.3 How to remove: Shelf supports

Before maintenance, make sure that the oven is cold. There is a risk of burns.

To clean the oven, remove the shelf supports.

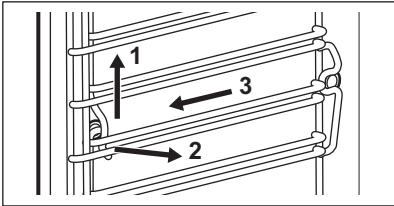
<b>Step 1</b>	 <p>Pull carefully the supports up and out of the front catch.</p>
<b>Step 2</b>	<p>Pull the front end of the shelf support away from the side wall.</p>
<b>Step 3</b>	<p>Pull the supports out of the rear catch.</p>

Install the shelf supports in the opposite sequence.

## 11.4 How to use: Steam Cleaning

When the oven is cold, remove the food remains.  
 Remove the accessories and the shelf support to clean the side walls.  
 The steam cleaning functions support the steam cleaning of the oven cavity.  
 When this function works, the light is off.

<b>Step 1</b>	<p>Make sure that the oven is cold.</p>	
<b>Step 2</b>	<p>Fill the water drawer to the maximum level.</p>	
<b>Step 3</b>	<p>Choose the steam cleaning function in the menu: Cleaning</p>	
	<p><b>Steam Cleaning</b>                  Duration: around 30 minutes</p>	<p><b>Steam Cleaning Plus</b>                  Duration: around 75 minutes                  Spray enamel and steel parts with a suitable detergent.</p>
<b>Step 4</b>	<p>Turn on preferred function.</p>	
<b>Step 5</b>	<p>After cleaning process, dry the cavity with a soft cloth.</p>	
<b>Step 6</b>	<p>Remove the remaining water from the water drawer.</p>	
<b>Step 7</b>	<p>Leave the oven door open for approximately 1 hour. Wait until the oven is dry.</p>	

## 11.5 How to use: Cleaning Reminder

When the reminder is displayed cleaning is necessary. Perform the function Steam Cleaning Plus.

## 11.6 How to use: Descaling

<b>First part duration:</b> around 1 hour 40 minutes	
<b>Step 1</b>	Make sure that the water drawer is empty.
<b>Step 2</b>	Remove the accessories. Leave only the grill- / roasting pan on the first shelf position.
<b>Step 3</b>	Pour 250 ml of the descaling agent in the water drawer.
<b>Step 4</b>	Fill the remaining part of the water drawer with water to the maximum level.
<b>Step 5</b>	Insert the water drawer.
<b>Step 6</b>	Select the function from the menu: Cleaning. Follow the instructions on the display.
After the first part is over, empty the grill- / roasting pan and put it back on the first shelf position.	
<b>Second part duration:</b> around 35 minutes	
<b>Step 7</b>	Fill the water drawer with fresh water. Make sure there is no remaining descaling agent inside the water drawer.
<b>Step 8</b>	Insert the water drawer.
<b>Step 9</b>	Remove the grill- / roasting pan after cleaning is over.
<b>Step 10</b>	Dry the oven with a soft cloth. Leave the oven door open for approximately 1 hour. Wait until the oven is dry.

When this function works, the light is off.

If this function is not performed in the correct way, the display will prompt to repeat it.

## 11.7 How to use: Descaling reminder

There are two descaling reminders which remind you to perform the function: Descaling.

The soft reminder reminds and recommends you to perform descaling.

The hard reminder obligates you to perform descaling.

If you do not descale the oven when the hard reminder is on, you cannot use the steam functions.

You cannot disable the descaling reminder.

## 11.8 How to use: Steam generation system - Rinsing

<b>Step 1</b>	Remove all accessories. Leave only the baking tray on the first shelf position.
---------------	---

<b>Step 2</b>	Fill the water drawer with fresh water.
<b>Step 3</b>	Select the function from the menu: Cleaning. The user interface will guide you through the procedure. The function duration: around 30 minutes. When this function works, the light is off.
<b>Step 4</b>	Remove the baking tray, when the function ends.

## 11.9 How to use: Drying reminder

After steam cooking the display shows a message prompting to dry the oven. Press YES to dry the oven.

## 11.10 How to use: Drying

After steam cooking or steam cleaning you can dry the cavity with this function.

<b>Step 1</b>	Make sure the oven is cold.
<b>Step 2</b>	Remove all accessories.
<b>Step 3</b>	Open the menu: Cleaning.
<b>Step 4</b>	Choose Drying.
<b>Step 5</b>	Follow the instructions on the screen.

## 11.11 How to remove and install: Door

You can remove the door and the internal glass panels to clean it. The number of glass panels depends on specific model.

The door is heavy.

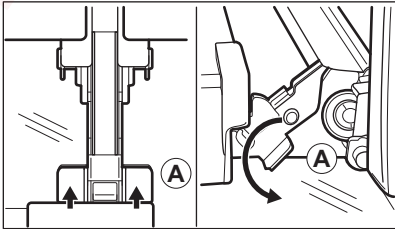
<b>Step 1</b>	Open the door fully.
<b>Step 2</b>	 <p>Fully press the clamping levers (A) on the two door hinges.</p>

# CARE AND CLEANING

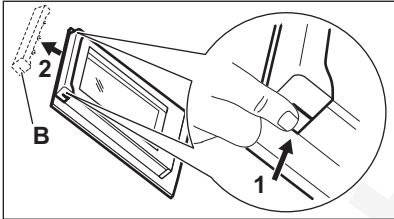
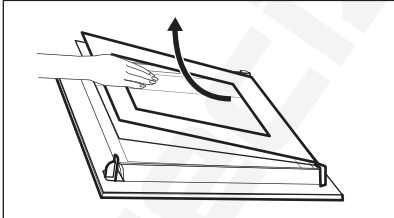
<b>Step 3</b>	Close the oven door to the first opening position (approximately 70° angle).
<b>Step 4</b>	 <p>Hold the door trim (B) on the top edge of the door at the two sides and push inwards to release the clip seal.</p>
<b>Step 5</b>	Pull the door trim to the front to remove it.
<b>Step 6</b>	 <p>Hold the door glass panels on their top edge one by one and pull them up out of the guide.</p>
<b>Step 7</b>	Clean the glass panel with water and soap. Dry the glass panel carefully.
<b>Step 8</b>	When the cleaning is completed, do the above steps in the opposite sequence.
<b>Step 9</b>	Install the smaller panel first, then the larger and the door.

## Step 10

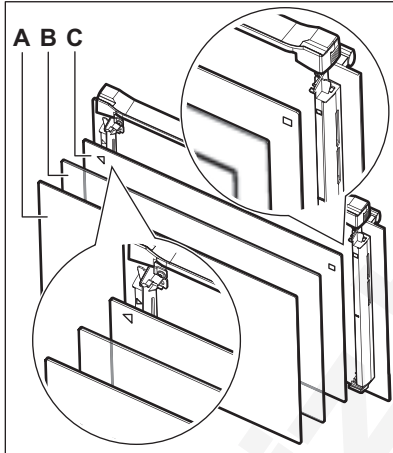

Make sure that you put the glass panels (C, B and A) back in the correct sequence. First, insert panel C, which has a square printed on the left side and a triangle on the right side. You will also find those symbols embossed on the door frame. The triangle symbol on the glass must match the triangle on the door frame, and the square symbol must match the square. After that insert the other two glass panels.

**⚠ WARNING!**

Make sure that the glasses are inserted in the correct position otherwise the surface of the door may overheat.

## 11.12 How to replace: Lamp

**⚠ WARNING!**

Risk of electric shock.  
The lamp can be hot.

1. Turn off the oven.

Wait until the oven is cooled down.

2. Disconnect the oven from the mains.
3. Put a cloth on the bottom of the cavity.

# CARE AND CLEANING

---

## The top lamp

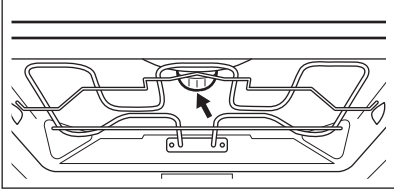
<b>Step 1</b>	 <p>Turn the lamp glass cover to remove it.</p>
<b>Step 2</b>	Clean the glass cover.
<b>Step 3</b>	Remove the metal ring and clean the glass cover.
<b>Step 4</b>	Replace the lamp with a suitable 300 °C heat-resistant lamp.
<b>Step 5</b>	Attach the metal ring to the glass cover.
<b>Step 6</b>	Install the glass cover.

## The side lamp

<b>Step 1</b>	Remove the left shelf support to get access to the lamp.
<b>Step 2</b>	Use a Torx 20 screwdriver to remove the cover.
<b>Step 3</b>	Remove and clean the metal frame and the seal.
<b>Step 4</b>	Replace the lamp with a suitable 300 °C heat-resistant lamp.
<b>Step 5</b>	Install the metal frame and the seal. Tighten the screws.
<b>Step 6</b>	Install the left shelf support.



## 12. TROUBLESHOOTING

### **WARNING!**

Refer to Safety chapters.

### 12.1 What to do if...



#### The oven does not turn on or does not heat up



#### Possible cause



#### Remedy

The oven is not connected to an electrical supply or it is connected incorrectly.

Check if the oven is correctly connected to the electrical supply.

The clock is not set.

Set the clock, for details refer to "Clock Functions" chapter, How to set: Clock functions.

The door is not closed correctly.

Fully close the door.

The fuse is blown.

Make sure the fuse is the cause of the problem. If the problem recurs, contact a qualified electrician.

The oven Child Lock is on.

Refer to "Menu" chapter, Submenu for: Options.



#### Components need to be replaced



#### Description











#### Remedy

The lamp is burnt out.



Replace the lamp, for details refer to "Care and Cleaning" chapter, How to replace: Lamp.

# TROUBLESHOOTING

 <b>Water drawer does not work properly</b>		
 <b>Description</b>	 <b>Possible cause</b>	 <b>Remedy</b>
The oven does not retain the water drawer after you insert it.	You did not fully press the water drawer body.	Fully insert the water drawer into the oven.
Water comes out of the water drawer.	You did not assemble the lid of the water drawer or wave breaker correctly.	Reassemble the lid of the water drawer and wave breaker.

 <b>Problems with cleaning procedure</b>		
 <b>Description</b>	 <b>Possible cause</b>	 <b>Remedy</b>
The water drawer is difficult to clean.	The lid and the wave-breaker were not removed.	Remove the lid and the wave breaker.
There is no water inside the grill-/roasting pan after descaling.	The water drawer was not filled in to the maximum level.	Check if a descaling agent/ water is present in the water drawer body.
There is a dirty water on the bottom of the cavity after descaling.	The grill- / roasting pan is on a wrong shelf position.	Remove the remaining water and the descaling agent from the bottom of the oven. Next time put the grill-/roasting pan on the first shelf position.
There is too much water on the bottom of the cavity after cleaning.	You put too much detergent in the oven before you started cleaning.	Next time evenly spread the thin layer of a detergent on the cavity walls.
Cleaning performance is not satisfactory.	You started cleaning when the oven was too hot.	Wait until the oven is cold. Repeat cleaning.
	You did not remove all the accessories from the oven before cleaning.	Remove all the accessories from the oven. Repeat cleaning.



Power cut always stops cleaning. Repeat cleaning if it's interrupted by power failure.

 <b>Problems with Wi-Fi signal</b>	
 <b>Possible cause</b>	 <b>Remedy</b>
Trouble with wireless network signal.	Check your wireless network and router. Restart the router.
New router installed or router configuration changed.	To configure oven and mobile device again, refer to "Before first use" chapter, Wireless connection.
The wireless network signal is weak.	Move router as close to the oven as possible.
The wireless signal is disrupted by a microwave appliance placed near the oven.	Turn off the microwave appliance.

## 12.2 How to manage: Error codes



When the software error occurs, the display shows error message.

In this section, you will find the list of the problems that you can handle on your own.

 <b>Code and description</b>	 <b>Action</b>
F111 - Food Sensor is not correctly inserted into the socket.	Fully plug Food Sensor into the socket.
F240, F439 - the touch fields on the display do not work properly.	Clean the surface of the display. Make sure there is no dirt on the touch fields.
F601 - there is a problem with Wi-Fi signal.	Check your network connection. Refer to "Before first use" chapter, Wireless connection.
F604 - the first connection to Wi-Fi failed.	Turn the oven off and on and try again. Refer to "Before first use" chapter, Wireless connection.
F908 - the oven system cannot connect with the control panel.	Turn the oven off and on.

In this section, you will find the list of the problems that have to be handled by a qualified technician.

# TROUBLESHOOTING

 <b>Code and description</b>	 <b>Action</b>
F131 - the temperature of the steamer sensor is too high.	Turn the oven off and wait until it cools down. Turn the oven on again.
F144 - the sensor in the Water Drawer cannot measure the water level.	Empty the Water Drawer and refill it.
F508 - the Water Drawer does not work properly.	Turn the oven off and on.
F602, F603 - Wi-Fi is not available.	Turn the oven off and on.

When one of these error messages continues to appear on the display, it means a faulty subsystem may have been disabled. In such a case contact your dealer or an Authorized Service Centre. If one of these errors occurs, the rest of the oven functions will continue to work as usually.

## 12.3 Service data

If you cannot find a solution to the problem yourself, contact your dealer or an Authorised Service Centre.

The necessary data for the service centre is on the rating plate. The rating plate is on the front frame of the oven cavity. Do not remove the rating plate from the oven cavity.

<b>We recommend that you write the data here:</b>	
Model (MOD.)	.....
Product number (PNC)	.....
Serial number (S.N.)	.....

# 13. ENERGY EFFICIENCY

## 13.1 Product Information Sheet

### Product information according to EU 65-66/2014

Supplier's name	Electrolux
Model identification	KOAS31WX 944184821
Energy Efficiency Index	61.9
Energy efficiency class	A++
Energy consumption with a standard load, conventional mode	0.99 kWh/cycle
Energy consumption with a standard load, fan-forced mode	0.52 kWh/cycle
Number of cavities	1
Heat source	Electricity
Volume	70 l
Type of oven	Built-In Oven
Mass	40.5 kg

EN 60350-1 - Household electric cooking appliances - Part 1: Ranges, ovens, steam ovens and grills - Methods for measuring performance.

## 13.2 Energy saving



The oven contains features which help you save energy during everyday cooking.

Make sure that the oven door is closed properly when the oven operates. Do not open the door too often during cooking. Keep the door gasket clean and make sure it is well fixed in its position.

Use metal cookware to improve energy saving.

When possible, do not preheat the oven before cooking.

Keep breaks between baking as short as possible when you prepare a few dishes at one time.

### **Cooking with fan**

When possible, use the cooking functions with fan to save energy.

### **Residual heat**

If a programme with the Duration or End Time selection is activated and the cooking time is longer than 30 minutes, the heating elements automatically turn off earlier in some oven functions.

The fan and lamp continue to operate. When you turn off the oven, the display shows the residual heat. You can use that heat to keep the food warm.

# ENERGY EFFICIENCY

---

When the cooking duration is longer than 30 minutes, reduce the oven temperature to minimum 3 - 10 minutes before the end of cooking. The residual heat inside the oven will continue to cook.

Use the residual heat to warm up other dishes.

## **Keep food warm**

Choose the lowest possible temperature setting to use residual heat and keep a meal warm. The residual heat indicator or temperature appears on the display.

## **Cooking with the lamp off**

Turn off the lamp during cooking. Turn it on only when you need it.

## **Moist Fan Baking**

Function designed to save energy during cooking.

When you use this function the lamp automatically turns off after 30 seconds. You may turn on the lamp again but this action will reduce the expected energy savings.

## **Standby mode**

After 2 minutes the display goes to standby mode.

# 14. MENU STRUCTURE

## 14.1 Menu

Press  on the display to open Menu.

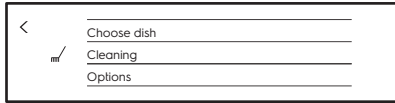

Menu

Menu item		Application
Assisted Cooking		Contains a list of automatic programmes.
Cleaning		Contains a list of cleaning programmes.
Options		To set the oven configuration.
Settings	Connections	To set the network configuration.
	Setup	To set the oven configuration.
	Service	Shows the software version and configuration.

## 14.2 Submenu for: Cleaning

Submenu	Application
Steam Cleaning	Light cleaning.
Steam Cleaning Plus	Thorough cleaning.
Descaling	Cleaning of the steam generation circuit from residual limestone.
Rinsing	Cleaning of the steam generation circuit. Use rinsing after frequent steam cooking.
Drying	Procedure for drying the cavity from the condensation remaining after a use of the steam functions.
Cleaning Reminder	Reminds you when to clean the oven.

# MENU STRUCTURE

---

## 14.3 Submenu for: Options

Submenu	Application
Light	To turn the lamp on and off.
Lamp Icon Visible	Lamp icon appears on the screen.
Fast Heat Up	Shortens heat up time. Note that it is available only for some of the oven functions.
Child Lock	Prevents accidental activation of the oven. When the option is on, the text "Child Lock" appears on the display when you turn on the oven. To enable the oven use, choose the code letters in the alphabetical order.
ECO Mode	Switches off Wi-Fi and the display to save as much power as possible.

## 14.4 Submenu for: Connections

Submenu	Description
Wi-Fi	To enable and disable Wi-Fi.
Network	To check network status and Wi-Fi signal power.
Forget Network	To disable current network from auto connection with the oven.

## 14.5 Submenu for: Setup

Submenu	Description
Language	Sets the oven language.
Time of Day	Sets the current time and date.
Time Indication	Turns the clock on and off.
Digital Clock Style	Changes the format of the displayed time indication.
Cleaning Reminder	Turns the reminder on and off.



Submenu	Description
Key Tones	Turns the tone of the touch fields on and off. It is not possible to switch off the tone of the ON / OFF and STOP.
Alarm / Error Tones	Turns the alarm tones on and off .
Buzzer Volume	Regulates the volume of key tones and signals.
Display Brightness	Regulates the display brightness.
Water hardness	Sets the water hardness.

## 14.6 Submenu for: Service







Submenu	Description
Demo mode	Activation / deactivation code: 2468
Licence	Information about licenses.
Software Version	Information about software version.
Reset All Settings	Restores factory settings.
Reset all popups	Restores all pop-ups to the original settings.

# 15. IT'S EASY!



## Before first use you have to set:

Language	Display Brightness	Buzzer Volume	Water hardness	Clock	Wireless connection
----------	--------------------	---------------	----------------	-------	---------------------





## Familiarize yourself with the basic icons on the control panel and the display:

 On / Off	 Menu / Back	 Wi-Fi	 Information	 START Timer	START / STOP	 More
---	--	--	--	---	-----------------	--

## Start using the oven

<b>Quick start</b>	Turn on the oven and start cooking with the default temperature and time of the function.	<b>Step 1</b>	<b>Step 2</b>	<b>Step 3</b>
		Press and hold  .	Press preferred function  ...	Press START .
<b>Quick Off</b>	Turn off the oven at any time, any screen or message.	Press and hold  until the oven turns off.		

## Start cooking

<b>Step 1</b>	<b>Step 2</b>	<b>Step 3</b>	<b>Step 4</b>	<b>Step 5</b>	<b>Step 6</b>
 Press to turn on the oven.	 ... Press chosen function.	 Press to go in the temperature settings.	 Move the finger on the slider to set the temperature.	OK Press to confirm.	START Press to start cooking.

## Use Steamify - Steam cooking



Move the finger on the slider to set the temperature. Type of the steam heating function depends on the set temperature.

Steam for Steaming	Steam for Stewing	Steam for Gentle Crisping	Steam for Baking and Roasting
--------------------	-------------------	---------------------------	-------------------------------





Use Steamify - Steam cooking			
50 - 100 °C	105 - 130 °C	135 - 150 °C	155 - 230 °C

## Get to know how to cook quickly



### Use Automatic Programmes to prepare a dish quickly with default settings:

Assisted Cooking	Step 1	Step 2	Step 3
	Press  .	Press  Assisted Cooking.	Choose the dish.

## Use quick functions to set the cooking time or change the cooking function

Quick timer settings	Step 1	Step 2
Use the most used timer settings by choosing from the shortcuts.	Press  .	Press preferred timer value.
<b>10% Finish assist</b> Use 10% Finish assist to add extra time or change cooking function when 10% of the cooking time is left.	Extra time: Press preferred extra time +1 min   +5 min   +10 min .	
	Change function: Press preferred function    ... .	

## Clean the oven with Steam cleaning

Step 1	Step 2	Step 3
Press  .	Press  .	Choose mode:
<b>Steam Cleaning</b>	For light cleaning.	
<b>Steam Cleaning Plus</b>	For thorough cleaning.	
<b>Descaling</b>	For cleaning the steam generation circuit from residual limestone.	
<b>Rinsing</b>	For rinsing and cleaning the steam generation circuit after frequent use of the steam functions.	

## 16. TAKE A SHORTCUT!

---

Here you can see all the useful shortcuts. You can also find them in the dedicated chapters in the user manual.

### Wireless connection



### How to set: Oven Functions



### How to set: Steamify - Steam Cooking



### How to set: Steamify - SousVide Cooking



### How to set: Assisted Cooking



### How to set cooking time



### How to delay start and end of cooking



### How to cancel set timer





How to use: Food Sensor



## 17. ENVIRONMENTAL CONCERNS

---

Recycle materials with the symbol . Put the packaging in relevant containers to recycle it. Help protect the environment and human health by recycling waste of electrical and electronic appliances. Do not dispose of appliances marked with the symbol  with the household waste. Return the product to your local recycling facility or contact your municipal office.





[www.electrolux.com/shop](http://www.electrolux.com/shop)



867352989-A-052019

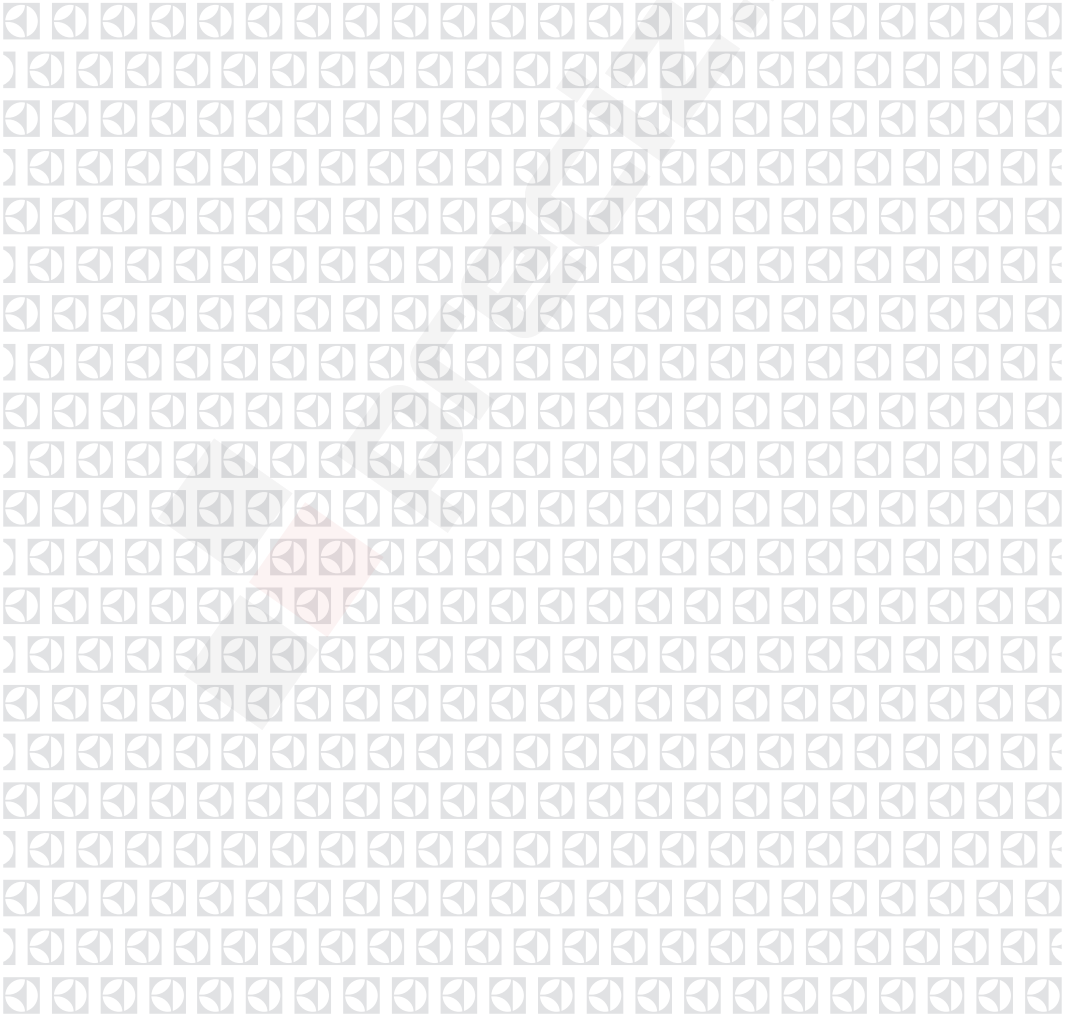



## Free Manuals Download Website

<http://myh66.com>

<http://usermanuals.us>

<http://www.somanuals.com>

<http://www.4manuals.cc>

<http://www.manual-lib.com>

<http://www.404manual.com>

<http://www.luxmanual.com>

<http://aubethermostatmanual.com>

Golf course search by state

<http://golfingnear.com>

Email search by domain

<http://emailbydomain.com>

Auto manuals search

<http://auto.somanuals.com>

TV manuals search

<http://tv.somanuals.com>