

Dell PowerEdge R930 System Owner's Manual

Regulatory Model: E37S Series
Regulatory Type: E37S001



Notes, cautions, and warnings

 **NOTE:** A NOTE indicates important information that helps you make better use of your computer.

 **CAUTION:** A CAUTION indicates either potential damage to hardware or loss of data and tells you how to avoid the problem.

 **WARNING:** A WARNING indicates a potential for property damage, personal injury, or death.

Copyright © 2015 Dell Inc. All rights reserved. This product is protected by U.S. and international copyright and intellectual property laws. Dell™ and the Dell logo are trademarks of Dell Inc. in the United States and/or other jurisdictions. All other marks and names mentioned herein may be trademarks of their respective companies.

2015 – 06

Rev. A00

Contents

1 About the PowerEdge R930.....	9
Front panel features and indicators.....	9
LCD panel features.....	11
Home screen.....	12
Setup menu.....	12
View menu.....	13
Diagnostic indicators.....	13
Hard drive indicator codes.....	15
SSD LED indicator pattern.....	16
Back panel features and indicators.....	17
NIC indicator codes.....	19
Power supply unit indicator codes.....	19
Documentation matrix.....	21
Quick Resource Locator (QRL).....	22
2 Performing initial system configuration	23
Setting up your system.....	23
Setting up and configuring the iDRAC IP address	23
Logging in to iDRAC.....	24
Methods of installing the operating system.....	24
Managing your system remotely.....	24
Downloading drivers and firmware.....	25
3 Pre-operating system management applications.....	26
Navigation keys.....	26
About System Setup.....	27
Entering system setup.....	27
System Setup Main Menu.....	27
System BIOS screen.....	27
System Information screen.....	28
Memory Settings screen.....	29
Processor Settings screen.....	30
SATA Settings screen.....	31
Boot Settings screen.....	32
Network Settings screen.....	33
Integrated Devices screen.....	33
Serial Communication screen.....	34
System Profile Settings screen.....	35

System Security Settings screen.....	37
Miscellaneous Settings screen.....	38
About Boot Manager.....	39
Entering Boot Manager	39
Boot Manager main menu.....	39
About Dell Lifecycle Controller.....	40
Changing the boot order.....	40
Choosing the system boot mode.....	40
Assigning a system or setup password.....	41
Using your system password to secure your system.....	41
Deleting or changing an existing system password or setup password.....	42
Operating with a setup password enabled.....	42
Embedded system management.....	43
iDRAC Settings utility.....	43
Entering the iDRAC Settings utility.....	43
Changing the Thermal Settings.....	43

4 Installing and removing system components.....45

Customer and field replaceable units.....	45
Safety instructions.....	46
Before working inside your system.....	46
After working inside your system.....	46
Recommended tools.....	47
Front bezel (optional).....	47
Installing the optional front bezel.....	47
Removing the optional front bezel.....	47
System cover.....	48
Removing the system cover.....	48
Installing the system cover.....	49
Inside the system.....	50
Chassis intrusion switch.....	51
Removing the chassis intrusion switch.....	51
Installing the chassis intrusion switch.....	52
Cable management tray.....	53
Removing the cable management tray	53
Installing the cable management tray.....	55
System memory.....	56
General memory module installation guidelines.....	59
Mode-specific guidelines.....	59
Advanced ECC (Lockstep).....	60
Memory optimized (independent channel) mode.....	60
Memory sparing.....	60

Memory mirroring.....	60
Fault Resilient Memory.....	61
Sample memory configurations.....	61
Memory riser.....	62
Removing a memory riser blank.....	62
Installing a memory riser blank.....	63
Removing a memory riser.....	64
Installing a memory riser.....	65
Removing memory modules from the memory riser.....	66
Installing memory modules into the memory riser.....	68
Memory riser and fan cage.....	70
Removing the memory riser and fan cage.....	70
Installing the memory riser and fan cage.....	71
Hard drives.....	72
Removing a 2.5 inch hard drive blank.....	73
Installing a 2.5 inch hard drive blank.....	74
Removing a hot-swappable hard drive carrier.....	75
Installing a hot-swappable hard drive carrier.....	76
Removing a hard drive from a hard drive carrier.....	77
Installing a hard drive into a hard drive carrier.....	77
Optical drive (optional).....	78
Removing the optical drive.....	78
Installing the optical drive.....	79
Cooling fans.....	80
Removing a cooling fan.....	80
Installing a cooling fan.....	81
Removing the fan tray.....	82
Installing the fan tray.....	83
Internal USB memory key (optional).....	84
Replacing the internal USB key.....	84
Expansion cards and expansion card risers.....	85
Expansion card installation guidelines.....	85
Removing the left expansion card riser blank.....	88
Installing the left expansion card riser blank.....	89
Removing the right expansion card riser blank.....	90
Installing the right expansion card riser blank.....	90
Removing the left expansion card riser.....	90
Installing the left expansion card riser.....	92
Removing the right expansion card riser.....	92
Installing the right expansion card riser.....	93
Removing an expansion card from expansion card risers.....	93
Installing an expansion card into the expansion card risers.....	97

NDC riser.....	97
Removing the NDC riser.....	98
Installing the NDC riser.....	99
Network daughter card.....	99
Removing the network daughter card.....	100
Installing the network daughter card.....	101
SD vFlash media card.....	101
Replacing an SD vFlash media card.....	102
Internal dual SD module.....	102
Removing an internal SD card.....	103
Installing an internal SD card.....	103
Removing the internal dual SD module.....	104
Installing the internal dual SD module.....	106
Integrated storage controller card.....	106
Removing the integrated storage controller card.....	107
Installing the integrated storage controller card.....	108
Processors and heat sinks.....	109
Removing a heat sink.....	109
Removing a processor.....	110
Installing a processor.....	113
Installing a heat sink.....	115
Removing a processor blank and heat sink blank	117
Installing a processor blank and heat sink blank.....	118
Power supply units.....	119
Hot spare feature.....	120
Removing an AC power supply unit.....	120
Installing an AC power supply unit.....	121
Removing the power supply unit blank.....	122
Installing the power supply unit blank.....	123
Power distribution board.....	124
Removing the power supply unit bay.....	124
Installing the power supply unit bay.....	125
Removing the power distribution board.....	126
Installing the power distribution board.....	127
System battery.....	128
Replacing the system battery.....	128
Hard drive backplane.....	129
Removing the hard drive backplane.....	130
Installing the hard drive backplane.....	138
SAS expander daughter card.....	139
Removing the SAS expander daughter card.....	139
Installing the SAS expander daughter card.....	140

Control panel assembly.....	141
Removing the control panel board.....	141
Installing the control panel board.....	142
System board.....	143
Removing the system board.....	143
Installing the system board.....	145
Trusted Platform Module.....	148
Re-enabling the TPM for BitLocker users.....	148
Re-enabling the TPM for TXT users.....	148
5 Troubleshooting your system.....	149
Safety first—for you and your system.....	149
Troubleshooting system startup failure.....	149
Troubleshooting external connections.....	149
Troubleshooting the video subsystem.....	149
Troubleshooting a USB device.....	150
Troubleshooting a serial I/O device.....	150
Troubleshooting a NIC.....	151
Troubleshooting a wet system.....	151
Troubleshooting a damaged system.....	152
Troubleshooting the system battery.....	153
Troubleshooting power supply units.....	153
Troubleshooting cooling problems.....	154
Troubleshooting cooling fans.....	155
Troubleshooting system memory.....	155
Troubleshooting an internal USB key.....	156
Troubleshooting an SD card.....	157
Troubleshooting an optical drive.....	158
Troubleshooting a hard drive.....	158
Troubleshooting a storage controller.....	159
Troubleshooting expansion cards.....	160
Troubleshooting processors.....	160
6 Using system diagnostics.....	162
Dell embedded system diagnostics.....	162
When to use the embedded system diagnostics.....	162
Running the Embedded System Diagnostics from Boot Manager.....	162
Running the Embedded System Diagnostics from the Dell Lifecycle Controller.....	163
System diagnostic controls.....	163
7 Jumpers and connectors.....	164
System board jumper settings.....	164

System board connectors.....	165
Disabling a forgotten password.....	168
8 Technical specifications.....	169
9 Getting help.....	176
Contacting Dell.....	176
Locating your system Service Tag.....	176
Quick Resource Locator (QRL).....	176

About the PowerEdge R930

The Dell PowerEdge R930 is a rack server that supports up to four processors based on the Intel E7-8800/4800 v3 product family, eight memory risers with a capacity of 12 DIMMs per riser, and up to 24 hard drives/SSDs.

The R930 systems are available in the following configurations:

System	Configuration
Four hard drive systems	Up to four 2.5 inch, hot-swappable hard drives/SSDs with redundant PSU
Twenty four hard drive systems	Up to twenty four 2.5 inch, hot-swappable hard drives/SSDs with redundant PSU
Sixteen hard drive/SSD plus eight PCIe SSD systems	Up to sixteen 2.5 inch, hot-swappable hard drives/SSDs plus eight PCIe SSDs with redundant PSU

Front panel features and indicators

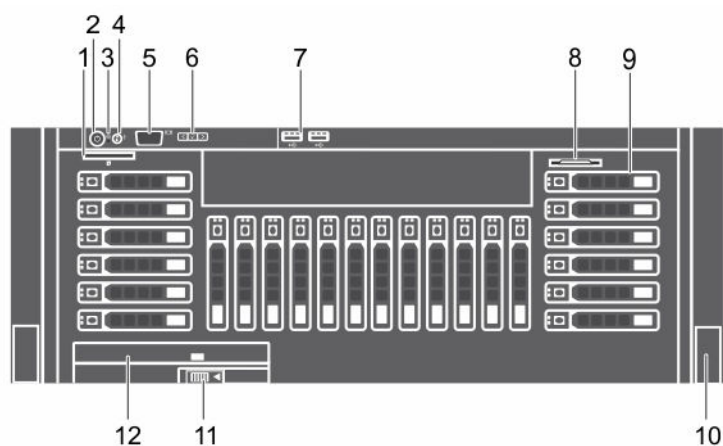









Figure 1. Front panel features and indicators

Item	Indicator, Button, or Connector	Icon	Description
1	vFlash media card slot		Enables you to insert a vFlash media card.
2	Power-on indicator, power button		<p>The power-on indicator lights when the system power is on. The power button controls the power supply output to the system.</p> <p> NOTE: On ACPI-compliant operating systems, turning off the system using the power button causes the system to perform a graceful shutdown before power to the system is turned off.</p>
3	NMI button		<p>Used to troubleshoot software and device driver errors when running certain operating systems. This button can be pressed using the end of a paper clip.</p> <p>Use this button only if directed to do so by qualified support personnel or by the operating system documentation.</p>
4	System identification button		<p>The identification buttons on the front and back panels can be used to locate a particular system within a rack. When one of these buttons is pressed, the LCD panel on the front and the system status indicator on the back flashes until one of the buttons is pressed again.</p> <p>Press the system identification button to turn the system ID on or off.</p> <p>If the system stops responding during POST, press and hold the system ID button for more than five seconds to enter BIOS progress mode.</p> <p>To reset iDRAC (if not disabled in F2 iDRAC setup), press and hold the button for more than 15 seconds.</p>
5	Video connector		Enables you to connect a VGA display to the system.
6	LCD menu buttons		Enables you to navigate the control panel LCD menu.
7	USB connectors (2)		Enables you to connect USB devices to the system. The ports are USB 2.0-compliant.
8	Enterprise Service Tag		A slide-out label panel, which allows you to record system information such as Service Tag, NIC, MAC address, and so on, as per your need.
9	Hard drives (number of drives will be either 4 or		2.5 inch hard drives

Item	Indicator, Button, or Connector	Icon	Description
	24 depending on the backplane configurations)		 NOTE: On the backplane supported Flash devices, there are 3 bays in total. The first two bays are for PCIe Flash devices with two sets of drives labelled 0 through 3. The bay 3 is for SAS drives labelled 0 through 15.
10	Rack ears		Enables you to pull the system out of the rack.
11	Slide lock		A lock that pops out the ejector handle for the optical drive.
12	Optical drive (optional)		One optional SATA DVD-ROM drive or DVD+/- RW drive.

LCD panel features

The system's LCD panel provides system information and status and error messages to indicate when the system is operating correctly or when the system needs attention.

- The LCD backlight lights blue during normal operating conditions and lights amber to indicate an error condition.
- The LCD backlight is turned off when the system is in standby mode and can be turned on by pressing either the Select, Left, or Right button on the LCD panel.
- The LCD backlight remains OFF if LCD messaging is turned off through the iDRAC utility, the LCD panel, or other tools.

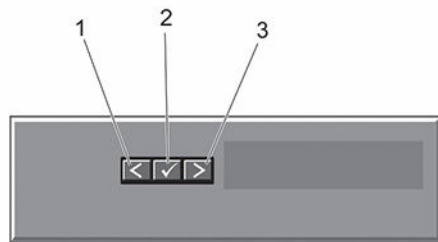

Figure 2. LCD panel Features



Item	Button	Description
1	Left	Moves the cursor back in one-step increments.
2	Select	Selects the menu item highlighted by the cursor.
3	Right	Moves the cursor forward in one-step increments. During message scrolling:

Item	Button	Description
		<ul style="list-style-type: none"> • Press once to increase scrolling speed • Press again to stop • Press again to return to the default scrolling speed • Press again to repeat the cycle

Home screen

The Home screen displays user-configurable information about the system. This screen is displayed during normal system operation when there are no status messages or errors. When the system is in standby mode, the LCD backlight turns off after five minutes of inactivity if there are no error messages. Press one of the three navigation buttons (Select, Left, or Right) to view the Home screen.

To navigate to the Home screen from another menu, follow the steps below.

1. Press and hold the up arrow  until the **Home** icon  is displayed.
2. Select the **Home** icon.
3. From the Home screen, press the **Select** button to enter the main menu.

Setup menu

 **NOTE:** When you select an option in the Setup menu, you must confirm the option before proceeding to the next action.

Option	Description
iDRAC	Select DHCP or Static IP to configure the network mode. If Static IP is selected, the available fields are IP , Subnet (Sub) , and Gateway (Gtw) . Select Setup DNS to enable DNS and to view domain addresses. Two separate DNS entries are available.
Set error	Select SEL to display LCD error messages in a format that matches the IPMI description in the SEL. This is useful when trying to match an LCD message with an SEL entry. Select Simple to display LCD error messages in a simplified user-friendly description. For more information on error messages, see the Dell Event and Error Messages Reference Guide at dell.com/esmmanuals .
Set home	Select the default information to be displayed on the LCD Home screen. See View menu to see the options and option items that can be set as the default on the Home screen.

View menu



 **NOTE:** When you select an option in the View menu, you must confirm the option before proceeding to the next action.





Option	Description
iDRAC IP	Displays the IPv4 or IPv6 addresses for iDRAC8. Addresses include DNS (Primary and Secondary) , Gateway, IP , and Subnet (IPv6 does not have Subnet).
MAC	Displays the MAC addresses for iDRAC , iSCSI , or Network devices.
Name	Displays the name of the Host , Model , or User String for the system.
Number	Displays the Asset tag or the Service tag for the system.
Power	Displays the power output of the system in BTU/hr or Watts. The display format can be configured in the Set home submenu of the Setup menu.
Temperature	Displays the temperature of the system in Celsius or Fahrenheit. The display format can be configured in the Set home submenu of the Setup menu.

Diagnostic indicators

The diagnostic indicators on the system front panel display error status during system startup.

 **NOTE:** No diagnostic indicators are lit when the system is switched off. To start the system, plug it into a working power source and press the power button.

Icon	Description	Condition	Corrective action
	Health indicator	If the system is on, and in good health, the indicator lights solid blue. The indicator blinks amber if the system is on or in standby, and if any error exists (for example, a failed fan or hard drive).	None required. See the System Event Log or system messages for the specific issue. For more information on error messages, see the Dell Event and Error Messages Reference Guide at Dell.com/esmanuals . Invalid memory configurations can cause the system to halt at startup without any video output. See Getting help .
	Hard drive indicator	The indicator blinks amber if a hard drive experiences an error.	See the System Event Log to determine the hard drive that has an error. Run the appropriate Online Diagnostics test. Restart system and run embedded diagnostics (ePSA). If the hard drives are configured in a RAID array, restart the system and enter the host adapter configuration utility program.

Icon	Description	Condition	Corrective action
	Electrical indicator	The indicator blinks amber if the system experiences an electrical error (for example, voltage out of range, or a failed power supply unit or voltage regulator).	See the System Event Log or system messages for the specific issue. If it is due to a problem with the power supply, check the LED on the power supply. Re-seat the power supply by removing and reinstalling it. If the problem persists, see Getting help .
	Temperature indicator	The indicator blinks amber if the system experiences a thermal error (for example, a temperature out of range or fan failure).	Ensure that none of the following conditions exist: <ul style="list-style-type: none"> • A cooling fan is removed or has failed. • System cover, cooling shroud, EMI filler panel, memory module blank, or back filler bracket is removed. • Ambient temperature is too high. • External airflow is obstructed. See Getting help .
	Memory indicator	The indicator blinks amber if a memory error occurs.	See System Event Log or system messages for the location of the failed memory. Reinstall the memory device. If the problem persists, see Getting help .
	PCIe indicator	The indicator blinks amber if a PCIe card experiences an error.	Restart the system. Update any required drivers for the PCIe card. Re-install the card. If the problem persists, see Getting help .

Hard drive indicator codes

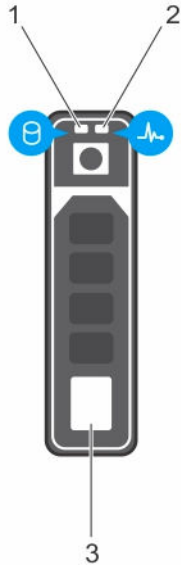

Figure 3. Hard drive indicators

1. hard drive activity indicator
2. hard drive status indicator
3. hard drive

NOTE: If the hard drive is in Advanced Host Controller Interface (AHCI) mode, the status indicator (on the right side) does not function and remains off.

Drive-status indicator pattern (RAID only)	Condition
Blinks green two times per second	Identifying drive or preparing for removal.
Off	Drive ready for insertion or removal.
	NOTE: The drive status indicator remains off until all hard drives are initialized after the system is turned on. Drives are not ready for insertion or removal during this time.
Blinks green, amber, and turns off	Predicted drive failure
Blinks amber four times per second	Drive failed
Blinks green slowly	Drive rebuilding
Steady green	Drive online
Blinks green three seconds, amber three seconds, and turns off six seconds	Rebuild aborted

SSD LED indicator pattern

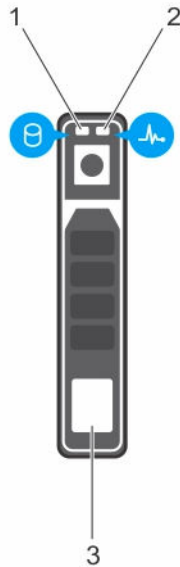

Figure 4. SSD LED indicator pattern

1. SSD activity indicator
2. SSD status indicator
3. SSD

While the operating system is running, the status indicator provides the current status of the device. The following table lists the device states along with the associated LED indicator codes.

Table 1. SSD LED indicator pattern

State Name	Slot/Device State	Status LED (Green)	Status LED (Amber)
Device status off	The server or device is not powered up.	Off	Off
Device online	The device is powered up.	On	Off
Device identify (blink)	The device is identifying the slot location or is indicating that the device has received a Prepare for Removal command from the host operating system.	On for 250 msec Off for 250 msec	Off
Device failed	The host operating system no longer has access to the device because the device is not responding or has	Off	On for 250 msec Off for 250 msec

State Name	Slot/Device State	Status LED (Green)	Status LED (Amber)
	encountered a critical error condition.		

Back panel features and indicators

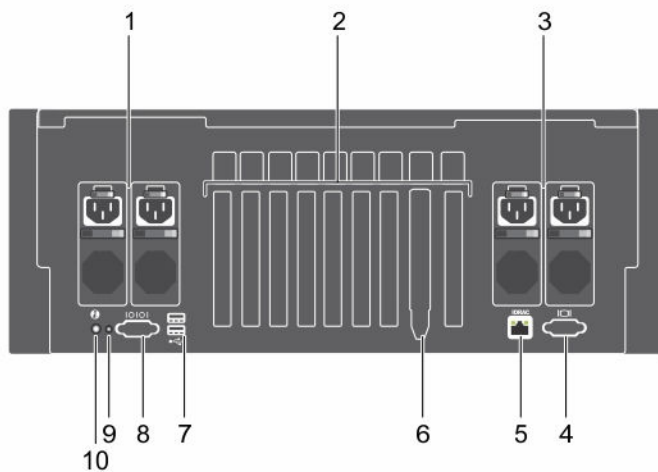





Figure 5. Back panel features and indicators

Item	Indicator, Button, or Connector	Icon	Description
1	Power supply unit (PSU 3 and 4)		AC 750 W or 1100 W
2	PCIe expansion card slots (8 or 10 depending on the I/O risers installed)		Enables you to connect PCI Express expansion cards.
3	Power supply unit (PSU 1 and 2)		AC 750 W or 1100 W
4	Video connector		Enables you to connect a VGA display to the system.
5	iDRAC Enterprise port		Dedicated management port.  NOTE: The port is available for use only if the iDRAC8 Enterprise license is installed on your system.
6	Ethernet connectors (4)		Four integrated 10/100/1000 Mbps NIC connectors







Item	Indicator, Button, or Connector	Icon	Description
			<p>or</p> <p>Four integrated connectors that include:</p> <ul style="list-style-type: none"> • Two 10/100/1000 Mbps NIC connectors • Two 100 Mbps/1 Gbps/10 Gbps SFP+/10 GbE T connectors
7	USB connectors (2)		Enables you to connect USB devices to the system. The ports are USB 2.0-compliant.
8	Serial connector		Enables you to connect a serial device to the system.
9	System identification connector		Connects the optional system status indicator assembly through the optional cable management arm.
10	System identification button		<p>The identification buttons on the front and back panels can be used to locate a particular system within a rack.</p> <p>Press the system identification button to turn the system ID on or off.</p> <p>If the system stops responding during POST, press and hold the system ID button for more than five seconds to enter BIOS progress mode.</p> <p>To reset iDRAC (if not disabled in F2 iDRAC setup) press and hold the button for more than 15 seconds.</p>



Figure 7. AC PSU status indicator

1. AC PSU status indicator/handle

Convention	Power indicator pattern	Condition
A	Green	A valid power source is connected to the PSU and the PSU is operational.
B	Flashing green	When the firmware of the PSU is being updated, the PSU handle flashes green. ⚠ CAUTION: Do not disconnect the power cord or unplug the PSU when updating firmware. If firmware update is interrupted, the PSUs will not function. You must roll back the PSU firmware by using Life cycle controller. See <i>Dell Lifecycle Controller User's Guide</i> at Dell.com/esmmanuals.
C	Flashing green and turns off	When hot-adding a PSU, the PSU handle flashes green five times at 4 Hz rate and turns off. This indicates that there is a PSU mismatch with respect to efficiency, feature set, health status, and supported voltage. Replace the PSU with a PSU that matches the capacity of the other PSU. ⚠ CAUTION: For AC PSUs, use only PSUs with the Extended Power Performance (EPP) label on the back. Mixing PSUs from previous generations of Dell PowerEdge servers can result in a PSU mismatch condition or failure to power on.
D	Flashing amber	Indicates a problem with the PSU.

Convention	Power indicator pattern	Condition
		<p> CAUTION: When correcting a PSU mismatch, replace only the PSU with the flashing indicator. Swapping the PSU to make a matched pair can result in an error condition and unexpected system shutdown. To change from a High Output configuration to a Low Output configuration or vice versa, you must power down the system.</p> <p> CAUTION: AC PSUs support both 220 V and 110 V input voltages with the exception of Titanium PSUs, which support only 220 V. When two identical PSUs receive different input voltages, they can output different wattages, and trigger a mismatch.</p> <p> CAUTION: If two PSUs are used, they must be of the same type and have the same maximum output power.</p>
E	Not lit	Power is not connected.

Documentation matrix

The documentation matrix provides information on documents that you can refer to for setting up and managing your system.

To...	Refer to...
Install your system into a rack	Rack documentation included with your rack solution
Set up your system and know the system technical specifications	<i>Getting Started With Your System</i> that shipped with your system or see Dell.com/poweredge manuals
Install the operating system	Operating system documentation at Dell.com/operatingsystem manuals
Get an overview of the Dell Systems Management offerings	Dell OpenManage Systems Management Overview Guide at Dell.com/openmanage manuals
Configure and log in to iDRAC, set up managed and management system, know the iDRAC features and troubleshoot using iDRAC	Integrated Dell Remote Access Controller User's Guide at Dell.com/esm manuals
Know about the RACADM subcommands and supported RACADM interfaces	RACADM Command Line Reference Guide for iDRAC and CMC at Dell.com/esm manuals
Launch, enable and disable Lifecycle Controller, know the features, use and troubleshoot Lifecycle Controller	Dell Lifecycle Controller User's Guide at Dell.com/esm manuals
Use Lifecycle Controller Remote Services	Dell Lifecycle Controller Remote Services Quick Start Guide at Dell.com/esm manuals

To...	Refer to...
Set up, use, and troubleshoot OpenManage Server Administrator	Dell OpenManage Server Administrator User's Guide at Dell.com/openmanagemanuals
Install, use, and troubleshoot OpenManage Essentials	Dell OpenManage Essentials User's Guide at Dell.com/openmanagemanuals
Know the features of the storage controller cards, deploy the cards, and manage the storage subsystem	Storage controller documentation at Dell.com/storagecontrollermanuals
Check the event and error messages generated by the system firmware and agents that monitor system components	Dell Event and Error Messages Reference Guide at Dell.com/esmmanuals

Quick Resource Locator (QRL)

Use the Quick Resource Locator (QRL) to get immediate access to system information and how-to videos. This can be done by visiting Dell.com/QRL or by using your smartphone or tablet and a model specific Quick Resource (QR) code located on your Dell PowerEdge system. To try out the QR code, scan the following image.



Performing initial system configuration

After you receive your system, you must set up your system, install the operating system if it is not pre-installed, and set up and configure the system iDRAC IP address.

Setting up your system

1. Unpack the system.
2. Install the system into the rack. For more information on installing the system into the rack, see your system *Rack Installation Placemat* at Dell.com/poweredgemanuals.
3. Connect the peripherals to the system.
4. Connect the system to its electrical outlet.
5. Turn on the system by pressing the power button or using iDRAC.
6. Turn on the attached peripherals.

Setting up and configuring the iDRAC IP address

You can set up the Integrated Dell Remote Access Controller (iDRAC) IP address by using one of the following interfaces:

- iDRAC Settings utility
- Lifecycle Controller
- Dell OpenManage Deployment Toolkit
- Server LCD panel

You can use the default iDRAC IP address 192.168.0.120 to configure the initial network settings, including setting up DHCP or a static IP for iDRAC.

You can configure iDRAC IP address by using the following interfaces:

 **NOTE:** Make sure that you change the default user name and password after setting up the iDRAC IP address.

- iDRAC Web interface. For more information, see the Integrated Dell Remote Access Controller User's Guide.
- Remote Access Controller Admin (RACADM). For more information, see the RACADM Command Line Interface Reference Guide and the Integrated Dell Remote Access Controller User's Guide.
- Remote Services that includes Web Services Management (WS-Man). For more information, see the Lifecycle Controller Remote Services Quick Start Guide.

For more information on setting up and configuring iDRAC, see the Integrated Dell Remote Access Controller User's Guide at Dell.com/esmanuals.

Logging in to iDRAC

You can log in to iDRAC as an iDRAC local user, a Microsoft Active Directory user, or a Lightweight Directory Access Protocol (LDAP) user. You can also log in by using Single Sign-On or a Smart Card. The default user name is **root** and password is **calvin**. For more information on logging in to iDRAC and iDRAC licenses, see the Integrated Dell Remote Access Controller User's Guide at Dell.com/esmanuals.

You can also access iDRAC using RACADM. For more information, see the RACADM Command Line Interface Reference Guide and the Integrated Dell Remote Access Controller User's Guide available at Dell.com/esmanuals.

Methods of installing the operating system

If the system is shipped without an operating system, install the supported operating system on the system by using one of the following methods:

- Dell Systems Management Tools and Documentation media. See the operating system documentation at Dell.com/operatingsystemmanuals.
- Dell Lifecycle Controller. See the Lifecycle Controller documentation at Dell.com/esmanuals.
- Dell OpenManage Deployment Toolkit. See the OpenManage documentation at Dell.com/openmanagemanuals.

For information on the list of operating systems supported on your system, see the operating systems support matrix at Dell.com/ossupport.

Managing your system remotely

To perform out-of-band systems management using iDRAC, you must configure iDRAC for remote accessibility, set up the management station and managed system, and configure the supported Web browsers. For more information, see the Integrated Dell Remote Access Controller User's Guide at Dell.com/esmanuals.

You can also remotely monitor and manage the server by using the Dell OpenManage Server Administrator (OMSA) software and OpenManage Essentials (OME) systems management console. For more information, see Dell.com/openmanagemanuals.

Downloading drivers and firmware

It is recommended that you download and install the latest BIOS, drivers, and systems management firmware on your system.

Prerequisites

Ensure that you clear the web browser cache.

Steps

1. Go to **Dell.com/support/drivers**.
2. In the **Product Selection** section, enter the Service Tag of your system in the **Service Tag or Express Service Code** field.



NOTE: If you do not have the Service Tag, select **Automatically detect my Service Tag for me** to allow the system to automatically detect your Service Tag, or select **Choose from a list of all Dell products** to select your product from the **Product Selection** page.

3. Click **Get drivers and downloads**.
The drivers that are applicable to your selection are displayed.
4. Download the drivers you require to a diskette drive, USB drive, CD, or DVD.

Pre-operating system management applications

The pre-operating system management applications for your system help you manage different settings and features without booting to the operating system.

Your system has the following pre-operating system management applications:

- System Setup
- Boot Manager
- Dell Lifecycle Controller

Navigation keys

The navigation keys can help you quickly access the pre-operating system management applications.

Key	Description
<Page Up>	Moves to the previous screen.
<Page Down>	Moves to the next screen.
Up arrow	Moves to the previous field.
Down arrow	Moves to the next field.
<Enter>	Enables you to type a value in the selected field (if applicable) or follow the link in the field.
Spacebar	Expands or collapses a drop-down list, if applicable.
<Tab>	Moves to the next focus area.
	 NOTE: This feature is applicable for the standard graphic browser only.
<Esc>	Moves to the previous page until you view the main screen. Pressing <Esc> in the main screen exits System BIOS or iDRAC Settings/ Device Settings/Service Tag Settings and proceeds with system boot.
<F1>	Displays the System Setup help.

About System Setup

Using **System Setup**, you can configure the BIOS settings, iDRAC settings, and device settings of your system.

You can access **System Setup** in two ways:

- Standard Graphical Browser — This is enabled by default.
- Text Browser — This is enabled by using Console Redirection.

 **NOTE:** By default, help text for the selected field is displayed in the graphical browser. To view the help text in the text browser, press <F1>.

Entering system setup

1. Turn on, or restart your system.
2. Press <F2> immediately after you see the following message:

<F2> = System Setup

If your operating system begins to load before you press <F2>, wait for the system to finish booting, and then restart your system and try again.

System Setup Main Menu

Option	Description
System BIOS	Enables you to configure BIOS settings.
iDRAC Settings	Enables you to configure iDRAC settings. The iDRAC Settings utility is an interface to set up and configure the iDRAC parameters by using UEFI. You can enable or disable various iDRAC parameters by using the iDRAC Settings utility. For more information about this utility, see the Integrated Dell Remote Access Controller User's Guide at Dell.com/esmmanuals .
Device Settings	Enables you to configure device settings.

System BIOS screen

By using the **System BIOS** screen, you can view the BIOS settings, edit specific functions such as **Boot Order**, **System Password**, **Setup Password**, set the RAID mode, and enable or disable USB ports.

To view the System BIOS screen click **System BIOS** on the **System Setup Main Menu**.

The **System BIOS** screen details are explained as follows:

Menu Item	Description
System Information	Displays information about the system such as the system model name, BIOS version, and Service Tag.
Memory Settings	Displays information and options related to the installed memory.
Processor Settings	Displays information and options related to the processor such as speed, cache size.
SATA Settings	Displays options to enable or disable the integrated SATA controller and ports.
Boot Settings	Displays options to specify the boot mode (BIOS or UEFI). Enables you to modify UEFI and BIOS boot settings.
Network Settings	Displays options to change the network settings.
Integrated Devices	Displays options to enable or disable integrated device controllers and ports and specify related features and options.
Serial Communication	Displays options to enable or disable the serial ports and specify related features and options.
System Profile Settings	Displays options to change the processor power management settings, memory frequency, and so on.
System Security	Displays options to configure the system security settings, such as system password, setup password, TPM security. It also enables or disables support for the power and NMI buttons on the system.
Miscellaneous Settings	Displays options to change the system date, time, and so on.

System Information screen

You can use the **System Information** screen to view system properties such as Service Tag, system model, and the BIOS version.

To view the **System Information** screen, click **System Setup Main Menu** → **System BIOS** → **System Information**.

The **System Information** screen details are explained as follows:

Menu Item	Description
System Model Name	Displays the system model name.
System BIOS Version	Displays the BIOS version installed on the system.
System Management Engine Version	Displays the current version of the Management Engine firmware.
System Service Tag	Displays the system service tag.
System Manufacturer	Displays the name of the system manufacturer.
System Manufacturer Contact Information	Displays the contact information of the system manufacturer.
System CPLD Version	Displays the current version of the system complex programmable logic device (CPLD) firmware.
UEFI Compliance Version	Displays the UEFI compliance level of the system firmware.

Memory Settings screen

You can use the **Memory Settings** screen to view all the memory settings as well as enable or disable specific memory functions such as system memory testing and node interleaving.

To view the **Memory Setting** screen, click **System Setup Main Menu** → **System BIOS** → **Memory Settings**.



Menu Item	Description
System Memory Size	Displays the amount of memory installed in the system.
System Memory Type	Displays the type of memory installed in the system.
System Memory Speed	Displays the system memory speed.
System Memory Voltage	Displays the system memory voltage.
Video Memory	Displays the amount of video memory utilized.
System Memory Testing	Specifies whether system memory tests are run during system boot. The options available are Enabled , Disabled and Hardware Based . By default, the System Memory Testing option is set to Disabled .
Memory Operating Mode	<p>Specifies the memory operating mode. The options available are fault resilient memory, Optimizer Mode, Advanced ECC Mode, Mirror Mode, Spare Mode, and Spare with Advanced ECC Mode. By default, the Memory Operating Mode option is set to Optimizer Mode.</p> <p> NOTE: The Memory Operating Mode can have different defaults and available options based on the memory configuration of your system.</p>
Node Interleaving	Specifies if Non-Uniform Memory architecture (NUMA) is supported. Node Interleaving options available are Enabled and Disabled . If this field is Enabled , memory interleaving is supported if a symmetric memory configuration is installed. If Disabled , the system supports NUMA (asymmetric) memory configurations. By default, Node Interleaving option is set to Disabled .
Spare Ranks per DDR channel	Specifies the number of DIMM ranks per DDR channel to configure as spare ranks when Memory Operating Mode is set to Spare Mode or Spare with Advanced ECC Mode. Spare Ranks per DDR channel options available are 1 spare rank per DDR channel and 2 spare ranks per DDR channel. Based on the memory configuration of the system, this option allows 2 spare ranks per DDR channel. By default, Spare Ranks per DDR channel option is set to 1 spare rank per DDR channel.
FRM Redundant Memory Size	Specifies the memory size to dedicate to Fault Resilient Memory (FRM) when Memory Operation Mode is set to Fault Resilient Mode . For FRM mode one memory riser per processor is dedicated for FRM. This option allows configuring the size of memory dedicated to FRM on each FRM riser. FRM Redundant Memory Size options are Full Riser , 64GB , and Half Riser . Half of the FRM size will be reserved for redundancy and not included in the total system memory size. By default, FRM Redundant Memory Size option is set to Full Riser .

Processor Settings screen

You can use the **Processor Settings** screen to view the processor settings and perform specific functions such as enabling virtualization technology, hardware prefetcher, and logical processor idling.

To view the **Processor Settings** screen, click **System Setup Main Menu** → **System BIOS** → **Processor Settings**.

Menu Item	Description
Logical Processor	Enables or disables the logical processors and displays the number of logical processors. If the Logical Processor option is set to Enabled , the BIOS displays all the logical processors. If this option is set to Disabled , the BIOS displays only one logical processor per core. By default, the Logical Processor option is set to Enabled .
QPI Speed	Allows you to control QuickPath Interconnect data rate settings.
Virtualization Technology	Enables or disables the additional hardware capabilities provided for virtualization. By default, the Virtualization Technology option is set to Enabled .
Address Translation Service (ATS)	Defines the Address Translation Cache (ATC) for devices to cache the DMA transactions. This field provides an interface to a chipset's Address Translation and Protection Table to translate DMA addresses to host addresses. By default, the option is set to Enabled .
Adjacent Cache Line Prefetch	Optimizes the system for applications that require high utilization of sequential memory access. By default, the Adjacent Cache Line Prefetch option is set to Enabled . You can disable this option for applications that require high utilization of random memory access.
Hardware Prefetcher	Enables or disables the hardware prefetcher. By default, the Hardware Prefetcher option is set to Enabled .
DCU Streamer Prefetcher	Allows you to enable or disable the Data Cache Unit (DCU) streamer prefetcher. By default, the DCU Streamer Prefetcher option is set to Enabled .
DCU IP Prefetcher	Enables or disables the Data Cache Unit (DCU) IP prefetcher. By default, the DCU IP Prefetcher option is set to Enabled .
Logical Processor Idling	Enables or disables the operating system capability to put logical processors in the idling state in order to reduce power consumption. By default, the option is set to Disabled .
Configurable TDP	Allows reconfiguration of Thermal Design Power (TDP) to lower levels. TDP refers to the maximum amount of power the cooling system is required to dissipate.
X2Apic Mode	Enables or disables the X2Apic mode.
Number of Cores per Processor	Controls the number of enabled cores in each processor. By default, the Number of Cores per Processor option is set to All .
Processor 64-bit Support	Specifies if the processor(s) support 64-bit extensions.
Processor Core Speed	Displays the maximum core frequency of the processor.
Processor Bus Speed	Displays the bus speed of the processor.

Menu Item	Description
	 NOTE: The processor bus speed option displays only when both processors are installed.
Processor 1	 NOTE: Depending on the number of installed CPUs, there may be up to four processor listings. The following settings are displayed for each processor installed in the system.
Family-Model-Stepping	Displays the family, model and stepping of the processor as defined by Intel.
Brand	Displays the brand name reported by the processor.
Level 2 Cache	Displays the total L2 cache.
Level 3 Cache	Displays the total L3 cache.
Number of Cores	Displays the number of cores per processor.

SATA Settings screen

You can use the **SATA Settings** screen to view the SATA settings of SATA devices and enable RAID on your system.

To view the **SATA Settings** screen click **System Setup Main Menu** → **System BIOS** → **SATA Settings**.

Menu Item	Description
Embedded SATA	Enables the embedded SATA to be set to Off , ATA , or AHCI modes. By default, the Embedded SATA option is set to AHCI .
Security Freeze Lock	Sends Security Freeze Lock command to the Embedded SATA drives during POST. This option is applicable only to ATA and AHCI mode.
Write Cache	Enables or disables the command for Embedded SATA drives during POST.
Port A	Sets the drive type of the selected device. For Embedded SATA settings in ATA mode, set this field to Auto to enable BIOS support. Set it to OFF to turn off BIOS support. For AHCI mode or RAID mode, BIOS always enables support.
Model	Displays the drive model of the selected device.
Drive Type	Displays the type of drive attached to the SATA port.
Capacity	Displays the total capacity of the hard drive. The field is undefined for removable media devices such as optical drives.
Port B	Sets the drive type of the selected device. For Embedded SATA settings in ATA mode, set this field to Auto to enable BIOS support. Set it to OFF to turn off BIOS support. For AHCI mode or RAID mode, BIOS always enables support.
Model	Displays the drive model of the selected device.
Drive Type	Displays the type of drive attached to the SATA port.
Capacity	Displays the total capacity of the hard drive. The field is undefined for removable media devices such as optical drives.



Menu Item	Description
Port C	Sets the drive type of the selected device. For Embedded SATA settings in ATA mode, set this field to Auto to enable BIOS support. Set it to OFF to turn off BIOS support. For AHCI mode or RAID mode, BIOS always enables support.
Model	Displays the drive model of the selected device.
Drive Type	Displays the type of drive attached to the SATA port.
Capacity	Displays the total capacity of the hard drive. The field is undefined for removable media devices such as optical drives.

Boot Settings screen

You can use the **Boot Settings** screen to set the Boot mode to either **BIOS** or **UEFI**. It also enables you to specify the boot order.

To view the **Boot Settings** screen, click **System Setup Main Menu** → **System BIOS** → **Boot Settings**.

The **Boot Settings** screen details are explained as follows:

Menu Item	Description
Boot Mode	<p>Enables you to set the boot mode of the system.</p> <p> CAUTION: Switching the boot mode may prevent the system from booting if the operating system is not installed in the same boot mode.</p> <p> NOTE: Setting this field to UEFI disables the BIOS Boot Settings menu. Setting this field to BIOS disables the UEFI Boot Settings menu.</p> <p>If the operating system supports UEFI, you can set this option to UEFI. Setting this field to BIOS allows compatibility with non-UEFI operating systems. By default, the Boot Mode option is set to BIOS.</p>
Boot Sequence Retry	Enables or disables the Boot Sequence Retry feature. If this field is enabled and the system fails to boot, the system reattempts the boot sequence after 30 seconds. By default, the Boot Sequence Retry option is set to Enabled .
Hard-Disk Failover	Specifies the devices in the Hard-Disk Drive Sequence that are attempted in the boot sequence. When this option is set to Disabled , only the first hard disk device in the list is attempted to boot. When set to Enabled , all hard disk devices are attempted to boot, as listed in the Hard-Disk Drive Sequence . This option is not enabled for UEFI Boot Mode.
Boot Option Settings	Configures the boot sequence and the boot devices.

Network Settings screen

You can use the **Network Settings** screen to modify PXE device settings. The **Network Settings** option is available only in the UEFI boot mode. BIOS does not control network settings in the BIOS boot mode. For BIOS boot mode, the network settings are handled by the network controllers option ROM.

To view the **Network Settings** screen, click **System Setup Main Menu** → **System BIOS** → **Network Settings**. The **Network Settings** screen details are explained as follows:

Menu Item	Description
PXE Device n (n = 1 to 4)	Enables or disables the device. When enabled, a UEFI boot option is created for the device.
PXE Device n Settings (n = 1 to 4)	Allows you to control the configuration of the PXE device.

Integrated Devices screen

The **Integrated Devices** screen allows you to view and configure the settings of all integrated devices including the video controller integrated RAID controller and the USB ports.

In the **System Setup Main Menu**, click **System BIOS** → **Integrated Devices**.



Menu Item	Description
User Accessible USB Ports	Allows you to enable or disable the USB ports. Selecting Only Back Ports On disables the front USB ports and selecting All Ports Off disables all USB ports. The USB keyboard and mouse operates during boot process in certain operating systems. After the boot process is complete, the USB keyboard and mouse do not work if the ports are disabled.  NOTE: Selecting Only Back Ports On and All Ports Off will disable the USB management port and also restrict access to iDRAC features.
Internal USB Port	Allows you to enable or disable the internal USB port. By default, the Internal USB Port option is set to Enabled .
Integrated RAID Controller	Enables or disables the integrated RAID controller. By default, the option is set to Enabled .
Integrated Network Card 1	Allows you to configure Network Daughter Card (NDC) in the system. By default, the option is set to Disabled (OS) .
I/OAT DMA Engine	Allows you to enable or disable the I/OAT option. Enable only if the hardware and software supports the feature.
Embedded Video Controller	Allows you to enable or disable the Embedded Video Controller . By default, the embedded video controller is Enabled . If the Embedded Video

Current State of Embedded Video Controller	Controller is the only display capability in the system (that is, no add-in graphics card is installed), then the Embedded Video Controller is automatically used as the primary display even if the Embedded Video Controller setting is Disabled . Displays the current state of the Embedded Video Controller. Current State of Embedded Video Controller is a read only field, indicating the current state for the Embedded Video Controller.
SR-IOV Global Enable	Allows you to enable or disable the BIOS configuration of Single Root I/O Virtualization (SR-IOV) devices. By default, the SR-IOV Global Enable option is set to Disabled .
OS Watchdog Timer	If your system stops responding, this watchdog timer aids in the recovery of your operating system. When this field is set to Enabled , the operating system is allowed to initialize the timer. When is the field is set to Disabled (the default), the timer will have no effect on the system.
Memory Mapped I/O above 4 GB	Allows you to enable support for PCIe devices that require large amounts of memory. By default, the option is set to Enabled .
Slot Disablement	Allows you to enable or disable the available PCIe slots on your system. The Slot Disablement feature controls the configuration of PCIe cards installed in the specified slot. Slot disablement must be used only when the installed peripheral card is preventing booting into the operating system or causing delays in system startup. If the slot is disabled, both the Option ROM and UEFI driver are disabled.

Serial Communication screen

You can use the **Serial Communication** screen to view the properties of the serial communication port. To view the **Serial Communication** click **System Setup Main Menu** → **System BIOS** → **Serial Communication**.

Menu Item	Description
Serial Communication	Selects serial communication devices (Serial Device 1 and Serial Device 2) in the BIOS. BIOS console redirection can also be enabled and the port address can be specified. By default, Serial Communication option is set to Auto .
Serial Port Address	Enables you to set the port address for serial devices. By default, the Serial Port Address option is set to Serial Device 1=COM2, Serial Device 2=COM1
	 NOTE: You can use only Serial Device 2 for the Serial Over LAN (SOL) feature. To use console redirection by SOL, configure the same port address for console redirection and the serial device.



Menu Item	Description
	 NOTE: Every time the system boots, the BIOS syncs the serial MUX setting saved in iDRAC. The serial MUX setting can independently be changed in iDRAC. Therefore, loading the BIOS default settings from within the BIOS setup utility may not always revert this setting to the default setting of Serial Device 1 .
External Serial Connector	<p>You can associate the External Serial Connector to Serial Device 1, Serial Device 2, or the Remote Access Device using this field.</p>  NOTE: Only Serial Device 2 can be used for (Serial Over LAN) SOL. To use console redirection by SOL, configure the same port address for console redirection and the serial device.  NOTE: Every time the system boots, the BIOS syncs the serial MUX setting saved in iDRAC. The serial MUX setting can independently be changed in iDRAC. Therefore, loading the BIOS default settings from within the BIOS setup utility may not always revert this setting to the default setting of Serial Device 1 .
Failsafe Baud Rate	Displays the failsafe baud rate for console redirection. The BIOS attempts to determine the baud rate automatically. This failsafe baud rate is used only if the attempt fails, and the value must not be changed. By default, the Failsafe Baud Rate option is set to 115200 .
Remote Terminal Type	Sets the remote console terminal type. By default, the Remote Terminal Type option is set to VT 100/VT 220 .
Redirection After Boot	Enables or disables the BIOS console redirection when the operating system is loaded. By default, the Redirection After Boot option is set to Enabled .

System Profile Settings screen

You can use the **System Profile Settings** screen to enable specific system performance settings such as power management.

To view the **System Profile Settings** screen, click **System Setup Main Menu** → **System BIOS** → **System Profile Settings**. The **System Profile Settings** screen details are explained as follows:



Menu Item	Description
System Profile	<p>Sets the system profile. If you set the System Profile option to a mode other than Custom, the BIOS automatically sets the rest of the options. You can only change the rest of the options if the mode is set to Custom. By default, the System Profile option is set to Performance Per Watt Optimized (DAPC). DAPC is Dell Active Power Controller.</p>  NOTE: The following parameters are available only when the System Profile option is set to Custom .
CPU Power Management	Sets the CPU power management. By default, the CPU Power Management option is set to System DBPM (DAPC) . DBPM is Demand-Based Power Management.
Memory Frequency	Sets the speed of the system memory. You can select Maximum Performance , Maximum Reliability , or a specific speed.

Menu Item	Description
Turbo Boost	Enables or disables the processor to operate in turbo boost mode. By default, the Turbo Boost option is set to Enabled .
Energy Efficient Turbo	Enables or disables the Energy Efficient Turbo . Energy Efficient Turbo (EET) is a mode of operation where a processor's core frequency is adjusted within the turbo range based on workload.
C1E	Enables or disables the processor to switch to a minimum performance state when it is idle. By default, the C1E option is set to Enabled .
C States	Enables or disables the processor to operate in all available power states. By default, the C States option is set to Enabled .
Collaborative CPU Performance Control	Enables or disables the CPU power management. When set to Enabled , the CPU power management is controlled by the OS DBPM and the System DBPM (DAPC). By default, the option is set to Disabled .
Memory Patrol Scrub	Sets the memory patrol scrub frequency. By default, the Memory Patrol Scrub option is set to Standard .
Memory Refresh Rate	Sets the memory refresh rate to either 1x or 2x. By default, the Memory Refresh Rate option is set to 1x .
Uncore Frequency	Enables you to select the Processor Uncore Frequency . Dynamic mode allows the processor to optimize power resources across the cores and uncore during runtime. The optimization of the uncore frequency to either save power or optimize performance is influenced by the setting of the Energy Efficiency Policy .
Energy Efficient Policy	Enables you to select the Energy Efficient Policy . The CPU uses the setting to manipulate the internal behavior of the processor and determines whether to target higher performance or better power savings.
Number of Turbo Boost Enabled Cores for Processor 1	 NOTE: If there are two processors installed in the system, you see an entry for Number of Turbo Boost Enabled Cores for Processor 2 . Controls the number of turbo boost enabled cores for processor 1. By default, the maximum number of cores is enabled.
Monitor/Mwait	Enables the Monitor/Mwait instructions in the processor. By default, the Monitor/Mwait option is set to Enabled for all system profiles, except Custom .  NOTE: This option can be disabled only if the C States option in Custom mode is set to disabled .  NOTE: When C States set to Enabled in Custom mode, changing the Monitor/Mwait setting does not impact system power/performance.

System Security Settings screen

You can use the **System Security** screen to perform specific functions such as setting the system password, setup password and disabling the power button.

To view the **System Security** screen, click **System Setup Main Menu** → **System BIOS** → **System Security Settings**.

Menu Item	Description
Intel AES-NI	Improves the speed of applications by performing encryption and decryption using the Advanced Encryption Standard Instruction Set and is set to Enabled by default.
System Password	Sets the system password. This option is set to Enabled by default and is read-only if the password jumper is not installed in the system.
Setup Password	Sets the setup password. This option is read-only if the password jumper is not installed in the system.
Password Status	Locks the system password. By default, the Password Status option is set to Unlocked .
TPM Security	 NOTE: The TPM menu is available only when the TPM module is installed. Allows you to control the reporting mode of the Trusted Platform Module (TPM). By default, the TPM Security option is set to Off . You can only modify the TPM Status, TPM Activation, and Intel TXT fields if the TPM Status field is set to either On with Pre-boot Measurements or On without Pre-boot Measurements .
TPM Information	Changes the operational state of the TPM. By default, the TPM Activation option is set to No Change .
TPM Status	Displays the TPM status.
TPM Command	 CAUTION: Clearing the TPM results in the loss of all keys in the TPM. The loss of TPM keys may affect booting to the operating system. Clears all the contents of the TPM. By default, the TPM Clear option is set to No .
Intel TXT	Enables or disables the Intel Trusted Execution Technology (TXT). To enable Intel TXT , Virtualization Technology must be enabled and TPM Security must be Enabled with Pre-boot measurements. By default, the Intel TXT option is set to Off .
Power Button	Enables or disables the power button on the front of the system. By default, the Power Button option is set to Enabled .
NMI Button	Enables or disables the NMI button on the front of the system. By default, the NMI Button option is set to Disabled .
AC Power Recovery	Sets how the system reacts after AC power is restored to the system. By default, the AC Power Recovery option is set to Last .
AC Power Recovery Delay	Sets how the system supports staggering of power up after AC power is restored to the system. By default, the AC Power Recovery Delay option is set to Immediate .

Menu Item	Description
User Defined Delay (60s to 240s)	Sets the User Defined Delay when the User Defined option for AC Power Recovery Delay is selected.
UEFI Variable Access	Provides varying degrees of securing UEFI variables. When set to Standard (the default), UEFI variables are accessible in the Operating System per the UEFI specification. When set to Controlled , selected UEFI variables are protected in the environment and new UEFI boot entries are forced to be at the end of the current boot order.
Secure Boot	Enables Secure Boot, where the BIOS authenticates each pre-boot image using the certificates in the Secure Boot Policy. Secure Boot is disabled by default.
Secure Boot Policy	When Secure Boot policy is set to Standard , the BIOS uses the system manufacturer's key and certificates to authenticate pre-boot images. When Secure Boot policy is set to Custom , the BIOS uses the user-defined key and certificates. Secure Boot policy is set to Standard by default.
Secure Boot Policy Summary	Displays the list of certificates and hashes that secure boot uses to authenticate images.

Secure Boot Custom Policy Settings screen

Secure Boot Custom Policy Settings is displayed only when **Secure Boot Policy** is set to **Custom**. In the **System Setup Main Menu**, click **System BIOS** → **System Security** → **Secure Boot Custom Policy Settings**. The **Secure Boot Custom Policy Settings** screen details are explained as follows:

Menu Item	Description
Platform Key	Imports, exports, deletes, or restores the platform key (PK).
Key Exchange Key Database	Enables you to import, export, delete, or restore entries in the Key Exchange Key (KEK) Database.
Authorized Signature Database	Imports, exports, deletes, or restores entries in the Authorized Signature Database (db).
Forbidden Signature Database	Imports, exports, deletes, or restores entries in the Forbidden Signature Database (dbx).

Miscellaneous Settings screen

You can use the **Miscellaneous Settings** screen to perform specific functions such as updating the asset tag, and changing the system date and time.

To view the **Miscellaneous Settings** click **System Setup Main Menu** → **System BIOS** → **Miscellaneous Settings**.

Menu Item	Description
System Time	Enables you to set the time on the system.
System Date	Enables you to set the date on the system.
Asset Tag	Displays the asset tag and enables you to modify it for security and tracking purposes.

Menu Item	Description
Keyboard NumLock	Enables you to set whether the system boots with the NumLock enabled or disabled. By default the Keyboard NumLock is set to On .  NOTE: This option does not apply to 84-key keyboards.
F1/F2 Prompt on Error	Enables or disables the F1/F2 prompt on error. By default, F1/F2 Prompt on Error is set to Enabled . The F1/F2 prompt also includes keyboard errors.
Load Legacy Video Option ROM	Enables you to determine whether the system BIOS loads the legacy video (INT 10H) option ROM from the video controller. Selecting Enabled in the operating system does not support UEFI video output standards. This field is only for UEFI boot mode. You cannot set this to Enabled if UEFI Secure Boot mode is enabled.

About Boot Manager

Boot Manager enables you to add, delete, and arrange boot options. You can also access System Setup and boot options without restarting the system.

Entering Boot Manager

The **Boot Manager** screen enables you to select boot options and diagnostic utilities.

1. Turn on, or restart your system.
2. Press F11 when you see the message `F11 = Boot Manager`.
If your operating system begins to load before you press F11, allow the system to finish booting, and then restart your system and try again.

Boot Manager main menu

Menu Item	Description
Continue Normal Boot	The system attempts to boot to devices starting with the first item in the boot order. If the boot attempt fails, the system continues with the next item in the boot order until the boot is successful or no more boot options are found.
One Shot Boot Menu	Takes you to the boot menu, where you can select a one time boot device to boot from.
Launch System Setup	Enables you to access System Setup.
Launch Lifecycle Controller	Exits the Boot Manager and invokes the Lifecycle Controller program.

Menu Item	Description
System Utilities	Launches System Utilities menu such as System Diagnostics and UEFI shell.

About Dell Lifecycle Controller

Dell Lifecycle Controller allows you to perform tasks such as configuring BIOS and hardware settings, deploying an operating system, updating drivers, changing RAID settings, and saving hardware profiles. For more information about Dell Lifecycle Controller, see the documentation at Dell.com/esmanuals.

Changing the boot order

You may have to change the boot order if you want to boot from a USB key or an optical drive. The following instructions may vary if you have selected **BIOS** for **Boot Mode**.

1. From the **System Setup Main Menu**, click **System BIOS** → **Boot Settings**.
2. Click **Boot Option Settings** → **Boot Sequence**.
3. Use the arrow keys to select a boot device, and use the Plus (+) and Minus (-) sign keys to move the device down or up in the order.
4. Click **Exit**, and then click **Yes** to save the settings on exit.

Choosing the system boot mode

System Setup enables you to specify one of the following boot modes for installing your operating system:

- BIOS boot mode (the default) is the standard BIOS-level boot interface.
- Unified Extensible Firmware Interface (UEFI) boot mode is an enhanced 64-bit boot interface. If you have configured your system to boot to UEFI mode, it overlays the system BIOS.

1. From the **System Setup Main Menu**, click **Boot Settings** and select **Boot Mode**.
2. Select the boot mode you want the system to boot into.



NOTE: After the system boots in the specified boot mode, proceed to install your operating system from that mode.



CAUTION: Trying to boot the operating system from the other boot mode will cause the system to halt at startup.



NOTE: Operating systems must be UEFI-compatible to be installed from the UEFI boot mode. DOS and 32-bit operating systems do not support UEFI and can only be installed from the BIOS boot mode.



NOTE: For the latest information on supported operating systems, go to Dell.com/ossupport.

Assigning a system or setup password

Prerequisites

 **NOTE:** The password jumper enables or disables the System Password and Setup Password features. For more information on the password jumper settings, see [System board jumper settings](#).

You can assign a new **System Password** or **Setup Password** or change an existing **System Password** or **Setup Password** only when the password jumper setting is enabled and **Password Status** is set to **Unlocked**. If the Password Status is set to **Locked**, you cannot change the System Password or Setup Password.

If the password jumper setting is disabled, the existing System Password and Setup Password is deleted and you need not provide the system password to boot the system.

Steps

1. To enter **System Setup**, press F2 immediately after a power-on or reboot.
2. In the **System Setup Main Menu**, select **System BIOS** and press Enter.
The **System BIOS** screen is displayed.
3. In the **System BIOS** screen, select **System Security** and press Enter.
The **System Security** screen is displayed.
4. In the **System Security** screen, verify that **Password Status** is **Unlocked**.
5. Select **System Password**, enter your system password, and press Enter or Tab.
Use the following guidelines to assign the system password:
 - A password can have up to 32 characters.
 - The password can contain the numbers 0 through 9.
 - Only the following special characters are allowed: space, ("), (+), (.), (-), (.), (/), (:), (|), (\), (|), (').

A message prompts you to re-enter the system password.

6. Re-enter the system password and click **OK**.
7. Select **Setup Password**, enter your system password and press Enter or Tab.
A message prompts you to re-enter the setup password.
8. Re-enter the setup password click **OK**.
9. Press Esc to return to the System BIOS screen. Press Esc again, and a message prompts you to save the changes.

 **NOTE:** Password protection does not take effect until the system reboots.

Using your system password to secure your system

About this task

If you have assigned a setup password, the system accepts your setup password as an alternate system password.

Steps

1. Turn on or reboot your system.
2. Type your system password and press Enter.

Next steps

When **Password Status** is **Locked**, type the password and press <Enter> when prompted at reboot.

 **NOTE:** If an incorrect system password is entered, the system displays a message and prompts you to re-enter your password. You have three attempts to enter the correct password. After the third unsuccessful attempt, the system displays an error message that the system has halted and must be powered down.

Even after you shut down and restart the system, the error message is displayed until the correct password is entered.

 **NOTE:** You can use the **Password Status** option with the **System Password** and **Setup Password** options to protect your system from unauthorized changes.

Deleting or changing an existing system password or setup password

Prerequisites

Ensure that the Password jumper is set to **enabled** and the **Password Status** is set to **Unlocked** before attempting to delete or change the existing System password or Setup password. You cannot delete or change an existing System password or Setup password if the **Password Status** is set to **Locked**.

Steps

1. To enter System Setup, press **F2** immediately after a power-on or restart.
2. In **System Setup Main Menu**, select **System BIOS** and press **Enter**.
The **System BIOS** screen is displayed.
3. In the **System BIOS** screen, select **System Security** and press **Enter**.
The **System Security** screen is displayed.
4. In the **System Security** screen, verify that **Password Status** is set to **Unlocked**.
5. Select **System Password**, change or delete the existing system password and press **Enter** or **Tab**.
6. Select **Setup Password**, change or delete the existing setup password and press **Enter** or **Tab**.
 **NOTE:** If you change the System password or Setup password, a message prompts you to re-enter the new password. If you delete the System password or Setup password, a message prompts you to confirm the deletion.
7. Press **Esc** to return to the System BIOS screen. Press **Esc** again, and a message prompts you to save the changes and exit.

Operating with a setup password enabled

If **Setup Password** is set to **Enabled**, enter the correct setup password before modifying most of the System Setup options.

If you do not enter the correct password in three attempts, the system displays the following message:
Invalid Password! Number of unsuccessful password attempts: <x> System Halted!
Must power down.

Even after you shut down and restart the system, the error message is displayed until the correct password is entered. The following options are exceptions:

- If **System Password** is not **Enabled** and is not locked through the **Password Status** option, you can assign a system password.
- You cannot disable or change an existing system password.

 **NOTE:** You can use the Password Status option with the **Setup Password** option to protect the system password from unauthorized changes.

Embedded system management

The Dell Lifecycle Controller provides advanced embedded systems management throughout the server's lifecycle. The Lifecycle Controller can be started during the boot sequence and can function independently of the operating system.

 **NOTE:** Certain platform configurations may not support the full set of features provided by the Lifecycle Controller.

For more information about setting up the Lifecycle Controller, configuring hardware and firmware, and deploying the operating system, see the Lifecycle Controller documentation at Dell.com/support/home.

iDRAC Settings utility

The iDRAC Settings utility is an interface to set up and configure the iDRAC parameters using UEFI. You can enable or disable various iDRAC parameters using the iDRAC Settings Utility.

 **NOTE:** Accessing some of the features on the iDRAC Settings utility requires the iDRAC Enterprise License upgrade.

For more information on using iDRAC, see the iDRAC User's Guide at dell.com/esmmanuals.

Entering the iDRAC Settings utility

1. Turn on or restart the managed system.
2. Press <F2> during Power-on Self-test (POST).
3. In the System Setup Main Menu page, click **iDRAC Settings**.
The iDRAC Settings screen is displayed.

Changing the Thermal Settings

The iDRAC Settings utility enables you to select and customize the thermal control settings for your system.

1. Enter the iDRAC Settings utility.
2. Under **iDRAC Settings** → **Thermal** → **User Option**, select one of the following options:
 - Default
 - Maximum Exhaust Temperature
 - Fan Speed Offset



NOTE: When the **User Option** is set to the default **Auto** setting, the user option cannot be modified.

3. Set the **Maximum Air Exhaust Temperature** or the **Fan Speed Offset** fields.
4. Click **Back** → **Finish** → **Yes**.

Installing and removing system components

This section provides information about installing and removing the R930 components.

Customer and field replaceable units







The following components are Customer Replaceable Units (CRUs):

- Left and right PCIe risers
- Memory riser
- Cooling fans
- Control panel
- Expansion card riser
- Expansion cards
- Internal dual SD module (IDSMD)
- SD cards
- Internal USB keys
- Power supply units (PSUs)
- 2.5 inch hard drives/Solid State Devices (SSDs)
- Memory modules
- SAS expander daughter card
- Cable management tray
- Memory riser and fan cage
- Fan tray
- Hard drive backplane
- Processor blank and heat sink blank

The following components are Field Replaceable Units (FRUs). Removal and installation procedures should be performed only by Dell certified service technicians.

- Chassis intrusion switch
- System board
- Trusted Platform Module (TPM)
- System battery
- Control panel module
- Heat sinks and processors

Safety instructions

-  **WARNING:** Whenever you need to lift the system, get others to assist you. To avoid injury, do not attempt to lift the system by yourself.
-  **WARNING:** Opening or removing the system cover while the system is powered on may expose you to a risk of electric shock.
-  **CAUTION:** Do not operate the system without the cover for a duration exceeding five minutes.
-  **CAUTION:** Many repairs may only be done by a certified service technician. You should only perform troubleshooting and simple repairs as authorized in your product documentation, or as directed by the online or telephone service and support team. Damage due to servicing that is not authorized by Dell is not covered by your warranty. Read and follow the safety instructions that came with the product.
-  **NOTE:** It is recommended that you always use a static mat and static strap while working on components inside the system.
-  **NOTE:** To ensure proper operation and cooling, all bays in the system must be populated at all times with either a module or with a blank.

Before working inside your system

1. Turn off the system, including any attached peripherals.
2. Disconnect the system from the electrical outlet and disconnect the peripherals.
3. If installed, remove the front bezel.
4. Remove the system cover.

Related Tasks

- [Removing the optional front bezel](#)
- [Removing the system cover](#)

After working inside your system

1. Install the system cover.
2. If removed, install the front bezel.
3. Reconnect the system to its electrical outlet.
4. Turn on the system, including any attached peripherals.

Related Tasks

- [Installing the system cover](#)
- [Installing the optional front bezel](#)

Recommended tools

You need the following items to perform the procedures in this section:

- Key to the bezel lock
- Phillips #2 screwdriver
- Wrist strap

Front bezel (optional)

Installing the optional front bezel

1. Locate and remove the bezel key.
 **NOTE:** The bezel key is attached to the bezel.
2. Hook the right end of the bezel onto the system.
3. Fit the free end of the bezel onto the system.
4. Secure the bezel with the bezel key.

Removing the optional front bezel

1. Unlock the bezel by using the bezel key.
2. Lift the release latch adjacent to the bezel lock.
3. Pull the left end of the bezel, unhook the right end and remove the bezel.

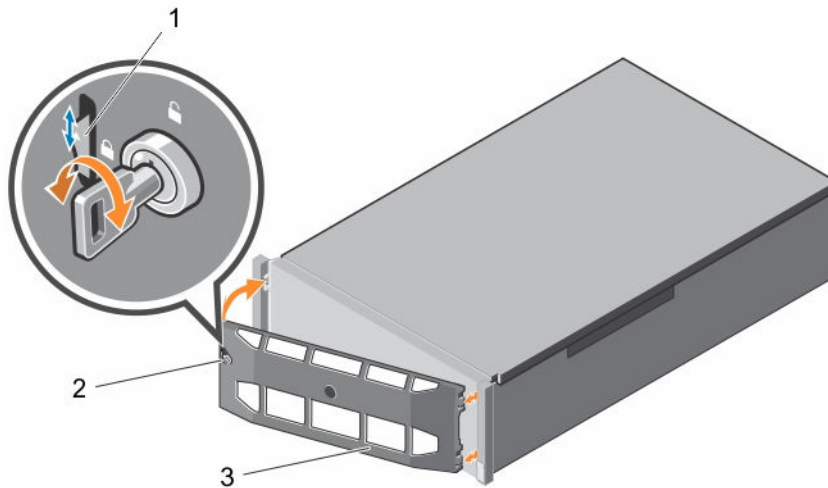

Figure 8. Removing and installing the front bezel

1. release latch
2. bezel lock
3. front bezel

System cover

- WARNING:** Whenever you need to lift the system, get others to assist you. To avoid injury, do not attempt to lift the system by yourself.
- WARNING:** Installing or removing the system cover when the system is on may expose you to a risk of electric shock.
- CAUTION:** Many repairs may only be done by a certified service technician. You should only perform troubleshooting and simple repairs as authorized in your product documentation, or as directed by the online or telephone service and support team. Damage due to servicing that is not authorized by Dell is not covered by your warranty. Read and follow the safety instructions that came with the product.
- CAUTION:** Do not operate the system without the system cover for a duration exceeding five minutes.

Removing the system cover

Prerequisites

1. Ensure that you follow the [Safety instructions](#).
2. Follow the procedure listed in [Before working inside your system](#).
3. If installed, remove the front bezel.

Steps

1. Turn the latch release lock to the unlock position.
2. Lift the latch and rotate the latch toward the back of the system.
The system cover slides back disengaging the tabs on the system cover from the slots on the chassis.
3. Hold the system cover on both sides, and lift the system cover away from the system.

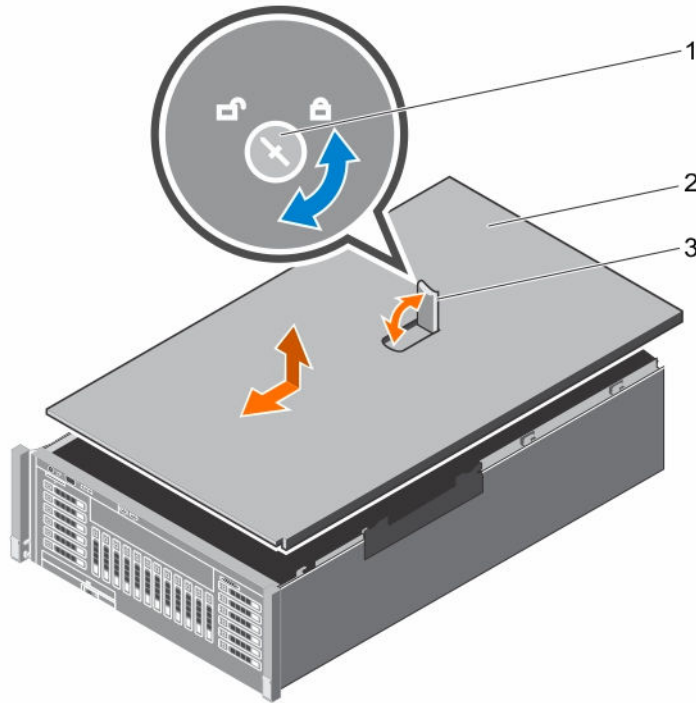

Figure 9. Removing and installing the system cover

- | | |
|-----------------------|-----------------|
| 1. latch release lock | 2. system cover |
| 3. system cover latch | |

Next steps

Install the system cover.

Related Tasks

[Removing the optional front bezel](#)

[Installing the system cover](#)

Installing the system cover

Prerequisites

Ensure that you follow the [Safety instructions](#).

Steps

1. Align the slots of the system cover with the tabs on the chassis.
2. Push the system cover latch toward the system cover until the latch locks into place.

 **NOTE:** The system cover slides forward engaging the tabs on the system cover with the slots on the chassis.

3. Turn the latch release lock clockwise to the locked position.

Next steps

1. If removed, install the front bezel.
2. Follow the procedure listed in [After working inside your system](#).

Related Tasks

[Installing the optional front bezel](#)

Inside the system

⚠ CAUTION: Many repairs may only be done by a certified service technician. You should only perform troubleshooting and simple repairs as authorized in your product documentation, or as directed by the online or telephone service and support team. Damage due to servicing that is not authorized by Dell is not covered by your warranty. Read and follow the safety instructions that came with the product.

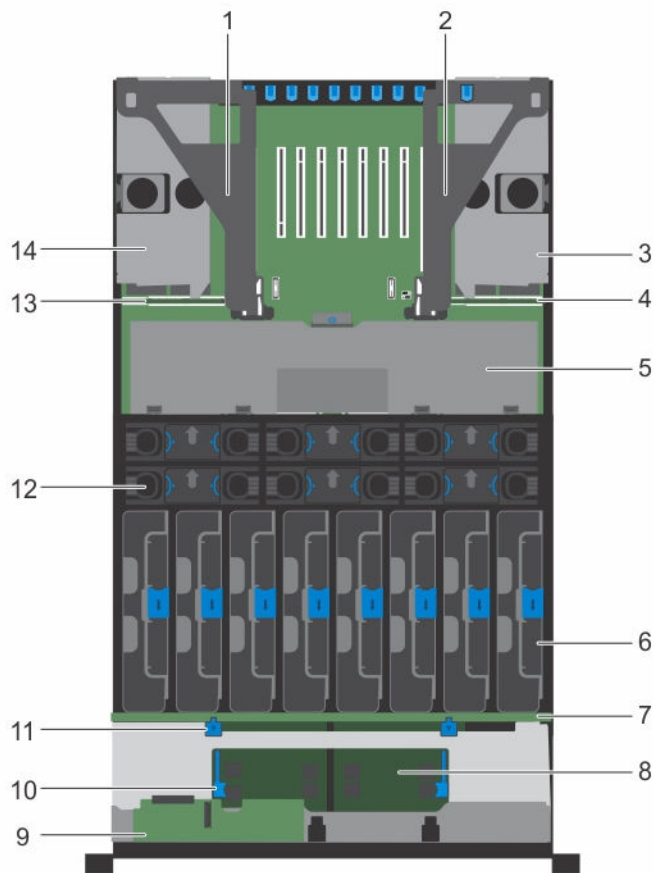



Figure 10. Inside the system

1. left expansion card riser assembly
2. right expansion card riser assembly

- | | |
|--|--|
| 3. right power supply bay | 4. right power distribution board |
| 5. cable management tray | 6. memory riser (8) |
| 7. hard drive backplane | 8. SAS expander daughter card (primary) |
| 9. control panel board | 10. release tab for SAS expander daughter card (2) |
| 11. release tab for hard drive backplane (2) | 12. cooling fan (6) |
| 13. left power distribution board | 14. left power supply bay |

Chassis intrusion switch

 **CAUTION:** Many repairs may only be done by a certified service technician. You should only perform troubleshooting and simple repairs as authorized in your product documentation, or as directed by the online or telephone service and support team. Damage due to servicing that is not authorized by Dell is not covered by your warranty. Read and follow the safety instructions that came with the product.

 **NOTE:** This is a Field Replaceable Unit (FRU). Removal and installation procedures should be performed only by Dell certified service technicians.

The chassis intrusion switch is located on the Network Daughter Card (NDC) riser, connected to the NDC riser card. It is used to detect unauthorized access to the inside of the system. The intrusion is indicated on the Embedded Server Management (ESM) when the system cover is open.

 **NOTE:** If the intrusion cable is missing or not connected, a notification is received in the ESM and intrusion status is not logged in the system event log.

Removing the chassis intrusion switch

Prerequisites

 **CAUTION:** Many repairs may only be done by a certified service technician. You should only perform troubleshooting and simple repairs as authorized in your product documentation, or as directed by the online or telephone service and support team. Damage due to servicing that is not authorized by Dell is not covered by your warranty. Read and follow the safety instructions that came with the product.

 **NOTE:** This is a Field Replaceable Unit (FRU). Removal and installation procedures should be performed only by Dell certified service technicians.

 **NOTE:** The chassis intrusion switch is detachable from the Network Daughter Card (NDC) riser. Ensure that it is not removed, so that the chassis intrusions are detected.

1. Ensure that you follow the [Safety instructions](#).
2. Follow the procedure listed in [Before working inside your system](#).
3. Remove the NDC riser.
4. Remove the NDC.

Steps

1. Press the intrusion switch and slide it out of the intrusion switch slot.
2. Disconnect the chassis intrusion switch cable connected to the NDC riser card.

 **NOTE:** The chassis intrusion switch cable is routed through a hook on the NDC riser bracket.

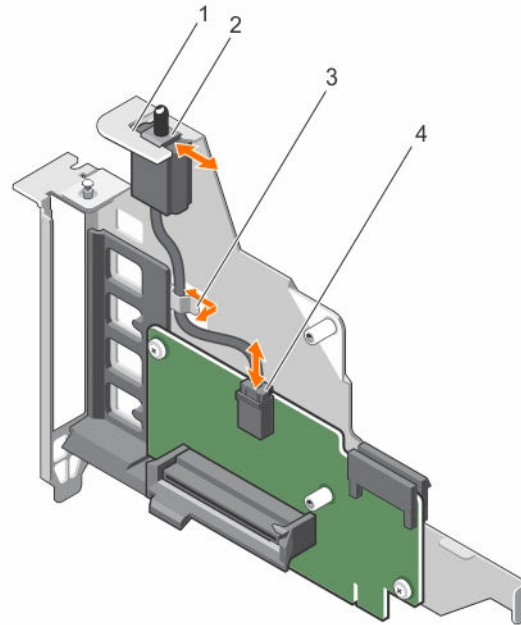

Figure 11. Removing and installing the chassis intrusion switch

- | | |
|----------------------------------|-----------------------------------|
| 1. intrusion switch slot | 2. chassis intrusion switch |
| 3. hook on the NDC riser bracket | 4. chassis intrusion switch cable |

Next steps

Install the chassis intrusion switch.

Related Tasks

[Removing the NDC riser](#)

[Removing the network daughter card](#)

[Installing the chassis intrusion switch](#)

Installing the chassis intrusion switch

Prerequisites

 **CAUTION:** Many repairs may only be done by a certified service technician. You should only perform troubleshooting and simple repairs as authorized in your product documentation, or as directed by the online or telephone service and support team. Damage due to servicing that is not authorized by Dell is not covered by your warranty. Read and follow the safety instructions that came with the product.

 **NOTE:** This is a Field Replaceable Unit (FRU). Removal and installation procedures should be performed only by Dell certified service technicians.

Ensure that you follow the [Safety instructions](#).

Steps

1. Slide the chassis intrusion switch into the intrusion switch slot.
2. Connect the chassis intrusion switch cable to the connector on the Network Daughter Card (NDC) riser card.
3. Route the cable through the hook on the NDC riser bracket.

Next steps

1. Install the NDC.
2. Install the NDC riser.
3. Follow the procedure listed in [After working inside your system](#).

Related Tasks

[Installing the network daughter card](#)

[Installing the NDC riser](#)

Cable management tray

The cable management tray is located above the heat sinks. It is used to route and manage the cables connecting the storage and expansion cards to various connectors on the backplane.

 **NOTE:** Cable management tray also facilitates proper cooling of the system. It helps control airflow to the processors and the expansion cards on the risers, when the risers are installed.

Removing the cable management tray

Prerequisites

 **CAUTION:** Many repairs may only be done by a certified service technician. You should only perform troubleshooting and simple repairs as authorized in your product documentation, or as directed by the online or telephone service and support team. Damage due to servicing that is not authorized by Dell is not covered by your warranty. Read and follow the safety instructions that came with the product.

1. Ensure that you follow the [Safety instructions](#).
2. Follow the procedure listed in [Before working inside your system](#).
3. Remove the following:
 - a. Memory risers
 - b. Cooling fans
 - c. Memory riser and fan cage
 - d. Memory riser blanks, if installed

Steps

1. To open the cable management tray, press the release tab.
2. Remove the cables routed through the cable management tray.
3. Press the cable management tray hooks to disengage them from the slots on the side of the chassis.
4. Lift the cable management tray out of the system.

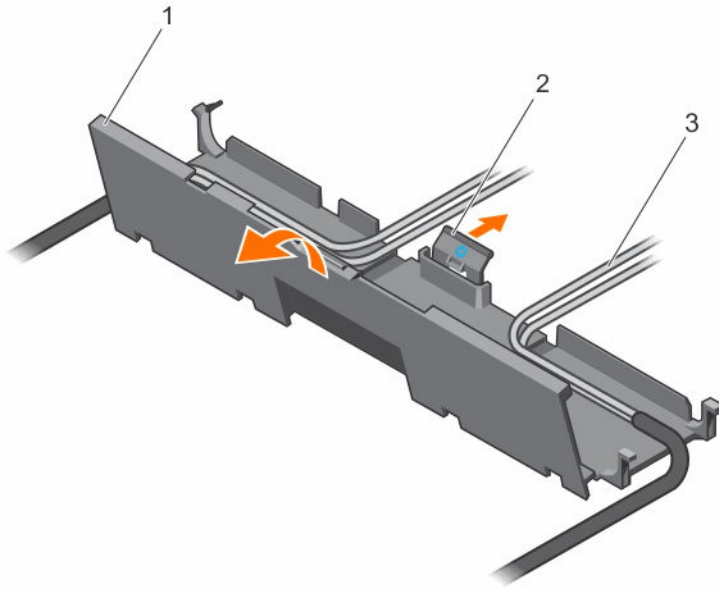

Figure 12. Removing the cables routed through the cable management tray

- 1. cable management tray
- 2. release tab
- 3. cables

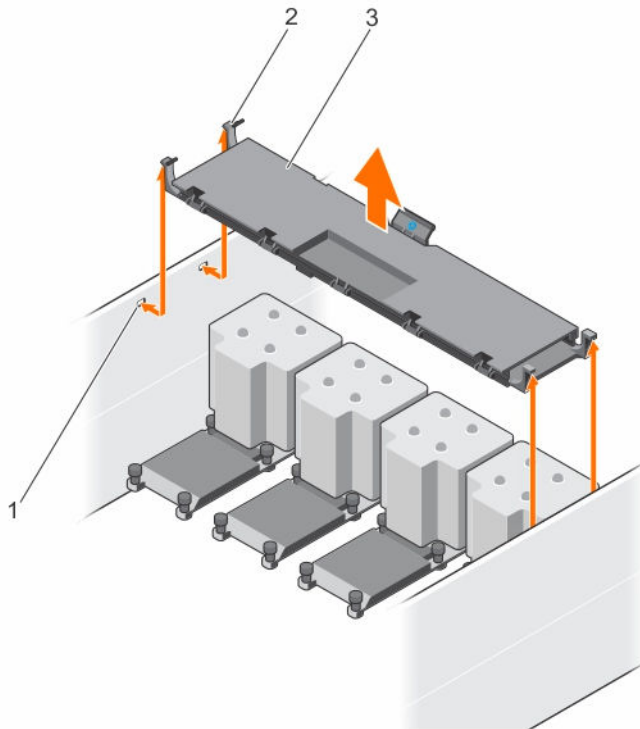

Figure 13. Removing and installing the cable management tray

- 1. slots on the chassis (4)
- 2. cable management tray hook (4)

3. cable management tray

Next steps

Install the cable management tray.

Related Tasks

- [Removing a memory riser](#)
- [Removing a cooling fan](#)
- [Removing the memory riser and fan cage](#)
- [Removing a memory riser blank](#)
- [Installing the cable management tray](#)

Installing the cable management tray

Prerequisites

 **CAUTION:** Many repairs may only be done by a certified service technician. You should only perform troubleshooting and simple repairs as authorized in your product documentation, or as directed by the online or telephone service and support team. Damage due to servicing that is not authorized by Dell is not covered by your warranty. Read and follow the safety instructions that came with the product.

Ensure that you follow the [Safety instructions](#).

Steps

1. Position the cable management tray above the heat sinks.
2. Lower one end of the cable management tray, and insert the cable management tray hooks into the slots on the side of the chassis.
3. Lower the other end of the cable management tray, and press the cable management tray hooks so that they snap into the slots on the side of the chassis.
4. Open the cable management tray by using the release tab.
5. Route the cables through the cable management tray.
6. Close the cable management tray.

Next steps

1. Install the following:
 - a. Memory riser and fan cage
 - b. Cooling fans
 - c. Memory risers
 - d. Memory riser blanks, if removed
2. Follow the procedure listed in [After working inside your system](#).

Related Tasks

- [Installing the memory riser and fan cage](#)
- [Installing a cooling fan](#)
- [Installing a memory riser](#)
- [Installing a memory riser blank](#)

System memory

Your system supports DDR4 ECC registered DIMMs (RDIMMs) and load reduced DIMMs (LRDIMMs) at DDR4 (1.2V) voltage specification. It also supports single, dual and quad rank DIMMs of up to 1866 MHz.

 **NOTE:** MT/s indicates DIMM speed in MegaTransfers per second.

Memory bus operating frequency can be 1333 MT/s, 1600 MT/s, and 1866 MT/s depending on:

- DIMM type (RDIMM and LRDIMM)
- DIMM configuration (number of ranks)
- Maximum frequency of the DIMMs
- Number of DIMMs populated per channel
- System profile selected (for example, Performance Optimized, Custom, or Dense Configuration Optimized)
- Maximum supported DIMM frequency of the processors

The system memory contain 96 memory sockets organized into eight memory risers, split into four sets of two risers per processor. Each memory riser has:

- 12 DIMM sockets arranged into four channels. In each channel, the release levers of the first socket are marked white, the second socket black, and the third socket green.
- Two Scalable Memory Interconnect-2 (SMI-2) ports that help DIMMs to connect with the processor.
- Two Scalable Memory Buffers (SMB) that provide access to the DIMMs.

SMI-2 ports operate in two modes:

 **NOTE:** GT/s indicates memory bus speed in Giga transfers per second.

- Performance Mode (2:1) up to 3.2 GT/s for higher bandwidth.
- Lock Step Mode (1:1) up to 1.87 GT/s for higher DDR4 speeds and better RAS (Reliability, Availability, and Serviceability) features.

The maximum memory that is supported on your system varies according to the sizes of memory modules being used. Single, dual, and quad rank DIMMs of capacities 8 GB, 16 GB, and 32 GB are supported for a total of up to 3 TB.

 **NOTE:** DIMMs in memory risers A and B are assigned to processor 1, C and D are assigned to processor 2, E and F are assigned to processor 3 and G and H are assigned to processor 4.

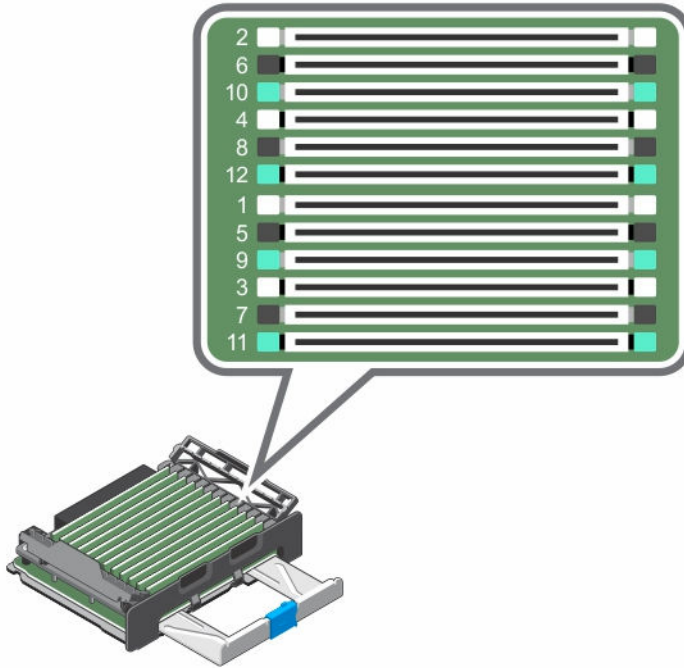

Figure 14. Memory socket locations

Memory channels are organized as follows:

- | | |
|--------------------|--|
| Processor 1 | channel 0: slots A1, A5, and A9
channel 1: slots A2, A6, and A10
channel 2: slots A3, A7, and A11
channel 3: slots A4, A8, and A12
channel 0: slots B1, B5, and B9
channel 1: slots B2, B6, and B10
channel 2: slots B3, B7, and B11
channel 3: slots B4, B8, and B12 |
| Processor 2 | channel 0: slots C1, C5, and C9
channel 1: slots C2, C6, and C10
channel 2: slots C3, B7, and C11
channel 3: slots C4, C8, and C12
channel 0: slots D1, D5, and D9
channel 1: slots D2, D6, and D10
channel 2: slots D3, D7, and D11
channel 3: slots D4, D8, and D12 |
| Processor 3 | channel 0: slots E1, E5, and E9 |

channel 1: slots E2, E6, and E10
channel 2: slots E3, E7, and E11
channel 3: slots E4, E8, and E12
channel 0: slots F1, F5, and F9
channel 1: slots F2, F6, and F10
channel 2: slots F3, F7, and F11
channel 3: slots F4, F8, and F12
Processor 4
channel 0: slots G1, G5, and G9
channel 1: slots G2, G6, and G10
channel 2: slots G3, G7, and G11
channel 3: slots G4, G8, and G12
channel 0: slots H1, H5, and H9
channel 1: slots H2, H6, and H10
channel 2: slots H3, H7, and H11
channel 3: slots H4, H8, and H12

The following table shows the memory populations and operating frequencies for the supported configurations (Performance Mode (2:1)).

DIMM Type	DIMMs Populated/ Channel (DPC)	DIMM Size	Operating Frequency (in MT/s)	Maximum DIMM Rank/ Channel
DDR4 2133 MT/s (1.2 V)				
RDIMM	1	8 GB, 16 GB, 32 GB	1600	Dual rank
	2	8 GB, 16 GB, 32 GB	1600	Dual rank
	3	8 GB, 16 GB, 32 GB	1333	Dual rank
LRDIMM	1	32 GB	1600	Quad rank
	2	32 GB	1600	Quad rank
	3	32 GB	1600	Quad rank

The following table shows the memory populations and operating frequencies for the supported configurations (Lock Step Mode (1:1)).

DIMM Type	DIMMs Populated/ Channel (DPC)	DIMM Size	Operating Frequency (in MT/s)	Maximum DIMM Rank/ Channel
DDR4 2133 MT/s (1.2 V)				
RDIMM	1	8 GB, 16 GB, 32 GB	1866	Dual rank
	2	8 GB, 16 GB, 32 GB	1866	Dual rank
	3	8 GB, 16 GB, 32 GB	1333	Dual rank
LRDIMM	1	32 GB	1866	Quad rank
	2	32 GB	1866	Quad rank
	3	32 GB	1600	Quad rank

General memory module installation guidelines

Your system supports Flexible Memory Configuration, enabling the system to be configured and run in any valid chipset architectural configuration. The following are the recommended guidelines for best performance:

- RDIMMs and LRDIMMs cannot be mixed.
- x4 and x8 DRAM based DIMMs can be mixed. For more information, see Mode-Specific Guidelines.
- Populate up to three dual- or single-rank RDIMMs per channel.
- Up to three quad rank LRDIMMs can be populated per channel.
- Up to three LRDIMMs can be populated regardless of rank count.
- Populate DIMM sockets only if a processor is installed. For dual-processor systems, sockets A1 to A12, B1 to B12 and sockets C1 to C12, D1 to D12 are available. Each processor requires a minimum of 2 DIMMs, which must be identical.
- Populate all sockets with white release lever first, then black, and then green.
- Populate the sockets by highest rank count in the following order — first in sockets with white release levers, then black, and then green. For example, if you want to mix single-rank and dual-rank RDIMMs, populate single-rank RDIMMs in the sockets with white release tabs and dual-rank RDIMMs in the sockets with black release tabs.
- The memory configuration for each processor should be identical. For example, if you populate socket A1 and B1 for processor 1, then populate socket C1 and D1 for processor 2, and so on.
- Memory modules of different sizes can be mixed provided that other memory population rules are followed (for example 8 GB and 16 GB memory modules can be mixed).
- Populate four DIMMs per processor (one DIMM per channel) at a time to maximize performance.
- If memory modules with different speeds are installed, they will operate at the speed of the slowest installed memory module(s) or slower depending on system DIMM configuration.

Mode-specific guidelines

Four memory channels are allocated to each processor. The allowable configurations depend on the memory mode selected.

-  **NOTE:** You can mix x4 and x8 DRAM based DIMMs to support RAS features. However, all guidelines for specific RAS features must be followed. x4 DRAM based DIMMs retain Single Device Data Correction (SDDC) in memory optimized (independent channel) mode. x8 DRAM based DIMMs require Advanced ECC mode to gain SDDC.

The following sections provide additional slot population guidelines for each mode:

Advanced ECC (Lockstep)

Advanced ECC mode extends SDDC from x4 DRAM based DIMMs to both x4 and x8 DRAMs. This protects against single DRAM chip failures during normal operation.

Memory installation guidelines:

- Memory modules within each matched pair must be identical in size, speed, and technology.
- DIMMs installed in memory sockets with white release tabs must be identical and similar rule applies for sockets with black and green release tabs. This ensures that identical DIMMs are installed in matched pairs - for example, A1 with A3, A2 with A4, A5 with A7, and so on.

-  **NOTE:** Advanced ECC with Mirroring is supported.

Memory optimized (independent channel) mode

This mode supports SDDC only for memory modules that use x4 device width, and this mode does not impose any specific slot population requirements.

Memory sparing

-  **NOTE:** To use memory sparing, this feature must be enabled in System Setup.

In this mode, one rank per channel is reserved as a spare. If persistent correctable errors are detected on a rank, the data from this rank is copied to the spare rank, and the failed rank is disabled.

With memory sparing enabled, the system memory available to the operating system is reduced by one rank per channel. For example, in a dual-processor configuration with sixteen 8 GB dual-rank memory modules, the available system memory is: $\frac{3}{4}$ (ranks/channel) \times 16 (memory modules) \times 8 GB = 96 GB, and not 16 (memory modules) \times 8 GB = 128 GB.

-  **NOTE:** Memory sparing does not offer protection against a multi-bit uncorrectable error.

-  **NOTE:** Both Advanced ECC/Lockstep and Optimizer modes support memory sparing.

Memory mirroring

Memory mirroring offers the strongest memory module reliability mode compared to all other modes, providing improved uncorrectable multi-bit failure protection. In a mirrored configuration, the total available system memory is one half of the total installed physical memory. Half of the installed memory is used to mirror the active memory modules. In the event of an uncorrectable error, the system switches over to the mirrored copy. This ensures SDDC and multi-bit protection.

The installation guidelines for memory modules are as follows

- Memory modules must be identical in size, speed, and technology.
- Memory modules installed in memory module sockets with white release levers must be identical and the same rule applies for sockets with black and green release tabs. This ensures that identical memory modules are installed in matched pairs—for example, A1 with A3, A2 with A4, A5 with A7, and so on.

Fault Resilient Memory

Fault Resilient Memory (FRM) mode operates with the parts of redundant system memory, leaving the rest of the system memory in non-mirror mode. It reduces the cost of memory mirroring by mirroring just the critical portion of memory versus mirroring the entire memory space. It provides additional flexibility to optimize cost, performance, or RAS by providing high degree of reliability to memory at lower cost than mirroring the entire system memory.

Memory Mirroring is a RAS feature that enables duplicating memory content at a remote DIMM in the partition. This capability enables high data availability from memory subsystem. Fault Resilient Memory enables you to select the segments of system memory that contains the most critical code.

Sample memory configurations

The following table shows sample memory configurations for a single processor that follow the appropriate memory guidelines stated in this section.

 **NOTE:** DIMMs populated must be identical for each riser. In the mirroring mode, only one of the two CPUs is populated.

Table 2. Memory configurations—single riser

Memory Mode	System Capacity (in GB)	DIMM Size (in GB)	Number of DIMMs	DIMM Slot Population for CPU 1 (Riser A and B)													
				2	6	10	4	8	12	1	5	9	3	7	11		
Advanced ECC Lockstep																	
	64	8	8	X			X			X			X				
	96	8	12	X			X			X	X		X	X			
	128	8	16	X	X		X	X		X	X		X	X			
	192	8	24	X	X	X	X	X	X	X	X	X	X	X	X	X	X
	64	16	4	X			X			X			X				
	96	16	6	X			X			X	X		X	X			
	128	16	8	X	X		X	X		X	X		X	X			
	128	32	4	X			X			X			X				
	192	32	6	X			X			X	X		X	X			
	256	32	8	X	X		X	X		X	X		X	X			
	384	32	12	X	X	X	X	X	X	X	X	X	X	X	X	X	X
Optimized Population	32	8	4	X			X			X			X				
	48	8	6	X						X			X				

Memory Mode	System Capacity (in GB)	DIMM Size (in GB)	Number of DIMMs	DIMM Slot Population for CPU 1 (Riser A and B)																		
(Independent Channel)	64	8	8	X						X							X					
	80	8	10	X						X			X	X			X					
	96	16	6	X									X				X					
	128	16	8	X									X				X					
	96	16	6	X									X				X					
	128	16	8	X									X				X					
	192	32	6	X									X				X					
	256	32	8	X									X				X					
	192	32	6	X									X				X					
	256	32	8	X									X				X					
	384	32	12	X	X								X	X			X	X				
Mirroring and Partial Mirroring	64	8	8	X								X				X						
	128	8	16	X	X					X	X		X	X		X	X		X	X		
	192	8	24	X	X	X				X	X	X	X	X	X	X	X	X	X	X	X	X
	128	16	8	X								X				X						
	256	16	16	X	X					X	X		X	X		X	X		X	X		
	384	16	24	X	X	X				X	X	X	X	X	X	X	X	X	X	X	X	X
	256	32	8	X								X				X						
	512	32	16	X	X					X	X		X	X		X	X		X	X		
	768	32	24	X	X	X				X	X	X	X	X	X	X	X	X	X	X	X	X

Memory riser

Removing a memory riser blank

Prerequisites

△ CAUTION: Many repairs may only be done by a certified service technician. You should only perform troubleshooting and simple repairs as authorized in your product documentation, or as directed by the online or telephone service and support team. Damage due to servicing that is not authorized by Dell is not covered by your warranty. Read and follow the safety instructions that came with the product.

1. Ensure that you follow the [Safety instructions](#).
2. Follow the procedure listed in [Before working inside your system](#).

Steps

Holding the slots on the memory riser blank, lift the memory riser blank out of the memory riser and fan cage.

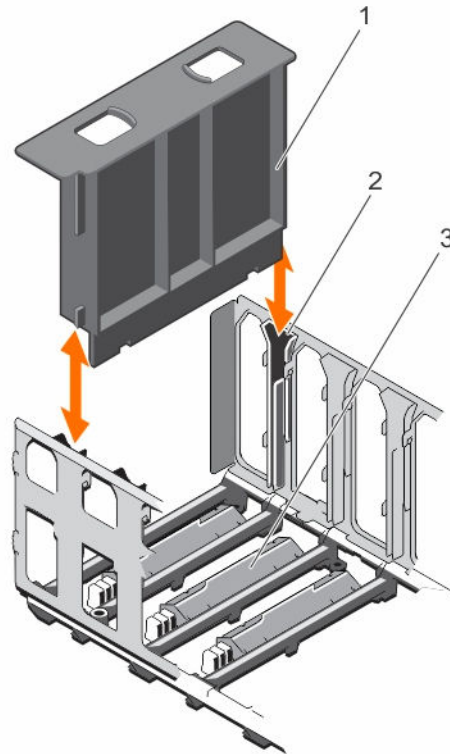

Figure 15. Removing and installing the memory riser blank

1. memory riser blank
2. guide on the memory riser and fan cage (2)
3. connector protective cap

Next steps

Install the memory riser blank or memory riser.

Related Tasks

[Installing a memory riser blank](#)

[Installing a memory riser](#)

Installing a memory riser blank

Prerequisites

⚠ CAUTION: Many repairs may only be done by a certified service technician. You should only perform troubleshooting and simple repairs as authorized in your product documentation, or as directed by the online or telephone service and support team. Damage due to servicing that is not authorized by Dell is not covered by your warranty. Read and follow the safety instructions that came with the product.

Ensure that you follow the [Safety instructions](#).

Steps

1. Align the memory riser blank with the guides on the memory riser and fan cage.
2. Insert the memory riser blank into the guides on the memory riser and fan cage until it is firmly seated.

Next steps

Follow the procedure listed in [After working inside your system](#).

Removing a memory riser

Prerequisites

 **CAUTION:** Many repairs may only be done by a certified service technician. You should only perform troubleshooting and simple repairs as authorized in your product documentation, or as directed by the online or telephone service and support team. Damage due to servicing that is not authorized by Dell is not covered by your warranty. Read and follow the safety instructions that came with the product.

1. Ensure that you follow the [Safety instructions](#).
2. Follow the procedure listed in [Before working inside your system](#).

Steps

1. Press the handle lock, and slide it in the direction of the arrow to release the memory riser handle.
2. Hold the memory riser handle and pull the memory riser out of the memory riser and fan cage.

 **CAUTION:** To maintain proper system cooling, all empty memory riser slots must have memory riser blanks installed.

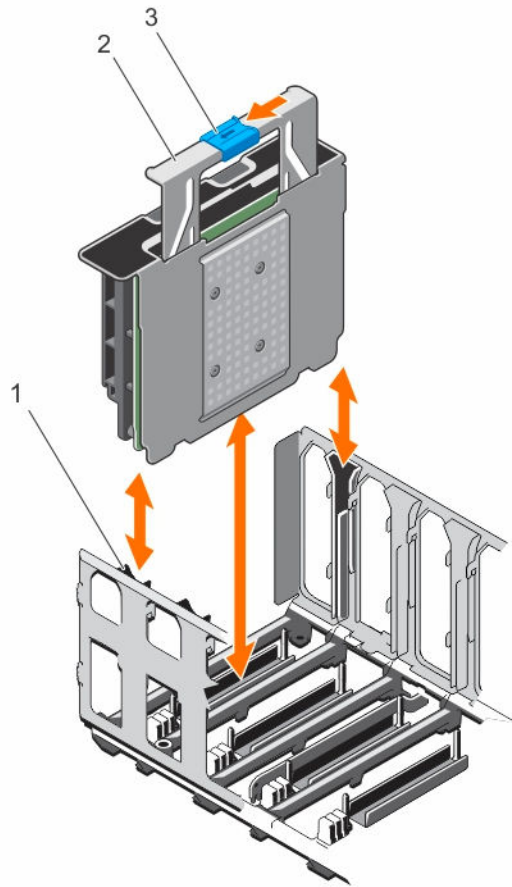

Figure 16. Removing and installing the memory riser

1. memory riser and fan cage
2. memory riser handle
3. handle lock

Next steps

Install a memory riser or a memory riser blank.

Related Tasks

[Installing a memory riser](#)

[Installing a memory riser blank](#)

Installing a memory riser

Prerequisites

△ CAUTION: Many repairs may only be done by a certified service technician. You should only perform troubleshooting and simple repairs as authorized in your product documentation, or as directed by the online or telephone service and support team. Damage due to servicing that is not authorized by Dell is not covered by your warranty. Read and follow the safety instructions that came with the product.

 **CAUTION:** Before installing the memory riser, ensure that the memory module socket ejectors are in the locked position. Also ensure cables from the hard drive backplane are placed in the cable latch and closed.

 **CAUTION:** Use the memory riser handle, while installing and removing the memory risers. Handling the memory riser without using the handle may cause injury.

1. Ensure that you follow the [Safety instructions](#).
2. If installed, remove the memory riser blank and the protective cap on the memory riser connector.

Steps

1. Hold the memory riser handle in the direction of the air flow, and align the memory riser with the guides on the memory riser and fan cage.
2. Insert the memory riser into the guides on the memory riser and fan cage until it is fully seated in the connector on the system board.

 **NOTE:** If the memory riser is not seated properly, the memory riser handle will not get locked.

3. Press the memory riser handle until the handle lock clicks into place.

Next steps

Follow the procedure listed in [After working inside your system](#).

Removing memory modules from the memory riser

Prerequisites

 **CAUTION:** Many repairs may only be done by a certified service technician. You should only perform troubleshooting and simple repairs as authorized in your product documentation, or as directed by the online or telephone service and support team. Damage due to servicing that is not authorized by Dell is not covered by your warranty. Read and follow the safety instructions that came with the product.

1. Ensure that you follow the [Safety instructions](#).
2. Follow the procedure listed in [Before working inside your system](#).
3. Remove the memory riser.

 **WARNING:** The memory modules are hot to touch for some time after the system has been powered down. Allow the memory modules to cool before handling them. Handle the memory modules by the card edges and avoid touching the components or metallic contacts on the memory module.

 **CAUTION:** To ensure proper system cooling, memory module blanks must be installed in any memory socket that is not occupied. Remove memory module blanks only if you intend to install memory modules in those sockets.

Steps

1. To open the memory riser, open the flip out brackets on the memory riser.

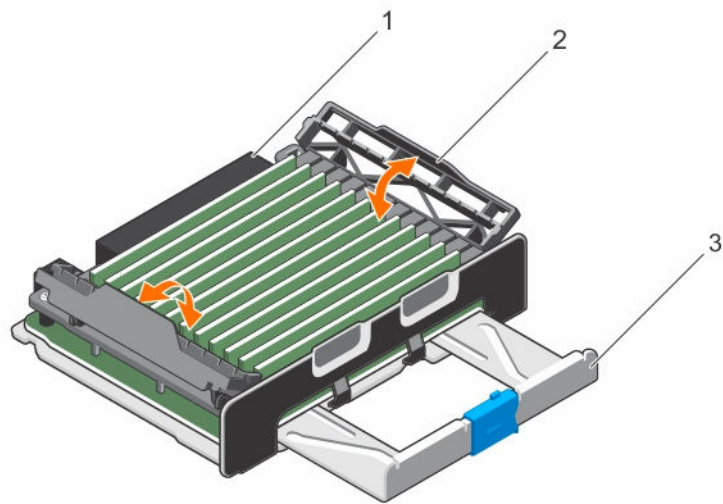

Figure 17. Opening and closing the memory riser

1. memory riser
 2. flip out bracket (2)
 3. memory riser handle
2. Locate the appropriate memory module socket.
 3. To release the memory module from the socket, simultaneously press the ejectors on both ends of the memory module socket.
 - ▣ **NOTE:** Handle each memory module only by the card edges, making sure not to touch the middle of the memory module or metallic contacts.
 4. Lift the memory module away from the chassis.

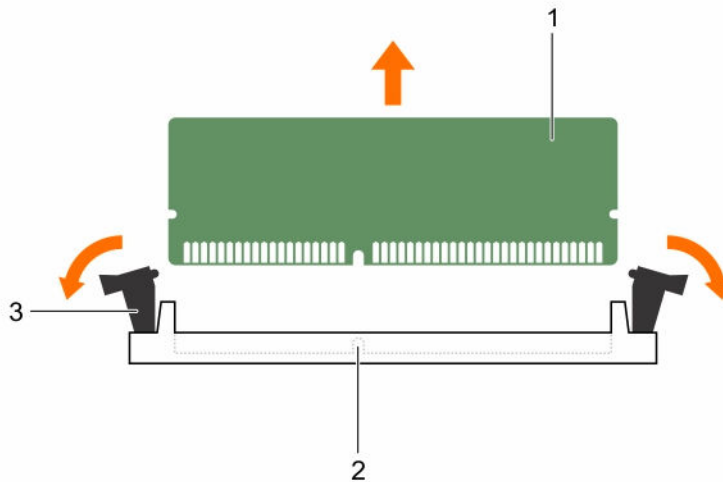

Figure 18. Removing and installing a memory module

1. memory module
2. memory module socket
3. memory module ejector (2)

Next steps

1. If you are removing a memory module permanently, install a memory module blank.





NOTE: The procedure for removing and installing a memory module blank is identical to removing and installing a memory module.

Related Tasks

[Removing a memory riser](#)

Installing memory modules into the memory riser

Prerequisites

-  **CAUTION:** Many repairs may only be done by a certified service technician. You should only perform troubleshooting and simple repairs as authorized in your product documentation, or as directed by the online or telephone service and support team. Damage due to servicing that is not authorized by Dell is not covered by your warranty. Read and follow the safety instructions that came with the product.
-  **WARNING:** The memory modules are hot to touch for some time after the system has been powered down. Allow the memory modules to cool before handling them. Handle the memory modules by the card edges and avoid touching the components or metallic contacts on the memory module.
-  **CAUTION:** To ensure proper system cooling, memory module blanks must be installed in any memory socket that is not occupied. Remove memory module blanks only if you intend to install memory modules in those sockets.

Ensure that you follow the [Safety instructions](#).

Steps

1. To open the memory riser, open the flip out brackets on the memory riser.
2. Locate the appropriate memory module socket.
 - △ **CAUTION: Handle each memory module only by the card edges, making sure not to touch the middle of the memory module or metallic contacts.**
3. If a memory module or a memory module blank is installed in the socket, remove it.
 - ✎ **NOTE:** The procedure to remove a memory module blank is similar to the procedure to remove a memory module.
 - ✎ **NOTE:** Retain removed memory module blank(s) for future use.
 - △ **CAUTION: To prevent damage to the memory module or the memory module socket during installation, do not bend or flex the memory module; insert both ends of the memory module simultaneously.**
4. Align the edge connector of the memory module with the alignment key on the memory module socket, and insert the memory module in the socket.
 - ✎ **NOTE:** The memory module socket has an alignment key that allows you to install the memory module in the socket in only one orientation.
 - △ **CAUTION: Do not apply pressure at the center of the memory module; apply pressure at both ends of the memory module evenly.**
5. Press the memory module with your thumbs until the memory module snaps into place.
6. Repeat step 3 through step 5 of this procedure to install the remaining memory modules.
7. Close the flip out brackets to secure the memory modules in the memory riser.

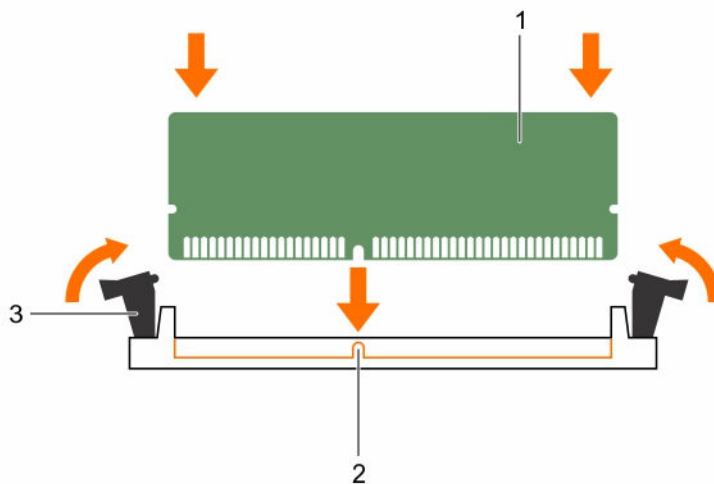

Figure 19. Installing a memory module

1. memory module
2. memory module socket
3. memory module ejector (2)

Next steps

1. Install the memory riser.
2. Follow the procedure listed in [After working inside your system](#).
3. Press F2 to enter System Setup, and check the **System Memory** setting. The **System Memory Size** value should reflect the installed memory.
4. If the **System Memory Size** value is incorrect, one or more of the memory modules may not be installed properly. Ensure that the memory modules are firmly seated in their sockets.
5. Run the system memory test in system diagnostics. See [Using system diagnostics](#).

Related Tasks

[Installing a memory riser](#)

Memory riser and fan cage

Removing the memory riser and fan cage

Prerequisites

 **CAUTION:** Many repairs may only be done by a certified service technician. You should only perform troubleshooting and simple repairs as authorized in your product documentation, or as directed by the online or telephone service and support team. Damage due to servicing that is not authorized by Dell is not covered by your warranty. Read and follow the safety instructions that came with the product.

1. Ensure that you follow the [Safety instructions](#).
2. Follow the procedure listed in [Before working inside your system](#).
3. Remove the following:
 - a. Memory risers
 - b. Cooling fans
 - c. Memory riser blanks, if installed

 **WARNING:** To avoid damage to the memory riser and fan cage, you must remove all the memory risers and cooling fans before removing the memory riser and fan cage.

Steps

1. Slide the cage handle lock in the direction of the arrow.
2. Holding the cage handle and rear handle, lift the memory riser and fan cage away from the system.

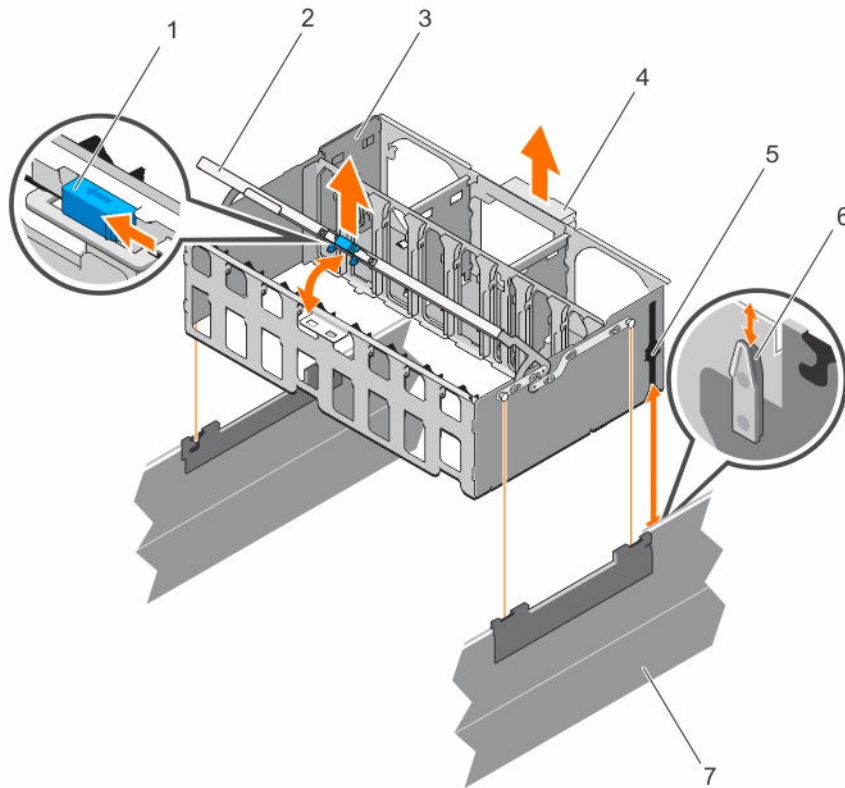

Figure 20. Removing and installing the memory riser and fan cage

- | | |
|------------------------------|-----------------------------|
| 1. cage handle lock | 2. cage handle |
| 3. memory riser and fan cage | 4. rear handle |
| 5. guide rail (2) | 6. guide on the chassis (2) |
| 7. chassis | |

Next steps

Install the memory riser and fan cage.

Related Tasks

- [Removing a memory riser blank](#)
- [Removing a memory riser](#)
- [Removing a cooling fan](#)
- [Installing the memory riser and fan cage](#)

Installing the memory riser and fan cage

Prerequisites

⚠ CAUTION: Many repairs may only be done by a certified service technician. You should only perform troubleshooting and simple repairs as authorized in your product documentation, or as directed by the online or telephone service and support team. Damage due to servicing that is not authorized by Dell is not covered by your warranty. Read and follow the safety instructions that came with the product.

Ensure that you follow the [Safety instructions](#).

 **NOTE:** Before installing the memory riser and fan cage, ensure there are no loose cables from the hard drive backplane. If the cables are not latched, the cage will not seat firmly into the chassis.

Steps

1. Lift the memory riser and fan cage by holding the cage handle and back of the cage.
2. Align the guide rails on the memory riser and fan cage with the guides on the chassis.
3. Lower the memory riser and fan cage into the system until it is firmly seated on the system board.
4. Lower the cage handle until the cage handle locks into place.

Next steps

1. Install the following:
 - a. Memory risers
 - b. Cooling fans
 - c. Memory riser blanks, if removed
2. Follow the procedure listed in [After working inside your system](#).

Related Tasks

[Installing a memory riser](#)

[Installing a cooling fan](#)

[Installing a memory riser blank](#)

Hard drives

Your system supports Entry Hard Drives and Enterprise Class Hard Drives. Entry Hard Drives are designed for 5x8 operating environment with less workload rating to drives and Enterprise Class Drives are designed for 24x7 operating environment. Selecting the correct drive class will enable the critical areas of quality, functionality, performance, and reliability to be optimized for the target implementation.

 **NOTE:** Do not mix Enterprise Class Drives with Entry Hard Drives.

Choosing the right drive type depends on the usage pattern. Improper use of Entry Hard Drives (workload rating exceed 55 TB/year) will lead to significant risk and increase the drives failure rate.

For more information on these hard drives, see the 512e and 4Kn Disk Formats whitepaper and 4K Sector HDD FAQ document at Dell.com/poweredge manuals.

Depending on the configuration, your system supports one of the following:

Four hard drive systems	Up to four 2.5 inch hot-swappable SAS hard drives, SATA hard drives, or SATA SSD
Twenty four hard drive systems	Up to twenty four 2.5 inch hot-swappable SAS hard drives, SATA hard drives, or SATA SSD
Sixteen hard drive/SSD plus eight PCIe SSD systems	Up to sixteen 2.5 inch hot-swappable SATA hard drives or SATA SSD plus eight 2.5 inch PCIe SSD

 **NOTE:** SSD/SAS/SATA hard drives cannot be mixed in a system.

The hot-swappable hard drives connect to the system board through the hard drive backplane. Hot-swappable hard drives are supplied in hot-swappable hard drive carriers that fit in the hard drive slots.

 **CAUTION:** Before attempting to remove or install a hot-swappable hard drive while the system is running, see the documentation for the storage controller card to ensure that the host adapter is configured correctly to support hot-swap hard drive removal and insertion.

 **CAUTION:** Do not turn off or reboot your system while the hard drive is being formatted. Doing so can cause a hard drive failure.

 **NOTE:** Use only hard drives that have been tested and approved for use with the hard drive backplane.

When you format a hard drive, allow enough time for the formatting to be completed. Be aware that high capacity hard drives can take a number of hours to format.

Removing a 2.5 inch hard drive blank

Prerequisites

 **CAUTION:** Many repairs may only be done by a certified service technician. You should only perform troubleshooting and simple repairs as authorized in your product documentation, or as directed by the online or telephone service and support team. Damage due to servicing that is not authorized by Dell is not covered by your warranty. Read and follow the safety instructions that came with the product.

 **CAUTION:** To maintain proper system cooling, all empty hard drive slots must have hard drive blanks installed.

1. Ensure that you follow the [Safety instructions](#).
2. Follow the procedure listed in [Before working inside your system](#).
3. If installed, remove the front bezel.

Steps

Press the release button and slide the hard drive blank out of the hard drive slot.

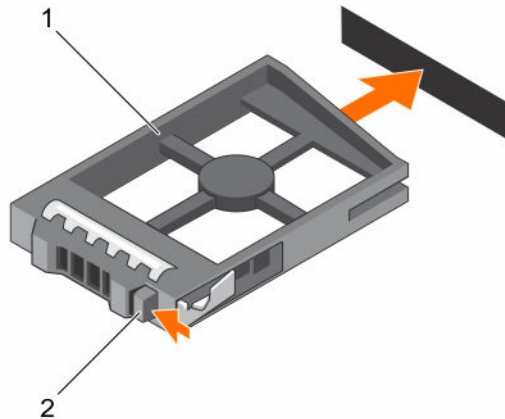

Figure 21. Removing and installing a 2.5 inch hard drive blank

1. hard drive blank
2. release button

Next steps

If removed, install the front bezel.

Related Tasks

[Removing the optional front bezel](#)

[Installing the optional front bezel](#)

Installing a 2.5 inch hard drive blank

Prerequisites

⚠ CAUTION: Many repairs may only be done by a certified service technician. You should only perform troubleshooting and simple repairs as authorized in your product documentation, or as directed by the online or telephone service and support team. Damage due to servicing that is not authorized by Dell is not covered by your warranty. Read and follow the safety instructions that came with the product.

1. Ensure that you follow the [Safety instructions](#).
2. If installed, remove the front bezel.

Steps

Insert the hard drive blank into the hard drive slot until the release button clicks into place.

Next steps

If removed, install the front bezel.

Related Tasks

[Removing the optional front bezel](#)

[Installing the optional front bezel](#)

Removing a hot-swappable hard drive carrier

Prerequisites

CAUTION: Many repairs may only be done by a certified service technician. You should only perform troubleshooting and simple repairs as authorized in your product documentation, or as directed by the online or telephone service and support team. Damage due to servicing that is not authorized by Dell is not covered by your warranty. Read and follow the safety instructions that came with the product.

1. Ensure that you read the [Safety instructions](#).
2. If installed, remove the front bezel.
3. Using the management software, prepare the hard drive for removal. For more information, see the documentation for the storage controller.

If the hard drive is online, the green activity/fault indicator flashes when the hard drive is turned off. You can remove the hard-drive when the hard drive indicators turn off.

CAUTION: To prevent data loss, ensure that your operating system supports hot-swap drive installation. See the documentation supplied with your operating system.

Steps

1. Press the release button to open the hard drive carrier release handle.
2. Slide the hard drive carrier out of the hard drive slot.

CAUTION: To maintain proper system cooling, all empty hard-drive slots must have hard-drive blanks installed.

3. If you are not replacing the hard drive immediately, insert a hard drive blank in the empty hard drive slot.

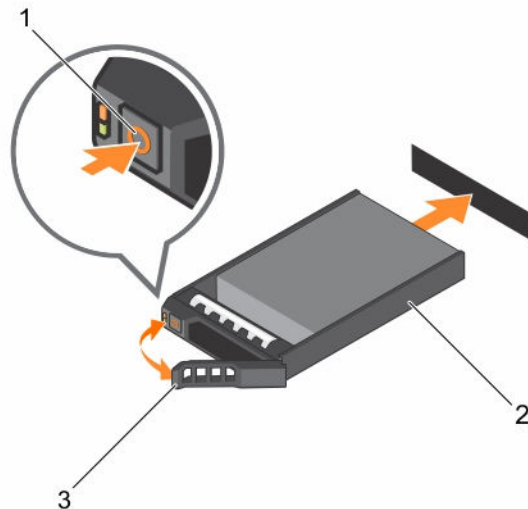

Figure 22. Removing and installing a hot-swap hard drive

1. release button

2. hard drive carrier

3. hard drive carrier handle

Next steps

1. If you are not replacing the hard drive immediately, insert a hard drive blank in the empty hard drive slot, or install a hard drive.

Related Tasks

[Removing the optional front bezel](#)

[Installing the optional front bezel](#)

Installing a hot-swappable hard drive carrier

Prerequisites

- △ **CAUTION:** Many repairs may only be done by a certified service technician. You should only perform troubleshooting and simple repairs as authorized in your product documentation, or as directed by the online or telephone service and support team. Damage due to servicing that is not authorized by Dell is not covered by your warranty. Read and follow the safety instructions that came with the product.
- △ **CAUTION:** Use only hard drives that have been tested and approved for use with the hard drive backplane.
- △ **CAUTION:** Combining SAS and SATA hard drives in the same RAID volume is not supported.
- △ **CAUTION:** When installing a hard drive, ensure that the adjacent drives are fully installed. Inserting a hard drive carrier and attempting to lock its handle next to a partially installed carrier can damage the partially installed carrier's shield spring and make it unusable.
- △ **CAUTION:** To prevent data loss, ensure that your operating system supports hot-swap drive installation. See the documentation supplied with your operating system.
- △ **CAUTION:** When a replacement hot-swappable hard drive is installed and the system is powered on, the hard drive automatically begins to rebuild. Make absolutely sure that the replacement hard drive is blank or contains data that you wish to have over-written. Any data on the replacement hard drive is immediately lost after the hard drive is installed.

Steps

1. If a hard drive blank is installed in the hard drive slot, remove it.
2. Install a hard drive in the hard drive carrier.
3. Press the release button on the front of the hard drive carrier and open the hard drive carrier handle.
4. Insert the hard drive carrier into the hard drive slot until the carrier comes in contact with the backplane.
5. Close the hard drive carrier handle to lock the hard drive in place.

Next steps

If applicable, install the front bezel.

Related Tasks

[Installing the optional front bezel](#)

Removing a hard drive from a hard drive carrier

Prerequisites

1. Keep the #2 Phillips screwdriver ready.
2. Remove the hard drive carrier from the system.

Steps

1. Remove the screws from the slide rails on the hard drive carrier.
2. Lift the hard drive out of the hard drive carrier.

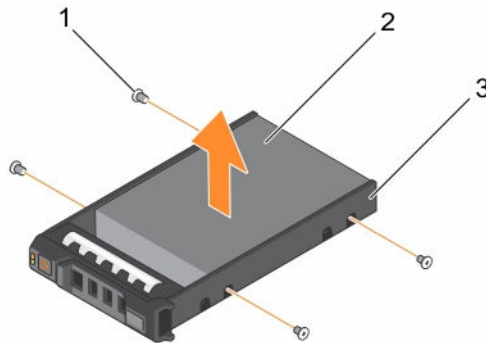

Figure 23. Removing and installing a hard drive into a hard drive carrier

- | | |
|-----------------------|---------------|
| 1. screw (4) | 2. hard drive |
| 3. hard drive carrier | |

Related Tasks

[Removing a hot-swappable hard drive carrier](#)

Installing a hard drive into a hard drive carrier

Prerequisites

⚠ CAUTION: Many repairs may only be done by a certified service technician. You should only perform troubleshooting and simple repairs as authorized in your product documentation, or as directed by the online or telephone service and support team. Damage due to servicing that is not authorized by Dell is not covered by your warranty. Read and follow the safety instructions that came with the product.

Keep the #2 Phillips screwdriver ready.

Steps

1. Insert the hard drive into the hard drive carrier with the connector end of the hard drive toward the back of the hard drive carrier.
2. Align the screw holes on the hard drive with the screw holes on the hard drive carrier.
When aligned correctly, the back of the hard drive is flush with the back of the hard drive carrier.
3. Tighten the screws to secure the hard drive to the hard drive carrier.

Optical drive (optional)

Removing the optical drive

Prerequisites



CAUTION: Many repairs may only be done by a certified service technician. You should only perform troubleshooting and simple repairs as authorized in your product documentation, or as directed by the online or telephone service and support team. Damage due to servicing that is not authorized by Dell is not covered by your warranty. Read and follow the safety instructions that came with the product.

1. Ensure that you follow the [Safety instructions](#).
2. Follow the procedure listed in [Before working inside your system](#).
3. If installed, remove the front bezel.

Steps

1. Slide the release button in the direction of the arrow to open the ejector handle.
2. Hold the ejector handle and pull the optical drive out of the system.
3. To remove the optical drive from the optical drive carrier, pull the pull tab on the cable, and disconnect the cable from the optical drive connector.
4. Flex the left side wall of the optical drive carrier to release the optical drive from the carrier.

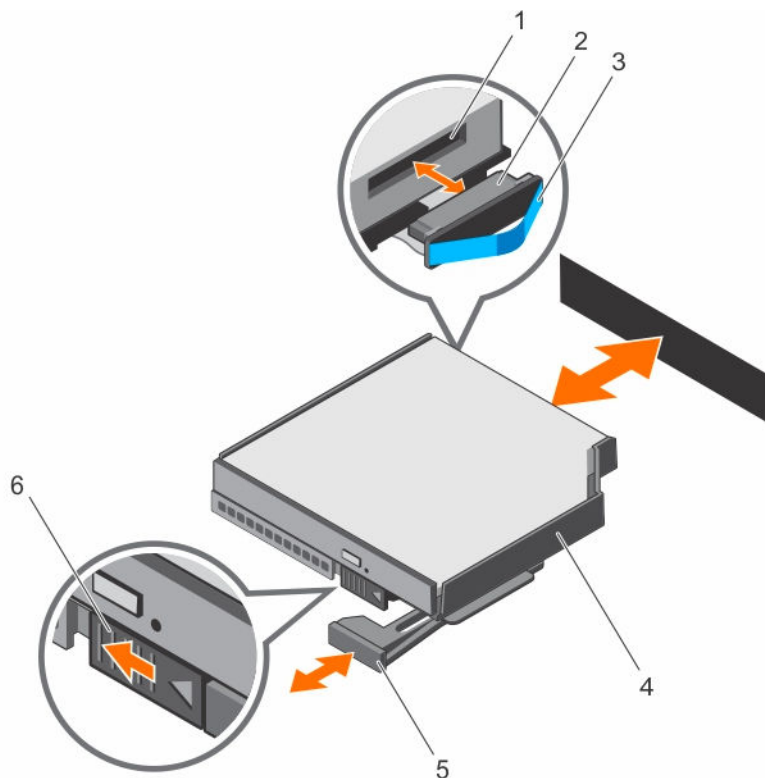

Figure 24. Removing and installing the optical drive

- | | |
|----------------------------|--------------------------|
| 1. optical drive connector | 2. cable |
| 3. pull tab | 4. optical drive carrier |
| 5. ejector handle | 6. release button |

Next steps

Install the optical drive.

Related Tasks

[Removing the optional front bezel](#)

[Installing the optical drive](#)

Installing the optical drive

Prerequisites

⚠ CAUTION: Many repairs may only be done by a certified service technician. You should only perform troubleshooting and simple repairs as authorized in your product documentation, or as directed by the online or telephone service and support team. Damage due to servicing that is not authorized by Dell is not covered by your warranty. Read and follow the safety instructions that came with the product.

1. Ensure that you follow the [Safety instructions](#).
2. Follow the artwork printed on the optical carrier to insert optical drive into the carrier.

Steps

1. Reconnect the cable to the back of the optical drive.
2. Align the optical drive with the optical drive slot in the front of the chassis.
3. Slide the optical drive into the optical drive slot until the optical drive connector engages with SATA connector on the system board.

Next steps

1. If removed, install the front bezel.
2. Follow the procedure listed in [After working inside your system](#).

Related Tasks

[Installing the optional front bezel](#)

Cooling fans

Your system supports six hot-swappable cooling fans that are mounted in a memory riser and fan cage. These fans provide cooling for the processors, expansion cards, and memory modules. Individual fans are connected to the fan tray located below the fan cage. The fan tray is connected through a single 12x2 connector to the system board.

 **NOTE:** In the event of a failure, excessive temperature, or a problem with a particular fan, the fan number is referenced by the Embedded Server Management (ESM), allowing you to easily identify and replace the particular fan by noting the fan numbers on the memory riser and fan cage.

 **WARNING:** Do not place any physical obstructions in the front or rear of the chassis. This may cause a decrease in airflow, resulting in an over-heating condition.

Removing a cooling fan

Prerequisites

 **CAUTION:** Many repairs may only be done by a certified service technician. You should only perform troubleshooting and simple repairs as authorized in your product documentation, or as directed by the online or telephone service and support team. Damage due to servicing that is not authorized by Dell is not covered by your warranty. Read and follow the safety instructions that came with the product.

 **WARNING:** Opening or removing the system cover when the system is on may expose you to a risk of electric shock. Exercise utmost care while removing or installing cooling fans.

 **WARNING:** Do not operate the system without the cooling fans or the system cover.

 **WARNING:** The cooling fans operate at a high speed. To avoid injury, do not attempt to touch the cooling fan blades while working on cooling fans.

 **CAUTION:** The cooling fans are hot-swappable. To maintain proper cooling while the system is on, replace only one fan at a time.

 **NOTE:** The procedure for removing each fan is identical.

1. Ensure that you follow the [Safety instructions](#).
2. Follow the procedure listed in [Before working inside your system](#).

Steps

Press the release tabs and lift the cooling fan out of the memory riser and fan cage.

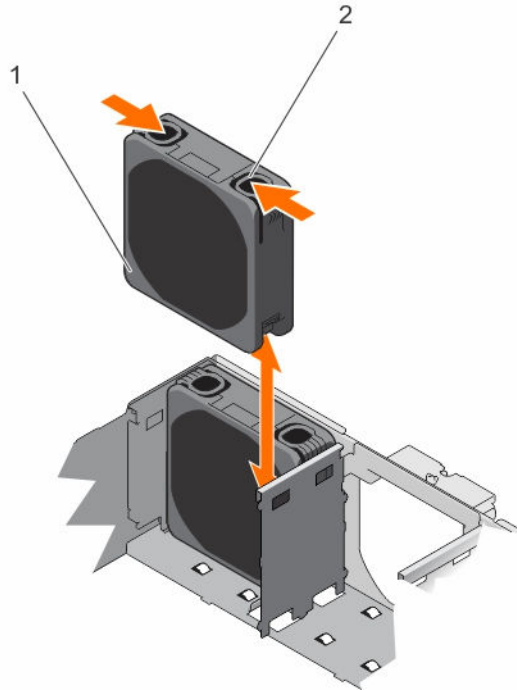

Figure 25. Removing and installing a cooling fan

1. cooling fan

2. release tab (2)

Next steps

Install the cooling fan.

Related Tasks

[Installing a cooling fan](#)

Installing a cooling fan

Prerequisites

CAUTION: Many repairs may only be done by a certified service technician. You should only perform troubleshooting and simple repairs as authorized in your product documentation, or as directed by the online or telephone service and support team. Damage due to servicing that is not authorized by Dell is not covered by your warranty. Read and follow the safety instructions that came with the product.

WARNING: The cooling fans operate at a high speed. To avoid injury, do not attempt to touch the cooling fan blades while working on cooling fans.

Ensure that you follow the [Safety instructions](#).

Steps

1. Align the connector on the cooling fan with the connector on the fan tray.
2. Holding the release tabs, insert the cooling fan into the memory riser and fan cage with the arrow pointing toward the back of the system.
3. Lower the cooling fan until connector on the cooling fan engages with the connector on the fan tray.

The release tabs click into place when the cooling fan is firmly seated.

Next steps

Follow the procedure listed in [After working inside your system](#).

Removing the fan tray

Prerequisites



CAUTION: Many repairs may only be done by a certified service technician. You should only perform troubleshooting and simple repairs as authorized in your product documentation, or as directed by the online or telephone service and support team. Damage due to servicing that is not authorized by Dell is not covered by your warranty. Read and follow the safety instructions that came with the product.

1. Ensure that you follow the [Safety instructions](#).
2. Follow the procedure listed in [Before working inside your system](#).
3. Remove the following:
 - a. Memory risers
 - b. Cooling fans
 - c. Memory riser and fan cage
 - d. Memory riser blanks, if installed

Steps

1. Loosen the captive screws in the order of the numbers printed on the fan tray.
2. Hold the fan tray by its edges and lift the fan tray out of the system.

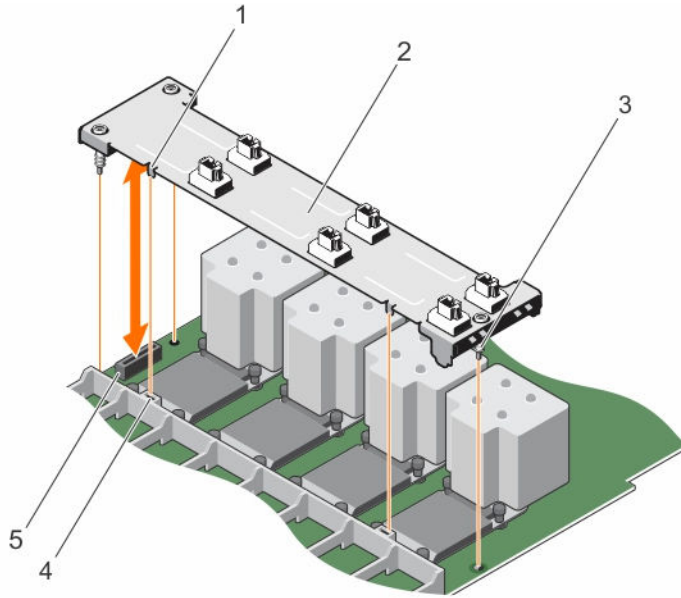

Figure 26. Removing and installing the fan tray

- | | |
|----------------------------------|-----------------------------------|
| 1. tab on the fan tray (2) | 2. fan tray |
| 3. captive screw (3) | 4. slot on the memory riser guide |
| 5. connector on the system board | |

Next steps

Install the fan tray.

Related Tasks

- [Removing a memory riser](#)
- [Removing a cooling fan](#)
- [Removing a memory riser blank](#)
- [Installing the fan tray](#)

Installing the fan tray

Prerequisites

△ CAUTION: Many repairs may only be done by a certified service technician. You should only perform troubleshooting and simple repairs as authorized in your product documentation, or as directed by the online or telephone service and support team. Damage due to servicing that is not authorized by Dell is not covered by your warranty. Read and follow the safety instructions that came with the product.

Ensure that you follow the [Safety instructions](#).

Steps

1. Align the captive screws on the fan tray with the screw holes on the system board.
2. Lower the fan tray into the system until:
 - a. The tabs on the fan tray are seated in the slots on the memory riser guide.

- b. The connector on the fan tray engages with the connector on the system board.
3. Press the fan tray at the edges to ensure that the fan tray is properly seated.
4. Tighten the captive screws in the order of the numbers printed on the fan tray.

Next steps

1. Install the following:
 - a. Memory riser and fan cage
 - b. Cooling fans
 - c. Memory risers
 - d. Memory riser blanks, if removed
2. Follow the procedure listed in [After working inside your system](#).

Related Tasks

- [Installing the memory riser and fan cage](#)
- [Installing a cooling fan](#)
- [Installing a memory riser](#)
- [Installing a memory riser blank](#)

Internal USB memory key (optional)

The USB memory key installed inside your system can be used as a boot device, security key, or mass storage device.

To boot from the USB memory key, configure the USB memory key with a boot image and then specify the USB memory key in the boot sequence in System Setup.

The internal USB connector is located on the system board.

Replacing the internal USB key

Prerequisites

 **CAUTION:** Many repairs may only be done by a certified service technician. You should only perform troubleshooting and simple repairs as authorized in your product documentation, or as directed by the online or telephone service and support team. Damage due to servicing that is not authorized by Dell is not covered by your warranty. Read and follow the safety instructions that came with the product.

1. Ensure that you follow the [Safety instructions](#).
2. Follow the procedure listed in [Before working inside your system](#)

Steps

1. Locate the USB connector/USB key on the system board.
To locate the USB connector, see [System board connectors](#).
2. If installed, remove the USB key.
3. Insert the replacement USB key into the USB connector.

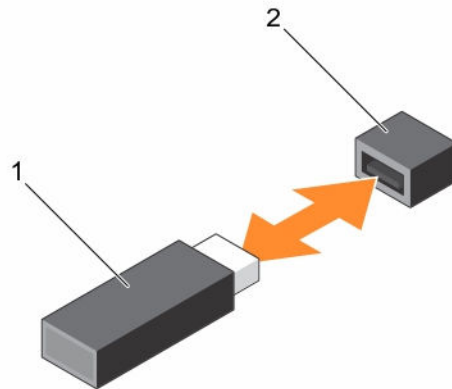

Figure 27. Replacing the internal USB key

1. USB memory key
2. USB memory key connector

Next steps

1. Follow the procedure listed in [After working inside your system](#).
2. While booting, press F2 to enter System Setup and verify that the USB key is detected by the system.

Expansion cards and expansion card risers

Your system supports third Generation 10 PCIe expansion card slots that include one dedicated slot for PERC 9 storage card and one dedicated riser-slot for Network Daughter Card (NDC).

Expansion card installation guidelines

Slot 1 connector functions as an x8 connector and can be extended as two x4 slots when the left I/O riser is installed.

Slot 9 connector functions as an x16 connector and can be extended as two x8 slots when the right I/O riser is installed.

 **NOTE:** A missing or an unsupported expansion card riser logs an SEL event. It does not prevent your system from powering on and no BIOS POST message or F1/F2 pause is displayed.





 **NOTE:** Left and right optional risers support Generation 3 expansion cards.

Table 3. Supported expansion cards

Riser	PCIe slot	Processor connection	Height	Length	Link width	Slot width
	1	Processor 1	Full Height	Half Length	x8	x24
1 (NDC riser)	2	Processor 1	Full Height	Half Length	x8	x16 - reversed
2 (optional)	1/1		Full Height	Full Length	x4	x8
 NOTE: If installed as a left I/O riser						
	2/2		Full Height	Half Length	x4	x8
	3	Processor 1	Full Height	Half Length	x8	x16
	4	Processor 2	Full Height	Half Length	x16	x16
	5	Processor 2	Full Height	Half Length	x16	x16
	6	Processor 3	Full Height	Half Length	x16	x16
	7	Processor 3	Full Height	Half Length	x16	x16
	8	Processor 4	Full Height	Half Length	x16	x16
	9	Processor 4	Full Height	Half Length	x16	x24
3 (optional)	1/9		Full Height	Full Length	x8	x16
 NOTE: If installed as a right I/O riser						
	2/10		Full Height	Half Length	x8	x16

 **NOTE:** Do not install a full-height expansion card on PCIe slot 2/10.

 **NOTE:** The expansion cards are not hot-swappable. Ensure the AC power supply unit is removed before installing the expansion cards.

The following table provides guidelines for installing expansion cards to ensure proper cooling and mechanical fit. The expansion cards with the highest priority should be installed first using the slot priority indicated. All other expansion cards should be installed in card priority and slot priority order.

Table 4. Expansion Card Installation Order

Card priority	Card type	Form factor	Slot priority (Two processors)	Slot priority (Four processors)	Max allowed
1	Internal Storage (Integrated Slot)	Full Height	4	4,7	2
2	External SAS controllers	Full Height	1, 3, 4, 5, (1/1)*, (2/2)*	1, 3, 4, 5, 6, 7, 8, 9, (2/10)^, (1/1)*	2
3	40 Gb Ethernet Controllers	Full Height	1, 3, 4, 5, (1/1)*, (2/2)*	1, 3, 4, 5, 6, 7, 8, 9, (1/9)^, (2/10)^, (1/1)*, (2/2)*	9
4	Fibre Channel 16 Gb, HBA, Single/ Dual Port (Emulex)	Full Height	1, 3, 4, 5, (1/1)*, (2/2)*	1, 3, 4, 5, 6, 7, 8, 9, (1/9)^, (2/10)^, (1/1)*, (2/2)*	10*
	Fibre Channel 16 Gb, HBA, Single/ Dual Port (QLogic)	Full Height	1, 3, 4, 5	1, 3, 4, 5, 6, 7, 8, 9	8
5	Converged Network Adapters 10 Gb, Dual Port (Intel)	Full Height	1, 3, 4, 5, (1/1)*, (2/2)*	(1/9)^, (2/10)^, 1, 3, 4, 5, 6, 7, 8, 9, (1/1)*, (2/2)*	10
	Converged Network Adapters 1 Gb, Quad Port (Broadcom)	Full Height	1, 3, 4, 5, (1/1)*, (2/2)*	(1/9)^, (2/10)^, 1, 3, 4, 5, 6, 7, 8, 9, (1/1)*, (2/2)*	10
	Converged Network Adapters 1 Gb, Dual Port (Broadcom)	Full Height	1, 3, 4, 5, (1/1)*, (2/2)*	(1/9)^, (2/10)^, 1, 3, 4, 5, 6, 7, 8, 9, (1/1)*, (2/2)*	10
	Converged Network Adapters 10 Gb, Dual Port (Broadcom)	Full Height	1, 3, 4, 5, (1/1)*, (2/2)*	(1/9)^, (2/10)^, 1, 3, 4, 5, 6, 7, 8, 9, (1/1)*, (2/2)*	10
6	10 Gb Ethernet Controllers Dual Port (Emulex)	Full Height	1, 3, 4, 5, (1/1)*, (2/2)*	1, 3, 4, 5, 6, 7, 8, 9, (1/9)^, (2/10)^, (1/1)*, (2/2)*	10*
	10 Gb Ethernet Controllers Dual Port (Mellanox)	Full Height	1, 3, 4, 5, (1/1)*, (2/2)*	1, 3, 4, 5, 6, 7, 8, 9, (1/9)^, (2/10)^, (1/1)*, (2/2)*	10
7	Fibre Channel 8 Gb Dual Port (QLogic)	Full Height	1, 3, 4, 5	1, 3, 4, 5, 6, 7, 8, 9	8

Card priority	Card type	Form factor	Slot priority (Two processors)	Slot priority (Four processors)	Max allowed
	Fibre Channel 8 Gb Dual Port (Emulex)	Full Height	(1/1)*, (2/2)*, 1, 3, 4, 5	(1/1)*, (2/2)*, (1/9)^, (2/10)^, 1, 3, 4, 5, 6, 7, 8, 9	10*
8	Fibre Channel 8 Gb Single Port (QLogic)	Full Height	1, 3, 4, 5	1, 3, 4, 5, 6, 7, 8, 9	8
	Fibre Channel 8 Gb Single Port (Emulex)	Full Height	(1/1)*, (2/2)*, 1, 3, 4, 5	(1/1)*, (2/2)*, (1/9)^, (2/10)^, 1, 3, 4, 5, 6, 7, 8, 9	10*
9	1 Gb NICs Dual Port (Intel)	Full Height	(1/1)*, (2/2)*, 1, 3, 4, 5	(1/1)*, (2/2)*, (1/9)^, (2/10)^, 1, 3, 4, 5, 6, 7, 8, 9	10
	1 Gb NICs Quad Port (Intel)	Full Height	(1/1)*, (2/2)*, 1, 3, 4, 5	(1/1)*, (2/2)*, (1/9)^, (2/10)^, 1, 3, 4, 5, 6, 7, 8, 9	10
10	External Non-RAID Controller	Full Height	1*, 3, 4, 5, (1/1)*, (2/2)*	1, 3, 4, 5, 6, 7, 8, 9, (2/10)^, (1/1)*	2



NOTE:

(*) indicates that "Slot 1" is not available if the optional left PCIe expansion riser is installed.

(^) indicates that "Slot 9" is not available if the optional right PCIe expansion riser is installed.

Removing the left expansion card riser blank

Prerequisites



CAUTION: Many repairs may only be done by a certified service technician. You should only perform troubleshooting and simple repairs as authorized in your product documentation, or as directed by the online or telephone service and support team. Damage due to servicing that is not authorized by Dell is not covered by your warranty. Read and follow the safety instructions that came with the product.

1. Ensure that you follow the [Safety instructions](#).
2. Follow the procedure listed in [Before working inside your system](#).

Steps

1. Slide the blank toward the side wall of the chassis.
2. Tilt the blank away from the chassis.
3. Press and push the release tab on the PCI retention rocker to release the retention rocker.
4. Lift the blank away from the system.

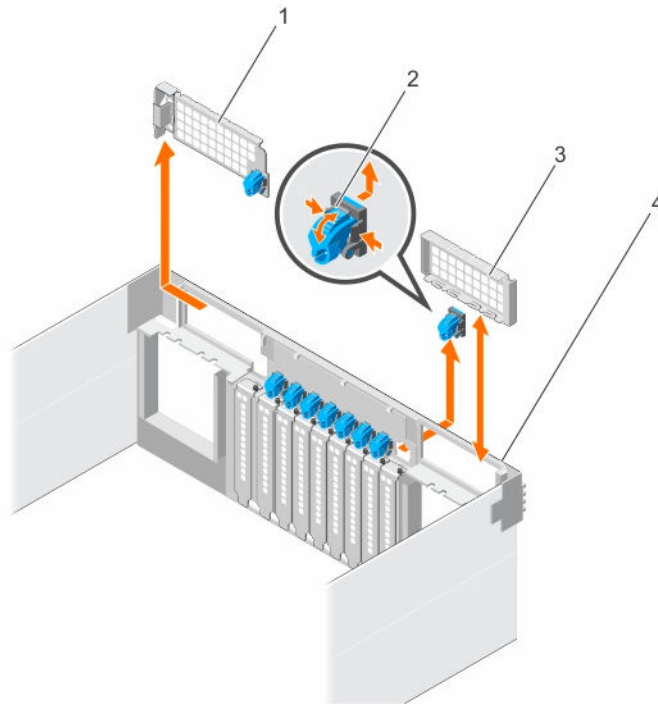

Figure 28. Removing and installing the left/right expansion card riser blank

1. left riser blank
2. release tab on the PCI retention rocker
3. right riser blank
4. chassis

Next steps

Install the left expansion card riser blank.

Related Tasks

[Installing the left expansion card riser blank](#)

Installing the left expansion card riser blank

Prerequisites

⚠ CAUTION: Many repairs may only be done by a certified service technician. You should only perform troubleshooting and simple repairs as authorized in your product documentation, or as directed by the online or telephone service and support team. Damage due to servicing that is not authorized by Dell is not covered by your warranty. Read and follow the safety instructions that came with the product.

Ensure that you follow the [Safety instructions](#).

Steps

1. Align the left riser blank with the corresponding slot on the back of the chassis.
2. Press and slide the blank to the right to lock the blank in place.

Next steps

Follow the procedure listed in [After working inside your system](#).

Removing the right expansion card riser blank

Prerequisites

 **CAUTION:** Many repairs may only be done by a certified service technician. You should only perform troubleshooting and simple repairs as authorized in your product documentation, or as directed by the online or telephone service and support team. Damage due to servicing that is not authorized by Dell is not covered by your warranty. Read and follow the safety instructions that came with the product.

1. Ensure that you follow the [Safety instructions](#).
2. Follow the procedure listed in [Before working inside your system](#).

Steps

1. Lift the riser blank away from the system.
2. Press and push the release tab on the PCI retention rocker to release the PCI retention rocker.
3. When the release tab opens, press the sides of the PCI retention rocker, and slide the PCI retention rocker assembly out of the chassis.

Next steps

Install the right expansion card riser blank.

Related Tasks

[Installing the right expansion card riser blank](#)

Installing the right expansion card riser blank

Prerequisites

Ensure that you follow the [Safety instructions](#).

Steps

1. Align the right riser blank with the corresponding slot on the back of the chassis.
2. Press the blank until it is firmly seated.
3. Replace the PCI retention rocker.

Next steps

Follow the procedure listed in [After working inside your system](#).

Removing the left expansion card riser

Prerequisites

 **CAUTION:** Many repairs may only be done by a certified service technician. You should only perform troubleshooting and simple repairs as authorized in your product documentation, or as directed by the online or telephone service and support team. Damage due to servicing that is not authorized by Dell is not covered by your warranty. Read and follow the safety instructions that came with the product.

1. Ensure that you follow the [Safety instructions](#).
2. Follow the procedure listed in [Before working inside your system](#).
3. Remove the left expansion card riser blank.

Steps

1. Holding the riser handle, pull the expansion card riser in the direction of the arrows on the handle.
2. Lift the expansion card riser away from the system.

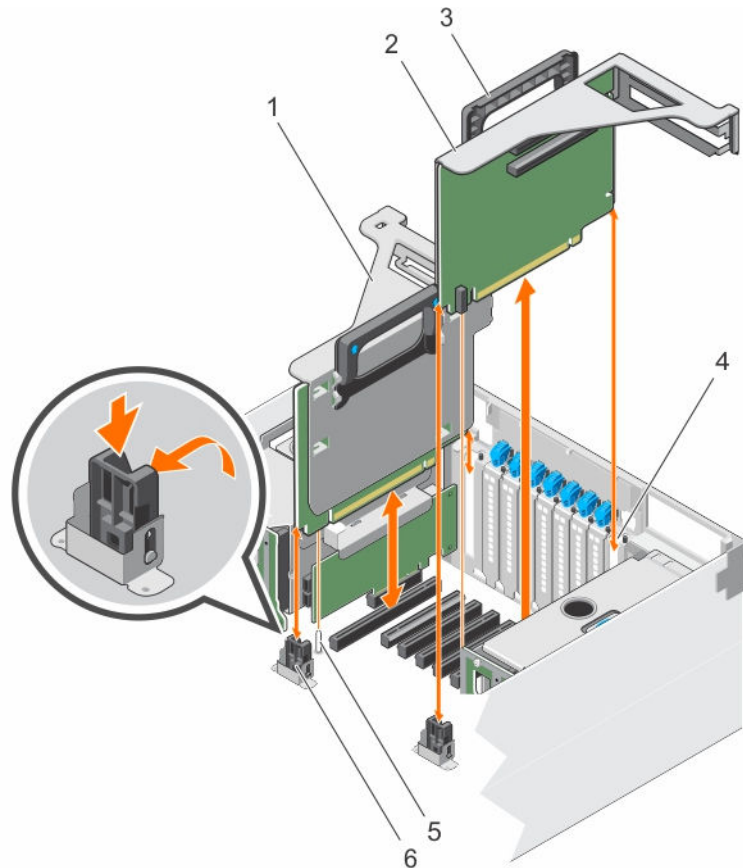

Figure 29. Removing and installing the left and right expansion card risers

- | | |
|------------------------------|-------------------------------|
| 1. left expansion card riser | 2. right expansion card riser |
| 3. riser handle | 4. riser panel |
| 5. guide pin | 6. riser guide on VR bracket |

Next steps

1. Install the expansion card into the left expansion card riser.
2. Install the left expansion card riser.

Related Tasks

- [Removing the left expansion card riser blank](#)
- [Installing an expansion card into the expansion card risers](#)
- [Installing the left expansion card riser](#)

Installing the left expansion card riser

Prerequisites

-  **CAUTION:** Many repairs may only be done by a certified service technician. You should only perform troubleshooting and simple repairs as authorized in your product documentation, or as directed by the online or telephone service and support team. Damage due to servicing that is not authorized by Dell is not covered by your warranty. Read and follow the safety instructions that came with the product.

Ensure that you follow the [Safety instructions](#).

Steps

1. Holding the expansion card riser by its sides, align the riser with the riser panel slot and the connector on the system board.
2. Insert the expansion card riser into the system.
 **NOTE:** Note that the riser edge slides into the riser guide on the system board.
3. Insert the riser edge connector into the connector on the system board until the riser is fully seated.

Next steps

Follow the procedure listed in [After working inside your system](#).

Removing the right expansion card riser

Prerequisites

-  **CAUTION:** Many repairs may only be done by a certified service technician. You should only perform troubleshooting and simple repairs as authorized in your product documentation, or as directed by the online or telephone service and support team. Damage due to servicing that is not authorized by Dell is not covered by your warranty. Read and follow the safety instructions that came with the product.

1. Ensure that you follow the [Safety instructions](#).
2. Follow the procedure listed in [Before working inside your system](#).
3. Remove the right expansion card riser blank.

Steps

1. Holding the riser handle, pull the expansion card riser in the direction of the arrows on the handle.
2. Lift the expansion card riser away from the system.

Next steps

1. Install the expansion card into the right expansion card riser.
2. Install the right expansion card riser.

Related Tasks

- [Removing the right expansion card riser blank](#)
- [Installing an expansion card into the expansion card risers](#)
- [Installing the right expansion card riser](#)

Installing the right expansion card riser

Prerequisites

-  **CAUTION:** Many repairs may only be done by a certified service technician. You should only perform troubleshooting and simple repairs as authorized in your product documentation, or as directed by the online or telephone service and support team. Damage due to servicing that is not authorized by Dell is not covered by your warranty. Read and follow the safety instructions that came with the product.

Ensure that you follow the [Safety instructions](#).

Steps

1. Holding the expansion card riser by its sides, align the riser with the riser panel slot and the connector on the system board.
2. Insert the expansion card riser into the system.
 **NOTE:** Note that the riser edge slides into the riser guide on the system board.
3. Insert the riser edge connector into the connector on the system board until the riser is fully seated.

Next steps

1. Install the right expansion card riser blank.
2. Follow the procedure listed in [After working inside your system](#).

Related Tasks

[Installing the right expansion card riser blank](#)

Removing an expansion card from expansion card risers

Prerequisites

-  **CAUTION:** Many repairs may only be done by a certified service technician. You should only perform troubleshooting and simple repairs as authorized in your product documentation, or as directed by the online or telephone service and support team. Damage due to servicing that is not authorized by Dell is not covered by your warranty. Read and follow the safety instructions that came with the product.

1. Ensure that you follow the [Safety instructions](#).
2. Follow the procedure listed in [Before working inside your system](#).
3. Remove the expansion card riser.
4. Disconnect the cables connected to the expansion card.

Steps

1. Slide the expansion card latch.
2. Remove the expansion card from the expansion card riser.
3. If you are removing the card permanently, install a metal filler bracket over the empty expansion slot, and insert the expansion card latch.

NOTE: You must install a filler bracket over an empty expansion slot to maintain Federal Communications Commission (FCC) certification of the system. The brackets also keep dust and dirt out of the system and aid in proper cooling and airflow inside the system.

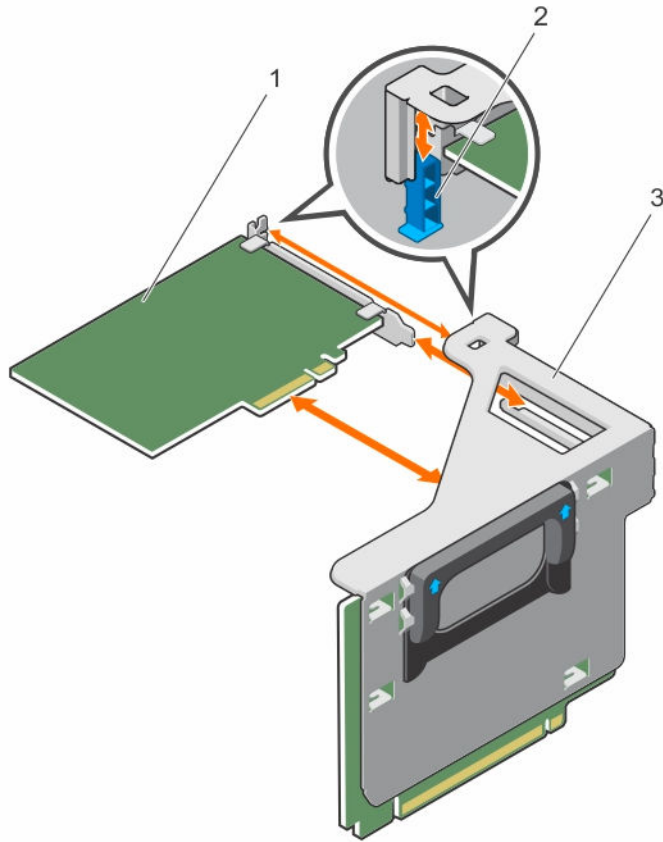

Figure 30. Removing and installing the expansion card (half-length) from the left expansion card riser

- 1. expansion card (half-length)
- 2. expansion card latch
- 3. expansion card riser

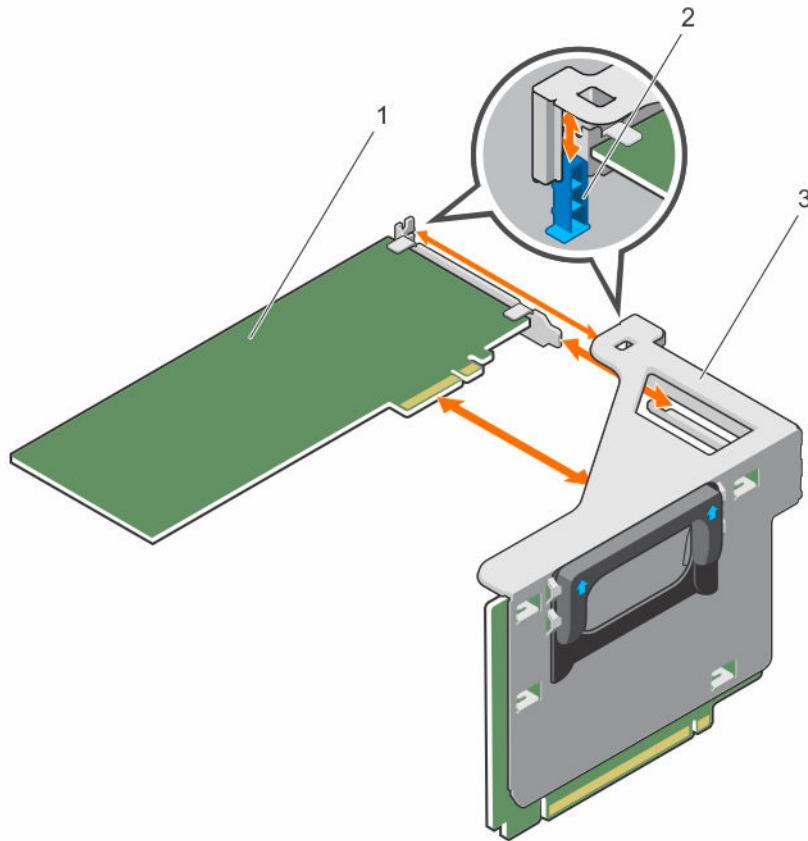

Figure 31. Removing and installing the expansion card (full-length) from the left expansion card riser

1. expansion card (full-length)
2. expansion card latch
3. expansion card riser

To enable the installation of full-length expansion card in expansion card risers, ensure the metal brackets are removed from the back of the memory cage and fan cage. See the illustration below for removing the metal brackets.

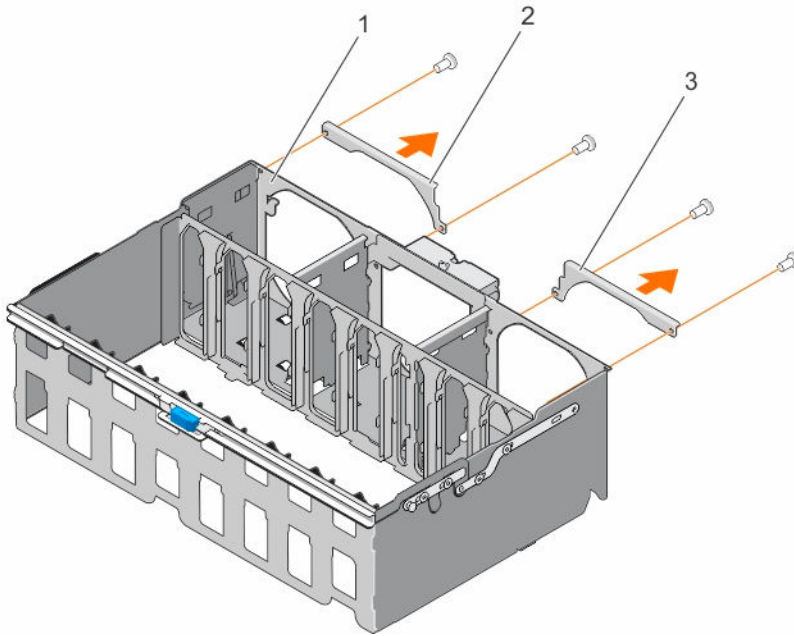

Figure 32. Removing the metal brackets to install the full-length expansion cards

- 1. memory riser and fan cage
- 2. left metal bracket
- 3. right metal bracket

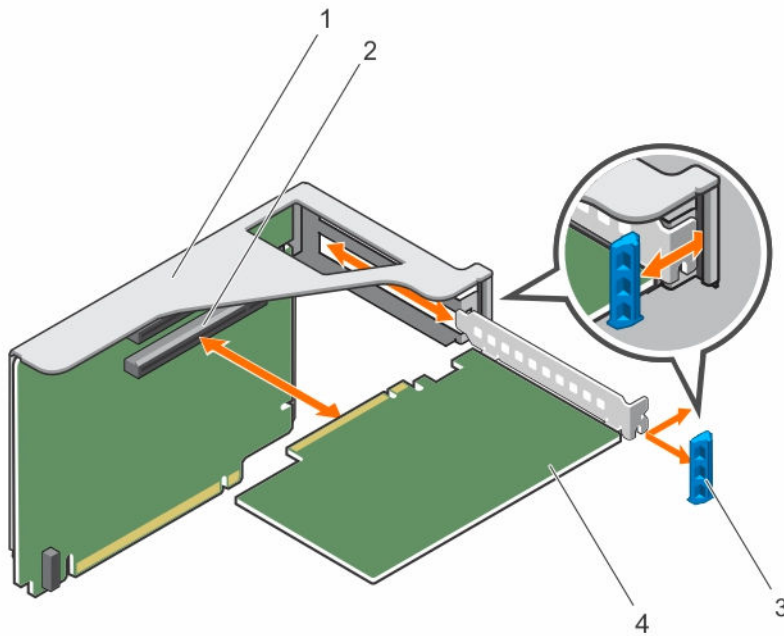

Figure 33. Removing and installing the expansion card from the right expansion card riser

- 1. expansion card riser
- 2. expansion card connector on the riser

3. expansion card latch

4. expansion card

Next steps

Install an expansion card into the expansion card riser or install the expansion card riser.

Related Tasks

[Installing an expansion card into the expansion card risers](#)

Installing an expansion card into the expansion card risers

Prerequisites

 **CAUTION:** Many repairs may only be done by a certified service technician. You should only perform troubleshooting and simple repairs as authorized in your product documentation, or as directed by the online or telephone service and support team. Damage due to servicing that is not authorized by Dell is not covered by your warranty. Read and follow the safety instructions that came with the product.

1. Ensure that you follow the [Safety instructions](#).
2. Unpack the expansion card and prepare it for installation. For instructions, see the documentation accompanying the card.

Steps

1. Slide the expansion card latch.
2. Holding the expansion card by its edges, position the card so that the card edge connector aligns with the expansion card connector on the riser.
3. Insert the card edge connector into the expansion card connector on the riser until the card is fully seated.
4. Insert the expansion card latch.

Next steps

1. Connect the cables to the expansion card.
2. Install the expansion card riser.
3. Install any device drivers required for the card as described in the documentation for the card.
4. Follow the procedure listed in [After working inside your system](#).

NDC riser

The Network Daughter Card (NDC) riser is a half-length, full-height card installed in a dedicated PCIe slot on the system board. It has an x16 PCIe connector (reverse orientation). The NDC riser is also known as I/O riser 1.

The NDC riser supports:

- A standard rNDC connector, which connects one Dell standard Network Daughter Card
- IDSDM connector
- Temperature sensor
- Chassis intrusion switch

Removing the NDC riser

Prerequisites

CAUTION: Many repairs may only be done by a certified service technician. You should only perform troubleshooting and simple repairs as authorized in your product documentation, or as directed by the online or telephone service and support team. Damage due to servicing that is not authorized by Dell is not covered by your warranty. Read and follow the safety instructions that came with the product.

1. Ensure that you follow the [Safety instructions](#).
2. Follow the procedure listed in [Before working inside your system](#).
3. Disconnect the cables connected to the Network Daughter Card (NDC) riser.
4. If installed, remove the left expansion card riser.
5. Locate the NDC riser (on PCIe slot 2).

Steps

1. Release the PCI retention rocker to unlock the NDC riser.
2. Hold the NDC riser by its edges, and pull the NDC riser till the card edge connector disengages from the connector on the system board.
3. Lift the NDC riser away from the system.

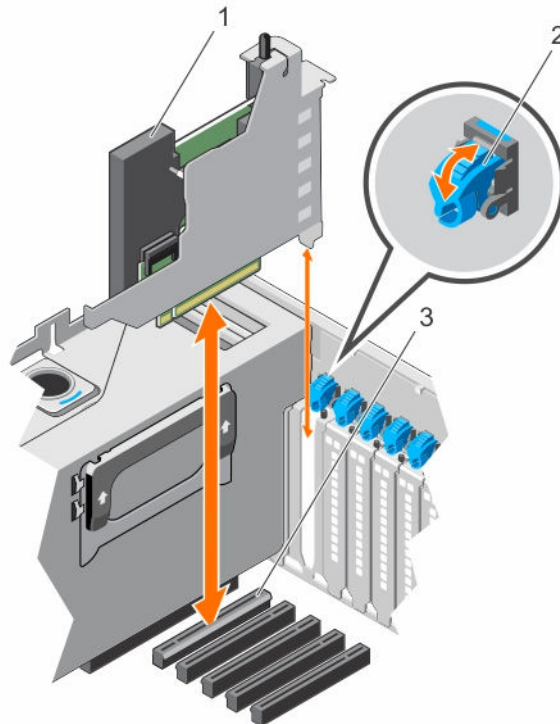

Figure 34. Removing and installing the NDC riser

1. NDC
2. PCI retention rocker
3. connector on the system board

Next steps

Install the NDC riser.

Related Tasks

[Removing the left expansion card riser](#)

[Installing the NDC riser](#)

Installing the NDC riser

Prerequisites

 **CAUTION:** Many repairs may only be done by a certified service technician. You should only perform troubleshooting and simple repairs as authorized in your product documentation, or as directed by the online or telephone service and support team. Damage due to servicing that is not authorized by Dell is not covered by your warranty. Read and follow the safety instructions that came with the product.

Ensure that you follow the [Safety instructions](#).

Steps

1. Hold the Network Daughter Card (NDC) riser by its edges and align the connector on the NDC riser with the connector on the system.

 **NOTE:** The NDC slot on the system board is keyed differently.

2. Insert the NDC riser until the card is fully seated.
3. Close the PCI retention rocker to lock the NDC riser.

Next steps

1. If removed, install the left expansion card riser.
2. Reconnect the cables to the NDC riser.
3. Follow the procedure listed in [After working inside your system](#).

Related Tasks

[Installing the left expansion card riser](#)

Network daughter card

The Network Daughter Card (NDC) contains the complete Network Interface Card (NIC) subsystem, it replaces the traditional LAN-on-Motherboard (LOM) design with the flexible new features, network types, speed and easy to upgrade from 1G to 10G LAN speeds.

NDC riser is installed on a dedicated PCIe slot 2 on the system board. It provides the following interfaces from the system board:

- PCIe x8 Gen3 link
- PCIe x2 Gen2 link
- Network Controller Sideband Interface (NC-SI)
- I-two-C (I2C)
- Power on and grounding

- Miscellaneous control signals

Removing the network daughter card

Prerequisites

⚠ CAUTION: Many repairs may only be done by a certified service technician. You should only perform troubleshooting and simple repairs as authorized in your product documentation, or as directed by the online or telephone service and support team. Damage due to servicing that is not authorized by Dell is not covered by your warranty. Read and follow the safety instructions that came with the product.

1. Ensure that you follow the [Safety instructions](#).
2. Follow the procedure listed in [Before working inside your system](#).
3. Remove the Network Daughter Card (NDC) riser.

✎ NOTE: The NDC is on riser 1.

Steps

1. Loosen the captive screws that secure NDC to the NDC riser bracket.
2. Hold the NDC by its edges, and pull until the connector on the NDC disengages from the connector on the NDC riser card.
3. Slide the NDC away from the NDC riser bracket until the Network Interface Card (NIC) connectors are clear of the slot.

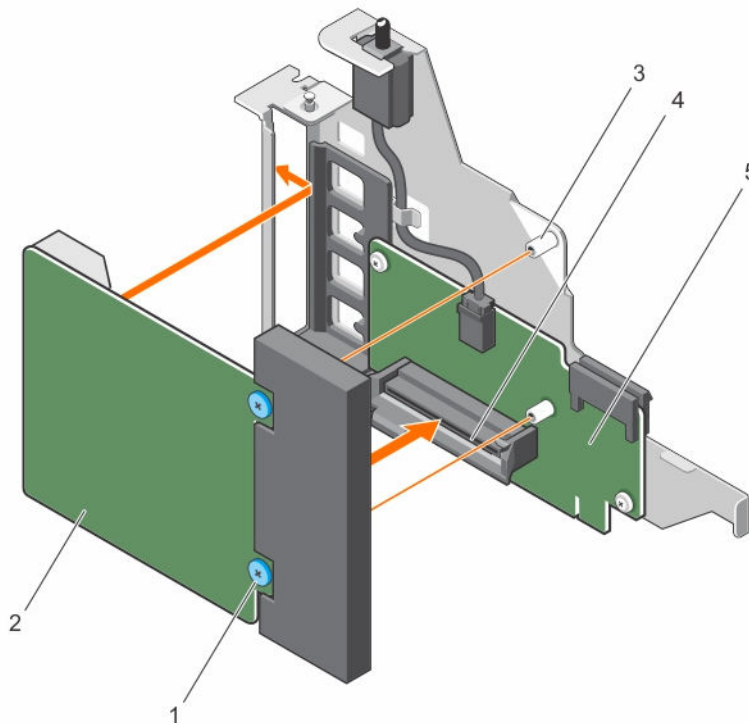

Figure 35. Removing and installing the network daughter card

1. captive screw (2)
2. NDC

3. screw hole (2)
4. connector on the NDC riser card
5. NDC riser card

Next steps

Install the network daughter card.

Related Tasks

[Removing the NDC riser](#)

[Installing the network daughter card](#)

Installing the network daughter card

Prerequisites

 **CAUTION:** Many repairs may only be done by a certified service technician. You should only perform troubleshooting and simple repairs as authorized in your product documentation, or as directed by the online or telephone service and support team. Damage due to servicing that is not authorized by Dell is not covered by your warranty. Read and follow the safety instructions that came with the product.

Ensure that you follow the [Safety instructions](#).

Steps

1. Align the following:
 - a. Network Interface Card (NIC) connectors with the slot opening on Network Daughter Card (NDC) riser bracket.
 - b. Captive screws with the screw holes on the NDC riser card.
2. Press the NDC at its edges to ensure that the connector on the NDC engages with the connector on the NDC riser card.
3. Tighten the captive screws to secure the NDC to the NDC riser card.

Next steps

1. Install the NDC riser.
2. Follow the procedure listed in [After working inside your system](#).

Related Tasks

[Installing the NDC riser](#)

SD vFlash media card

A vFlash SD card is a Secure Digital (SD) card that plugs into the vFlash SD card slot in the system. It provides persistent on-demand local storage and a custom deployment environment that allows automation of server configuration, scripts, and imaging. It emulates USB device(s). For more information, see the iDRAC8 User's Guide at Dell.com/esmmanuals.

Replacing an SD vFlash media card

1. Locate the SD vFlash media slot at the back of the chassis.
2. To remove the SD vFlash media card, push the card inward to release it, and pull the card from the card slot.

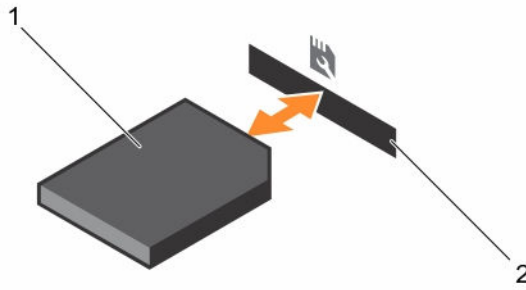



Figure 36. Removing and installing the SD vFlash media card

1. SD vFlash media card
2. SD vFlash media-card slot
3. To install an SD vFlash media card, insert the contact-pin end of the SD vFlash media card into the card slot on the module.
 **NOTE:** The slot is keyed to ensure correct insertion of the card.
4. Press the card inward to lock it into the slot.

Internal dual SD module

The Internal Dual SD Module (IDSDM) card provides two SD card slots. This card offers the following features:

- Dual card operation — maintains a mirrored configuration using SD cards in both slots and provides redundancy.
 **NOTE:** When the **Redundancy** option is set to **Mirror Mode** in the **Integrated Devices** screen of System Setup, the information is replicated from one SD card to another.
- Single card operation — single card operation is supported, but without redundancy.

Removing an internal SD card

Prerequisites

 **CAUTION:** Many repairs may only be done by a certified service technician. You should only perform troubleshooting and simple repairs as authorized in your product documentation, or as directed by the online or telephone service and support team. Damage due to servicing that is not authorized by Dell is not covered by your warranty. Read and follow the safety instructions that came with the product.

1. Ensure that you follow the [Safety instructions](#).
2. Follow the procedure listed in [Before working inside your system](#).

Steps

1. Locate the SD card slot(s) on the Internal Dual SD Module (IDSDM).
2. Press the SD card to release it from the slot, and remove the card.

Next steps

Install the internal SD card.

Related Tasks

[Installing an internal SD card](#)

Installing an internal SD card

Prerequisites

 **CAUTION:** Many repairs may only be done by a certified service technician. You should only perform troubleshooting and simple repairs as authorized in your product documentation, or as directed by the online or telephone service and support team. Damage due to servicing that is not authorized by Dell is not covered by your warranty. Read and follow the safety instructions that came with the product.

 **NOTE:** To use an SD card with your system, ensure that **Internal SD Card Port** is enabled in **System Setup**.

Ensure that you follow the [Safety instructions](#).

Steps

1. Locate the SD card slot(s) on the Internal Dual SD Module (IDSDM).
 **NOTE:** The slot is keyed to ensure correct insertion of the SD card.
2. Align the SD card appropriately and insert the contact-pin end of the card into the SD card slot.
3. Press the SD card into the card slot to lock it into place.
4. Repeat steps 1 and 2 to insert the second SD card on the other side of IDSDM.

Next steps

Follow the procedure listed in [After working inside your system](#).

Removing the internal dual SD module

Prerequisites



CAUTION: Many repairs may only be done by a certified service technician. You should only perform troubleshooting and simple repairs as authorized in your product documentation, or as directed by the online or telephone service and support team. Damage due to servicing that is not authorized by Dell is not covered by your warranty. Read and follow the safety instructions that came with the product.

1. Ensure that you follow the [Safety instructions](#).
2. Follow the procedure listed in [Before working inside your system](#).

Steps

1. Locate the Internal Dual SD Module (IDSDM) on the Network Daughter Card (NDC) riser card.
2. If installed, remove the internal SD card(s).
3. Hold the pull tab, and pull IDSDM out of the NDC riser card.

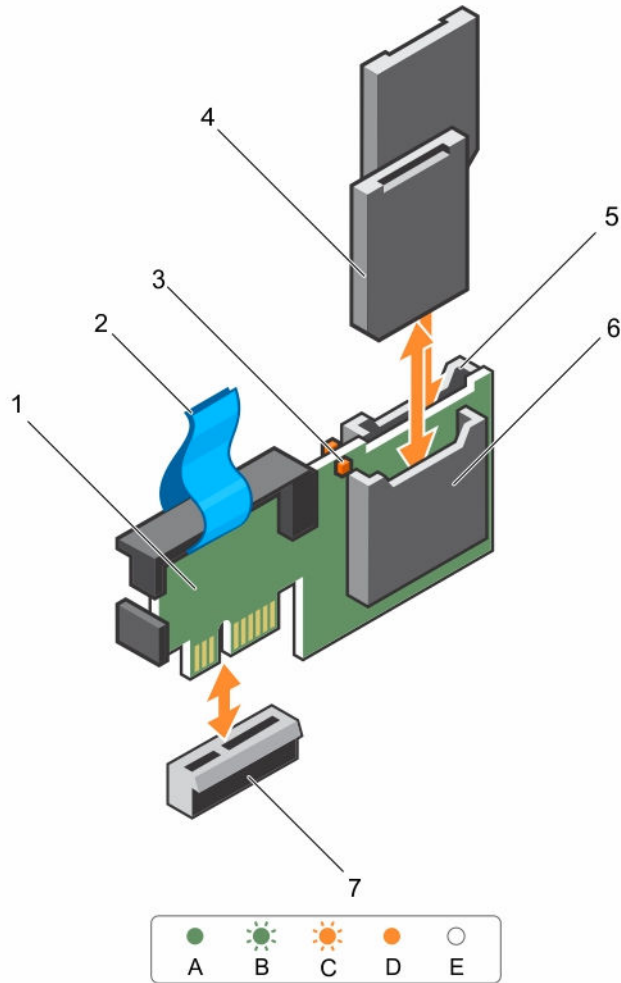

Figure 37. Removing and installing the Internal Dual SD Module (IDSDM)

- | | |
|-----------------------------|-------------------|
| 1. Internal Dual SD module | 2. pull tab |
| 3. LED status indicator (2) | 4. SD card (2) |
| 5. SD card slot 2 | 6. SD card slot 1 |
| 7. IDSDM connector | |

The following table describes the IDSDM indicator codes.

Convention	IDSDM indicator code	Description
A	Green	Indicates that the card is online
B	Flashing green	Indicates rebuild or activity
C	Flashing amber	Indicates card mismatch or that the card has failed

Convention	IDSDM indicator code	Description
D	Amber	Indicates that the card is offline, has failed, or is write protected
E	Not lit	Indicates that the card is missing or is booting

Next steps

Install the internal dual SD module.

Related Tasks

- [Removing an internal SD card](#)
- [Installing the internal dual SD module](#)

Installing the internal dual SD module

Prerequisites

 **CAUTION:** Many repairs may only be done by a certified service technician. You should only perform troubleshooting and simple repairs as authorized in your product documentation, or as directed by the online or telephone service and support team. Damage due to servicing that is not authorized by Dell is not covered by your warranty. Read and follow the safety instructions that came with the product.

Ensure that you follow the [Safety instructions](#).

Steps

1. Align the connector on the NDC riser card with the IDSDM connector.
2. Push IDSDM until it is firmly seated on the NDC riser card.

Next steps

1. If removed, install the internal SD cards.
2. Follow the procedure listed in [After working inside your system](#).

Related Tasks

- [Installing an internal SD card](#)

Integrated storage controller card

Your system supports both single and dual storage controller card options. Your system includes a dedicated expansion card slot on the system board for the primary integrated SAS or PERC controller card. The Integrated storage controller card provides the integrated storage subsystem for your system's internal hard drives. Install the secondary storage card must be installed in slot 8. The controller supports SAS and SATA hard drives, and also enables you to set up the hard drives in RAID configurations as supported by the version of the storage controller included with your system.

Removing the integrated storage controller card

Prerequisites

CAUTION: Many repairs may only be done by a certified service technician. You should only perform troubleshooting and simple repairs as authorized in your product documentation, or as directed by the online or telephone service and support team. Damage due to servicing that is not authorized by Dell is not covered by your warranty. Read and follow the safety instructions that came with the product.

NOTE: If applicable, remove the other PCIe cards prior to removing the storage controller card.

1. Ensure that you follow the [Safety instructions](#).
2. Follow the procedure listed in [Before working inside your system](#).
3. If installed, remove the left expansion card riser.
4. Remove the Network Daughter Card (NDC) riser.

NOTE: The storage controller card is located next to the power supply bay, under the clamp.

Steps

1. Press and open the clamp.
2. Hold the storage controller card by its edges and lift to remove it from the connector on the system board.
3. To disconnect the SAS cables connected to the card:
 - a. Press down and hold the tab on the SAS cable connector.
 - b. Pull the SAS cable out of the connector.

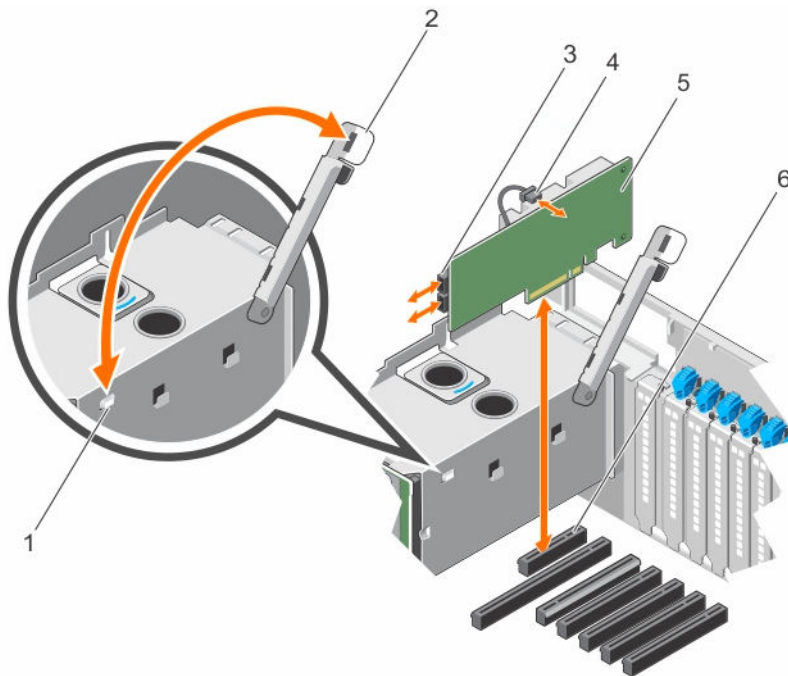

1. clamp slot on the power supply bay
2. clamp
3. SAS connector
4. storage controller card battery
5. storage controller card
6. storage controller card connector on the system board

Next steps



Install the integrated storage controller card.

Related Tasks

- [Removing the left expansion card riser](#)
- [Removing the NDC riser](#)
- [Installing the integrated storage controller card](#)

Installing the integrated storage controller card

Prerequisites

-  **CAUTION:** Many repairs may only be done by a certified service technician. You should only perform troubleshooting and simple repairs as authorized in your product documentation, or as directed by the online or telephone service and support team. Damage due to servicing that is not authorized by Dell is not covered by your warranty. Read and follow the safety instructions that came with the product.
-  **CAUTION:** Ensure that the storage controller card is installed carefully, so that the components on the card are not damaged.

Ensure that you follow the [Safety instructions](#).

Steps

1. Reconnect the SAS data cables to the card.
 -  **NOTE:** Ensure that you connect the cable according to the connector labels on the cable. The cable does not function properly if reversed.
2. Hold the card by its edges, and align the card edge connector with the connector on the system board.
3. Lower the card into the system until the card is firmly seated.
4. Route the SAS data cable through the channel on the inner side of the chassis.
5. Connect the SAS cables from the storage controller card to the connectors on hard drive backplane or SAS expander card based on the hard drive configuration selected. For more information about cabling images, see [Removing the hard drive backplane](#).
6. Close the clamp.

Next steps

1. Install the NDC riser.
2. If removed, install the left expansion card riser.
3. Follow the procedure listed in [After working inside your system](#).

Related Tasks

- [Installing the NDC riser](#)
- [Installing the left expansion card riser](#)

Processors and heat sinks

 **NOTE:** This is a Field Replaceable Unit (FRU). Removal and installation procedures should be performed only by Dell certified service technicians.

Use the following procedure when:

- Installing an additional processor
- Replacing a processor

Your system supports two types of processor configurations:

- Four-processor configuration
- Two-processor configuration

 **NOTE:** To ensure proper system cooling, you must install a processor and a heat sink blank in any empty processor socket.

Removing a heat sink

Prerequisites

 **CAUTION:** Many repairs may only be done by a certified service technician. You should only perform troubleshooting and simple repairs as authorized in your product documentation, or as directed by the online or telephone service and support team. Damage due to servicing that is not authorized by Dell is not covered by your warranty. Read and follow the safety instructions that came with the product.

 **NOTE:** This is a Field Replaceable Unit (FRU). Removal and installation procedures should be performed only by Dell certified service technicians.

 **CAUTION:** Never remove the heat sink from a processor unless you intend to remove the processor. The heat sink is necessary to maintain proper thermal conditions.

 **NOTE:** To ensure proper system cooling, you must install a processor blank and heat sink blank in any empty processor socket.

1. Ensure that you follow the [Safety instructions](#).
2. Follow the procedure listed in [Before working inside your system](#).
3. Keep the Phillips #2 screwdriver ready.
4. Remove the following:
 - a. Cooling fans
 - b. Memory risers
 - c. Memory riser and fan cage
 - d. Cable management tray
 - e. Fan tray

 **WARNING:** The heat sink will be hot to touch for some time after the system has been powered down. Allow the heat sink to cool before removing it.

Steps

1. Loosen one of the screws that secure the heat sink to the system board.
Wait 30 seconds for the heat sink to loosen from the processor.
2. Remove the screw diagonally opposite the screw you first removed.
3. Repeat the procedure for the remaining two screws.

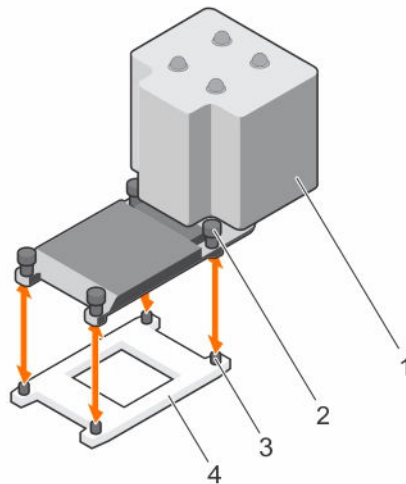

Figure 38. Removing and installing a heat sink

- | | |
|--------------------------|-------------------------|
| 1. heat sink | 2. retention screws (4) |
| 3. retention sockets (4) | 4. processor |

Next steps

Remove a processor or a heat sink.

Related Tasks

- [Removing a cooling fan](#)
- [Removing a memory riser](#)
- [Removing the memory riser and fan cage](#)
- [Removing the cable management tray](#)
- [Removing the fan tray](#)
- [Installing a processor](#)
- [Installing a heat sink](#)

Removing a processor

Prerequisites

⚠ CAUTION: Many repairs may only be done by a certified service technician. You should only perform troubleshooting and simple repairs as authorized in your product documentation, or as directed by the online or telephone service and support team. Damage due to servicing that is not authorized by Dell is not covered by your warranty. Read and follow the safety instructions that came with the product.

🔧 NOTE: This is a Field Replaceable Unit (FRU). Removal and installation procedures should be performed only by Dell certified service technicians.

 **NOTE:** To ensure proper system cooling, you must install a processor blank and heat sink blank in any empty processor socket.



1. Ensure that you follow the [Safety instructions](#).
2. Follow the procedure listed in [Before working inside your system](#).
3. Keep the Phillips #2 screwdriver ready.
4. If you are upgrading your system (from a dual processor system to a quad processor system or a processor with a higher processor bin), download the latest system BIOS version from **Dell.com/support** and follow the instructions included in the compressed download file to install the update on your system.

 **NOTE:** You can update the system BIOS by using Lifecycle Controller.

 **WARNING:** The processor will be hot to touch for some time after the system has been powered down. Allow the processor to cool before removing it.

 **CAUTION:** The processor is held in its socket under strong pressure. Be aware that the release lever can spring up suddenly if not firmly grasped.

Steps

1. Release the *open first* socket release lever near the unlock icon  by pushing the lever down and out from under the tab.
2. Release the *close first* socket release lever near the lock icon  by pushing the lever down and out from under the tab. Lift the lever 90 degrees upward.
3. Lower the *open first* socket release lever to lift the processor shield.
4. Hold the tab on the processor shield and lift the processor shield until the *open first* socket release lever lifts up.

 **CAUTION:** The socket pins are fragile and can be permanently damaged. Be careful not to bend the pins in the socket when removing the processor out of the socket.

5. Lift the processor out of the socket and leave the *open first* socket release lever up.

 **NOTE:** If you are permanently removing the processor, you must install a socket protective cap in the empty socket to protect the socket pins and keep the socket free of dust.

 **NOTE:** After removing the processor, place it in an anti-static container for reuse, return, or temporary storage. Do not touch the bottom of the processor. Touch only the side edges of the processor.

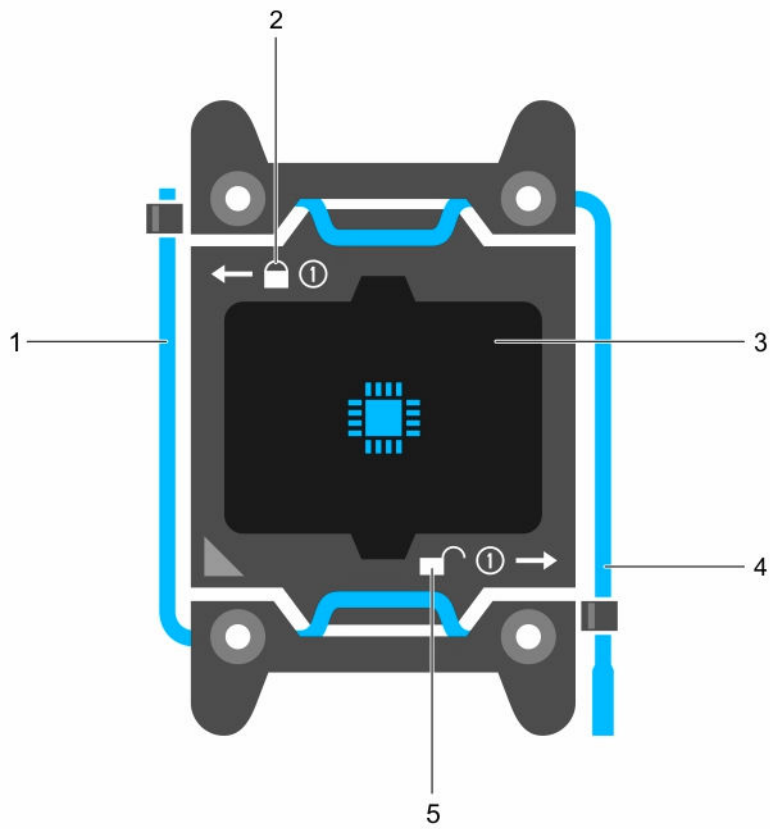

Figure 39. Processor shield

- | | |
|--|---|
| 1. <i>close first</i> socket release lever | 2. lock icon |
| 3. processor | 4. <i>open first</i> socket release lever |
| 5. unlock icon | |

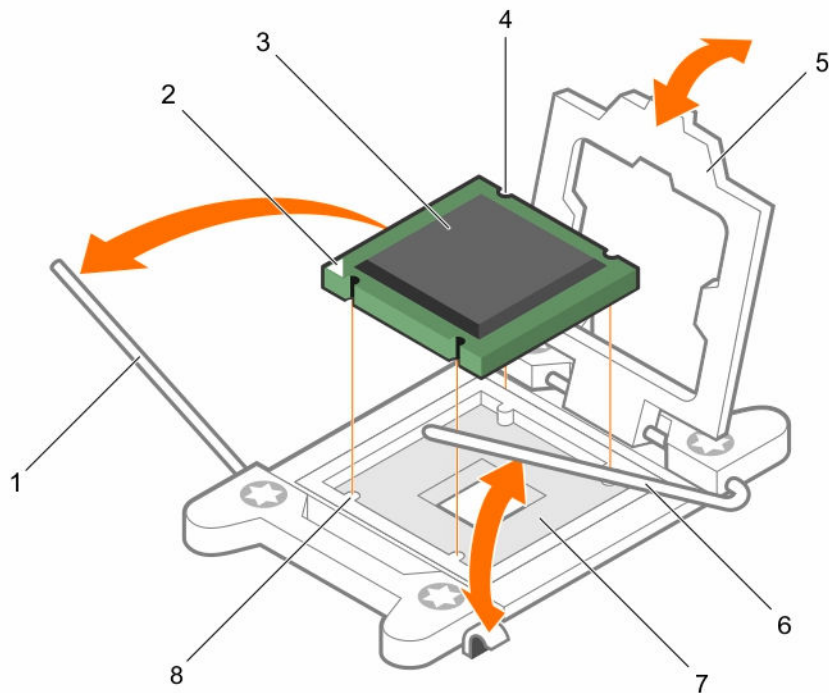

Figure 40. Removing and installing a processor

- | | |
|--|---|
| 1. close <i>first</i> socket release lever | 2. pin-1 indicator of processor |
| 3. processor | 4. slot (4) |
| 5. processor shield | 6. <i>open first</i> socket release lever |
| 7. socket | 8. socket keys (4) |

Next steps

Install the processor.

Related Tasks

[Installing a processor](#)

Installing a processor

Prerequisites



CAUTION: Many repairs may only be done by a certified service technician. You should only perform troubleshooting and simple repairs as authorized in your product documentation, or as directed by the online or telephone service and support team. Damage due to servicing that is not authorized by Dell is not covered by your warranty. Read and follow the safety instructions that came with the product.

 **NOTE:** This is a Field Replaceable Unit (FRU). Removal and installation procedures should be performed only by Dell certified service technicians.

1. Ensure that you follow the [Safety instructions](#).
2. Keep the Phillips #2 screwdriver ready.
3. If you are upgrading your system (from a dual processor system to a quad processor system or a processor with a higher processor bin) download the latest system BIOS version from **Dell.com/support** and follow the instructions included in the compressed download file to install the update on your system.

 **NOTE:** You can update the system BIOS by using Lifecycle Controller.

Steps



1. Unpack the new processor.
2. Locate the processor socket.
3. If applicable, remove the socket protective cap.
4. Release the *open first* socket release lever near the unlock icon  by pushing the lever down and out from under the tab.
5. Release the *close first* socket release lever near the lock icon  by pushing the lever down and out from under the tab. Lift the lever 90 degrees upward.
6. Hold the tab near the lock symbol on the processor shield and lift it up and out of the way.

 **CAUTION: Positioning the processor incorrectly can permanently damage the system board or the processor. Be careful not to bend the pins in the socket.**

 **CAUTION: While removing or reinstalling the processor, wipe your hands of any contaminants. Contaminants on the processor pins such as thermal grease or oil can damage the processor.**

7. Align the processor with the socket keys.

 **CAUTION: Do not use force to seat the processor. When the processor is positioned correctly, it engages easily into the socket.**

8. Align the pin-1 indicator of the processor with the triangle on the socket.
9. Place the processor on the socket such that the slots on the processor align with the socket keys.
10. Close the processor shield.
11. Lower the *close first* socket release lever near the lock icon  and push it under the tab to lock it.
12. Lower the *open first* socket release lever near the unlock icon  and push it under the tab to lock it.

Next steps

Install the heat sink.

 **NOTE:** Ensure that you install the heat sink after you install the processor. The heat sink is necessary to maintain proper thermal conditions.

Related Tasks

[Installing a heat sink](#)

Installing a heat sink

Prerequisites

 **CAUTION:** Many repairs may only be done by a certified service technician. You should only perform troubleshooting and simple repairs as authorized in your product documentation, or as directed by the online or telephone service and support team. Damage due to servicing that is not authorized by Dell is not covered by your warranty. Read and follow the safety instructions that came with the product.

 **NOTE:** This is a Field Replaceable Unit (FRU). Removal and installation procedures should be performed only by Dell certified service technicians.

1. Ensure that you follow the [Safety instructions](#).
2. Keep the Phillips #2 screwdriver ready.
3. Install the processor.

Steps

1. If you are using an existing heat sink, remove the thermal grease from the heat sink by using a clean lint-free cloth.
2. Use the thermal grease syringe included with your processor kit to apply the grease in a thin spiral on the top of the processor as shown in the following figure.

 **CAUTION:** Applying too much thermal grease can result in excess grease coming in contact with and contaminating the processor socket.

 **NOTE:** The thermal grease syringe is intended for one-time use only. Dispose of the syringe after you use it.

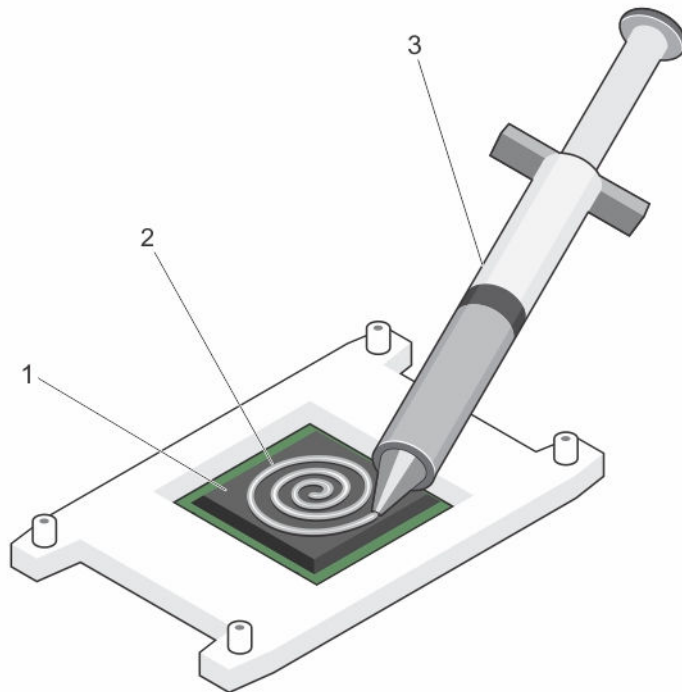

Figure 41. Applying thermal grease on the top of the processor

1. processor
 2. thermal grease
 3. thermal grease syringe
3. Place the heat sink onto the processor.
 4. Tighten one of the four screws to secure the heat sink to the system board.
 5. Tighten the screw diagonally opposite to the first screw you tightened.
- NOTE:** Do not over-tighten the heat sink retention screws when installing the heat sink. To prevent over-tightening, tighten the retention screw until resistance is felt, and stop once the screw is seated. The screw tension should be no more than 6 in-lb (6.9 cm-kg).
6. Repeat the procedure for the remaining two screws.

Next steps

1. Install the following:
 - a. Fan tray
 - b. Cable management tray
 - c. Memory riser and fan cage
 - d. Memory riser
 - e. Cooling fans
2. Follow the procedure listed in [After working inside your system](#).
3. While booting, press F2 to enter System Setup and check that the processor information matches the new system configuration.
4. Run system diagnostics to verify that the new processor operates correctly.

Related Tasks

- [Installing a processor](#)
- [Installing the fan tray](#)
- [Installing the cable management tray](#)
- [Installing the memory riser and fan cage](#)
- [Installing a memory riser](#)
- [Installing a cooling fan](#)

Removing a processor blank and heat sink blank

Prerequisites



CAUTION: Many repairs may only be done by a certified service technician. You should only perform troubleshooting and simple repairs as authorized in your product documentation, or as directed by the online or telephone service and support team. Damage due to servicing that is not authorized by Dell is not covered by your warranty. Read and follow the safety instructions that came with the product.

1. Ensure that you follow the [Safety instructions](#).
2. Follow the procedure listed in [Before working inside your system](#).
3. Remove the following:
 - a. Memory risers
 - b. Cooling fans
 - c. Memory riser and fan cage
 - d. Cable management tray
 - e. Fan tray

Steps

1. Press the release tab located at the back of the processor blank and heat sink blank.
2. Lift the processor blank and heat sink blank out of the system.

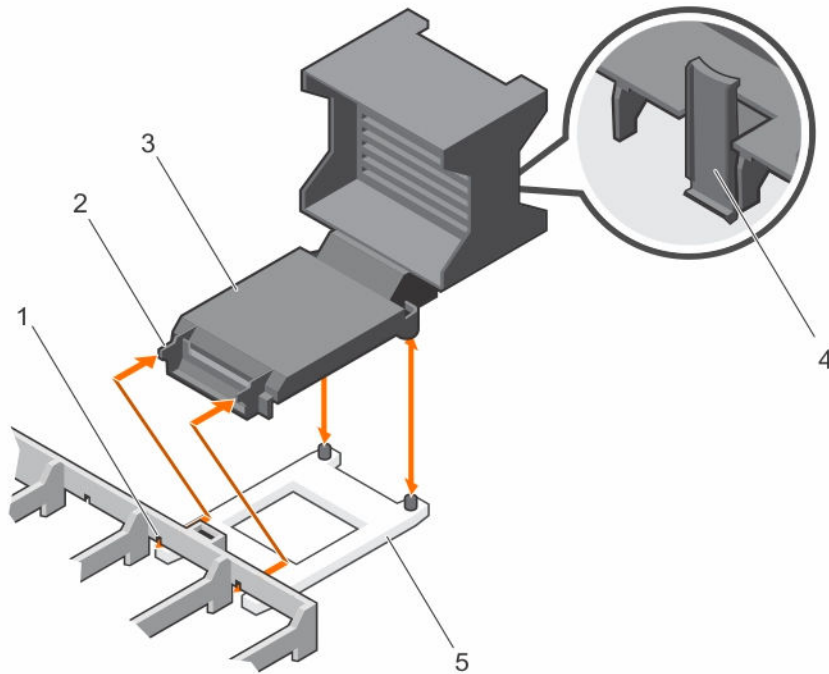

Figure 42. Removing and installing the processor blank and heat sink blank

- | | |
|--|----------------|
| 1. slot (2) | 2. tab (2) |
| 3. processor blank and heat sink blank | 4. release tab |
| 5. processor socket | |

Next steps

Install the heat sink or processor blank and heat sink blank.

Related Tasks

- [Removing a memory riser](#)
- [Removing a cooling fan](#)
- [Removing the memory riser and fan cage](#)
- [Removing the cable management tray](#)
- [Removing the fan tray](#)
- [Installing a processor blank and heat sink blank](#)

Installing a processor blank and heat sink blank

Prerequisites

⚠ CAUTION: Many repairs may only be done by a certified service technician. You should only perform troubleshooting and simple repairs as authorized in your product documentation, or as directed by the online or telephone service and support team. Damage due to servicing that is not authorized by Dell is not covered by your warranty. Read and follow the safety instructions that came with the product.

Ensure that you follow the [Safety instructions](#).

Steps

1. Align the tabs on the processor blank and heat sink blank with the slots on the memory riser guide.
2. Orient the processor blank and heat sink blank such that the tabs on the processor blank and heat sink blank engage with the slots on the memory riser guide.
3. Lower the processor blank and heat sink blank into the system until the release tab clicks into place.

Next steps





1. Install the following:
 - a. Fan tray
 - b. Cable management tray
 - c. Memory riser and fan cage
 - d. Cooling fans
 - e. Memory risers
2. Follow the procedure listed in [After working inside your system](#).

Related Tasks

- [Installing the fan tray](#)
- [Installing the cable management tray](#)
- [Installing the memory riser and fan cage](#)
- [Installing a cooling fan](#)
- [Installing a memory riser](#)

Power supply units

Your system supports up to four 750 W or four 1100 W AC power supply units (PSUs) that are connected to the system power distribution boards.

-  **NOTE:** When two identical PSUs are installed, the PSU configuration can be set to redundant (1 + 1) mode. In redundant mode, power is supplied to the system equally from both PSUs to maximize efficiency.
-  **NOTE:** When only one PSU is installed, the PSU configuration is non-redundant (1 + 0). Power is supplied to the system only by the single PSU.
-  **NOTE:** When four identical PSUs are installed, the PSU configuration can be set to redundant (2+2 or 3+1) mode. In redundant mode, power is supplied to the system equally from all PSUs to maximize efficiency.
-  **NOTE:** If two PSUs are used, they must be of the same type and have the same maximum output power.
-  **NOTE:** For AC PSUs, use only PSU with the Extended Power Performance (EPP) label on the back. Mixing PSUs from previous generations of servers can result in a PSU mismatch condition or failure to power on.

Hot spare feature

Your system supports the Hot Spare feature that significantly reduces the power overhead associated with power supply redundancy.

When the Hot Spare feature is enabled, a redundant power supply is switched to a sleep state. The active power supply supports 100% of the load, thus operating at higher efficiency. The redundant power supply in the sleep state monitors output voltage of the active power supply. If the output voltage of the active power supply drops, the redundant power supply in the sleep state returns to an active output state.

The active power supply can also activate a sleeping power supply if having both power supplies active is more efficient than having the redundant power supply in a sleep state. The power supply defaults are to wake both power supplies if the load on the active power supply is greater than 50% and to sleep the redundant power supply if the load falls below 20%.

You can configure the Hot Spare feature using the iDRAC settings. For more information on iDRAC settings, see the iDRAC8 User's Guide at Dell.com/esmmanuals.

Removing an AC power supply unit

Prerequisites

 **CAUTION:** Many repairs may only be done by a certified service technician. You should only perform troubleshooting and simple repairs as authorized in your product documentation, or as directed by the online or telephone service and support team. Damage due to servicing that is not authorized by Dell is not covered by your warranty. Read and follow the safety instructions that came with the product.

 **CAUTION:** The system requires one power supply unit (PSU) for normal operation. On power-redundant systems, remove and install only one PSU at a time in a system that is powered on.

 **NOTE:** You may have to unlatch and open the optional cable management arm if it interferes with power-supply removal. For information about the cable management arm, see the system's rack documentation.

1. Ensure that you follow the [Safety instructions](#).

Steps

1. Disconnect the power cable from the power source and from the PSU you intend to remove.
2. Remove the cables from the strap on the PSU.
3. Press the release latch.
4. Holding the PSU handle, pull the PSU out of the PSU slot bay to release the PSU from the Power Distribution Board (PDB).

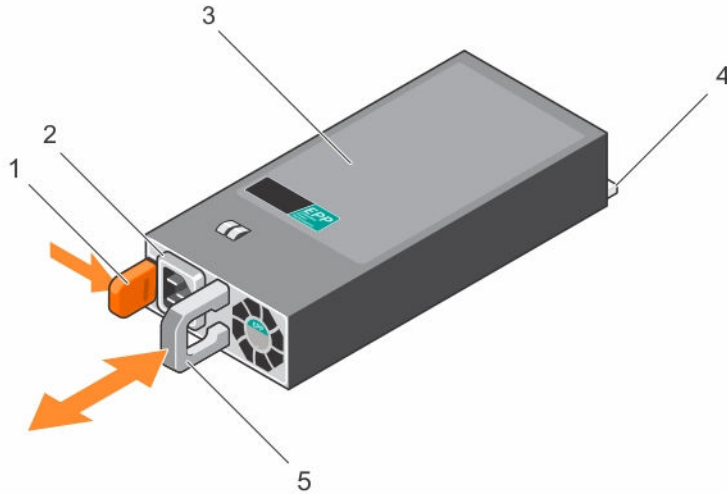

Figure 43. Removing and installing an AC power supply unit

- | | |
|------------------|------------------------------|
| 1. release latch | 2. PSU power cable connector |
| 3. PSU | 4. PSU connector |
| 5. PSU handle | |

Next steps

Install an AC power supply unit.

Related Tasks

[Installing an AC power supply unit](#)

Installing an AC power supply unit

Prerequisites

⚠ CAUTION: Many repairs may only be done by a certified service technician. You should only perform troubleshooting and simple repairs as authorized in your product documentation, or as directed by the online or telephone service and support team. Damage due to servicing that is not authorized by Dell is not covered by your warranty. Read and follow the safety instructions that came with the product.

1. Ensure that you follow the [Safety instructions](#).
2. Verify that both the power supply units (PSUs) are the same type and have the same maximum output power.

✍ NOTE: The maximum output power (shown in Watts) is listed on the power supply label.

3. If installed, remove the PSU blank.

Steps

1. Slide the new PSU into the chassis until the PSU is fully seated and the release latch snaps into place.

 **NOTE:** If you unlatched the cable management arm, re-latch it. For information about the cable management arm, see the system's rack documentation.

 **CAUTION:** When connecting the power cable, secure the cable with the strap.

2. Connect the power cable to the PSU and plug the cable into a power outlet.

 **NOTE:** When installing, hot swapping, or hot adding a new PSU, wait for 15 seconds for the system to recognize the PSU and determine its status. The power supply redundancy may not occur until the new PSU discovery is complete. Wait until the new PSU is discovered and enabled before you remove the other PSU. The PSU status indicator turns green to signify that the PSU is functioning properly.

Removing the power supply unit blank

Prerequisites

 **CAUTION:** Many repairs may only be done by a certified service technician. You should only perform troubleshooting and simple repairs as authorized in your product documentation, or as directed by the online or telephone service and support team. Damage due to servicing that is not authorized by Dell is not covered by your warranty. Read and follow the safety instructions that came with the product.

 **CAUTION:** To ensure proper system cooling, the power supply unit (PSU) blank must be installed in the second power supply bay in a non-redundant configuration. Remove the power supply blank only if you are installing a second power supply.

1. Ensure that you follow the [Safety instructions](#).

Steps

1. Hold the PSU blank by the sides, and slide it to disengage the tabs on the PSU blank from the slots on the chassis.
2. Remove the PSU blank out of the PSU bay.

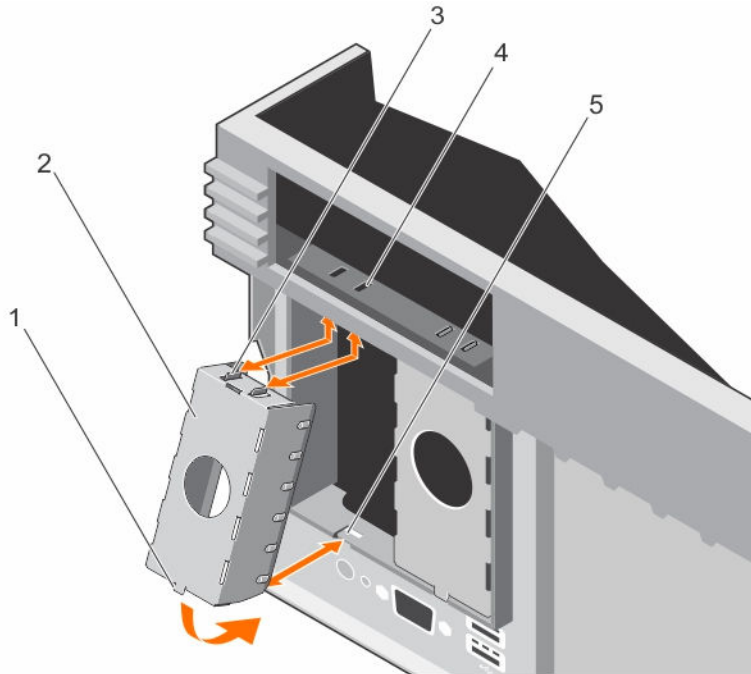

Figure 44. Removing and installing the PSU blank

- | | |
|--------------------------------------|----------------------------|
| 1. tab at the bottom of PSU blank | 2. PSU blank |
| 3. tab on the PSU blank (2) | 4. slot on the chassis (2) |
| 5. slot at the bottom of the chassis | |

Next steps

Install the PSU or PSU blank.

Related Tasks

[Installing an AC power supply unit](#)

[Installing the power supply unit blank](#)

Installing the power supply unit blank

Prerequisites

⚠ CAUTION: Many repairs may only be done by a certified service technician. You should only perform troubleshooting and simple repairs as authorized in your product documentation, or as directed by the online or telephone service and support team. Damage due to servicing that is not authorized by Dell is not covered by your warranty. Read and follow the safety instructions that came with the product.

Ensure that you follow the [Safety instructions](#).

✎ NOTE: Install the power supply unit (PSU) blank only in the second PSU bay.

Steps

1. Align the tabs on the PSU blank with the slots on the chassis.
2. Insert the top of the PSU blank into the PSU bay first, and then the bottom.

Ensure that the tabs on the PSU blank engage with the slots on the chassis.

Power distribution board

Your system supports two Power Distribution Boards (PDBs) connected to the system board. PDBs are located on the left and right sides of the system and supports AC power supply for your system.

Removing the power supply unit bay

Prerequisites

 **CAUTION:** Many repairs may only be done by a certified service technician. You should only perform troubleshooting and simple repairs as authorized in your product documentation, or as directed by the online or telephone service and support team. Damage due to servicing that is not authorized by Dell is not covered by your warranty. Read and follow the safety instructions that came with the product.

1. Ensure that you follow the [Safety instructions](#).
2. Follow the procedure listed in [Before working inside your system](#).
3. Remove the following:
 - a. AC PSU or power supply unit (PSU) blanks, if installed
 - b. Expansion card risers, if installed
 - c. Storage controller card for the left PSU bay

Steps

1. Using your index finger and thumb press the spring latch on the PSU bay, and pull it until:
 - a. The slots on the PSU bay disengage from the tabs on the chassis.
 - b. The connector on the Power Distribution Board (PDB) disengages from the connector on the system board.
2. Lift the power supply bay away from the system.
Follow the same procedure for the removal of other power supply bay in the system.

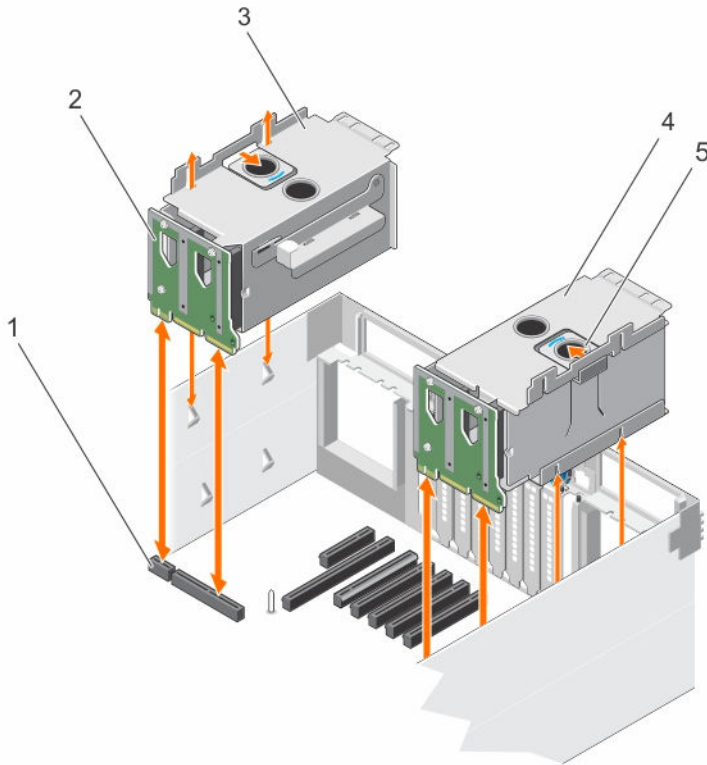

- | | |
|----------------------------------|---------------------------|
| 1. connector on the system board | 2. PDB |
| 3. left power supply bay | 4. right power supply bay |
| 5. spring latch | |

Next steps

Install the PSU bay.

Related Tasks

- [Removing an AC power supply unit](#)
- [Removing the power supply unit blank](#)
- [Removing the left expansion card riser](#)
- [Removing the right expansion card riser](#)
- [Removing the integrated storage controller card](#)
- [Installing the power supply unit bay](#)

Installing the power supply unit bay

Prerequisites

⚠ CAUTION: Many repairs may only be done by a certified service technician. You should only perform troubleshooting and simple repairs as authorized in your product documentation, or as directed by the online or telephone service and support team. Damage due to servicing that is not authorized by Dell is not covered by your warranty. Read and follow the safety instructions that came with the product.

Ensure that you follow the [Safety instructions](#).

Steps

1. Orient the power supply unit (PSU) bay to the side of the chassis.
2. Align the following:
 - a. Four slots on the PSU bay with the hooks on the side of the chassis.
 - a. Connector on the power distribution board (PDB) with the connector on the system board.
3. Press the PSU bay until it clicks into place.

Next steps

1. Install the following:
 - a. Storage controller card for the left power supply bay
 - b. Expansion card risers, if removed
2. Install the AC PSU or PSU blanks.
3. Follow the procedure listed in [After working inside your system](#).

Related Tasks

- [Installing the integrated storage controller card](#)
- [Installing the left expansion card riser](#)
- [Installing the right expansion card riser](#)
- [Installing an AC power supply unit](#)
- [Installing the power supply unit blank](#)

Removing the power distribution board

Prerequisites

 **CAUTION:** Many repairs may only be done by a certified service technician. You should only perform troubleshooting and simple repairs as authorized in your product documentation, or as directed by the online or telephone service and support team. Damage due to servicing that is not authorized by Dell is not covered by your warranty. Read and follow the safety instructions that came with the product.

1. Ensure that you follow the [Safety instructions](#).
2. Follow the procedure listed in [Before working inside your system](#).
3. Keep the Phillips #2 screwdriver ready
4. Remove the following:
 - a. Expansion card risers, if installed
 - b. Storage controller card
 - c. AC power supply unit (PSU) or PSU blank, if installed
 - d. PSU bay

 **NOTE:** The Power Distribution Boards (PDBs) are located toward the back of the PSU bay.

Steps

1. Remove the screws securing the PDB to the PSU bay.
2. Remove the PDB from the PSU bay.

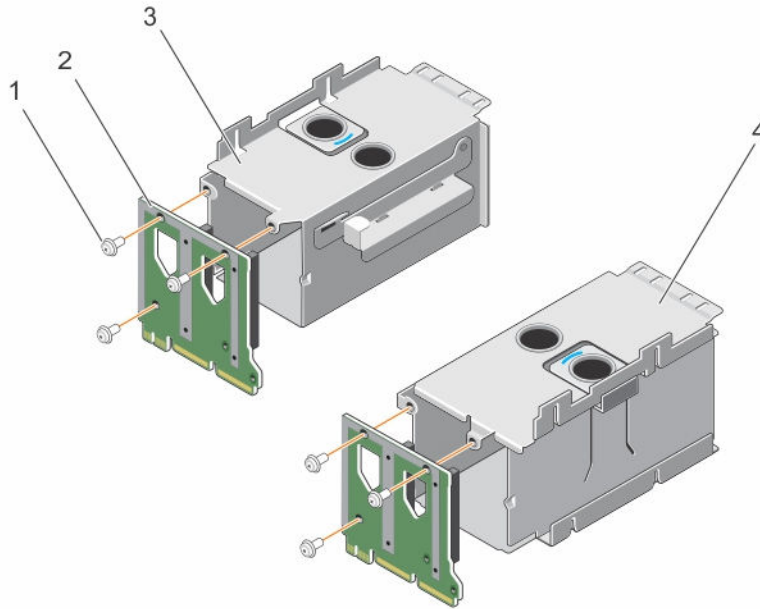

Figure 45. Removing and installing the power distribution board

- | | |
|-----------------|------------------|
| 1. screw (3) | 2. PDB |
| 3. left PSU bay | 4. right PSU bay |

Next steps

Install the PDB.

Related Tasks

- [Removing the right expansion card riser](#)
- [Removing the left expansion card riser](#)
- [Removing the integrated storage controller card](#)
- [Removing an AC power supply unit](#)
- [Removing the power supply unit blank](#)
- [Removing the power supply unit bay](#)
- [Installing the power distribution board](#)

Installing the power distribution board

Prerequisites

CAUTION: Many repairs may only be done by a certified service technician. You should only perform troubleshooting and simple repairs as authorized in your product documentation, or as directed by the online or telephone service and support team. Damage due to servicing that is not authorized by Dell is not covered by your warranty. Read and follow the safety instructions that came with the product.

1. Ensure that you follow the [Safety instructions](#).
2. Follow the procedure listed in [Before working inside your system](#).
3. Keep the Phillips #2 screwdriver ready.

4. Unpack the new power distribution board (PDB).

Steps

1. Align the screw holes on the PDB with the holes on the power supply unit (PSU) bay.
2. Tighten the screws to secure the PDB to the PSU bay.

Next steps

1. Install the following:
 - a. PSU bay
 - b. AC PSU or PSU blank, if installed
 - c. Storage controller card
 - d. Expansion card risers, if installed
2. Follow the procedure listed in [After working inside your system](#).

Related Tasks

[Installing the power supply unit bay](#)

[Installing an AC power supply unit](#)

[Installing the power supply unit blank](#)

[Installing the integrated storage controller card](#)

[Installing the left expansion card riser](#)

[Installing the right expansion card riser](#)

System battery

Replacing the system battery

Prerequisites

 **CAUTION:** Many repairs may only be done by a certified service technician. You should only perform troubleshooting and simple repairs as authorized in your product documentation, or as directed by the online or telephone service and support team. Damage due to servicing that is not authorized by Dell is not covered by your warranty. Read and follow the safety instructions that came with the product.

 **NOTE:** This is a Field Replaceable Unit (FRU). Removal and installation procedures should be performed only by Dell certified service technicians.

 **WARNING:** There is a danger of a new battery exploding if it is incorrectly installed. Replace the battery only with the same or equivalent type recommended by the manufacturer. For more information, see the safety information that shipped with your system.

1. Ensure that you follow the [Safety instructions](#).
2. Follow the procedure listed in [Before working inside your system](#).
3. Remove the power supply unit (PSU) bay.
4. If installed, remove the expansion card riser.

Steps

1. Locate the battery socket.

△ CAUTION: To avoid damage to the battery connector, you must firmly support the connector while installing or removing a battery.

2. To remove the battery, support the battery connector by pressing down firmly on the positive side of the connector.

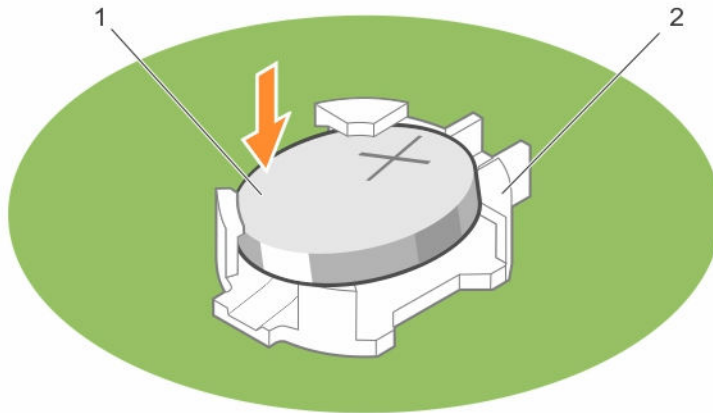

1. positive side of battery

2. socket

3. Lift the battery out of the securing tabs at the negative side of the connector.
4. To install a new system battery, support the battery connector by pressing down firmly on the positive side of the connector.
5. Hold the battery with the "+" facing up and slide it under the securing tabs at the positive side of the connector.
6. Press the battery straight down into the connector until it snaps into place.

Next steps

1. Install the PSU bay.
2. If removed, install the expansion card riser.
3. Follow the procedure listed in [After working inside your system](#).
4. Enter System Setup to confirm that the battery is operating properly.
5. Enter the correct time and date in the System Setup **Time** and **Date** fields.
6. Exit System Setup.

Related Tasks

[Removing the power supply unit bay](#)

[Installing the power supply unit bay](#)

Hard drive backplane

Depending on the configuration, your system supports the following backplanes:

- 2.5 inch (x4) SAS/SATA backplane
- 2.5 inch (x24) SAS/SATA backplane
- 2.5 inch (x16) SAS/SATA backplane plus 2.5 inch (x8) Dell PowerEdge Express Flash (PCIe SSD) backplane

Removing the hard drive backplane

Prerequisites

 **CAUTION:** Many repairs may only be done by a certified service technician. You should only perform troubleshooting and simple repairs as authorized in your product documentation, or as directed by the online or telephone service and support team. Damage due to servicing that is not authorized by Dell is not covered by your warranty. Read and follow the safety instructions that came with the product.

1. Ensure that you follow the [Safety instructions](#).
2. Follow the procedure listed in [Before working inside your system](#).
3. If installed, remove the front bezel.

 **CAUTION:** To prevent damage to the drives and backplane, you must remove the hard drives from the system before removing the backplane.

 **CAUTION:** You must note the number of each hard drive and temporarily label them before removal so that you can replace them in the same locations.

4. Remove the following:
 - a. Hard drives
 - b. Memory risers
 - c. Cooling fans
 - d. Memory riser and fan cage
 - e. SAS expander daughter card

 **NOTE:** Not applicable for the 2.5 inch (x4) SAS/SATA backplane configuration.

5. Disconnect the SAS/SATA/SSD data, signal, and power cables from the backplane and system board.

Steps

1. Push the release tabs in the direction of the arrow.
2. Lift the backplane away from the system until the hooks and slots on the backplane disengage from the hooks and slots on the chassis.

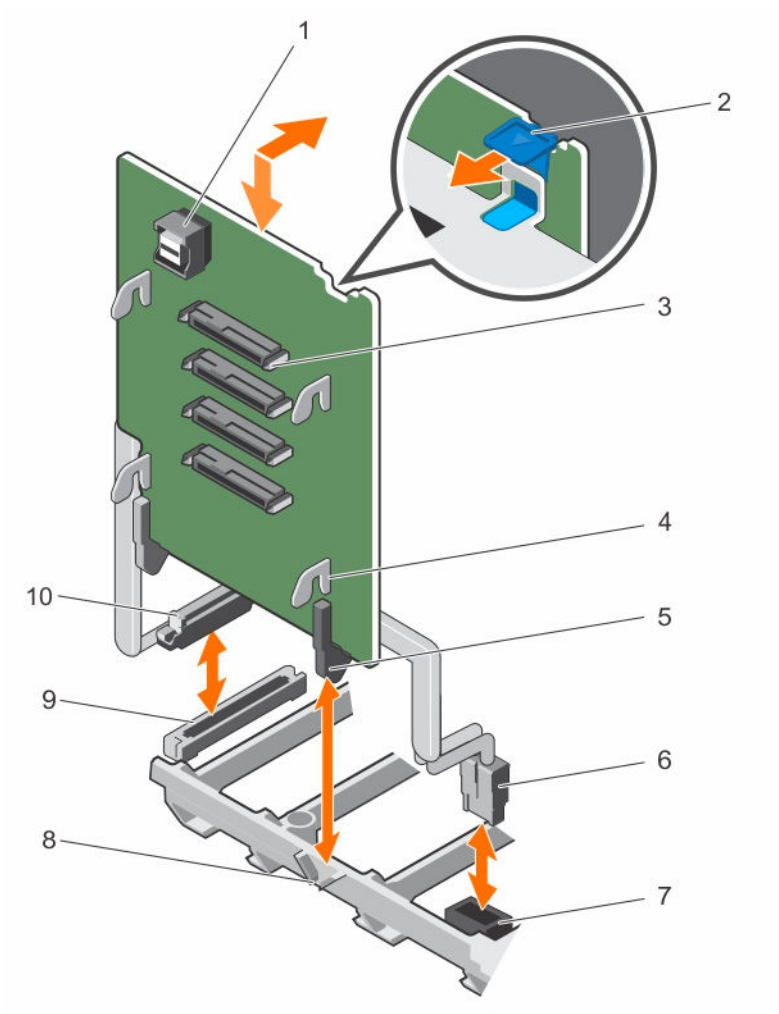

Figure 46. Removing and installing the 2.5 inch (x4) SAS/SATA backplane

- | | |
|---|--|
| 1. SAS connector | 2. release tab (2) |
| 3. hard drive connector (4) | 4. backplane hook (4) |
| 5. guide | 6. backplane power cable |
| 7. power connector on the system board | 8. memory riser guide |
| 9. miscellaneous signal connector on the system board | 10. backplane miscellaneous signal cable |

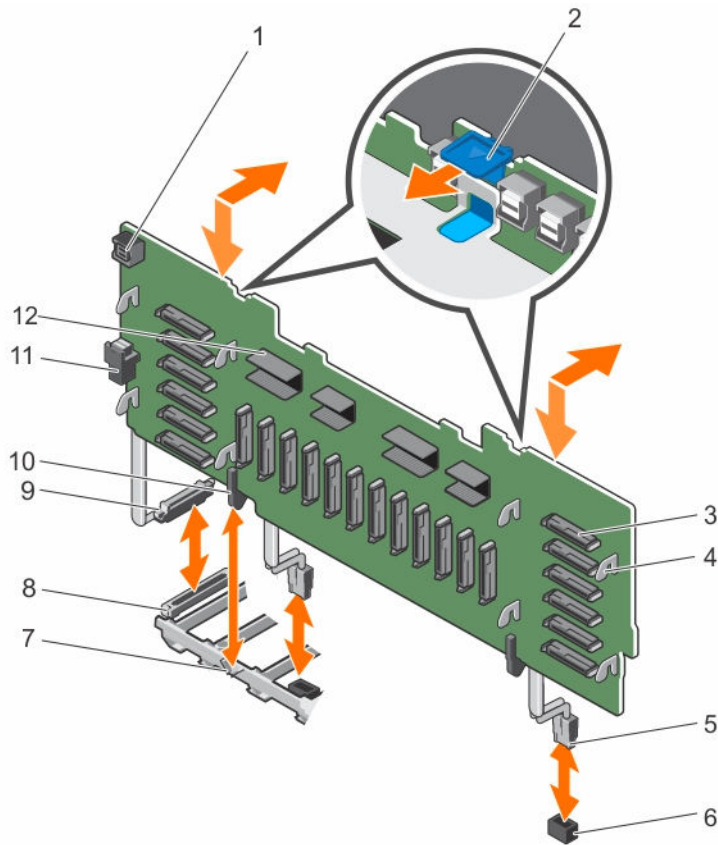

Figure 47. Removing and installing the 2.5 inch (x24) SAS/SATA backplane

- | | |
|--|---|
| 1. backplane jumper connector for the expander daughter card | 2. release tab (2) |
| 3. hard drive connector (24) | 4. backplane hook (8) |
| 5. backplane power cable (2) | 6. power connector on the system board (2) |
| 7. memory riser guide | 8. miscellaneous signal connector on the system board |
| 9. backplane miscellaneous signal cable | 10. guide |
| 11. backplane jumper connector | 12. expander connector |

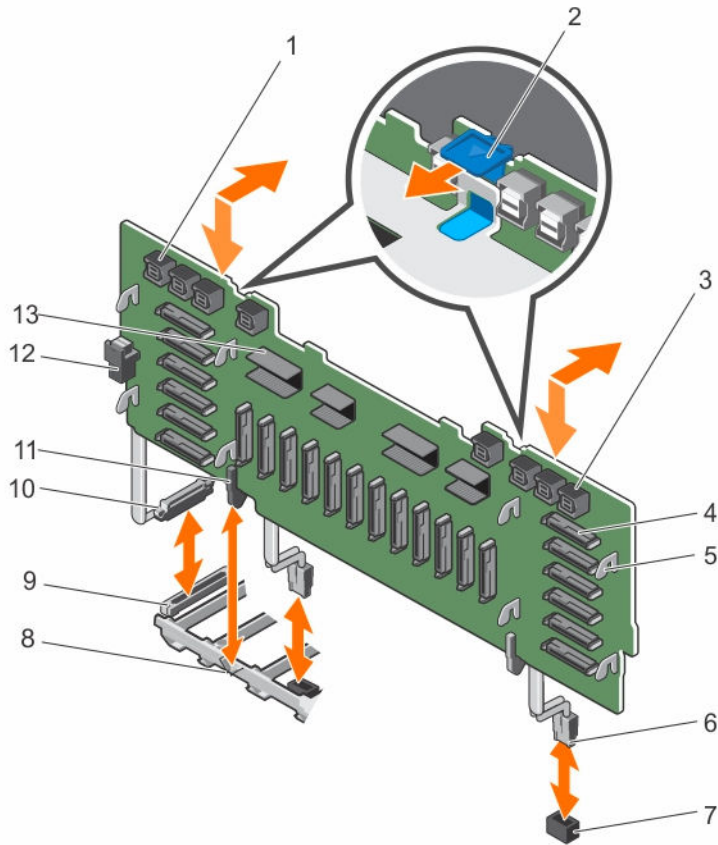

Figure 48. Removing and installing the 2.5 Inch (x16) SAS/SATA plus (x8) PCIe SSD backplane

- | | |
|--|--|
| 1. primary PCIe SSD extender mini-SAS HD connector (4) | 2. release tab (2) |
| 3. secondary PCIe SSD extender mini-SAS HD connector (4) | 4. hard drive connector (24) |
| 5. backplane hook (8) | 6. backplane power cable (2) |
| 7. power connector on the system board (2) | 8. memory riser guide |
| 9. miscellaneous signal connector on the system board | 10. backplane miscellaneous signal cable |
| 11. guide | 12. backplane jumper connector |
| 13. expander connector | |

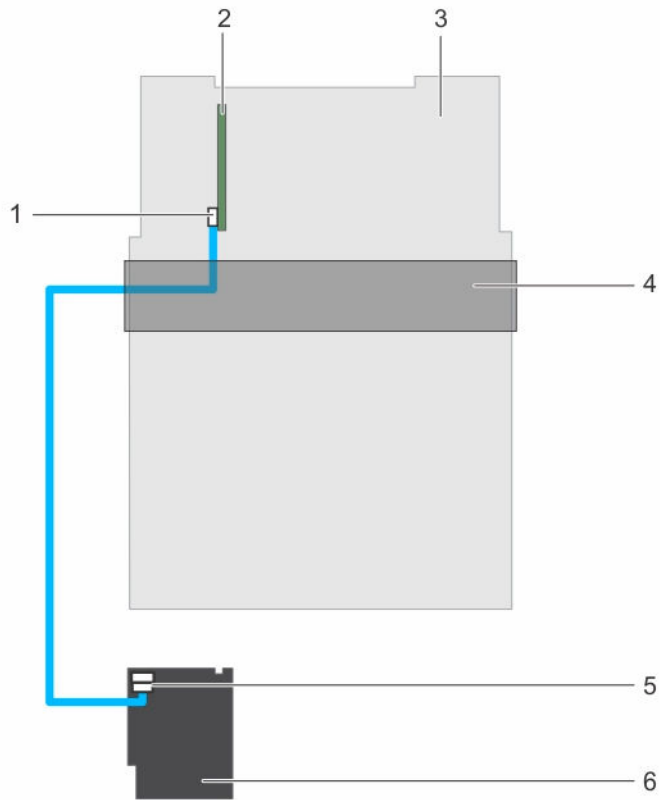

Figure 49. Cabling—2.5 inch (x4) SAS/SATA backplane with PERC 9

- | | |
|--|--|
| 1. SAS cable connector on the integrated storage controller card | 2. integrated storage controller card (PERC 9) |
| 3. system board | 4. cable management tray |
| 5. SAS connector on the backplane | 6. x4 hard drive backplane |

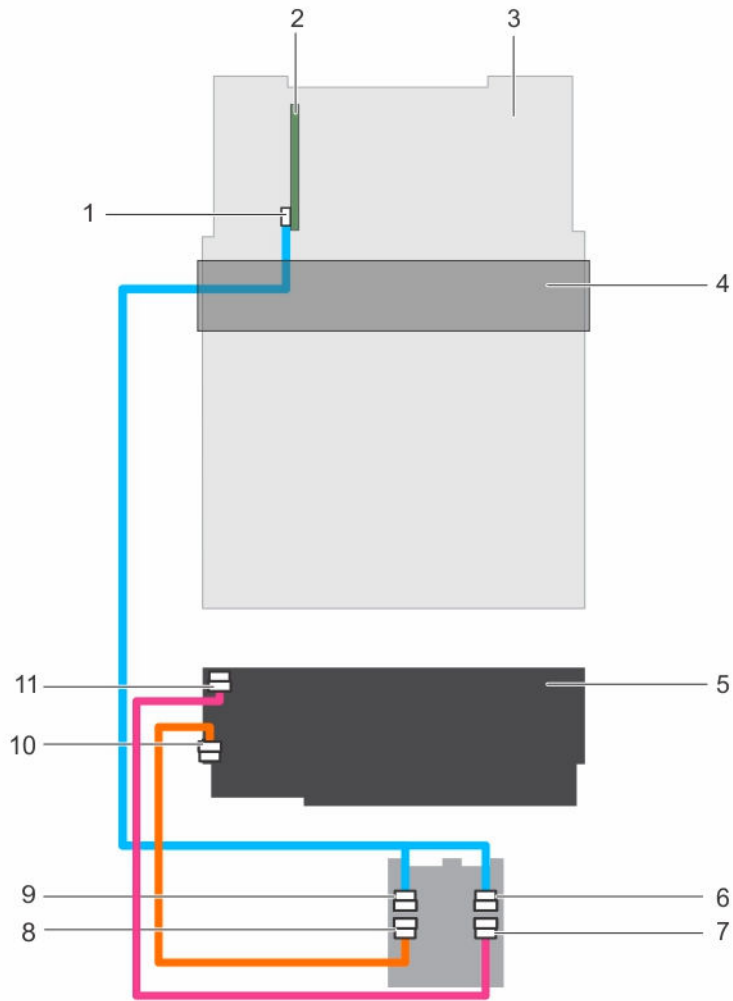

Figure 50. Cabling—2.5 inch (x24) SAS/SATA backplane with PERC 9

- | | |
|--|---|
| 1. SAS (A and B) cable connector on the integrated storage controller card | 2. integrated storage controller card (PERC 9) |
| 3. system board | 4. cable management tray |
| 5. x24 hard drive backplane | 6. SAS B cable connector on the expander daughter card |
| 7. backplane jumper cable connector on the expander daughter card | 8. SAS jumper cable connector on the expander daughter card |
| 9. SAS A cable connector on the expander daughter card | 10. SAS jumper cable connector on the backplane |
| 11. backplane jumper cable connector on the backplane | |

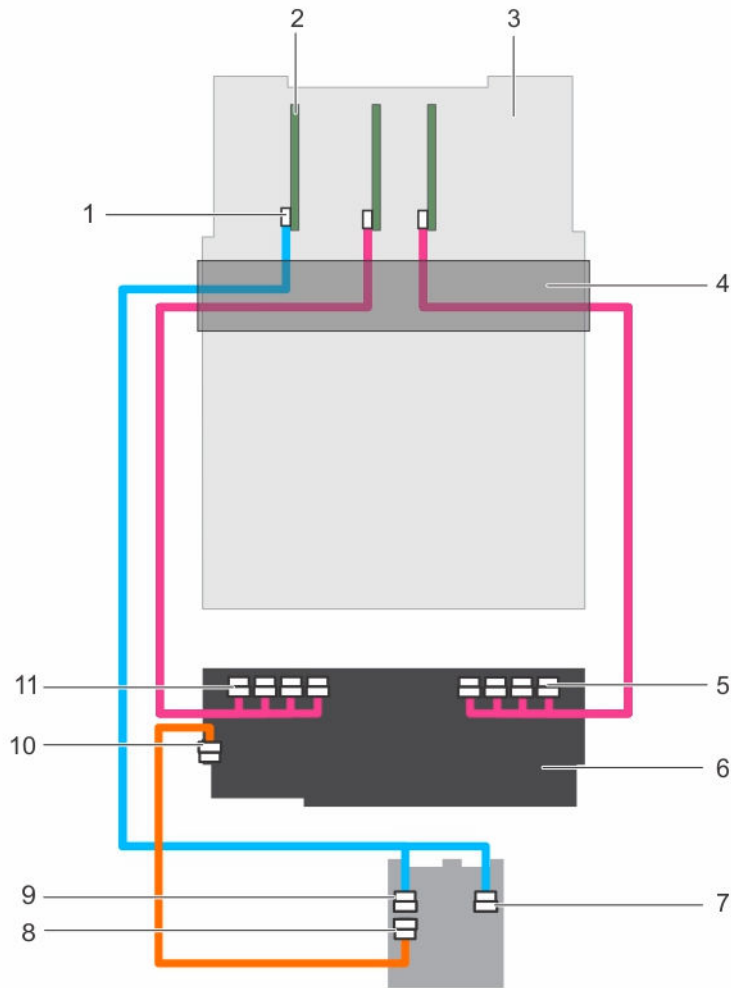

Figure 51. Cabling—2.5 inch (x16) SAS/SATA plus (x8) PCIe SSD backplane (left and right side)

- | | |
|--|---|
| 1. SAS (A&B) cable connector on the integrated storage controller card | 2. integrated storage controller card (PERC 9) |
| 3. system board | 4. cable management tray |
| 5. secondary PCIe SSD extender mini-SAS HD connector (A to D) | 6. 2.5 inch (x16) SAS/SATA plus (x8) PCIe SSD backplane |
| 7. SAS B cable connector on the expander daughter card | 8. SAS jumper cable connector on the expander daughter card |
| 9. SAS A cable connector on the expander daughter card | 10. SAS jumper cable connector on the backplane |
| 11. primary PCIe SSD extender mini-SAS HD connector (A to D) | |

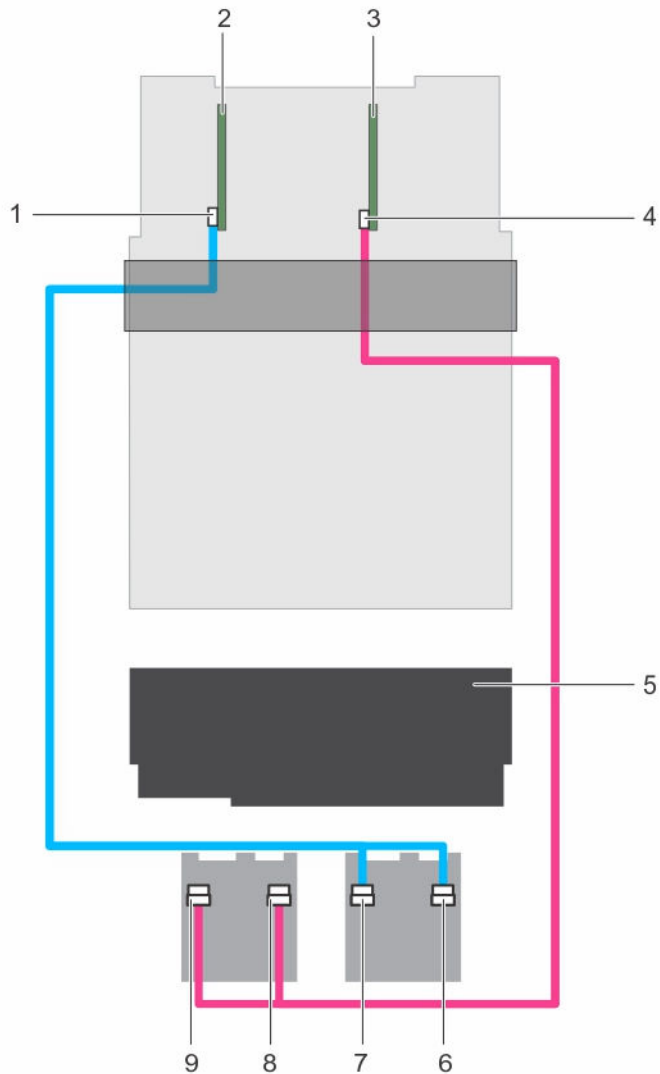

Figure 52. Cabling— x24 backplane with dual PERC and dual SAS expander cards

- | | |
|--|--|
| 1. SAS cable connector on the primary integrated storage controller card | 2. integrated storage controller card (primary card) |
| 3. integrated storage controller card (secondary card) | 4. SAS cable connector on the secondary integrated storage controller card |
| 5. x24 hard drive backplane | 6. primary daughter card SAS B connector |
| 7. primary daughter card SAS A connector | 8. secondary daughter card SAS B connector |
| 9. secondary daughter card SAS A connector | |

Next steps

Install the hard drive backplane.

Related Tasks

[Removing the optional front bezel](#)

[Removing a hot-swappable hard drive carrier](#)
[Removing a memory riser](#)
[Removing a cooling fan](#)
[Removing the memory riser and fan cage](#)
[Removing the SAS expander daughter card](#)
[Installing the hard drive backplane](#)

Installing the hard drive backplane

Prerequisites

 **CAUTION:** Many repairs may only be done by a certified service technician. You should only perform troubleshooting and simple repairs as authorized in your product documentation, or as directed by the online or telephone service and support team. Damage due to servicing that is not authorized by Dell is not covered by your warranty. Read and follow the safety instructions that came with the product.

Ensure that you follow the [Safety instructions](#).

 **NOTE:** Before installing the hard drive backplane, ensure that the hard drives are removed.

Steps

1. Align the following:
 - a. Black guide on the hard drive backplane with the memory riser guide.
 - b. Hooks and slots on the hard drive backplane with the hooks and slots on the chassis.
2. Lower the backplane into the system until the hooks and slots on the backplane engage with the hooks and slots on the chassis.

Next steps

1. Reconnect the SAS/SATA/PCIe SSD data, signal, and power cables to the backplane and system board.
2. Route the control panel/USB cable, PERC card cable, and PCIe SSD cables along the left side of the chassis wall.
3. Route the PERC card cable first, and then the PCIe SSD cables along the right side of the chassis wall.
4. Install the following:
 - a. SAS expander daughter card
 - b. Memory riser and fan cage
 - c. Cooling fans
 - d. Memory risers or memory riser blank, as applicable
 - e. Hard drives
 - f. Front bezel, if removed
5. Follow the procedure listed in [After working inside your system](#).

Related Tasks

[Installing the SAS expander daughter card](#)
[Installing the memory riser and fan cage](#)
[Installing a cooling fan](#)
[Installing a memory riser](#)
[Installing a hot-swappable hard drive carrier](#)

SAS expander daughter card

The systems storage uses SAS expander daughter card to facilitate:

- Transition of SAS technology from 6 Gbps to 12 Gbps
- Maximize the hard disk drive space
- Provide the configuration flexibility and cabling and signalling issues of the system

The daughter card uses LSI expander chips that support:

- Up to 12 Gbps SAS
- Up to 6 Gbps SAS and SATA
- Serial SCSI Protocol (SSP)
- Spanning-Tree Protocol (STP)
- Simple Management Protocol (SMP) and their communication with the RAID controllers.

 **NOTE:** The SAS expander daughter card tray supports up to two daughter cards (depending on the system configuration).

Removing the SAS expander daughter card

Prerequisites

 **CAUTION:** Many repairs may only be done by a certified service technician. You should only perform troubleshooting and simple repairs as authorized in your product documentation, or as directed by the online or telephone service and support team. Damage due to servicing that is not authorized by Dell is not covered by your warranty. Read and follow the safety instructions that came with the product.

1. Ensure that you follow the [Safety instructions](#).
2. Follow the procedure listed in [Before working inside your system](#).
3. Disconnect the SAS cables connected to the SAS expander daughter card and hard drive backplane.

Steps

1. Push the release tabs up to release the SAS expander daughter card.
The SAS expander daughter card slides out disengaging itself from the backplane slots, towards the front of the system.
2. Pull the SAS expander daughter card out of the system.

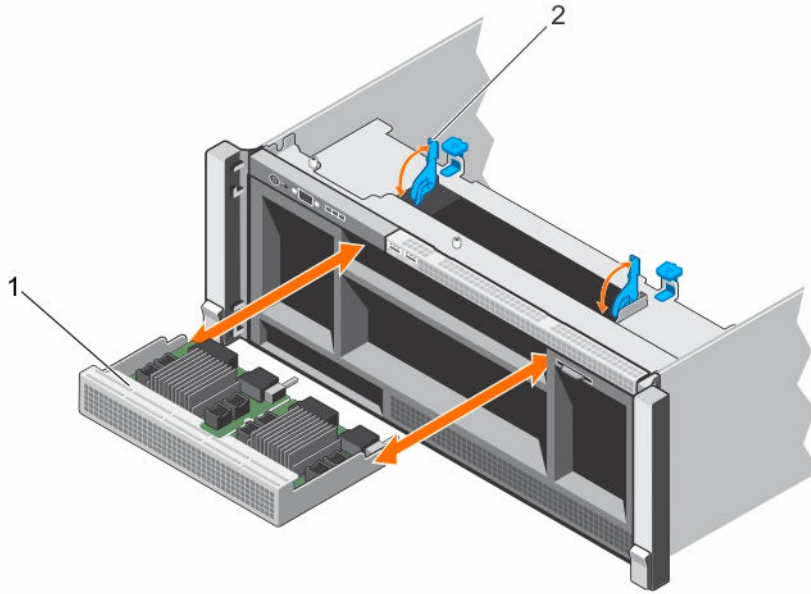

Figure 53. Removing and installing the SAS expander daughter card

1. SAS expander daughter card
2. release tab (2)

Next steps

Install the SAS expander daughter card.

Related Tasks

[Installing the SAS expander daughter card](#)

Installing the SAS expander daughter card

Prerequisites

⚠ CAUTION: Many repairs may only be done by a certified service technician. You should only perform troubleshooting and simple repairs as authorized in your product documentation, or as directed by the online or telephone service and support team. Damage due to servicing that is not authorized by Dell is not covered by your warranty. Read and follow the safety instructions that came with the product.

Ensure that you follow the [Safety instructions](#).

Steps

1. Open the release tabs, and insert the SAS expander daughter card into the slot in the front of the system.
2. Push the SAS expander daughter card into the system until the release tabs click into place.
NOTE: Ensure that the SAS expander daughter card pins engage with the slots on the backplane.
3. Press the release tabs to lock the SAS expander daughter card in place.

Next steps

1. Reconnect the SAS cables connected to the SAS expander daughter card and hard drive backplane.
2. Follow the procedure listed in [After working inside your system](#).

Control panel assembly

Removing the control panel board

Prerequisites



CAUTION: Many repairs may only be done by a certified service technician. You should only perform troubleshooting and simple repairs as authorized in your product documentation, or as directed by the online or telephone service and support team. Damage due to servicing that is not authorized by Dell is not covered by your warranty. Read and follow the safety instructions that came with the product.

1. Ensure that you follow the [Safety instructions](#).
2. Follow the procedure listed in [Before working inside your system](#).
3. Keep the Phillips #2 screwdriver ready.
4. Disconnect the cables connected to the control panel board.



NOTE: Note the routing of the cables on the side of the system as you remove them from the control panel board. You must route these cables properly when you replace them inside the shim stock pieces to prevent them from being pinched or crimped.

Steps

1. Remove the screws that secure the control panel board to the chassis.
2. Slide the control panel board toward the back of the system, and remove the control panel board away from the system.

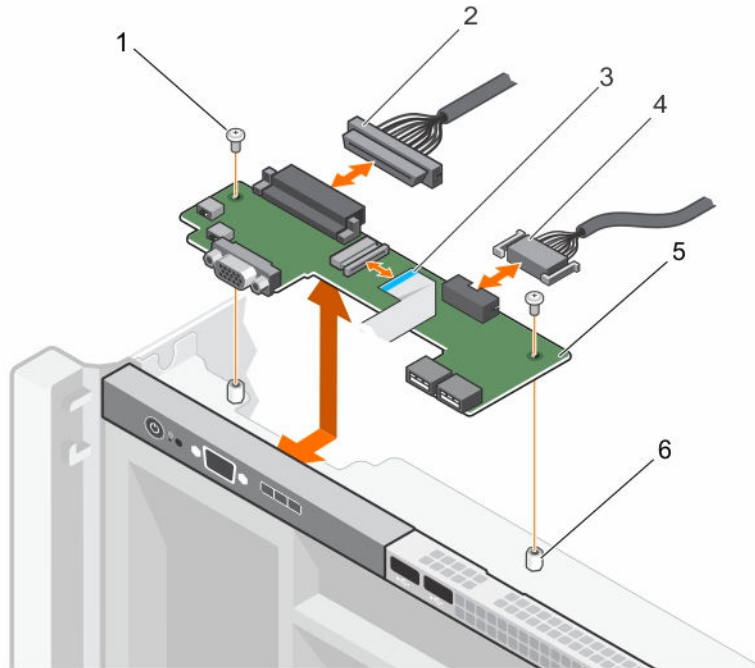

Figure 54. Removing and installing the control panel board

- | | |
|-------------------------|----------------------------------|
| 1. screw (2) | 2. control panel connector cable |
| 3. display module cable | 4. USB connector cable |
| 5. control panel board | 6. standoff (2) |

Next steps

Install the control panel board.

Related Tasks

[Installing the control panel board](#)

Installing the control panel board

Prerequisites

⚠ CAUTION: Many repairs may only be done by a certified service technician. You should only perform troubleshooting and simple repairs as authorized in your product documentation, or as directed by the online or telephone service and support team. Damage due to servicing that is not authorized by Dell is not covered by your warranty. Read and follow the safety instructions that came with the product.

1. Ensure that you follow the [Safety instructions](#).
2. Keep the Phillips #2 screwdriver ready.

Steps

1. Align the screw holes on the control panel board with the holes on the chassis.
2. Tighten the screws that secure the control panel board to the chassis.

Next steps

1. Reconnect all the cables to the control panel board.
2. Follow the procedure listed in [After working inside your system](#).

System board

Removing the system board

Prerequisites

 **CAUTION:** Many repairs may only be done by a certified service technician. You should only perform troubleshooting and simple repairs as authorized in your product documentation, or as directed by the online or telephone service and support team. Damage due to servicing that is not authorized by Dell is not covered by your warranty. Read and follow the safety instructions that came with the product.

 **CAUTION:** If you are using the Trusted Program Module (TPM) with an encryption key, you may be prompted to create a recovery key during program or System Setup. Be sure to create and safely store this recovery key. If you replace this system board, you must supply the recovery key when you restart your system or program before you can access the encrypted data on your hard drives.

 **NOTE:** This is a Field Replaceable Unit (FRU). Removal and installation procedures should be performed only by Dell certified service technicians.

1. Ensure that you follow the [Safety instructions](#).
2. Follow the procedure listed in [Before working inside your system](#).
3. Disconnect the cables connected to the system board, SAS backplane, and control panel board.
4. Remove the following:
 - a. Cable management tray
 - b. Cooling fans (6)
 - c. Memory risers (8)
 - d. Memory riser and fan cage
 - e. Fan tray
 - f. Processor blank and heat sink blank
 - g. Processors and heat sinks
 - h. Power supply units
 - i. Power supply unit bays with power distribution boards (2)
 - j. NDC riser
 - k. Expansion card risers, expansion cards, integrated storage controller cards
 - l. Internal USB key, if installed
 - m. Hard drive backplanes
 - n. Optical drive

 **WARNING:** The heat sink is hot to touch for some time after the system has been powered down. Ensure that you do not touch the heat sink(s) while removing the system board.

5. Disconnect all cables from the system board.

CAUTION: Do not lift the system board by holding a memory module, processor, or other components.

NOTE: Exercise caution when you install the system board into the chassis, because installing the system board may cause damage to the optical drive cable connector that is connected to front of the system board.

Steps

1. Hold the system board by the memory riser guide, lift the blue release pin, and slide the system board toward the front of the system.
2. Lift the system board away from the chassis until it clears the retention pins on the chassis.
3. Holding the memory riser guide and metal bracket, angle the system board toward the back of the chassis.

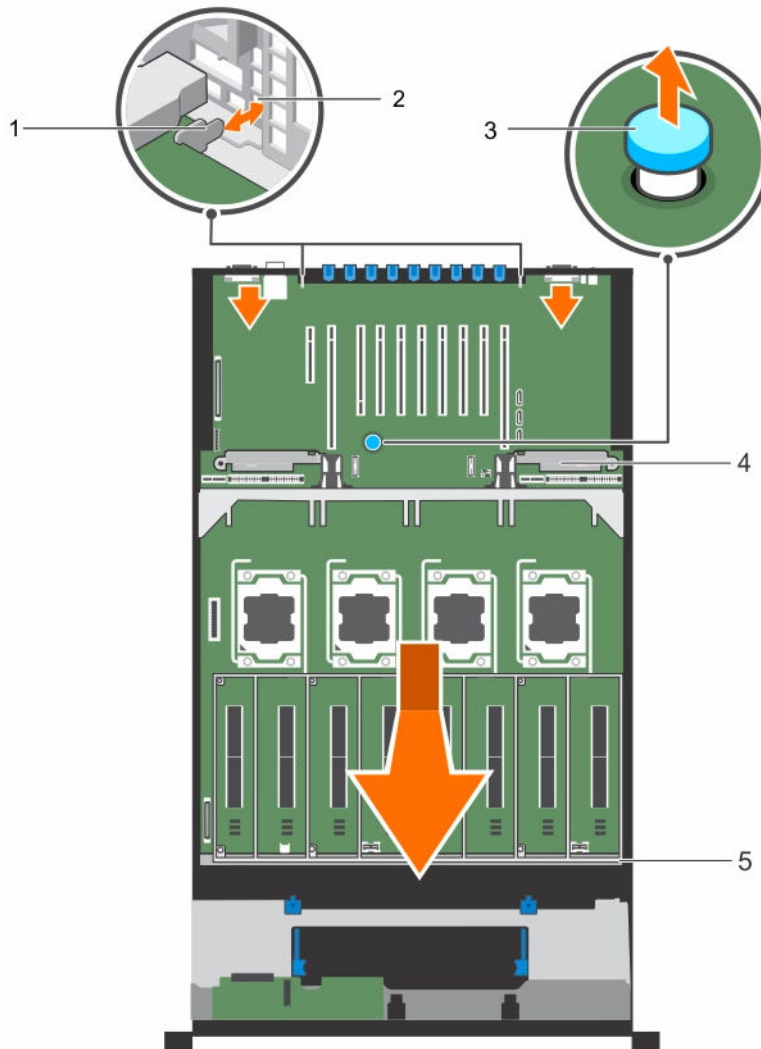

Figure 55. Removing and installing the system board

- | | |
|---------------------------------|-------------------------|
| 1. tabs on the system board (2) | 2. slots on the chassis |
| 3. release pin | 4. metal bracket |

5. memory riser guide

Next steps

Install the system board.

Related Tasks

- [Removing the cable management tray](#)
- [Removing a cooling fan](#)
- [Removing a memory riser](#)
- [Removing the memory riser and fan cage](#)
- [Removing the fan tray](#)
- [Removing a heat sink](#)
- [Removing a processor blank and heat sink blank](#)
- [Removing a processor](#)
- [Removing an AC power supply unit](#)
- [Removing the power supply unit bay](#)
- [Removing the power distribution board](#)
- [Removing the NDC riser](#)
- [Removing the right expansion card riser](#)
- [Removing the left expansion card riser](#)
- [Removing an expansion card from expansion card risers](#)
- [Removing the integrated storage controller card](#)
- [Replacing the internal USB key](#)
- [Removing the hard drive backplane](#)
- [Removing the optical drive](#)

Installing the system board

Prerequisites

 **CAUTION:** Many repairs may only be done by a certified service technician. You should only perform troubleshooting and simple repairs as authorized in your product documentation, or as directed by the online or telephone service and support team. Damage due to servicing that is not authorized by Dell is not covered by your warranty. Read and follow the safety instructions that came with the product.



 **NOTE:** This is a Field Replaceable Unit (FRU). Removal and installation procedures should be performed only by Dell certified service technicians.

1. Ensure that you follow the [Safety instructions](#).
2. Unpack the new system board.

Steps

1. Holding the memory riser guide and metal bracket, lower the system board into the chassis.

 **CAUTION:** Do not lift the system board by holding a memory module, processor, or other components.

-  **NOTE:** Exercise caution when you install the system board into the chassis, because installing the system board may cause damage to the optical drive cable connector that is connected to front of the system board.
2. Push the system board toward the back of the chassis until the release pin on the board clicks into place.
-  **NOTE:** Ensure that the two tabs at the back of the system board engage with the slots on the chassis.

Next steps

1. Install the following:
 - a. Power supply unit bay (2) with power distribution board (2)
 - b. Power supply units
 - c. NDC riser
 - d. Expansion card risers, expansion card, integrated storage controller
 - e. Processors and heat sinks
 - f. Processor blank and heat sink blank
 - g. Fan tray
 - h. Memory riser and fan cage
 - i. Memory risers (8)
 - j. Cooling fans (6)
 - k. Cable management tray
 - l. Hard drive backplane
 - m. Internal USB key, if removed
 - n. Optical drive
2. Reconnect the cables to the system board, hard drive backplane, control panel board, and the optical drive cable.

 **NOTE:** Ensure that the cables inside the system are routed along the chassis wall and secured using the shimstock pieces.
3. Follow the procedure listed in [After working inside your system](#).
4. Ensure that you perform the following steps:
 - a. Use the Easy Restore feature to restore the service tag. For more information, see [Restoring the Service Tag using the Easy Restore feature](#).
 - b. If the service tag is not backed up in the backup flash device, enter the system service tag manually. For more information, see [Entering the system Service Tag using System Setup](#).
 - c. Update the BIOS and iDRAC versions.
 - d. Re-enable the Trusted Platform Module (TPM). For more information, see [Re-enabling the TPM for TXT users](#).
5. Import your new or existing iDRAC8 Enterprise license. For more information, see iDRAC8 User's Guide, at Dell.com/esmmanuals.

Related Tasks

- [Installing the power supply unit bay](#)
- [Installing the power distribution board](#)
- [Installing an AC power supply unit](#)
- [Installing the NDC riser](#)
- [Installing an expansion card into the expansion card risers](#)
- [Installing the left expansion card riser](#)

- [Installing the right expansion card riser](#)
- [Installing the integrated storage controller card](#)
- [Installing a processor](#)
- [Installing a heat sink](#)
- [Installing a processor blank and heat sink blank](#)
- [Installing the fan tray](#)
- [Installing the memory riser and fan cage](#)
- [Installing a memory riser](#)
- [Installing a cooling fan](#)
- [Installing the cable management tray](#)
- [Installing the hard drive backplane](#)
- [Replacing the internal USB key](#)
- [Installing the optical drive](#)

Restoring the Service Tag using the Easy Restore feature

Use the Easy Restore feature if you do not know the Service Tag of your system. The Easy Restore feature allows you to restore your system's Service Tag, license, UEFI configuration, and the system configuration data after replacing the system board. All data is backed up in a backup flash device automatically. If BIOS detects a new system board and the Service Tag in the backup flash device, BIOS prompts the user to restore the backup information.

1. Turn on the system.
If BIOS detects a new system board, and if the Service Tag is present in the backup flash device, BIOS displays the Service Tag, the status of the license, and the **UEFI Diagnostics** version.
2. Perform one of the following steps:
 - Press **Y** to restore the Service Tag, license, and diagnostics information.
 - Press **N** to navigate to the Lifecycle Controller based restore options.
 - Press <F10> to restore data from a previously created **Hardware Server Profile**.

After the restore process is complete, BIOS prompts to restore the system configuration data.

3. Perform one of the following steps:
 - Press **Y** to restore the system configuration data.
 - Press **N** to use the default configuration settings.

After the restore process is complete, the system restarts.

Entering the system Service Tag using System Setup

If you know the system Service Tag, use System Setup menu to enter the Service Tag.

About this task

 **NOTE:** This procedure should be followed if Easy Restore fails to populate the service tag.

Steps

1. Turn on the system.
2. Press <F2> to enter System Setup.
3. Click **Service Tag Settings**.
4. Enter the Service Tag.

 **NOTE:** You can enter the Service Tag only when the **Service Tag** field is empty. Ensure that you enter the correct Service Tag. Once the Service Tag is entered, it cannot be updated or changed.

5. Click **Ok**.
6. Import your new or existing iDRAC Enterprise license.
For more information, see Integrated Dell Remote Access Controller User's Guide, at dell.com/esmanuals.

Trusted Platform Module

The Trusted Platform Module (TPM) is used to generate or store keys, protect or authenticate passwords, and create or store digital certificates. TPM can also be used to enable the BitLocker hard drive encryption feature in Windows Server.

 **CAUTION:** Do not attempt to remove the Trusted Platform Module (TPM) from the system board. Once the TPM is installed, it is cryptographically bound to that specific system board. Any attempt to remove an installed TPM breaks the cryptographic binding, and it cannot be re-installed or installed on another system board.

 **NOTE:** This is a Field Replaceable Unit (FRU). Removal and installation procedures should be performed only by Dell certified service technicians.

Re-enabling the TPM for BitLocker users

Initialize the TPM.

For more information on initializing the TPM, see <http://technet.microsoft.com/en-us/library/cc753140.aspx>.

The **TPM Status** changes to **Enabled, Activated**.

Re-enabling the TPM for TXT users

1. While booting your system, press <F2> to enter System Setup.
2. In the **System Setup Main Menu**, click **System BIOS** → **System Security Settings**.
3. In the **TPM Security** option, select **On with Pre-boot Measurements**.
4. In the **TPM Command** option, select **Activate**.
5. Save the settings.
6. Restart your system.
7. Enter System Setup again.
8. In the **System Setup Main Menu**, click **System BIOS** → **System Security Settings**.
9. In the **Intel TXT** option, select **On**.

Troubleshooting your system

Safety first—for you and your system

 **CAUTION:** Many repairs may only be done by a certified service technician. You should only perform troubleshooting and simple repairs as authorized in your product documentation, or as directed by the online or telephone service and support team. Damage due to servicing that is not authorized by Dell is not covered by your warranty. Read and follow the safety instructions that came with the product.

Troubleshooting system startup failure

If you boot the system to the BIOS boot mode after installing an operating system from the UEFI Boot Manager, the system stops responding. You must boot to the same boot mode in which you installed the operating system.

For all other startup issues, note the system messages that appear on the screen.

Troubleshooting external connections

Ensure that all external cables are securely attached to the external connectors on your system before troubleshooting any external devices.

Troubleshooting the video subsystem

1. Check the power connections to the monitor.
2. Check the video interface cabling from the system to the monitor.
3. Run the appropriate diagnostic test.

If the tests run successfully, the problem is not related to video hardware.

If the tests fail, see [Getting Help](#).

Troubleshooting a USB device

About this task

Follow steps 1 to 6 to troubleshoot a USB keyboard or mouse. For other USB devices, go to step 7.

Steps

1. Disconnect the keyboard and/or mouse cables from the system and reconnect them.
2. If the problem persists, connect the keyboard and/or mouse to another USB port on the system.
3. If the problem is resolved, restart the system, enter System Setup, and check if the non-functioning USB ports are enabled.



NOTE: Older operating systems may not support USB 3.0.

4. Check if USB 3.0 is enabled in System Setup. If enabled, disable it and see if the issue is resolved.
5. In **iDRAC Settings Utility**, ensure **USB Management Port Mode** is configured as **Automatic** or **Standard OS Use**.
6. If the problem is not resolved, replace the keyboard and/or mouse with a working keyboard or mouse.
If the problem is not resolved, proceed to the next step to troubleshoot other USB devices attached to the system.
7. Turn off all attached USB devices, and disconnect them from the system.
8. Restart the system.
9. If your keyboard is functioning, enter System Setup, verify that all USB ports are enabled on the **Integrated Devices** screen.
10. Check if USB 3.0 is enabled in System Setup. If it is enabled, disable it and restart your system.
If your keyboard is not functioning, you can use remote access to enable or disable the USB options.
11. If the system is not accessible, reset the NVRAM_CLR jumper inside your system and restore the BIOS to the default settings.
12. In the **iDRAC Settings Utility**, ensure **USB Management Port Mode** is configured as **Automatic** or **Standard OS Use**.
13. Reconnect and power on each USB device one at a time.
14. If a USB device causes the same problem, turn off the device, replace the USB cable with a known good cable, and turn on the device.

Next steps

If all troubleshooting fails, see [Getting Help](#).

Troubleshooting a serial I/O device

Steps

1. Turn off the system and any peripheral devices connected to the serial port.
2. Swap the serial interface cable with a working cable, and turn on the system and the serial device.
If the problem is resolved, replace the interface cable with a known good cable.
3. Turn off the system and the serial device, and swap the serial device with a comparable device.
4. Turn on the system and the serial device.

Next steps

If the problem persists, see [Getting Help](#).

Troubleshooting a NIC

Steps

1. Run the appropriate diagnostic test. For more information, see [Using system diagnostics](#) for available diagnostic tests.
2. Restart the system and check for any system messages pertaining to the NIC controller.
3. Check the appropriate indicator on the NIC connector:
 - If the link indicator does not light, check all cable connections.
 - If the activity indicator does not light, the network driver files might be damaged or missing. Remove and reinstall the drivers if applicable. For more information, see the NIC documentation.
 - If applicable, change the autonegotiation setting.
 - Use another connector on the switch or hub.
4. Ensure that the appropriate drivers are installed and the protocols are bound. For more information, see the NIC documentation.
5. Enter System Setup and confirm that the NIC ports are enabled on the **Integrated Devices** screen.
6. Ensure that all the NICs, hubs, and switches on the network are set to the same data transmission speed and duplex. For more information, see the documentation for each network device.
7. Ensure that all network cables are of the proper type and do not exceed the maximum length.

Next steps

If all troubleshooting fails, see [Getting Help](#).

Troubleshooting a wet system

Prerequisites

 **CAUTION:** Many repairs may only be done by a certified service technician. You should only perform troubleshooting and simple repairs as authorized in your product documentation, or as directed by the online or telephone service and support team. Damage due to servicing that is not authorized by Dell is not covered by your warranty. Read and follow the safety instructions that came with the product.

 **WARNING:** When troubleshooting a wet system, ensure the power cables are unplugged and the flea power is drained off the system board or it may expose you to a risk of electric shock.

Steps

1. Turn off the system and attached peripherals, and disconnect the system from the electrical outlet.
2. Open the system cover.
3. Disassemble components from the system:
 - Hard drives
 - Optical drive
 - Hard drive backplane

- USB memory key
 - NIC hardware key
 - SD cards
 - Cable Management Tray
 - Expansion cards and expansion card risers
 - Network Daughter Card Riser (Riser 1)
 - Power supply(s)
 - Cooling fans
 - Memory risers
 - Memory riser and fan cage
 - Processor(s) and heat sink(s)
4. Let the system dry thoroughly for at least 24 hours.
 5. Reinstall the components you removed in step 3.
 6. Close the system cover.
 7. Turn on the system and attached peripherals.
If the system does not start properly, see [Getting Help](#).
 8. If the system starts properly, shut down the system and reinstall all of the expansion cards that you removed.
 9. Run the appropriate diagnostic test. For more information, see [Using system diagnostics](#).

Next steps

If the tests fail, see [Getting Help](#).

Troubleshooting a damaged system

Prerequisites



CAUTION: Many repairs may only be done by a certified service technician. You should only perform troubleshooting and simple repairs as authorized in your product documentation, or as directed by the online or telephone service and support team. Damage due to servicing that is not authorized by Dell is not covered by your warranty. Read and follow the safety instructions that came with the product.

Steps

1. Turn off the system and attached peripherals, and disconnect the system from the electrical outlet.
2. Remove the system cover.
3. Ensure that the following components are properly installed:
 - Hard drive carriers
 - Hard drive backplane
 - Hard drives
 - Cable Management Tray
 - Expansion cards and expansion card risers
 - Power supply(s)
 - Memory risers
 - Cooling fans

- Memory riser and fan cage
 - SD cards
 - USB memory key
 - NIC hardware key
 - Network Daughter Card riser (Riser 1)
 - Processor(s) and heat sink(s)
4. Ensure that all cables are properly connected.
 5. Install the system cover.
 6. Run the appropriate diagnostic test. For more information, see [Using system diagnostics](#).

Next steps

If the tests fail, see [Getting Help](#).

Troubleshooting the system battery

Prerequisites

 **CAUTION:** Many repairs may only be done by a certified service technician. You should only perform troubleshooting and simple repairs as authorized in your product documentation, or as directed by the online or telephone service and support team. Damage due to servicing that is not authorized by Dell is not covered by your warranty. Read and follow the safety instructions that came with the product.

 **NOTE:** If the system is turned off for long periods of time (for weeks or months), the NVRAM may lose its system configuration information. This situation is caused by a defective battery.

 **NOTE:** Some software may cause the system time to speed up or slow down. If the system seems to operate normally except for the time set in System Setup, the problem may be caused by a software rather than by a defective battery.

Steps

1. Re-enter the time and date in System Setup.
2. Turn off the system, and disconnect it from the electrical outlet for at least one hour.
3. Reconnect the system to the electrical outlet, and turn on the system.
4. Enter System Setup.

If the date and time are not correct in System Setup, check the System Error Log (SEL) for system battery messages.

Next steps

If the problem persists, see [Getting Help](#).

Troubleshooting power supply units

Prerequisites

 **CAUTION:** Many repairs may only be done by a certified service technician. You should only perform troubleshooting and simple repairs as authorized in your product documentation, or as directed by the online or telephone service and support team. Damage due to servicing that is not authorized by Dell is not covered by your warranty. Read and follow the safety instructions that came with the product.

 **CAUTION:** At least one power supply (PSU) must be installed for the system to operate. Operating the system with only one PSU installed for extended periods of time can cause the system to overheat.

Steps

1. Identify the faulty PSU by the PSU's fault indicator.
2. Reseat the PSU by removing and reinstalling it.

 **NOTE:** After installing a PSU, allow several seconds for the system to recognize the PSU and to determine if it is working properly.

3. If the problem persists, see [Getting Help](#).

Troubleshooting cooling problems

 **CAUTION:** Many repairs may only be done by a certified service technician. You should only perform troubleshooting and simple repairs as authorized in your product documentation, or as directed by the online or telephone service and support team. Damage due to servicing that is not authorized by Dell is not covered by your warranty. Read and follow the safety instructions that came with the product.

Ensure that the following conditions exist:

- System cover, memory riser blank, drive blank, memory module blank, power supply blank, processor blank, or back-filler bracket is removed.
- Ambient temperature is not too high.
- External airflow is not obstructed.
- A cooling fan is not removed or has not failed.
- The expansion card installation guidelines have been followed.

Additional cooling can be added by one of the following methods:

From the iDRAC Web GUI

1. Click **Hardware** → **Fans** → **Setup**.
2. From the **Fan Speed Offset** drop-down list, select the cooling level needed or set the minimum fan speed to a custom value.

From F2 System Setup

1. Select **iDRAC Settings** → **Thermal**, and set a higher fan speed from the fan speed offset or minimum fan speed.

From RACADM commands

1. Run the command `racadm help system.thermalsettings`

For more information, see the Integrated Dell Remote Access User's Guide at Dell.com/esmmanuals.

Troubleshooting cooling fans

Prerequisites

 **CAUTION:** Many repairs may only be done by a certified service technician. You should only perform troubleshooting and simple repairs as authorized in your product documentation, or as directed by the online or telephone service and support team. Damage due to servicing that is not authorized by Dell is not covered by your warranty. Read and follow the safety instructions that came with the product.

Steps

1. Open the system cover.

 **CAUTION:** The cooling fans are hot-swappable. To maintain proper cooling while the system is on, only replace one fan at a time.

2. Locate the faulty fan indicated by the Embedded Server Management (ESM).
3. Replace the fan or the fan's power cable.

 **NOTE:** Wait at least 30 seconds for the system to recognize the fan and determine whether it is working properly.

4. If the problem is not resolved, install a new fan.
5. If the fan functions properly, close the system cover.

Next steps

If the problem persists, see [Getting Help](#).

Troubleshooting system memory

Prerequisites

 **CAUTION:** Many repairs may only be done by a certified service technician. You should only perform troubleshooting and simple repairs as authorized in your product documentation, or as directed by the online or telephone service and support team. Damage due to servicing that is not authorized by Dell is not covered by your warranty. Read and follow the safety instructions that came with the product.

Steps

1. If the system is operational, run the appropriate diagnostic test. See [Using system diagnostics](#) for available diagnostic tests.
If diagnostics indicates a fault, follow the corrective actions provided by the diagnostic program.
2. If the system is not operational, turn off the system and attached peripherals, and unplug the system from the power source. Wait at least 10 seconds and then reconnect the system to power.
3. Turn on the system and attached peripherals and note the messages on the screen.
If an error message is displayed indicating a fault with a specific memory module, go to step 14.
4. Enter System Setup and check the system memory setting. Make any changes to the memory settings, if needed.
If the memory settings match the installed memory but a problem is still indicated, go to step 14.
5. Turn off the system and attached peripherals, and disconnect the system from the electrical outlet.

6. Remove the system cover.
7. Remove the memory risers.
8. Check the memory channels and ensure that they are populated correctly.
9. Reseat the memory modules in their sockets.
10. Install the memory risers.
11. Install the system cover.
12. Reconnect the system to its electrical outlet, and turn on the system and attached peripherals.
13. Enter System Setup and check the system memory setting.
If the problem is not resolved, proceed with the next step.
14. If a diagnostic test or error message indicates a specific memory module as faulty, swap or replace the module with a known good memory module.
15. Remove the system cover.
16. Remove the memory risers.
17. To troubleshoot an unspecified faulty memory module, replace the memory module in the first DIMM socket with a module of the same type and capacity.
If an error message is displayed on the screen, this may indicate a problem with the installed DIMM type(s), incorrect DIMM installation, or defective DIMM(s). Follow the on-screen instructions to resolve the problem. For more information, see General Memory Module Installation Guidelines.
18. Install the memory risers.
19. Install the system cover.
20. Reconnect the system to its electrical outlet, and turn on the system and attached peripherals.
21. As the system boots, observe any error message that is displayed and the diagnostic indicators on the front of the system.
22. If the memory problem is still indicated, repeat step 14 through step 19 for each memory module installed.

Next steps

If the problem persists after all memory modules have been checked, see [Getting Help](#).

Troubleshooting an internal USB key

Prerequisites



CAUTION: Many repairs may only be done by a certified service technician. You should only perform troubleshooting and simple repairs as authorized in your product documentation, or as directed by the online or telephone service and support team. Damage due to servicing that is not authorized by Dell is not covered by your warranty. Read and follow the safety instructions that came with the product.

Steps

1. Enter System Setup and ensure that the **USB key port** is enabled on the **Integrated Devices** screen.
2. Turn off the system and attached peripherals, and disconnect the system from the electrical outlet.
3. Remove the system cover.
4. Locate the USB key and reseat it.
5. Install the system cover.
6. Turn on the system and attached peripherals, and check if the USB key is functioning.
7. If the problem is not resolved, repeat step 2 and step 3.

8. Insert a different USB key that you know works properly.
9. Install the system cover.

Next steps

If the problem is not resolved, see [Getting Help](#).

Troubleshooting an SD card

Prerequisites

 **CAUTION:** Many repairs may only be done by a certified service technician. You should only perform troubleshooting and simple repairs as authorized in your product documentation, or as directed by the online or telephone service and support team. Damage due to servicing that is not authorized by Dell is not covered by your warranty. Read and follow the safety instructions that came with the product.

 **NOTE:** Certain SD cards have a physical write-protect switch on the card. If the write-protect switch is turned on, the SD card is not writable.

Steps

1. Enter System Setup, and ensure that the **Internal SD Card Port** is enabled.
2. Turn off the system, including any attached peripherals, and disconnect the system from the electrical outlet.
3. Remove the system cover.
 -  **NOTE:** When an SD card failure occurs, the internal dual SD module controller notifies the system. On the next restart, the system displays a message indicating the failure. If redundancy is enabled at the time of SD card failure, a critical alert will be logged and chassis health will degrade.
4. Replace the failed SD card with a new SD card.
5. Install the system cover.
6. Reconnect the system to its electrical outlet and turn the system on, including any attached peripherals.
7. Enter System Setup, and ensure that the **Internal SD Card Port** and **Internal SD Card Redundancy** modes are set to the required modes.

Verify that the correct SD slot is set as **Primary SD Card**.
8. Check if the SD card is functioning properly.
9. If the **Internal SD Card Redundancy** option is set to **Enabled** at the time of the SD card failure, the system will prompt you to perform a rebuild.
 -  **NOTE:** The rebuild will always be sourced from the primary SD card to the secondary SD card. Perform the rebuild of the SD card as necessary.

Troubleshooting an optical drive

Prerequisites

 **CAUTION:** Many repairs may only be done by a certified service technician. You should only perform troubleshooting and simple repairs as authorized in your product documentation, or as directed by the online or telephone service and support team. Damage due to servicing that is not authorized by Dell is not covered by your warranty. Read and follow the safety instructions that came with the product.

Steps

1. Try using a different CD or DVD.
2. Enter the System Setup and ensure that the integrated SATA controller and the drive's SATA port are enabled.
3. Run the appropriate diagnostic test.
4. Turn off the system and attached peripherals, and disconnect the system from the electrical outlet.
5. If installed, remove the front bezel.
6. Remove the system cover.
7. Ensure that the interface cable is securely connected to the optical drive and to the controller.
8. Ensure that a power cable is properly connected to the drive.
9. Install the system cover.

Next steps

If the problem is not resolved, see [Getting Help](#).

Troubleshooting a hard drive

Prerequisites

 **CAUTION:** Many repairs may only be done by a certified service technician. You should only perform troubleshooting and simple repairs as authorized in your product documentation, or as directed by the online or telephone service and support team. Damage due to servicing that is not authorized by Dell is not covered by your warranty. Read and follow the safety instructions that came with the product.

 **CAUTION:** This troubleshooting procedure can erase data stored on the hard drive. Before you proceed, back up all files on the hard drive.

Steps

1. Run the appropriate diagnostic test. For more information, see [Using System Diagnostics](#). Depending on the results of the diagnostics test, proceed as needed through the following steps.
2. If your system has a RAID controller and your hard drives are configured in a RAID array, perform the following steps:
 - a. Restart the system and press <F10> during system startup to run the Lifecycle Controller, and then run the Hardware Configuration wizard to check the RAID configuration.
See the Lifecycle Controller documentation or online help for information on RAID configuration.
 - b. Ensure that the hard drive(s) are configured correctly for the RAID array.
 - c. Take the hard drive offline and reseat the drive.

- d. Exit the configuration utility and allow the system to boot to the operating system.
3. Ensure that the required device drivers for your controller card are installed and are configured correctly. See the operating system documentation for more information.
4. Restart the system and enter the System Setup.
5. Verify that the controller is enabled and the drives are displayed in the System Setup.

Next steps

If the problem persists, try troubleshooting the expansion cards or see [Getting Help](#).

Troubleshooting a storage controller

 **CAUTION:** Many repairs may only be done by a certified service technician. You should only perform troubleshooting and simple repairs as authorized in your product documentation, or as directed by the online or telephone service and support team. Damage due to servicing that is not authorized by Dell is not covered by your warranty. Read and follow the safety instructions that came with the product.

 **NOTE:** When troubleshooting a SAS or PERC controller, see the documentation for your operating system and the controller.

1. Run the appropriate diagnostic test. For more information, see [Using system diagnostics](#).
2. Turn off the system and attached peripherals, and disconnect the system from the electrical outlet.
3. Remove the system cover.
4. Verify that the installed expansion cards are compliant with the expansion card installation guidelines.
5. Ensure that each expansion card is firmly seated in its connector.
6. Install the system cover.
7. Reconnect the system to the electrical outlet, and turn on the system and attached peripherals.
8. If the problem is not resolved, turn off the system and attached peripherals, and disconnect the system from the electrical outlet.
9. Remove the system cover.
10. Remove all expansion cards installed in the system.
11. Install the system cover.
12. Reconnect the system to the electrical outlet, and turn on the system and attached peripherals.
13. Run the appropriate diagnostic test. For more information, see [Using system diagnostics](#). If the tests fail, see [Getting Help](#).
14. For each expansion card you removed in step 10, perform the following steps:
 - a. Turn off the system and attached peripherals, and disconnect the system from the electrical outlet.
 - b. Remove the system cover.
 - c. Reinstall one of the expansion cards.
 - d. Install the system cover.
 - e. Run the appropriate diagnostic test. For more information, see [Using system diagnostics](#).

If the tests fail, see [Getting Help](#).

Troubleshooting expansion cards

Prerequisites

 **CAUTION:** Many repairs may only be done by a certified service technician. You should only perform troubleshooting and simple repairs as authorized in your product documentation, or as directed by the online or telephone service and support team. Damage due to servicing that is not authorized by Dell is not covered by your warranty. Read and follow the safety instructions that came with the product.

 **NOTE:** When troubleshooting an expansion card, see the documentation for your operating system and the expansion card.

Steps

1. Run the appropriate diagnostic test. For more information, see [Using system diagnostics](#).
2. Turn off the system and attached peripherals, and disconnect the system from the electrical outlet.
3. Remove the system cover.
4. Ensure that each expansion card is firmly seated in its connector.
5. Install the system cover.
6. If the problem is not resolved, turn off the system and attached peripherals, and disconnect the system from the electrical outlet.
7. Remove the system cover.
8. Remove all expansion cards installed in the system.
9. Install the system cover.
If the tests fail, see [Getting Help](#).
10. For each expansion card you removed in step 8, perform the following steps:
 - a. Turn off the system and attached peripherals, and disconnect the system from the electrical outlet.
 - b. Remove the system cover.
 - c. Reinstall one of the expansion cards.
 - d. Install the system cover.
 - e. Run the appropriate diagnostic test. For more information, see [Using system diagnostics](#).

Next steps

If the problem persists, see [Getting Help](#).

Troubleshooting processors

Prerequisites

 **CAUTION:** Many repairs may only be done by a certified service technician. You should only perform troubleshooting and simple repairs as authorized in your product documentation, or as directed by the online or telephone service and support team. Damage due to servicing that is not authorized by Dell is not covered by your warranty. Read and follow the safety instructions that came with the product.

Steps

1. Run the appropriate diagnostics test. See [Using system diagnostics](#) for available diagnostic tests.
2. Turn off the system and attached peripherals, and disconnect the system from the electrical outlet.
3. Remove the system cover.
4. Ensure that the processor and heat sink are properly installed.
5. Install the system cover.
6. Run the appropriate diagnostic test. For more information, see [Using system diagnostics](#).

Next steps

If the problem persists, see [Getting Help](#).

Using system diagnostics

If you experience a problem with your system, run the system diagnostics before contacting Dell for technical assistance. The purpose of running system diagnostics is to test your system hardware without requiring additional equipment or risking data loss. If you are unable to fix the problem yourself, service and support personnel can use the diagnostics results to help you solve the problem.

Dell embedded system diagnostics

 **NOTE:** The Dell Embedded System Diagnostics is also known as Enhanced Pre-boot System Assessment (ePSA) diagnostics.

The embedded system diagnostics provides a set of options for particular device groups or devices allowing you to:

- Run tests automatically or in an interactive mode
- Repeat tests
- Display or save test results
- Run thorough tests to introduce additional test options to provide extra information about the failed device(s)
- View status messages that inform you if tests are completed successfully
- View error messages that inform you of problems encountered during testing

When to use the embedded system diagnostics

If a major component or device in the system does not operate properly, running the embedded system diagnostics may indicate component failure.

Running the Embedded System Diagnostics from Boot Manager

1. As the system boots, press **<F11>**.
2. Use the up and down arrow keys to select **System Utilities** → **Launch Diagnostics**.
The **ePSA Pre-boot System Assessment** window is displayed, listing all devices detected in the system. The diagnostics starts executing the tests on all the detected devices.

Running the Embedded System Diagnostics from the Dell Lifecycle Controller

1. As the system boots, press <F11>.
2. Select **Hardware Diagnostics** → **Run Hardware Diagnostics**.
The **ePSA Pre-boot System Assessment** window is displayed, listing all devices detected in the system. The diagnostics starts executing the tests on all the detected devices.

System diagnostic controls

Menu	Description
Configuration	Displays the configuration and status information of all detected devices.
Results	Displays the results of all tests that are executed.
System health	Provides the current overview of the system performance.
Event log	Displays system event log entries. This is displayed if the diagnostics detect a supported log type.





For information about embedded system diagnostics, see the *ePSA Diagnostics Guide (Notebooks, Desktops and Servers)* at Dell.com/support/home.

Jumpers and connectors

System board jumper settings

For information about resetting the password jumper to disable a password, see [Disabling a forgotten password](#).

Table 5. System board jumper settings

Jumper	Setting	Description
PWRD_EN	 2 4 6 (default)	The password reset feature is enabled (pins 2–4).
	 2 4 6	The password reset feature is disabled (pins 4–6). The iDRAC local access is unlocked at the next AC power cycle.
NVRAM_CLR	 1 3 5 (default)	The configuration settings are retained at the next system boot (pins 3–5).
	 1 3 5	The configuration settings are cleared at system boot (pins 1–3).

System board connectors

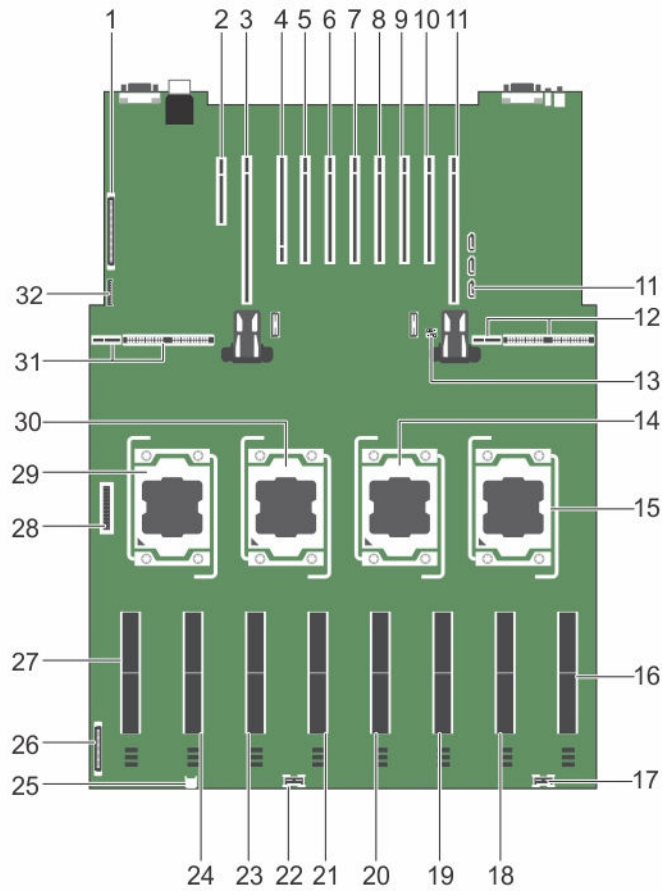

Figure 56. System board jumpers and connectors

Item	Connector	Description
1	CONTROL PANEL	Control panel connector
2	INT_STORAGE/ J_PERC	Integrated storage controller card connector
3	J_PCIE_SLOT1	Left I/O riser connector (optional)
4	IO_RISER1/J_NDC_RISER	NDC riser connector
5	J_PCIE_SLOT3	
6	J_PCIE_SLOT4	
7	J_PCIE_SLOT5	Expansion-card connectors
8	J_PCIE_SLOT6	
9	J_PCIE_SLOT7	

Item	Connector	Description
10	J_PCIE_SLOT8	
11	J_PCIE_SLOT9	
11	SATA_A	SATA A connector
12	J_PDBR_SIG	Right power distribution board connector
13	J_PW_NVRAM	Jumpers
14	CPU3	Processor 3
15	CPU4	Processor 4
16	MEMORY RISER H	Memory Riser connector
17	J_BP_PWR_B	Backplane power connector B
18	MEMORY RISER G	
19	MEMORY RISER F	
20	MEMORY RISER E	Memory Riser connectors
21	MEMORY RISER D	
22	J_BP_PWR_A	Backplane power connector A
23	MEMORY RISER C	
24	MEMORY RISER B	Memory Riser connectors
25	J_SATA_PWR_A	Optical drive SATA power connector
26	J_BP_PWR_MISC	Backplane power connector
27	MEMORY RISER A	Memory Riser connector
28	J_FAN_MOD1	Fan tray connector
29	CPU1	Processor socket 1
30	CPU2	Processor socket 2
31	J_PDBL_SIG	Left power distribution board connector
32	J_USB_CNTRL_PNL	USB control panel connector

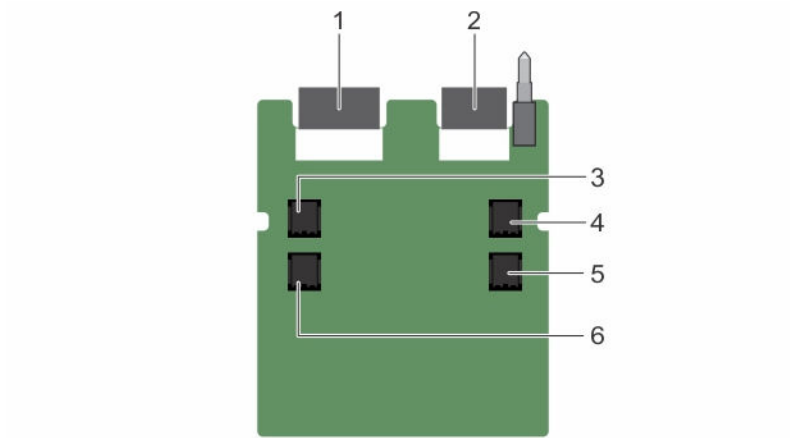

Figure 57. Expander daughter card board jumpers and connectors (unified mode)

Item	Connector	Description
1	J_XCEDE_SAS1	SAS 1 connector
2	J_XCEDE_SAS2	SAS 2 connector
3	J_SAS_A	SAS A connector
4	J_SAS_B	SAS B connector
5	J_SAS_B1	SAS B1 connector
6	J_SAS_A1	SAS A1 connector

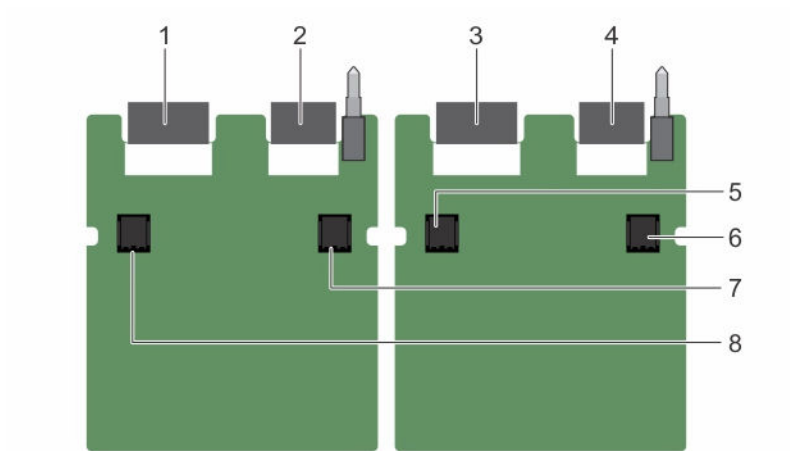

Figure 58. Expander daughter card board jumpers and connectors (performance mode)

Item	Connector	Description
1	J_XCEDE_SAS1	SAS 1 connector
2	J_XCEDE_SAS2	SAS 2 connector
3	J_XCEDE_SAS1	SAS 1 connector

Item	Connector	Description
4	J_XCEDE_SAS2	SAS 2 connector
5	J_SAS_A	SAS A connector
6	J_SAS_B	SAS B connector
7	J_SAS_B	SAS B connector
8	J_SAS_A	SAS A connector

Disabling a forgotten password

The system's software security features include a system password and a setup password. The password jumper enables these password features or disables them and clears any password(s) currently in use.

Prerequisites



CAUTION: Many repairs may only be done by a certified service technician. You should only perform troubleshooting and simple repairs as authorized in your product documentation, or as directed by the online or telephone service and support team. Damage due to servicing that is not authorized by Dell is not covered by your warranty. Read and follow the safety instructions that came with the product.

Steps

1. Turn off the system, including any attached peripherals, and disconnect the system from the electrical outlet.
2. Remove the system cover.
3. Move the jumper on the system board jumper from pins 4 and 6 to pins 2 and 4.
4. Install the system cover.



The existing passwords are not disabled (erased) until the system boots with the jumper on pins 2 and 4. However, before you assign a new system and/or setup password, you must move the jumper back to pins 4 and 6.



NOTE: If you assign a new system and/or setup password with the jumper on pins 2 and 4, the system disables the new password(s) the next time it boots.

5. Reconnect the system to its electrical outlet and turn the system on, including any attached peripherals.
6. Turn off the system, including any attached peripherals, and disconnect the system from the electrical outlet.
7. Remove the system cover.
8. Move the jumper on the system board jumper from pins 2 and 4 to pins 4 and 6.
9. Install the system cover.
10. Reconnect the system to its electrical outlet and turn the system on, including any attached peripherals.
11. Assign a new system and/or setup password.

Technical specifications

Physical	
Height	172.6 mm (6.8 inch)
Width	
With rack latches	482.4 mm (18.99 inch)
Without rack latches	422 mm (16.61 inch)
Depth	
With bezel	802.3 mm (31.59 inch)
Without bezel	787.7 mm (31.01 inch)
Weight (maximum)	59 kg (130.07 lb)
Weight (empty)	23.8 kg (52.47 lb)
Processor	
Processor type	Two or four Intel E7-8800/4800 v3 product family
Power	
AC power supply Unit (per power supply)	
Wattage	750 W or 1100 W
Heat dissipation	2891 BTU/hr maximum (750 W power supply)
 NOTE: Heat dissipation is calculated using the power supply unit wattage rating.	4100 BTU/hr maximum (1100 W power supply)
Voltage	100–240 V AC, autoranging, 50/60 Hz
 NOTE: This system is also designed to be connected to IT power systems with a phase to phase voltage not exceeding 230 V.	
Battery	
Coin-cell battery	3 V CR2032 Lithium coin cell

Expansion Bus

Bus type	PCI Express Generation 3
Expansion slots using riser card:	
Riser 1 (NDC riser default)	(Slot 2) One full-height, half-length x8 link
Riser 2 (optional)	(Slot 1/1) One full-height, full-length x4 link (Slot 2/2) One full-height, half-length x4 link (Slot 3) One full-height, half-length x8 link (Slot 4) One full-height, full-length x16 link  NOTE: To use slots 6 through 10, all four processors must be installed. (Slot 5) One full-height, half-length x16 link (Slot 6) One full-height, half-length x16 link (Slot 7) One full-height, half-length x16 link (Slot 8) One full-height, half-length x16 link Riser 3 (optional) (Slot 1/ 9) One full-height, full-length x8 link (Slot 2/ 10) One half-height, half-length x8 link

 **NOTE:** Do not install a full-height expansion card on PCIe slot 2/10.

Memory





Architecture	1333 MT/s, 1600 MT/s or 1866 MT/s DDR4 registered, load-reduced Error Correcting Code (ECC) DIMMs Support for advanced ECC or memory optimized operation
Memory module sockets	Ninety-six 240-pin
Memory module capacities	
LRDIMMs	32 GB quad-rank

Memory

RDIMMs	8 GB, or 32 GB single-, dual-, or quad-rank
Minimum RAM	32 GB with dual processor with 4 memory risers 64 GB with quad processor with 8 memory risers
Maximum RAM	1.5 TB with dual processor with 4 memory risers 3 TB with quad processor with 8 memory risers

Drives

Hard drives

Four hard drive systems	Up to four 2.5 inch, internal, hot-swappable SAS hard drives in hard drive slots 0 through 3. This configuration supports: <ul style="list-style-type: none">• 6 Gbps and 12 Gbps I/O operations on SAS drives.• 6 Gbps on SATA drives.
Twenty four hard drive systems (SAS/SATA)	Up to twenty four 2.5 inch, internal, hot-swappable SAS/SATA hard drives. This configuration supports: <ul style="list-style-type: none">• 6 Gbps and 12 Gbps I/O operations on SAS drives.• 6 Gbps on SATA drives. <p> NOTE: With a single <i>Unified mode</i> daughter card and PERC 9 card the hard drives are located in hard drive slots 0 through 24 (bay 1).</p> <p> NOTE: With two <i>Performance mode</i> daughter cards and two PERC 9 cards the hard drives are located in hard drive slots 0 through 11 (bay 1) and 0 through 11 (bay 2)</p>
Twenty four or sixteen plus eight hard drive systems	Up to sixteen 2.5 inch, internal, hot-swappable SAS drives and up to eight Dell PowerEdge Express Flash devices (PCIe SSDs) hard drives in hard drive slots 0 through 4 (bay 1), 0 through 4 (bay 2), and 0 through 15 (bay 3) for SAS/SATA with 2 PCIe Extender Cards, one Unified Mode Daughter Card, and one PERC 9 Card. <p> NOTE: Performance mode daughter cards (hard drive slots 0 through 7 on SAS/SATA) are not supported.</p>
Twenty four hard drive systems (SAS-3 (12 Gbps)) Performance Mode (split-capable)	Up to twenty four 2.5 inch, internal, hot-swappable SAS hard drives. <p> NOTE: When the backplane is NOT in the split mode with single internal PERC, the maximum number of SATA/SSDs are 12 in the right bay (hard drives slots 12 through 23).</p>

Drives

Twenty four or sixteen plus eight hard drive systems (SATA SSD)	Up to sixteen 2.5 inch, internal, hot-swappable SATA drives and up to eight Dell PowerEdge Express Flash devices (PCIe SSDs) hard drives in hard drive slots 0 through 4 (bay 1), 0 through 4 (bay 2), and 8 through 15 (bay 3) for SAS/SATA.
Optical drive	One optional SATA DVD-ROM drive or DVD+/-RW drive.

Connectors

Back

NIC	Four RJ-45 10/100/1000 Mbps Ethernet
Serial	9-pin, DTE, 16550-compatible
USB	Two 4-pin, USB 2.0-compliant
Video	15-pin VGA
iDRAC8	One RJ-45 10/100/1000 Mbps Ethernet

Front

USB	Two 4-pin, USB 2.0-compliant
Video	15-pin VGA
External vFlash card	vFlash memory card slot



NOTE: The card slot is available for use only if the iDRAC8 Enterprise license is installed on your system.

Internal

USB	One 4-pin, USB 2.0-compliant
Internal Dual SD Module	Two optional flash memory card slots with the internal SD module



NOTE: One card slot is dedicated for redundancy.

Video

Video type	Integrated Matrox G200 with iDRAC8
Video memory	16 MB shared with iDRAC8 application memory

Expanded Operating Temperature



NOTE: When operating in the expanded temperature range, system performance may be impacted.

Expanded Operating Temperature

 **NOTE:** When operating in the expanded temperature range, ambient temperature warnings may be reported on the LCD and in the System Event Log.

≤ 10% of annual operating hours

5°C to 40°C at 5% to 85% RH with 26°C dew point.

 **NOTE:** Outside the standard operating temperature (10°C to 35°C), the system can operate down to 5°C or up to 40°C for a maximum of 10% of its annual operating hours.

For temperatures between 35°C and 40°C, de-rate maximum allowable dry bulb temperature by 1°C per 175 m above 950 m (1°F per 319 ft).

≤ 1% of annual operating hours

–5°C to 45°C at 5% to 90% RH with 26°C dew point.

 **NOTE:** Outside the standard operating temperature (10°C to 35°C), the system can operate down to –5°C or up to 45°C for a maximum of 1% of its annual operating hours.

For temperatures between 40°C and 45°C, de-rate maximum allowable dry bulb temperature by 1°C per 125 m above 950 m (1°F per 228 ft).

Expanded operating temperature restrictions

- Do not perform a cold startup below 5°C.
- The operating temperature specified is for a maximum altitude of 3050 m (10,000 ft).
- 130 W (4 core) processor is not supported.
- Redundant power supply units are required.
- Non Dell qualified peripheral cards and/or peripheral cards greater than 25 W are not supported.

 **NOTE:** Your system is capable of 40°C and 45°C excursion operation for fresh air cooled data centers.

 **NOTE:** For additional information about environmental measurements for specific system configurations, see Dell.com/environmental_datasheets.



Temperature

Maximum temperature gradient (operating and storage) 20°C/h (36°F/h)

Storage temperature limits –40°C to 65°C (–40°F to 149°F)

Temperature (Continuous Operation)

Temperature ranges (for altitude less than 950 m or 3117 ft) 10°C to 35°C (50°F to 95°F) with no direct sunlight on the equipment.

Humidity percentage range	10% to 80% Relative Humidity with 26°C (78.8°F) maximum dew point.
Relative Humidity	
Storage	5% to 95% RH with 33°C (91°F) maximum dew point. Atmosphere must be non-condensing at all times.
Maximum Vibration	
Operating	0.26 G _{rms} at 5 Hz to 350 Hz (all operation orientations).
Storage	1.87 G _{rms} at 10 Hz to 500 Hz for 15 min (all six sides tested).
Maximum Shock	
Operating	One shock pulse in the positive z axis of 40 G for 2.3 ms in all operational orientations.
Storage	Six consecutively executed shock pulses in the positive and negative x, y, and z axes (one pulse on each side of the system) of 71 G for up to 2 ms.
Maximum Altitude	
Operating	3048 m (10,000 ft).
Storage	12,000 m (39,370 ft).
Operating Altitude De-rating	
Up to 35°C (95°F)	Maximum temperature is reduced by 1°C/300 m (1°F/547 ft) above 950 m (3,117 ft).
35°C to 40°C (95°F to 104°F)	Maximum temperature is reduced by 1°C/175 m (1°F/319 ft) above 950 m (3,117 ft).
40°C to 45°C (104°F to 113°F)	Maximum temperature is reduced by 1°C/125 m (1°F/228 ft) above 950 m (3,117 ft).
Particulate Contamination	
 NOTE: This section defines the limits to help avoid IT equipment damage and/or failure from particulates and gaseous contamination. If it is determined that levels of particulates or gaseous pollution are beyond the limits specified below and are the reason for the damage and/or failures to your equipment, it may be necessary for you to re-mediate the environmental conditions that are causing the damage and/or failures. Re-mediation of environmental conditions will be the responsibility of the customer.	
Air Filtration	Data center air filtration as defined by ISO Class 8 per ISO 14644-1 with a 95% upper confidence limit.
	 NOTE: Air entering the data center must have MERV11 or MERV13 filtration.

 **NOTE:** Applies to data center environments only. Air filtration requirements do not apply to IT equipment designed to be used outside a data center, in environments such as an office or factory floor.

Conductive Dust

Air must be free of conductive dust, zinc whiskers, or other conductive particles.

 **NOTE:** Applies to data center and non-data center environments.

Corrosive Dust

- Air must be free of corrosive dust.
- Residual dust present in the air must have a deliquescent point less than 60% relative humidity.

 **NOTE:** Applies to data center and non-data center environments.

Gaseous Contamination

 **NOTE:** Maximum corrosive contaminant levels measured at $\leq 50\%$ relative humidity.

Copper Coupon Corrosion Rate

<300 Å/month per Class G1 as defined by ANSI/ISA71.04-1985.

Silver Coupon Corrosion Rate

<200 Å/month as defined by AHSRAE TC9.9.

Getting help

Contacting Dell

Dell provides several online and telephone-based support and service options. If you do not have an active Internet connection, you can find contact information on your purchase invoice, packing slip, bill, or Dell product catalog. Availability varies by country and product, and some services may not be available in your area. To contact Dell for sales, technical support, or customer-service issues:

1. Go to **Dell.com/support**.
2. Select your country from the drop-down menu on the bottom right corner of the page.
3. For customized support:
 - a. Enter your system Service Tag in the **Enter your Service Tag** field.
 - b. Click **Submit**.
4. For general support:
 - a. Select your product category.
 - b. Select your product segment.
 - c. Select your product.

The support page that lists the various support categories is displayed.

The support page that lists the various support categories is displayed.

Locating your system Service Tag

Your system is identified by a unique Express Service Code and Service Tag number. The Express Service Code and Service Tag are found on the front of the system by pulling out the information tag. Alternatively, the information may be on a sticker on the chassis of the system. This information is used by Dell to route support calls to the appropriate personnel.

Quick Resource Locator (QRL)

Use the Quick Resource Locator (QRL) to get immediate access to system information and how-to videos. This can be done by visiting **Dell.com/QRL** or by using your smartphone or tablet and a model specific Quick Resource (QR) code located on your Dell PowerEdge system. To try out the QR code, scan the following image.



Quick Resource Locator



www.dell.com/QRL/Server/PER930

Free Manuals Download Website

<http://myh66.com>

<http://usermanuals.us>

<http://www.somanuals.com>

<http://www.4manuals.cc>

<http://www.manual-lib.com>

<http://www.404manual.com>

<http://www.luxmanual.com>

<http://aubethermostatmanual.com>

Golf course search by state

<http://golfingnear.com>

Email search by domain

<http://emailbydomain.com>

Auto manuals search

<http://auto.somanuals.com>

TV manuals search

<http://tv.somanuals.com>