


# Dell EMC PowerEdge T150

## Installation and Service Manual

## Notes, cautions, and warnings

 **NOTE:** A NOTE indicates important information that helps you make better use of your product.

 **CAUTION:** A CAUTION indicates either potential damage to hardware or loss of data and tells you how to avoid the problem.

 **WARNING:** A WARNING indicates a potential for property damage, personal injury, or death.

<b>Chapter 1: About this document</b> .....	<b>6</b>
<b>Chapter 2: PowerEdge T150 system overview</b> .....	<b>7</b>
Front view of the system.....	8
Rear view of the system.....	10
Inside the system .....	12
Locating the Express Service Code and Service Tag.....	12
System information label.....	12
<b>Chapter 3: Initial system setup and configuration</b> .....	<b>15</b>
Setting up the system.....	15
iDRAC configuration.....	15
Options to set up iDRAC IP address.....	15
Options to log in to iDRAC.....	16
Resources to install operating system.....	17
Options to download firmware .....	17
Options to download and install OS drivers .....	17
Downloading drivers and firmware.....	18
<b>Chapter 4: Minimum to POST and system management configuration validation</b> .....	<b>19</b>
Minimum configuration to POST .....	19
Configuration validation.....	19
Error messages.....	20
<b>Chapter 5: Installing and removing system components</b> .....	<b>21</b>
Safety instructions.....	21
Before working inside your system.....	22
After working inside your system.....	22
Recommended tools.....	22
System cover.....	22
Removing the system cover.....	22
Installing the system cover.....	23
Frontbezel.....	24
Removing the front bezel.....	24
Installing the front bezel.....	25
Drives.....	26
Removing a 3.5-inch drive carrier from the drive bay.....	26
Installing a 3.5-inch drive carrier into the drive bay.....	27
Removing a drive from the drive carrier.....	28
Installing a drive into the drive carrier.....	29
Removing a 2.5-inch drive from the 3.5-inch drive adapter.....	30
Installing a 2.5-inch drive into the 3.5-inch drive adapter.....	31
Removing a 3.5-inch drive adapter from a 3.5-inch drive carrier.....	32
Installing a 3.5-inch adapter into a 3.5-inch drive carrier.....	33

Setting the cooling fan speed for 8 TB drives.....	33
Cable routing.....	34
Optional optical drive.....	35
Removing the optical drive fillers.....	35
Installing the optical drive fillers.....	36
Removing the optical drive.....	37
Installing the optical drive.....	38
System memory.....	39
System memory guidelines.....	39
General memory module installation guidelines.....	40
Removing a memory module.....	41
Installing a memory module.....	42
Cooling fans.....	43
Removing a cooling fan.....	43
Installing a cooling fan.....	44
Internal USB memory key.....	45
Removing the optional internal USB memory key.....	45
Installing the internal USB memory key .....	46
Expansion cards.....	47
Expansion card installation guidelines.....	47
Removing a PCIe expansion card.....	48
Installing a PCIe expansion card.....	49
Optional BOSS S1 card.....	51
Removing the M.2 SSD module.....	51
Installing the M.2 SSD module.....	52
Processor and heat sink .....	52
Removing the heat sink.....	52
Removing the processor.....	53
Installing the processor.....	54
Installing the heat sink.....	55
Power supply unit.....	57
Removing the power supply unit.....	57
Installing the power supply unit.....	58
System battery .....	58
Replacing the system battery.....	58
Intrusion switch .....	60
Removing the intrusion switch.....	60
Installing the intrusion switch.....	61
System board.....	61
Removing the system board.....	61
Installing the system board.....	63
Trusted Platform Module.....	67
Upgrading the Trusted Platform Module.....	67
Initializing TPM for users.....	68
Initializing the TPM 1.2 for users.....	68
Initializing the TPM 2.0 for users.....	68
Control panel.....	68
Removing the control panel cage.....	68
Removing the control panel.....	69
Installing the control panel.....	70

Installing the control panel cage.....	71
<b>Chapter 6: Jumpers and connectors.....</b>	<b>72</b>
System board connectors.....	72
System board jumper settings.....	73
Disabling a forgotten password.....	74
<b>Chapter 7: System diagnostics and indicator codes.....</b>	<b>75</b>
System health and system ID indicator codes.....	75
iDRAC Direct LED indicator codes.....	75
NIC indicator codes.....	76
Non-redundant cabled power supply unit indicator codes.....	76
Using system diagnostics.....	77
Dell Embedded System Diagnostics.....	77
<b>Chapter 8: Getting help.....</b>	<b>79</b>
Recycling or End-of-Life service information.....	79
Contacting Dell Technologies.....	79
Accessing system information by using QRL.....	79
Quick Resource Locator for PowerEdge T150 system.....	80
Receiving automated support with SupportAssist .....	80
<b>Chapter 9: Documentation resources.....</b>	<b>82</b>


# About this document

This document provides an overview about the system, information about installing and replacing components, diagnostic tools, and guidelines to be followed while installing certain components.


# PowerEdge T150 system overview

The PowerEdge T150 system is a 4U mini tower server that supports:

- one Intel® Xeon® E-2300 series processor with up to 8 cores per processor
- Four DDR4 DIMM slots, supports UDIMM 128GB max, speeds up to 3200 MT/s
- Cabled AC power supply unit
- Up to 4 x 3.5-inch SAS/SATA HDD/SSD drives

 **NOTE:** All instances of SAS or SATA drives are seen as drives in this document, unless specified otherwise.

 **NOTE:** For more information, see the *Dell EMC PowerEdge T150 Technical Specifications* on the product documentation page.

 **CAUTION:** Do not install GPUs, network cards, or other PCIe devices on your system that are not validated and tested by Dell. Damage caused by unauthorized and invalidated hardware installation will null and void the system warranty.

## Topics:

- [Front view of the system](#)
- [Rear view of the system](#)
- [Inside the system](#)
- [Locating the Express Service Code and Service Tag](#)
- [System information label](#)

# Front view of the system

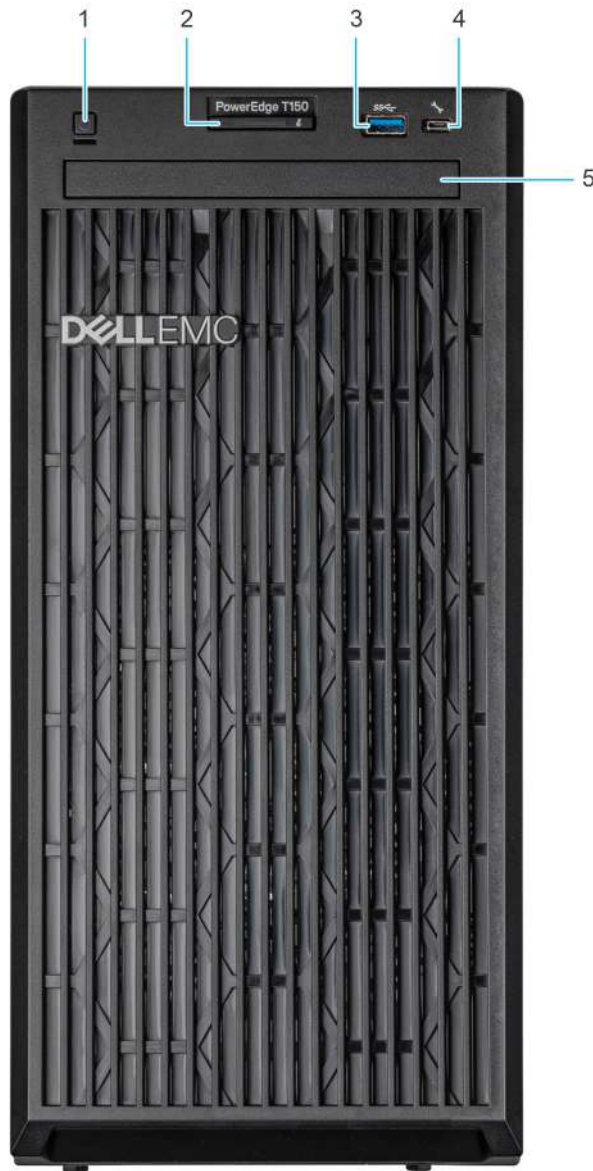






Figure 1. Front view of the system

Table 1. Features available on the front of the system

Item	Ports, panels, and slots	Icon	Description
1	Power button		Indicates if the system is powered on or off. Press the power button to manually power on or off the system. <b>NOTE:</b> Press the power button to gracefully shut down an ACPI-compliant operating system.
2	System health and ID indicator		Indicates the status of the system. For more information, see the <a href="#">System health and system ID indicator codes</a> section.
3	USB 3.0 port		The USB ports are 4-pin, 2.0-compliant. These ports enable you to connect USB devices to the system.



**Table 1. Features available on the front of the system (continued)**

Item	Ports, panels, and slots	Icon	Description
4	iDRAC Direct port (Micro-AB USB)		<p>The iDRAC Direct port (Micro-AB USB) enables you to access the iDRAC direct Micro-AB USB features. For more information, see the <a href="https://www.dell.com/idracmanuals">https://www.dell.com/idracmanuals</a>.</p> <p><b>NOTE:</b> You can configure iDRAC Direct by using a USB to micro USB (type AB) cable, which you can connect to your laptop or tablet. Cable length should not exceed 3 feet (0.91 meters). Performance could be affected by cable quality.</p>
5	Optical drive (optional)	N/A	One optional slim SATA DVD-ROM drive or DVD+/-RW drive.

**NOTE:** For more information, see the *Dell EMC PowerEdge T150 Technical Specifications* on the product documentation page.

# Rear view of the system

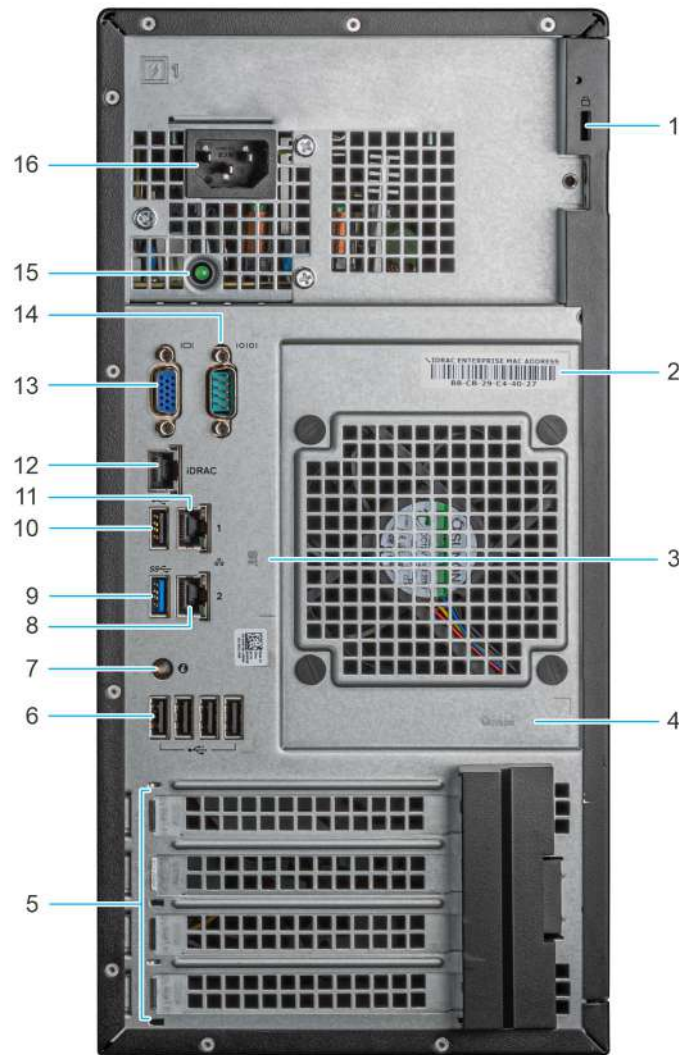











Figure 2. Rear view of the system

Table 2. Rear view of the system

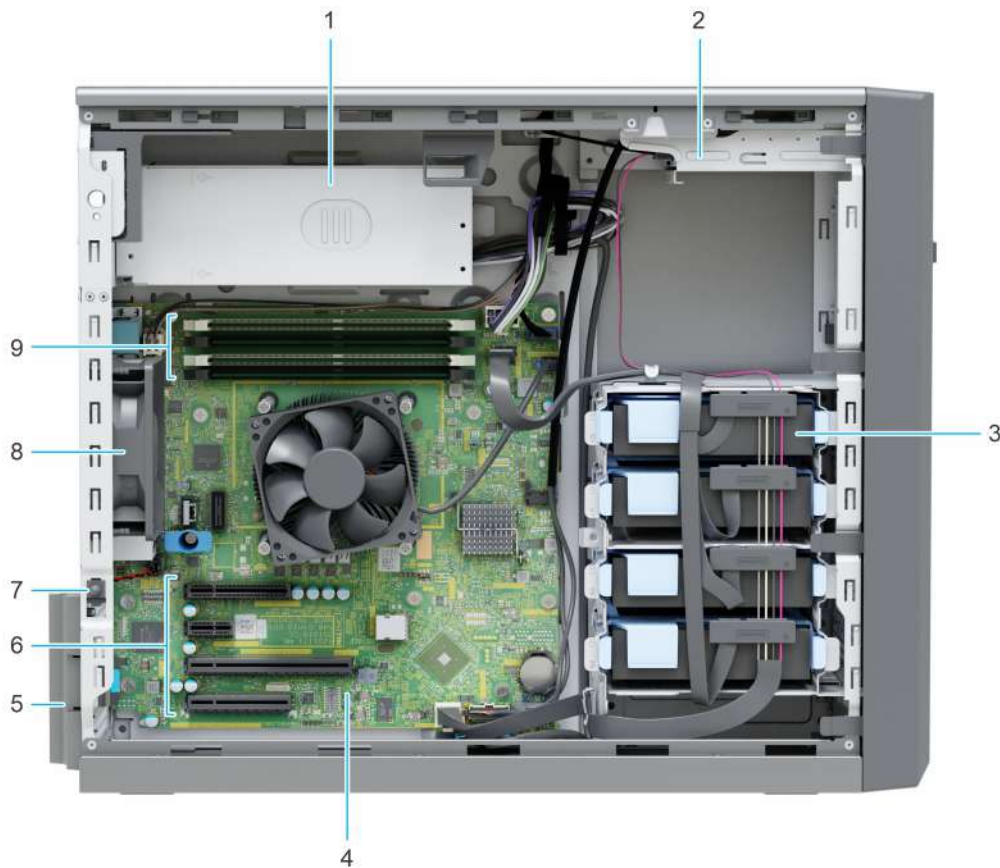
Item	Ports, panels, or slots	Icon	Descriptions
1	Security cable lock	N/A	Enables you to connect to the security cable lock.
2	iDRAC MAC address and iDRAC secure password label	N/A	Indicates the iDRAC MAC address and iDRAC secure password label.
3	Service Tag, Express Service Code, QRL label	N/A	Indicates the Service Tag, Express Service Code, QRL label.
4	OpenManage Mobile (OMM) label	N/A	Indicates the OpenManage Mobile (OMM) label.
5	PCIe expansion card slots (4)	N/A	Enables you to connect PCI Express expansion cards.

**Table 2. Rear view of the system (continued)**

Item	Ports, panels, or slots	Icon	Descriptions
6	USB 2.0 port (4)		The USB ports are 4-pin, 2.0-compliant. These ports enable you to connect USB devices to the system.
7	System identification button		<p>Press the system ID button:</p> <ul style="list-style-type: none"> <li>To locate a particular system within a rack.</li> <li>To turn the system ID on or off.</li> </ul> <p>To reset iDRAC, press and hold the button for 16 seconds.</p> <p><b>NOTE:</b></p> <ul style="list-style-type: none"> <li>To reset iDRAC using system ID, ensure that the system ID button is enabled in the iDRAC setup.</li> <li>If the system stops responding during POST, press and hold the system ID button (for more than five seconds) to enter the BIOS progress mode.</li> </ul>
8	NIC ports (2)		The NIC ports that are integrated on the system board provide network connectivity. These NIC ports can also be shared with iDRAC when iDRAC network settings are set to shared mode.
9	USB 3.0 port		The USB ports are 9-pin, 3.0-compliant. These ports enable you to connect USB devices to the system.
10	USB 2.0 port		The USB ports are 4-pin, 2.0-compliant. These ports enable you to connect USB devices to the system.
11	NIC ports (1)		The NIC ports that are integrated on the system board provide network connectivity. These NIC ports can also be shared with iDRAC when iDRAC network settings is set to shared mode.
12	iDRAC ethernet port		Enables you to remotely access iDRAC. For more information, see the <i>Integrated Dell Remote Access Controller User's Guide</i> at <a href="http://www.dell.com/poweredgemanuals">www.dell.com/poweredgemanuals</a> .
13	VGA port		Enables you to connect a display device to the system.
14	Serial port		Enables you to connect a serial device to the system.
15	PSU Built-in Self-Test (BIST) LED	N/A	Enables you to check the power supply to the PSU.
16	Power supply unit plug	N/A	Enables you to install cabled AC PSU.

**NOTE:** For more information, see the *Dell EMC PowerEdge T150 Technical Specifications* on the product documentation page.

## Inside the system



**Figure 3. Inside the system**

- |                                   |                                  |
|-----------------------------------|----------------------------------|
| 1. Cabled Power Supply Unit (PSU) | 2. Optical drive                 |
| 3. Cabled drives (4)              | 4. System board                  |
| 5. Expansion card retention latch | 6. PCIe expansion card slots (4) |
| 7. Intrusion switch               | 8. Fan                           |
| 9. Memory module sockets          |                                  |

## Locating the Express Service Code and Service Tag

The unique Express Service Code and Service Tag are used to identify the system.

The Express Service Code and Service Tag are found on a sticker on the rear of the system. If you have opted for the secure default access to iDRAC, the Information tag also contains the iDRAC secure default password.

Alternatively, the Service Tag information is located on a label on the rear of the chassis.

## System information label

The system information label is located on the back of the system cover.

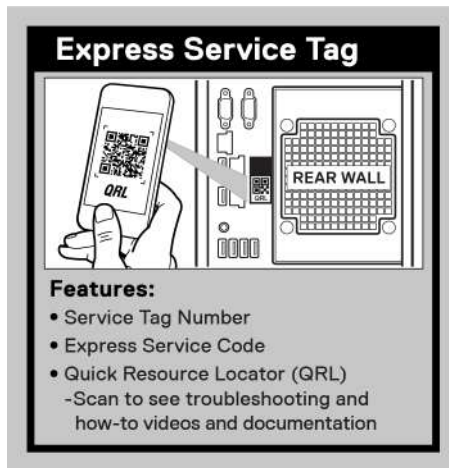


Figure 4. Express Service Tag

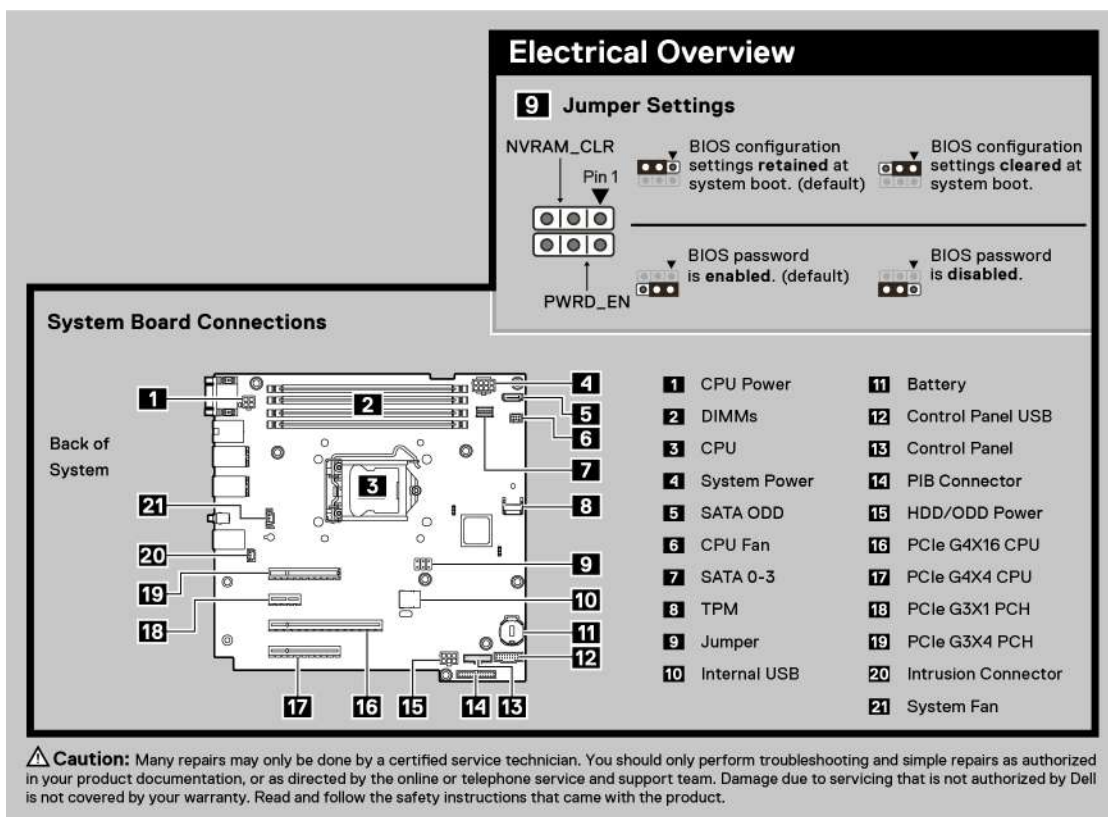


Figure 5. Electrical overview and system board connections

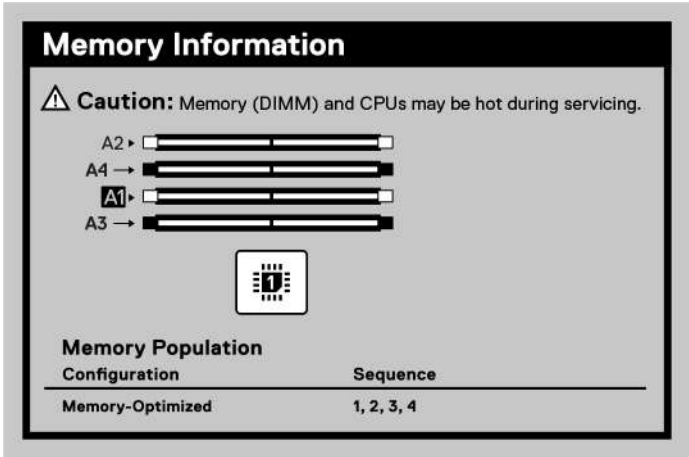


Figure 6. Memory information



Figure 7. Quick Resource Locator

# Initial system setup and configuration

This section describes the tasks for initial setup and configuration of the Dell EMC system. The section also provides general steps to set up the system and the reference guides for detailed information.

## Topics:

- [Setting up the system](#)
- [iDRAC configuration](#)
- [Resources to install operating system](#)

## Setting up the system

Perform the following steps to set up the system:

### Steps

1. Unpack the system.
2. Connect the peripherals to the system and the system to the electrical outlet.
3. Power on the system.

For more information about setting up the system, see the *Getting Started Guide* that is shipped with your system.

**i** **NOTE:** For information about managing the basic settings and features of the system, see the *Dell EMC PowerEdge T150 BIOS and UEFI Reference Guide* on the product documentation page.

**i** **NOTE:** Legacy BIOS is not supported on the system, only UEFI BIOS is supported.

## iDRAC configuration

The Integrated Dell Remote Access Controller (iDRAC) is designed to make you more productive as a system administrator and improve the overall availability of Dell EMC servers. iDRAC alerts you to system issues, helps you to perform remote management, and reduces the need for physical access to the system.

### Options to set up iDRAC IP address

To enable communication between your system and iDRAC, you must first configure the network settings based on your network infrastructure. The network settings option is set to **DHCP**, by default.




**i** **NOTE:** For static IP configuration, you must request for the settings at the time of purchase.


You can set up the iDRAC IP address using one of the interfaces in the table below. For information about setting up iDRAC IP address, see the documentation links provided in the table below.

**Table 3. Interfaces to set up iDRAC IP address**

Interface	Documentation links
iDRAC Settings utility	<i>Integrated Dell Remote Access Controller User's Guide</i> at <a href="https://www.dell.com/idracmanuals">https://www.dell.com/idracmanuals</a> or for system specific <i>Integrated Dell Remote Access Controller User's Guide</i> , go to <a href="https://www.dell.com/poweredgemanuals">https://www.dell.com/poweredgemanuals</a> > <b>Product Support</b> page of your system > <b>Documentation</b> .

**Table 3. Interfaces to set up iDRAC IP address (continued)**

Interface	Documentation links
	<p> <b>NOTE:</b> To determine the most recent iDRAC release for your platform and for latest documentation version, see KB article <a href="https://www.dell.com/support/article/sln308699">https://www.dell.com/support/article/sln308699</a>.</p>
OpenManage Deployment Toolkit	<p><i>Dell EMC OpenManage Deployment Toolkit User's Guide</i> available at <a href="https://www.dell.com/openmanagemanuals">https://www.dell.com/openmanagemanuals</a> &gt; Open Manage Deployment Toolkit.</p>
iDRAC Direct	<p><i>Integrated Dell Remote Access Controller User's Guide</i> at <a href="https://www.dell.com/idracmanuals">https://www.dell.com/idracmanuals</a> or for system specific <i>Integrated Dell Remote Access Controller User's Guide</i>, go to <a href="https://www.dell.com/poweredgemanuals">https://www.dell.com/poweredgemanuals</a> &gt; <b>Product Support</b> page of your system &gt; <b>Documentation</b>.</p> <p> <b>NOTE:</b> To determine the most recent iDRAC release for your platform and for latest documentation version, see KB article <a href="https://www.dell.com/support/article/sln308699">https://www.dell.com/support/article/sln308699</a>.</p>
Lifecycle Controller	<p><i>Dell Lifecycle Controller User's Guide</i> at <a href="https://www.dell.com/idracmanuals">https://www.dell.com/idracmanuals</a> or for system specific <i>Dell Lifecycle Controller User's Guide</i>, go to <a href="https://www.dell.com/poweredgemanuals">https://www.dell.com/poweredgemanuals</a> &gt; <b>Product Support</b> page of your system &gt; <b>Documentation</b>.</p> <p> <b>NOTE:</b> To determine the most recent iDRAC release for your platform and for latest documentation version, see KB article <a href="https://www.dell.com/support/article/sln308699">https://www.dell.com/support/article/sln308699</a>.</p>

 **NOTE:** To access iDRAC, ensure that you connect the ethernet cable to the iDRAC dedicated network port or use the iDRAC Direct port by using the USB cable. You can also access iDRAC through the shared LOM mode, if you have opted for a system that has the shared LOM mode enabled.

## Options to log in to iDRAC

To log in to the iDRAC Web User Interface, open a browser and enter the IP address.


You can log in to iDRAC as:

- iDRAC user
- Microsoft Active Directory user
- Lightweight Directory Access Protocol (LDAP) user

In the login screen displayed, if you have opted for secure default access to iDRAC, enter the iDRAC secure default password available on back of the Information Tag. If you have not opted for secure default access to iDRAC, enter the default user name and password – root and calvin. You can also log in by using your Single Sign-On or Smart Card.

 **NOTE:** Ensure that you change the default username and password after setting up the iDRAC IP address.

For more information about logging in to the iDRAC and iDRAC licenses, see the latest *Integrated Dell Remote Access Controller User's Guide* at [www.dell.com/idracmanuals](http://www.dell.com/idracmanuals).

 **NOTE:** To determine the most recent iDRAC release for your platform and for latest documentation version, see KB article <https://www.dell.com/support/article/sln308699>.

You can also access iDRAC using command-line protocol - RACADM. For more information, see the *Integrated Dell Remote Access Controller RACADM CLI Guide* available at <https://www.dell.com/idracmanuals>.

You can also access iDRAC using automation tool - Redfish API. For more information, see the *Integrated Dell Remote Access Controller User's Guide Redfish API Guide* available at <https://developer.dell.com>.



## Resources to install operating system

If the system is shipped without an operating system, you can install a supported operating system by using one of the resources provided in the table below. For information about how to install the operating system, see the documentation links provided in the table below.

**Table 4. Resources to install the operating system**

Resource	Documentation links
iDRAC	<i>Integrated Dell Remote Access Controller User's Guide</i> at <a href="https://www.dell.com/idracmanuals">https://www.dell.com/idracmanuals</a> or for system specific <i>Integrated Dell Remote Access Controller User's Guide</i> , go to <a href="https://www.dell.com/poweredgemanuals">https://www.dell.com/poweredgemanuals</a> > <b>Product Support</b> page of your system > <b>Documentation</b> . ⓘ <b>NOTE:</b> To determine the most recent iDRAC release for your platform and for latest documentation version, see KB article at <a href="https://www.dell.com/support/article/sln308699">https://www.dell.com/support/article/sln308699</a> .
Lifecycle Controller	<i>Dell Lifecycle Controller User's Guide</i> at <a href="https://www.dell.com/idracmanuals">https://www.dell.com/idracmanuals</a> or for system specific <i>Dell Lifecycle Controller User's Guide</i> , go to <a href="https://www.dell.com/poweredgemanuals">https://www.dell.com/poweredgemanuals</a> > <b>Product Support</b> page of your system > <b>Documentation</b> . Dell recommends using Lifecycle Controller to install the OS, since all required drivers are installed on the system. ⓘ <b>NOTE:</b> To determine the most recent iDRAC release for your platform and for latest documentation version, see KB article at <a href="https://www.dell.com/support/article/sln308699">https://www.dell.com/support/article/sln308699</a> .
OpenManage Deployment Toolkit	<a href="http://www.dell.com/openmanagemanuals">www.dell.com/openmanagemanuals</a> > OpenManage Deployment Toolkit

ⓘ **NOTE:** For more information about installation and how-to videos for operating systems supported on PowerEdge systems, see [Supported Operating Systems for Dell EMC PowerEdge systems](#).

## Options to download firmware

You can download firmware from the Dell support site. For information about downloading firmware, see the [Downloading drivers and firmware](#) section.

You can also choose any one of the following options to download the firmware. For information about how to download the firmware, see the documentation links provided in the table below.

**Table 5. Options to download firmware**

Option	Documentation link
Using Integrated Dell Remote Access Controller Lifecycle Controller (iDRAC with LC)	<a href="http://www.dell.com/idracmanuals">www.dell.com/idracmanuals</a>
Using Dell Repository Manager (DRM)	<a href="http://www.dell.com/openmanagemanuals">www.dell.com/openmanagemanuals</a> > Repository Manager
Using Dell Server Update Utility (SUU)	<a href="http://www.dell.com/openmanagemanuals">www.dell.com/openmanagemanuals</a> > Server Update Utility
Using Dell OpenManage Deployment Toolkit (DTK)	<a href="http://www.dell.com/openmanagemanuals">www.dell.com/openmanagemanuals</a> > OpenManage Deployment Toolkit
Using iDRAC virtual media	<a href="http://www.dell.com/idracmanuals">www.dell.com/idracmanuals</a>

## Options to download and install OS drivers

You can choose any one of the following options to download and install OS drivers. For information about how to download or install OS drivers, see the documentation links provided in the table below.

**Table 6. Options to download and install OS drivers**

Option	Documentation
Dell EMC support site	<a href="#">Downloading drivers and firmware</a> section.

**Table 6. Options to download and install OS drivers (continued)**

Option	Documentation
iDRAC virtual media	<p><i>Integrated Dell Remote Access Controller User's Guide</i> at <a href="https://www.dell.com/idracmanuals">https://www.dell.com/idracmanuals</a> or for system specific <i>Integrated Dell Remote Access Controller User's Guide</i>, go to <a href="https://www.dell.com/poweredgemanuals">https://www.dell.com/poweredgemanuals</a> &gt; <b>Product Support</b> page of your system &gt; <b>Documentation</b> .</p> <p><b>NOTE:</b> To determine the most recent iDRAC release for your platform and for latest documentation version, see <a href="https://www.dell.com/support/article/sln308699">https://www.dell.com/support/article/sln308699</a>.</p>

## Downloading drivers and firmware

It is recommended that you download and install the latest BIOS, drivers, and systems management firmware on the system.

### Prerequisites

Ensure that you clear the web browser cache before downloading the drivers and firmware.

### Steps

1. Go to [www.dell.com/support/drivers](http://www.dell.com/support/drivers).
2. Enter the Service Tag of the system in the **Enter a Dell Service Tag, Dell EMC Product ID or Model** field, and then press Enter.

**NOTE:** If you do not have the Service Tag, click **Browse all products**, and navigate to your product.

3. On the displayed product page, click **Drivers & Downloads**.  
On the **Drivers & Downloads** page, all drivers that are applicable to the system are displayed.
4. Download the drivers to a USB drive, CD, or DVD.

# Minimum to POST and system management configuration validation

This section describes the minimum to POST system requirement and system management configuration validation of the Dell EMC system.

## Topics:

- [Minimum configuration to POST](#)
- [Configuration validation](#)

## Minimum configuration to POST

The components listed below are the minimum configuration to POST:

- Processor
- One memory module (DIMM) in socket A1
- Cabled power supply unit
- System board

## Configuration validation

The new generation of PowerEdge systems have added interconnect flexibility and advanced iDRAC management features to collect precise system configuration information and report configuration errors.

When the system is powered on, information about installed cables, backplanes, floating card (adapter PERC like BOSS), and processor is obtained from the CPLD and backplane memory maps is analyzed. This information forms a unique configuration, which is compared with one of the qualified configurations stored in a table maintained by iDRAC.

One or more sensors are assigned to each of the configuration elements. During POST, any configuration validation error is logged in the System Event Log (SEL)/LifeCycle (LC) log. The reported events are categorized in the configuration validation error table.

**Table 7. Configuration validation error**

Error	Description	Possible cause and recommendations	Example
Config Error	A configuration element within the closest match contains something that is unexpected and does not match any Dell qualified configuration.	Wrong configuration	Config Error: Backplane cable CTRS_SRC_SA1 and BP-DST_SA1
		The element reported in HWC8010 errors are assembled incorrectly. Verify element (cable, etc) placement in the system.	Config Error : SL Cable PLANAR_SL7 and CTRL_DST_PA1
Config Missing	iDRAC found a configuration element missing within the closest match detected.	Missing or damaged cable, device, or part	Config Missing: adapter PERC/HBA
		Missing element or cable is reported in HWC8010 error logs. Install the missing element (cable, etc).	Config Missing : SL cable PLANAR_SL8 and CTRL_DST_PA1

**Table 7. Configuration validation error (continued)**

Error	Description	Possible cause and recommendations	Example
Comm Error	A configuration element is not responding to iDRAC using the management interface while running an inventory check.	System management sideband communication  Unplug AC Power, reseal the element and replace the element if the problem persists.	Comm Error: Backplane 2

## Error messages

This section describes the error messages displayed on the screen during POST or captured in the system event log (SEL)/ LifeCycle (LC) log.

**Table 8. Error message HWC8010**

Error code	HWC8010
Message	The System Configuration Check operation resulted in the following issue involving the indicated component type
Arguments	floating card (adapter PERClike BOSS), backplane, processor, cable, or other components
Detailed Description	The issue identified in the message is observed in the System Configuration Check operation.
Recommended Response Action	Do the following and retry the operation: <ol style="list-style-type: none"> <li>1. Disconnect the input power.</li> <li>2. Check for proper cable connection and component placement. If the issue persists, contact the service provider.</li> </ol>
Category	System Health (HWC = Hardware Config)
Severity	Critical
Trap/EventID	2329

**Table 9. Error message HWC8011**


Error code	HWC8011
Message	The System Configuration Check operation resulted in multiple issues involving the indicated component type
Arguments	floating card (adapter PERClike BOSS), backplane, processor, cable, or other components
Detailed Description	Multiple issues are observed in the System Configuration Check operation.
Recommended Response Action	Do the following and retry the operation: <ol style="list-style-type: none"> <li>1. Disconnect the input power.</li> <li>2. Check for proper cable connection and component placement. If the issue persists, contact the service provider.</li> </ol>
Category	System Health (HWC = Hardware Config)
Severity	Critical

# Installing and removing system components


## Topics:


- Safety instructions
- Before working inside your system
- After working inside your system
- Recommended tools
- System cover
- Frontbezel
- Drives
- Cable routing
- Optional optical drive
- System memory
- Cooling fans
- Internal USB memory key
- Expansion cards
- Optional BOSS S1 card
- Processor and heat sink
- Power supply unit
- System battery
- Intrusion switch
- System board
- Trusted Platform Module
- Control panel


## Safety instructions


 **CAUTION:** Ensure that two or more people lift the system horizontally from the box and place it on a flat surface, rack lift, or into the rails.


 **WARNING:** Opening or removing the system cover while the system is powered on may expose you to a risk of electric shock.


 **WARNING:** Do not operate the system without the cover for a duration exceeding five minutes. Operating the system without the system cover can result in component damage.

 **CAUTION:** Many repairs may only be done by a certified service technician. You should only perform troubleshooting and simple repairs as authorized in your product documentation, or as directed by the online or telephone service and support team. Damage due to servicing that is not authorized by Dell is not covered by your warranty. Read and follow the safety instructions that are shipped with your product.

 **NOTE:** It is recommended that you always use an antistatic mat and antistatic strap while working on components inside the system.

 **CAUTION:** To ensure proper operation and cooling, all system bays and fans must always be populated with a component or a blank.

 **NOTE:** While replacing faulty storage controller, FC, or NIC card with the same type of card, after you power on the system; the new card automatically updates to the same firmware and configuration of the faulty one. For updating to the latest firmware and changing the configuration, see the *Lifecycle Controller User's Guide* at <https://www.dell.com/idracmanuals>.

 **CAUTION:** Do not install GPUs, network cards, or other PCIe devices on your system that are not validated and tested by Dell. Damage caused by unauthorized and invalidated hardware installation will null and void the system warranty.

## Before working inside your system

### Prerequisites

Follow the safety guidelines listed in the [Safety instructions](#).

### Steps

1. Power off the system and all attached peripherals.
2. Disconnect the system from the electrical outlet, and disconnect the peripherals.
3. Remove the system cover.

## After working inside your system

### Prerequisites

Follow the safety guidelines listed in [Safety instructions](#).

### Steps

1. Replace the system cover.
2. Reconnect the peripherals and connect the system to the electrical outlet, and then power on the system.

## Recommended tools

You may need any or combination of the following tools to perform the removal and installation procedures:


- Phillips 1 screwdriver
- Phillips 2 screwdriver
- Torx T15 screwdriver
- 5 mm hex nut screwdriver
- Plastic scribe
- 1/4-inch flat blade screwdriver
- Wrist grounding strap connected to the ground
- ESD mat
- Needle-nose pliers

## System cover

### Removing the system cover

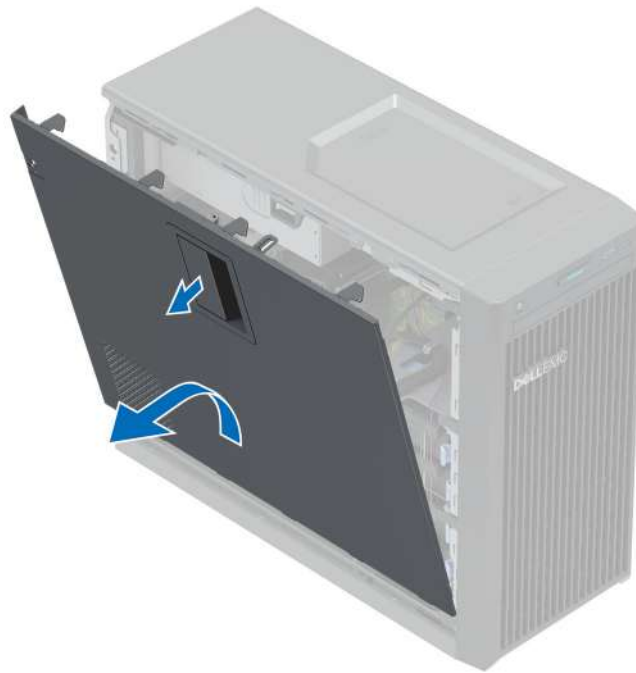
#### Prerequisites

1. Follow the safety guidelines listed in the [Safety instructions](#).
2. Power off the system, and any attached peripherals.
3. Disconnect the system from the electrical outlet and peripherals.
4. Place the system on a flat, stable surface.

 **NOTE:** Ensure that the lock on the side of the system cover is unlocked.

## Steps

Lift the release latch and remove the system cover.



**Figure 8. Removing the system cover**

## Next steps

Replace the system cover.

## Installing the system cover

### Prerequisites

1. Follow the safety guidelines listed in the [Safety instructions](#).
2. Ensure that all internal cables are routed, connected, and that no tools or extra parts are left inside the system.

### Steps

1. Align the tabs on the system cover with the corresponding slots on the system.
2. Press the system cover until it clicks in place.



**Figure 9. Installing the system cover**

#### **Next steps**

1. Place the system upright on a flat, stable surface.
2. Reconnect the peripherals and connect the system to the electrical outlet, and then power on the system.

## **Frontbezel**

### **Removing the front bezel**

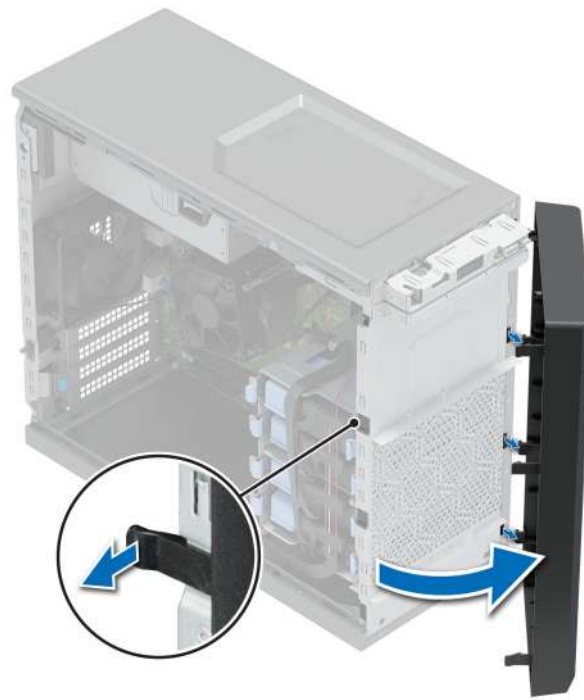
#### **Prerequisites**

1. Follow the safety guidelines listed in the [Safety instructions](#).
2. Follow the procedure listed in [Before working inside your system](#).

#### **Steps**

1. Lift the retention clips at the edge of the bezel.
2. Unhook the bezel tabs and remove the bezel.





**Figure 10. Removing the front bezel**

#### **Next steps**

Replace the front bezel.

## **Installing the front bezel**

#### **Prerequisites**

1. Follow the safety guidelines listed in [Safety instructions](#).
2. Follow the procedure that is listed in [Before working inside your system](#).

#### **Steps**

1. Align and insert the tabs on the bezel into the slots on the system.
2. Press the bezel until the retention clips lock in place.



Figure 11. Installing the front bezel

#### Next steps

Follow the procedure that is listed in [After working inside your system](#).

## Drives

### Removing a 3.5-inch drive carrier from the drive bay

#### Prerequisites

1. Follow the safety guidelines listed in [Safety instructions](#).
2. Follow the procedure that is listed in [Before working inside your system](#).
3. Disconnect the power and data cables from the drive carrier in the drive bay.
4. Using the management software, prepare the drive for removal. Power off the system completely and unplug cables before remove the drive. For more information, see the [www.dell.com/storagecontrollermanuals](http://www.dell.com/storagecontrollermanuals).

**CAUTION:** Before attempting to remove or install a drive while the system is running, see the documentation for the storage controller card to ensure that the host adapter is configured correctly to support drive removal and insertion.

**CAUTION:** Mixing drive carriers from previous generations of PowerEdge servers is not supported.

**CAUTION:** To prevent data loss, ensure that your operating system supports drive installation. See the documentation supplied with your operating system.

#### Steps

Press the retention clips and lift the drive carrier from the drive bay.

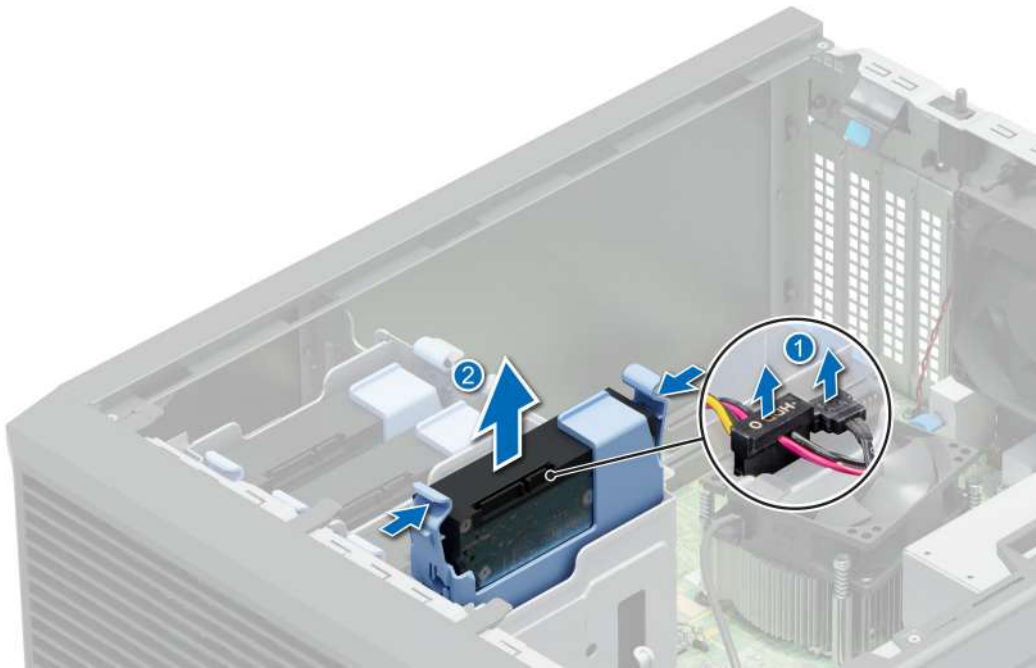


Figure 12. Removing the drive carrier from the drive bay

### Next steps

Replace the drive carrier into the drive bay.

## Installing a 3.5-inch drive carrier into the drive bay

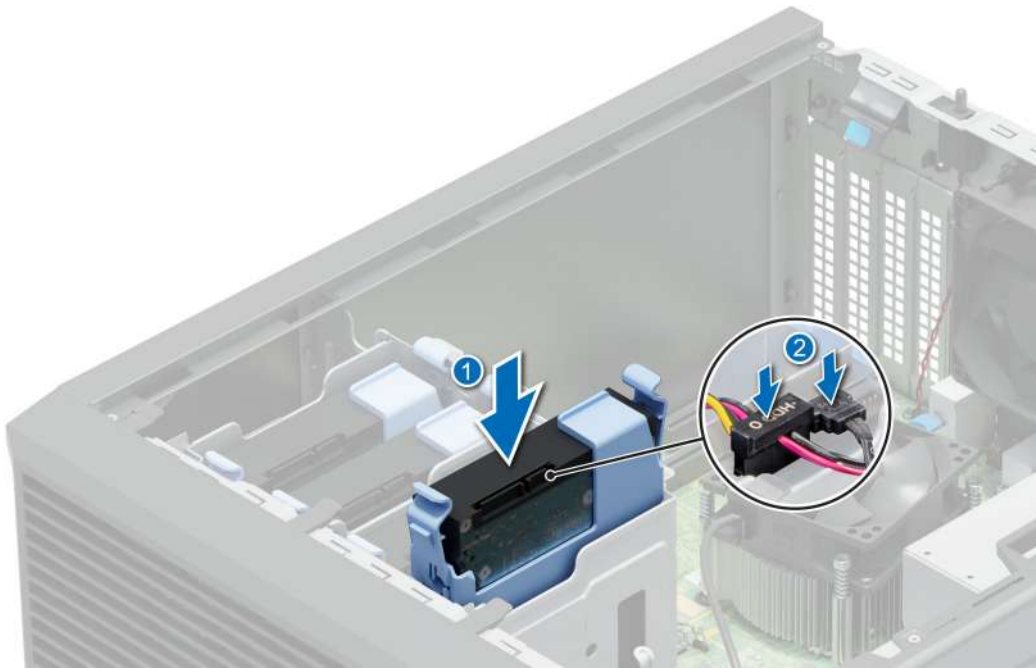
### Prerequisites

- ⚠ **CAUTION:** Before attempting to remove or install a drive while the system is running, see the documentation for the storage controller card to ensure that the host adapter is configured correctly to support drive removal and insertion.
- ⚠ **CAUTION:** Combining SAS and SATA drives in the same RAID volume is not supported.
- ⚠ **CAUTION:** RAID mode does not support entry drives.
- ⚠ **CAUTION:** When installing a drive, ensure that the adjacent drives are fully installed. Inserting a drive carrier and attempting to lock its handle next to a partially installed carrier can damage the partially installed carrier's shield spring and make it unusable.
- ⚠ **CAUTION:** To prevent data loss, ensure that your operating system supports hot-swap drive installation. See the documentation supplied with your operating system.
- ⚠ **CAUTION:** When a replacement hot swappable drive is installed and the system is powered on, the drive automatically begins to rebuild. Ensure that the replacement drive is blank or contains data that you want to overwrite. Any data on the replacement drive is immediately lost after the drive is installed.

1. Follow the safety guidelines listed in [Safety instructions](#).
2. Follow the procedure that is listed in [Before working inside your system](#).

### Steps

Align and slide the drive carrier into the drive bay until it clicks into place.



**Figure 13. Installing the drive carrier into the drive bay**

**Next steps**

1. Connect the power and data cables on the drive carrier.
2. Follow the procedure listed in [After working inside your system](#).

## Removing a drive from the drive carrier

**Prerequisites**

1. Follow the safety guidelines listed in [Safety instructions](#).
2. Follow the procedure that is listed in [Before working inside your system](#).
3. [Remove a 3.5-inch drive carrier from the drive bay](#).

**Steps**

Flex the drive bracket and remove the drive from the carrier.



Figure 14. Removing the drive from the drive carrier

#### Next steps

Install the drive into the drive carrier.

## Installing a drive into the drive carrier

#### Prerequisites

1. Follow the safety guidelines listed in [Safety instructions](#).
2. Follow the procedure that is listed in [Before working inside your system](#).
3. [Remove a 3.5-inch drive carrier from the drive bay](#).

#### Steps

1. Align the screw holes on one side of the drive with the pins on the drive carrier.
2. Flex the side of the drive carrier, and place the drive into the drive carrier.



Figure 15. Installing a drive into the drive carrier

#### Next steps

1. Install a 3.5-drive carrier into the drive bay.
2. Follow the procedure listed in [After working inside your system](#).

## Removing a 2.5-inch drive from the 3.5-inch drive adapter

#### Prerequisites

1. Follow the safety guidelines listed in the [Safety instructions](#).
2. Follow the procedure listed in [Before working inside your system](#).
3. [Remove 3.5-inch drive adapter from the 3.5-inch drive carrier](#).

**NOTE:** A 2.5-inch cabled drive is installed in a 3.5-inch drive adapter, which is then installed in the 3.5-inch cabled drive carrier.

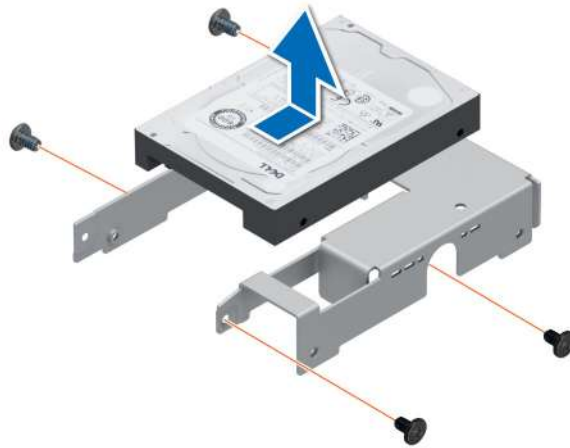
#### Steps

1. Using a Phillips 1 screwdriver, remove the screws from the side of the 3.5-inch drive adapter.

**NOTE:** If the 2.5-inch drive has Torx screw, use Torx 6 screwdriver to remove the drive from a 3.5-inch drive adapter.



2. Remove the drive from the 3.5-inch drive adapter.



**Figure 16. Removing a 2.5-inch drive from the 3.5-inch drive adapter**

#### Next steps

Replace a 2.5-inch drive into the 3.5-inch drive adapter.

## Installing a 2.5-inch drive into the 3.5-inch drive adapter

#### Prerequisites

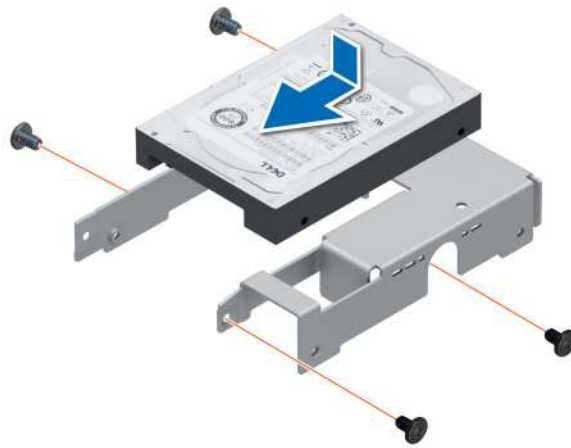
Follow the safety guidelines listed in the [Safety instructions](#).

#### Steps

1. Align the screw holes on the 2.5-inch drive with the screw holes on the 3.5-inch drive adapter.
2. Using a Phillips 1 screwdriver, tighten the screws to secure the drive to the 3.5-inch drive adapter.

**NOTE:** If the 2.5-inch drive has Torx screw, use Torx 6 screwdriver to install the drive to a 3.5-inch drive adapter.





**Figure 17. Installing a 2.5-inch drive into the 3.5-inch drive adapter**

#### **Next steps**

1. [Install a 3.5-inch adapter into the 3.5-inch drive carrier.](#)
2. Follow the procedure listed in [After working inside your system.](#)

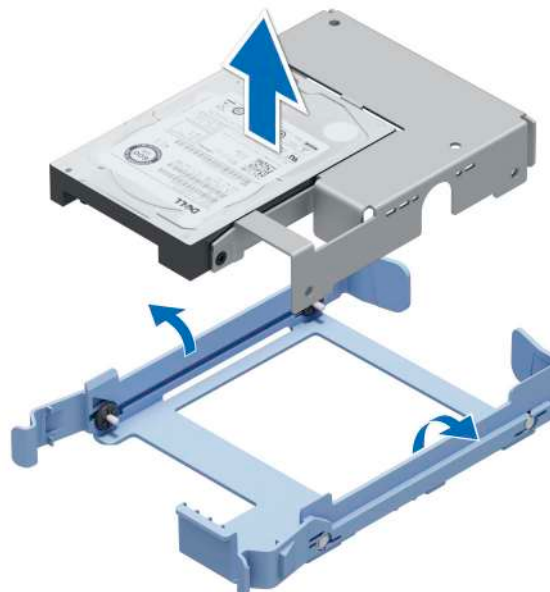
## **Removing a 3.5-inch drive adapter from a 3.5-inch drive carrier**

#### **Prerequisites**

1. Follow the safety guidelines listed in the [Safety instructions.](#)
2. Follow the procedure listed in [Before working inside your system.](#)
3. [Remove the 3.5-inch drive carrier from the system.](#)

#### **Steps**

Flex the drive bracket and remove the adapter from the carrier.



**Figure 18. Removing a 3.5-inch drive adapter from a 3.5-inch drive carrier**



### Next steps

Replace a 3.5-inch adapter into a 3.5-inch drive carrier.

## Installing a 3.5-inch adapter into a 3.5-inch drive carrier

### Prerequisites

1. Follow the safety guidelines listed in the [Safety instructions](#).
2. Follow the procedure listed in [Before working inside your system](#).

### Steps

1. Align the screw holes on one side of the adapter with the pins on the drive carrier.
2. Flex the side of the drive carrier, and place the adapter into the drive carrier.

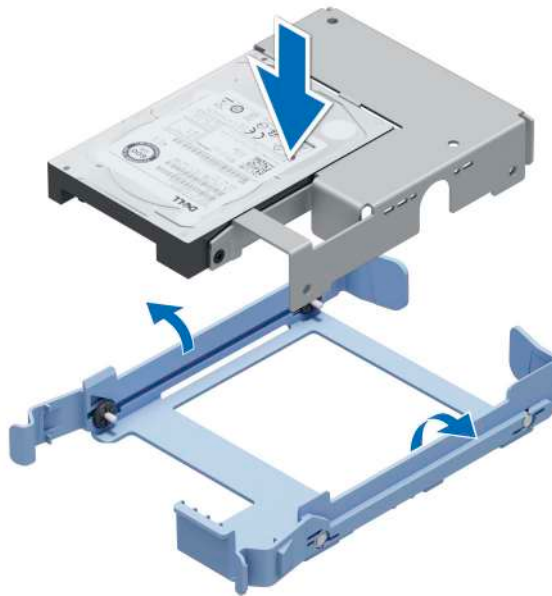


Figure 19. Installing a 3.5-inch drive adapter into the 3.5-inch drive carrier

### Next steps

1. [Replace a 3.5-inch drive carrier into the system](#).
2. Follow the procedure listed in [After working inside your system](#).

## Setting the cooling fan speed for 8 TB drives

### Prerequisites

**NOTE:** Dell EMC recommends 8 TB drives be used only in systems configured with a PERC controller.

**CAUTION:** Using 8 TB drives in the system without a PERC controller might cause drive 1 to overheat under excessive work load, leading to a potential failure of the drive.

### About this task

When 8 TB drives are used in a system without a PERC controller, the speed of the cooling fan must be manually adjusted to prevent the drives from overheating.

### Steps

1. To enter the iDRAC menu, press F2 or F11 during post.

2. Select **iDRAC** setting.
3. Select **Thermal** section.
4. Select **Fan Setup** setting.
5. At the **Fan Speed Offset** section, select **Low fan speed offset (+15%)**.

## Cable routing

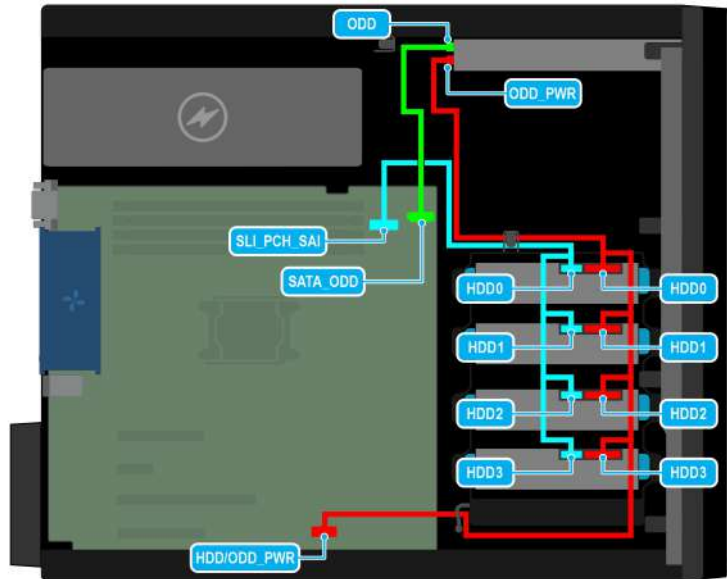


Figure 20. Cable routing - 4 x 3.5-inch cabled SATA drive

Table 10. Connector descriptions for 4 x 3.5-inch cabled SATA drive

From	To
ODD (Optical disc drive connector)	SATA_ODD (Optical disc drive SATA connector on system board)
ODD_PWR + HDD0, HDD1, HDD2, HDD3 (Optical disc drive power connector, connecting through the drives 0, 1, 2, 3)	HDD/ODD_PWR (Drives/Optical disc drive power connector on the system board)
HDD0, HDD1, HDD2, HDD3 (Signal connector connecting through the drives 0, 1, 2, 3)	SL1_PCH_SA1 (Signal connector on system board, cable marking MB SL1)

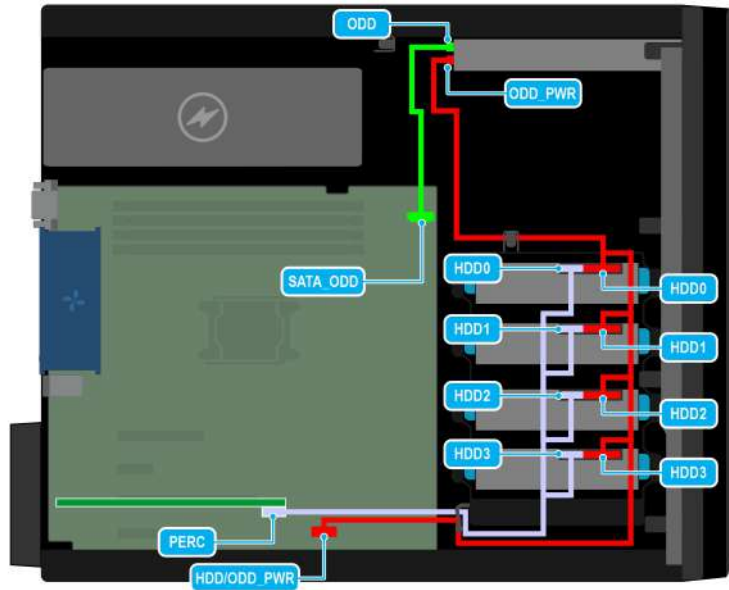


Figure 21. Cable routing - 4 x 3.5-inch cabled SAS drive with storage controller card

Table 11. Connector descriptions for 4 x3.5-inch cabled SAS drive with storage controller card

From	To
ODD (Optical disc drive connector)	SATA_ODD (Optical disc drive SATA connector on system board)
ODD_PWR + HDD0, HDD1, HDD2, HDD3 (Optical disc drive power connector, connecting through the drives 0, 1, 2, 3)	HDD/ODD_PWR (Drives/Optical disc drive power connector on the system board)
HDD0, HDD1, HDD2, HDD3 (Signal connector connecting through the drives 0, 1, 2, 3)	PERC (SAS connector of PERC card on the system board)

## Optional optical drive

This is a service technician replaceable part only.

## Removing the optical drive fillers

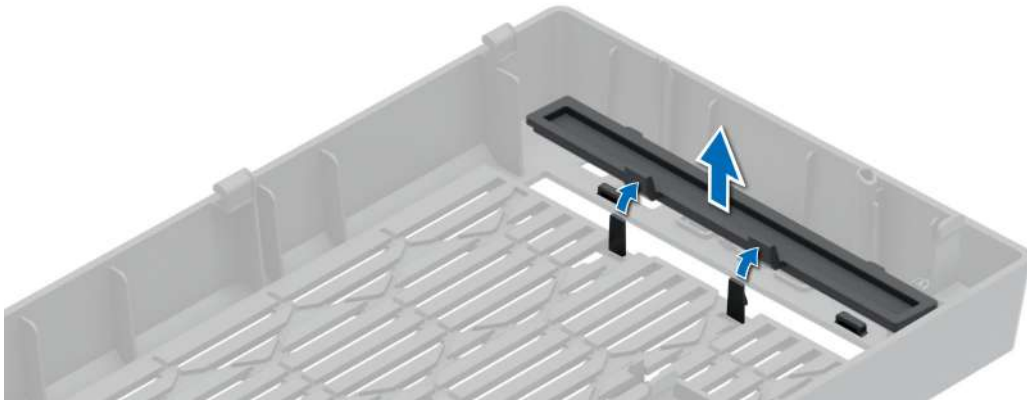
### Prerequisites

1. Follow the safety guidelines listed in [Safety instructions](#).
2. Follow the procedure that is listed in [Before working inside your system](#).
3. [Remove the front bezel](#).

**NOTE:** There are two optical drive fillers, plastic filler on the front bezel, and metal filler on the optical drive cage.

### Steps

1. On the front bezel, press the retention clip of the optical drive filler and pull the filler from the front bezel.



**Figure 22. Removing the optical drive filler from the front bezel**

2. On the optical drive cage, hold the tabs on the optical drive filler and remove the filler from the optical drive cage.



**Figure 23. Removing the optical drive filler from the optical drive cage**

### Next steps

Replace the optical drive filler or install the optical drive.

## Installing the optical drive fillers

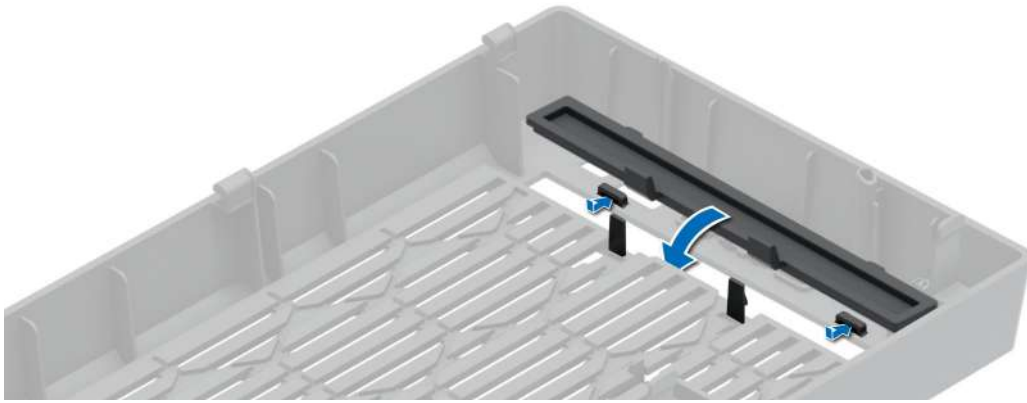
### Prerequisites

1. Follow the safety guidelines listed in [Safety instructions](#).
2. Follow the procedure that is listed in [Before working inside your system](#).
3. [Remove the front bezel](#).

**NOTE:** There are two optical drive fillers, plastic filler on the front bezel, and metal filler on the optical drive cage.

### Steps

1. On the front bezel, insert the tabs on optical drive blank into the slots and push the blank until it locks in place.



**Figure 24. Installing the optical drive filler into the front bezel**

2. On the optical drive cage, hold the tabs on the optical drive filler and push the filler into the optical drive cage.



**Figure 25. Installing the optical drive filler into the optical drive cage**

### Next steps

1. [Install the front bezel.](#)
2. Follow the procedure that is listed in [After working inside your system.](#)

## Removing the optical drive

### Prerequisites

1. Follow the safety guidelines listed in [Safety instructions.](#)
  2. Follow the procedure that is listed in [Before working inside your system.](#)
  3. [Remove the front bezel.](#)
  4. Disconnect the power and data cables from the back of the optical drive.
- NOTE:** Ensure that you note the routing of the power and data cable on the side of the system as you remove them from the system board and drive.

### Steps

Press the release tab and slide the optical drive toward the front of the system.



**Figure 26. Removing the optical drive**

### Next steps

Replace the optical drive or install the optical drive fillers.

## Installing the optical drive

### Prerequisites

**NOTE:** Only slim 9.5 mm SATA DVD-ROM drive or DVD+/-RW drive can be installed in your system. External optical drives can be connected through USB ports.

1. Follow the safety guidelines listed in [Safety instructions](#).
2. Follow the procedure that is listed in [Before working inside your system](#).
3. [Remove the front bezel](#).

### Steps

1. Align the optical drive with the slot in the optical drive cage.
2. Slide the optical drive into the slot until the release tab snaps in place.



**Figure 27. Installing the optical drive**

### Next steps

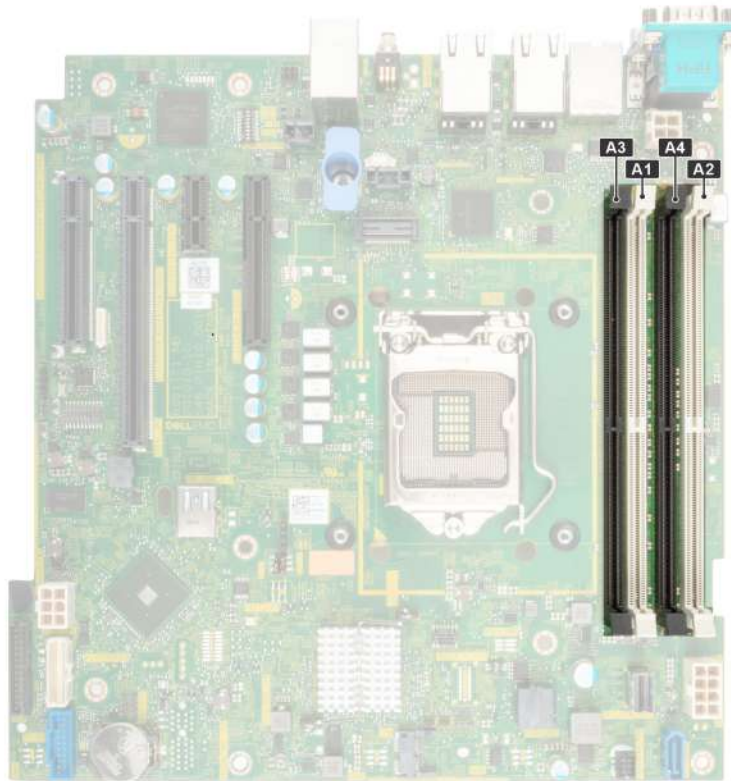
1. Connect the power cable and the data cable to the optical drive.  
**i** **NOTE:** Route the cables properly to prevent them from being pinched or crimped.
2. [Install the front bezel.](#)
3. Follow the procedure that is listed in [After working inside your system.](#)

## System memory

### System memory guidelines

The PowerEdge T150 system supports DDR4 unregistered DIMMs (UDIMMs). System memory holds the instructions that are executed by the processor.

Your system contains four memory sockets that are organized into two channels. In each channel, the first socket is marked white and the second socket black.



**Figure 28. Memory channels**

Memory channels are organized as follows:

**Table 12. Memory channels**

Channel 0	Channel 1
A1 and A3	A2 and A4

**Figure 29. Memory socket location**

**Table 13. Supported memory matrix**

DIMM type	Rank	Capacity	DIMM rated voltage and speed	DIMMs per Channel (DPC)
UDIMM	1R	8 GB/16 GB	DDR4 (1.2 V), 3200 MT/s	3200 MT/s
	2R	32 GB	DDR4 (1.2 V), 3200 MT/s	3200 MT/s


## General memory module installation guidelines

To ensure optimal performance of your system, observe the following general guidelines when configuring your system memory. If your system's memory configurations fail to observe these guidelines, your system might not boot, stop responding during memory configuration, or operate with reduced memory.

The memory bus may operate at speeds up to 2933 MT/s depending on the following factors:


- System profile selected (for example, Performance Optimized, or Custom [can be run at high speed or lower])
- Maximum supported DIMM speed of the processor
- Maximum supported speed of the DIMMs
- Rank of the DIMMs



 **NOTE:** MT/s indicates DIMM speed in Mega-Transfers per second.

The system supports Flexible Memory Configuration, enabling the system to be configured and run in any valid chipset architectural configuration. The following are the recommended guidelines for installing memory modules:

- All DIMMs must be DDR4.
- If memory modules with different speeds are installed, they operate at the speed of the slowest installed memory module.
- Populate memory module sockets only if a processor is installed.
  - For single-processor systems, sockets A1 to A4 is available.
- In **Optimizer Mode**, the DRAM controllers operate independently in the 64-bit mode and provide optimized memory performance.

 **NOTE:** DIMM speed is limited to 2933 MT/s when mixing dual rank DIMMs with single rank or dual rank DIMMs in the same channel.

**Table 14. Memory population rules**

Processor	Configuration	Memory population	Memory population information
Single processor	Optimizer (Independent channel) population order	A{1}, A{2}, A{3}, A{4}	1, 2, 3, 4 DIMMs are allowed.

- Populate all the sockets with white release tabs first, followed by the black release tabs.
- Unbalanced or odd memory configuration results in a performance loss and system may not identify the memory modules being installed, so always populate memory channels identically with equal DIMMs for best performance.

## Removing a memory module


### Prerequisites

1. Follow the safety guidelines listed in the [Safety instructions](#).
2. Follow the procedure listed in the [Before working inside your system](#).

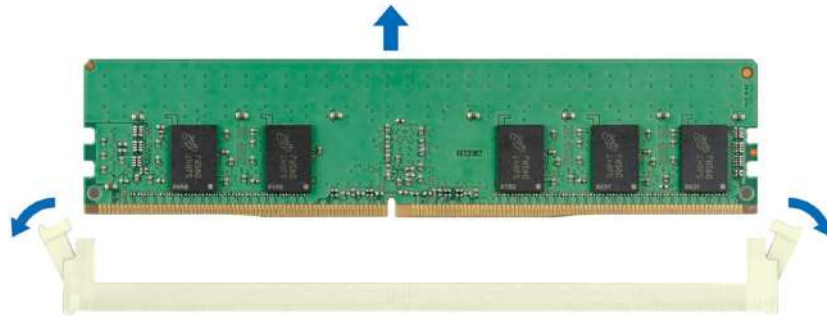
 **WARNING:** The memory modules are hot to touch for some time after the system has been powered off. Allow the memory modules to cool before handling them.

### Steps

1. Locate the appropriate memory module socket.
2. To release the memory module from the socket, simultaneously press the ejectors on both ends of the memory module socket to fully open.

 **CAUTION:** Handle each memory module only by the card edges, ensuring not to touch the middle of the memory module or metallic contacts.

3. Lift the memory module away from the system.



**Figure 30. Removing a memory module**

### Next steps

Replace the memory module.

## Installing a memory module

### Prerequisites

1. Follow the safety guidelines listed in the [Safety instructions](#).
2. Follow the procedure listed in [Before working inside your system](#).

### Steps

1. Locate the appropriate memory module socket.

**CAUTION:** Handle each memory module only by the card edges, ensuring not to touch the middle of the memory module or metallic contacts.

2. If a memory module is installed in the socket, remove it.

**NOTE:** Ensure that the socket ejector latches are fully open, before installing the memory module.

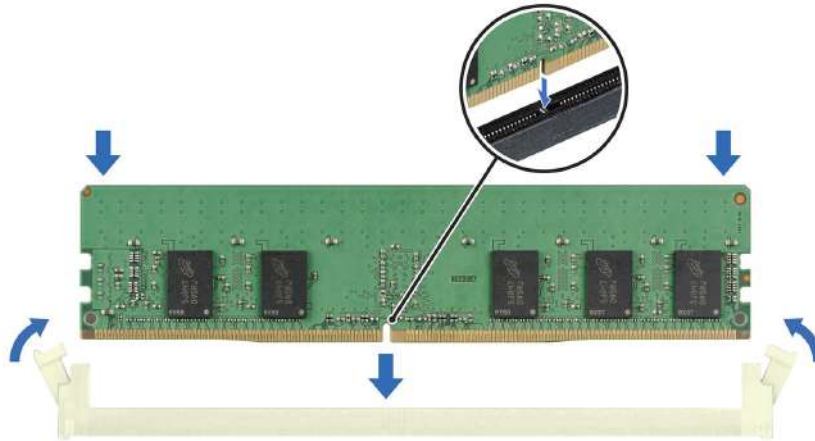
3. Align the edge connector of the memory module with the alignment key of the memory module socket, and insert the memory module in the socket.

**CAUTION:** To prevent damage to the memory module or the memory module socket during installation, do not bend or flex the memory module; insert both ends of the memory module simultaneously.

**NOTE:** The memory module socket has an alignment key that enables you to install the memory module in the socket in only one orientation.

**CAUTION:** Do not apply pressure at the center of the memory module; apply pressure at both ends of the memory module evenly.

4. Press the memory module with your thumbs until the ejectors firmly click into place. When the memory module is properly seated in the socket, the levers on the memory module socket align with the levers on the other sockets that have memory modules that are installed.



**Figure 31. Installing a memory module**

#### Next steps

1. Follow the procedure listed in [After working inside your system](#).
2. To verify if the memory module has been installed properly, press F2 and go to **System Setup Main Menu > System BIOS > Memory Settings**. In the **Memory Settings** screen, the System Memory Size must reflect the updated capacity of the installed memory.
3. If the System Memory Size is incorrect, one or more of the memory modules may not be installed properly. Ensure that the memory modules are firmly seated in their sockets.
4. Run the system memory test in system diagnostics.

## Cooling fans

### Removing a cooling fan

#### Prerequisites

**CAUTION:** Do not remove or install the fan by holding the blades.

**CAUTION:** Never operate your system with the system fan removed. System can overheat and result in shutdown of the system and loss of data.

1. Follow the safety guidelines listed in the [Safety instructions](#).
2. Follow the procedure listed in the [Before working inside your system](#).

#### Steps

1. Disconnect the fan power cable from the system board connector.
2. Stretch the grommets securing the fan to the system.
3. Hold the fan by the sides, and slide it from the grommet.
4. Repeat steps 2 and 3 to release the fan from the remaining grommets.

**NOTE:** The numbers on the image do not depict the exact steps. The numbers are for representation of sequence.



Figure 32. Removing the cooling fan

### Next steps

Replace the cooling fan.

## Installing a cooling fan

### Prerequisites

**CAUTION:** Do not remove or install the cooling fan by holding the blades.

1. Follow the safety guidelines listed in the [Safety instructions](#).
2. Follow the procedure listed in the [Before working inside your system](#).

### Steps

1. Hold the cooling fan by the sides with the cable end facing the bottom of the system.
2. Align the four grommets on the system with the four holes on the sides of the fan.

**NOTE:** It is recommended to first install the lower two grommets.

3. Pass the grommets through the corresponding holes on the fan.
4. Stretch the grommets and push the fan toward the system until it is secured in place.
5. Connect the fan power cable to the connector on the system board.

**NOTE:** The numbers on the image do not depict the exact steps. The numbers are for representation of sequence.



Figure 33. Installing a cooling fan

### Next steps

Follow the procedure listed in [After working inside your system](#).

## Internal USB memory key

### Removing the optional internal USB memory key

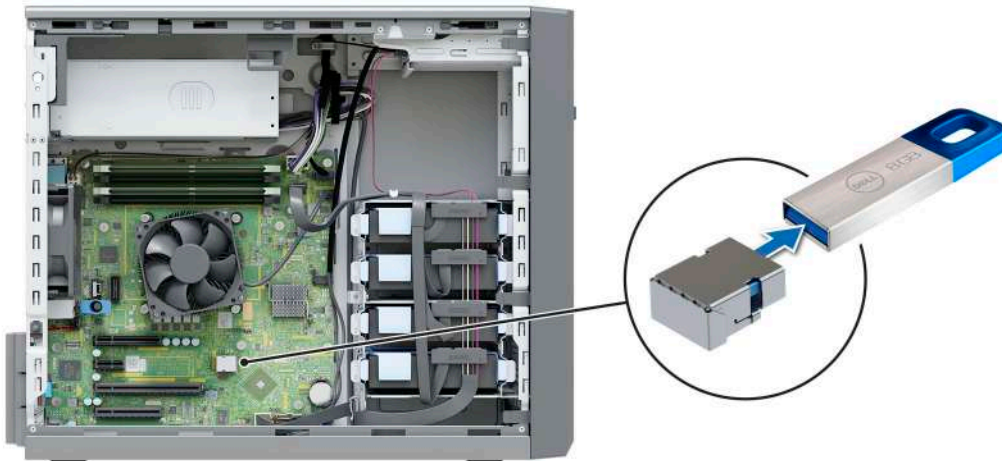
#### Prerequisites

**CAUTION:** To avoid interference with other components in the server, the maximum permissible dimensions of the USB memory key are 15.9 mm width x 57.15 mm length x 7.9 mm height.

1. Follow the safety guidelines listed in the [Safety instructions](#).
2. Follow the procedure listed in the [Before working inside your system](#).

#### Steps

Remove the USB memory key from the internal USB port.



**Figure 34. Removing the internal USB memory key**

**Next steps**

Replace the internal USB memory key.

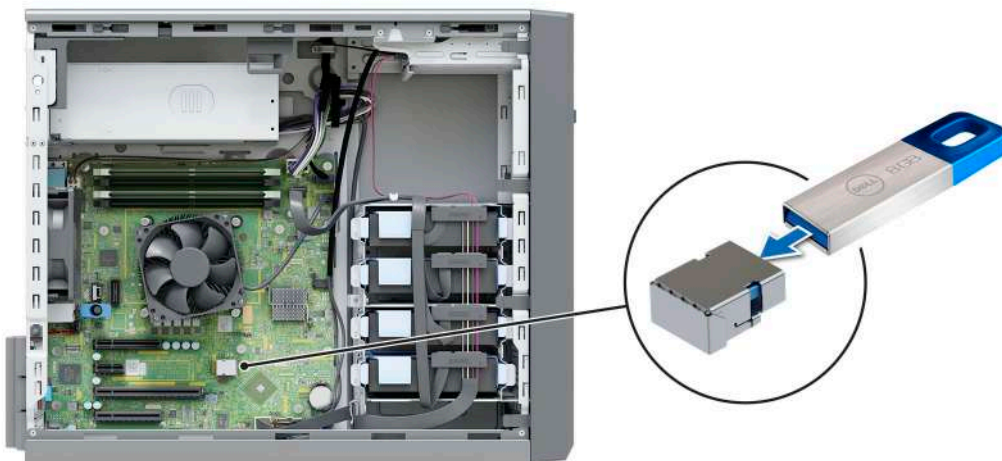
## Installing the internal USB memory key

**Prerequisites**

1. Follow the safety guidelines listed in the [Safety instructions](#).
2. Follow the procedure listed in the [Before working inside your system](#).

**Steps**

Connect the USB memory key into the USB port.



**Figure 35. Installing the internal USB memory key**

### Next steps

1. Follow the procedure listed in [After working inside your system](#).
2. While booting, press F2 to enter **System Setup** and verify that the system detects the USB memory key.

## Expansion cards

**NOTE:** When an expansion card is not supported or missing, the iDRAC and Lifecycle Controller logs an event. This does not prevent your system from booting. However, if a F1/F2 pause occurs with an error message, see *Troubleshooting expansion cards* section in the *Dell EMC PowerEdge Servers Troubleshooting Guide* at [www.dell.com/poweredgemanuals](http://www.dell.com/poweredgemanuals).

### Expansion card installation guidelines

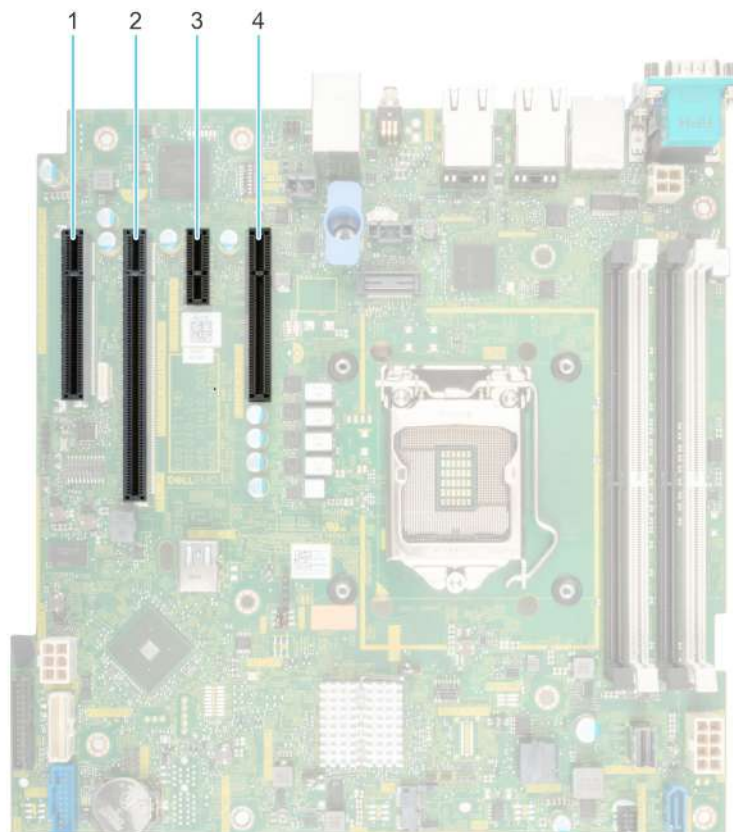


Figure 36. Expansion card slot connectors

- |           |           |
|-----------|-----------|
| 1. Slot 1 | 2. Slot 2 |
| 3. Slot 3 | 4. Slot 4 |

Table 15. Expansion card slots supported on the system board

PCIe slot	Processor connection	PCIe slot height	PCIe slot length	Slot width
Slot 1 (Gen4 from processor)	Processor	Full height	Half length	x4 link in x8 slot
Slot 2 (Gen4 from processor)	Processor	Full height	Half length	x16 link in x16 slot
Slot 3 (Gen3)	Platform Controller Hub	Full height	Half length	x1
Slot 4 (Gen3)	Platform Controller Hub	Full height	Half length	x4 link in x8 slot

**NOTE:** Slot 1 does not function when Pentium processor is installed.

**NOTE:** The expansion cards are not hot swappable.

**NOTE:** For a system with 8 TB (or more) drive capacity, PERC is required for thermal control.

The following table describes the installation order for installing expansion cards to ensure proper cooling and mechanical fit: The expansion cards with the highest priority must be installed first by using the slot priority indicated.

**Table 16. Expansion card installation order**

Card type	Slot priority	Maximum allowed	Maximum PCIe width
H755	2	1	x 8
H355	2	1	x 8
HBA355i	2,1	1	x 8
HBA355e	2,1	2	x 8
H345	2	1	x 8
Broadcom (NIC: 1Gb)	2, 1, 4	3	x 4
Intel (NIC: 1Gb)	2, 1, 4	3	x 4
Dell BOSS S1 Module	2, 1, 4	3	x 8

## Removing a PCIe expansion card

### Prerequisites

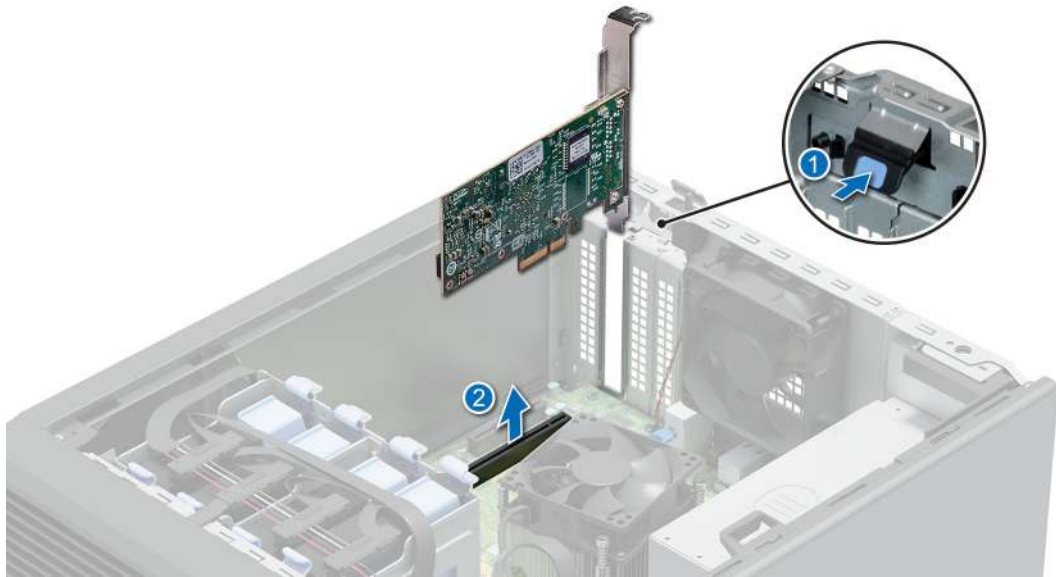
1. Follow the safety guidelines listed in the [Safety instructions](#).
2. Follow the procedure listed in [Before working inside your system](#).
3. Disconnect any cables connected to the expansion card.

**NOTE:** The procedure to remove the storage controller card and BOSS S1 is similar to removing the PCIe expansion card.

### Steps

1. Press the blue retention latch and push down the latch to open it.
2. Hold the expansion card by the edges and pull the card to disengage from the system.

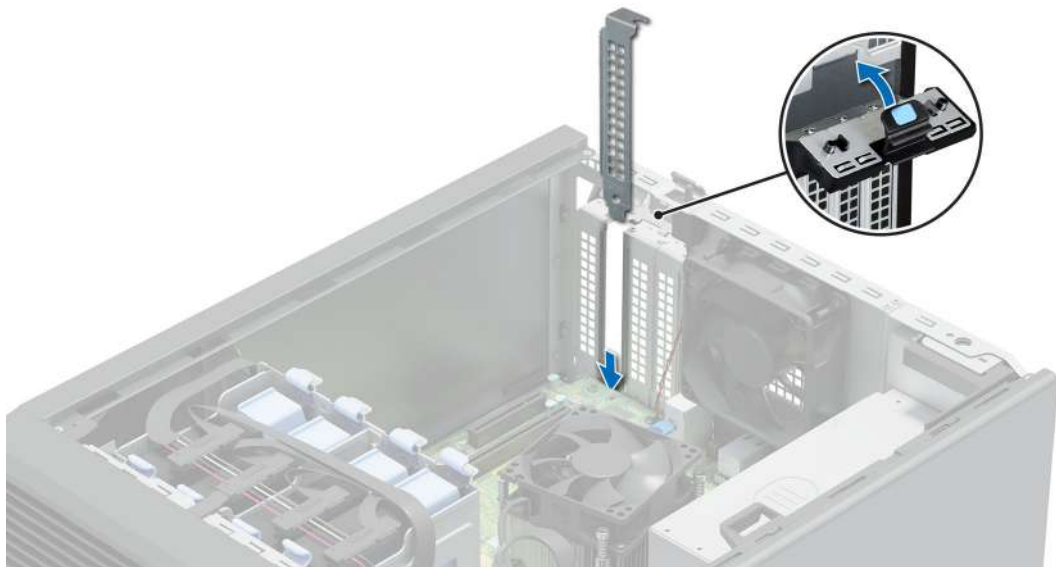




**Figure 37. Removing a PCIe expansion card**

3. If the expansion card is not going to be replaced, install a filler bracket and close the card retention latch.

**i** **NOTE:** You must install a filler bracket over an empty expansion card slot to maintain Federal Communications Commission (FCC) certification of the system. The brackets also keep dust and dirt out of the system and aid in proper cooling and airflow inside the system.



**Figure 38. Installing the filler bracket**

### Next steps

Replace the expansion card.

## Installing a PCIe expansion card

### Prerequisites

1. Follow the safety guidelines listed in the [Safety instructions](#).
2. Follow the procedure listed in [Before working inside your system](#).

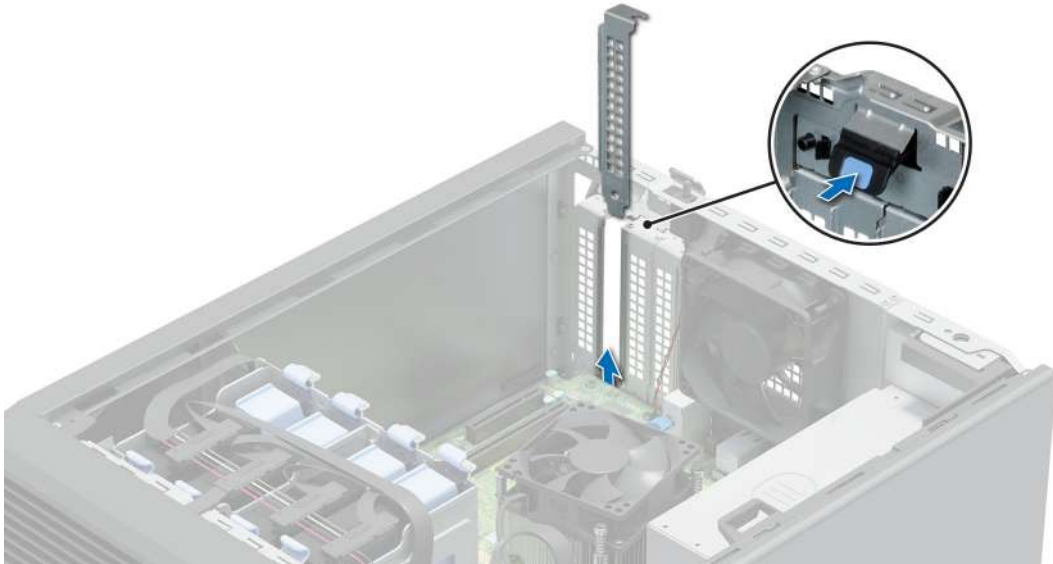
### About this task

**NOTE:** The procedure to install the storage controller card and BOSS S1 is similar to installing the PCIe expansion card.

### Steps

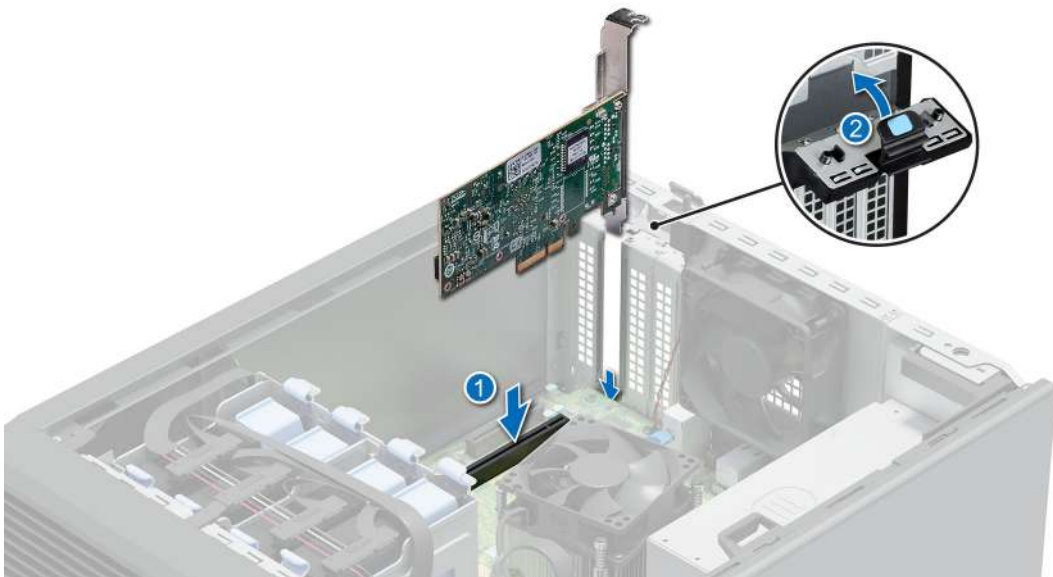
1. Press the blue retention latch and push down the latch to open it.
2. If installed, remove the filler bracket.

**NOTE:** Store the filler bracket for future use. Filler brackets must be installed in empty expansion card slots to maintain Federal Communications Commission (FCC) certification of the system. The filler brackets also keep dust and dirt out of the system and aid in proper cooling and airflow inside the system.



**Figure 39. Removing the filler bracket**

3. Hold the expansion card by the edges, and align the card edge connector with the expansion card connector.
4. Insert the card edge connector firmly into the expansion card connector until the card is fully seated.
5. Close the blue retention latch.



**Figure 40. Installing a PCIe expansion card**

### Next steps

1. If applicable, connect the internal cables to the expansion card.
2. Follow the procedure listed in [After working inside your system](#).
3. Install any device drivers required for the card as described in the documentation for the card.

**i** **NOTE:** While replacing faulty storage controller, FC, or NIC card with the same type of card, after you power on the system; the new card automatically updates to the same firmware and configuration of the faulty one. For updating to the latest firmware and changing the configuration, see the *Lifecycle Controller User's Guide* at <https://www.dell.com/idracmanuals>.

**⚠ CAUTION:** Do not install GPUs, network cards, or other PCIe devices on your system that are not validated and tested by Dell. Damage caused by unauthorized and invalidated hardware installation will null and void the system warranty.

## Optional BOSS S1 card

### Removing the M.2 SSD module

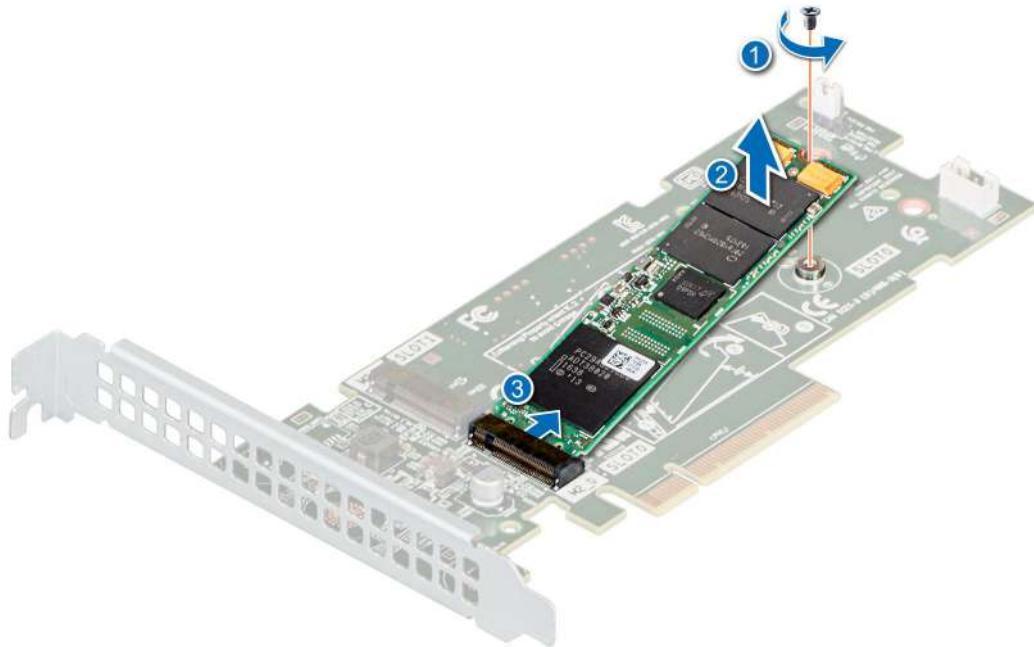
#### Prerequisites

1. Follow the safety guidelines listed in the [Safety instructions](#).
2. Follow the procedure listed in the [Before working inside your system](#).
3. [Remove the BOSS S1 card](#).

**i** **NOTE:** The procedure to remove the BOSS S1 card is similar to removing an expansion card.

#### Steps

1. Using the Phillips 1 screwdriver, remove the screw securing the M.2 SSD module to the BOSS S1 card.
2. Pull the M.2 SSD module to disconnect from the BOSS S1 card connector.



**Figure 41. Removing the M.2 SSD module**

#### Next steps

Replace the M.2 SSD module.

# Installing the M.2 SSD module

## Prerequisites

1. Follow the safety guidelines listed in the [Safety instructions](#).
2. Follow the procedure listed in the [Before working inside your system](#).
3. [Remove the BOSS S1 card](#).

**NOTE:** The procedure to remove the BOSS S1 card is similar to the removing an expansion card.

## Steps

1. Align the M.2 SSD module at an angle with the BOSS S1 card connector.
2. Insert the M.2 SSD module until it is firmly seated in the BOSS S1 card connector.
3. Using the Phillips 1 screwdriver, secure the M.2 SSD module on the BOSS S1 card with the screw.

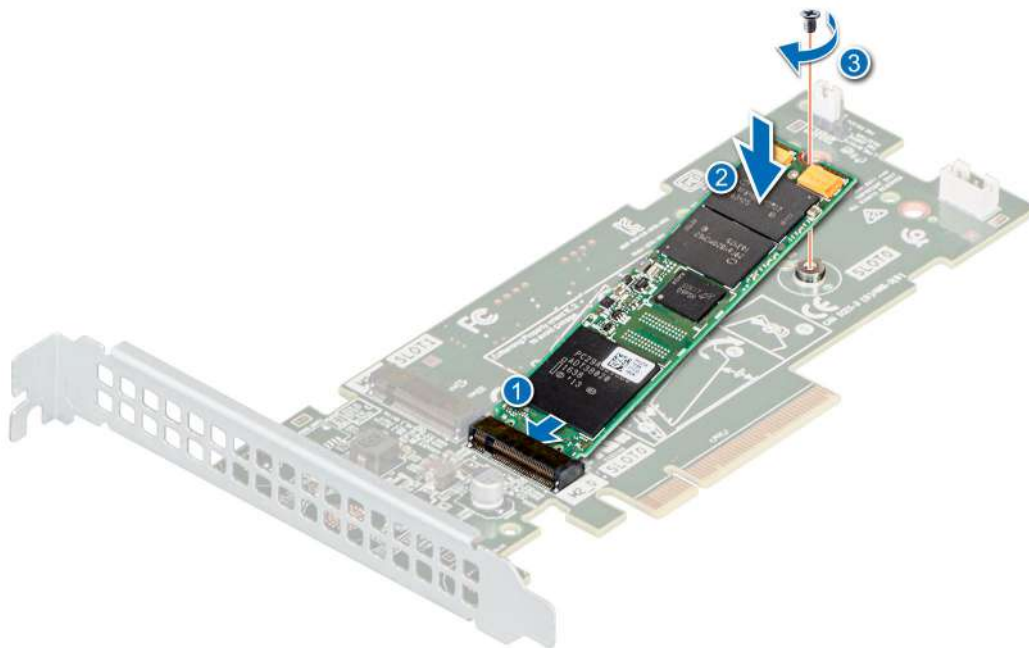


Figure 42. Installing the M.2 SSD module

## Next steps

1. [Install the BOSS S1 card](#)  
**NOTE:** The procedure to install the BOSS S1 card is similar to installing an expansion card.
2. Follow the procedure listed in [After working inside your system](#).

# Processor and heat sink

This is a service technician replaceable part only.

## Removing the heat sink


### Prerequisites

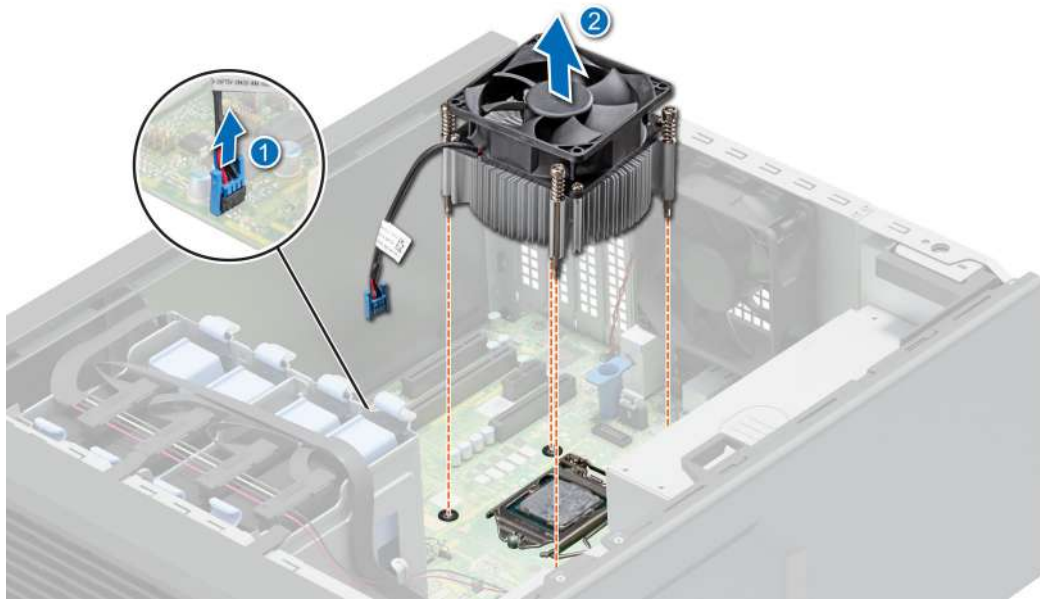
**WARNING:** The heat sink may be hot to touch for some time after the system has been powered off. Allow the heat sink to cool before removing it.

1. Follow the safety guidelines listed in the [Safety instructions](#).
2. Follow the procedure listed in [Before working inside your system](#).

### Steps

1. Disconnect the heat sink fan power cable connector from the connector on the system board.
2. Using a Phillips 2 screwdriver, loosen the screws on the heat sink in the order that is mentioned below:
  - a. Loosen the first screw three turns.
  - b. Loosen the screw diagonally opposite to the screw you loosened first.
  - c. Repeat the procedure for the remaining two screws.
  - d. Return to the first screw to loosen it completely.
3. Lift the heat sink away from the system.

 **NOTE:** The numbers on the image do not depict the exact steps. The numbers are for representation of sequence.




**Figure 43. Removing the heat sink**


### Next steps


[Replace the heat sink](#) or [install the processor](#).

## Removing the processor

### Prerequisites

 **WARNING:** The processor will be hot to touch for some time after the system has been powered down. Allow the processor to cool before removing it.

 **CAUTION:** The processor is held in its socket under strong pressure. The release lever can spring up suddenly if not firmly held.

 **NOTE:** Only remove the processor if you are replacing the processor or system board. This procedure is not required when replacing a heat sink module.

1. Follow the safety guidelines listed in the [Safety instructions](#).
2. Follow the procedure listed in [Before working inside your system](#).
3. [Remove the heat sink module](#).

## Steps

1. Release the socket lever by pushing the lever down and out from under the tab on the processor shield.
2. Lift the lever upward until the processor shield lifts.

**CAUTION:** The processor socket pins are fragile and can be permanently damaged. Be careful not to bend the pins in the processor socket when removing the processor out of the socket.

3. Lift the processor out of the socket.

**NOTE:** Ensure that the processor and the bracket are placed in the tray after you remove the heat sink.



Figure 44. Removing the processor

## Next steps

Replace the processor.

# Installing the processor

## Prerequisites

**CAUTION:** Never remove the heat sink from a processor unless you intend to replace the processor. The heat sink is necessary to maintain proper thermal conditions.

1. Follow the safety guidelines listed in the [Safety instructions](#).
2. Follow the procedure listed in [Before working inside your system](#).
3. [Remove the processor](#).

## Steps

1. Align the pin 1 indicator of the processor with the triangle on the socket and place the processor on the socket.

**CAUTION:** Positioning the processor incorrectly can permanently damage the system board or the processor. Be careful not to bend the pins in the socket.

2. Lower the socket lever and push it under the tab to lock it.

**NOTE:** If the processor has previously been used in a system, remove any remaining thermal grease from the processor by using a lint-free cloth.



**Figure 45. Installing the processor**

### Next steps

**i** **NOTE:** Ensure that you install the heat sink after you install the processor. The heat sink is necessary to maintain proper thermal conditions.

1. [Install the heat sink module.](#)
2. Follow the procedure listed in [After working inside your system.](#)

## Installing the heat sink

### Prerequisites

**⚠ CAUTION:** Never remove the heat sink from a processor unless you intend to replace the processor. The heat sink is necessary to maintain proper thermal conditions.

1. Follow the safety guidelines listed in the [Safety instructions.](#)
2. Follow the procedure listed in [Before working inside your system.](#)
3. If removed, [install the processor.](#)

### Steps

1. If you are using an existing heat sink, remove the thermal grease from the heat sink by using a clean lint-free cloth.
2. Use the thermal grease syringe included with your processor kit to apply the grease in a quadrilateral design on the top of the processor.

**⚠ CAUTION:** Applying too much thermal grease can result in excess grease coming in contact with and contaminating the processor socket.

**i** **NOTE:** The thermal grease syringe is intended for single use only. Dispose the syringe after you use it.

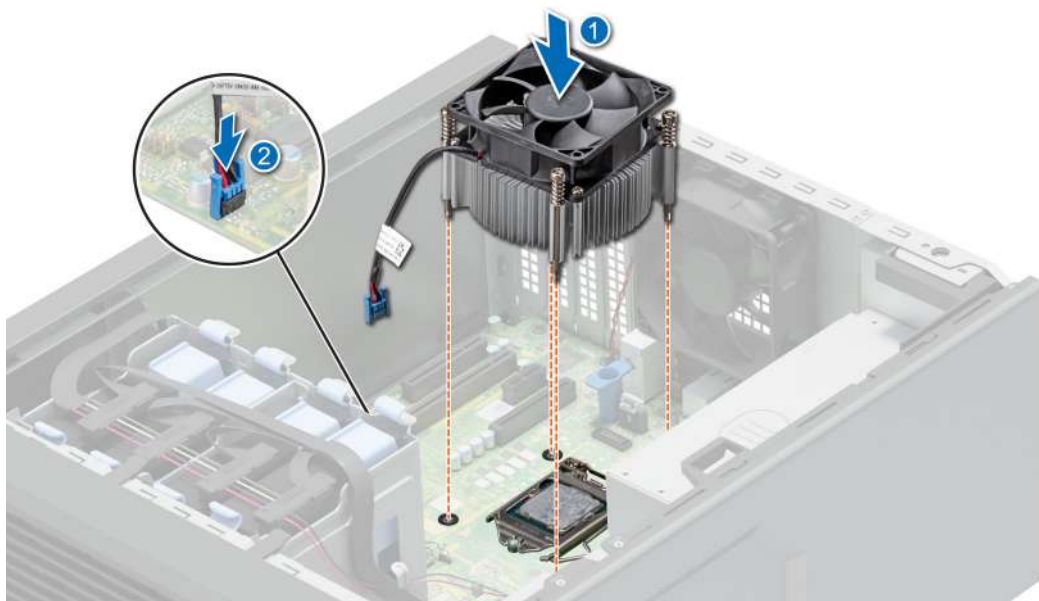


**Figure 46. Applying thermal grease on top of the processor**

3. Place the heat sink onto the processor with the cable end facing the drive carrier.
4. Using the Phillips 2 screwdriver, tighten the screws (8 in-lbf) on the heat sink in the order below:
  - a. In a random order, tighten the first screw three turns.
  - b. Tighten the screw diagonally opposite to the screw you tighten first.
  - c. Repeat the procedure for the remaining two screws.
  - d. Return to the first screw to tighten it completely.
  - e. Check all the screws to ensure they are firmly secured.

**i** **NOTE:** The processor and heat sink module retention screws should not be tightened to more than 0.13 kgf-m (1.35 N.m or 12 in-lbf).

**i** **NOTE:** The numbers on the image do not depict the exact steps. The numbers are for representation of sequence.



**Figure 47. Installing the heat sink**



### Next steps

1. Follow the procedure listed in [After working inside your system](#).
2. While booting, press F2 to enter System Setup and check that the processor information matches the new system configuration.
3. Run the system diagnostics to verify that the new processor operates correctly.

## Power supply unit

**NOTE:** While replacing the hot swappable PSU, after next server boot; the new PSU automatically updates to the same firmware and configuration of the replaced one. For updating to the latest firmware and changing the configuration, see the *Lifecycle Controller User's Guide* at <https://www.dell.com/idracmanuals>.

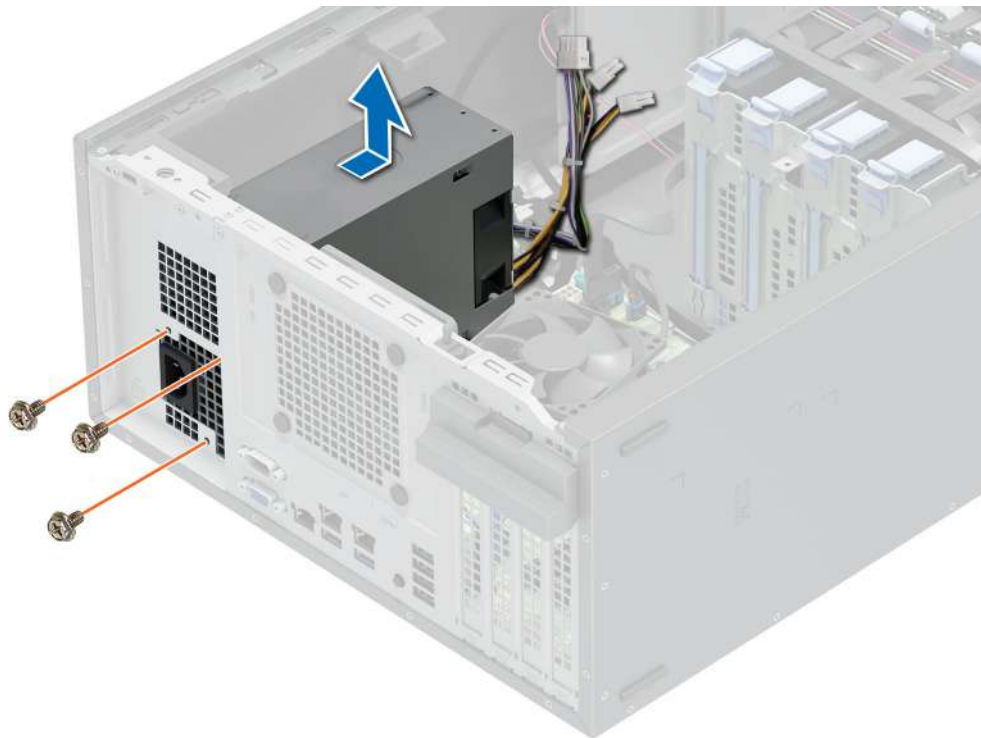
## Removing the power supply unit

### Prerequisites

1. Follow the safety guidelines listed in the [Safety instructions](#).
2. Follow the procedure listed in [Before working inside your system](#).
3. Disconnect the power cable from the system board.
4. Disconnect all the power dongle cable from the D12 PSU cable tie from the system board.

### Steps

1. Remove the screws securing the PSU to the system.
2. Slide and lift the PSU toward the front of the system.



**Figure 48. Removing the D12 PSU**

### Next steps

[Replace the PSU.](#)

# Installing the power supply unit

## Prerequisites

1. Follow the safety guidelines listed in the [Safety instructions](#).
2. Follow the procedure listed in [Before working inside your system](#).

## Steps

1. Place the D12 PSU in the system and slide it toward the back of the system until it is fully seated.
2. Tighten the screws to secure the PSU to the system.

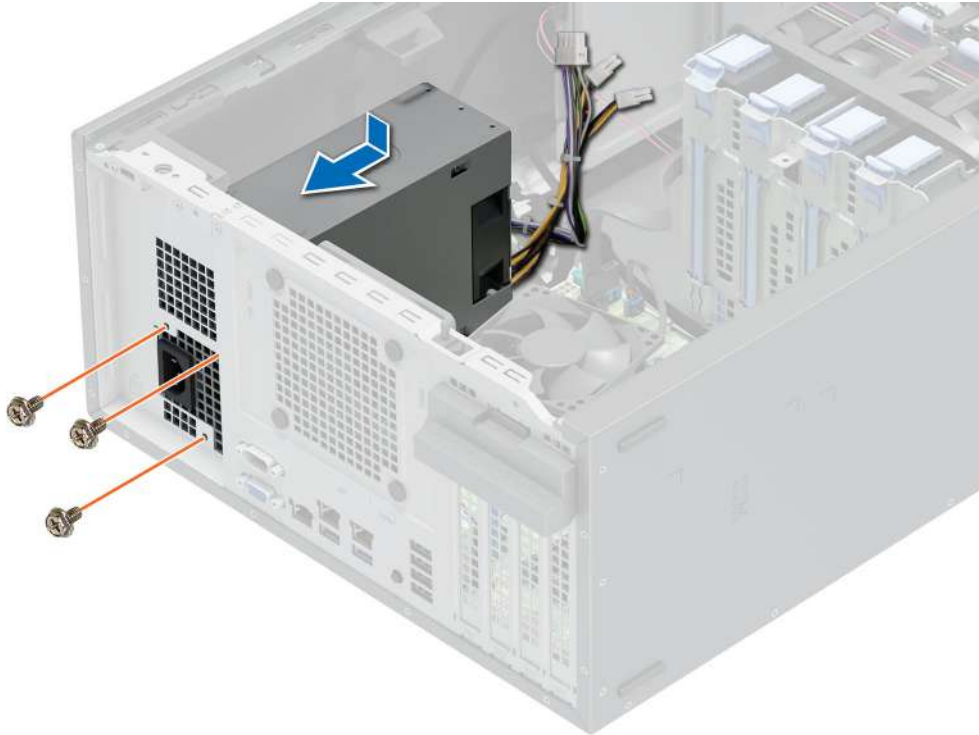


Figure 49. Installing the D12 PSU

3. Bundle the PSU cable with equal interval spaces between cable tie.

## Next steps

1. Connect the power cable and the power dongle cable on the system board connectors.
2. Follow the procedure listed in [After working inside your system](#).

# System battery

This is a service technician replaceable part only.

# Replacing the system battery

## Prerequisites

**⚠ WARNING:** A new battery can explode if it is installed incorrectly. Replace the battery only with the same or equivalent type that is recommended by the manufacturer. Discard used batteries according to the manufacturer's instructions. For more information, see the Safety instructions documentation that is shipped with your system.

1. Follow the safety guidelines listed in the [Safety instructions](#).
2. Follow the procedure listed in [Before working inside your system](#).

### Steps

1. To remove the battery:
  - a. Use a plastic scribe to pry out the system battery.

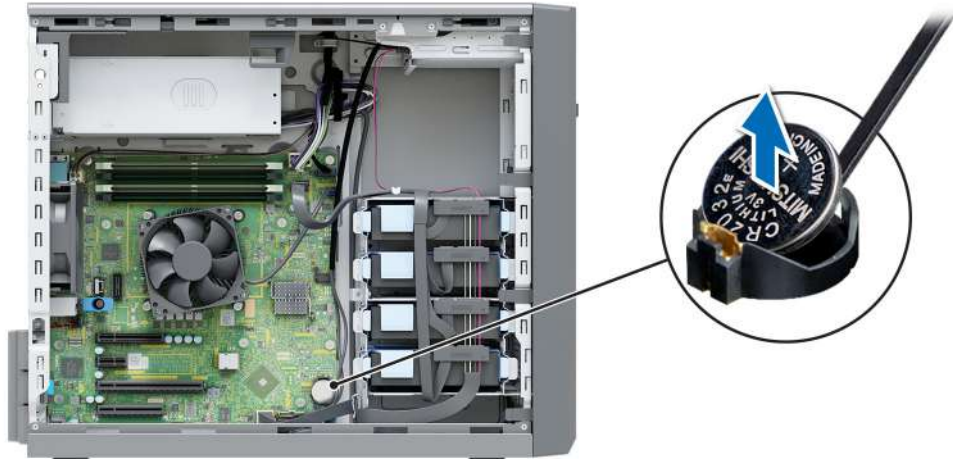


Figure 50. Removing the system battery

**CAUTION:** To prevent damage to the battery connector, you must firmly support the connector while removing or installing a battery.

2. To install a new system battery:
  - a. Slide the battery with the positive side facing up under the securing tabs.
  - b. Press the battery into the connector until it snaps into place.

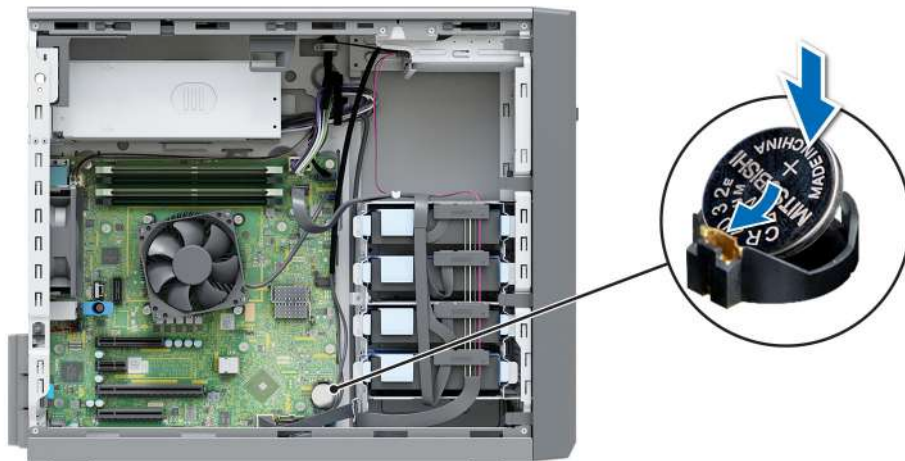


Figure 51. Installing the system battery

### Next steps

1. Follow the procedure listed in [After working inside your system](#).
2. Confirm that the battery is operating properly, by performing the following steps:
  - a. Enter the System Setup, while booting, by pressing **F2**.
  - b. Enter the correct time and date in the System Setup **Time** and **Date** fields.
  - c. **Exit** the System Setup.
  - d. To test the newly installed battery, remove the system from the enclosure for at least an hour.
  - e. Reinstall the system into the enclosure after an hour.
  - f. Enter the System Setup and if the time and date are still incorrect, see [Getting help](#) section.

## Intrusion switch

This is a service technician replaceable part only.

### Removing the intrusion switch

#### Prerequisites

1. Follow the safety guidelines listed in the [Safety instructions](#).
2. Follow the procedure listed in [Before working inside your system](#).

#### Steps

1. Disconnect the intrusion switch cable from the connector on the system board.
2. Slide and push the intrusion switch out of the intrusion switch slot on the system.

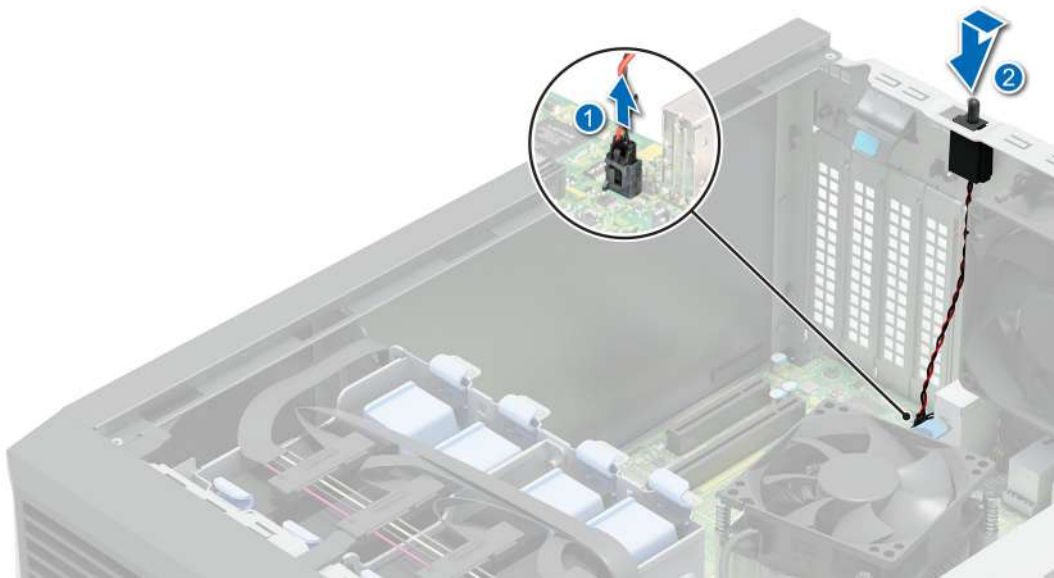


Figure 52. Removing the intrusion switch

### Next steps

[Replace the intrusion switch.](#)

## Installing the intrusion switch

### Prerequisites

1. Follow the safety guidelines listed in the [Safety instructions](#).
2. Follow the procedure listed in [Before working inside your system](#).

### Steps

1. Align the intrusion switch to the intrusion switch slot and slide the intrusion switch to lock in place.

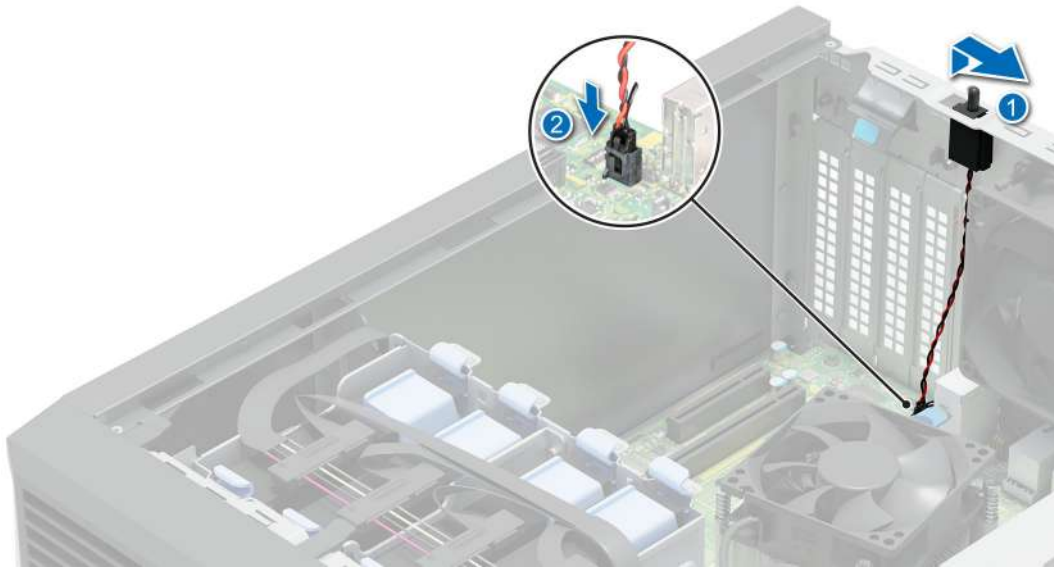


Figure 53. Installing the intrusion switch

2. Connect the intrusion switch cable to the connector on the system board.

### Next steps

Follow the procedure listed in [After working inside your system](#).

## System board

This is a service technician replaceable part only.

## Removing the system board

### Prerequisites


**CAUTION:** If you are using the Trusted Platform Module (TPM) with an encryption key, you may be prompted to create a recovery key during program or System Setup. Be sure to create and safely store this recovery key. If you replace this system board, you must supply the recovery key when you restart your system or program before you can access the encrypted data on your drives.

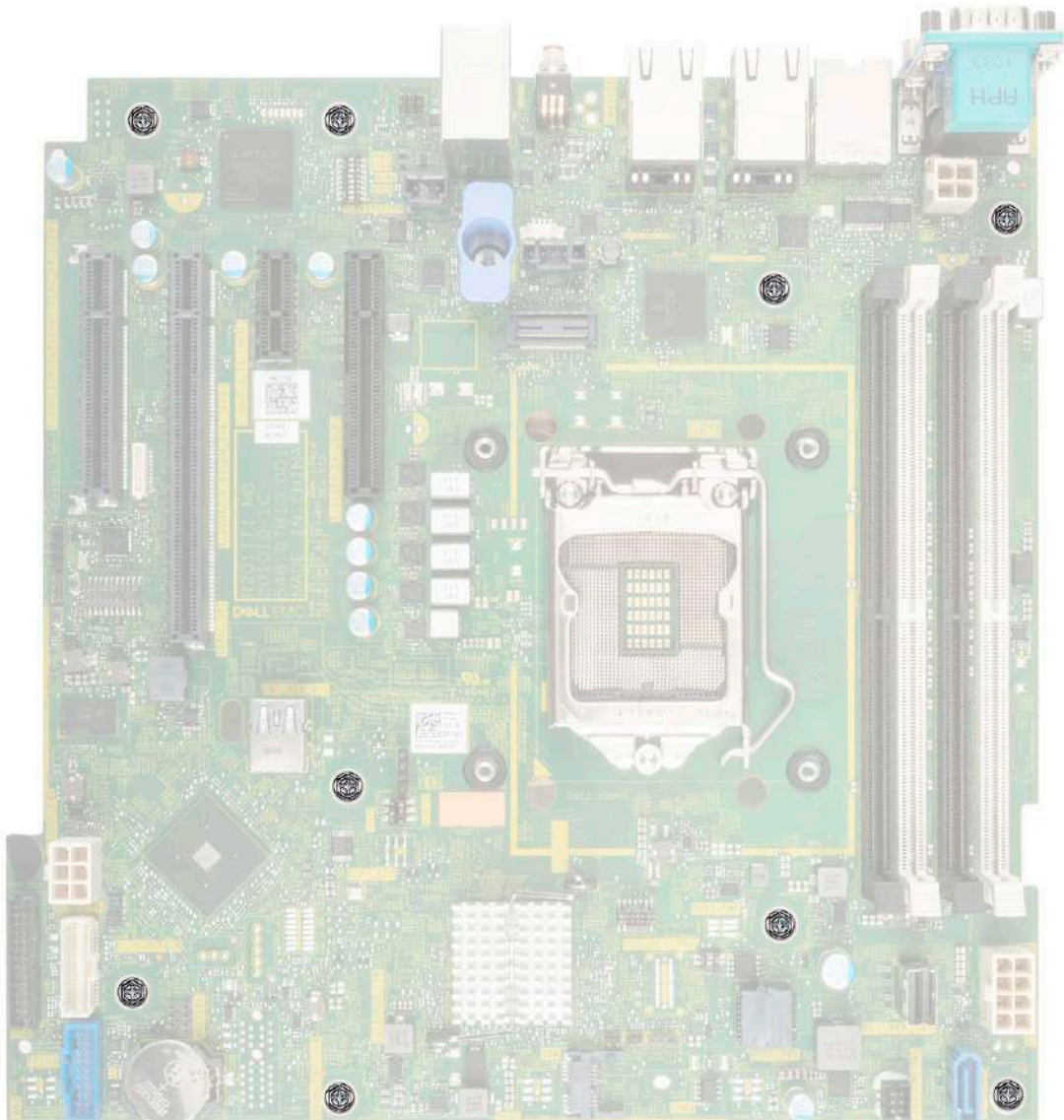
**NOTE:** Do not attempt to remove the TPM plug-in module from the system board. After the TPM plug-in module is installed, it is cryptographically bound to that specific system board. Any attempt to remove an installed TPM plug-in module breaks the cryptographic binding, and it cannot be reinstalled or installed on another system board.

1. Follow the safety guidelines listed in the [Safety instructions](#).
2. Follow the procedure listed in [Before working inside your system](#).
3. Remove the following components:
  - a. [Expansion card](#)
  - b. [Internal USB key](#)
  - c. [Heat sink module](#)
  - d. [Processor](#)
  - e. [Memory module](#)

### Steps

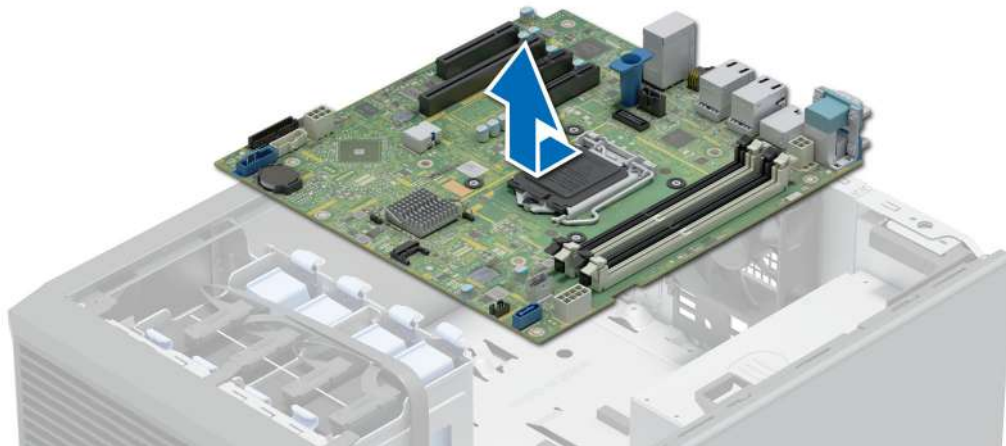
1. Disconnect all cables from the system board.

 **CAUTION: Take care not to damage the system identification button while removing the system board from the chassis.**



**Figure 54. System board screw location**

2. Using a Phillips 2 screwdriver, remove the screws that secure the system board to the chassis.
3. Using the system board holder, slide the system board toward the front of the chassis.
4. Incline the system board at an angle and lift the system board out of the chassis.



**Figure 55. Removing the system board**

### Next steps

Install the system board.

## Installing the system board

### Prerequisites

1. Follow the safety guidelines listed in the [Safety instructions](#).
2. Follow the procedure listed in [Before working inside your system](#).
3. If you are replacing the system board, remove all the components that are listed in the [removing the system board](#) section.

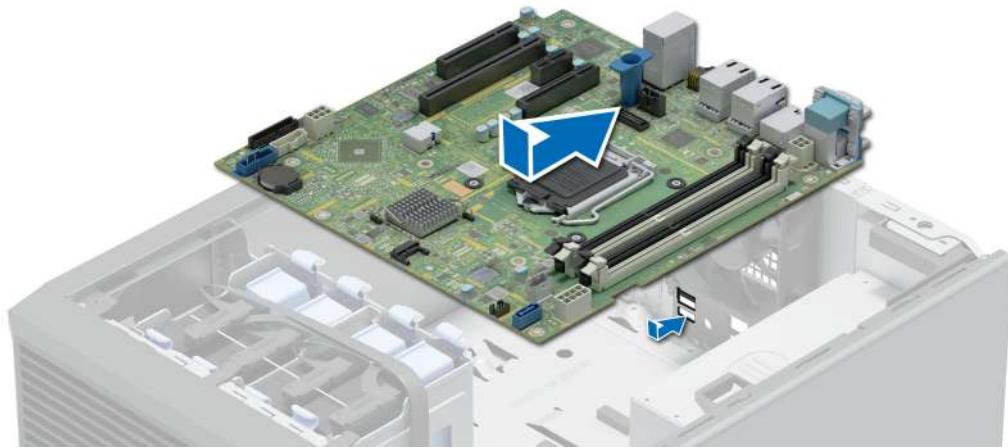
### Steps

1. Unpack the new system board assembly.

**NOTE:** Do not lift the system board by holding a memory module, the processor, or any other components.

**CAUTION:** Take care not to damage the system identification button while placing the system board into the chassis.

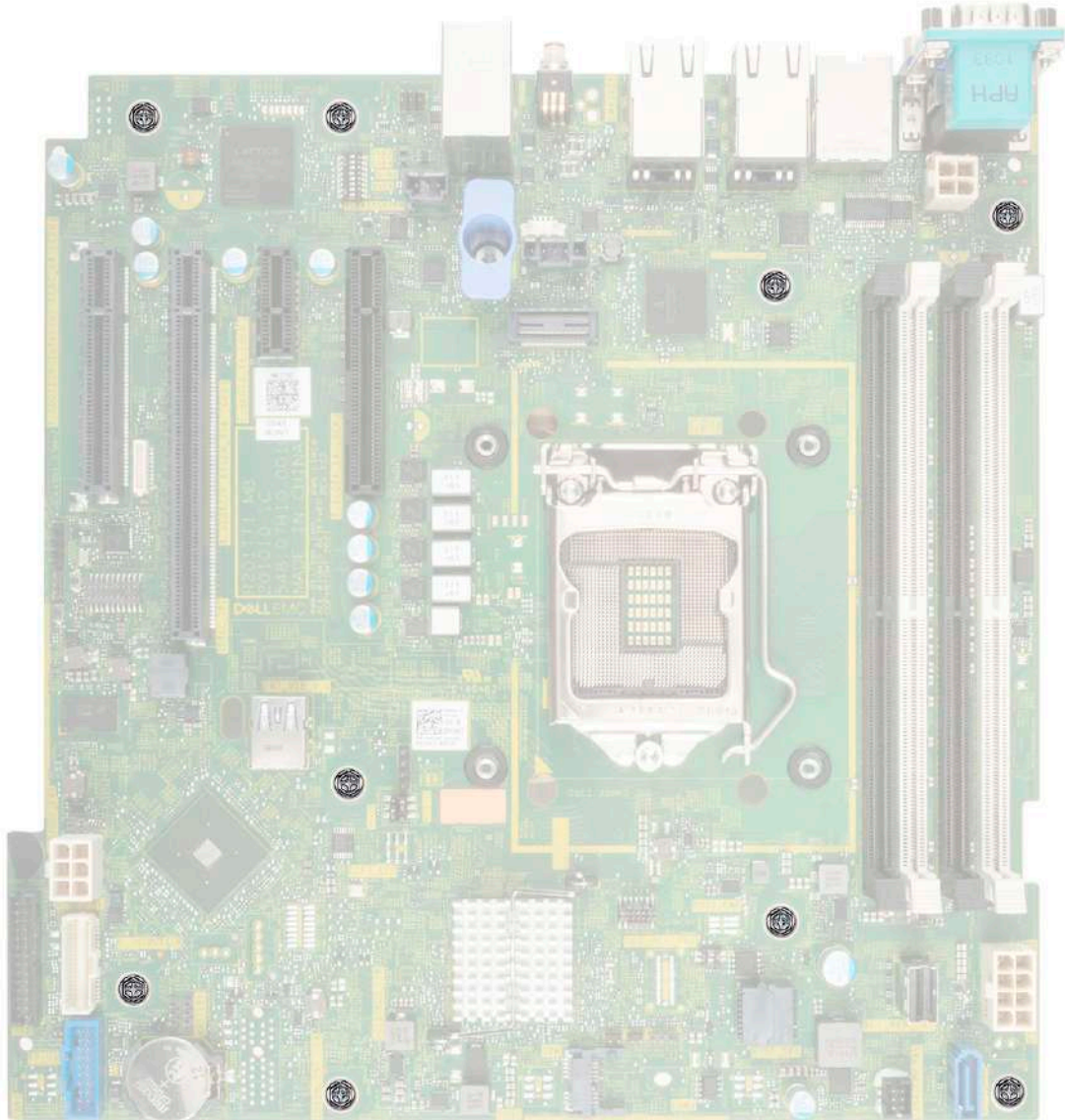
2. Holding the blue holder, incline the system board at an angle and align the connectors on the system board with the slots on the system, and lower the system board into the system.



**Figure 56. Installing the system board**



3. Using the Phillips 2 screwdriver secure the system board to the chassis with screws.





**Figure 57. system board connector location**

### Next steps

1. Replace the following:
  - a. [Trusted Platform Module \(TPM\)](#)
    -  **NOTE:** The TPM must be replaced only while installing a new system board.
    -  **NOTE:** The TPM plug-in module is attached to the system board and cannot be removed. A replacement TPM plug-in module is provided for all system board replacements, where a TPM plug-in module was installed.
  - b. [Memory modules](#)
  - c. [Processor](#)
  - d. [Heat sink module](#)
  - e. [Internal USB card, if installed](#)
  - f. [Expansion cards, if installed](#)
2. Replace the iDRAC MAC address label from the system with the new iDRAC MAC address label that came with the replacement system board.
3. Reconnect all cables to the system board.

**i** **NOTE:** Ensure that the cables inside the system are routed along the chassis wall and secured using the cable securing bracket.

4. Ensure that you perform the following steps:
  - a. Use the Easy Restore feature to restore the Service Tag. See the [Restoring the system by using the Easy Restore feature](#) section.
  - b. If the service tag is not backed up in the backup flash device, enter the system service tag manually. See the [Manually update the Service Tag by using System Setup](#) section.
  - c. Update the BIOS and iDRAC versions.  
Reenable the Trusted Platform Module (TPM). See the [Upgrading the Trusted Platform Module](#) section.
5. If you are not using Easy restore, import your new or existing iDRAC Enterprise license. For more information, see the *Integrated Dell Remote Access Controller User's Guide* available at <https://www.dell.com/idracmanuals>.
6. Follow the procedure listed in [After working inside your system](#).

## Restoring the system using Easy Restore

The Easy Restore feature enables you to restore your service tag, license, UEFI configuration, and the system configuration data after replacing the system board. All data is backed up in a backup flash device automatically. If BIOS detects a new system board, and the service tag in the backup flash device, BIOS prompts the user to restore the backup information.

### About this task

Below is a list of options/steps available:

- Restore the service tag, license, and diagnostics information, press **Y**
- Navigate to the Lifecycle Controller based restore options, press **N**
- Restore data from a previously created **Hardware Server Profile**, press **F10**
- **i** **NOTE:** When the restore process is complete, BIOS prompts to restore the system configuration data.
- Restore data from a previously created **Hardware Server Profile**, press **F10**
- To restore the system configuration data, press **Y**
- To use the default configuration settings, press **N**
- **i** **NOTE:** After the restore process is complete, system reboots.

## Manually update the Service Tag

After replacing a system board, if Easy Restore fails, follow this process to manually enter the Service Tag, using **System Setup**.

### About this task

If you know the system service tag, use the **System Setup** menu to enter the service tag.

### Steps

1. Power on the system.
2. To enter the **System Setup**, press **F2**.
3. Click **Service Tag Settings**.
4. Enter the service tag.  
**i** **NOTE:** You can enter the service tag only when the **Service Tag** field is empty. Ensure that you enter the correct service tag. Once the service tag is entered, it cannot be updated or changed.
5. Click **OK**.

# Trusted Platform Module

This is a service technician replaceable part only.


## Upgrading the Trusted Platform Module

### Removing the TPM

#### Prerequisites

##### NOTE:

- Ensure the operating system is compatible with the TPM version you are installing.
- Ensure that you download and install the latest BIOS firmware on your system.
- Ensure that the BIOS is configured to enable UEFI boot mode.

 **CAUTION:** The TPM plug-in module is cryptographically bound to that particular system board after it is installed. When the system is powered on, any attempt to remove an installed TPM plug-in module breaks the cryptographic binding, and the removed TPM cannot be installed on another system board. Ensure any keys you have stored on the TPM have been securely transferred.

#### Steps

1. Locate the TPM connector on the system board. For more information, see [System board connectors](#).
2. Press to hold the module down and remove the screw using the security Torx 8-bit shipped with the TPM module.
3. Slide the TPM module out from its connector.
4. Push the plastic rivet away from the TPM connector and rotate it 90° counterclockwise to release it from the system board.
5. Pull the plastic rivet out of its slot on the system board.

### Installing the TPM

#### Steps

1. To install the TPM, align the edge connectors on the TPM with the slot on the TPM connector.
2. Insert the TPM into the TPM connector such that the plastic rivet aligns with the slot on the system board.
3. Press the plastic rivet until the rivet snaps into place.
4. Replace the screw that secures the TPM to the system board.



Figure 58. Installing the TPM

## Initializing TPM for users

### Steps

1. Initialize the TPM.  
For more information, see [Initializing the TPM for users](#).
2. The **TPM Status** changes to **Enabled, Activated**.

## Initializing the TPM 1.2 for users

### Steps

1. While booting your system, press F2 to enter System Setup.
2. On the **System Setup Main Menu** screen, click **System BIOS > System Security Settings**.
3. From the **TPM Security** option, select **On with Preboot Measurements**.
4. From the **TPM Command** option, select **Activate**.
5. Save the settings.
6. Restart your system.

## Initializing the TPM 2.0 for users

### Steps


1. While booting your system, press F2 to enter System Setup.
2. On the **System Setup Main Menu** screen, click **System BIOS > System Security Settings**.
3. From the **TPM Security** option, select **On**.
4. Save the settings.
5. Restart your system.

## Control panel

This is a service technician replaceable part only.

## Removing the control panel cage

### Prerequisites

1. Follow the safety guidelines listed in the [Safety instructions](#).
2. Follow the procedure listed in [Before working inside your system](#).
3. Disconnect all peripherals that are connected to the control panel.
4. Disconnect the control panel cable and control panel USB cable from the system board.  
 **CAUTION: Do not use excessive force when removing the control panel cables as it can damage the connectors.**
5. [Remove the front bezel](#).

### Steps

1. Using the Phillips 1 screwdriver, remove the screws that secure the control panel cage to the system.
2. Slide the control panel cage out of the system along with the cables.



**Figure 59. Removing the control panel cage**

### Next steps

Remove the control panel.

## Removing the control panel

### Prerequisites

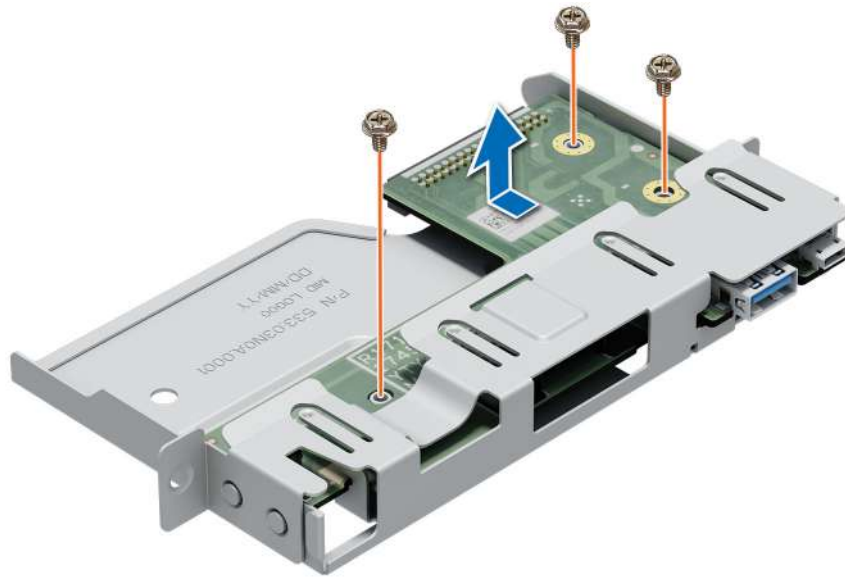
1. Follow the safety guidelines listed in the [Safety instructions](#).
2. Follow the procedure listed in [Before working inside your system](#).

### Steps

1. Disconnect the control panel cable from the control panel.

**CAUTION:** Do not use excessive force when removing the control panel cables as it can damage the connectors.

2. Using the Phillips 2 screwdriver, remove the screws that secure the control panel to the control panel cage.
3. Slide the control panel out of the control panel cage.



**Figure 60. Removing the control panel**

### Next steps

Replace the control panel.

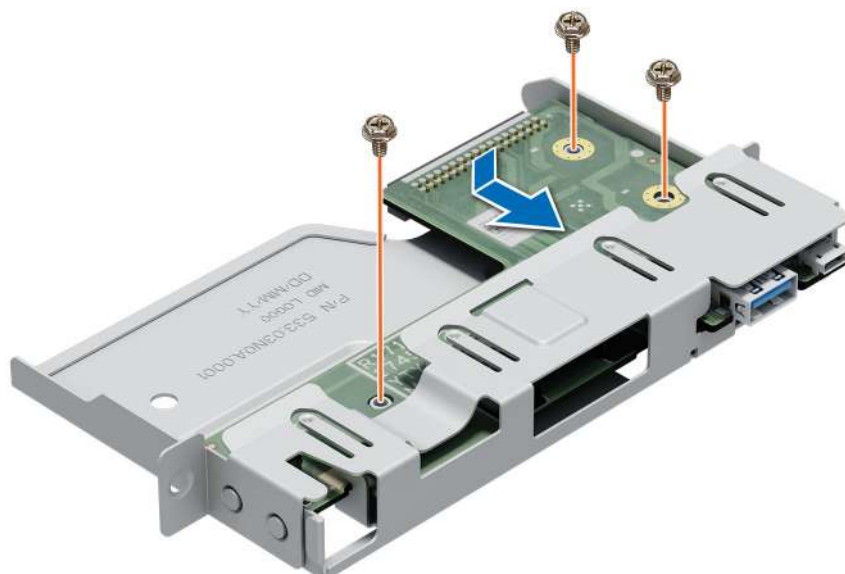
## Installing the control panel

### Prerequisites

1. Follow the safety guidelines listed in the [Safety instructions](#).
2. Follow the procedure listed in [Before working inside your system](#).

### Steps

1. Align and insert the control panel into the control panel cage.
2. Using the Phillips 2 screwdriver, secure the control panel to the cage with screws.



**Figure 61. Installing the control panel**

### Next steps

1. Connect the control panel cable to the control panel.
2. [Install the control panel cage.](#)
3. Follow the procedure listed in [After working inside your system.](#)

## Installing the control panel cage

### Prerequisites

1. Follow the safety guidelines listed in the [Safety instructions.](#)
2. Follow the procedure listed in [Before working inside your system.](#)

### Steps

1. Align and insert the control panel cage into the control panel cage slot in the system.
2. Secure the control panel cage to the system with screws.
3. Route the control panel cable and control panel USB cable through the system clip.
4. Connect the control panel cable and control panel USB cable to the system board.



**Figure 62. Installing the control panel cage**

### Next steps

1. [Install the front bezel.](#)
2. Reconnect the disconnected peripherals from the control panel assembly.
3. Follow the procedure listed in [After working inside your system.](#)

## Jumpers and connectors

This section provides essential and specific information about jumpers and switches. It also describes the connectors on the various boards in the system. Jumpers on the system board help to disable the system and reset the passwords. To install components and cables correctly, you must be able to identify the connectors on the system board.

### Topics:

- [System board connectors](#)
- [System board jumper settings](#)
- [Disabling a forgotten password](#)

## System board connectors

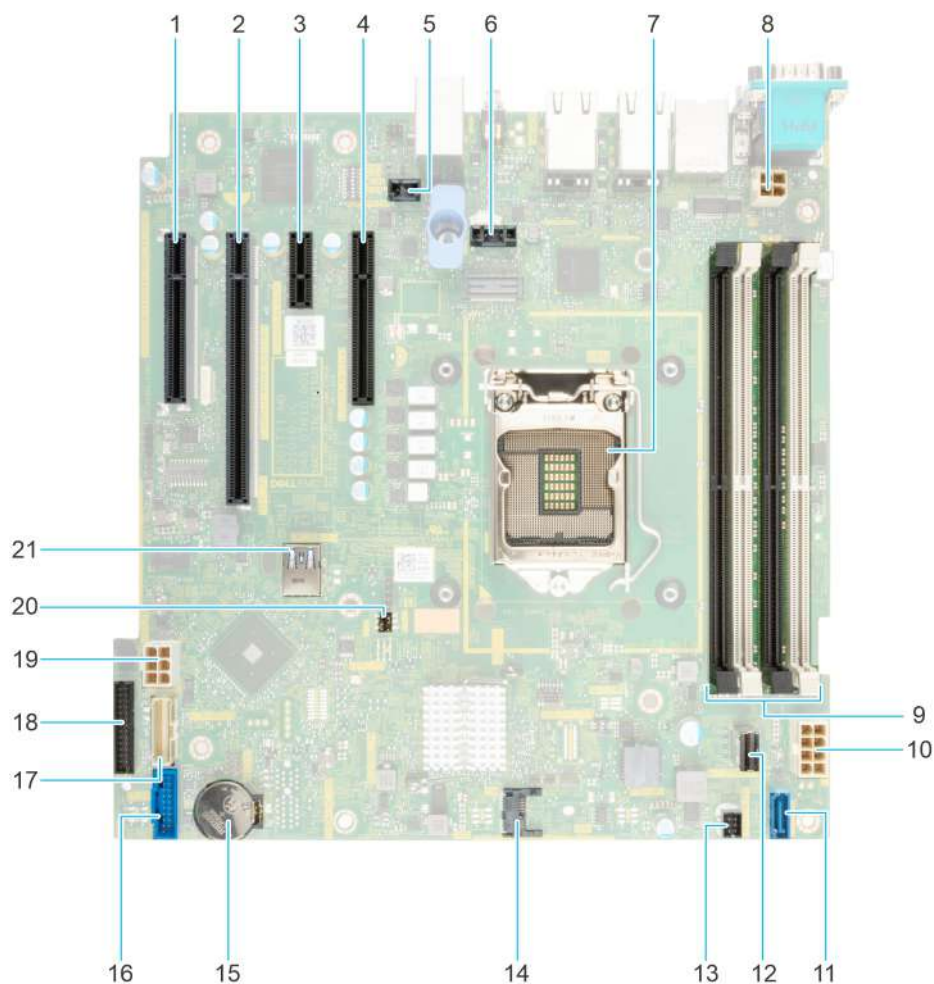


Figure 63. System board jumpers and connectors

Table 17. System board jumpers and connectors

Item	Connector	Description
1	Slot 1: PCIe_G4_X4 CPU	PCIe card connector 1







**Table 17. System board jumpers and connectors (continued)**

Item	Connector	Description
2	Slot 2: PCIe_G4_X16 CPU	PCIe card connector 2
3	Slot 3: PCIe_G3_X1 PCH	PCIe card connector 3
4	Slot 4: PCIe_G3_X4 PCH	PCIe card connector 4
5	T_INTRUSION	Intrusion connector
6	SYSTEM FAN	System cooling fan connector
7	CPU	Processor socket
8	PWR_CPU 1	CPU power connector P2
9	A3, A1, A4, A2	Memory module sockets
10	PWR_SYSTEM 1	System power connector P1
11	SATA_ODD/HDD	Optical disk drive connector
12	SATA 0-3	Mini SAS connector
13	FAN 4/ CPU_FAN	CPU fan connector
14	TPM	Trusted platform module connector
15	BATTERY	CMOS Battery connector
16	FP_USB	Front panel USB connector
17	CTRL_PNL	Control panel
18	PIB connector	PIB connector
19	HDD/ODD_POWER	Hard drive power connector
20	Jumper	NVRAM / Reset BIOS password jumper
21	INT_USB_3.0	Internal USB connector

## System board jumper settings

For information about resetting the password jumper to disable a password, see the [Disabling a forgotten password](#) section.

**Table 18. System board jumper settings**

Jumper	Setting	Description
PWRD_EN	 2 4 6 (default)	The BIOS password feature is enabled.
	 2 4 6	The BIOS password feature is disabled. The BIOS password is now disabled and you are not allowed to set a new password.
NVRAM_CLR	 1 3 5 (default)	The BIOS configuration settings are retained at system boot.
	 1 3 5	The BIOS configuration settings are cleared at system boot.

**CAUTION:** You should be cautious when changing the BIOS settings. The BIOS interface is designed for advanced users. Any changes in the setting might prevent your system from starting correctly and may even result in data loss.

# Disabling a forgotten password

The software security features of the system include a system password and a setup password. The password jumper enables or disables password features and clears any password(s) currently in use.

## Prerequisites

**CAUTION:** Many repairs may only be done by a certified service technician. You should only perform troubleshooting and simple repairs as authorized in your product documentation, or as directed by the online or telephone service and support team. Damage due to servicing that is not authorized by Dell is not covered by your warranty. Read and follow the safety instructions that are shipped with your product.

## Steps

1. Power off the system and all attached peripherals. Disconnect the system from the electrical outlet, and disconnect the peripherals.
2. Remove the system cover.
3. Move the jumper on the system board from pins 2 and 4 to pins 4 and 6.
4. Replace the system cover.
  - NOTE:** The existing passwords are not disabled (erased) until the system boots with the jumper on pins 4 and 6. However, before you assign a new system and/or setup password, you must move the jumper back to pins 2 and 4.
  - NOTE:** If you assign a new system and/or setup password with the jumper on pins 4 and 6, the system disables the new password(s) the next time it boots.
5. Reconnect the peripherals and connect the system to the electrical outlet, and then power on the system.
6. Power off the system.
7. Remove the system cover.
8. Move the jumper on the system board from pins 4 and 6 to pins 2 and 4.
9. Replace the system cover.
10. Reconnect the peripherals and connect the system to the electrical outlet, and then power on the system.
11. Assign a new system and/or setup password.

# System diagnostics and indicator codes

This section describes the diagnostic indicators on the system front panel that displays the system status during system startup.

## Topics:

- [System health and system ID indicator codes](#)
- [iDRAC Direct LED indicator codes](#)
- [NIC indicator codes](#)
- [Non-redundant cabled power supply unit indicator codes](#)
- [Using system diagnostics](#)

## System health and system ID indicator codes

The system health and system ID indicator is located on the front panel of the system.



Figure 64. System health and system ID indicator

Table 19. System health and system ID indicator codes

System health and system ID indicator code	Condition
Solid blue	Indicates that the system is powered on, is healthy, and system ID mode is not active. Press the system health and system ID button to switch to system ID mode.
Blinking blue	Indicates that the system ID mode is active. Press the system health and system ID button to switch to system health mode.
Solid amber	Indicates that the system is in fail-safe mode. If the problem persists, see the <a href="#">Getting help</a> section.
Blinking amber	Indicates that the system is experiencing a fault. Check the System Event Log for specific error messages. For information about the event and error messages generated by the system firmware and agents that monitor system components, go to <a href="http://qrl.dell.com">qrl.dell.com</a> > <b>Look Up</b> > <b>Error Code</b> , type the error code, and then click <b>Look it up</b> .

## iDRAC Direct LED indicator codes

The iDRAC Direct LED indicator lights up to indicate that the port is connected and is being used as a part of the iDRAC subsystem.

You can configure iDRAC Direct by using a USB to micro USB (type AB) cable, which you can connect to your laptop or tablet. Cable length should not exceed 3 feet (0.91 meters). Performance could be affected by cable quality. The following table describes iDRAC Direct activity when the iDRAC Direct port is active:

Table 20. iDRAC Direct LED indicator codes

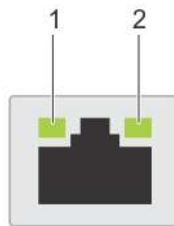
iDRAC Direct LED indicator code	Condition
Solid green for two seconds	Indicates that the laptop or tablet is connected.

**Table 20. iDRAC Direct LED indicator codes (continued)**

iDRAC Direct LED indicator code	Condition
Blinking green (on for two seconds and off for two seconds)	Indicates that the laptop or tablet connected is recognized.
LED Indicator off	Indicates that the laptop or tablet is unplugged.

## NIC indicator codes

Each NIC on the back of the system has indicators that provide information about the activity and link status. The activity LED indicator indicates if data is flowing through the NIC, and the link LED indicator indicates the speed of the connected network.



**Figure 65. NIC indicator codes**

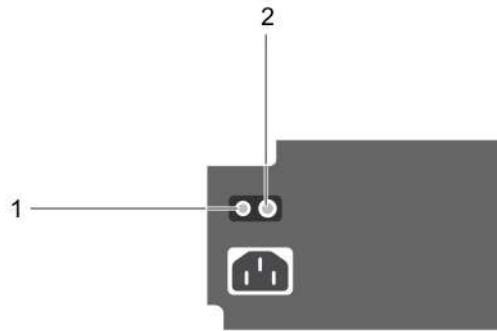
1. Link LED indicator
2. Activity LED indicator

**Table 21. NIC indicator codes**

NIC indicator codes	Condition
Link and activity indicators are off.	Indicates that the NIC is not connected to the network.
Link indicator is green, and activity indicator is blinking green.	Indicates that the NIC is connected to a valid network at its maximum port speed, and data is being sent or received.
Link indicator is amber, and activity indicator is blinking green.	Indicates that the NIC is connected to a valid network at less than its maximum port speed, and data is being sent or received.
Link indicator is green, and activity indicator is off.	Indicates that the NIC is connected to a valid network at its maximum port speed, and data is not being sent or received.
Link indicator is amber, and activity indicator is off.	Indicates that the NIC is connected to a valid network at less than its maximum port speed, and data is not being sent or received.
Link indicator is blinking green, and activity is off.	Indicates that the NIC identity is enabled through the NIC configuration utility.

## Non-redundant cabled power supply unit indicator codes

Press the self-diagnostic button to perform a quick health check on the non-redundant cabled power supply unit (PSU) of the system.



**Figure 66. Non-redundant cabled AC PSU status indicator and self-diagnostic button**

1. Self-diagnostic button
2. AC PSU status indicator

**Table 22. Non-redundant AC PSU status indicator**

Power Indicator Pattern	Condition
Not lit	Power is not connected or PSU is faulty.
Green	A valid power source is connected to the PSU and the PSU is operational.

## Using system diagnostics

If you experience an issue with the system, run the system diagnostics before contacting Dell for technical assistance. The purpose of running system diagnostics is to test the system hardware without using additional equipment or risking data loss. If you are unable to fix the issue yourself, service and support personnel can use the diagnostics results to help you solve the issue.

## Dell Embedded System Diagnostics

**NOTE:** The Dell Embedded System Diagnostics is also known as Enhanced Pre-boot System Assessment (ePSA) diagnostics.

The Embedded System Diagnostics provide a set of options for particular device groups or devices allowing you to:

- Run tests automatically or in an interactive mode
- Repeat tests
- Display or save test results
- Run thorough tests to introduce additional test options to provide extra information about the failed device(s)
- View status messages that inform you if tests are completed successfully
- View error messages that inform you of issues encountered during testing

## Running the Embedded System Diagnostics from the Dell Lifecycle Controller

### Steps

1. When the system is booting, press F10.
2. Select **Hardware Diagnostics** → **Run Hardware Diagnostics**.

The **ePSA Pre-boot System Assessment** window is displayed, listing all devices detected in the system. The diagnostics start executing the tests on all the detected devices.

## Running the Embedded System Diagnostics from Boot Manager

Run the Embedded System Diagnostics (ePSA) if your system does not boot.

### Steps

1. When the system is booting, press F11.
2. Use the up arrow and down arrow keys to select **System Utilities > Launch Diagnostics**.
3. Alternatively, when the system is booting, press F10, select **Hardware Diagnostics > Run Hardware Diagnostics**.  
The **ePSA Pre-boot System Assessment** window is displayed, listing all devices detected in the system. The diagnostics starts executing the tests on all the detected devices.

## System diagnostic controls

Table 23. System diagnostic controls

Menu	Description
<b>Configuration</b>	Displays the configuration and status information of all detected devices.
<b>Results</b>	Displays the results of all tests that are run.
<b>System health</b>	Provides the current overview of the system performance.
<b>Event log</b>	Displays a time-stamped log of the results of all tests run on the system. This is displayed if at least one event description is recorded.

# Getting help

## Topics:

- [Recycling or End-of-Life service information](#)
- [Contacting Dell Technologies](#)
- [Accessing system information by using QRL](#)
- [Receiving automated support with SupportAssist](#)

## Recycling or End-of-Life service information

Take back and recycling services are offered for this product in certain countries. If you want to dispose of system components, visit [www.dell.com/recyclingworldwide](http://www.dell.com/recyclingworldwide) and select the relevant country.

## Contacting Dell Technologies

Dell provides online and telephone based support and service options. If you do not have an active internet connection, you can find Dell contact information on your purchase invoice, packing slip, bill or Dell product catalog. The availability of services varies depending on the country and product, and some services may not be available in your area. To contact Dell for sales, technical assistance, or customer service issues follow these steps:

### Steps

1. Go to [www.dell.com/support/home](http://www.dell.com/support/home).
2. Select your country from the drop-down menu on the lower right corner of the page.
3. For customized support:
  - a. Enter the system Service Tag in the **Enter a Service Tag, Serial Number, Service Request, Model, or Keyword** field.
  - b. Click **Search**.  
The support page that lists the various support categories is displayed.
4. For general support:
  - a. Select your product category.
  - b. Select your product segment.
  - c. Select your product.  
The support page that lists the various support categories is displayed.
5. For contact details of Dell Global Technical Support:
  - a. Click [Contact Technical Support](#).
  - b. The **Contact Technical Support** page is displayed with details to call, chat, or e-mail the Dell Global Technical Support team.

## Accessing system information by using QRL

The QRL is found on a sticker on the rear of the system.

### Prerequisites

Ensure that your smartphone or tablet has a QR code scanner installed.

The QRL includes the following information about your system:

- How-to videos

- Reference materials, including the Installation and Service Manual, and mechanical overview
- The system service tag to quickly access the specific hardware configuration and warranty information
- A direct link to Dell to contact technical assistance and sales teams

#### Steps

1. Go to [www.dell.com/qrl](http://www.dell.com/qrl), and navigate to your specific product or
2. Use your smart phone or tablet to scan the model-specific Quick Resource (QR) code on your system or in the Quick Resource Locator section.

## Quick Resource Locator for PowerEdge T150 system



Figure 67. Quick Resource Locator for PowerEdge T150 system

## Receiving automated support with SupportAssist

Dell EMC SupportAssist is an optional Dell EMC Services offering that automates technical support for your Dell EMC server, storage, and networking devices. By installing and setting up a SupportAssist application in your IT environment, you can receive the following benefits:

- Automated issue detection — SupportAssist monitors your Dell EMC devices and automatically detects hardware issues, both proactively and predictively.
- Automated case creation — When an issue is detected, SupportAssist automatically opens a support case with Dell EMC Technical Support.
- Automated diagnostic collection — SupportAssist automatically collects system state information from your devices and uploads it securely to Dell EMC. This information is used by Dell EMC Technical Support to troubleshoot the issue.
- Proactive contact — A Dell EMC Technical Support agent contacts you about the support case and helps you resolve the issue.




The available benefits vary depending on the Dell EMC Service entitlement purchased for your device. For more information about SupportAssist, go to [www.dell.com/supportassist](http://www.dell.com/supportassist).

## Documentation resources

This section provides information about the documentation resources for your system.

To view the document that is listed in the documentation resources table:

- From the Dell EMC support site:
  1. Click the documentation link that is provided in the Location column in the table.
  2. Click the required product or product version.
-  **NOTE:** To locate the model number, see the front of your system.
- 3. On the Product Support page, click **Documentation**.
- Using search engines:
  - Type the name and version of the document in the search box.

**Table 24. Additional documentation resources for your system**

Task	Document	Location
Setting up your system	For information about setting up your system, see the <i>Getting Started Guide</i> document that is shipped with your system.	<a href="http://www.dell.com/poweredgemanuals">www.dell.com/poweredgemanuals</a>
Configuring your system	For information about the iDRAC features, configuring and logging in to iDRAC, and managing your system remotely, see the Integrated Dell Remote Access Controller User's Guide.	<a href="http://www.dell.com/poweredgemanuals">www.dell.com/poweredgemanuals</a>
	For information about understanding Remote Access Controller Admin (RACADM) subcommands and supported RACADM interfaces, see the RACADM CLI Guide for iDRAC.	
	For information about Redfish and its protocol, supported schema, and Redfish Eventing implemented in iDRAC, see the Redfish API Guide.	
	For information about iDRAC property database group and object descriptions, see the Attribute Registry Guide.	
	For information about Intel QuickAssist Technology, see the Integrated Dell Remote Access Controller User's Guide.	
	For information about earlier versions of the iDRAC documents.  To identify the version of iDRAC available on your system, on the iDRAC web interface, click <b>? &gt; About</b> .	<a href="http://www.dell.com/idracmanuals">www.dell.com/idracmanuals</a>
	For information about installing the operating system, see the operating system documentation.	<a href="http://www.dell.com/operatingsystemmanuals">www.dell.com/operatingsystemmanuals</a>
	For information about updating drivers and firmware, see the Methods to download firmware and drivers section in this document.	<a href="http://www.dell.com/support/drivers">www.dell.com/support/drivers</a>

**Table 24. Additional documentation resources for your system (continued)**

Task	Document	Location
Managing your system	For information about systems management software offered by Dell, see the Dell OpenManage Systems Management Overview Guide.	<a href="http://www.dell.com/poweredgemanuals">www.dell.com/poweredgemanuals</a>
	For information about setting up, using, and troubleshooting OpenManage, see the Dell OpenManage Server Administrator User's Guide.	<a href="http://www.dell.com/openmanagemanuals">www.dell.com/openmanagemanuals</a> > OpenManage Server Administrator
	For information about installing and using Dell SupportAssist, see the Dell EMC SupportAssist Enterprise User's Guide.	<a href="https://www.dell.com/serviceabilitytools">https://www.dell.com/serviceabilitytools</a>
	For information about partner programs enterprise systems management, see the OpenManage Connections Enterprise Systems Management documents.	<a href="http://www.dell.com/openmanagemanuals">www.dell.com/openmanagemanuals</a>
Working with the Dell PowerEdge RAID controllers	For information about understanding the features of the Dell PowerEdge RAID controllers (PERC), Software RAID controllers, or BOSS card and deploying the cards, see the Storage controller documentation.	<a href="http://www.dell.com/storagecontrollermanuals">www.dell.com/storagecontrollermanuals</a>
Understanding event and error messages	For information about the event and error messages generated by the system firmware and agents that monitor system components, go to <a href="http://qrl.dell.com">qrl.dell.com</a> > <b>Look Up</b> > <b>Error Code</b> , type the error code, and then click <b>Look it up</b> .	<a href="http://www.dell.com/qrl">www.dell.com/qrl</a>
Troubleshooting your system	For information about identifying and troubleshooting the PowerEdge server issues, see the Server Troubleshooting Guide.	<a href="http://www.dell.com/poweredgemanuals">www.dell.com/poweredgemanuals</a>

## Free Manuals Download Website

<http://myh66.com>

<http://usermanuals.us>

<http://www.somanuals.com>

<http://www.4manuals.cc>

<http://www.manual-lib.com>

<http://www.404manual.com>

<http://www.luxmanual.com>

<http://aubethermostatmanual.com>

Golf course search by state

<http://golfingnear.com>

Email search by domain

<http://emailbydomain.com>

Auto manuals search

<http://auto.somanuals.com>

TV manuals search

<http://tv.somanuals.com>