

Dell B3460dn Laser Printer

User's Guide



June 2012

www.dell.com | support.dell.com

Trademarks

Information in this document is subject to change without notice.

© 2012 Dell, Inc. All rights reserved.

Reproduction of this material in any manner whatsoever without the written permission of Dell Inc. is strictly forbidden.

Trademarks used in this text: *Dell*, the *DELL* logo, *Inspiron*, *Dell Precision*, *Dimension*, *OptiPlex*, *Latitude*, *PowerEdge*, *PowerVault*, *PowerApp*, and *Dell OpenManage* are trademarks of Dell Inc.; *Intel*, *Pentium*, and *Celeron* are registered trademarks of Intel Corporation; *Microsoft* and *Windows* are registered trademarks of Microsoft Corporation.

Other trademarks and trade names may be used in this document to refer to the entities claiming the marks and names of their products. Dell Inc. disclaims any proprietary interest in trademarks and trade names other than its own.

Contents

- Safety information.....6**
- Learning about the printer.....8**
 - Finding information about the printer.....8
 - Selecting a location for the printer.....9
 - Printer configurations.....10
 - Using the printer control panel.....11
 - Understanding the colors of the indicator and Sleep button lights.....12
- Additional printer setup.....13**
 - Installing internal options.....13
 - Installing hardware options.....17
 - Attaching cables.....19
 - Setting up the printer software.....20
 - Networking.....22
 - Connecting the printer to a wireless network using the Embedded Web Server.....25
 - Verifying printer setup.....26
- Loading paper and specialty media.....27**
 - Setting the paper size and type.....27
 - Configuring Universal paper settings.....27
 - Using the standard bin and paper stop.....27
 - Loading trays.....28
 - Loading the multipurpose feeder.....32
 - Linking and unlinking trays.....35
 - Linking and unlinking trays35
 - Creating a custom name for a paper type35
 - Assigning a custom paper type name36
 - Assigning a custom paper type37
- Paper and specialty media guide.....38**
 - Paper guidelines.....38
 - Using specialty media.....40
 - Supported paper sizes, types, and weights.....43

Printing.....	46
Printing a document.....	46
Printing a document	46
Adjusting toner darkness.....	46
Printing from a mobile device.....	47
Printing from a flash drive.....	47
Printing from a flash drive	47
Supported flash drives and file types.....	49
Printing confidential and other held jobs.....	49
Printing confidential and other held jobs	49
Printing information pages.....	50
Printing a font sample list	50
Printing a directory list.....	50
Canceling a print job.....	50
Canceling a print job from the printer control panel.....	50
Canceling a print job from the computer	51
Understanding the printer menus.....	52
Menus list.....	52
Paper menu.....	53
Reports menu.....	61
Network/Ports menu.....	62
Security menu.....	70
Settings menu.....	72
Help menu.....	85
Saving money and the environment.....	87
Saving paper and toner.....	87
Saving energy.....	87
Recycling.....	90
Securing the printer.....	91
Using the security lock feature.....	91
Statement of Volatility.....	91
Erasing volatile memory.....	92
Erasing non-volatile memory.....	92
Finding printer security information.....	92

Maintaining the printer.....93

- Cleaning the printer.....93
- Checking the status of parts and supplies.....93
- Estimated number of remaining pages.....94
- Ordering supplies.....94
- Storing supplies.....95
- Replacing supplies.....95
- Moving the printer.....99

Managing the printer.....101

- Managing printer messages.....101
- Accessing Status Monitor Center.....101
- Checking the virtual display.....101
- Viewing reports.....102
- Configuring supply notifications from the Embedded Web Server.....102
- Modifying confidential print settings.....103
- Copying printer settings to other printers.....103
- Restoring factory default settings.....104

Clearing jams.....105

- Avoiding jams.....105
- Understanding jam messages and locations.....106
- [x]-page jam, open front door. [20y.xx].....108
- [x]-page jam, open rear door. [20y.xx].....111
- [x]-page jam, clear standard bin. [20y.xx].....112
- [x]-page jam, remove tray 1 to clear duplex. [23y.xx].....113
- [x]-page jam, open tray [x]. [24y.xx].....114
- [x]-page jam, clear manual feeder. [25y.xx].....115

Troubleshooting.....117

- Understanding the printer messages.....117
- Solving printer problems.....127
- Solving print problems.....133
- Embedded Web Server does not open.....156
- Contacting technical support.....158

Appendix.....159

Index.....161

Safety information

Connect the power cord to a properly grounded electrical outlet that is near the product and easily accessible.

Do not place or use this product near water or wet locations.

 **CAUTION—POTENTIAL INJURY:** This product uses a laser. Use of controls or adjustments or performance of procedures other than those specified herein may result in hazardous radiation exposure.

This product uses a printing process that heats the print media, and the heat may cause the media to release emissions. You must understand the section in your operating instructions that discusses the guidelines for selecting print media to avoid the possibility of harmful emissions.

 **CAUTION—POTENTIAL INJURY:** The lithium battery in this product is not intended to be replaced. There is a danger of explosion if a lithium battery is incorrectly replaced. Do not recharge, disassemble, or incinerate a lithium battery. Discard used lithium batteries according to the manufacturer's instructions and local regulations.

 **CAUTION—POTENTIAL INJURY:** Before moving the printer, follow these guidelines to avoid personal injury or printer damage:

- Turn the printer off using the power switch, and then unplug the power cord from the electrical outlet.
- Disconnect all cords and cables from the printer before moving it.
- If an optional tray is installed, then remove it from the printer. To remove the optional tray, slide the latch on the right side of the tray toward the front of the tray until it *clicks* into place.
- Use the handholds located on both sides of the printer to lift it.
- Make sure your fingers are not under the printer when you set it down.
- Before setting up the printer, make sure there is adequate clearance around it.

Use only the power cord provided with this product or the manufacturer's authorized replacement.

 **CAUTION—HOT SURFACE:** The inside of the printer might be hot. To reduce the risk of injury from a hot component, allow the surface to cool before touching.

 **CAUTION—SHOCK HAZARD:** If you are accessing the controller board or installing optional hardware or memory devices sometime after setting up the printer, then turn the printer off, and unplug the power cord from the electrical outlet before continuing. If you have any other devices attached to the printer, then turn them off as well, and unplug any cables going into the printer.

 **CAUTION—SHOCK HAZARD:** Make sure that all external connections (such as Ethernet and telephone system connections) are properly installed in their marked plug-in ports.

This product is designed, tested, and approved to meet strict global safety standards with the use of specific manufacturer's components. The safety features of some parts may not always be obvious. The manufacturer is not responsible for the use of other replacement parts.

 **CAUTION—POTENTIAL INJURY:** Do not cut, twist, bind, crush, or place heavy objects on the power cord. Do not subject the power cord to abrasion or stress. Do not pinch the power cord between objects such as furniture and walls. If any of these things happen, a risk of fire or electrical shock results. Inspect the power cord regularly for signs of such problems. Remove the power cord from the electrical outlet before inspecting it.

Refer service or repairs, other than those described in the user documentation, to a service representative.

 **CAUTION—SHOCK HAZARD:** To avoid the risk of electrical shock when cleaning the exterior of the printer, unplug the power cord from the electrical outlet and disconnect all cables from the printer before proceeding.



CAUTION—POTENTIAL INJURY: To reduce the risk of equipment instability, load each tray separately. Keep all other trays closed until needed.



CAUTION—SHOCK HAZARD: Do not set up this product or make any electrical or cabling connections, such as the fax feature, power cord, or telephone, during a lightning storm.

SAVE THESE INSTRUCTIONS.

Learning about the printer

Finding information about the printer

What are you looking for?	Find it here
Initial setup instructions: <ul style="list-style-type: none"> • Connecting the printer • Installing the printer software 	Setup documentation—The setup documentation came with the printer.
Additional setup and instructions for using the printer: <ul style="list-style-type: none"> • Selecting and storing paper and specialty media • Loading paper • Configuring printer settings • Viewing and printing documents and photos • Setting up and using the printer software • Configuring the printer on a network • Caring for and maintaining the printer • Troubleshooting and solving problems 	<i>User's Guide</i> and <i>Quick Reference Guide</i> —The guides are available on the <i>Software and Documentation CD</i> . For updates, visit our Web site at http://support.dell.com .
Instructions for: <ul style="list-style-type: none"> • Connecting the printer to an Ethernet network • Troubleshooting printer connection problems 	<i>Networking Guide</i> —Open the <i>Software and Documentation CD</i> , and then look for <i>Printer and Software Documentation</i> under the Pubs folder. From the list of publications, click the Networking Guide link.
Help using the printer software	Windows or Mac Help—Open a printer software program or application, and then click Help . Click  to view context-sensitive information. Notes: <ul style="list-style-type: none"> • Help is automatically installed with the printer software. • The printer software is located in the printer program folder or on the desktop, depending on your operating system.
The latest supplemental information, updates, and technical support: <ul style="list-style-type: none"> • Documentation • Driver downloads • Product upgrades • Service call and repair information • Order status • Live chat support • E-mail support • Voice support 	Dell Support Web site— http://support.dell.com Support telephone numbers and hours of operation for your country or region can be found on the Support Web site. Have the following information ready when you contact support so that they may serve you faster: <ul style="list-style-type: none"> • service tag • express service Code Note: The service tag and express service code appear on labels located on your printer.

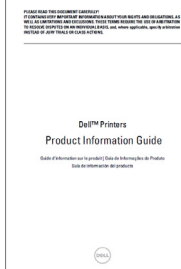
What are you looking for?	Find it here
<ul style="list-style-type: none"> • Software and Drivers—Certified drivers for my printer and installers for Dell printer software • Readme files—Last-minute technical changes, or advanced technical reference materials for experienced users or technicians 	<p><i>Software and Documentation CD</i></p>
<ul style="list-style-type: none"> • Supplies and accessories for my printer • Replacement cartridges 	<p>Dell Printer Supplies Web site—http://dell.com/supplies You can purchase printer supplies online, by telephone, or in select retail stores.</p>
<ul style="list-style-type: none"> • Safety information for preparing to operate my printer • Regulatory information • Warranty information 	<p><i>Product Information Guide</i></p>  <p>Note: The <i>Product Information Guide</i> may not be available in your country or region.</p>

Selecting a location for the printer

When selecting a location for the printer, leave enough room to open trays, covers, and doors. If you plan to install any hardware options, then leave enough room for them also. It is important to:

- Set up the printer near a properly grounded and easily accessible electrical outlet.
- Make sure airflow in the room meets the latest revision of the ASHRAE 62 standard or the CEN Technical Committee 156 standard.
- Provide a flat, sturdy, and stable surface.
- Keep the printer:
 - Clean, dry, and free of dust.
 - Away from stray staples and paper clips.
 - Away from the direct airflow of air conditioners, heaters, or ventilators.
 - Free from direct sunlight and humidity extremes.
- Observe the recommended temperatures and avoid fluctuations.

Ambient temperature	16 to 32°C (60 to 90°F)
Storage temperature	-20 to 40°C (-4 to 104°F)

- Allow the following recommended amount of space around the printer for proper ventilation:

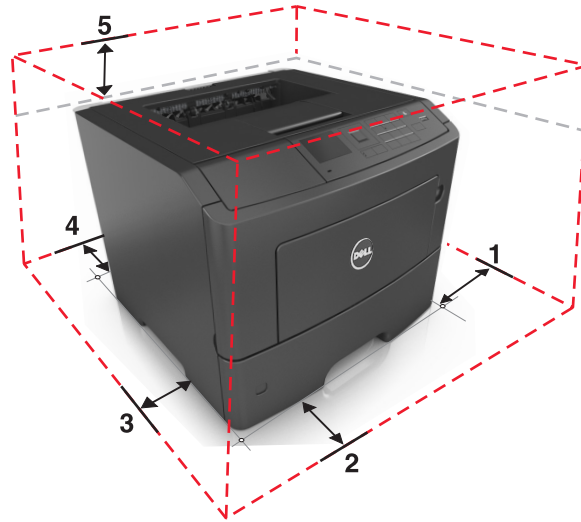

1	Right side	30 cm (12 in.)
2	Front	51 cm (20 in.)
3	Left side	20 cm (8 in.)
4	Rear	20 cm (8 in.)
5	Top	30 cm (12 in.)

Printer configurations

⚠ CAUTION—POTENTIAL INJURY: To reduce the risk of equipment instability, load each tray separately. Keep all other trays closed until needed.

You can configure your printer by adding up to two optional 550-sheet trays. For instructions on installing the optional trays, see “Installing optional trays” on page 17.

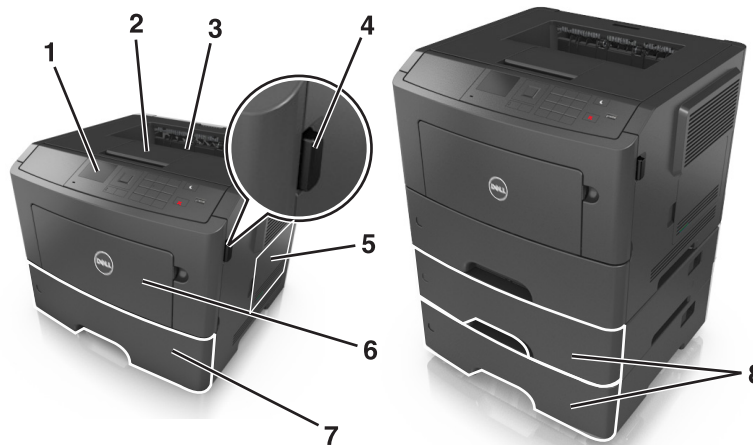

1	Printer control panel
2	Paper stop

3	Standard bin
4	Front door release button
5	Controller board access door
6	100-sheet multipurpose feeder
7	Standard 550-sheet tray
8	Optional 550-sheet trays

Using the printer control panel

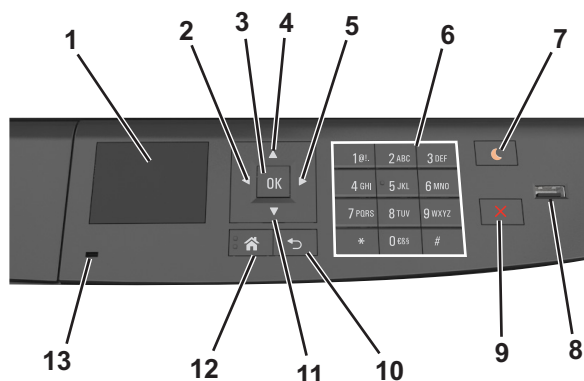

	Use the	To
1	Display	View the printer status and messages. Set up and operate the printer.
2	Left arrow button	Scroll to the left.
3	Select button	Select menu options. Save settings.
4	Up arrow button	Scroll up.
5	Right arrow button	Scroll to the right.
6	Keypad	Enter numbers, letters, or symbols.
7	Sleep button	Enable Sleep mode or Hibernate mode. The following actions wake the printer from Sleep mode: <ul style="list-style-type: none"> • Pressing any hard button • Opening a tray or the front door • Sending a print job from the computer • Performing a power-on reset using the main power switch • Attaching a device in the USB port
8	USB port	Connect a flash drive to the printer. Notes: <ul style="list-style-type: none"> • Only the front USB port supports flash drives. • This feature is available only in select printer models.

	Use the	To
9	Stop or cancel button	Stop all printer activities.
10	Back button	Return to the previous screen.
11	Down arrow button	Scroll down.
12	Home button	Go to the home screen.
13	Indicator light	Check the status of the printer.

Understanding the colors of the indicator and Sleep button lights

The colors of the indicator and Sleep button lights on the printer control panel signify a certain printer status or condition.

Indicator light color and its corresponding printer status

Indicator light	Printer status
Off	The printer is off or in Hibernate mode.
Blinking green	The printer is warming up, processing data, or printing.
Solid green	The printer is on, but idle.
Blinking red	The printer requires user intervention.

Sleep button light color and its corresponding printer status

Sleep button light	Printer status
Off	The printer is idle or in Ready state.
Solid amber	The printer is in Sleep mode.
Blinking amber	The printer is waking from or entering Hibernate mode.
Blinking amber for 0.1 second, then goes completely off for 1.9 seconds in pulsing pattern	The printer is in Hibernate mode.

Additional printer setup

Installing internal options

Notes:

- A Service Set Identifier (SSID) is a name assigned to a wireless network. Wired Equivalent Privacy (WEP), Wi-Fi Protected Access (WPA), WPA2, and 802.1X - RADIUS are types of security used on a network.

Available internal options

Memory cards

- DDR3 DIMM
- Flash memory
 - Fonts
 - Firmware
 - Forms Barcode
 - Prescribe
 - IPDS
 - Printcrypton

Accessing the controller board

⚠ CAUTION—SHOCK HAZARD: If you are accessing the controller board or installing optional hardware or memory devices sometime after setting up the printer, then turn the printer off, and unplug the power cord from the electrical outlet before continuing. If you have any other devices attached to the printer, then turn them off as well, and unplug any cables going into the printer.

- 1 Open the controller board access door.

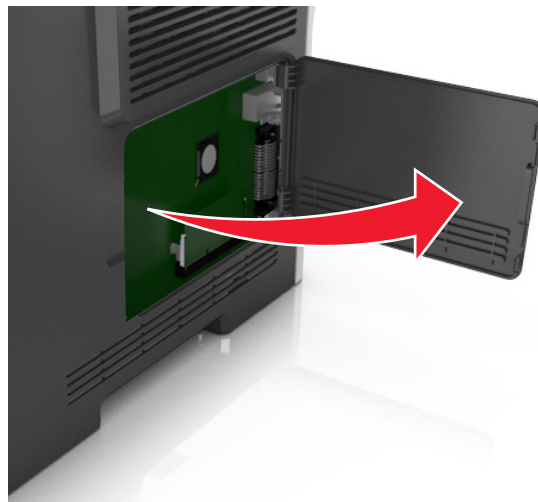

- 2 Use the following illustration to locate the appropriate connector.

Warning—Potential Damage: Controller board electronic components are easily damaged by static electricity. Touch a metal surface on the printer before touching any controller board electronic components or connectors.

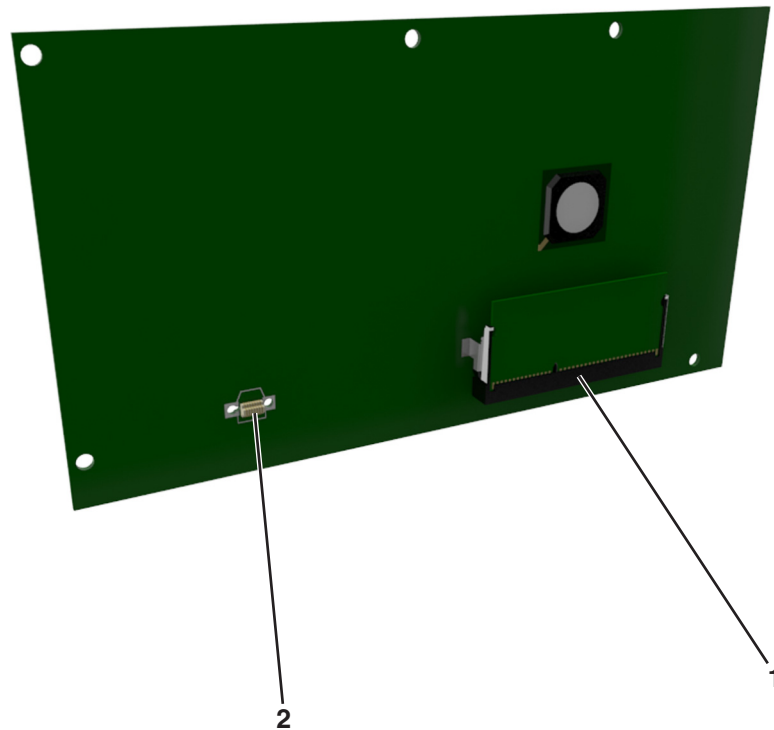

1	Memory card connector
2	Option card connector

Installing a memory card

CAUTION—SHOCK HAZARD: If you are accessing the controller board or installing optional hardware or memory devices sometime after setting up the printer, then turn the printer off, and unplug the power cord from the electrical outlet before continuing. If you have any other devices attached to the printer, then turn them off as well, and unplug any cables going into the printer.

Warning—Potential Damage: Controller board electronic components are easily damaged by static electricity. Touch a metal surface on the printer before touching any controller board electronic components or connectors.

An optional memory card can be purchased separately and attached to the controller board.

- 1 Access the controller board.

For more information, see “Accessing the controller board” on page 13.

- 2 Unpack the memory card.

Warning—Potential Damage: Do not touch the connection points along the edge of the card. Doing so may cause damage.

- 3 Align the notch (1) on the memory card with the ridge (2) on the connector.

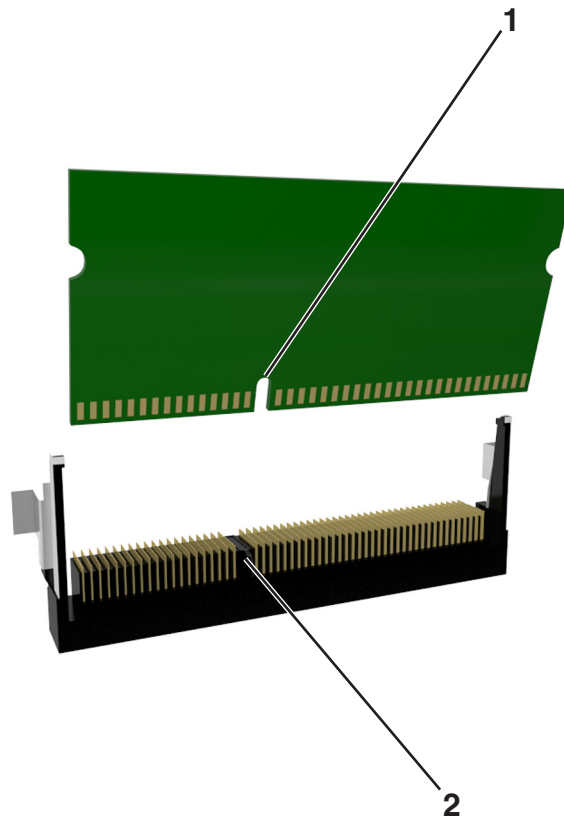

- 4 Push the memory card straight into the connector, and then push the card toward the controller board wall until it *clicks* into place.

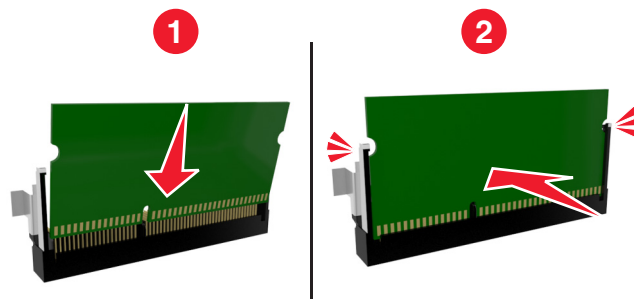

- 5 Close the controller board access door.

Note: When the printer software and any hardware options are installed, it may be necessary to manually add the options in the printer driver to make them available for print jobs. For more information, see “Updating available options in the printer driver” on page 21.

Installing an optional card

⚠ CAUTION—SHOCK HAZARD: If you are accessing the controller board or installing optional hardware or memory devices sometime after setting up the printer, then turn the printer off, and unplug the power cord from the electrical outlet before continuing. If you have other devices attached to the printer, then turn them off as well, and unplug any cables going into the printer.

Warning—Potential Damage: Controller board electronic components are easily damaged by static electricity. Touch a metal surface on the printer before touching any controller board electronic components or connectors.

1 Access the controller board.

For more information, see “Accessing the controller board” on page 13.

2 Unpack the optional card.

Warning—Potential Damage: Avoid touching the connection points along the edge of the card.

3 Holding the card by its sides, align the plastic pins (1) on the card with the holes (2) on the controller board.

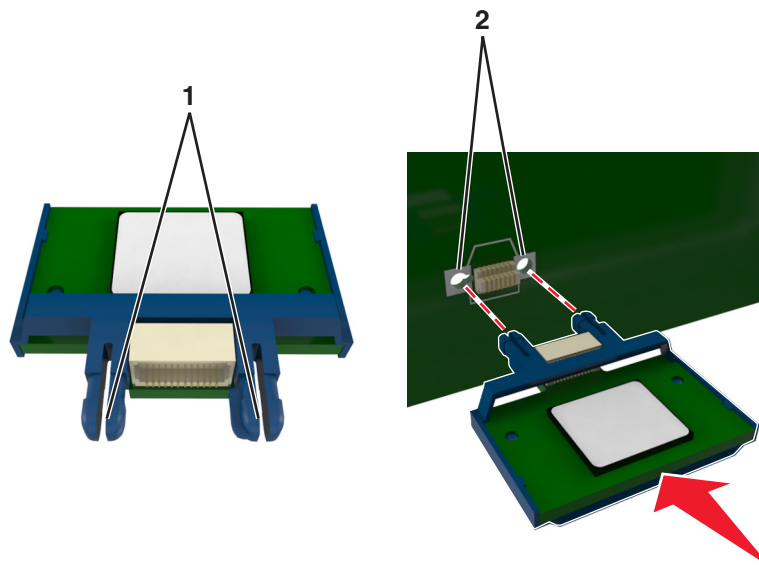

- 4 Push the card firmly into place as shown in the illustration.

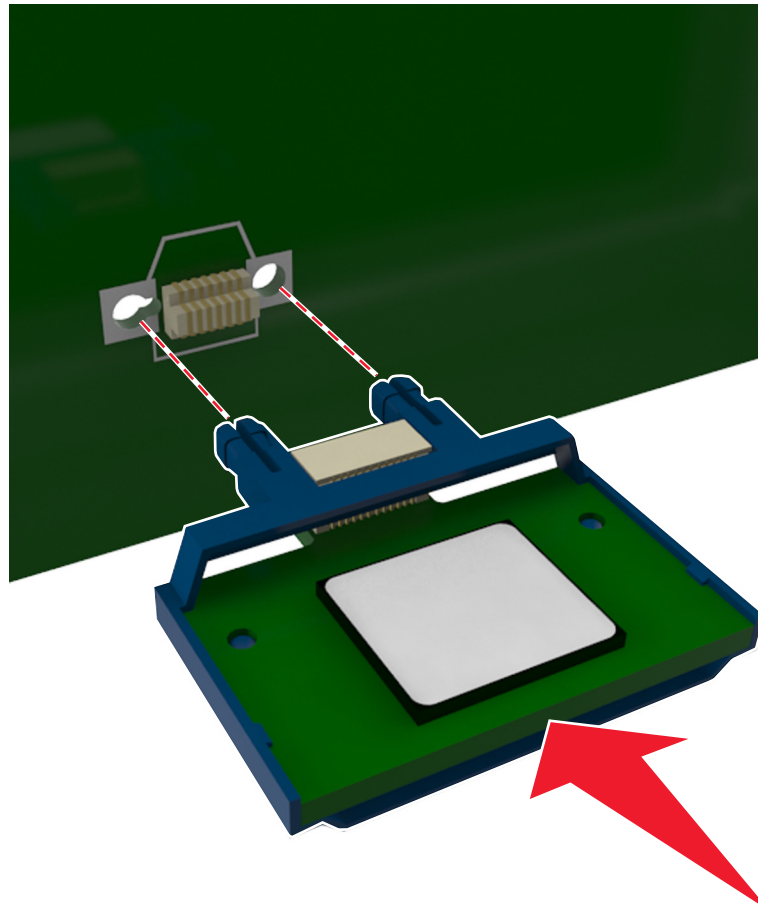

Warning—Potential Damage: Improper installation of the card may cause damage to the card and the controller board.

Note: The entire length of the connector on the card must touch and be flushed against the controller board.

- 5 Close the controller board access door.

Note: When the printer software and any hardware options are installed, it may be necessary to manually add the options in the printer driver to make them available for print jobs. For more information, see “Updating available options in the printer driver” on page 21.

Installing hardware options

Installing optional trays

CAUTION—SHOCK HAZARD: If you are accessing the controller board or installing optional hardware or memory devices sometime after setting up the printer, then turn the printer off, and unplug the power cord from the electrical outlet before continuing. If you have any other devices attached to the printer, then turn them off as well, and unplug any cables going into the printer.

- 1 Turn off the printer using the power switch, and then unplug the power cord from the electrical outlet.



- 2 Unpack the tray, and then remove all packing materials.
- 3 Pull the tray completely out of the base.

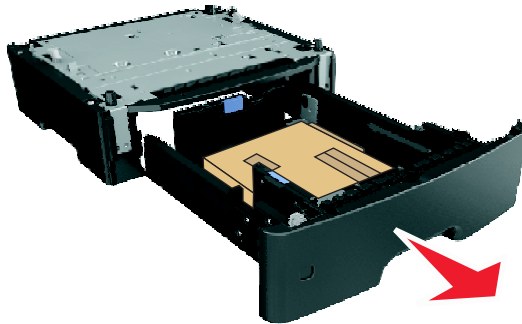

- 4 Remove any packing material from inside the tray.
- 5 Insert the tray into the base.
- 6 Place the tray near the printer.
- 7 Align the printer with the tray, and then lower the printer into place.

Note: Optional trays lock together when stacked.



8 Connect the power cord to the printer, then to a properly grounded electrical outlet, and then turn on the printer.



Note: When the printer software and any hardware options are installed, you may need to manually add the options in the printer driver to make them available for print jobs. For more information, see “Updating available options in the printer driver” on page 21.

To uninstall the optional trays, slide the latch on the right side of the printer toward the front of the printer until it *clicks* into place, and then remove stacked trays one at a time from the top to the bottom.

Attaching cables

Connect the printer to the computer using a USB or parallel cable, or to the network using an Ethernet cable.

Make sure to match the following:

- The USB symbol on the cable with the USB symbol on the printer
- The appropriate parallel cable with the parallel port

- The appropriate Ethernet cable with the Ethernet port

Warning—Potential Damage: Do not touch the USB cable, any network adapter, or the printer in the area shown while actively printing. Loss of data or a malfunction can occur.

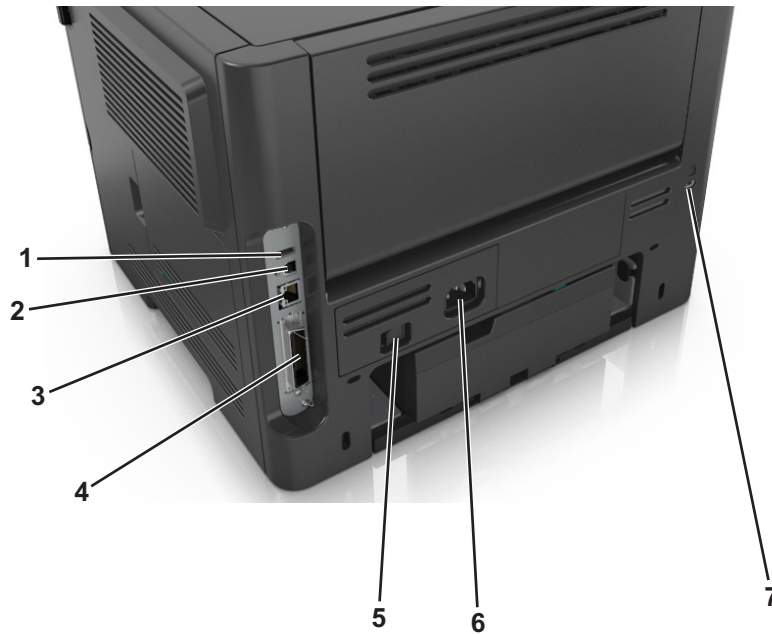

	Use the	To
1	USB port	Attach an optional wireless network adapter.
2	USB printer port	Connect the printer to a computer.
3	Ethernet port	Connect the printer to an Ethernet network.
4	Parallel port Note: This port is available only in select printer models.	Connect the printer to a computer.
5	Power switch	Turn on or turn off the printer.
6	Printer power cord socket	Connect the printer to an electrical outlet.
7	Security slot	Attach a lock that will secure the printer in place.

Setting up the printer software

Installing the printer software

Note: If you installed the printer software on the computer before but need to reinstall the software, then uninstall the current software first.

For Windows users

- 1 Close all open software programs.
- 2 Insert the *Software and Documentation* CD.

If the installation dialog screen does not appear after a minute, then launch the CD manually:

- a Click , or click **Start** and then click **Run**.
- b In the Start Search or Run dialog, type **D:\setup.exe**, where **D** is the letter of your CD or DVD drive.
- c Press **Enter**, or click **OK**.

3 Click **Install**, and then follow the instructions on the computer screen.

For Macintosh users

1 Close all open applications.

2 Insert the *Software and Documentation* CD.

If the installation dialog does not appear after a minute, then click the CD icon on the desktop.

3 Double-click the software installer package, and then follow the instructions on the computer screen.

Note: To take advantage of the full features of your printer, select the custom install option, and then select all packages listed.

Using the Internet

Updated printer software may be available at <http://support.dell.com>.

Updating available options in the printer driver

When the printer software and any hardware options are installed, you may need to manually add the options in the printer driver to make them available for print jobs.

For Windows users

1 Open the printers folder.

- a Click , or click **Start** and then click **Run**.
- b In the Start Search or Run dialog, type **control printers**.
- c Press **Enter**, or click **OK**.

2 Select the printer.

3 Right-click the printer, and then select **Properties**.

4 Click the **Configuration** tab.

5 Do either of the following:

- Click **Update Now - Ask Printer**.
- Under Configuration Options, manually add any installed hardware options.

6 Click **Apply**.

For Macintosh users

1 From the Apple menu, navigate to either of the following:

- **System Preferences > Print & Scan > select your printer > Options & Supplies > Driver**
- **System Preferences > Print & Fax > select your printer > Options & Supplies > Driver**

- 2 Add any installed hardware options, and then click **OK**.

Networking

Notes:

- Purchase a wireless network adapter first before setting up the printer on a wireless network. To install the wireless network adapter, see the instruction sheet that came with the adapter.
- A Service Set Identifier (SSID) is a name assigned to a wireless network. Wireless Equivalent Privacy (WEP), Wi-Fi Protected Access (WPA), WPA2, and 802.1X - RADIUS are types of security used on a network.

Preparing to set up the printer on an Ethernet network

To configure your printer to connect to an Ethernet network, organize the following information before you begin:

Note: If your network automatically assigns IP addresses to computers and printers, continue on to installing the printer.

- A valid, unique IP address for the printer to use on the network
- The network gateway
- The network mask
- A nickname for the printer (optional)

Note: A printer nickname can make it easier for you to identify your printer on the network. You can choose to use the default printer nickname, or assign a name that is easier for you to remember.

You will need an Ethernet cable to connect the printer to the network and an available port where the printer can physically connect to the network. Use a new network cable when possible to avoid potential problems caused by a damaged cable.

Installing the printer on an Ethernet network

For Windows users

- 1 Insert the *Software and Documentation* CD.

If the installation dialog does not appear after a minute, then launch the CD manually:

- a Click , or click **Start** and then click **Run**.
- b In the Start Search or Run dialog, type **D:\setup.exe**, where **D** is the letter of the CD or DVD drive.
- c Press **Enter**, or click **OK**.

- 2 Click **Install**, and then follow the instructions on the computer screen.

- 3 Select **Ethernet connection**, and then click **Continue**.

- 4 Attach the Ethernet cable when instructed to do so.

- 5 Select the printer from the list, and then click **Continue**.

Note: If the configured printer does not appear in the list, then click **Modify Search**.

- 6 Follow the instructions on the computer screen.

For Macintosh users

1 Allow the network DHCP server to assign an IP address to the printer.

2 Obtain the printer IP address either:

- From the printer control panel
- From the TCP/IP section in the Network/Ports menu
- By printing a network setup page or menu settings page, and then finding the TCP/IP section

Note: You will need the IP address if you are configuring access for computers on a different subnet than the printer.

3 Install the printer driver on the computer.

- a** Insert the *Software and Documentation* CD, and then double-click the installer package for the printer.
- b** Follow the instructions on the computer screen.
- c** Select a destination, and then click **Continue**.
- d** From the Easy Install screen, click **Install**.
- e** Type the user password, and then click **OK**.
All the necessary applications are installed on the computer.
- f** Click **Close** when installation is complete.

4 Add the printer.

- For IP printing:
 - a** From the Apple menu, navigate to either of the following:
 - **System Preferences > Print & Scan**
 - **System Preferences > Print & Fax**
 - b** Click +.
 - c** Click the **IP** tab.
 - d** Type the printer IP address in the address field, and then click **Add**.
- For AppleTalk printing:

Notes:

- Make sure AppleTalk is activated on your printer.
- This feature is supported only in Mac OS X version 10.5.

a From the Apple menu, navigate to:

System Preferences > Print & Fax

b Click +, and then navigate to:

AppleTalk > select your printer > Add

Preparing to set up the printer on a wireless network

Notes:

- Make sure your wireless network adapter is installed in your printer and working properly.
- Make sure your access point (wireless router) is turned on and is working properly.

Make sure you have the following information before setting up the printer on a wireless network:

- **SSID**—The SSID is also referred to as the network name.
- **Wireless Mode (or Network Mode)**—The mode is either infrastructure or ad hoc.
- **Channel (for ad hoc networks)**—The channel defaults to automatic for infrastructure networks.

Some ad hoc networks will also require the automatic setting. Check with your system support person if you are not sure which channel to select.

- **Security Method**—There are three basic options for Security Method:

- WEP key

If your network uses more than one WEP key, then enter up to four in the provided spaces. Select the key currently in use on the network by selecting the default WEP transmit key.

or

- WPA or WPA2 preshared key or passphrase

WPA includes encryption as an additional layer of security. The choices are AES or TKIP. Encryption must be set for the same type on the router and on the printer, or the printer will not be able to communicate on the network.

- 802.1X–RADIUS

If you are installing the printer on an 802.1X network, then you may need the following:

- Authentication type
- Inner authentication type
- 802.1X user name and password
- Certificates

- No security

If your wireless network does not use any type of security, then you will not have any security information.

Note: Using an unsecured wireless network is not recommended.

Notes:

- If you do not know the SSID of the network that your computer is connected to, then launch the wireless utility of the computer network adapter, and then look for the network name. If you cannot find the SSID or the security information for your network, then see the documentation that came with the access point, or contact your system support person.
- To find the WPA/WPA2 preshared key/passphrase for the wireless network, see the documentation that came with the access point, see the Web page associated with the access point, or consult your system support person.









Connecting the printer to a wireless network using Wi-Fi Protected Setup (WPS)

Before you begin, make sure that:

- The access point (wireless router) is WPS certified.
- A wireless network adapter is installed in the printer and is working properly. For more information, see the instruction sheet that came with the wireless network adapter.

Using the Push Button Configuration (PBC) method







1 From the printer control panel, navigate to:

 > Settings >  > Network/Ports >  > Network [x] >  > Network [x] Setup >  > Wireless >  > Wi-Fi Protected Setup >  > Start Push Button Method > 

2 Follow the instructions on the printer display.

Using the Personal Identification Number (PIN) method

1 From the printer control panel, navigate to:

 > Settings >  > Network/Ports >  > Network [x] > Wireless >  > Wi-Fi Protected Setup >  > Start PIN Method > 

2 Copy the eight-digit WPS PIN.

3 Open a Web browser, and then type the IP address of your access point in the address bar.

Notes:

- The IP address appears as four sets of numbers separated by periods, such as 123.123.123.123.
- If you are using a proxy server, then temporarily disable it to load the Web page correctly.

4 Access the WPS settings.

5 Enter the eight-digit PIN, and then save the setting.

Connecting the printer to a wireless network using the Embedded Web Server

Before you begin, make sure that:

- Your printer is connected temporarily to an Ethernet network.
- A wireless network adapter is installed in your printer and working properly. For more information, see the instruction sheet that came with your wireless network adapter.

1 Open a Web browser, and then type the printer IP address in the address field.

Notes:

- View the printer IP address in the TCP/IP section in the Network/Ports menu. The IP address appears as four sets of numbers separated by periods, such as 123.123.123.123.
- If you are using a proxy server, then temporarily disable it to load the Web page correctly.

2 Click **Settings** > **Network/Ports** > **Wireless**.

3 Modify the settings to match the settings of your access point (wireless router).

Note: Make sure to enter the correct SSID.

4 Click **Submit**.

- 5 Turn off the printer, and then disconnect the Ethernet cable. Then wait for at least five seconds, and then turn the printer back on.
- 6 To verify if your printer is connected to the network, print a network setup page. Then in the Network Card [x] section, see if the status is “Connected”.

For more information, see the “Verifying printer setup” section of the *User’s Guide*.

Verifying printer setup

Printing a menu settings page

Print a menu settings page to review the current menu settings and to verify if the printer options are installed correctly.

Note: If you have not changed any menu settings, then the menu settings page lists all the factory default settings. When you select and save other settings from the menus, they replace the factory default settings as *user default settings*. A user default setting remains in effect until you access the menu again, choose another value, and save it.

From the printer control panel, navigate to:

 > Settings >  > Reports >  > Menu Settings Page > 

Printing a network setup page

If the printer is attached to a network, then print a network setup page to verify the network connection. This page also provides important information that aids network printing configuration.

- 1 From the printer control panel, navigate to:

 > Settings >  > Reports >  > Network Setup Page > 

- 2 Check the first section of the network setup page, and then confirm that the status is Connected.

If the status is Not Connected, then the LAN drop may not be active, or the network cable may be malfunctioning. Consult your system support person for a solution, and then print another network setup page.



Loading paper and specialty media

The selection and handling of paper and specialty media can affect how reliably documents print. For more information, see “Avoiding jams” on page 105 and “Storing paper” on page 40.

Setting the paper size and type

- 1 From the printer control panel, navigate to:

 > Settings >  > Paper Menu >  > Paper Size/Type > 

- 2 Press the up or down arrow button to select the tray or feeder, and then press .
- 3 Press the up or down arrow button to select the paper size, and then press .
- 4 Press the up or down arrow button to select the paper type, and then press  to change the settings.

Configuring Universal paper settings



The Universal paper size is a user-defined setting that lets you print on paper sizes that are not preset in the printer menus.

Notes:

- The smallest Universal paper size is 6 x 127 mm (3 x 5 inches), and is supported only from the multipurpose feeder.
- The largest Universal paper size is 216 x 355.6 mm (8.5 x 14 inches), and is supported from all paper sources.

- 1 From the printer control panel, navigate to:

 > Settings >  > Paper Menu >  > Universal Setup >  > Units of Measure >  > select a unit of measure > 

- 2 Select **Portrait Width** or **Portrait Height**, and then press .
- 3 Press the left or right arrow button to change the setting, and then press .

Using the standard bin and paper stop

The standard bin holds up to 150 sheets of 20-lb paper. It collects prints facedown. The standard bin includes a paper stop that keeps paper from sliding out the front of the bin as it stacks.

To open the paper stop, pull it so that it flips forward.



Note: Close the paper stop when moving the printer to another location.

Loading trays

CAUTION—POTENTIAL INJURY: To reduce the risk of equipment instability, load each tray separately. Keep all other trays closed until needed.

- 1 Pull the tray completely out.

Note: Do not remove trays while a job prints or while **Busy** appears on the printer display. Doing so may cause a jam.

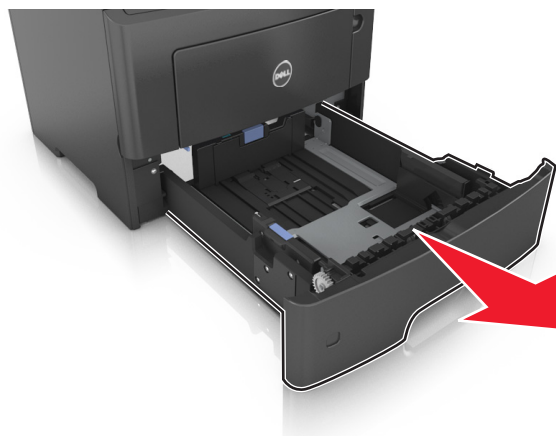

- 2 Squeeze, and then slide the width guide tab to the correct position for the size of the paper you are loading.

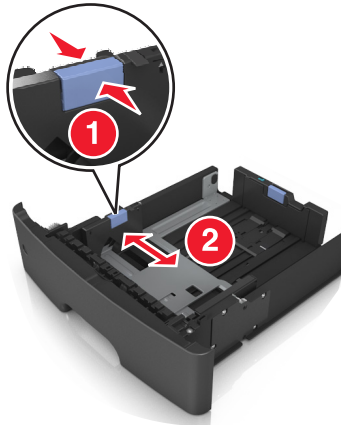

- 3 Unlock the length guide. Squeeze, and then slide the length guide tab to the correct position for the size of the paper you are loading.

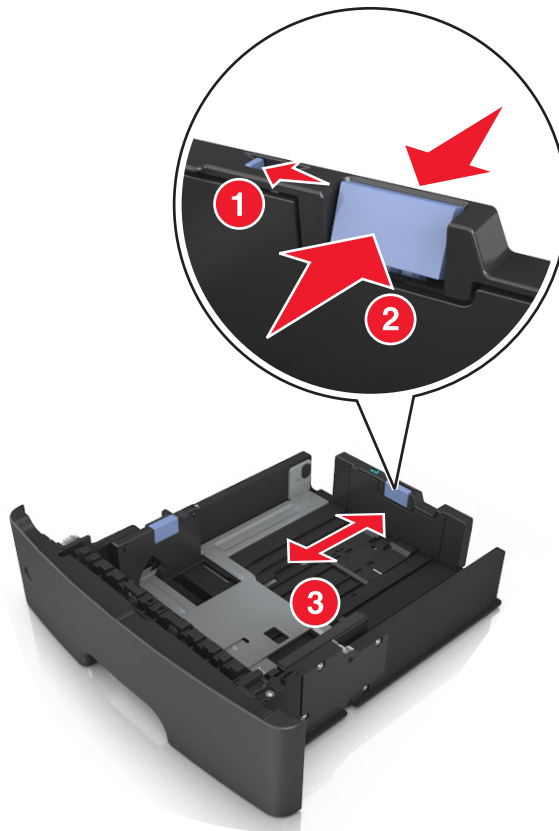

Notes:

- For some paper sizes like letter, legal, and A4, squeeze and slide the length guide tab backward to accommodate their length.
- If you are loading A6-size paper in the standard tray, then squeeze and then slide the length guide tab toward the center of the tray to the A6-size position.
- Make sure the width and length guides are aligned with the paper size indicators on the bottom of the tray.

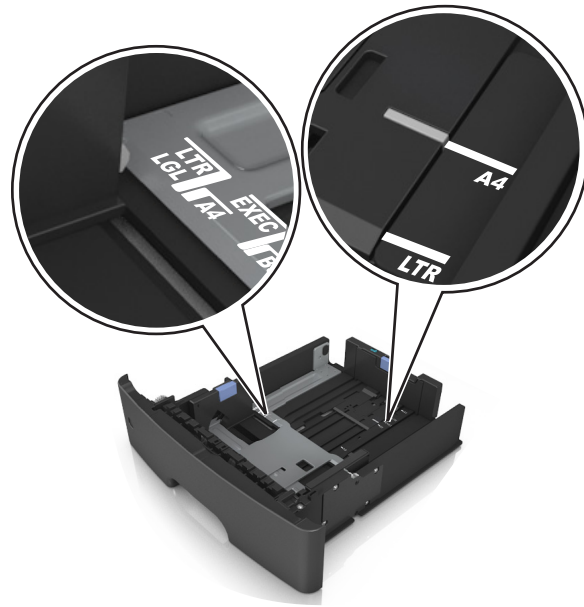

- 4 Flex the sheets back and forth to loosen them, and then fan them. Do not fold or crease the paper. Straighten the edges on a level surface.

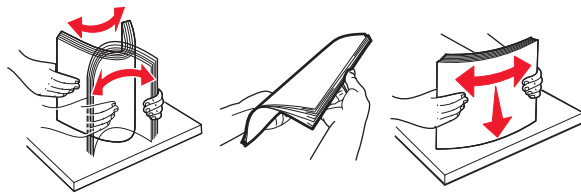

- 5 Load the paper stack.

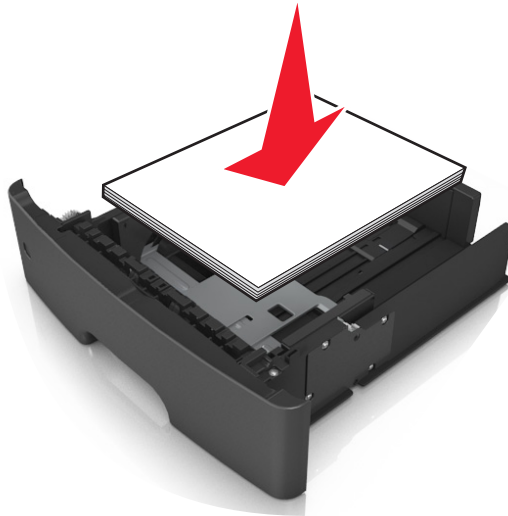

Notes:

- Load with the printable side facedown when using recycled or preprinted paper.
- Load prepunched paper with the holes on the top edge toward the front of the tray.

- Load letterhead facedown, with the top edge of the sheet toward the front of the tray. For two-sided printing, load letterhead faceup with the bottom edge of the sheet toward the front of the tray.
- Make sure the paper is below the maximum paper fill indicator located on the side of the width guide.

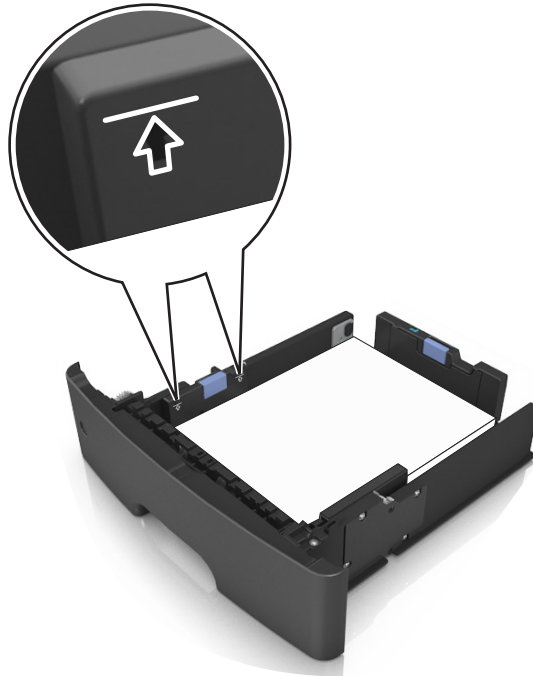

6 Insert the tray.

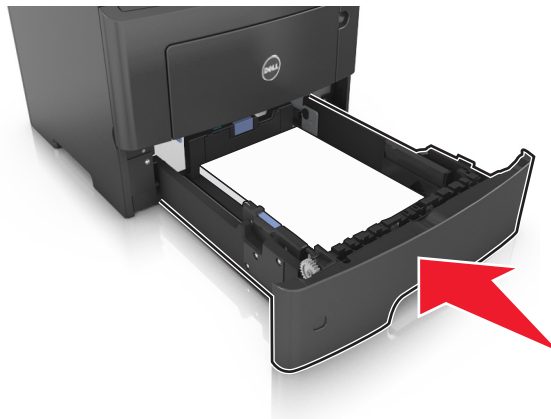

7 From the printer control panel, set the paper size and type in the Paper menu to match the paper loaded in the tray.

Note: Set the correct paper size and type to avoid paper jams and print quality problems.

Loading the multipurpose feeder

Use the multipurpose feeder when printing on different paper sizes and types or specialty media, such as card stock, transparencies, and envelopes. You can also use it for single-page print jobs on letterhead.

- 1 Open the multipurpose feeder.

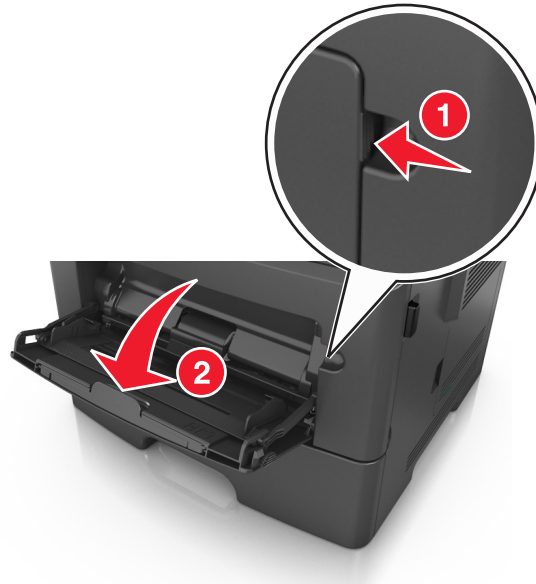

- a Pull the multipurpose feeder extender.



- b Pull the extender gently so that the multipurpose feeder is fully extended and open.



- 2 Squeeze the tab on the left width guide, and then move the guides for the paper you are loading.

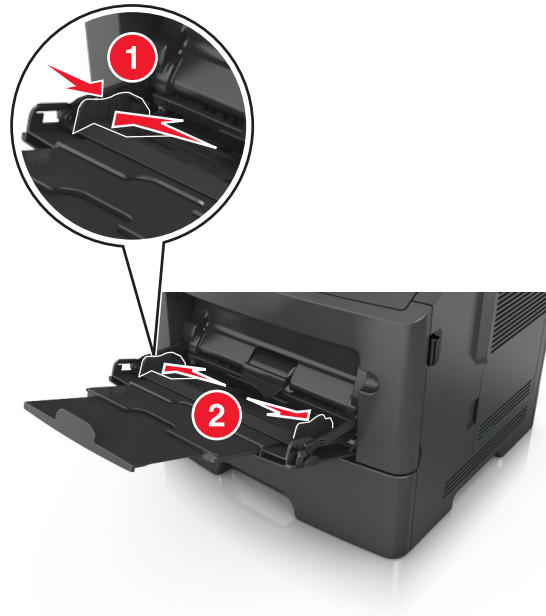

- 3 Prepare the paper or specialty media for loading.

- Flex sheets of paper back and forth to loosen them, and then fan them. Do not fold or crease the paper. Straighten the edges on a level surface.

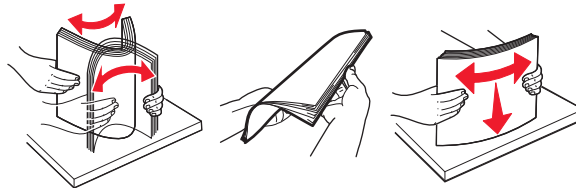

- Hold transparencies by the edges. Flex the stack of transparencies back and forth to loosen them, and then fan them. Straighten the edges on a level surface.

Note: Avoid touching the printable side of the transparencies. Be careful not to scratch them.

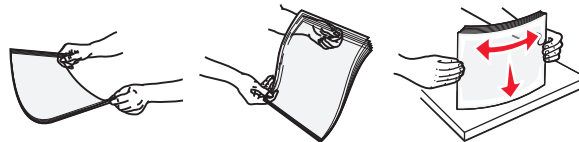

- Flex the stack of envelopes back and forth to loosen them, and then fan them. Straighten the edges on a level surface.



- 4 Load the paper or specialty media.

Note: Make sure the paper or specialty media is below the maximum paper fill indicator located on the paper guides. Overfilling may cause paper jams.



- Load paper, transparencies, and card stock with the recommended printable side faceup and the top edge entering the printer first. For more information on loading transparencies, see the packaging that the transparencies came in.



- Load letterhead faceup with the top edge entering the printer first. For two-sided (duplex) printing, load letterhead facedown with the bottom edge entering the printer first.



- Load envelopes with the flap on the left side facedown.



Warning—Potential Damage: Never use envelopes with stamps, clasps, snaps, windows, coated linings, or self-stick adhesives. These envelopes may severely damage the printer.

- 5 From the printer control panel, set the paper size and type in the Paper menu to match the paper or specialty media loaded in the multipurpose feeder.

Linking and unlinking trays

Linking and unlinking trays

- 1 Open a Web browser, and then type the printer IP address in the address field.

Notes:

- View the printer IP address on the printer control panel in the TCP/IP section under the Network/Ports menu. The IP address appears as four sets of numbers separated by periods, such as 123.123.123.123.
- If you are using a proxy server, then temporarily disable it to load the Web page correctly.

- 2 Click **Settings > Paper Menu**.

- 3 Change the paper size and type settings for the trays you are linking.

- To link trays, make sure the paper size and type for the tray match that of the other tray.
- To unlink trays, make sure the paper size or type for the tray does *not* match that of the other tray.

- 4 Click **Submit**.

Note: You can also change the paper size and type settings using the printer control panel. For more information, see “Setting the paper size and type” on page 27.

Warning—Potential Damage: Paper loaded in the tray should match the paper type name assigned in the printer. The temperature of the fuser varies according to the specified paper type. Printing issues may occur if settings are not properly configured.

Creating a custom name for a paper type

Using the Embedded Web Server

- 1 Open a Web browser, and then type the printer IP address in the address field.

Notes:

- View the printer IP address in the TCP/IP section in the Network/Ports menu. The IP address appears as four sets of numbers separated by periods, such as 123.123.123.123.
- If you are using a proxy server, then temporarily disable it to load the Web page correctly.

2 Click **Settings > Paper Menu > Custom Names**.

3 Select a custom name, and then type a new custom paper type name.

4 Click **Submit**.

5 Click **Custom Types**, and then verify if the new custom paper type name has replaced the custom name.

Using the printer control panel

1 From the printer control panel, navigate to:

 > **Settings** >  > **Paper Menu** >  > **Custom Names**

2 Select a custom name, and then type a new custom paper type name.

3 Press .

4 Press **Custom Types**, and then verify if the new custom paper type name has replaced the custom name.

Assigning a custom paper type name**Using the Embedded Web Server**

1 Open a Web browser, and then type the printer IP address in the address field.

Notes:

- View the printer IP address in the TCP/IP section in the Network/Ports menu. The IP address appears as four sets of numbers separated by periods, such as 123.123.123.123.
- If you are using a proxy server, then temporarily disable it to load the Web page correctly.

2 Click **Settings > Paper Menu > Custom Names**.

3 Type a name for the paper type, and then click **Submit**.

4 Select a custom type, and then verify that the correct paper type is associated with the custom name.

Note: Plain Paper is the factory default paper type for all user-defined custom names.

Using the printer control panel

1 From the printer control panel, navigate to:

 > **Settings** >  > **Paper Menu** >  > **Custom Names**

2 Type a name for the paper type, and then press .

Assigning a custom paper type

Using the Embedded Web Server

- 1 Open a Web browser, and then type the printer IP address in the address field.

Notes:

- View the printer IP address in the TCP/IP section in the Network/Ports menu. The IP address appears as four sets of numbers separated by periods, such as 123.123.123.123.
- If you are using a proxy server, then temporarily disable it to load the Web page correctly.

- 2 Click **Settings > Paper Menu > Custom Types**.

- 3 Select a custom paper type name, and then select a paper type.

Note: Paper is the factory default paper type for all user-defined custom names.

- 4 Click **Submit**.

Using the printer control panel

- 1 From the printer control panel, navigate to:

 > **Settings** >  > **Paper Menu** >  > **Custom Types**

- 2 Select a custom paper type name, and then select a paper type.

Note: Paper is the factory default paper type for all user-defined custom names.

- 3 Press .

Paper and specialty media guide

Paper guidelines

Selecting the correct paper or specialty media reduces printing problems. For the best print quality, try a sample of the paper or specialty media before buying large quantities.

Paper characteristics

The following paper characteristics affect print quality and reliability. Consider these characteristics when evaluating new paper stock.

Weight

The standard printer trays can automatically feed paper weights up to 90-g/m² (24-lb) bond grain long paper. The optional trays can automatically feed paper weights up to 120-g/m² (32-lb) bond grain long paper. The multipurpose feeder can automatically feed paper weights up to 163-g/m² (43-lb) bond grain long paper. Paper lighter than 60 g/m² (16 lb) might not be stiff enough to feed properly, causing jams. For best performance, use 75-g/m² (20-lb) bond grain long paper. For paper smaller than 182 x 257 mm (7.2 x 10.1 inches), it is recommended to use 90 g/m² (24 lb) or heavier paper.

Note: Two-sided printing is supported only for 60–90-g/m² (16–24-lb) bond paper.

Curl

Curl is the tendency for paper to curl at its edges. Excessive curl can cause paper feeding problems. Curl can occur after the paper passes through the printer, where it is exposed to high temperatures. Storing paper unwrapped in hot, humid, cold, or dry conditions, even in the trays, can contribute to paper curling prior to printing and can cause feeding problems.

Smoothness

Paper smoothness directly affects print quality. If paper is too rough, toner cannot fuse to it properly. If paper is too smooth, it can cause paper feeding or print quality issues. Always use paper between 100 and 300 Sheffield points; smoothness between 150–250 Sheffield points produces the best print quality.

Moisture content

The amount of moisture in paper affects both print quality and the ability of the printer to feed the paper correctly. Leave paper in its original wrapper until it is time to use it. This limits the exposure of paper to moisture changes that can degrade its performance.

Condition paper before printing by storing it in its original wrapper in the same environment as the printer for 24–48 hours before printing. Extend the time to several days if the storage or transportation environment is very different from the printer environment. Thick paper may also require a longer conditioning period.

Grain direction

Grain refers to the alignment of the paper fibers in a sheet of paper. Grain is either *grain long*, running the length of the paper, or *grain short*, running the width of the paper.

For 60–90-g/m² (16–24-lb) bond paper, grain long paper is recommended.

Fiber content

Most high-quality xerographic paper is made from 100% chemically treated pulped wood. This content provides the paper with a high degree of stability resulting in fewer paper feeding problems and better print quality. Paper containing fibers such as cotton can negatively affect paper handling.

Unacceptable paper

The following paper types are not recommended for use with the printer:

- Chemically treated papers used to make copies without carbon paper, also known as carbonless papers, carbonless copy paper (CCP), or no carbon required (NCR) paper
- Preprinted papers with chemicals that may contaminate the printer
- Preprinted papers that can be affected by the temperature in the printer fuser
- Preprinted papers that require a registration (the precise print location on the page) less than ±2.5 mm (±0.10 inch), such as optical character recognition (OCR) forms

In some cases, registration can be adjusted with a software application to successfully print on these forms:

- Coated papers (erasable bond), synthetic papers, thermal papers
- Rough-edged, rough or heavily textured surface papers, or curled papers
- Recycled papers that fail EN12281:2002 (European)
- Paper weighing less than 60 g/m² (16 lb)
- Multiple-part forms or documents

Selecting paper

Using the appropriate paper prevents jams and helps ensure trouble-free printing.

To help avoid paper jams and poor print quality:

- *Always* use new, undamaged paper.
- Before loading paper, know the recommended printable side of the paper. This information is usually indicated on the paper package.
- *Do not* use paper that has been cut or trimmed by hand.
- *Do not* mix paper sizes, types, or weights in the same tray; mixing results in jams.
- *Do not* use coated papers unless they are specifically designed for electrophotographic printing.

Selecting preprinted forms and letterhead

Use these guidelines when selecting preprinted forms and letterhead:

- Use grain long for 60 to 90 g/m² (16 to 24 lb) weight paper.
- Use only forms and letterhead printed using an offset lithographic or engraved printing process.
- Avoid papers with rough or heavily textured surfaces.

Use papers printed with heat-resistant inks designed for use in xerographic copiers. The ink must be able to withstand temperatures up to 230°C (446°F) without melting or releasing hazardous emissions. Use inks that are not affected by the resin in toner. Inks that are oxidation-set or oil-based generally meet these requirements; latex inks might not. When in doubt, contact the paper supplier.

Preprinted papers such as letterhead must be able to withstand temperatures up to 230°C (446°F) without melting or releasing hazardous emissions.

Using recycled paper and other office papers

- Low moisture content (4–5%)
- Suitable smoothness (100–200 Sheffield units, or 140–350 Bendtsen units, European)

Note: Some much smoother papers (such as premium 24 lb laser papers, 50–90 Sheffield units) and much rougher papers (such as premium cotton papers, 200–300 Sheffield units) have been engineered to work very well in laser printers, despite surface texture. Before using these types of paper, consult your paper supplier.

- Suitable sheet-to-sheet coefficient of friction (0.4–0.6)
- Sufficient bending resistance in the direction of feed

Recycled paper, paper of lower weight (<60 g/m² [16 lb bond]) and/or lower caliper (<3.8 mils [0.1 mm]), and paper that is cut grain-short for portrait (or short-edge) fed printers may have lower bending resistance than is required for reliable paper feeding. Before using these types of paper for laser (electrophotographic) printing, consult your paper supplier. Remember that these are general guidelines only and that paper meeting these guidelines may still cause paper feeding problems in any laser printer (for example, if the paper curls excessively under normal printing conditions).

Storing paper

Use these paper storage guidelines to help avoid jams and uneven print quality:

- For best results, store paper where the temperature is 21°C (70°F) and the relative humidity is 40 percent. Most label manufacturers recommend printing in a temperature range of 18–24°C (65–75°F) with relative humidity between 40 and 60 percent.
- Store paper in cartons, on a pallet or shelf, rather than on the floor.
- Store individual packages on a flat surface.
- Do not store anything on top of individual paper packages.
- Take paper out of the carton or wrapper only when you are ready to load it in the printer. The carton and wrapper help keep the paper clean, dry, and flat.

Using specialty media

Tips on using card stock

Card stock is heavy, single-ply specialty media. Many of its variable characteristics, such as moisture content, thickness, and texture, can significantly impact print quality. Print samples on the card stock being considered for use before buying large quantities.

When printing on card stock:

- Make sure the Paper Type is Card Stock.
- Select the appropriate Paper Texture setting.
- Be aware that preprinting, perforation, and creasing may significantly affect the print quality and cause jams or other paper handling problems.
- Check with the manufacturer or vendor to ensure that the card stock can withstand temperatures up to 240°C (464°F) without releasing hazardous emissions.
- Do not use preprinted card stock manufactured with chemicals that may contaminate the printer. Preprinting introduces semi-liquid and volatile components into the printer.
- Use grain short card stock when possible.

Tips on using envelopes

Print samples on the envelopes being considered for use before buying large quantities.

- Use envelopes designed specifically for laser printers. Check with the manufacturer or vendor to ensure that the envelopes can withstand temperatures up to 230°C (446°F) without sealing, wrinkling, curling excessively, or releasing hazardous emissions.
- For best performance, use envelopes made from 90-g/m² (24-lb bond) paper or 25% cotton. All-cotton envelopes must not exceed 70-g/m² (20-lb bond) weight.
- Use only new envelopes from undamaged packages.
- To optimize performance and minimize jams, do not use envelopes that:
 - Have excessive curl or twist
 - Are stuck together or damaged in any way
 - Have windows, holes, perforations, cutouts, or embossing
 - Have metal clasps, string ties, or folding bars
 - Have an interlocking design
 - Have postage stamps attached
 - Have any exposed adhesive when the flap is in the sealed or closed position
 - Have bent corners
 - Have rough, cockle, or laid finishes
- Adjust the width guides to fit the width of the envelopes.

Note: A combination of high humidity (over 60%) and high printing temperature may wrinkle or seal envelopes.

Tips on using labels

Print samples on the labels being considered for use before buying large quantities.

Note: Use only paper label sheets. Vinyl, pharmacy, and two-sided labels are not supported.

When printing on labels:

- Use labels designed specifically for laser printers. Check with the manufacturer or vendor to verify that:
 - The labels can withstand temperatures up to 240°C (464°F) without sealing, excessive curling, wrinkling, or releasing hazardous emissions.
 - Label adhesives, face sheet (printable stock), and topcoats can withstand up to 25-psi (172-kPa) pressure without delaminating, oozing around the edges, or releasing hazardous fumes.
- Do not use labels with slick backing material.
- Use full label sheets. Partial sheets may cause labels to peel off during printing, resulting in a jam. Partial sheets also contaminate the printer and the cartridge with adhesive, and could void the printer and toner cartridge warranties.
- Do not use labels with exposed adhesive.
- Do not print within 1 mm (0.04 inch) of the edge of the label, of the perforations, or between die-cuts of the label.
- Make sure the adhesive backing does not reach to the edge of the sheet. Zone coating of the adhesive should be at least 1 mm (0.04 inch) away from edges. Adhesive material contaminates the printer and could void the warranty.
- If zone coating of the adhesive is not possible, then remove a 2-mm (0.06-inch) strip on the leading and driver edge, and then use a non-oozing adhesive.
- Portrait orientation is recommended, especially when printing bar codes.

Tips on using letterhead

- Use letterhead designed specifically for laser printers.
- Print samples on the letterhead being considered for use before buying large quantities.
- Before loading letterhead, flex, fan, and straighten the stack to prevent sheets from sticking together.
- Page orientation is important when printing on letterhead. For information on how to load letterhead, see:
 - “Loading trays” on page 28
 - “Loading the multipurpose feeder” on page 32

Tips on using transparencies

- Print a test page on the transparencies being considered for use before buying large quantities.
- Feed transparencies from the standard tray, or the multipurpose feeder.
- Use transparencies designed specifically for laser printers. Transparencies must be able to withstand temperatures up to 185°C (365°F) without melting, discoloring, offsetting, or releasing hazardous emissions.
Note: If the transparency weight is set to Heavy and the transparency texture is set to Rough in the Paper menu, then transparencies can be printed at a temperature up to 195°C (383°F).
- Avoid getting fingerprints on the transparencies to prevent print quality problems.
- Before loading transparencies, flex, fan, and straighten the stack to prevent sheets from sticking together.

Supported paper sizes, types, and weights

Supported paper sizes

Note: For an unlisted paper size, select the closest *larger* listed size. For information on card stock and labels, see the *Card Stock & Label Guide*.

Paper size	Standard tray	Optional 550-sheet tray	Multipurpose feeder	Duplex mode
A4 210 x 297 mm (8.3 x 11.7 in.)	✓	✓	✓	✓
A5 148 x 210 mm (5.8 x 8.3 in.)	✓	✓	✓	X
A6 105 x 148 mm (4.1 x 5.8 in.)	✓	X	✓	X
JIS B5 182 x 257 mm (7.2 x 10.1 in.)	✓	✓	✓	X
Letter 216 x 279 mm (8.5 x 11 in.)	✓	✓	✓	✓
Legal 216 x 356 mm (8.5 x 14 in.)	✓	✓	✓	✓
Executive 184 x 267 mm (7.3 x 10.5 in.)	✓	✓	✓	X
Oficio (Mexico)¹ 216 x 340 mm (8.5 x 13.4 in.)	✓	✓	✓	✓
Folio 216 x 330 mm (8.5 x 13 in.)	✓	✓	✓	✓
Statement 140 x 216 mm (5.5 x 8.5 in.)	✓	✓	✓	X
Universal² 76.2 x 127 mm (3 x 5 in.) up to 216 x 356 mm (8.5 x 14 in.)	✓	✓	✓	✓
7 3/4 Envelope (Monarch) 98 x 191 mm (3.9 x 7.5 in.)	X	X	✓	X
9 Envelope 98 x 225 mm (3.9 x 8.9 in.)	X	X	✓	X

¹ This size setting formats the page for 216 x 356 mm (8.5 x 14 in.) unless the size is specified by the software application.

² Universal is supported only in the standard tray if the paper size is at least 105 x 148 mm (4.1 x 5.8 in.). Universal is supported only in the optional 550-sheet tray if the paper size is at least 148 x 210 mm (5.8 x 8.3 in.). Universal is supported only in duplex mode if the width is at least 210 mm (8.3 in.) and length is at least 279 mm (11 in.). The smallest supported Universal size is supported only in the multipurpose feeder.

Paper size	Standard tray	Optional 550-sheet tray	Multipurpose feeder	Duplex mode
10 Envelope 105 x 241 mm (4.1 x 9.5 in.)	X	X	✓	X
DL Envelope 110 x 220 mm (4.3 x 8.7 in.)	X	X	✓	X
C5 Envelope 162 x 229 mm (6.4 x 9 in.)	X	X	✓	X
B5 Envelope 176 x 250 mm (6.9 x 9.8 in.)	X	X	✓	X
Other Envelope 229 x 356 mm (9 x 14 in.)	X	X	✓	X

¹ This size setting formats the page for 216 x 356 mm (8.5 x 14 in.) unless the size is specified by the software application.

² Universal is supported only in the standard tray if the paper size is at least 105 x 148 mm (4.1 x 5.8 in.). Universal is supported only in the optional 550-sheet tray if the paper size is at least 148 x 210 mm (5.8 x 8.3 in.). Universal is supported only in duplex mode if the width is at least 210 mm (8.3 in.) and length is at least 279 mm (11 in.). The smallest supported Universal size is supported only in the multipurpose feeder.

Supported paper types and weights

The standard tray supports 60–90-g/m² (16–24-lb) paper weights. The optional tray supports 60–120-g/m² (16–32-lb) paper weights. The multipurpose feeder supports 60–163-g/m² (16–43-lb) paper weights.

Paper type	550-sheet tray	Multipurpose feeder	Duplex mode
Plain paper	✓	✓	✓
Card stock	X	✓	X
Transparencies	✓	✓	X
Recycled	✓	✓	✓
Glossy paper	X	X	X
Paper labels¹	✓	✓	X
Vinyl labels	X	X	X
Bond²	✓	✓	✓
Envelope	X	✓	X
Rough envelope	X	✓	X
Letterhead	✓	✓	✓

Paper type	550-sheet tray	Multipurpose feeder	Duplex mode
Preprinted	✓	✓	✓
Colored Paper	✓	✓	✓
Light Paper	✓	✓	✓
Heavy Paper²	✓	✓	✓
Rough/Cotton	✓	✓	x
Custom Type [x]	✓	✓	✓ ³

¹ One-sided paper labels designed for laser printers are supported for occasional use. It is recommended to print 20 or fewer pages of paper labels per month. Vinyl, pharmacy, and two-sided labels are not supported.

² Bond and Heavy Paper are supported in duplex mode up to 90-g/m² (24-lb) paper weight.

³ Custom Type [x] is supported in duplex mode if any of the paper type listed in the Custom Types menu is selected. For more information, see “Custom Types menu” on page 60.

Printing

This chapter covers printing, printer reports, and job cancelation. Selection and handling of paper and specialty media can affect how reliably documents print. For more information, see “Avoiding jams” on page 105 and “Storing paper” on page 40.

Printing a document

Printing a document

- 1 From the Paper menu on the printer control panel, set the paper type and size to match the paper loaded.
- 2 Send the print job:

For Windows users

- a With a document open, click **File > Print**.
- b Click **Properties, Preferences, Options, or Setup**.
- c Adjust the settings, if necessary.
- d Click **OK > Print**.

For Macintosh users

- a Customize the settings in the Page Setup dialog if necessary:
 - 1 With a document open, choose **File > Page Setup**.
 - 2 Choose a paper size or create a custom size to match the paper loaded.
 - 3 Click **OK**.
- b Customize the settings in the Page Setup dialog if necessary:
 - 1 With a document open, choose **File > Print**.
If necessary, click the disclosure triangle to see more options.
 - 2 From the Print dialog and pop-up menus adjust the settings if necessary.
Note: To print on a specific paper type, adjust the paper type setting to match the paper loaded, or select the appropriate tray or feeder.
 - 3 Click **Print**.

Adjusting toner darkness

Using the Embedded Web Server

- 1 Open a Web browser, and then type the IP address of the printer in the address field.

Notes:

- View the printer IP address in the TCP/IP section in the Network/Ports menu. The IP address appears as four sets of numbers separated by periods, such as 123.123.123.123.

- If you are using a proxy server, then temporarily disable it to load the Web page correctly.

2 Click **Settings > Print Settings > Quality Menu > Toner Darkness**.

3 Adjust the toner darkness, and then click **Submit**.

Using the printer control panel

1 From the printer control panel, navigate to:

 > **Settings** >  > **Print Settings** >  > **Quality Menu** >  > **Toner Darkness**

2 Adjust the toner darkness, and then press .

Printing from a mobile device

For the list of supported mobile devices and to download a compatible mobile printing application, visit our Web site.

Note: Mobile printing applications may also be available from your mobile device manufacturer.

Printing from a flash drive

Printing from a flash drive

Notes:

- Before printing an encrypted PDF file, you will be prompted to enter the file password from the printer control panel.
- You cannot print files for which you do not have printing permissions.

1 Insert a flash drive into the USB port.



Notes:

- A flash drive icon appears on the printer control panel and in the held jobs icon when a flash drive is installed.
- If you insert the flash drive when the printer requires attention, such as when a jam has occurred, then the printer ignores the flash drive.
- If you insert the flash drive while the printer is processing other print jobs, then **Busy** appears. After these print jobs are processed, you may need to view the held jobs list to print documents from the flash drive.

Warning—Potential Damage: Do not touch the printer or the flash drive in the area shown while actively printing, reading, or writing from the memory device. Loss of data can occur.



- 2 From the printer control panel, select the document you want to print.
- 3 Press the left or right arrow button to specify the number of copies for printing, and then press **OK**.

Notes:

- Do not remove the flash drive from the USB port until the document has finished printing.
- If you leave the flash drive in the printer after leaving the initial USB menu screen, then access held jobs from the printer control panel to print files from the flash drive.

Supported flash drives and file types

Flash drive	File type
<p>Notes:</p> <ul style="list-style-type: none"> • Hi-Speed USB flash drives must support the full-speed standard. Devices supporting only USB low-speed capabilities are not supported. • USB flash drives must support the File Allocation Table (FAT) system. Devices formatted with New Technology File System (NTFS) or any other file system are not supported. 	<p>Documents:</p> <ul style="list-style-type: none"> • .pdf • .xps <p>Images:</p> <ul style="list-style-type: none"> • .dcm • .gif • .JPEG or .jpg • .bmp • .pcx • .TIFF or .tif • .png • .fls

Printing confidential and other held jobs

Printing confidential and other held jobs

Note: Confidential and Verify print jobs are automatically deleted from memory after printing. Repeat and Reserve jobs are held in the printer until you choose to delete them.

For Windows users

- 1 With a document open, click **File > Print**.
- 2 Click **Properties, Preferences, Options, or Setup**.
- 3 Click **Print and Hold**.
- 4 Select the print job type (Confidential, Repeat, Reserve, or Verify), and then assign a user name. For a confidential print job, also enter a four-digit PIN.
- 5 Click **OK** or **Print**.
- 6 From the printer control panel, release the print job.
 - For confidential print jobs, navigate to:
Held jobs > select your user name > Confidential Jobs > enter the PIN > select the print job > specify the number of copies > Print
 - For other print jobs, navigate to:
Held jobs > select your user name > select the print job > specify the number of copies > Print

For Macintosh users





- 1 With a document open, choose **File > Print**.
If necessary, click the disclosure triangle to see more options.
- 2 From the print options or Copies & Pages pop-up menu, choose **Job Routing**.

- 3 Select the print job type (Confidential, Repeat, Reserve, or Verify), and then assign a user name. For a confidential print job, also enter a four-digit PIN.
- 4 Click **OK** or **Print**.
- 5 From the printer control panel, release the print job:
 - For confidential print jobs, navigate to:
Held jobs > select your user name > **Confidential Jobs** > enter the PIN > select the print job > specify the number of copies > **Print**
 - For other print jobs, navigate to:
Held jobs > select your user name > select the print job > specify the number of copies > **Print**

Printing information pages

For more information on printing information pages, see “Printing a menu settings page” on page 26 and “Printing a network setup page” on page 26.

Printing a font sample list

- 1 From the printer control panel, navigate to:
 > **Settings** >  > **Reports** >  > **Print Fonts**
- 2 Press the up or down arrow button to select the font setting.
- 3 Press .

Note: The PPDS fonts appear only when the PPDS data stream is activated.

Printing a directory list



From the printer control panel, navigate to:

 > **Settings** > **Reports** >  > **Print Directory** > 

Note: The Print Directory menu item appears only when an optional flash memory is installed.

Canceling a print job

Canceling a print job from the printer control panel

From the printer control panel, press  > .

Canceling a print job from the computer

For Windows users

- 1 Open the printers folder.
 - a Click , or click **Start** and then click **Run**.
 - b In the Start Search or Run dialog, type **control printers**.
 - c Press **Enter**, or click **OK**.
- 2 Double-click the printer icon.
- 3 Select the print job you want to cancel.
- 4 Click **Delete**.

For Macintosh users

- 1 From the Apple Menu, navigate to either of the following:
 - **System Preferences > Print & Scan > select a printer > Open Print Queue**
 - **System Preferences > Print & Fax > select a printer > Open Print Queue**
- 2 From the printer window, select the print job you want to cancel, and then click **Delete**.

Understanding the printer menus

Menus list

Paper Menu

- Default Source
- Paper Size/Type
- Configure MP
- Substitute Size
- Paper Texture
- Paper Weight
- Paper Loading
- Custom Types
- Universal Setup

Security

- Confidential Print
- Security Audit Log
- Set Date and Time

Reports

- Menu Settings Page
- Device Statistics
- Network Setup Page¹
- Profiles List
- Print Fonts
- Print Directory
- Print Demo
- Asset Report

Settings

- General Settings
- Flash Drive Menu
- Print Settings

Network/Ports

- Active NIC
- Standard Network²
- Standard USB
- Reports
- Network Card
- TCP/IP
- IPv6
- Wireless
- AppleTalk
- SMTP Setup

Help

- Print All Guides
- Print Quality
- Printing Guide
- Media Guide
- Print Defects Guide
- Menu Map
- Information Guide
- Connection Guide
- Moving Guide

¹ Depending on the printer setup, this menu item appears as Network Setup Page or Network [x] Setup Page.

² Depending on the printer setup, this menu item appears as Standard Network or Network [x].

Paper menu

Default Source menu

Use	To
Default Source Tray [x] MP Feeder Manual Paper Manual Envelope	Set a default paper source for all print jobs. Notes: <ul style="list-style-type: none"> • Tray 1 (standard tray) is the factory default setting. • From the Paper menu, set Configure MP to "Cassette" for MP Feeder to appear as a menu setting. • If two trays contain paper of the same size and type, and the trays have the same settings, then the trays are automatically linked. When one tray is empty, the print job continues using the linked tray.

Paper Size/Type menu

Use	To
Tray [x] Size A4 A5 A6 JIS-B5 Letter Legal Executive Oficio (Mexico) Folio Statement Universal	Specify the paper size loaded in each tray. Notes: <ul style="list-style-type: none"> • Letter is the US factory default setting. A4 is the international factory default setting. • If two trays contain paper of the same size and type, and the trays have the same settings, then the trays are automatically linked. When one tray is empty, the print job continues using the linked tray. • The A6 paper size is supported only in Tray 1 and the multipurpose feeder.
Tray [x] Type Plain Paper Transparency Recycled Labels Bond Letterhead Preprinted Colored Paper Light Paper Heavy Paper Rough/Cotton Custom Type [x]	Specify the type of paper loaded in each tray. Notes: <ul style="list-style-type: none"> • Plain Paper is the factory default setting for Tray 1. Custom Type [x] is the factory default setting for all other trays. • If available, a user-defined name will appear instead of Custom Type [x]. • Use this menu to configure automatic tray linking.
Note: Only installed trays and feeders are listed in this menu.	

Use	To
<p>MP Feeder Size</p> <ul style="list-style-type: none"> A4 A5 A6 JIS B5 Letter Legal Executive Oficio (Mexico) Folio Statement Universal 7 3/4 Envelope 9 Envelope 10 Envelope DL Envelope C5 Envelope B5 Envelope Other Envelope 	<p>Specify the paper size loaded in the multipurpose feeder.</p> <p>Notes:</p> <ul style="list-style-type: none"> • Letter is the US factory default setting. A4 is the international factory default setting. • From the Paper menu, set Configure MP to “Cassette” for MP Feeder Size to appear as a menu. • The multipurpose feeder does not automatically detect paper size. Make sure to set the paper size value.
<p>MP Feeder Type</p> <ul style="list-style-type: none"> Plain Paper Card Stock Transparency Recycled Labels Bond Envelope Rough Envelope Letterhead Preprinted Colored Paper Light Paper Heavy Paper Rough/Cotton Custom Type [x] 	<p>Specify the type of paper loaded in the multipurpose feeder.</p> <p>Notes:</p> <ul style="list-style-type: none"> • Plain Paper is the factory default setting. • From the Paper menu, set Configure MP to “Cassette” for MP Feeder Type to appear as a menu.
<p>Note: Only installed trays and feeders are listed in this menu.</p>	

Use	To
<p>Manual Paper Size</p> <ul style="list-style-type: none"> A4 A5 A6 JIS B5 Letter Legal Executive Oficio (Mexico) Folio Statement Universal 	<p>Specify the paper size being manually loaded.</p> <p>Note: Letter is the US factory default setting. A4 is the international factory default setting.</p>
<p>Manual Paper Type</p> <ul style="list-style-type: none"> Plain Paper Card Stock Transparency Recycled Labels Bond Letterhead Preprinted Colored Paper Light Paper Heavy Paper Rough/Cotton Custom Type [x] 	<p>Specify the paper type being manually loaded.</p> <p>Notes:</p> <ul style="list-style-type: none"> • Plain Paper is the factory default setting. • From the Paper menu, set Configure MP to “Manual” for Manual Paper Type to appear as a menu.
<p>Manual Envelope Size</p> <ul style="list-style-type: none"> 7 3/4 Envelope 9 Envelope 10 Envelope DL Envelope C5 Envelope B5 Envelope Other Envelope 	<p>Specify the envelope size being manually loaded.</p> <p>Note: 10 Envelope is the US factory default setting. DL Envelope is the international factory default setting.</p>
<p>Manual Envelope Type</p> <ul style="list-style-type: none"> Envelope Rough Envelope Custom Type [x] 	<p>Specify the envelope type being manually loaded.</p> <p>Note: Envelope is the factory default setting.</p>
<p>Note: Only installed trays and feeders are listed in this menu.</p>	

Configure MP menu

Use	To
Configure MP Cassette Manual First	Determine when the printer selects paper from the multipurpose feeder. Notes: <ul style="list-style-type: none"> • Cassette is the factory default setting. Cassette configures the multipurpose feeder as the automatic paper source. • Manual sets the multipurpose feeder only for manual-feed print jobs. • First configures the multipurpose feeder as the primary paper source.

Substitute Size menu

Use	To
Substitute Size Off Statement/A5 Letter/A4 All Listed	Substitute a specified paper size if the requested paper size is not available. Notes: <ul style="list-style-type: none"> • All Listed is the factory default setting. All available substitutions are allowed. • Off indicates that no size substitutions are allowed. • Setting a size substitution lets the print job continue without Change Paper appearing.

Paper Texture menu

Use	To
Plain Texture Smooth Normal Rough	Specify the relative texture of the plain paper loaded. Note: Normal is the factory default setting.
Card Stock Texture Smooth Normal Rough	Specify the relative texture of the card stock loaded. Notes: <ul style="list-style-type: none"> • Normal is the factory default setting. • The options appear only if card stock is supported.
Transparency Texture Smooth Normal Rough	Specify the relative texture of the transparencies loaded. Note: Normal is the factory default setting.
Recycled Texture Smooth Normal Rough	Specify the relative texture of the recycled paper loaded. Note: Normal is the factory default setting.

Use	To
Labels Texture Smooth Normal Rough	Specify the relative texture of the labels loaded. Note: Normal is the factory default setting.
Bond Texture Smooth Normal Rough	Specify the relative texture of the bond paper loaded. Note: Rough is the factory default setting.
Envelope Texture Smooth Normal Rough	Specify the relative texture of the envelopes loaded. Note: Normal is the factory default setting.
Rough Envelope Texture Rough	Specify the relative texture of the rough envelopes loaded.
Letterhead Texture Smooth Normal Rough	Specify the relative texture of the letterhead loaded. Note: Normal is the factory default setting.
Preprinted Texture Smooth Normal Rough	Specify the relative texture of the preprinted paper loaded. Note: Normal is the factory default setting.
Colored Texture Smooth Normal Rough	Specify the relative texture of the colored paper loaded. Note: Normal is the factory default setting.
Light Texture Smooth Normal Rough	Specify the relative texture of the paper loaded. Note: Normal is the factory default setting.
Heavy Texture Smooth Normal Rough	Specify the relative texture of the paper loaded. Note: Normal is the factory default setting.
Rough/Cotton Texture Rough	Specify the relative texture of the cotton paper loaded.
Custom [x] Texture Smooth Normal Rough	Specify the relative texture of the custom paper loaded. Notes: <ul style="list-style-type: none"> • Normal is the factory default setting. • The options appear only if the custom type is supported.

Paper Weight menu

Use	To
Plain Weight Light Normal Heavy	Specify the relative weight of the plain paper loaded. Note: Normal is the factory default setting.
Card Stock Weight Light Normal Heavy	Specify the relative weight of the card stock loaded. Note: Normal is the factory default setting.
Transparency Weight Light Normal Heavy	Specify the relative weight of the transparencies loaded. Note: Normal is the factory default setting.
Recycled Weight Light Normal Heavy	Specify the relative weight of the recycled paper loaded. Note: Normal is the factory default setting.
Labels Weight Light Normal Heavy	Specify the relative weight of the labels loaded. Note: Normal is the factory default setting.
Bond Weight Light Normal Heavy	Specify the relative weight of the bond paper loaded. Note: Normal is the factory default setting.
Envelope Weight Light Normal Heavy	Specify the relative weight of the envelope loaded. Note: Normal is the factory default setting.
Rough Envelope Weight Light Normal Heavy	Specify the relative weight of the rough envelope loaded. Note: Normal is the factory default setting.
Letterhead Weight Light Normal Heavy	Specify the relative weight of the letterhead loaded. Note: Normal is the factory default setting.
Preprinted Weight Light Normal Heavy	Specify the relative weight of the preprinted paper loaded. Note: Normal is the factory default setting.

Use	To
Colored Weight Light Normal Heavy	Specify the relative weight of the colored paper loaded. Note: Normal is the factory default setting.
Light Weight Light	Specify that the weight of the paper loaded is light.
Heavy Weight Heavy	Specify that the weight of the paper loaded is heavy.
Cotton/Rough Weight Light Normal Heavy	Specify the relative weight of the cotton or rough paper loaded. Note: Heavy is the factory default setting.
Custom [x] Weight Light Normal Heavy	Specify the relative weight of the custom paper loaded. Notes: <ul style="list-style-type: none"> • Normal is the factory default setting. • The options appear only when the custom type is supported.

Paper Loading menu

Use	To
Recycled Loading Duplex Off	Determine and set two-sided printing for all print jobs that specify Recycled as the paper type.
Bond Loading Duplex Off	Determine and set two-sided printing for all print jobs that specify Bond as the paper type.
Letterhead Loading Duplex Off	Determine and set two-sided printing for all print jobs that specify Letterhead as the paper type.
Preprinted Loading Duplex Off	Determine and set two-sided printing for all print jobs that specify Preprinted as the paper type.
Colored Loading Duplex Off	Determine and set two-sided printing for all print jobs that specify Colored as the paper type.
Notes: <ul style="list-style-type: none"> • Duplex sets two-sided printing as the default for all print jobs unless one-sided printing is set from Printing Preferences or Print dialog. • If Duplex is selected, then all print jobs are sent through the duplex unit, including one-sided jobs. • Off is the factory default setting for all the menus. 	

Use	To
Light Loading Duplex Off	Determine and set two-sided printing for all print jobs that specify Light as the paper type.
Heavy Loading Duplex Off	Determine and set two-sided printing for all print jobs that specify Heavy as the paper type.
Custom [x] Loading Duplex Off	Determine and set two-sided printing for all print jobs that specify Custom [x] as the paper type. Note: Custom [x] Loading is available only if the custom type is supported.
Notes: <ul style="list-style-type: none"> • Duplex sets two-sided printing as the default for all print jobs unless one-sided printing is set from Printing Preferences or Print dialog. • If Duplex is selected, then all print jobs are sent through the duplex unit, including one-sided jobs. • Off is the factory default setting for all the menus. 	

Custom Types menu

Use	To
Custom Type [x] Paper Card Stock Transparency Rough/Cotton Labels Envelope	Associate a paper or specialty media type with a factory default Custom Type [x] name or a user-defined custom name created in the Embedded Web Server. Notes: <ul style="list-style-type: none"> • Paper is the factory default setting for Custom Type [x]. • The custom media type must be supported in the selected tray or feeder in order to print from that source.
Recycled Paper Card Stock Transparency Rough/Cotton Labels Envelope Cotton	Specify a paper type when the Recycled setting is selected in other menus. Notes: <ul style="list-style-type: none"> • Paper is the factory default setting. • The Recycled paper type must be supported in the selected tray or feeder in order to print from that source.

Universal Setup menu

Use	To
Units of Measure Inches Millimeters	Identify the units of measure. Notes: <ul style="list-style-type: none"> • Inches is the US factory default setting. • Millimeters is the international factory default setting.
Portrait Width 3–8.5 inches 76–216 mm	Set the portrait width. Notes: <ul style="list-style-type: none"> • If the width exceeds the maximum, then the printer uses the maximum width allowed. • 8.5 inches is the US factory default setting. You can increase the width in 0.01-inch increments. • 216 mm is the international factory default setting. You can increase the width in 1-mm increments.
Portrait Height 3–14.17 inches 76–360 mm	Set the portrait height. Notes: <ul style="list-style-type: none"> • If the height exceeds the maximum, then the printer uses the maximum height allowed. • 14 inches is the US factory default setting. You can increase the height in 0.01-inch increments. • 356 mm is the international factory default setting. You can increase the height in 1-mm increments.
Feed Direction Short Edge Long Edge	Specify the feed direction if the paper can be loaded in either direction. Notes: <ul style="list-style-type: none"> • Short Edge is the factory default setting. • Long Edge appears only when the longest edge is shorter than the maximum width supported in the tray.

Reports menu

Reports menu

Use	To
Menu Settings Page	Print a report containing information about the paper loaded in trays, installed memory, total page count, alarms, timeouts, printer control panel language, TCP/IP address, status of supplies, status of the network connection, and other information.
Device Statistics	Print a report containing printer statistics, such as supply information and details about printed pages.

Use	To
Network Setup Page	Print a report containing information about the network printer settings, such as the TCP/IP address information. Note: This menu item appears only in network printers or in printers connected to print servers.
Profiles List	Print a list of profiles stored in the printer. Note: This menu item appears only when LDSS is enabled.
Print Fonts PCL Fonts PostScript Fonts	Print a report of all the fonts available for the printer language currently set in the printer. Note: A separate list is available for PCL and PostScript emulations.
Print Directory	Print a list of all the resources stored in an optional flash memory card. Notes: <ul style="list-style-type: none"> • Job Buffer Size must be set to 100%. • Make sure the optional flash memory is installed correctly and working properly. • This menu item appears only when an optional flash memory card is installed.
Asset Report	Print a report containing printer asset information, such as serial number and model name.

Network/Ports menu

Active NIC menu

Use	To
Active NIC Auto [list of available network cards]	Notes: <ul style="list-style-type: none"> • Auto is the factory default setting. • This menu item appears only when an optional network card is installed.

Standard Network or Network [x] menu

Note: Only active ports appear in this menu. All inactive ports are omitted.

Use	To
PCL SmartSwitch On Off	Set the printer to automatically switch to PCL emulation when a print job requires it, regardless of the default printer language. Notes: <ul style="list-style-type: none"> • On is the factory default setting. • If PCL SmartSwitch is disabled, then the printer does not examine incoming data and it uses the default printer language specified in the Setup menu.

Use	To
PS SmartSwitch On Off	Set the printer to automatically switch to PS emulation when a print job requires it, regardless of the default printer language. Notes: <ul style="list-style-type: none"> • On is the factory default setting. • If PS SmartSwitch is disabled, then the printer does not examine incoming data and it uses the default printer language specified in the Setup menu.
NPA Mode Off Auto	Set the printer to perform the special processing required for bidirectional communication following the conventions defined by the NPA protocol. Notes: <ul style="list-style-type: none"> • Auto is the factory default setting. • Changing this setting from the printer control panel and then exiting the menus causes the printer to restart. The menu selection is then updated.
Network Buffer Disabled Auto 3KB to [maximum size allowed]	Set the size of the network input buffer. Notes: <ul style="list-style-type: none"> • Auto is the factory default setting. • The value can be changed in 1-KB increments. • The maximum size allowed depends on the amount of memory in the printer, the size of the other link buffers, and whether Resource Save is set to On or Off. • To increase the maximum size range for the Network Buffer, disable or reduce the size of the parallel, serial, and USB buffers. • Changing this setting from the printer control panel and then exiting the menus causes the printer to restart. The menu selection is then updated.
Mac Binary PS On Off Auto	Set the printer to process Macintosh binary PostScript print jobs. Notes: <ul style="list-style-type: none"> • Auto is the factory default setting. • Off filters print jobs using the standard protocol. • On processes raw binary PostScript print jobs.

Reports menu

To access the menu, navigate to any of the following:

- **Network/Ports** menu > **Networks/Ports** > **Standard Network** > **Standard Network Setup** > **Reports**
- **Network/Ports** menu > **Networks/Ports** > **Network [x]** > **Network [x] Setup** > **Reports**

Use	To
Print Setup Page	Print a report containing information about the network printer settings, such as the TCP/IP address.

Network Card menu

To access the menu, navigate to either of the following:

- **Network/Ports > Standard Network > Standard Network Setup > Network Card**
- **Network/Ports > Network [x] > Network [x] Setup > Network Card**

Use	To
View Card Status Connected Disconnected	View the connection status of the network card.
View Card Speed	View the speed of an active network card.
Network Address UAA LAA	View the network addresses.
Job Timeout 0–255 seconds	Set the amount of time it takes for a network print job to be canceled. Notes: <ul style="list-style-type: none"> • 90 seconds is the factory default setting. • A setting value of 0 disables the timeout. • If a value of 1–9 is selected, then the setting is saved as 10.

TCP/IP menu

To access the menu, navigate to any of the following:

- **Network/Ports > Standard Network > Standard Network Setup > TCP/IP**
- **Network/Ports > Network [x] > Network [x] Setup > TCP/IP**

Note: This menu is available only in network printers or printers connected to print servers.

Use	To
Set Hostname	Set the host name. Notes: <ul style="list-style-type: none"> • This setting can be changed only from the Embedded Web Server. • The host name is limited to 15 characters, and accepts US-ASCII, alphanumeric characters and hyphen only.
IP Address	View or change the current TCP/IP address. Note: Manually setting the IP address sets the Enable DHCP and Enable Auto IP settings to Off. It also sets Enable BOOTP and Enable RARP to Off on systems that support BOOTP and RARP.
Netmask	View or change the current TCP/IP netmask.
Gateway	View or change the current TCP/IP gateway.
Enable DHCP On Off	Specify the DHCP address and parameter assignment. Note: On is the factory default setting.

Use	To
Enable AutoIP Yes No	Specify the Zero Configuration Networking setting. Note: Yes is the factory default setting.
Enable FTP/TFTP Yes No	Enable the built-in FTP server, which lets you send files to the printer using File Transfer Protocol. Note: Yes is the factory default setting.
Enable HTTP Server Yes No	Enable the built-in Web server (Embedded Web Server). When enabled, the printer can be monitored and managed remotely using a Web browser. Note: Yes is the factory default setting.
WINS Server Address	View or change the current WINS server address.
Enable DDNS Yes No	View or change the current DDNS setting. Note: Yes is the factory default setting.
Enable mDNS Yes No	View or change the current mDNS setting. Note: Yes is the factory default setting.
DNS Server Address	View or change the current DNS server address.
Backup DNS Server Address	View or change the backup DNS server addresses.
Backup DNS Server Address 2	
Backup DNS Server Address 3	
Enable HTTPS Yes No	View or change the current HTTPS setting. Note: Yes is the factory default setting.

IPv6 menu

To access the menu, navigate to any of the following:

- **Network/Ports > Standard Network > Standard Network Setup > IPv6**
- **Network/Ports > Network [x] > Network [x] Setup > IPv6**

Note: This menu is available only in network printers or printers connected to print servers.

Use	To
Enable IPv6 On Off	Enable Internet Protocol Version Six (IPv6) in the printer. IPv6 uses bigger numbers to create IP addresses. Note: On is the factory default setting.
Auto Configuration On Off	Specify whether or not the network adapter accepts the automatic IPv6 address configuration entries provided by a router. Note: On is the factory default setting.
* These settings can be changed only from the Embedded Web Server.	

Use	To
Set Hostname*	Set the host name. Note: The host name is limited to 15 characters, and accepts US-ASCII, alphanumeric characters and hyphen only.
View Address*	View the current IPv6 addresses.
View Router Address*	View the current router address.
Enable DHCPv6 On Off	Enable DHCPv6 in the printer. Note: On is the factory default setting.
* These settings can be changed only from the Embedded Web Server.	

Wireless menu

Note: This menu is available only in printer models connected to a wireless network.

To access the menu, navigate to any of the following:

- **Network/Ports > Standard Network > Standard Network Setup > Wireless**
- **Network/Ports > Network [x] > Network [x] Setup > Wireless**

Use	To
Wi-Fi Protected Setup (WPS) Start Push Button Method Start PIN Method	Establish a wireless network and enable network security. Notes: <ul style="list-style-type: none"> • Start Push Button Method connects the printer to a wireless network by pressing buttons on both the printer and the access point (wireless router) within a given period of time. • Start PIN Method connects the printer to a wireless network by using a PIN on the printer and entering it into the wireless settings of the access point.
Enable/Disable WPS Auto-detection Enable Disable	Automatically detect the connection method that an access point with WPS uses—Start Push Button Method or Start PIN Method. Note: Disable is the factory default setting.
Network Mode Infrastructure Ad hoc	Specify the network mode. Notes: <ul style="list-style-type: none"> • Ad hoc is the factory default setting. This configures wireless connection directly between the printer and a computer. • Infrastructure lets the printer access a network using an access point.
Compatibility 802.11b/g 802.11b/g/n	Specify the wireless standard for the wireless network. Note: The 802.11b/g/n is the factory default setting.
Choose Network	Select an available network for the printer to use.
View Signal Quality	View the quality of the wireless connection.

Use	To
View Security Mode	View the encryption method for the wireless network.

AppleTalk menu

Note: This menu is available only in printer models connected to a wired network or when an optional network card is installed.

To access the menu, navigate to any of the following:

- **Network/Ports > Standard Network > Standard Network Setup > AppleTalk**
- **Network/Ports > Network Setup [x] > AppleTalk**

Use	To
Activate Yes No	Enable or disable AppleTalk support. Note: Yes is the factory default setting.
View Name	Show the assigned AppleTalk name. Note: The name can be changed only from the Embedded Web Server.
View Address	Show the assigned AppleTalk address. Note: The address can be changed only from the Embedded Web Server.
Set Zone [list of zones available on the network]	Provide a list of AppleTalk zones available on the network. Note: The factory default setting is the default zone for the network. If no default zone exists, then the zone marked with an asterisk (*) is the default setting.

Standard USB menu

Use	To
PCL SmartSwitch On Off	Set the printer to automatically switch to PCL emulation when a print job received through a USB port requires it, regardless of the default printer language. Notes: <ul style="list-style-type: none"> • On is the factory default setting. • When set to Off, the printer does not examine incoming data. The printer uses PostScript emulation if the PS SmartSwitch is set to On. It uses the default printer language specified in the Setup menu if the PS SmartSwitch is set to Off.
PS SmartSwitch On Off	Set the printer to automatically switch to PS emulation when a print job received through a USB port requires it, regardless of the default printer language. Notes: <ul style="list-style-type: none"> • On is the factory default setting. • When set to Off, the printer does not examine incoming data. The printer uses PCL emulation if the PCL SmartSwitch is set to On. It uses the default printer language specified in the Setup menu if the PCL SmartSwitch is set to Off.

Use	To
NPA Mode On Off Auto	Set the printer to perform the special processing required for bidirectional communication following the conventions defined by the NPA protocol. Notes: <ul style="list-style-type: none"> • Auto is the factory default setting. Auto sets the printer to examine data, determine the format, and then process it appropriately. • The printer automatically restarts when changing the setting from the printer control panel. The menu selection is then updated.
USB Buffer Disabled Auto 3K to [maximum size allowed]	Set the size of the USB input buffer. Notes: <ul style="list-style-type: none"> • Auto is the factory default setting. • Disabled turns off job buffering. • The USB buffer size value can be changed in 1-KB increments. • The maximum size allowed depends on the amount of memory in the printer, the size of the other link buffers, and whether Resource Save is set to On or Off. • To increase the maximum size range for USB Buffer, disable or reduce the size of the parallel, serial, and network buffers. • The printer automatically restarts when the setting is changed from the printer control panel. The menu selection is then updated.
Mac Binary PS On Off Auto	Set the printer to process Macintosh binary PostScript print jobs. Notes: <ul style="list-style-type: none"> • Auto is the factory default setting. • On processes raw binary PostScript print jobs. • Off filters print jobs using the standard protocol.
ENA Address YYY.YYY.YYY.YYY	Set the network address information for an external print server. Note: This menu is available only when the printer is attached to an external print server through the USB port.
ENA Netmask YYY.YYY.YYY.YYY	Set the netmask information for an external print server. Note: This menu is available only when the printer is attached to an external print server through the USB port.
ENA Gateway YYY.YYY.YYY.YYY	Set the gateway information for an external print server. Note: This menu is available only when the printer is attached to an external print server through the USB port.

SMTP Setup menu

Use	To
Primary SMTP Gateway	Specify SMTP server gateway and port information. Note: 25 is the default SMTP gateway port.
Primary SMTP Gateway Port	
Secondary SMTP Gateway	
Secondary SMTP Gateway Port	
SMTP Timeout 5–30	Specify the amount of time in seconds before the server stops trying to send an e-mail. Note: 30 seconds is the factory default setting.
Reply Address	Specify a reply address of up to 128 characters in the e-mail sent by the printer.
Use SSL Disabled Negotiate Required	Set the printer to use SSL for increased security when connecting to the SMTP server. Notes: <ul style="list-style-type: none"> • Disabled is the factory default setting. • When the Negotiate setting is used, the SMTP server determines if SSL will be used.
SMTP Server Authentication No authentication required Login/Plain CRAM-MD5 Digest-MD5 NTLM Kerberos 5	Specify the type of user authentication required for printing privileges. Note: “No authentication required” is the factory default setting.
Device-Initiated E-mail None Use Device SMTP Credentials	Specify what credentials will be used when communicating to the SMTP server. Some SMTP servers require credentials to send an e-mail. Notes: <ul style="list-style-type: none"> • None is the factory default setting for Device-Initiated E-mail. • Device Userid and Device Password are used to log in to the SMTP server when Use Device SMTP Credentials is selected.
Device Userid	
Device Password	

Security menu

Miscellaneous Security Settings menu

Use	To
Login Restrictions Panel Login Timeout Remote Login Timeout	Limit the number and time frames of failed login attempts on the printer control panel before <i>all</i> users are locked out. Notes: <ul style="list-style-type: none"> Panel Login Timeout specifies how long the printer remains idle on the printer control panel before automatically logging the user off. Settings range from 1 to 900 seconds. 3 seconds is the factory default setting. Remote Login Timeout specifies how long a remote interface remains idle before automatically logging the user off. Settings range from 1 to 120 minutes. 10 minutes is the factory default setting.
Minimum PIN Length 1–16	Limit the digit length of the PIN. Note: 4 is the factory default setting.

Security Audit Log menu

Use	To
Export Log	Let an authorized user export the audit log. Notes: <ul style="list-style-type: none"> To export the audit log from the printer control panel, connect a flash drive to the printer. You can also download the audit log from the Embedded Web Server, and then save it on your computer.
Delete Log Delete now Do not delete	Specify whether or not audit logs are deleted. Note: Delete now is the factory default setting.
Configure Log Enable Audit Yes No Enable Remote Syslog No Yes Remote Syslog Facility 0–23 Severity of events to log 0–7	Specify how and whether or not audit logs are created. Notes: <ul style="list-style-type: none"> Enable Audit determines if events are recorded in the secure audit log and remote syslog. No is the factory default setting. Enable Remote Syslog determines if logs are sent to a remote server. No is the factory default setting. Remote Syslog Facility determines the value used to send logs to the remote syslog server. 4 is the factory default setting. If the security audit log is activated, then the severity value of each event is recorded. 4 is the factory default setting.

Set Date and Time menu

Use	To
Current Date and Time	Show the current date and time settings for the printer.
Manually Set Date and Time [input date/time]	Enter the date and time. Notes: <ul style="list-style-type: none"> • For touch-screen printer models, date and time are set in YYYY-MM-DD HH:MM format. • Manually setting the date and time sets Enable NTP to No. • For non-touch-screen printer models, the wizard lets you set the date and time in YYYY-MM-DD-HH:MM format.
Time Zone [list of time zones]	Select the time zone. Note: GMT is the factory default setting for non-touch-screen printer models.
Automatically observe DST On Off	Set the printer to use the applicable daylight saving time (DST) start and end times associated with the printer Time Zone setting. Note: On is the factory default setting.
Enable NTP On Off	Enable Network Time Protocol, which synchronizes the clocks of devices on a network. Notes: <ul style="list-style-type: none"> • On is the factory default setting. • The setting is turned off if you manually set the date and time.

Settings menu

General Settings menu

Use	To
<p>Display Language</p> <ul style="list-style-type: none"> English Francais Deutsch Italiano Espanol Dansk Norsk Nederlands Svenska Portuguese Suomi Russian Polski Greek Magyar Turkce Cesky Simplified Chinese Traditional Chinese Korean Japanese 	<p>Set the language of the text appearing on the printer display.</p> <p>Note: Not all languages are available for all printers, and you may need to install special hardware for those languages to appear.</p>
<p>Show Supply Estimates</p> <ul style="list-style-type: none"> Show estimates Do not show estimates 	<p>View the estimates of the supplies on the printer control panel, Embedded Web Server, menu settings, and the device statistics reports.</p>
<p>Eco-Mode</p> <ul style="list-style-type: none"> Off Energy Energy/Paper Paper 	<p>Minimize the use of energy, paper, or specialty media.</p> <p>Notes:</p> <ul style="list-style-type: none"> • Off is the factory default setting. Off resets the printer to its factory default settings. • Energy minimizes the power used by the printer. • Energy/Paper minimizes the use of power and of paper and specialty media. • Paper minimizes the amount of paper and specialty media needed for a print job.

Use	To
Run Initial setup Yes No	Run the setup wizard. Notes: <ul style="list-style-type: none"> • Yes is the factory default setting. • After completing the setup wizard by selecting Done at the country or region selection screen, the default becomes No.
Paper Sizes US Metric	Specify the unit of measurement for paper sizes. Notes: <ul style="list-style-type: none"> • US is the factory default setting. • The initial setting is determined by your country or region selection in the initial setup wizard.
Timeouts Sleep Mode Disabled 1–120 min	Set the amount of time the printer waits after a job is printed before it goes into a reduced power state. Notes: <ul style="list-style-type: none"> • “30 min” is the factory default setting. • “Disabled” appears only when Energy Conserve is set to Off. • Lower settings conserve more energy, but may require longer warm-up times. • Select a high setting if the printer is in constant use. Under most circumstances, this keeps the printer ready to print with minimum warm-up time.
Timeouts Hibernate Timeout Disabled 1 hour 2 hours 3 hours 6 hours 1 day 2 days 3 days 1 week 2 weeks 1 month	Set the amount of time the printer waits before it enters Hibernate mode. Notes: <ul style="list-style-type: none"> • “Disabled” is the factory default setting in all countries except European Union countries and Switzerland. • “3 days” is the factory default setting for all European Union countries and Switzerland.
Timeouts Hibernate Timeout on Connection Hibernate Do Not Hibernate	Set the printer to Hibernate mode even if there is an active Ethernet connection. Note: “Do Not Hibernate” is the factory default setting.
Timeouts Screen Timeout 15–300 sec	Set the amount of time in seconds the printer waits before the it returns to a ready state. Note: “30 sec” is the factory default setting.

Use	To
Timeouts Prolong Screen Timeout On Off	Display a message that lets you reset the screen timeout timer instead of returning to the printer display. Note: Off is the factory default setting.
Timeouts Print Timeout Disabled 1–255 sec	Set the amount of time in seconds the printer waits to receive an end-of-job message before canceling the remainder of the print job. Notes: <ul style="list-style-type: none"> • “90 sec” is the factory default setting. • When the timer expires, any partially printed page still in the printer is printed, and then the printer checks to see if any new print jobs are waiting. • Print Timeout is available only when using PCL emulation. This setting has no effect on PostScript emulation print jobs.
Timeouts Wait Timeout Disabled 15–65535 sec	Set the amount of time in seconds the printer waits for additional data before canceling a print job. Note: “40 sec” is the factory default setting.
Print Recovery Auto Continue Disabled 5–255 sec	Let the printer automatically continue printing from certain offline situations when these are not resolved within the specified time period. Note: Disabled is the factory default setting.
Print Recovery Jam Recovery On Off Auto	Specify whether the printer reprints jammed pages. Notes: <ul style="list-style-type: none"> • Auto is the factory default setting. The printer reprints jammed pages unless the memory required to hold the pages is needed for other printer tasks. • On sets the printer to always reprint jammed pages. • Off sets the printer to never reprint jammed pages.
Print Recovery Jam Assist On Off	Notes: <ul style="list-style-type: none"> • On is the factory default setting. On sets the printer to automatically dump blank pages or partially printed pages to the standard bin after a jammed page has been cleared. • Off requires the user to remove all pages from all possible jam locations.
Print Recovery Page Protect Off On	Successfully print a page that may not have printed otherwise. Notes: <ul style="list-style-type: none"> • Off is the factory default setting. Off prints a partial page when there is not enough memory to print the whole page. • On sets the printer to process the whole page so that the entire page prints.

Use	To
Press Sleep Button Do nothing Sleep Hibernate	Determine how the printer, while in idle state, reacts to a short press of the Sleep button. Note: Sleep is the factory default setting.
Press and Hold Sleep Button Do nothing Sleep Hibernate	Determine how the printer, while in idle state, reacts to a long press of the Sleep button. Note: Sleep is the factory default setting.
Factory Defaults Do Not Restore Restore Now	Use the printer factory default settings. Notes: <ul style="list-style-type: none"> • Do Not Restore is the factory default setting. Do Not Restore retains the user-defined settings. • Restore Now sets all printer settings to the factory default settings except Network/Ports menu settings. All downloads stored in the RAM are deleted. Downloads stored in the flash memory are not affected.
Custom Home Message Off IP Address Hostname Contact Name Location Zero Configuration Name Custom Text 1	Select a custom home message that appears as an alternating display of the printer status. Note: Off is the factory default setting.

Setup menu

Use	To
Printer Language PCL Emulation PS Emulation	Set the default printer language. Notes: <ul style="list-style-type: none"> • PCL Emulation is the factory default setting. • PostScript emulation uses a PostScript interpreter for processing print jobs. • PCL Emulation uses a PCL interpreter for processing print jobs. • Setting a printer language default does not prevent a software program from sending print jobs that use another printer language.

Use	To
<p>Print Area</p> <p>Normal</p> <p>Whole Page</p>	<p>Set the logical and physical printable area.</p> <p>Notes:</p> <ul style="list-style-type: none"> • Normal is the factory default setting. When attempting to print data on the non-printable area defined by the Normal setting, the printer clips the image at the boundary. • Whole Page allows the image to be moved into the non-printable area defined by the Normal setting. This setting affects only pages printed using a PCL 5 interpreter and has no effect on pages printed using the PCL XL or PostScript interpreter.
<p>Download Target</p> <p>RAM</p> <p>Flash</p>	<p>Set the storage location for downloads.</p> <p>Notes:</p> <ul style="list-style-type: none"> • RAM is the factory default setting. Storing downloads in the RAM is temporary. • Storing downloads in a flash memory places them in permanent storage. Downloads remain in the flash memory even when the printer is turned off. • This menu item appears only when an optional flash memory is installed.
<p>Resource Save</p> <p>On</p> <p>Off</p>	<p>Specify how the printer handles temporary downloads, such as fonts and macros stored in the RAM, when the printer receives a print job that requires more than the available memory.</p> <p>Notes:</p> <ul style="list-style-type: none"> • Off is the factory default setting. Off sets the printer to retain downloads only until memory is needed. Downloads are deleted in order to process print jobs. • On sets the printer to retain downloads during language changes and printer resets. If the printer runs out of memory, then Memory Full [38] appears on the printer display, but downloads are not deleted.

Finishing menu

Use	To
Sides (Duplex) 1 sided 2 sided	Specify whether two-sided (duplex) printing is set as the default for all print jobs. Notes: <ul style="list-style-type: none"> • “1 sided” is the factory default setting. • You can set two-sided printing from the software program. For Windows users: <ol style="list-style-type: none"> 1 Click File > Print. 2 Click Properties, Preferences, Options, or Setup. For Macintosh users: <ol style="list-style-type: none"> 1 Choose File > Print. 2 Adjust the settings from the print dialog and pop-up menus.
Duplex Binding Long Edge Short Edge	Define the way two-sided pages are bound and printed. Notes: <ul style="list-style-type: none"> • Long Edge is the factory default setting. Long Edge binds pages along their long edge (left edge for portrait and top edge for landscape). • Short Edge binds pages along their short edge (top edge for portrait and left edge for landscape).
Copies 1–999	Specify the default number of copies for each print job. Note: 1 is the factory default setting.
Blank Pages Do Not Print Print	Specify whether to insert blank pages in a print job. Note: Do Not Print is the factory default setting.
Collate (1,1,1) (2,2,2) (1,2,3) (1,2,3)	Stack the pages of a print job in sequence when printing multiple copies. Note: “(1,2,3) (1,2,3)” is the factory default setting.
Separator Sheets Off Between Copies Between Jobs Between Pages	Specify whether to insert blank separator sheets. Notes: <ul style="list-style-type: none"> • Off is the factory default setting. • Between Copies inserts a blank sheet between each copy of a print job if Collate is set to (1,1,1) (2,2,2). If Collate is set to (1,2,3) (1,2,3), then a blank page is inserted between each set of printed pages, such as after all page 2's and after all page 3's. • Between Jobs inserts a blank sheet between print jobs. • Between Pages inserts a blank sheet between each page of a print job. This setting is useful when printing transparencies or when inserting blank pages in a document.
Separator Source Tray [x] Multi-Purpose Feeder	Specify the paper source for separator sheets. Note: Tray 1 (standard tray) is the factory default setting.

Use	To
Paper Saver Off 2-Up 3-Up 4-Up 6-Up 9-Up 12-Up 16-Up	Print multiple-page images on one side of a paper. Notes: <ul style="list-style-type: none"> • Off is the factory default setting. • The number selected is the number of page images that will print per side.
Paper Saver Ordering Horizontal Reverse Horizontal Reverse Vertical Vertical	Specify the positioning of multiple-page images when using Paper Saver. Notes: <ul style="list-style-type: none"> • Horizontal is the factory default setting. • Positioning depends on the number of page images and whether they are in portrait or landscape orientation.
Paper Saver Orientation Auto Landscape Portrait	Specify the orientation of a multiple-page document. Note: Auto is the factory default setting. The printer chooses between portrait and landscape.
Paper Saver Border None Solid	Print a border when using Paper Saver. Note: None is the factory default setting.

Quality menu

Use	To
Print Resolution 300 dpi 600 dpi 1200 dpi 1200 Image Q 2400 Image Q	Specify the printed output resolution in dots per inch. Note: 600 dpi is the factory default setting.
Pixel Boost Off Fonts Horizontally Vertically Both directions Isolated	Enable more pixels to print in clusters for clarity, in order to enhance images horizontally or vertically, or to enhance fonts. Note: Off is the factory default setting.

Use	To
Toner Darkness 1–10	Lighten or darken the printed output. Notes: <ul style="list-style-type: none"> • 8 is the factory default setting. • Selecting a smaller number can help conserve toner.
Enhance Fine Lines On Off	Enable a print mode preferable for files such as architectural drawings, maps, electrical circuit diagrams, and flow charts. Notes: <ul style="list-style-type: none"> • Off is the factory default setting. • You can set this option from the printer software. For Windows users, click File > Print, and then click Properties, Preferences, Options, or Setup. For Macintosh users, choose File > Print, and then adjust the settings from the Print dialog and pop-up menus. • To set this option using the Embedded Web Server, type the network printer IP address in the Web browser address field.
Gray Correction Auto Off	Automatically adjust the contrast enhancement applied to images. Note: Auto is the factory default setting.
Brightness -6 to 6	Adjust the printed output either by lightening or darkening it. You can conserve toner by lightening the output. Note: 0 is the factory default setting.
Contrast 0–5	Adjust the contrast of printed objects. Note: 0 is the factory default setting.

Utilities menu

Use	To
Format Flash Yes No	Format the flash memory. Warning—Potential Damage: Do not turn off the printer while the flash memory is being formatted. Notes: <ul style="list-style-type: none"> • Flash memory refers to the memory added by installing a flash memory card in the printer. • Yes deletes all data stored in the flash memory. • No cancels the format request. • The flash memory option card must not be read/write- or write-protected. • This menu item appears only when a non-defective flash memory card is installed.

Use	To
Hex Trace	Assist in isolating the source of a print job problem. Notes: <ul style="list-style-type: none"> • When activated, all data sent to the printer is printed in hexadecimal and character representation, and control codes are not executed. • To exit or deactivate Hex Trace, turn off or reset the printer.
Coverage Estimator Off On	Provide an estimate of the percentage coverage of toner on a page. The estimate is printed on a separate page at the end of each print job. Note: Off is the factory default setting.

XPS menu

Use	To
Print Error Pages Off On	Print a page containing information on errors, including XML markup errors. Note: Off is the factory default setting.

PDF menu

Use	To
Scale to Fit Yes No	Scale page content to fit the selected paper size. Note: No is the factory default setting.
Annotations Do Not Print Print	Print annotations in a PDF. Note: Do Not Print is the factory default setting.

PostScript menu

Use	To
Print PS Error On Off	Print a page containing the PostScript error. Note: Off is the factory default setting.
Lock PS Startup Mode On Off	Disable the SysStart file. Note: Off is the factory default setting.

Use	To
Font Priority Resident Flash	Establish the font search order. Notes: <ul style="list-style-type: none"> • Resident is the factory default setting. • This menu item is available only when a formatted flash memory card is installed and operating properly. • Make sure the flash memory card is not read/write-, write-, or password-protected. • Job Buffer Size must not be set to 100%.

PCL Emul menu

Use	To
Font Source Resident Download Flash All	Specify the set of fonts used by the Font Name menu. Notes: <ul style="list-style-type: none"> • “Resident” is the factory default setting. “Resident” shows the factory default set of fonts downloaded in the RAM. • “Download” shows all the fonts downloaded in the RAM. • “Flash” shows all fonts resident in that option. The optional flash memory card must be properly formatted and cannot be read/write-, write-, or password-protected. • “All” shows all fonts available to any option.
Font Name Courier 10	Identify a specific font and the option where it is stored. Note: Courier 10 is the factory default setting. Courier 10 shows the font name, font ID, and the storage location in the printer. The font source abbreviation is R for Resident, F for Flash, and D for Download.
Symbol Set 10U PC-8 12U PC-850	Specify the symbol set for each font name. Notes: <ul style="list-style-type: none"> • 10U PC-8 is the US factory default setting. 12U PC-850 is the international factory default setting. • A symbol set is a set of alphabetic and numeric characters, punctuation, and special symbols. Symbol sets support the different languages or specific program, such as math symbols for scientific text. Only the supported symbol sets are shown.
PCL Emulation Settings Point Size 1.00–1008.00	Change the point size for scalable typographic fonts. Notes: <ul style="list-style-type: none"> • 12 is the factory default setting. • Point size refers to the height of the characters in the font. One point equals approximately 0.014 inch. • Point sizes can be increased or decreased in 0.25-point increments.

Use	To
PCL Emulation Settings Pitch 0.08–100	Specify the font pitch for scalable monospaced fonts. Notes: <ul style="list-style-type: none"> • 10 is the factory default setting. • Pitch refers to the number of fixed-space characters per inch (dpi). • Pitch can be increased or decreased in 0.01-dpi increments. • For nonscalable monospaced fonts, the pitch appears on the display but it cannot be changed.
PCL Emulation Settings Orientation Portrait Landscape	Specify the orientation of text and graphics on the page. Notes: <ul style="list-style-type: none"> • Portrait is the factory default setting. Portrait prints text and graphics parallel to the short edge of the page. • Landscape prints text and graphics parallel to the long edge of the page.
PCL Emulation Settings Lines per Page 1–255	Specify the number of lines that print on each page. Notes: <ul style="list-style-type: none"> • 60 is the US factory default setting. 64 is the international default setting. • The printer sets the amount of space between each line based on the Lines per Page, Paper Size, and Orientation settings. Select the Paper Size and Orientation you want before setting Lines per Page.
PCL Emulation Settings A4 Width 198 mm 203 mm	Set the printer to print on A4-size paper. Notes: <ul style="list-style-type: none"> • 198 mm is the factory default setting. • The 203-mm setting sets the width of the page to allow printing of eighty 10-pitch characters.
PCL Emulation Settings Auto CR after LF On Off	Specify whether the printer automatically performs a carriage return (CR) after a line feed (LF) control command. Note: Off is the factory default setting.
PCL Emulation Settings Auto LF after CR On Off	Specify whether the printer automatically performs a line feed (LF) after a carriage return (CR) control command. Note: Off is the factory default setting.

Use	To
<p>Tray Renumber</p> <p>Assign MP Feeder Off None 0–199</p> <p>Assign Tray [x] Off None 0–199</p> <p>Assign Manual Paper Off None 0–199</p> <p>Assign Manual Env Off None 0–199</p>	<p>Configure the printer to work with printer software or programs that use different source assignments for trays and feeders.</p> <p>Notes:</p> <ul style="list-style-type: none"> • Off is the factory default setting. • None cannot be selected. It is only displayed when it is selected by the PCL 5 interpreter. It also ignores the Select Paper Feed command. • 0–199 allows a custom setting to be assigned.
<p>Tray Renumber</p> <p>View Factory Defaults</p> <p>MPF Default = 8 T1 Default = 1 T1 Default = 4 T1 Default = 5 T1 Default = 20 T1 Default = 21 Env Default = 6 MPaper Default = 2 MEnv Default = 3</p>	<p>Display the factory default setting assigned to each tray or feeder.</p>
<p>Tray Renumber</p> <p>Restore Defaults</p> <p>Yes No</p>	<p>Restore all tray and feeder assignments to their factory default settings.</p>

HTML menu

Use		To
Font Name Albertus MT Antique Olive Apple Chancery Arial MT Avant Garde Bodoni Bookman Chicago Clarendon Cooper Black Copperplate Coronet Courier Eurostile Garamond Geneva Gill Sans Goudy Helvetica Hoefler Text Intl CG Times Intl Courier Intl Univers	Joanna MT Letter Gothic Lubalin Graph Marigold MonaLisa Recut Monaco New CenturySbk New York Optima Oxford Palatino StempelGaramond Taffy Times TimesNewRoman Univers Zapf Chancery NewSansMTCS NewSansMTCT New SansMTJA NewSansMTKO	Set the default font for HTML documents. Note: The Times font is used in HTML documents that do not specify a font.

Use	To
Font Size 1–255 pt	Set the default font size for HTML documents. Notes: <ul style="list-style-type: none"> • 12 pt is the factory default setting. • Font size can be increased in 1-point increments.
Scale 1–400%	Scale the default font for HTML documents. Notes: <ul style="list-style-type: none"> • 100% is the factory default setting. • Scaling can be increased in 1% increments.
Orientation Portrait Landscape	Set the page orientation for HTML documents. Note: Portrait is the factory default setting.

Use	To
Margin Size 8–255 mm	Set the page margin for HTML documents. Notes: <ul style="list-style-type: none"> • 19 mm is the factory default setting. • Margin size can be increased in 1-mm increments.
Backgrounds Do Not Print Print	Specify whether to print backgrounds on HTML documents. Note: Print is the factory default setting.

Image menu

Use	To
Auto Fit On Off	Select the optimal paper size, scaling, and orientation. Note: On is the factory default setting. It overrides scaling and orientation settings for some images.
Invert On Off	Invert bitonal monochrome images. Notes: <ul style="list-style-type: none"> • Off is the factory default setting. • This setting does not apply to GIF or JPEG images.
Scaling Anchor Top Left Best Fit Anchor Center Fit Height/Width Fit Height Fit Width	Scale the image to fit the selected paper size. Notes: <ul style="list-style-type: none"> • Best Fit is the factory default setting. • When Auto Fit is set to On, Scaling is automatically set to Best Fit.
Orientation Portrait Landscape Reverse Portrait Reverse Landscape	Set the image orientation. Note: Portrait is the factory default setting.

Help menu

The Help menu consists of a series of Help pages that are stored in the printer as PDFs. They contain information about using the printer and performing printing tasks.

English, French, German, and Spanish translations are stored in the printer. Other translations are available on the *Software and Documentation* CD.

Use	To
Print All Guides	Print all the guides.
Print Quality	Print information about solving print quality issues.

Use	To
Printing Guide	Print information about loading paper and other specialty media.
Media Guide	Print a list of the paper sizes supported in trays and feeders.
Print Defects Guide	Print information about resolving print defects.
Menu Map	Print a list of the printer control panel menus and settings.
Information Guide	Print a guide in locating additional information.
Connection Guide	Print information about connecting the printer locally (USB) or to a network.
Moving Guide	Print instructions for safely moving the printer.

Saving money and the environment

Saving paper and toner

Studies show that as much as 80% of the carbon footprint of a printer is related to paper usage. You can significantly reduce your carbon footprint by using recycled paper and the following printing suggestions, such as printing on both sides of the paper and printing multiple pages on one side of a single sheet of paper.

For information on how you can quickly save paper and energy using one printer setting, see "Using Eco-Mode".

Using recycled paper

As an environmentally conscious company, we support the use of recycled office paper produced specifically for use in laser printers. For more information on recycled papers that work well with your printer, see "Using recycled paper and other office papers" on page 40.

Conserving supplies

Use both sides of the paper

If your printer model supports duplex printing, then you can control whether print appears on one or two sides of the paper by selecting **2-sided printing** from the Print dialog.

Place multiple pages on one sheet of paper

You can print up to 16 consecutive pages of a multiple-page document onto one side of a single sheet of paper by selecting a setting from the Multipage printing (N-Up) section of the Print dialog screen.

Check your first draft for accuracy

Before printing or making multiple copies of a document:

- Use the preview feature, which you can select from the Print dialog to see how the document will look like before you print it.
- Print one copy of the document to check its content and format for accuracy.

Avoid paper jams

Correctly set the paper type and size to avoid paper jams. For more information, see "Avoiding jams" on page 105.

Saving energy

Using Eco-mode

Use Eco-Mode to quickly select one or more ways to reduce your printer's environmental impact.

- 1 From the printer control panel, navigate to:

 > Settings > Settings >  > General Settings >  > Eco-Mode >  > select the setting you want

Use	To
Off	Use the factory default settings for all settings associated with Eco-Mode. This setting supports the performance specifications for your printer.
Energy	Reduce energy use, especially when the printer is idle. <ul style="list-style-type: none"> • Printer engine motors do not start until a job is ready to print. You may notice a short delay before the first page is printed. • The printer enters Sleep mode after one minute of inactivity.
Energy/Paper	Use all the settings associated with Energy and Paper modes.
Plain Paper	<ul style="list-style-type: none"> • Enable the automatic two-sided (duplex) feature. • Turn off print log features.

2 Press .

Reducing printer noise

Use Quiet mode to reduce the printer noise.

1 From the printer control panel, navigate to:

 > Settings > Settings >  > General Settings >  > Quiet Mode > 

2 Select a setting you want.

Use	To
On	Reduce printer noise. <p>Notes:</p> <ul style="list-style-type: none"> • Print jobs will process at a reduced speed. • Printer engine motors do not start until a document is ready to print. There is a short delay before the first page is printed.
Off	Use factory default settings. <p>Note: This setting supports the performance specifications of the printer.</p>

3 Press .

Adjusting Sleep mode

To save energy, decrease the number of minutes the printer waits before it enters Sleep mode.

Available settings range from 1–180 minutes. The factory default setting is 30 minutes.

Using the Embedded Web Server

1 Open a Web browser, and then type the printer IP address in the address field.

Notes:

- View the printer IP address in the TCP/IP section in the Network/Reports menu. The IP address appears as four sets of numbers separated by periods, such as 123.123.123.123.
- If you are using a proxy server, then temporarily disable it to load the Web page correctly.

2 Click **Settings > General Settings > Timeouts**.

3 In the Sleep Mode field, enter the number of minutes you want the printer to wait before it enters Sleep mode.

4 Click **Submit**.

Using the printer control panel

1 From the printer control panel, navigate to:

 > **Settings** > **Settings** >  > **General Settings** >  > **Timeouts** >  > **Sleep Mode** > 

2 Press the left or right arrow button to select the number of minutes you want the printer to wait before it enters Sleep mode.

3 Press .

Using Hibernate Mode

Hibernate is an ultra-low power operating mode. When operating in Hibernate mode, all other systems and devices are powered down safely.

Note: The Hibernate and Sleep modes can be scheduled.

Using the Embedded Web Server

1 Open a Web browser, and then type the printer IP address in the address field.

Notes:

- View the printer IP address in the TCP/IP section in the Network/Reports menu. The IP address appears as four sets of numbers separated by periods, such as 123.123.123.123.
- If your are using a proxy server, then temporarily disable it to load the Web page correctly.

2 Click **Settings > General Settings > Sleep Button Settings**.

3 From the Press Sleep Button or Press and Hold Sleep Button drop-down menu, select **Hibernate**.

4 Click **Submit**.

Using the printer control panel

1 From the printer control panel, navigate to:

 > **Settings** > **Settings** >  > **General Settings** > 

2 Press **Press Sleep Button** or **Press and Hold Sleep Button**, and then press .

3 Press **Hibernate** > .

Adjusting the brightness of the printer display

To save energy, or if you have trouble reading the display, adjust its brightness settings.

Using the Embedded Web Server

- 1 Open a Web browser, and then type the printer IP address in the address field.

Notes:

- View the printer IP address in the TCP/IP section in the Network/Ports menu. The IP address appears as four sets of numbers separated by periods, such as 123.123.123.123.
- If you are using a proxy server, then temporarily disable it to load the Web page correctly.

- 2 Click **Settings > General Settings**.
- 3 In the Screen Brightness field, enter the brightness percentage you want for the display.
- 4 Click **Submit**.

Recycling

Recycling Dell products

To return Dell products for recycling:

- 1 Visit our Web site at www.dell.com/recycle.
- 2 Select your country or region.
- 3 Follow the instructions on the computer screen.

Securing the printer

Using the security lock feature

The printer is equipped with a security lock feature. Attach a security lock compatible with most laptop computers in the location shown to secure the printer in place.



Statement of Volatility

Your printer contains various types of memory that can store device and network settings, and user data.

Type of memory	Description
Volatile memory	Your printer uses standard <i>random access memory</i> (RAM) to temporarily buffer user data during simple print jobs.
Non-volatile memory	Your printer may use two forms of non-volatile memory: EEPROM and NAND (flash memory). Both types are used to store operating system, device settings, and network information.

Erase the content of any installed printer memory in the following circumstances:

- The printer is being decommissioned.
- The printer is being moved to a different department or location.
- The printer is being serviced by someone from outside your organization.
- The printer is being removed from your premises for service.
- The printer is being sold to another organization.

Erasing volatile memory

The volatile memory (RAM) installed in your printer requires a power source to retain information. To erase the buffered data, turn off the printer.

Erasing non-volatile memory

Erase individual settings, device and network settings, security settings, and embedded solutions by following these steps:

- 1 Turn off the printer.
- 2 Hold down **2** and **6** on the keypad while turning the printer on. Release the buttons only when the screen with the progress bar appears.

The printer performs a power-on sequence, and then the Configuration menu appears. When the printer is fully turned on, a list of functions appears on the printer display.

- 3 Press the up or down arrow button until **Wipe All Settings** appears.

The printer will restart several times during this process.

Note: Wipe All Settings securely removes device settings, solutions, jobs, and passwords from the printer memory.

- 4 Navigate to:

Back > Exit Config Menu

The printer will perform a power-on reset, and then return to normal operating mode.

Finding printer security information

In high-security environments, it may be necessary to take additional steps to make sure that confidential data stored in the printer cannot be accessed. For more information, see the *Embedded Web Server Administrator's Guide*.

Maintaining the printer

Periodically, certain tasks are required to maintain the optimum performance of your printer.

Warning—Potential Damage: Failure to replace parts and supplies when directed, may cause damage to your printer or prevent the printer from performing optimally.

Cleaning the printer

Cleaning the printer

Note: You may need to perform this task after every few months.

Warning—Potential Damage: Damage to the printer caused by improper handling is not covered by the printer warranty.

- 1 Make sure that the printer is turned off and unplugged from the electrical outlet.



CAUTION—SHOCK HAZARD: To avoid the risk of electrical shock when cleaning the exterior of the printer, unplug the power cord from the electrical outlet and disconnect all cables from the printer before proceeding.

- 2 Remove paper from the standard bin and multipurpose feeder.
- 3 Remove any dust, lint, and pieces of paper around the printer using a soft brush or vacuum.
- 4 Dampen a clean, lint-free cloth with water, and use it to wipe the outside of the printer.

Warning—Potential Damage: Do not use household cleaners or detergents to prevent damage to the exterior of the printer.

- 5 Make sure all areas of the printer are dry before sending a new print job.

Checking the status of parts and supplies

A message appears on the printer display when a replacement supply item is needed or when maintenance is required.

Checking the status of parts and supplies on the printer control panel

From the printer control panel, navigate to:



Checking the status of parts and supplies from the Embedded Web Server

Note: Make sure the computer and printer are connected to the same network.

- 1 Open a Web browser, and then type the printer IP address in the address field.

Notes:

- View the printer IP address in the TCP/IP section in the Network/Ports menu. The IP address appears as four sets of numbers separated by periods, such as 123.123.123.123.
- If you are using a proxy server, then temporarily disable it to load the Web page correctly.

2 Click **Device Status > More Details**.

Estimated number of remaining pages

The estimated number of remaining pages is based on the recent printing history of the printer. Its accuracy may vary significantly and is dependent on many factors, such as actual document content, print quality settings, and other printer settings.

The accuracy of the estimated number of remaining pages may decrease when the actual printing consumption is different from the historical printing consumption. Consider the variable level of accuracy before purchasing or replacing supplies based on the estimate. Until an adequate print history is obtained on the printer, initial estimates assume future supplies consumption based on the International Organization for Standardization* test methods and page content.

* Average continuous black declared cartridge yield in accordance with ISO/IEC 19752.

Ordering supplies

Ordering supplies using the Supplies Ordering Utility

- 1 Click  or **Start**.
- 2 Click **All Programs** or **Programs**, and then select the printer program folder from the list.
- 3 Select your printer, and then navigate to:
Status Monitor Center > Order Supplies
- 4 From the Order Printer Supplies dialog, do any of the following:
 - Click **Order Online** to order supplies on the Internet.
 - Click **Order by Phone** to order supplies by phone.

Ordering supplies using Printer Home

- 1 Click  or **Start**.
- 2 Click **All Programs** or **Programs**, and then select the printer program folder from the list.
- 3 Select your printer, and then navigate to:
Dell Printer Home > Maintenance > Order supplies
- 4 From the Order Printer Supplies dialog, do any of the following:
 - Click **Order Online** to order supplies on the Web.
 - Click **Order by Phone** to order supplies by phone.

Storing supplies

Choose a cool, clean storage area for the printer supplies. Store supplies right side up in their original packing until you are ready to use them.

Do not expose supplies to:

- Direct sunlight
- Temperatures above 35°C (95°F)
- High humidity above 80%
- Salty air
- Corrosive gases
- Heavy dust

Replacing supplies

Replacing the toner cartridge

- 1 Press the button on the right side of the printer, and then open the front door.

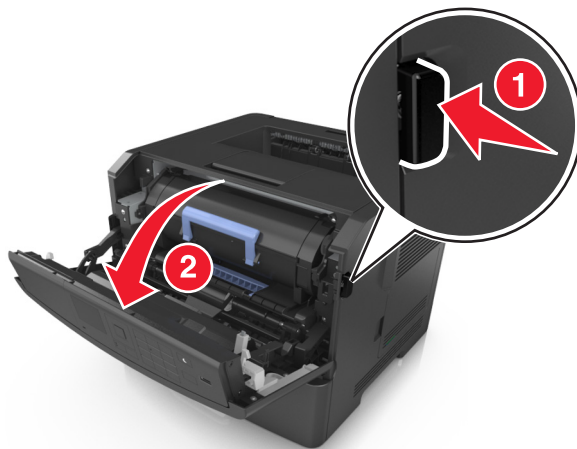

- 2 Pull the toner cartridge out using the handle.

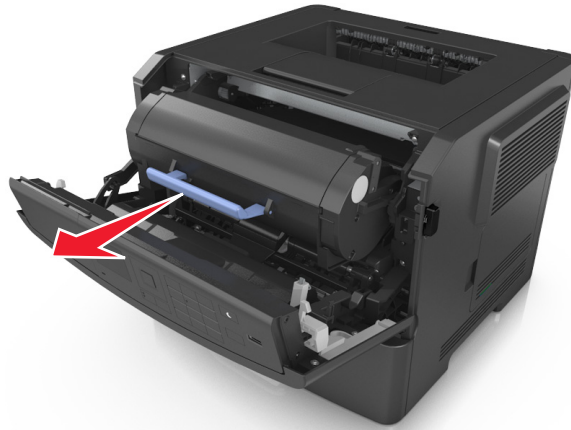

- 3 Unpack the toner cartridge, and then remove all packing materials.
- 4 Shake the new cartridge to redistribute the toner.

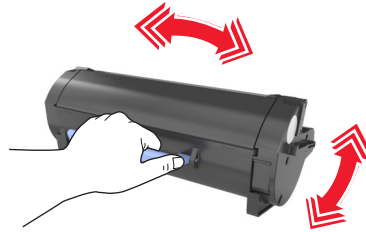

- 5 Insert the toner cartridge into the printer by aligning the side rails of the cartridge with the arrows on the side rails inside the printer.

Warning—Potential Damage: Do not expose the imaging unit to direct light for more than 10 minutes. Extended exposure to light may cause print quality problems.

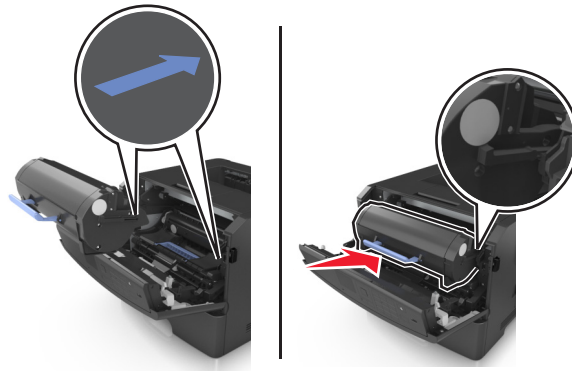

- 6 Close the front door.

Replacing the imaging unit

- 1 Press the button on the right side of the printer, and then open the front door.

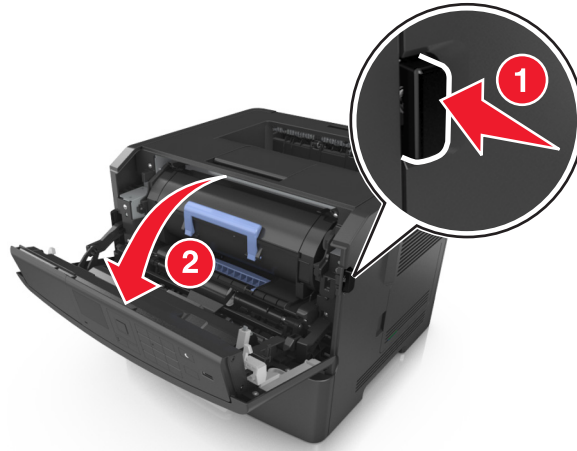

- 2 Pull the toner cartridge out using the handle.

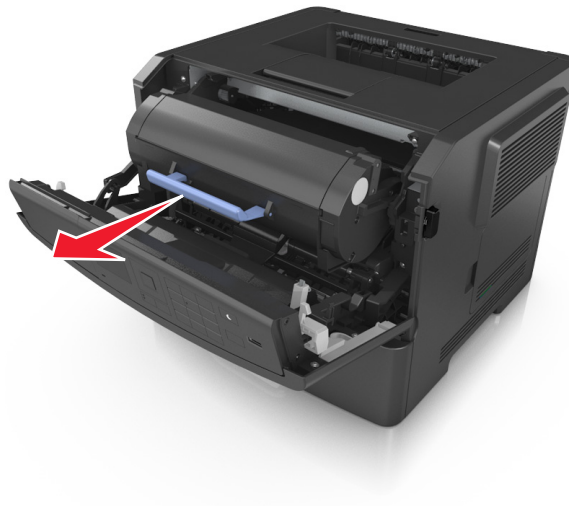

- 3 Lift the blue handle, and then pull the imaging unit out of the printer.



- 4 Unpack the new imaging unit, and then shake it.

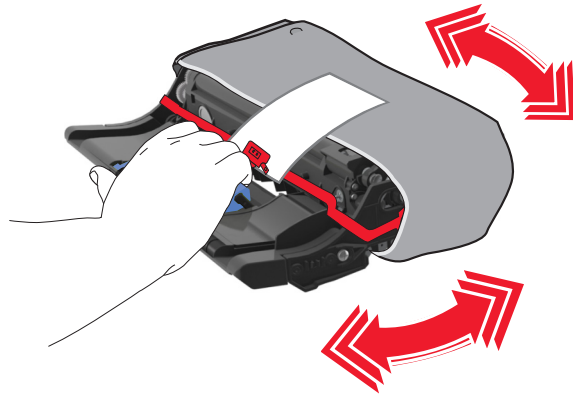

- 5 Remove all packing materials from the imaging unit.

Warning—Potential Damage: Do not expose the imaging unit to direct light for more than 10 minutes. Extended exposure to light may cause print quality problems.

Warning—Potential Damage: Do not touch the photoconductor drum. Doing so may affect the print quality of future print jobs.

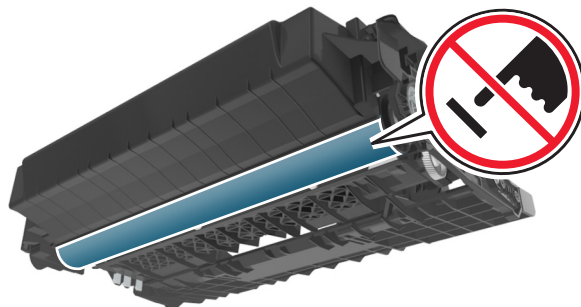

- 6 Insert the imaging unit into the printer by aligning the arrows on the side rails of the imaging unit with the arrows on the side rails inside the printer.

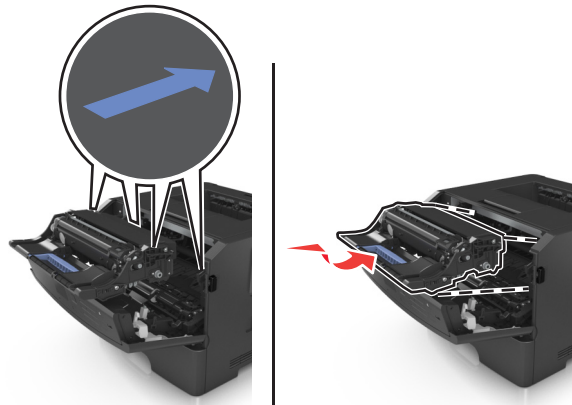

- 7 Insert the toner cartridge into the printer by aligning the side rails of the cartridge with the arrows on the side rails inside the printer.

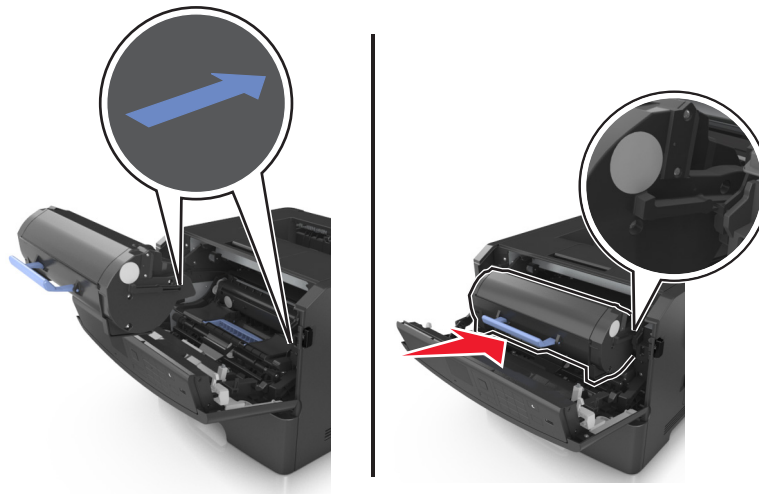

- 8 Close the front door.

Moving the printer

Before moving the printer

⚠ CAUTION—POTENTIAL INJURY: Before moving the printer, follow these guidelines to avoid personal injury or printer damage:

- Turn the printer off using the power switch, and then unplug the power cord from the electrical outlet.
- Disconnect all cords and cables from the printer before moving it.

- If an optional tray is installed, then remove it from the printer. To remove the optional tray, slide the latch on the right side of the tray toward the front of the tray until it *clicks* into place.



- Use the handholds located on both sides of the printer to lift it.
- Make sure your fingers are not under the printer when you set it down.
- Before setting up the printer, make sure there is adequate clearance around it.

Use only the power cord provided with this product or the manufacturer's authorized replacement.

Warning—Potential Damage: Damage to the printer caused by improper moving is not covered by the printer warranty.

Moving the printer to another location

The printer and its hardware options can be safely moved to another location by following these precautions:

- Any cart used to move the printer must have a surface able to support the full footprint of the printer.
- Any cart used to move the hardware options must have a surface able to support the dimensions of the hardware options.
- Keep the printer in an upright position.
- Avoid severe jarring movements.

Shipping the printer

When shipping the printer, use the original packaging.

Managing the printer

Managing printer messages

Use the Status Messenger application to view error messages requiring your intervention on your printer. When there is an error, a bubble appears telling you what the error is, and points you to the appropriate recovery information.

If you installed Status Messenger with your printer software, then the application launches automatically when the software installation is completed. The installation is successful if you see the Status Messenger icon in the system tray.

Notes:

- This feature is available only in Windows XP or later.
- Make sure bidirectional communication support is in place so the printer and computer can communicate.

Disabling Status Messenger

- 1 From the system tray, right click the Status Messenger icon.
- 2 Select **Exit**.

Enabling Status Messenger

- 1 Click  or **Start**.
- 2 Click **All Programs** or **Programs**, and then select the printer program folder from the list.
- 3 Select your printer, and then click **Status Messenger**.

Accessing Status Monitor Center

Use the Status Monitor Center application to view the status of any USB- or network-connected printer and order supplies online.

Note: Make sure bidirectional communication support is in place so the printer and computer can communicate.

- 1 Click  or **Start**.
- 2 Click **All Programs** or **Programs**, and then select the printer program folder from the list.
- 3 Click **Status Monitor Center**.

Note: To order supplies online, click the **Supplies Ordering Utility** link.

Checking the virtual display

- 1 Open a Web browser, and then type the printer IP address in the address field.

Notes:

- Print a network setup page or menu settings page, and then locate the IP address in the TCP/IP section. The IP address appears as four sets of numbers separated by periods, such as 123.123.123.123.

- If you are using a proxy server, then temporarily disable it to load the Web page correctly.

2 Press **Enter** to open the Web page of your printer.

3 Click **Applications > Remote Operator Panel > Launch VNC Applet**.

Note: VNC Applet requires a Java plug-in to launch.

4 Click **Click here to continue**.

The virtual display works as an actual display would work on a printer control panel.

Viewing reports

You can view some reports from the Embedded Web Server. These reports are useful for assessing the status of the printer, network, and supplies.

1 Open a Web browser, and then type the printer IP address in the address field.

Notes:

- View the printer IP address in the TCP/IP section in the Network/Ports menu. The IP address appears as four sets of numbers separated by periods, such as 123.123.123.123.
- If you are using a proxy server, then temporarily disable it to load the Web page correctly.

2 Click **Reports**, and then click the type of report you want to view.

Configuring supply notifications from the Embedded Web Server

You can determine how you would like to be notified when supplies run nearly low, low, very low, or reach their end-of-life by setting the selectable alerts.

Notes:

- Selectable alerts can be set on the toner cartridge, imaging unit, and maintenance kit.
- All selectable alerts can be set for nearly low, low, and very low supply conditions. Not all selectable alerts can be set for the end-of-life supply condition. E-mail selectable alert is available for all supply conditions.
- The percentage of estimated remaining supply that prompts the alert can be set on some supplies for some supply conditions.

1 Open a Web browser, and then type the printer IP address in the address field.

Notes:

- View the printer IP address in the TCP/IP section in the Network/Ports menu. The IP address appears as four sets of numbers separated by periods, such as 123.123.123.123.
- If you are using a proxy server, then temporarily disable it to load the Web page correctly.

2 Click **Settings > Print Settings > Supply Notifications**.

3 From the drop-down menu for each supply, select one of the following notification options:

Notification	Description
Off	The normal printer behavior for all supplies occurs.
E-mail Only	The printer generates an e-mail when the supply condition is reached. The status of the supply will appear on the menus page and status page.
Warning	The printer displays the warning message and generates an email about the status of the supply. The printer does not stop when the supply condition is reached.
Continuable Stop ¹	The printer stops processing jobs when the supply condition is reached, and the user needs to press a button to continue printing.
Non Continuable Stop ^{1,2}	The printer stops when the supply condition is reached. The supply must be replaced to continue printing.
¹ The printer generates an e-mail about the status of the supply when supply notification is enabled. ² The printer stops when some supplies become empty to prevent damage.	

4 Click **Submit**.

Modifying confidential print settings

Note: This feature is available only in network printers or printers connected to print servers.

1 Open a Web browser, and then type the printer IP address in the address field.

Notes:

- View the printer IP address in the TCP/IP section in the Network/Ports menu. The IP address appears as four sets of numbers separated by periods, such as 123.123.123.123.
- If you are using a proxy server, then temporarily disable it to load the Web page correctly.

2 Click **Configuration > Other Settings** tab > **Security > Confidential Print Setup**.

3 Modify the settings:

- Set a maximum number of PIN entry attempts. When a user exceeds a specific number of PIN entry attempts, all of the jobs for that user are deleted.
- Set an expiration time for confidential print jobs. When a user has not printed the jobs within the specified time, all of the jobs for that user are deleted.

4 Save the modified settings.

Copying printer settings to other printers

Note: This feature is available only in network printers.

1 Open a Web browser, and then type the printer IP address in the address field.

Notes:

- View the printer IP address in the TCP/IP section in the Network/Ports menu. The IP address appears as four sets of numbers separated by periods, such as 123.123.123.123.
- If you are using a proxy server, then temporarily disable it to load the Web page correctly.

2 Click the **Copy Printer Settings**.

- 3 To change the language, select a language from the drop-down menu, and then click **Click here to submit language**.
- 4 Click **Printer Settings**.
- 5 Type the IP addresses of the source and target printers in their appropriate fields.
Note: If you want to add or remove a target printer, then click **Add Target IP** or **Remove Target IP**.
- 6 Click **Copy Printer Settings**.

Restoring factory default settings

If you want to keep a list of the current menu settings for reference, then print a menu settings page before restoring the factory default settings. For more information, see “Printing a menu settings page” on page 26.

If you want a more comprehensive method of restoring the printer factory default settings, then perform the Wipe All Settings option. For more information, see “Erasing non-volatile memory” on page 92.

Warning—Potential Damage: Restoring factory defaults returns most printer settings to the original factory default settings. Exceptions include the display language, custom sizes and messages, and network/port menu settings. All downloads stored in the RAM are deleted. Downloads stored in the flash memory or in the printer hard disk are not affected.

From the printer control panel, navigate to:

 > Settings >  > Settings >  > General Settings >  > Factory Defaults >  > Restore Now > 

Clearing jams

Carefully select paper and specialty media and load it properly to avoid most jams. If jams do occur, then follow the steps outlined in this chapter.

Note: Jam recovery is set to Auto by default. The printer reprints jammed pages unless the memory required to hold the pages is needed for other printer tasks.

Avoiding jams

Load paper properly

- Make sure paper lies flat in the tray.

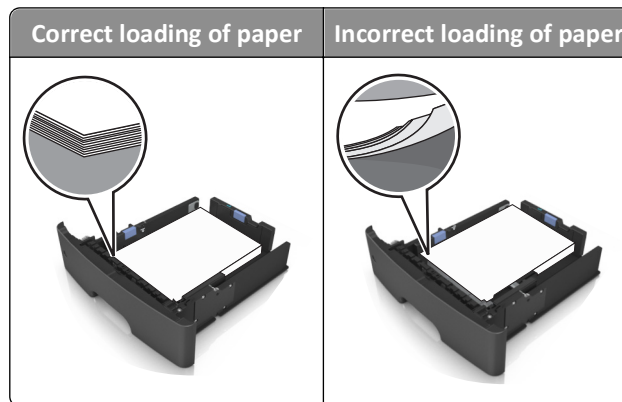

- Do not remove a tray while the printer is printing.
- Do not load a tray while the printer is printing. Load it before printing, or wait for a prompt to load it.
- Do not load too much paper. Make sure the stack height is below the maximum paper fill indicator.
- Do not slide the paper into the tray. Load paper as shown in the illustration.

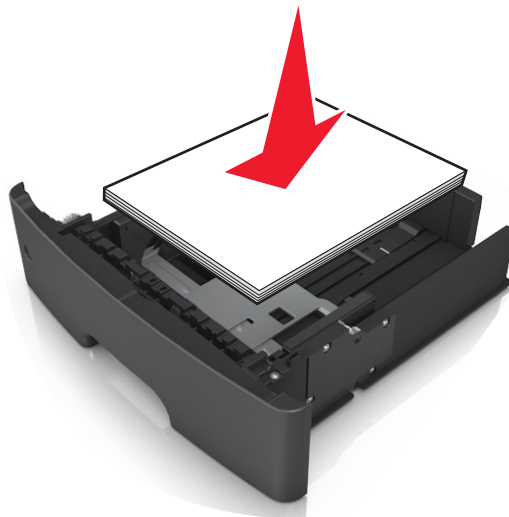

- Make sure the guides in the tray or the multipurpose feeder are properly positioned and are not pressing tightly against the paper or envelopes.
- Push the tray firmly into the printer after loading paper.

Use recommended paper

- Use only recommended paper or specialty media.
- Do not load wrinkled, creased, damp, bent, or curled paper.
- Flex, fan, and straighten paper before loading it.

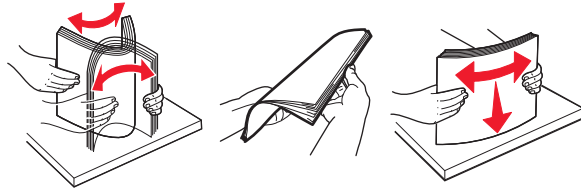

- Do not use paper that has been cut or trimmed by hand.
- Do not mix paper sizes, weights, or types in the same tray.
- Make sure the paper size and type are set correctly on the computer or printer control panel.
- Store paper according to manufacturer recommendations.

Understanding jam messages and locations

When a jam occurs, a message indicating the jam location and information to clear the jam appears on the printer display. Open the doors, covers, and trays indicated on the display to remove the jam.

Notes:

- When Jam Assist is set to On, the printer automatically flushes blank pages or pages with partial prints to the standard bin after a jammed page has been cleared. Check your printed output stack for discarded pages.
- When Jam Recovery is set to On or Auto, the printer reprints jammed pages. However, the Auto setting does not guarantee that the page will print.



	Area	Printer control panel message	What to do
1	Standard bin	[x]-page jam, clear standard bin. [20y.xx]	Remove the jammed paper.
2	Rear door	[x]-page jam, open rear door. [20y.xx]	Open the rear door, and then remove the jammed paper.
3	Tray 1	[x]-page jam, remove tray 1 to clear duplex. [23y.xx]	Pull tray 1 completely out, then push the front duplex flap down, and then remove the jammed paper. Note: You may need to open the rear door to clear some 23y.xx paper jams.
4	Tray [x]	[x]-page jam, remove tray [x]. [24y.xx]	Pull the indicated tray out, and then remove the jammed paper.
5	Multipurpose feeder	[x]-page jam, clear manual feeder. [250.xx]	Remove all paper from the multipurpose feeder, and then remove the jammed paper.
6	Front door	[x]-page jam, open front door. [20y.xx]	Open the front door, then remove the toner cartridge, imaging unit, and jammed paper.

[x]-page jam, open front door. [20y.xx]

 **CAUTION—HOT SURFACE:** The inside of the printer might be hot. To reduce the risk of injury from a hot component, allow the surface to cool before touching it.

- 1 Press the button on the right side of the printer, and then open the front door.

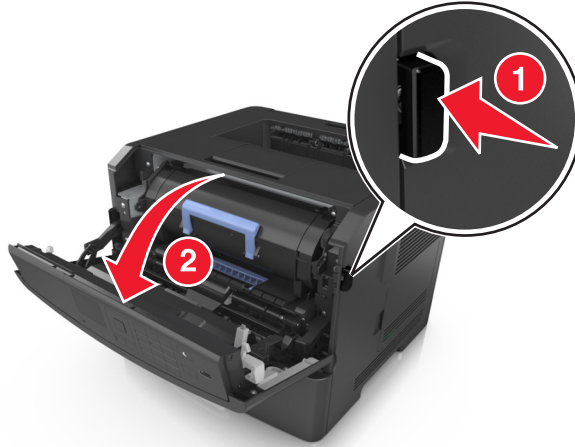

- 2 Pull the toner cartridge out using the handle.



- 3 Lift the blue handle, and then pull the imaging unit out of the printer.



Warning—Potential Damage: Do not touch the shiny blue photoconductor drum under the imaging unit. Doing so may affect the quality of future print jobs.

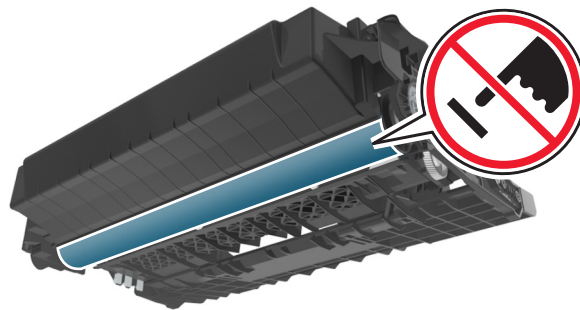

- 4 Lift the blue flap in front of the printer.

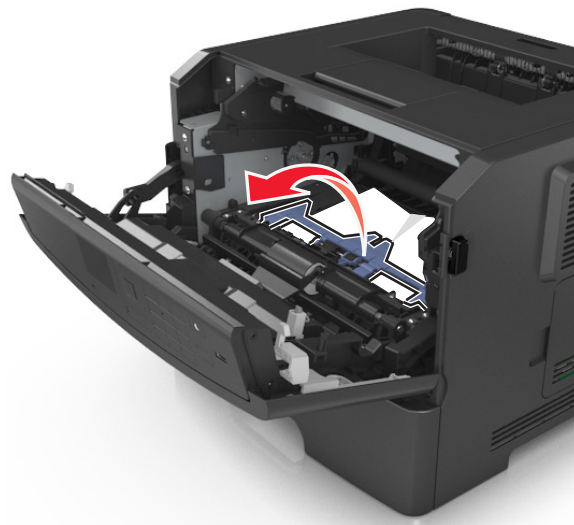

- 5 Place the imaging unit aside on a flat, smooth surface.

Warning—Potential Damage: Do not expose the imaging unit to direct light for more than 10 minutes. Extended exposure to light may cause print quality problems.

- 6 Firmly grasp the jammed paper on each side, and then gently pull it out.

Note: Make sure all paper fragments are removed.

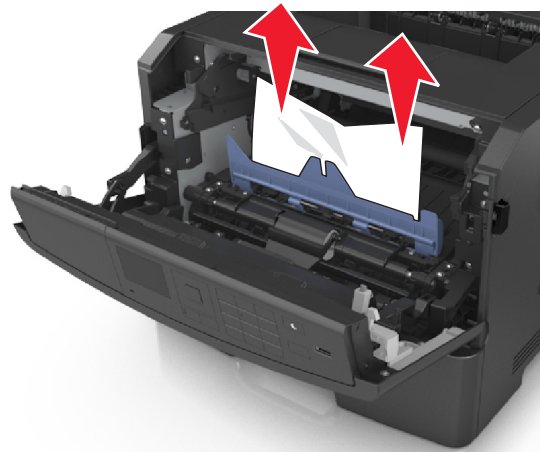

- 7 Insert the imaging unit by aligning the arrows on the side rails of the unit with the arrows on the side rails inside the printer, and then insert the imaging unit into the printer.

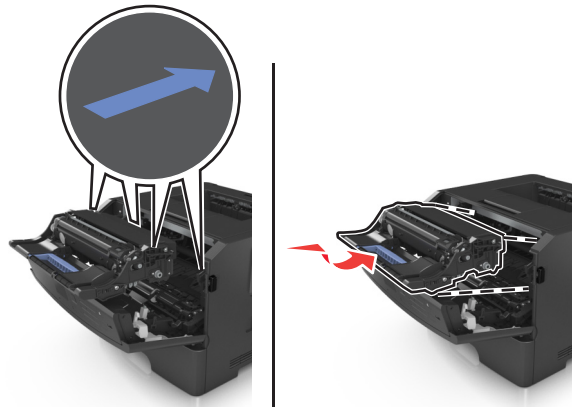

- 8 Insert the toner cartridge by aligning the side rails of the cartridge with the arrows on the side rails inside the printer, and then insert the cartridge into the printer.

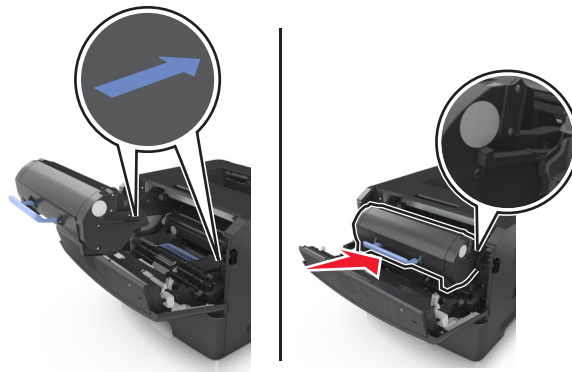

- 9 Close the front door.
- 10 From the printer control panel, select **Next** > **OK** > **Clear the jam, press OK** > **OK** to clear the message and continue printing.

[x]-page jam, open rear door. [20y.xx]

- 1 Open the front door.

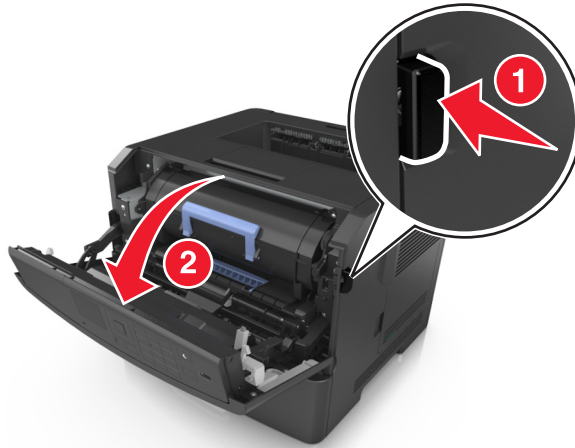

- 2 Gently pull down the rear door.

 **CAUTION—HOT SURFACE:** The inside of the printer might be hot. To reduce the risk of injury from a hot component, allow the surface to cool before touching it.



- 3 Firmly grasp the jammed paper on each side, and then gently pull it out.

Note: Make sure all paper fragments are removed.

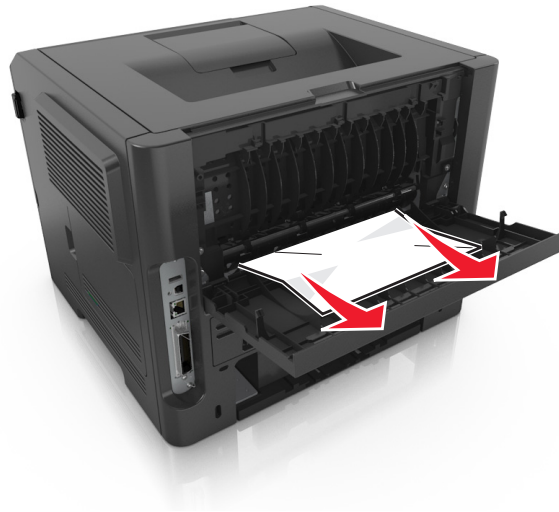

4 Close the rear door.

5 From the printer control panel, select **Next** > **OK** > **Clear the jam, press OK** > **OK** to clear the message and continue printing.

[x]-page jam, clear standard bin. [20y.xx]

1 Firmly grasp the jammed paper on each side, and then gently pull it out.

Note: Make sure all paper fragments are removed.



2 From the printer control panel, select **Next** > **OK** > **Clear the jam, press OK** > **OK** to clear the message and continue printing.

[x]-page jam, remove tray 1 to clear duplex. [23y.xx]

 **CAUTION—HOT SURFACE:** The inside of the printer might be hot. To reduce the risk of injury from a hot component, allow the surface to cool before touching it.

- 1 Pull the tray completely out of the printer.



- 2 Locate the blue lever, and then pull it down to release the jam.

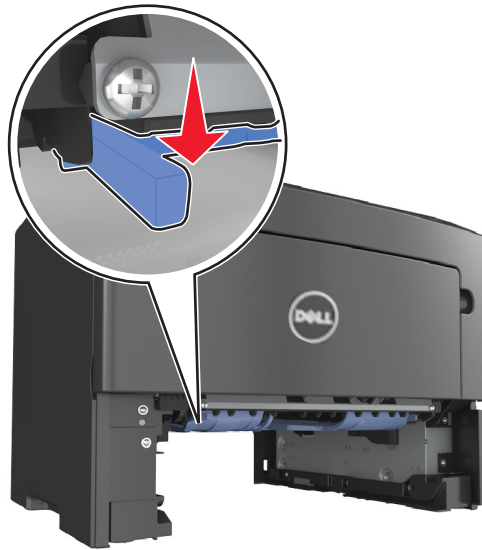

- 3 Firmly grasp the jammed paper on each side, and then gently pull it out.

Note: Make sure all paper fragments are removed.



4 Insert the tray.

5 From the printer control panel, select **Next** > **OK** > **Clear the jam, press OK** > **OK** to clear the message and continue printing.

[x]-page jam, open tray [x]. [24y.xx]

1 Pull the tray completely out of the printer.

Note: The message on the printer display indicates the tray where the jammed paper is located.



2 Firmly grasp the jammed paper on each side, and then gently pull it out.

Note: Make sure all paper fragments are removed.

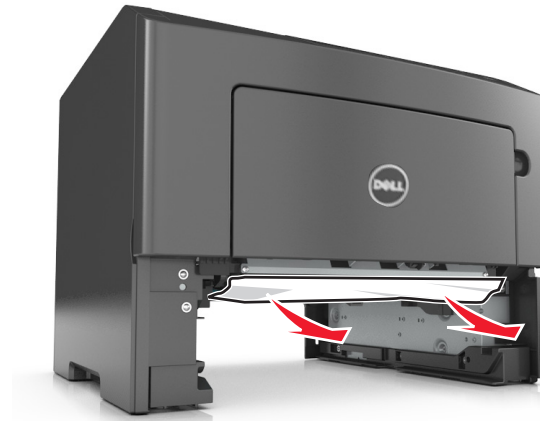

3 Insert the tray.

4 From the printer control panel, select **Next** > **OK** > **Clear the jam, press OK** > **OK** to clear the message and continue printing.

[x]-page jam, clear manual feeder. [25y.xx]

1 From the multipurpose feeder, firmly grasp the jammed paper on each side, and then gently pull it out.

Note: Make sure all paper fragments are removed.



2 Flex the sheets of paper back and forth to loosen them, and then fan them. Do not fold or crease the paper. Straighten the edges on a level surface.

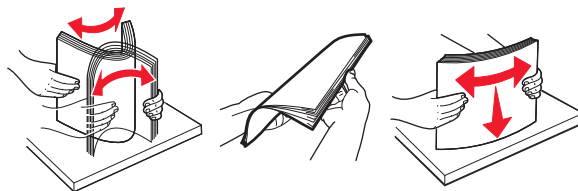

- 3 Reload paper into the multipurpose feeder.



Note: Make sure the paper guide lightly rests against the edge of the paper.

- 4 From the printer control panel, select **Next** > **OK** > **Clear the jam, press OK** > **OK** to clear the message and continue printing.

Troubleshooting

Understanding the printer messages

Cartridge, imaging unit mismatch [41.xy]

- 1 Check if the toner cartridge and imaging unit are both *MICR* (Magnetic Imaging Content Recording) or non-MICR supplies.

Note: For a list of supported supplies, contact the place where you purchased the printer.

- 2 Change the toner cartridge or imaging unit so that both are MICR or non-MICR supplies.

Notes:

- Use MICR toner cartridge and imaging unit for printing checks and other similar documents.
- Use non-MICR toner cartridge and imaging unit for regular print jobs.

Cartridge low [88.xy]

You may need to order a toner cartridge. Press  to clear the message and continue printing.

Cartridge nearly low [88.xy]

If necessary, press  on the printer control panel to clear the message and continue printing.

Cartridge very low, [x] estimated pages remain [88.xy]

You may need to replace the toner cartridge very soon. For more information, see the “Replacing supplies” section of the *User’s Guide*.

If necessary, press  to clear the message and continue printing.

Change [paper source] to [custom type name] load [orientation]

Try one or more of the following:

- Load the correct size and type of paper in the tray, and then press  on the printer control panel.

Note: Make sure the paper size and type settings are specified in the Paper menu on the printer control panel.

- Cancel the print job.

Change [paper source] to [custom string] load [orientation]

Try one or more of the following:

- Load the correct size and type of paper in the tray, and then press **OK** on the printer control panel.
Note: Make sure the paper size and type settings are specified in the Paper menu on the printer control panel.
- Cancel the print job.

Change [paper source] to [paper size] load [orientation]

Try one or more of the following:

- Load the correct size and type of paper in the tray, and then press **OK** on the printer control panel.
Note: Make sure the paper size and type settings are specified in the Paper menu on the printer control panel.
- Cancel the print job.

Change [paper source] to [paper type] [paper size] load [orientation]

Try one or more of the following:

- Load the correct size and type of paper in the tray, and then press **OK** on the printer control panel.
Note: Make sure the paper size and type settings are specified in the Paper menu on the printer control panel.
- Cancel the print job.

Close front door

Close the front door of the printer.

Complex page, some data may not have printed [39]

Try one or more of the following:

- From the printer control panel, press **OK** to clear the message and continue printing.
- Reduce the number and size of fonts, the number and complexity of images, and the number of pages in the print job.
- Cancel the print job.
- Install additional printer memory.

Defective flash detected [51]

Try one or more of the following:

- Replace the defective flash memory card.
- From the printer control panel, press **OK** to ignore the message and continue printing.
- Cancel the current print job.

Error reading USB drive. Remove USB.

An unsupported USB device is inserted. Remove the USB device, and then insert a supported one.

Error reading USB hub. Remove hub.

An unsupported USB hub has been inserted. Remove the USB hub, and then install a supported one.

Imaging unit low [84.xy]

You may need to order an imaging unit. If necessary, press **OK** to clear the message and continue printing.

Imaging unit nearly low [84.xy]

If necessary, press **OK** on the printer control panel to clear the message and continue printing.

Imaging unit very low, [x] estimated pages remain [84.xy]

You may need to replace the imaging unit very soon. For more information, see the "Replacing supplies" section of the *User's Guide*.

If necessary, press **OK** to clear the message and continue printing.

Incorrect paper size, open [paper source] [34]

Try one or more of the following:

- Load the correct size of paper in the tray.
- From the printer control panel, press **OK** to clear the message and print using a different tray.
- Check the tray length and width guides and make sure the paper is loaded properly in the tray.
- Make sure the correct paper size and type are specified in Print Properties or in the Print dialog.
- Make sure the paper size and type settings are specified in the Paper menu on the printer control panel.
- Make sure the paper size is correctly set. For example, if the MP Feeder Size is set to Universal, then make sure the paper is large enough for the data being printed.
- Cancel the print job.

Insert Tray [x]

Insert the indicated tray into the printer.

Insufficient memory to support Resource Save feature [35]

Try one or more of the following:

- From the printer control panel, press  to disable Resource Save, clear the message, and continue printing.
- Install additional printer memory.









Insufficient memory to collate job [37]

Try one or more of the following:

- From the printer control panel, press  to print the portion of the job already stored and begin collating the rest of the print job.
- Cancel the current print job.

Insufficient memory for Flash Memory Defragment operation [37]

Try one or more of the following:

- From the printer control panel, press  to stop the defragmentation and continue printing.
- Delete fonts, macros, and other data in the printer memory. From the printer control panel, navigate to:
 > Settings >  > Settings >  > Print Settings >  > Utilities Menu >  > Format Flash >  > Yes > 
- Install additional printer memory.

Insufficient memory, some Held Jobs were deleted [37]

From the printer control panel, press  to clear the message.

Insufficient memory, some held jobs will not be restored [37]

Do either of the following:

- From the printer control panel, press  to clear the message.
- Delete other held jobs to free up additional printer memory.

Load [paper source] with [custom string] [orientation]

Try one or more of the following:

- Load the indicated tray or feeder with the correct size and type of paper.
- From the printer control panel, press  to clear the message and continue printing.

Note: If the printer finds a tray that has the correct paper type and size, then it feeds from that tray. If the printer cannot find a tray that has the correct size and type of paper, then it prints from the default paper source.

- Cancel the current job.

Load [paper source] with [custom type name] [orientation]

Try one or more of the following:

- Load the tray or feeder with the correct size and type of paper.
- From the printer control panel, press  to clear the message and continue printing.

Note: If the printer finds a tray that has the correct size and type of paper, then it feeds from that tray. If the printer cannot find a tray that has the correct size and type of paper, then it prints from the default paper source.

- Cancel the current job.

Load [paper source] with [paper size] [orientation]

Try one or more of the following:

- Load the tray or feeder with the correct size of paper.
- From the printer control panel, press  to clear the message and continue printing.

Note: If the printer finds a tray that has the correct paper size, then it feeds from that tray. If the printer cannot find a tray that has the correct size of paper, then it prints from the default paper source.

- Cancel the current job.

Load [paper source] with [paper type] [paper size] [orientation]

Try one or more of the following:

- Load the tray or feeder with the correct size and type of paper.
- From the printer control panel, press  to clear the message and continue printing.

Note: If the printer finds a tray that has the correct size and type of paper, then it feeds from that tray. If the printer cannot find a tray that has the correct size and type of paper, then it prints from the default paper source.

- Cancel the current job.

Load Manual Feeder with [custom type name] [orientation]

Try one or more of the following:

- Load the feeder with the correct size and type of paper.
- From the printer control panel, press  to clear the message and continue printing.

Note: If no paper is loaded in the feeder, then the printer manually overrides the request, and then prints from an automatically selected tray.

- Cancel the current job.

Load Manual Feeder with [custom string] [orientation]

Try one or more of the following:

- Load the feeder with the correct size and type of paper.
- From the printer control panel, press **OK** to clear the message and continue printing.

Note: If no paper is loaded in the feeder, then the printer manually overrides the request, and then prints from an automatically selected tray.

- Cancel the current job.

Load Manual Feeder with [paper size] [orientation]

Try one or more of the following:

- Load the feeder with the correct size of paper.
- From the printer control panel, press **OK** to clear the message and continue printing.

Note: If no paper is loaded in the feeder, then the printer manually overrides the request, and then prints from an automatically selected tray.

- Cancel the current job.

Load Manual Feeder with [paper type] [paper size] [orientation]

Try one or more of the following:

- Load the feeder with the correct size and type of paper.
- From the printer control panel, press **OK** to clear the message and continue printing.

Note: If no paper is loaded in the feeder, then the printer manually overrides the request, and then prints from an automatically selected tray.

- Cancel the current job.

Maintenance kit low [80.xy]

You may need to order a maintenance kit. Contact technical support or your Dell printer dealer, and then report the message. If necessary, press **OK** on the printer control panel to clear the message and continue printing.

Maintenance kit nearly low [80.xy]

For more information, contact technical support or your Dell printer dealer, and then report the message. If necessary, press **OK** on the printer control panel to clear the message and continue printing.

Maintenance kit very low, [x] estimated pages remain [80.xy]

You may need to replace the maintenance kit very soon. For more information, contact technical support or your Dell printer dealer.

If necessary, press  on the printer control panel to clear the message and continue printing.

Memory full [38]

Try one or more of the following:

- From the printer control panel, press  to clear the message.
- Decrease the resolution setting.
- Install additional printer memory.

Network [x] software error [54]

Try one or more of the following:

- From the printer control panel, press  to clear the message and continue printing.
- Unplug the router, then wait for 30 seconds, and then plug it back again.
- Turn off the printer, wait for about 10 seconds, and then turn the printer back on.
- Update the network firmware in the printer or the print server. For more information, contact your system support person.

Non-Dell [supply type], see *User's Guide* [33.xy]



Note: The supply type can be toner cartridge or imaging unit.

The printer has detected a non-Dell supply or part installed in the printer.

Your Dell printer is designed to function best with genuine Dell supplies and parts. Use of third-party supplies or parts may affect the performance, reliability, or life of the printer and its imaging components.

All life indicators are designed to function with Dell supplies and parts and may deliver unpredictable results if third-party supplies or parts are used. Imaging component usage beyond the intended life may damage your Dell printer or associated components.

Warning—Potential Damage: Use of third-party supplies or parts can affect warranty coverage. Damage caused by the use of third-party supplies or parts may not be covered by the warranty.

To accept any and all of these risks and to proceed with the use of non-genuine supplies or parts in your printer, press  and  simultaneously for 15 seconds to clear the message and continue printing.

If you do not wish to accept these risks, then remove the third-party supply or part from your printer, and then install a genuine Dell supply or part.

Note: For the list of supported supplies, see the “Ordering supplies” section of the *User's Guide* or visit <http://support.dell.com>.

Not enough free space in flash memory for resources [52]

Try one or more of the following:

- From the printer control panel, press **OK** to clear the message and continue printing.
- Delete fonts, macros, and other data stored in the flash memory.

From the printer control panel, navigate to:

Home > **Settings** > **OK** > **Settings** > **OK** > **Print Settings** > **OK** > **Utilities Menu** > **OK** > **Format Flash** > **OK** > **Yes** > **OK**

- Use a larger-capacity flash memory card.

Note: Downloaded fonts and macros that are not stored in the flash memory are deleted when the printer is turned off or restarted.

PPDS font error [50]

Try one or more of the following:

- From the printer control panel, press **OK** to clear the message and continue printing.
- If the printer cannot find the requested font, then navigate to:

Home > **Settings** > **OK** > **Settings** > **Print Settings** > **OK** > **PPDS menu** > **OK** > **Best Fit** > **OK** > **On** > **OK**

The printer finds a similar font and reformats the affected text.

- Cancel the current print job.

Reinstall missing or unresponsive cartridge [31.xy]

Try one or more of the following:

- Check if the toner cartridge is missing. If missing, install the toner cartridge.
For information on installing the cartridge, see the “Replacing supplies” section of the *User’s Guide*.
- If the toner cartridge is installed, then remove the unresponsive toner cartridge, and then reinstall it.

Note: If the message appears after reinstalling the supply, then the cartridge is defective. Replace the toner cartridge.

Reinstall missing or unresponsive imaging unit [31.xy]

Try one or more of the following:

- Check if the imaging unit is missing. If missing, install the imaging unit.
For information on installing the imaging unit, see the “Replacing supplies” section of the *User’s Guide*.
- If the imaging unit is installed, then remove the unresponsive imaging unit, and then reinstall it.

Note: If the message appears after reinstalling the supply, then the imaging unit is defective. Replace the imaging unit.

Remove paper from standard output bin

Remove the paper stack from the standard bin.

Replace cartridge, 0 estimated pages remain [88.xy]

Replace the toner cartridge to clear the message and continue printing. For more information, see the instruction sheet that came with the supply or see the “Replacing supplies” section of the *User’s Guide*.

Note: If you do not have a replacement cartridge, then see the “Ordering supplies” section of the *User’s Guide* or visit our Web site.

Replace imaging unit, 0 estimated pages remain [84.xy]

Replace the imaging unit to clear the message and continue printing. For more information, see the instruction sheet that came with the supply or see the “Replacing supplies” section of the *User’s Guide*.

Note: If you do not have a replacement imaging unit, then see the “Ordering supplies” section of the *User’s Guide* or visit our Web site.

Replace maintenance kit, 0 estimated pages remain [80.xy]

Contact technical support or your Dell printer dealer, and then report the message. The printer is scheduled for maintenance.

Replace unsupported cartridge [32.xy]

Remove the toner cartridge, and then install a supported one to clear the message and continue printing. For more information, see the instruction sheet that came with the supply or see the “Replacing supplies” section of the *User’s Guide*.

Note: If you do not have a replacement cartridge, then see the “Ordering supplies” section of the *User’s Guide* or visit our Web site.

Replace unsupported imaging unit [32.xy]

Remove the imaging unit, and then install a supported one to clear the message and continue printing. For more information, see the instruction sheet that came with the supply or see the “Replacing supplies” section of the *User’s Guide*.

Note: If you do not have a replacement imaging unit, then see the “Ordering supplies” section of the *User’s Guide* or visit our Web site.

SMTP server not set up. Contact system administrator.

From the printer control panel, press  to clear the message.

Note: If the message appears again, then contact your system support person.

Standard network software error [54]

Try one or more of the following:

- From the printer control panel, press **OK** to confirm.
- Unplug the router, then wait for 30 seconds, and then plug it back again.
- Turn off the printer, and then turn it back on.
- Update the network firmware in the printer or print server. For more information, contact your system support person.

Standard parallel port disabled [56]

- From the printer control panel, select **Continue** to clear the message. For non-touch-screen printer models, press **OK** to confirm.

Notes:

- The printer discards any data received through the parallel port.
- Make sure the Parallel Buffer menu is not set to Disabled.

Standard USB port disabled [56]

Try one or more of the following:

- From the printer control panel, press **OK** to clear the message and continue printing.
Note: The printer discards any data received through the USB port.
- From the printer control panel, set USB Buffer to Auto.

Too many flash options installed [58]

- 1 Turn off the printer.
- 2 Unplug the power cord from the electrical outlet.
- 3 Remove the extra flash memory.
- 4 Connect the power cord to a properly grounded electrical outlet.
- 5 Turn the printer back on.

Too many trays attached [58]

- 1 Turn off the printer.
- 2 Unplug the power cord from the electrical outlet.
- 3 Remove the extra trays.
- 4 Connect the power cord to a properly grounded electrical outlet.
- 5 Turn the printer back on.

Unformatted flash detected [53]

Try one or more of the following:

- From the printer control panel, press **OK** to stop the defragmentation and continue printing.
- Format the flash memory device.

Note: If the error message remains, then the flash memory device may be defective and need to be replaced.

Unsupported option in slot [x] [55]

- 1 Turn off the printer.
- 2 Unplug the power cord from the electrical outlet.
- 3 Remove the unsupported option card from the printer controller board, and then replace it with a supported card.
- 4 Connect the power cord to a properly grounded electrical outlet.
- 5 Turn the printer back on.

Solving printer problems

- “Basic printer problems” on page 127
- “Option problems” on page 129
- “Paper feed problems” on page 131

Basic printer problems

The printer is not responding

Action	Yes	No
<p>Step 1 Make sure the printer is turned on.</p> <p>Is the printer turned on?</p>	Go to step 2.	Turn on the printer.
<p>Step 2 Check if the printer is in Sleep mode or Hibernate mode.</p> <p>Is the printer in Sleep mode or Hibernate mode?</p>	Press the Sleep button to wake the printer from Sleep mode or Hibernate mode.	Go to step 3.
<p>Step 3 Check if one end of the power cord is plugged into the printer and the other to a properly grounded electrical outlet.</p> <p>Is the power cord plugged into the printer and a properly grounded electrical outlet?</p>	Go to step 4.	Plug one end of the power cord into the printer and the other to a properly grounded electrical outlet.

Action	Yes	No
<p>Step 4 Check other electrical equipment plugged into the electrical outlet.</p> <p>Does other electrical equipment work?</p>	Unplug the other electrical equipment, and then turn on the printer. If the printer does not work, then reconnect the other electrical equipment.	Go to step 5.
<p>Step 5 Check if the cables connecting the printer and the computer are inserted in the correct ports.</p> <p>Are the cables inserted in the correct ports?</p>	Go to step 6.	<p>Make sure to match the following:</p> <ul style="list-style-type: none"> • The USB symbol on the cable with the USB symbol on the printer • The appropriate Ethernet cable with the Ethernet port
<p>Step 6 Make sure the electrical outlet is not turned off by a switch or breaker.</p> <p>Is the electrical outlet turned off by a switch or breaker?</p>	Turn on the switch or reset the breaker.	Go to step 7.
<p>Step 7 Check if the printer is plugged into any surge protectors, uninterruptible power supplies, or extension cords.</p> <p>Is the printer plugged into any surge protectors, uninterruptible power supplies, or extension cords?</p>	Connect the printer power cord directly to a properly grounded electrical outlet.	Go to step 8.
<p>Step 8 Check if one end of the printer cable is plugged into a port on the printer and the other to the computer, print server, option, or other network device.</p> <p>Is the printer cable securely attached to the printer and the computer, print server, option, or other network device?</p>	Go to step 9.	Connect the printer cable securely to the printer and the computer, print server, option, or other network device.
<p>Step 9 Make sure to install all hardware options properly and remove any packing material.</p> <p>Are all hardware options properly installed and all packing material removed?</p>	Go to step 10.	Turn off the printer, remove all packing materials, then reinstall the hardware options, and then turn on the printer.
<p>Step 10 Check if you have selected the correct port settings in the printer driver.</p> <p>Are the port settings correct?</p>	Go to step 11.	Use correct printer driver settings.

Action	Yes	No
<p>Step 11 Check the installed printer driver.</p> <p>Is the correct printer driver installed?</p>	Go to step 12.	Install the correct printer driver.
<p>Step 12 Turn off the printer, then wait for about 10 seconds, and then turn the printer back on.</p> <p>Is the printer working?</p>	The problem is solved.	Contact technical support .

Printer display is blank

Action	Yes	No
<p>Step 1 Press the Sleep button on the printer control panel.</p> <p>Does Ready appear on the printer display?</p>	The problem is solved.	Go to step 2.
<p>Step 2 Turn off the printer, then wait for about 10 seconds, and then turn the printer back on.</p> <p>Do Please wait and Ready appear on the printer display?</p>	The problem is solved.	Turn off the printer, and then contact technical support .

Option problems

Cannot detect internal option

Action	Yes	No
<p>Step 1 Turn off the printer, then wait for about 10 seconds, and then turn on the printer.</p> <p>Does the internal option operate correctly?</p>	The problem is solved.	Go to step 2.
<p>Step 2 Check if the internal option is properly installed in the controller board.</p> <ul style="list-style-type: none"> a Turn off the printer using the power switch, and then unplug the power cord from the electrical outlet. b Make sure the internal option is installed in the appropriate connector in the controller board. c Connect the power cord to the printer, then to a properly grounded electrical outlet, and then turn on the printer. <p>Is the internal option properly installed in the controller board?</p>	Go to step 3.	Connect the internal option to the controller board.

Action	Yes	No
<p>Step 3 Print a menu settings page, and then check to see if the internal option is listed in the Installed Features list.</p> <p>Is the internal option listed in the menu settings page?</p>	Go to step 4.	Reinstall the internal option.
<p>Step 4</p> <p>a Check if the internal option is selected. It may be necessary to manually add the internal option in the printer driver to make it available for print jobs. For more information, see “Updating available options in the printer driver” on page 21.</p> <p>b Resend the print job.</p> <p>Does the internal option operate correctly?</p>	The problem is solved.	Contact technical support .

Tray problems

Action	Yes	No
<p>Step 1</p> <p>a Open the tray and do one or more of the following:</p> <ul style="list-style-type: none"> • Check for paper jams or misfeeds. • Check if the paper size indicators on the paper guides are aligned with the paper size indicators on the tray. • If you are printing on custom-size paper, then make sure that the paper guides rest against the edges of the paper. • Make sure the paper is below the maximum paper fill indicator. • Make sure paper lies flat in the tray. <p>b Check if the tray closes properly.</p> <p>Is the tray working?</p>	The problem is solved.	Go to step 2.
<p>Step 2</p> <p>a Turn off the printer, then wait about 10 seconds, and then turn the printer back on.</p> <p>b Resend the print job.</p> <p>Is the tray working?</p>	The problem is solved.	Go to step 3.
<p>Step 3</p> <p>Check if the tray is installed and recognized by the printer. Print a menu settings page, and then check if the tray is listed in the Installed Features list.</p> <p>Is the tray listed in the menu settings page?</p>	Go to step 4.	Reinstall the tray. For more information, see the setup documentation that came with the tray.

Action	Yes	No
<p>Step 4 Check if the tray is available in the printer driver.</p> <p>Note: If necessary, manually add the tray in the printer driver to make it available for print jobs. For more information, see “Updating available options in the printer driver” on page 21.</p> <p>Is the tray available in the printer driver?</p>	Go to step 5.	Manually add the tray in the printer driver.
<p>Step 5 Check if the option is selected.</p> <p>a From the application you are using, select the option. For Mac OS X version 9 users, make sure the printer is set up in Chooser.</p> <p>b Resend the print job.</p> <p>Is the tray working?</p>	The problem is solved.	Contact technical support .

Paper feed problems

Paper frequently jams

Action	Yes	No
<p>Step 1</p> <p>a Pull out the tray, and then do one or more of the following:</p> <ul style="list-style-type: none"> • Make sure paper lies flat in the tray. • Check if the paper size indicators on the paper guides are aligned with the paper size indicators on the tray. • Check if the paper guides are aligned against the edges of the paper. • Make sure the paper is below the maximum paper fill indicator. • Check if you are printing on a recommended paper size and type. <p>b Insert the tray properly.</p> <p>If jam recovery is enabled, then the print jobs will reprint automatically.</p> <p>Do paper jams still occur frequently?</p>	Go to step 2.	The problem is solved.
<p>Step 2</p> <p>a Load paper from a fresh package.</p> <p>Note: Paper absorbs moisture due to high humidity. Store paper in its original wrapper until you use it.</p> <p>b Resend the print job.</p> <p>Do paper jams still occur frequently?</p>	Go to step 3.	The problem is solved.

Action	Yes	No
<p>Step 3</p> <p>a Review the tips on avoiding jams. For more information, see “Avoiding jams” on page 105.</p> <p>b Follow the recommendations, and then resend the print job.</p> <p>Do paper jams still occur frequently?</p>	<p>Contact technical support.</p>	<p>The problem is solved.</p>

Paper jam message remains after jam is cleared

Action	Yes	No
<p>Open front door and remove all trays.</p> <p>a Clear any jammed pages.</p> <p>Note: Make sure all paper fragments are removed.</p> <p>b Press OK to clear the message and continue printing.</p> <p>Does the paper jam message remain?</p>	<p>Contact technical support.</p>	<p>The problem is solved.</p>

Jammed pages are not reprinted

Action	Yes	No
<p>a Turn on jam recovery.</p> <p>1 From the printer control panel, navigate to:</p> <p>Settings > OK > General Settings > OK > Print Recovery > OK > Jam Recovery</p> <p>2 Press the left or right arrow button to scroll to On or Auto, and then press OK.</p> <p>b Resend the pages that did not print.</p> <p>Were the jammed pages reprinted?</p>	<p>The problem is solved.</p>	<p>Contact technical support.</p>

Solving print problems

Printing problems

Multiple-language PDF files do not print

Action	Yes	No
<p>Step 1</p> <p>a Check if the print options for the PDF output are set to embed all fonts.</p> <p>b Generate a new PDF file, and then resend the print job.</p> <p>Do the files print?</p>	The problem is solved.	Go to step 2.
<p>Step 2</p> <p>a Open the document you want to print in Adobe Acrobat.</p> <p>b Click File > Print > Advanced > Print As Image > OK > OK.</p> <p>Do the files print?</p>	The problem is solved.	Contact technical support .

Error message about reading the flash drive appears

Action	Yes	No
<p>Step 1</p> <p>Check if the flash drive is inserted into the front USB slot.</p> <p>Note: The flash drive will not work if it is inserted into the rear USB slot.</p> <p>Is the flash drive inserted into the front USB slot?</p>	Go to step 2.	Insert the flash drive into the front USB slot.
<p>Step 2</p> <p>Check if the printer is busy.</p> <p>Note: A green blinking light indicates that the printer is busy.</p> <p>Is there an error message on the display?</p>	Wait until the printer is ready, then view the held jobs list, and then print the documents.	Go to step 3.
<p>Step 3</p> <p>Check for an error message on the display.</p> <p>Note: A blinking red light indicates a printer error. Since the printer requires attention, the printer ignores the flash drive.</p> <p>Does the printer require attention?</p>	Clear the message.	Go to step 4.

Action	Yes	No
<p>Step 4 Check if the flash drive is supported. For more information regarding tested and approved USB flash memory devices, see “Supported flash drives and file types” on page 49.</p> <p>Is the flash drive supported?</p>	Go to step 5.	Use a supported flash drive.
<p>Step 5 Check if the USB slot is disabled by the system support person.</p> <p>Is the USB slot disabled?</p>	Contact your system support person.	Contact technical support .

Print jobs do not print

Action	Yes	No
<p>Step 1 a From the document you are trying to print, open the Print dialog and check if you have selected the correct printer. Note: If the printer is not the default printer, then you must select the printer for each document that you want to print. b Resend the print job.</p> <p>Do the jobs print?</p>	The problem is solved.	Go to step 2.
<p>Step 2 a Check if the printer is plugged in and turned on, and if Ready appears on the printer display. b Resend the print job.</p> <p>Do the jobs print?</p>	The problem is solved.	Go to step 3.
<p>Step 3 If an error message appears on the printer display, then clear the message. Note: The printer continues to print after clearing the message.</p> <p>Do the jobs print?</p>	The problem is solved.	Go to step 4.
<p>Step 4 a Check if the ports (USB, serial, or Ethernet) are working and if the cables are securely connected to the computer and the printer. Note: For more information, see the setup documentation that came with the printer. b Resend the print job.</p> <p>Do the jobs print?</p>	The problem is solved.	Go to step 5.

Action	Yes	No
<p>Step 5</p> <p>a Turn off the printer, then wait for about 10 seconds, and then turn the printer back on.</p> <p>b Resend the print job.</p> <p>Do the jobs print?</p>	The problem is solved.	Go to step 6.
<p>Step 6</p> <p>a Remove, and then reinstall the printer software. For more information, see “Installing the printer software” on page 20.</p> <p>Note: For more information, visit http://support.dell.com.</p> <p>b Resend the print job.</p> <p>Do the jobs print?</p>	The problem is solved.	Contact technical support .

Print job takes longer than expected

Action	Yes	No
<p>Step 1</p> <p>Change the environmental settings of the printer.</p> <p>a From the printer control panel, navigate to: Settings > General Settings</p> <p>b Select Eco-Mode or Quiet Mode, and then select Off.</p> <p>Note: Disabling Eco-Mode or Quiet Mode may increase the consumption of energy or supplies, or both.</p> <p>Did the job print?</p>	The problem is solved.	Go to step 2.
<p>Step 2</p> <p>Reduce the number and size of fonts, the number and complexity of images, and the number of pages in the print job, and then resend the job</p> <p>Did the job print?</p>	The problem is solved.	Go to step 3.
<p>Step 3</p> <p>a Remove held jobs stored in the printer memory.</p> <p>b Resend the print job.</p> <p>Did the job print?</p>	The problem is solved.	Go to step 4.
<p>Step 4</p> <p>a Disable the Page Protect feature.</p> <p>From the printer control panel, navigate to: Settings > General Settings > Print Recovery > Page Protect > Off</p> <p>b Resend the print job.</p> <p>Did the job print?</p>	The problem is solved.	Go to step 5.

Action	Yes	No
<p>Step 5 Install additional printer memory, and then resend the print job.</p> <p>Did the job print?</p>	The problem is solved.	Contact technical support .

Job prints from the wrong tray or on the wrong paper

Action	Yes	No
<p>Step 1 a Check if you are printing on paper that is supported by the tray. b Resend the print job.</p> <p>Did the job print from the correct tray or on the correct paper?</p>	The problem is solved.	Go to step 2.
<p>Step 2 a From the Paper menu on the printer control panel, set the paper size and type to match the paper loaded in the tray. b Resend the print job.</p> <p>Did the job print from the correct tray or on the correct paper?</p>	The problem is solved.	Go to step 3.
<p>Step 3 a Depending on your operating system, open Printing Preferences or the Print dialog, and then specify the paper type. b Resend the print job.</p> <p>Did the job print from the correct tray or on the correct paper?</p>	The problem is solved.	Go to step 4.
<p>Step 4 a Check if the trays are not linked. b Resend the print job.</p> <p>Did the job print from the correct tray or on the correct paper?</p>	The problem is solved.	Contact technical support .

Incorrect characters print

Action	Yes	No
<p>Step 1 Make sure the printer is not in Hex Trace mode.</p> <p>Note: If Ready Hex appears on the printer display, then turn off the printer, and then turn it back on to deactivate Hex Trace mode.</p> <p>Is the printer in Hex Trace mode?</p>	Deactivate Hex Trace mode.	Go to step 2.
<p>Step 2</p> <p>a From the printer control panel, select Standard Network or Network [x], and then set SmartSwitch to On.</p> <p>b Resend the print job.</p> <p>Do incorrect characters print?</p>	Contact technical support .	The problem is solved.

Tray linking does not work

Note: The trays and the multipurpose feeder do not automatically detect the paper size. You must set the size from the Paper Size/Type menu.

Action	Yes	No
<p>a From the printer control panel, set the paper size and type in the Paper menu to match the paper loaded in the trays to be linked.</p> <p>Note: The paper size and type must match for trays to be linked.</p> <p>b Resend the print job.</p> <p>Do the trays link correctly?</p>	The problem is solved.	Contact technical support .

Large jobs do not collate

Action	Yes	No
<p>Step 1</p> <p>a From the Finishing menu on the printer control panel, set Collate to (1,2,3) (1,2,3).</p> <p>b Resend the print job.</p> <p>Did the job print and collate correctly?</p>	The problem is solved.	Go to step 2.
<p>Step 2</p> <p>a From the printer software, set Collate to (1,2,3) (1,2,3).</p> <p>Note: Setting Collate to (1,1,1) (2,2,2) in the software overrides the setting in the Finishing menu.</p> <p>b Resend the print job.</p> <p>Did the job print and collate correctly?</p>	The problem is solved.	Go to step 3.

Action	Yes	No
<p>Step 3 Reduce the complexity of the print job by eliminating the number and size of fonts, the number and complexity of images, and the number of pages in the job.</p> <p>Did the job print and collate correctly?</p>	The problem is solved.	Contact technical support .

Unexpected page breaks occur

Action	Yes	No
<p>Step 1 Adjust the print timeout settings.</p> <ul style="list-style-type: none"> a From the printer control panel, navigate to: Settings > General Settings > Timeouts > Print Timeout b Select a higher setting, and then press OK. c Resend the print job. <p>Did the file print correctly?</p>	The problem is solved.	Go to step 2.
<p>Step 2 a Check the original file for manual page breaks. b Resend the print job.</p> <p>Did the file print correctly?</p>	The problem is solved.	Contact technical support .

Print quality problems

Characters have jagged or uneven edges

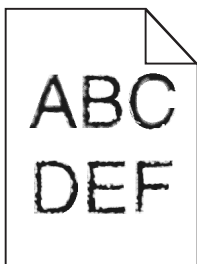

Action	Yes	No
<p>Step 1</p> <p>a Print a font sample list to check if the fonts you are using are supported by the printer.</p> <p>1 From the printer control panel, navigate to: Menus > Reports > Print Fonts</p> <p>2 Select PCL Fonts or PostScript Fonts.</p> <p>b Resend the print job.</p> <p>Are you using fonts that are supported by the printer?</p>	Go to step 2.	Select a font that is supported by the printer.
<p>Step 2</p> <p>Check if the fonts installed on the computer are supported by the printer.</p> <p>Are the fonts installed on the computer supported by the printer?</p>	The problem is solved.	Contact technical support .

Clipped pages or images

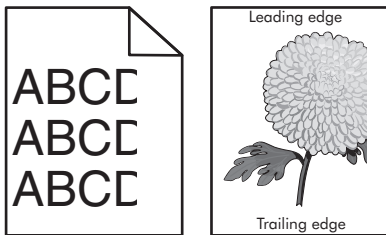

Action	Yes	No
<p>Step 1</p> <p>a Move the width and length guides in the tray to the correct positions for the paper loaded.</p> <p>b Resend the print job.</p> <p>Is the page or image clipped?</p>	Go to step 2.	The problem is solved.
<p>Step 2</p> <p>From the printer control panel, set the paper size and type in the Paper menu to match the paper loaded in the tray.</p> <p>Do the paper size and type match the paper loaded in the tray?</p>	Go to step 3.	<p>Do one or more of the following:</p> <ul style="list-style-type: none"> Specify the paper size from the tray settings to match the paper loaded in the tray. Change the paper loaded in the tray to match the paper size specified in the tray settings.

Action	Yes	No
<p>Step 3</p> <p>a Depending on your operating system, specify the paper size from Printing Preferences or from the Print dialog.</p> <p>b Resend the print job.</p> <p>Is the page or image clipped?</p>	Go to step 4.	The problem is solved.
<p>Step 4</p> <p>a Reinstall the imaging unit.</p> <ol style="list-style-type: none"> 1 Remove the toner cartridge. 2 Remove the imaging unit. <p>Warning—Potential Damage: Do not expose the imaging unit to direct light for more than 10 minutes. Extended exposure to light may cause print quality problems.</p> <ol style="list-style-type: none"> 3 Install the imaging unit, and then the cartridge. <p>b Resend the print job.</p> <p>Is the page or image clipped?</p>	Contact technical support .	The problem is solved.

Shadow images appear on prints

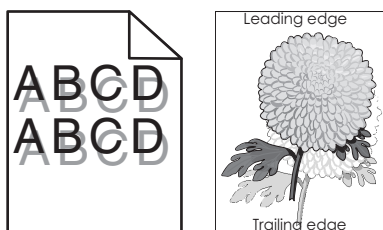

Action	Yes	No
<p>Step 1</p> <p>Load paper with the correct paper type and weight in the tray.</p> <p>Is paper with the correct paper type and weight loaded in the tray?</p>	Go to step 2.	Load paper with the correct paper type and weight in the tray.
<p>Step 2</p> <p>From the printer control panel, set the paper type and weight in the Paper menu to match the paper loaded in the tray.</p> <p>Is the tray set to the type and weight of the paper loaded?</p>	Go to step 3.	Change the paper loaded in the tray to match the paper type and weight specified in the tray settings.
<p>Step 3</p> <p>a Depending on your operating system, specify the paper type and weight from Printing Preferences or from the Print dialog.</p> <p>b Resend the print job.</p> <p>Do shadow images still appear on prints?</p>	Go to step 4.	The problem is solved.

Action	Yes	No
<p>Step 4 Replace the imaging unit, and then resend the print job.</p> <p>Do shadow images still appear on prints?</p>	<p>Contact technical support.</p>	<p>The problem is solved.</p>

Gray background on prints

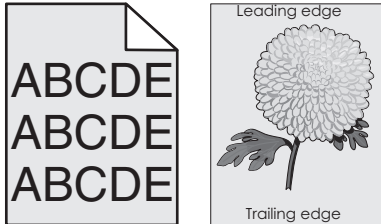

Action	Yes	No
<p>Step 1</p> <p>a From the Quality Menu on the printer control panel, decrease the toner darkness.</p> <p>Note: 8 is the factory default setting.</p> <p>b Resend the print job.</p> <p>Did the gray background disappear from the prints?</p>	<p>The problem is solved.</p>	<p>Go to step 2.</p>
<p>Step 2</p> <p>Reinstall the imaging unit and the toner cartridge.</p> <p>a Remove the toner cartridge.</p> <p>b Remove the imaging unit.</p> <p>Warning—Potential Damage: Do not expose the imaging unit to direct light for more than 10 minutes. Extended exposure to light can cause print quality problems.</p> <p>c Install the imaging unit, and then the cartridge.</p> <p>d Resend the print job.</p> <p>Did the gray background disappear from the prints?</p>	<p>The problem is solved.</p>	<p>Go to step 3.</p>
<p>Step 3</p> <p>Replace the imaging unit, and then resend the print job.</p> <p>Did the gray background disappear from the prints?</p>	<p>The problem is solved.</p>	<p>Contact technical support.</p>

Incorrect margins on prints

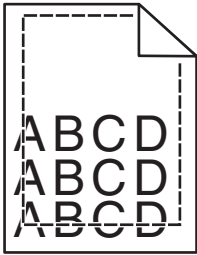

Action	Yes	No
<p>Step 1</p> <p>a Move the width and length guides in the tray to the correct positions for the paper size loaded.</p> <p>b Resend the print job.</p> <p>Are the margins correct?</p>	<p>The problem is solved.</p>	<p>Go to step 2.</p>
<p>Step 2</p> <p>From the printer control panel, set the paper size in the Paper menu to match the paper loaded in the tray.</p> <p>Does the paper size match the paper loaded in the tray?</p>	<p>Go to step 3.</p>	<p>Do one or more of the following:</p> <ul style="list-style-type: none"> • Specify the paper size from the tray settings to match the paper loaded in the tray. • Change the paper loaded in the tray to match the paper size specified in the tray settings.
<p>Step 3</p> <p>a Depending on your operating system, specify the paper size from Printing Preferences or from the Print dialog.</p> <p>b Resend the print job.</p> <p>Are the margins correct?</p>	<p>The problem is solved.</p>	<p>Contact technical support.</p>

Paper curl

Action	Yes	No
<p>Step 1 Move the width and length guides in the tray to the correct positions for the size of the paper loaded.</p> <p>Are the width and length guides positioned correctly?</p>	Go to step 2.	Adjust the width and length guides.
<p>Step 2 From the printer control panel, set the paper type and weight in the Paper menu to match the paper loaded in the tray.</p> <p>Do the paper type and weight match the type and weight of the paper in the tray?</p>	Go to step 3.	Specify the paper type and weight from the tray settings to match the paper loaded in the tray.
<p>Step 3</p> <ul style="list-style-type: none"> a Depending on your operating system, specify the paper type and weight from Printing Preferences or from the Print dialog. b Resend the print job. <p>Is the paper still curled?</p>	Go to step 4.	The problem is solved.
<p>Step 4</p> <ul style="list-style-type: none"> a Remove the paper from the tray, and then turn it over. b Resend the print job. <p>Is the paper still curled?</p>	Go to step 5.	The problem is solved.
<p>Step 5</p> <ul style="list-style-type: none"> a Load paper from a fresh package. <p>Note: Paper absorbs moisture due to high humidity. Store paper in its original wrapper until you use it.</p> <ul style="list-style-type: none"> b Resend the print job. <p>Is the paper still curled?</p>	Contact technical support .	The problem is solved.

Print irregularities

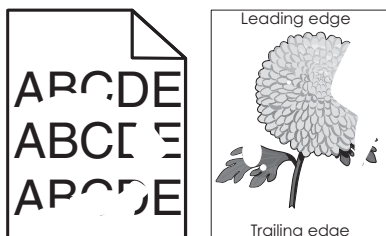

Action	Yes	No
<p>Step 1</p> <p>a Move the width and length guides in the tray to the correct positions for the size of the paper loaded in the tray.</p> <p>b Resend the print job.</p> <p>Do print irregularities still appear?</p>	Go to step 2.	The problem is solved.
<p>Step 2</p> <p>From the printer control panel, set the paper size and type in the Paper menu to match the paper loaded in the tray.</p> <p>Do the printer settings match the type and weight of the paper loaded in the tray?</p>	Go to step 3.	Specify the paper size and type from the tray settings to match the paper loaded in the tray.
<p>Step 3</p> <p>a Depending on your operating system, specify the paper type and weight from Printing Preferences or from the Print dialog.</p> <p>b Resend the print job.</p> <p>Do print irregularities still appear?</p>	Go to step 4.	The problem is solved.
<p>Step 4</p> <p>Check if the paper loaded in the tray has texture or rough finishes.</p> <p>Are you printing on textured or rough paper?</p>	From the printer control panel, set the paper texture in the Paper menu to match the paper loaded in the tray.	Go to step 5.
<p>Step 5</p> <p>a Load paper from a fresh package.</p> <p>Note: Paper absorbs moisture due to high humidity. Store paper in its original wrapper until you use it.</p> <p>b Resend the print job.</p> <p>Do print irregularities still appear?</p>	Go to step 6.	The problem is solved.
<p>Step 6</p> <p>Replace the imaging unit, and then resend the print job.</p> <p>Do print irregularities still appear?</p>	Contact technical support or your Dell printer dealer.	The problem is solved.

Repeating defects appear on prints

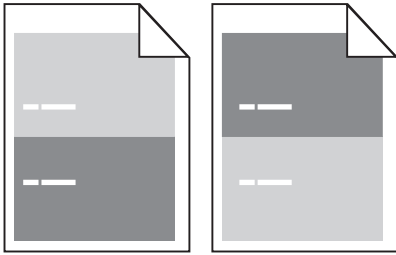

Action	Yes	No
<p>Step 1 Measure the distance between the defects. Check for a distance between the defects that equals:</p> <ul style="list-style-type: none"> • 97 mm (3.82 in.) • 47 mm (1.85 in.) • 38 mm (1.5 in.) <p>Is the distance between defects equal to one of the listed measurements?</p>	<p>Go to step 2.</p>	<p>1 Check if the distance between the defects equal to 80 mm (3.15 in.)</p> <p>2 Take note of the distance, and then contact technical support or your Dell printer dealer.</p>
<p>Step 2 Replace the imaging unit, and then resend the print job. Do the repeating defects still appear?</p>	<p>Contact technical support or your Dell printer dealer.</p>	<p>The problem is solved.</p>

Print is too dark

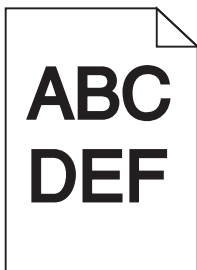

Action	Yes	No
<p>Step 1</p> <p>a From the Quality menu on the printer control panel, reduce the toner darkness. Note: 8 is the factory default setting.</p> <p>b Resend the print job.</p> <p>Is the print still too dark?</p>	<p>Go to step 2.</p>	<p>The problem is solved.</p>

Action	Yes	No
<p>Step 2</p> <p>a From the printer control panel, set the paper type, texture and weight in the Paper menu to match the paper loaded in the tray.</p> <p>b Resend the print job.</p> <p>Is the tray set to the type, texture, and weight of the paper loaded?</p>	<p>Go to step 3.</p>	<p>Do one or more of the following:</p> <ul style="list-style-type: none"> • Specify the paper type, texture, and weight from the tray settings to match the paper loaded in the tray. • Change the paper loaded in the tray to match the paper type, texture and weight specified in the tray settings.
<p>Step 3</p> <p>a Depending on your operating system, specify the paper type, texture and weight from Printing Preferences or from the Print dialog.</p> <p>b Resend the print job.</p> <p>Is the print still too dark?</p>	<p>Go to step 4.</p>	<p>The problem is solved.</p>
<p>Step 4</p> <p>Check if the paper loaded in the tray has texture or rough finishes.</p> <p>Are you printing on textured or rough paper?</p>	<p>From the printer control panel, change the texture settings in the Paper Texture menu to match the paper you are printing on.</p>	<p>Go to step 5.</p>
<p>Step 5</p> <p>a Load paper from a fresh package.</p> <p>Note: Paper absorbs moisture due to high humidity. Store paper in its original wrapper until you use it.</p> <p>b Resend the print job.</p> <p>Is the print still too dark?</p>	<p>Go to step 6.</p>	<p>The problem is solved.</p>
<p>Step 6</p> <p>Replace the imaging unit, and then resend the print job.</p> <p>Is the print still too dark?</p>	<p>Contact technical support.</p>	<p>The problem is solved.</p>

Print is too light



Action	Yes	No
<p>Step 1</p> <p>a From the Quality menu on the printer control panel, increase the toner darkness.</p> <p>Note: 8 is the factory default setting.</p> <p>b Resend the print job.</p> <p>Is the print still too light?</p>	Go to step 2.	The problem is solved.
<p>Step 2</p> <p>From the printer control panel, set the paper type, texture, and weight in the Paper menu to match the paper loaded in the tray.</p> <p>Is the tray set to the type, texture, and weight of the paper loaded?</p>	Go to step 3.	Change the paper type, texture, and weight to match the paper loaded in the tray.
<p>Step 3</p> <p>a Depending on your operating system, specify the paper type, texture, and weight from Printing Preferences or from the Print dialog.</p> <p>b Resend the print job.</p> <p>Is the print still too light?</p>	Go to step 4.	The problem is solved.
<p>Step 4</p> <p>Make sure that the paper has no texture or rough finishes.</p> <p>Are you printing on textured or rough paper?</p>	From the printer control panel, change the texture settings in the Paper Texture menu to match the paper you are printing on.	Go to step 5.
<p>Step 5</p> <p>a Load paper from a fresh package.</p> <p>Note: Paper absorbs moisture due to high humidity. Store paper in its original wrapper until you use it.</p> <p>b Resend the print job.</p> <p>Is the print still too light?</p>	Go to step 6.	The problem is solved.

Action	Yes	No
<p>Step 6</p> <p>a Redistribute the toner in the imaging unit.</p> <ol style="list-style-type: none"> 1 Remove the toner cartridge, and then the imaging unit. 2 Firmly shake the imaging unit. <p>Warning—Potential Damage: Do not expose the imaging unit to direct light for more than 10 minutes. Extended exposure to light may cause print quality problems.</p> <ol style="list-style-type: none"> 3 Install the imaging unit, and then the cartridge. <p>b Resend the print job.</p> <p>Is the print still too light?</p>	<p>Go to step 7.</p>	<p>The problem is solved.</p>
<p>Step 7</p> <p>Replace the imaging unit, and then resend the print job.</p> <p>Is the print still too light?</p>	<p>Contact technical support.</p>	<p>The problem is solved.</p>

Printer is printing blank pages

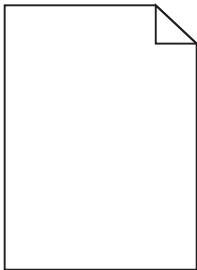

Action	Yes	No
<p>Step 1</p> <p>a Check if there is packing material left on the imaging unit.</p> <ol style="list-style-type: none"> 1 Remove the toner cartridge, and then the imaging unit. 2 Check if the packing material is properly removed from the imaging unit. <p>Warning—Potential Damage: Do not expose the imaging unit to direct light for more than 10 minutes. Extended exposure to light may cause print quality problems.</p> <ol style="list-style-type: none"> 3 Reinstall the imaging unit, and then the cartridge. <p>b Resend the print job.</p> <p>Is the printer still printing blank pages?</p>	<p>Go to step 2.</p>	<p>The problem is solved.</p>

Action	Yes	No
<p>Step 2</p> <p>a Redistribute the toner in the imaging unit.</p> <ol style="list-style-type: none"> 1 Remove the toner cartridge, and then the imaging unit. 2 Firmly shake the imaging unit. <p>Warning—Potential Damage: Do not expose the imaging unit to direct light for more than 10 minutes. Extended exposure to light may cause print quality problems.</p> <ol style="list-style-type: none"> 3 Reinstall the imaging unit, and then the cartridge. <p>b Resend the print job.</p> <p>Is the printer still printing blank pages?</p>	Go to step 3.	The problem is solved.
<p>Step 3</p> <p>Replace the imaging unit, and then resend the print job.</p> <p>Is the printer still printing blank pages?</p>	Contact technical support .	The problem is solved.

Skewed print

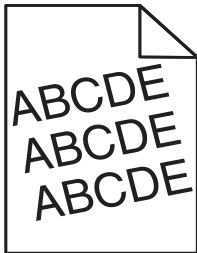

Action	Yes	No
<p>Step 1</p> <p>a Move the width and length guides in the tray to the correct positions for the size of the paper loaded.</p> <p>b Resend the print job.</p> <p>Is the print still skewed?</p>	Go to step 2.	The problem is solved.
<p>Step 2</p> <p>a Check if you are printing on a paper that is supported by the tray.</p> <p>b Resend the print job.</p> <p>Is the print still skewed?</p>	Contact technical support .	The problem is solved.

Printer is printing solid black pages



Action	Yes	No
<p>Step 1</p> <p>a Reinstall the imaging unit.</p> <p> 1 Remove the toner cartridge, and then the imaging unit.</p> <p> Warning—Potential Damage: Do not expose the imaging unit to direct light for more than 10 minutes. Extended exposure to light may cause print quality problems.</p> <p> 2 Install the imaging unit, and then the cartridge.</p> <p>b Resend the print job.</p> <p>Is the printer printing solid black pages?</p>	<p>Go to step 2.</p>	<p>The problem is solved.</p>
<p>Step 2</p> <p>Replace the imaging unit, and then resend the print job.</p> <p>Is the printer printing solid black pages?</p>	<p>Contact technical support.</p>	<p>The problem is solved.</p>

Transparency print quality is poor

Action	Yes	No
<p>Step 1</p> <p>From the printer control panel, set the paper type in the Paper menu to match the paper loaded in the tray.</p> <p>Is the paper type for the tray set to Transparency?</p>	<p>Go to step 2.</p>	<p>Set the paper type to Transparency.</p>
<p>Step 2</p> <p>a Check if you are using a recommended type of transparency.</p> <p>b Resend the print job.</p> <p>Is the print quality still poor?</p>	<p>Contact technical support.</p>	<p>The problem is solved.</p>

Streaked horizontal lines appear on prints

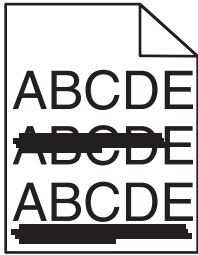

Action	Yes	No
<p>Step 1</p> <p>a Depending on your operating system, specify the tray or feeder from Printing Preferences or the Print dialog.</p> <p>b Resend the print job.</p> <p>Do streaked horizontal lines appear on prints?</p>	Go to step 2.	The problem is solved.
<p>Step 2</p> <p>From the printer control panel, set the paper type and weight in the Paper menu to match the paper loaded in the tray.</p> <p>Do the paper type and weight match the type and weight of the paper in the tray?</p>	Go to step 3.	Change the paper type and weight to match the paper loaded in the tray.
<p>Step 3</p> <p>a Load paper from a fresh package.</p> <p>Note: Paper absorbs moisture due to high humidity. Store paper in its original wrapper until you use it.</p> <p>b Resend the print job.</p> <p>Do streaked horizontal lines appear on prints?</p>	Go to step 4.	The problem is solved.
<p>Step 4</p> <p>a Reinstall the imaging unit.</p> <p>1 Remove the toner cartridge, and then the imaging unit.</p> <p>Warning—Potential Damage: Do not expose the imaging unit to direct light for more than 10 minutes. Extended exposure to light may cause print quality problems.</p> <p>2 Install the imaging unit, and then the cartridge.</p> <p>b Resend the print job.</p> <p>Do streaked horizontal lines appear on prints?</p>	Go to step 5.	The problem is solved.
<p>Step 5</p> <p>Replace the imaging unit, and then resend the print job.</p> <p>Do streaked horizontal lines appear on prints?</p>	Contact technical support .	The problem is solved.

Streaked vertical lines appear on prints

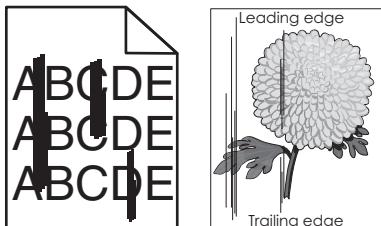

Action	Yes	No
<p>Step 1</p> <p>a Depending on your operating system, specify the paper type, texture, and weight from Printing Preferences or from the Print dialog.</p> <p>b Resend the print job.</p> <p>Do streaked vertical lines appear on prints?</p>	Go to step 2.	The problem is solved.
<p>Step 2</p> <p>From the printer control panel, set the paper texture, type, and weight in the Paper menu to match the paper loaded in the tray.</p> <p>Do the paper texture, type, and weight match the paper in the tray?</p>	Go to step 3.	<p>Do one or more of the following:</p> <ul style="list-style-type: none"> Specify the paper texture, type, and weight from the tray settings to match the paper loaded in the tray. Change the paper loaded in the tray to match the paper texture, type, and weight specified in the tray settings.
<p>Step 3</p> <p>a Load paper from a fresh package.</p> <p>Note: Paper absorbs moisture due to high humidity. Store paper in its original wrapper until you use it.</p> <p>b Resend the print job.</p> <p>Do streaked vertical lines appear on prints?</p>	Go to step 4.	The problem is solved.
<p>Step 4</p> <p>a Reinstall the imaging unit.</p> <ol style="list-style-type: none"> Remove the toner cartridge, and then the imaging unit. <p>Warning—Potential Damage: Do not expose the imaging unit to direct light for more than 10 minutes. Extended exposure to light may cause print quality problems.</p> <ol style="list-style-type: none"> Install the imaging unit, and then the cartridge. <p>b Resend the print job.</p> <p>Do streaked vertical lines appear on prints?</p>	Go to step 5.	The problem is solved.

Action	Yes	No
<p>Step 5 Replace the imaging unit, and then resend the print job.</p> <p>Do streaked vertical lines appear on prints?</p>	<p>Contact technical support or your Dell printer dealer.</p>	<p>The problem is solved.</p>

Horizontal voids appear on prints

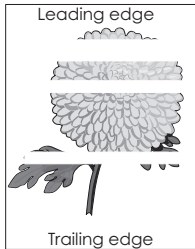

Action	Yes	No
<p>Step 1</p> <ul style="list-style-type: none"> a Make sure your software program is using a correct fill pattern. b Resend the print job. <p>Do horizontal voids appear on prints?</p>	<p>Go to step 2.</p>	<p>The problem is solved.</p>
<p>Step 2</p> <ul style="list-style-type: none"> a Load the specified tray or feeder with a recommended type of paper. b Resend the print job. <p>Do horizontal voids appear on prints?</p>	<p>Go to step 3.</p>	<p>The problem is solved.</p>
<p>Step 3</p> <ul style="list-style-type: none"> a Redistribute the toner in the imaging unit. <ol style="list-style-type: none"> 1 Remove the toner cartridge, and then the imaging unit. 2 Firmly shake the imaging unit. <p>Warning—Potential Damage: Do not expose the imaging unit to direct light for more than 10 minutes. Extended exposure to light may cause print quality problems.</p> <ol style="list-style-type: none"> 3 Reinstall the imaging unit, and then the cartridge. b Resend the print job. <p>Do horizontal voids appear on prints?</p>	<p>Go to step 4.</p>	<p>The problem is solved.</p>
<p>Step 4 Replace the imaging unit, and then resend the print job.</p> <p>Do horizontal voids appear on prints?</p>	<p>Contact technical support.</p>	<p>The problem is solved.</p>

Vertical voids appear on prints

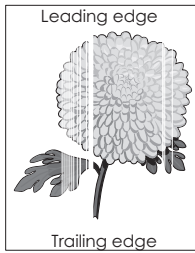

Action	Yes	No
<p>Step 1</p> <ul style="list-style-type: none"> a Make sure your software program is using a correct fill pattern. b Resend the print job. <p>Do vertical voids appear on prints?</p>	Go to step 2.	The problem is solved.
<p>Step 2</p> <ul style="list-style-type: none"> a From the printer control panel, set the paper type and weight in the Paper menu to match the paper loaded in the tray. b Resend the print job. <p>Do vertical voids appear on prints?</p>	Go to step 3.	The problem is solved.
<p>Step 3</p> <p>Check if you are using a recommended type of paper.</p> <ul style="list-style-type: none"> a Load the indicated tray or feeder with a recommended type of paper. b Resend the print job. <p>Do vertical voids appear on prints?</p>	Go to step 4.	The problem is solved.
<p>Step 4</p> <ul style="list-style-type: none"> a Redistribute the toner in the imaging unit. <ol style="list-style-type: none"> 1 Remove the toner cartridge, and then the imaging unit. 2 Firmly shake the imaging unit. <p>Warning—Potential Damage: Do not expose the imaging unit to direct light for more than 10 minutes. Extended exposure to light may cause print quality problems.</p> <ol style="list-style-type: none"> 3 Reinstall the imaging unit, and then the cartridge. b Resend the print job. <p>Do vertical voids appear on prints?</p>	<p>Contact technical support.</p> <p>Note: The laser scanning unit may be defective.</p>	The problem is solved.

Toner specks appear on prints

Action	Yes	No
Replace the imaging unit, and then resend the print job. Do toner specks appear on prints?	Contact technical support .	The problem is solved.

Toner fog or background shading appears on prints

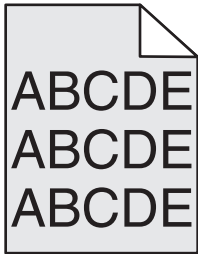

Action	Yes	No
Step 1 Reinstall the imaging unit. a Remove, and then install the imaging unit. b Resend the print job. Do fog or shading appear on prints?	Go to step 2.	The problem is solved.
Step 2 Replace the imaging unit, and then resend the print job. Do fog or shading appear on prints?	Contact technical support or your Dell printer dealer.	The problem is solved.

Toner rubs off

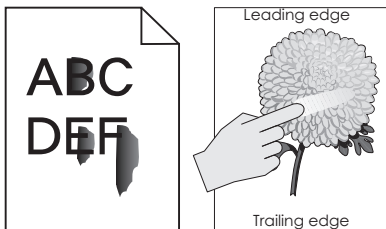

Action	Yes	No
<p>Step 1 From the Paper menu on the printer control panel, check the paper type and weight.</p> <p>Do the paper type and texture match the paper loaded in the tray?</p>	Go to step 2.	Specify the paper type and weight from the tray settings to match the paper loaded in the tray.
<p>Step 2 Check if you are printing on paper with texture or rough finishes.</p> <p>Are you printing on textured or rough paper?</p>	From the Paper menu on the printer control panel, set the paper texture.	Contact technical support or your Dell printer dealer.

Uneven print density

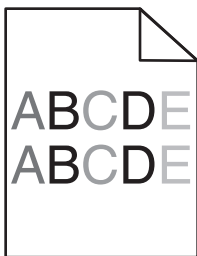

Action	Yes	No
<p>Replace the imaging unit, and then resend the print job.</p> <p>Is the print density uneven?</p>	Contact technical support .	The problem is solved.

Embedded Web Server does not open

Action	Yes	No
<p>Step 1</p> <ul style="list-style-type: none"> a Turn on the printer. b Open a Web browser, and then type the printer IP address. c Press Enter. <p>Does the Embedded Web Server open?</p>	The problem is solved.	Go to step 2.

Action	Yes	No
<p>Step 2 Make sure the printer IP address is correct.</p> <p>a View the printer IP address:</p> <ul style="list-style-type: none"> • From the TCP/IP section in the Network/Ports menu • By printing a network setup page or menu settings page, and then finding the TCP/IP section <p>Note: An IP address appears as four sets of numbers separated by periods, such as 123.123.123.123.</p> <p>b Open a Web browser, and then type the IP address.</p> <p>Note: Depending on the network settings, you may need to type “https://” instead of “http://” before the printer IP address to access the Embedded Web Server.</p> <p>c Press Enter.</p> <p>Does the Embedded Web Server open?</p>	<p>The problem is solved.</p>	<p>Go to step 3.</p>
<p>Step 3 Check if the network is working.</p> <p>a Print a network setup page.</p> <p>b Check the first section of the network setup page and confirm that the status is Connected.</p> <p>Note: If the status is Not Connected, then the connection may be intermittent, or the network cable may be defective. Contact your system support person for a solution, and then print another network setup page.</p> <p>c Open a Web browser, and then type the printer IP address.</p> <p>d Press Enter.</p> <p>Does the Embedded Web Server open?</p>	<p>The problem is solved.</p>	<p>Go to step 4.</p>
<p>Step 4 Check if the cable connections to the printer and print server are secure.</p> <p>a Connect the cables properly. For more information, see the setup documentation that came with the printer.</p> <p>b Open a Web browser, and then type the printer IP address.</p> <p>c Press Enter.</p> <p>Does the Embedded Web Server open?</p>	<p>The problem is solved.</p>	<p>Go to step 5.</p>
<p>Step 5 Temporarily disable the Web proxy servers. Proxy servers may block or restrict you from accessing certain Web sites including the Embedded Web Server.</p> <p>Does the Embedded Web Server open?</p>	<p>The problem is solved.</p>	<p>Contact your system support person.</p>

Contacting technical support

When you call technical support, describe the problem you are experiencing, the message on the printer display, and the troubleshooting steps you have already taken to find a solution.

You need to know your printer model type and the service tag number or express service code. For more information, see the label on the inside top front cover or at the back of the printer. The service tag number is also listed on the menu settings page.

For more information, check the Dell Support Web site at <http://support.dell.com>.

Appendix

Dell Technical Support Policy

Technician-assisted technical support requires the cooperation and participation of the customer in the troubleshooting process and provides for restoration of the Operating System, application software and hardware drivers to the original default configuration as shipped from Dell, as well as the verification of appropriate functionality of the printer and all Dell-installed hardware. In addition to this technician assisted technical support, online technical support is available at Dell Support. Additional technical support options may be available for purchase.

Dell provides limited technical support for the printer and any Dell-installed software and peripherals. Support for third-party software and peripherals is provided by the original manufacturer, including those purchased and/or installed through Software & Peripherals (DellWare), ReadyWare, and Custom Factory Integration (CFI/DellPlus).

Contacting Dell

You can access Dell Support at **support.dell.com**. Select your region on the WELCOME TO DELL SUPPORT page, and fill in the requested details to access help tools and information.

You can contact Dell electronically using the following addresses:

- World Wide Web
 - www.dell.com/**
 - www.dell.com/ap/** (Asian/Pacific countries only)
 - www.dell.com/jp/** (Japan only)
 - www.euro.dell.com** (Europe only)
 - www.dell.com/la/** (Latin American and Caribbean countries)
 - www.dell.ca** (Canada only)
- Anonymous file transfer protocol (FTP)
 - ftp.dell.com**
 - Log in as user: anonymous, and use your email address as your password.
- Electronic Support Service
 - mobile_support@us.dell.com**
 - support@us.dell.com**
 - la-techsupport@dell.com** (Latin America and Caribbean countries only)
 - apsupport@dell.com** (Asian/Pacific countries only)
 - support.jp.dell.com** (Japan only)
 - support.euro.dell.com** (Europe only)
- Electronic Quote Service
 - apmarketing@dell.com** (Asian/Pacific countries only)
 - sales_canada@dell.com** (Canada only)

Warranty and Return Policy

Dell Inc. (“Dell”) manufactures its hardware products from parts and components that are new or equivalent to new in accordance with industry-standard practices. For information about the Dell warranty for your printer, refer to the *Product Information Guide*.

Index

Numerics

- 250-sheet tray
 - installing 17
- 550-sheet tray
 - installing 17

Symbols

- [x]-page jam, clear manual feeder. [25y.xx] 115
- [x]-page jam, clear standard bin. [20y.xx] 112
- [x]-page jam, open front door. [20y.xx] 108
- [x]-page jam, open rear door. [20y.xx] 111
- [x]-page jam, open tray [x]. [24y.xx] 114
- [x]-page jam, remove tray 1 to clear duplex. [23y.xx] 113

A

- accessing Status Monitor Center 101
- accessing the controller board 13
- Active NIC menu 62
- adjusting printer display brightness 90
- adjusting Sleep mode 88
- adjusting toner darkness 46
- AppleTalk menu 67
- attaching cables 19
- available internal options 13
- avoiding jams 40
- avoiding paper jams 105

C

- cables
 - Ethernet 19
 - parallel 19
 - USB 19
- canceling
 - print job, from computer 51
- canceling a print job
 - from a computer 51
 - from the printer control panel 50
- cannot open Embedded Web Server 156

- card stock
 - loading, multipurpose feeder 32
 - tips 40
- Cartridge low [88.xy] 117
- Cartridge nearly low [88.xy] 117
- Cartridge very low, [x] estimated pages remain [88.xy] 117
- Cartridge, imaging unit mismatch [41.xy] 117
- Change [paper source] to [custom string] load [orientation] 118
- Change [paper source] to [custom type name] load [orientation] 117
- Change [paper source] to [paper size] load [orientation] 118
- Change [paper source] to [paper type] [paper size] load [orientation] 118
- checking an unresponsive printer 127
- checking status of parts and supplies 93
- checking the status of parts and supplies 93
- checking the virtual display using the Embedded Web Server 101
- cleaning
 - exterior of the printer 93
- cleaning the printer 93
- Close front door 118
- Complex page, some data may not have printed [39] 118
- confidential jobs
 - modifying print settings 103
- confidential print jobs
 - printing from a Macintosh computer 49
 - printing from Windows 49
- configuration information wireless network 23
- configurations
 - printer 10
- Configure MP menu 56
- configuring
 - multiple printers 103
 - supply notifications, imaging unit 102

- supply notifications, maintenance kit 102
- supply notifications, toner cartridge 102
- configuring supply notifications 102
- configuring the Universal paper size settings 27
- connecting to a wireless network using PBC, Push Button Configuration method 24
- using PIN, Personal Identification Number method 24
- using the Embedded Web Server 25
- conservation settings
 - brightness, adjusting 90
 - conserving supplies 87
 - Eco-Mode 87
 - Hibernate Mode 89
 - Quiet mode 88
 - Sleep mode 88
- conserving supplies 87
- contacting technical support 158
- control panel, printer 11
 - indicator light 12
 - Sleep button light 12
- controller board
 - accessing 13
- custom paper type
 - assigning 37
- custom paper type name
 - creating 35
- custom paper type names
 - assigning 36
- Custom Type [x]
 - assigning a paper type 37
- Custom Type [x] name
 - creating 35
- Custom Types menu 60

D

- Default Source menu 53
- Defective flash detected [51] 118
- device and network settings
 - erasing 92
- directory list
 - printing 50

- display troubleshooting
 - printer display is blank 129
- display, control panel 11
- display, printer control panel
 - adjusting brightness 90
- documents, printing
 - from Macintosh 46
 - from Windows 46
- E**
- Eco-Mode setting 87
- embedded solutions
 - erasing 92
- Embedded Web Server
 - adjusting brightness 90
 - checking the status of parts 93
 - checking the status of supplies 93
 - copying settings to other printers 103
 - modifying confidential print settings 103
 - problem accessing 156
- Embedded Web Server Administrator's Guide
 - where to find 92
- envelopes
 - loading, multipurpose feeder 32
 - tips on using 41
- environmental settings
 - conserving supplies 87
 - Eco-Mode 87
 - Hibernate Mode 89
 - printer display brightness, adjusting 90
 - Quiet mode 88
 - Sleep mode 88
- erasing non-volatile memory 92
- erasing volatile memory 92
- Error reading USB drive. Remove USB. 119
- Error reading USB hub. Remove hub. 119
- Ethernet network
 - preparing to set up for Ethernet printing 22
- Ethernet network setup
 - using Macintosh 22
 - using Windows 22
- Ethernet networking
 - Macintosh 22
 - Windows 22
- Ethernet port 19
- Ethernet setup
 - preparing for an 22
- exterior of the printer
 - cleaning 93
- F**
- factory defaults, restoring 104
- finding more information about the printer 8
- Finishing menu 77
- firmware card 13
- flash drive
 - printing from 47
- flash drives
 - supported file types 49
- font sample list
 - printing 50
- G**
- General Settings menu 72
- green settings
 - Eco-Mode 87
 - Hibernate Mode 89
 - Quiet mode 88
 - Sleep mode 88
- H**
- held jobs
 - printing from a Macintosh computer 49
 - printing from Windows 49
- Help menu 85
- Hibernate Mode
 - using 89
- HTML menu 84
- I**
- Image menu 85
- imaging unit
 - replacing 97
- Imaging unit low [84.xy] 119
- Imaging unit nearly low [84.xy] 119
- Imaging unit very low, [x] estimated pages remain [84.xy] 119
- Incorrect paper size, open [paper source] [34] 119
- indicator light 11
- individual settings
 - erasing 92
- Insert Tray [x] 119
- installing an optional card 16
- installing printer on a network
 - Ethernet networking 22
- installing printer software 20
 - adding options 21
- installing the 250-sheet tray 17
- installing the 550-sheet tray 17
- Insufficient memory for Flash Memory Defragment operation [37] 120
- Insufficient memory to collate job [37] 120
- Insufficient memory to support Resource Save feature [35] 120
- Insufficient memory, some Held Jobs were deleted [37] 120
- Insufficient memory, some held jobs will not be restored [37] 120
- internal options 13
- IPv6 menu 65
- J**
- jams
 - accessing 106
 - avoiding 105
 - understanding messages 106
- jams, clearing
 - in duplex area 113
 - in front door 108
 - in manual feeder 115
 - in rear door 111
 - in standard bin 112
 - in tray [x] 114
- L**
- labels, paper
 - tips 41
- letterhead
 - loading, multipurpose feeder 32
 - tips on using 42
- light, indicator 11
- linking trays 35
 - assigning custom paper type names 36
- Load [paper source] with [custom string] [orientation] 120
- Load [paper source] with [custom type name] [orientation] 121
- Load [paper source] with [paper size] [orientation] 121
- Load [paper source] with [paper type] [paper size] [orientation] 121

- Load Manual Feeder with [custom string] [orientation] 122
- Load Manual Feeder with [custom type name] [orientation] 121
- Load Manual Feeder with [paper size] [orientation] 122
- Load Manual Feeder with [paper type] [paper size] [orientation] 122
- loading
 - multipurpose feeder 32
 - trays 28
- loading the optional tray 28
- loading the standard tray 28
- lock, security 91

M

- Maintenance kit low [80.xy] 122
- Maintenance kit nearly low [80.xy] 122
- Maintenance kit very low, [x]
 - estimated pages remain [80.xy] 122
- managing printer messages 101
- memory
 - types installed on printer 91
- memory card 13
 - installing 14
- Memory full [38] 123
- menu settings
 - loading on multiple printers 103
- menu settings page
 - printing 26
- menus
 - Active NIC 62
 - AppleTalk 67
 - Configure MP 56
 - Custom Types 60
 - Default Source 53
 - Finishing 77
 - General Settings 72
 - Help 85
 - HTML 84
 - Image 85
 - IPv6 65
 - list of 52
 - Miscellaneous 70
 - Network [x] 62
 - Network Card 64
 - Paper Loading 59
 - Paper Size/Type 53
 - Paper Texture 56
 - Paper Weight 58

- PCL Emul 81
- PDF 80
- PostScript 80
- Quality 78
- Reports 61, 63
- Security Audit Log 70
- Set Date and Time 71
- Setup 75
- SMTP Setup menu 69
- Standard Network 62
- Standard USB 67
- Substitute Size 56
- TCP/IP 64
- Universal Setup 61
- Utilities 79
- Wireless 66
- XPS 80
- Miscellaneous menu 70
- mobile device
 - printing from 47
- moving the printer 9, 99, 100
- multipurpose feeder
 - loading 32

N

- Network [x] menu 62
- Network [x] software error [54] 123
- Network Card menu 64
- network setup page
 - printing 26
- Non-Dell [supply type], see User's Guide [33.xy] 123
- non-volatile memory 91
 - erasing 92
- Not enough free space in flash memory for resources [52] 124
- number of remaining pages
 - estimate 94

O

- optional card
 - installing 16
- optional tray
 - loading 28
- options
 - 250-sheet tray, installing 17
 - 550-sheet tray, installing 17
 - firmware cards 13
 - memory card 14
 - memory cards 13

- updating in printer driver 21
- ordering supplies
 - using Printer Home 94

P

- paper
 - characteristics 38
 - letterhead 39
 - loading, multipurpose feeder 32
 - preprinted forms 39
 - recycled 40
 - selecting 39
 - setting size 27
 - setting type 27
 - storing 40
 - unacceptable 39
 - Universal size setting 27
 - using recycled 87
- paper feed troubleshooting
 - message remains after jam is cleared 132
- paper jams
 - avoiding 105
- paper jams, clearing
 - in duplex area 113
 - in front door 108
 - in manual feeder 115
 - in rear door 111
 - in standard bin 112
 - in tray [x] 114
- Paper Loading menu 59
- paper messages
 - [x]-page jam, remove tray 1 to clear duplex. [23y.xx] 113
- Paper Size/Type menu 53
- paper sizes
 - supported by the printer 43
- paper stop, using 27
- Paper Texture menu 56
- paper types
 - duplex support 44
 - supported by printer 44
 - where to load 44
- Paper Weight menu 58
- parallel port 19
- parts
 - checking status 93
 - checking, using the Embedded Web Server 93
- parts and supplies, status of
 - checking, on printer control panel 93

- PCL Emul menu 81
- PDF menu 80
- Personal Identification Number method
 - using 24
- PostScript menu 80
- PPDS font error [50] 124
- preparing to set up the printer on an Ethernet network 22
- print irregularities 143
- print job
 - canceling from the printer control panel 50
 - canceling, from computer 51
- print quality troubleshooting
 - blank pages 148
 - characters have jagged edges 138
 - clipped pages or images 139
 - gray background on prints 141
 - horizontal voids appear on prints 153
 - print irregularities 143
 - print is too dark 145
 - print is too light 147
 - printer is printing solid black pages 150
 - repeating print defects appear on prints 145
 - shadow images appear on prints 140
 - skewed print 149
 - streaked horizontal lines appear on prints 151
 - streaked vertical lines 152
 - toner fog or background shading 155
 - toner rubs off 155
 - toner specks appear on prints 155
 - transparency print quality is poor 150
 - uneven print density 156
 - white streaks 154
- print troubleshooting
 - error reading flash drive 133
 - incorrect characters print 137
 - incorrect margins on prints 142
 - jammed pages are not reprinted 132
 - job prints from wrong tray 136
 - job prints on wrong paper 136
 - jobs do not print 134
 - Large jobs do not collate 137
 - multiple-language PDF files do not print 133
 - paper curl 143
 - paper frequently jams 131
 - print job takes longer than expected 135
 - tray linking does not work 137
 - unexpected page breaks occur 138
- printer
 - configurations 10
 - minimum clearances 9
 - moving 9, 99, 100
 - selecting a location 9
 - shipping 100
- printer configurations
 - basic model 10
 - configured model 10
- printer control panel 11
 - adjusting brightness 90
 - factory defaults, restoring 104
 - indicator light 12
 - Sleep button light 12
 - using 11
- printer control panel, virtual display
 - using the Embedded Web Server 101
- printer information
 - where to find 8
- printer is printing blank pages 148
- printer messages
 - [x]-page jam, clear manual feeder. [25y.xx] 115
 - [x]-page jam, clear standard bin. [20y.xx] 112
 - [x]-page jam, open front door. [20y.xx] 108
 - [x]-page jam, open rear door. [20y.xx] 111
 - [x]-page jam, open tray [x]. [24y.xx] 114
- Cartridge low [88.xy] 117
- Cartridge nearly low [88.xy] 117
- Cartridge very low, [x] estimated pages remain [88.xy] 117
- Cartridge, imaging unit mismatch [41.xy] 117
- Change [paper source] to [custom string] load [orientation] 118
- Change [paper source] to [custom type name] load [orientation] 117
- Change [paper source] to [paper size] load [orientation] 118
- Change [paper source] to [paper type] [paper size] load [orientation] 118
- Close front door 118
- Complex page, some data may not have printed [39] 118
- Defective flash detected [51] 118
- Error reading USB drive. Remove USB. 119
- Error reading USB hub. Remove hub. 119
- Imaging unit low [84.xy] 119
- Imaging unit nearly low [84.xy] 119
- Imaging unit very low, [x] estimated pages remain [84.xy] 119
- Incorrect paper size, open [paper source] [34] 119
- Insert Tray [x] 119
- Insufficient memory for Flash Memory Defragment operation [37] 120
- Insufficient memory to collate job [37] 120
- Insufficient memory to support Resource Save feature [35] 120
- Insufficient memory, some Held Jobs were deleted [37] 120
- Insufficient memory, some held jobs will not be restored [37] 120
- Load [paper source] with [custom string] [orientation] 120
- Load [paper source] with [custom type name] [orientation] 121
- Load [paper source] with [paper size] [orientation] 121
- Load [paper source] with [paper type] [paper size] [orientation] 121
- Load Manual Feeder with [custom string] [orientation] 122
- Load Manual Feeder with [custom type name] [orientation] 121
- Load Manual Feeder with [paper size] [orientation] 122

- Load Manual Feeder with [paper type] [paper size] [orientation] 122
 - Maintenance kit low [80.xy] 122
 - Maintenance kit nearly low [80.xy] 122
 - Maintenance kit very low, [x] estimated pages remain [80.xy] 122
 - managing 101
 - Memory full [38] 123
 - Network [x] software error [54] 123
 - Non-Dell [supply type], see User's Guide [33.xy] 123
 - Not enough free space in flash memory for resources [52] 124
 - PPDS font error [50] 124
 - Reinstall missing or unresponsive cartridge [31.xy] 124
 - Reinstall missing or unresponsive imaging unit [31.xy] 124
 - Remove paper from standard output bin 125
 - Replace cartridge, 0 estimated pages remain [88.xy] 125
 - Replace imaging unit, 0 estimated pages remain [84.xy] 125
 - Replace maintenance kit, 0 estimated pages remain [80.xy] 125
 - Replace unsupported cartridge [32.xy] 125
 - Replace unsupported imaging unit [32.xy] 125
 - SMTP server not set up. Contact system administrator. 125
 - Standard network software error [54] 126
 - Standard parallel port disabled [56] 126
 - Standard USB port disabled [56] 126
 - Too many flash options installed [58] 126
 - Too many trays attached [58] 126
 - Unformatted flash detected [53] 127
 - Unsupported option in slot [x] [55] 127
 - Unsupported USB hub, please remove 119
 - printer options troubleshooting
 - internal option is not detected 129
 - tray problems 130
 - printer problems, solving basic 127
 - printer software
 - installing 20
 - printing
 - directory list 50
 - font sample list 50
 - from a mobile device 47
 - from flash drive 47
 - from Macintosh 46
 - from Windows 46
 - menu settings page 26
 - network setup page 26
 - printing a document 46
 - printing a network setup page 26
 - printing confidential and other held jobs
 - from a Macintosh computer 49
 - from Windows 49
 - printing from a flash drive 47
 - printing from a mobile device 47
 - publications
 - where to find 8
 - Push Button Configuration method using 24
- Q**
- Quality menu 78
 - Quiet mode 88
- R**
- recycled paper
 - using 40, 87
 - recycling
 - Dell products 90
 - reducing noise 88
 - Reinstall missing or unresponsive cartridge [31.xy] 124
 - Reinstall missing or unresponsive imaging unit [31.xy] 124
 - Remove paper from standard output bin 125
 - repeat print jobs
 - printing from a Macintosh computer 49
 - printing from Windows 49
 - repeating print defects appear on prints 145
 - Replace cartridge, 0 estimated pages remain [88.xy] 125
 - Replace imaging unit, 0 estimated pages remain [84.xy] 125
 - Replace maintenance kit, 0 estimated pages remain [80.xy] 125
 - Replace unsupported cartridge [32.xy] 125
 - Replace unsupported imaging unit [32.xy] 125
 - replacing
 - imaging unit 97
 - toner cartridge 95
 - reports
 - viewing 102
 - Reports menu 61, 63
 - reserve print jobs
 - printing from a Macintosh computer 49
 - printing from Windows 49
- S**
- safety information 6, 7
 - security
 - modifying confidential print settings 103
 - Security Audit Log menu 70
 - security lock 91
 - security settings
 - erasing 92
 - security Web page
 - where to find 92
 - selecting a location for the printer 9
 - selecting paper 39
 - Set Date and Time menu 71
 - setting
 - paper size 27
 - paper type 27
 - TCP/IP address 64
 - setting up the printer
 - on an Ethernet network (Macintosh only) 22
 - on an Ethernet network (Windows only) 22
 - Setup menu 75
 - shipping the printer 100
 - Sleep mode
 - adjusting 88
 - SMTP server not set up. Contact system administrator. 125

SMTP Setup menu 69
software
 Status Messenger 101
 Status Monitor Center 101
 Supplies Ordering Utility 94
standard bin, using 27
Standard Network menu 62
Standard network software error
[54] 126
Standard parallel port disabled
[56] 126
standard tray
 loading 28
Standard USB menu 67
Standard USB port disabled
[56] 126
statement of volatility 91
Status Monitor Center
 accessing 101
status of parts and supplies
 checking 93
storing
 paper 40
 supplies 95
streaked horizontal lines appear on
prints 151
streaked vertical lines appear on
prints 152
streaks appear 154
Substitute Size menu 56
supplies
 checking status 93
 checking, using the Embedded
 Web Server 93
 conserving 87
 ordering 94
 storing 95
 using recycled paper 87
Supplies Ordering Utility
 ordering supplies 94
supply notifications
 configuring 102
supported flash drives 49
supported paper sizes 43
supported paper types and
weights 44

T

TCP/IP menu 64
tips
 card stock 40
 labels, paper 41

 letterhead 42
 on using envelopes 41
 transparencies 42
tips on using envelopes 41
toner cartridge
 replacing 95
toner darkness
 adjusting 46
Too many flash options installed
[58] 126
Too many trays attached [58] 126
transparencies
 loading, multipurpose feeder 32
 tips 42
trays
 linking 35
 loading 28
 unlinking 35
troubleshooting
 cannot open Embedded Web
 Server 156
 checking an unresponsive
 printer 127
 contacting technical support 158
 solving basic printer
 problems 127
troubleshooting, display
 printer display is blank 129
troubleshooting, paper feed
 message remains after jam is
 cleared 132
troubleshooting, print
 error reading flash drive 133
 incorrect characters print 137
 incorrect margins on prints 142
 jammed pages are not
 reprinted 132
 job prints from wrong tray 136
 job prints on wrong paper 136
 jobs do not print 134
 Large jobs do not collate 137
 multiple-language PDF files do not
 print 133
 paper curl 143
 paper frequently jams 131
 print job takes longer than
 expected 135
 tray linking does not work 137
 unexpected page breaks
 occur 138
troubleshooting, print quality
 blank pages 148

 characters have jagged edges 138
 clipped pages or images 139
 gray background on prints 141
 horizontal voids appear on
 prints 153
 print irregularities 143
 print is too dark 145
 print is too light 147
 printer is printing solid black
 pages 150
 repeating print defects appear on
 prints 145
 shadow images appear on
 prints 140
 skewed print 149
 streaked horizontal lines appear
 on prints 151
 streaked vertical lines 152
 toner fog or background
 shading 155
 toner rubs off 155
 toner specks appear on prints 155
 transparency print quality is
 poor 150
 uneven print density 156
 white streaks on a page 154
troubleshooting, printer options
 internal option is not
 detected 129
 tray problems 130

U

unacceptable paper 39
uneven print density 156
Unformatted flash detected
[53] 127
Universal paper size settings
 configuring 27
Universal Setup menu 61
unlinking trays 35
Unsupported option in slot [x]
[55] 127
Unsupported USB hub, please
remove 119
updating options in printer
driver 21
USB port 19
 using Hibernate Mode 89
 using recycled paper 87
 using the printer control panel 11
Utilities menu 79

V

- verify print jobs
 - printing from a Macintosh computer 49
 - printing from Windows 49
- vertical voids appear 154
- viewing
 - reports 102
- virtual display
 - checking, using Embedded Web Server 101
- voids appear 154
- volatile memory 91
 - erasing 92
- volatility
 - statement of 91

W

- Wireless menu 66
- wireless network
 - configuration information 23
- wireless network setup
 - using the Embedded Web Serve 25

X

- XPS menu 80

Free Manuals Download Website

<http://myh66.com>

<http://usermanuals.us>

<http://www.somanuals.com>

<http://www.4manuals.cc>

<http://www.manual-lib.com>

<http://www.404manual.com>

<http://www.luxmanual.com>

<http://aubethermostatmanual.com>

Golf course search by state

<http://golfingnear.com>

Email search by domain

<http://emailbydomain.com>

Auto manuals search

<http://auto.somanuals.com>

TV manuals search

<http://tv.somanuals.com>