

# DATA PROJECTOR

## XJ-H1600/XJ-H1650\*

## XJ-H1700/XJ-H1750\*

## XJ-ST145\*/XJ-ST155\*

- \* USB port models
- \* Modèles à port USB
- \* Modelos con puerto USB

## English

### Setup Guide

Be sure to keep all user documentation handy for future reference.

## Français

### Guide d'installation

Conservez la documentation à portée de main pour toute référence future.

## Español

### Guía de configuración

Asegúrese de tener a mano toda la documentación del usuario para futuras consultas.

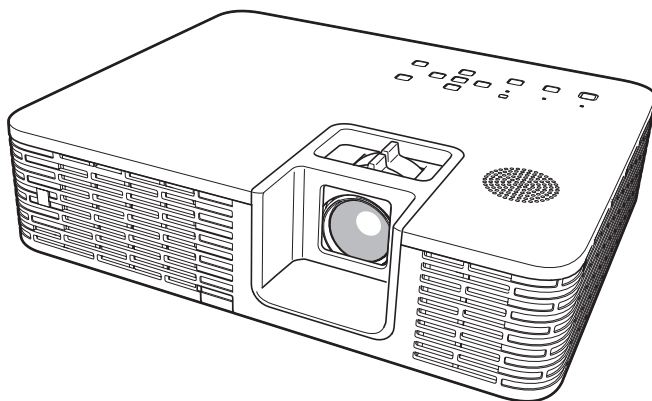

• Some models covered by this User's Guide may not be available in certain geographic areas.

• Certains modèles couverts par ce mode d'emploi peuvent ne pas être commercialisés dans certaines zones géographiques.

• Algunos modelos cubiertos por esta Guía del usuario pueden no estar disponibles en determinadas áreas geográficas.

# Contents

<b>Safety Precautions</b> .....	<b>E-1</b>	<b>Starting and Stopping Projection</b> .....	<b>E-15</b>
<b>Operating Precautions</b> .....	<b>E-7</b>	To start projection .....	E-15
About the Light Source Unit .....	E-7	To turn off the projector .....	E-15
Laser Precautions .....	E-7	<b>Using the CD-ROM</b> .....	<b>E-16</b>
Other Precautions .....	E-8	To view the contents of a	
Precaution when Handling the		User's Guide (PDF) .....	E-16
Projector after Use .....	E-9	<b>Indicators</b> .....	<b>E-17</b>
Stowing the Projector in the Carrying Bag .....	E-9	<b>Troubleshooting</b> .....	<b>E-18</b>
Cleaning the Projector .....	E-9	<b>Main Specifications</b> .....	<b>E-20</b>
<b>Unpacking</b> .....	<b>E-10</b>		
<b>General Guide</b> .....	<b>E-11</b>		
<b>Getting Ready</b> .....	<b>E-12</b>		
Loading Remote Controller Batteries .....	E-12		
Setting Up the Projector .....	E-12		
Setup Precautions .....	E-13		
Changing the Projector Elevation Angle .....	E-13		
Connecting a Computer to the Projector .....	E-14		

- DLP is a registered trademark of Texas Instruments Incorporated of the United States.
- Microsoft, Windows, Windows Vista, and PowerPoint are registered trademarks or trademarks of Microsoft Corporation in the United States and other countries.
- HDMI, the HDMI Logo and High-Definition Multimedia Interface are trademarks or registered trademarks of HDMI Licensing, LLC.
- Apple and Macintosh are registered trademarks of Apple Inc. of the United States.
- Adobe and Reader are registered trademarks of Adobe Systems Incorporated.
- XGA is a registered trademark of IBM Corporation of the United States.
- ArcSoft and the ArcSoft logo are trademarks or registered trademarks of ArcSoft, Inc. in the United States and other countries.
- Other company and product names may be registered trademarks or trademarks of their respective owners.



- The contents of this User's Guide are subject to change without notice.
- Copying of this manual, either in part or its entirety, is forbidden. You are allowed to use this manual for your own personal use. Any other use is forbidden without the permission of CASIO COMPUTER CO., LTD.
- CASIO COMPUTER CO., LTD. shall not be held liable for any lost profits or claims from third parties arising out of the use of this product or this manual.
- CASIO COMPUTER CO., LTD. shall not be held liable for any loss or lost profits due to loss of data caused by malfunction or maintenance of this product, or any other reason.
- The sample screens shown in this manual are for illustrative purposes only, and may not be exactly the same as the screens actually produced by the product.
- Unless specifically stated otherwise, all illustrations in this manual show the XJ-H1650.

# Safety Precautions

Thank you for selecting this CASIO product. Be sure to read these “Safety Precautions” before trying to use it. After reading this User’s Guide, keep it in a safe place for future reference.

## About safety symbols

Various symbols are used in this User’s Guide and on the product itself to ensure safe use, and to protect you and others against the risk of injury and against material damage. The meaning of each of the symbols is explained below.

 <b>Danger</b>	This symbol indicates information that, if ignored or applied incorrectly, creates the risk of death or serious personal injury.
 <b>Warning</b>	This symbol indicates information that, if ignored or applied incorrectly, could possibly create the risk of death or serious personal injury.
 <b>Caution</b>	This symbol indicates information that, if ignored or applied incorrectly, could possibly create the risk of personal injury or material damage.

## Icon Examples



A triangle indicates a situation against which you need to exercise caution. The example shown here indicates you should take precaution against electric shock.



A circle with a line through it indicates information about an action that you should not perform. The specific action is indicated by the figure inside the circle. The example shown here means disassembly is prohibited.



A black circle indicates information about an action that you must perform. The specific action is indicated by the figure inside the circle. The example shown here indicates you must unplug the power cord from the power outlet.

## Precautions During Use



### Warning

#### ● Smoke, odor, heat, and other abnormalities



Should you ever notice smoke, strange odor, or any other abnormality, immediately stop using the projector. Continued use creates the risk of fire and electric shock. Immediately perform the following steps.

1. Unplug the projector.
2. Contact your original dealer or authorized CASIO service center.

#### ● Malfunction



Immediately stop using the projector if the screen appears abnormal, or if any other abnormal operation occurs even though you are operating the projector correctly. Continued use creates the risk of fire and electric shock. Immediately perform the following steps.

1. Turn off the projector.
2. Unplug the projector.
3. Contact your original dealer or authorized CASIO service center.

## Safety Precautions

---

### ● Power cord



Misuse of the power cord creates the risk of fire and electric shock.

Make sure that you always observe the following precautions.

- Be sure to use only the accessories that come with the projector.
- Make sure that you use a power source with the same voltage as that specified for the projector.
- Do not overload a power outlet with too many devices.
- Do not locate the power cord near a stove.
- Do not use the power cord that comes with the projector with any other device.
- Do not share the outlet supplying power to the projector with other devices. If you are using an extension cord, make sure that the ampere rating of the extension cord is compatible with the power consumption value of this projector.
- Never use the power cord while it is still bundled together.
- Use a conveniently located power outlet that you can reach easily when you need to unplug the projector.



A damaged power cord creates the risk of fire and electric shock.

Make sure that you always observe the following precautions.

- Never place heavy objects on the power cord and never expose it to heat.
- Make sure the power cord is not pinched between the wall and the rack or table where the projector is located, and never cover the power cord with a cushion or other object.
- Never try to modify the power cord, allow it to become damaged, or subject it to excessive bending.
- Do not twist the power cord or pull on it.



Never touch the power cord or plug while your hands are wet.

Doing so creates the risk of electric shock.

- When using this projector in the country where you purchased it, be sure to use the power cord that came with it. Whenever using the projector in another country, be sure to purchase and use a power cord that is rated for the voltage of that country. Also make sure that you are aware of the Safety Standards that apply in that country.



When going out, make sure the projector is in a location away from pets and other animals, and unplug the power plug from the power outlet. A power cord damaged by chewing can cause shorts, and creates the risk of fire.

### ● Water and foreign matter



Never allow water to get on the projector. Water creates the risk of fire and electric shock.



Never place a vase or any other container of water on top of the projector. Water creates the risk of fire and electric shock.



Water or other liquid, or foreign matter (metal, etc.) getting into the projector creates the risk of fire and electric shock. Should anything get inside the projector, immediately perform the following steps.

1. Turn off the projector.
2. Unplug the projector.
3. Contact your original dealer or authorized CASIO service center.

### ● Disassembly and modification



Never try to take the projector apart or modify it in any way. The projector contains a large number of high-voltage components that create the risk of electric shock and burn injury. Also, note that problems caused by unauthorized projector disassembly or modification are not covered by the warranty and are not eligible for repair by CASIO.

Be sure to leave all internal inspection, adjustment, and repair up to your original dealer or authorized CASIO service center.

### ● Dropping and impact



Continued use of the projector after it has been damaged by dropping or other mistreatment creates the risk of fire and electric shock. Immediately perform the following steps.

1. Turn off the projector.
2. Unplug the projector.
3. Contact your original dealer or authorized CASIO service center.

### ● Disposal by burning



Never try to dispose of the projector by burning it. Doing so can cause an explosion, which creates the risk of fire and personal injury.

### ● Looking into the lens or vents while light source unit is on



Never look directly into the lens or vents while light source unit is on. The strong light emitted by the projector creates the risk of eye damage.

### ● Blocking the vents



Never allow the vents to become blocked. Doing so causes internal heat build up, which creates the risk of fire and breakdown of the projector. Touching the projector while it is hot creates the risk of burn injury. Make sure that you always observe the following precautions.

- Allow at least 30cm (11.8 inches) between the projector and walls.
- Do not insert the projector into any space where air circulation is poor.
- Never cover the projector with a blanket or any similar item.
- Locate the projector on a firm, flat surface during use. Never use the projector while it is on a carpet, blanket, towel, seat cushion, or other pliable surface.
- Never stand the projector up on either end during use.

### ● Projector cabinet



Never open the projector's cabinet. Doing so creates the risk of electric shock.

### ● Cleaning



Before cleaning the projector, be sure to turn it off and unplug it from the power outlet. Failure to do so creates the risk of electric shock.

### ● Intake-exhaust vents

The intake-exhaust vents become very hot while the projector is running. Never touch them. Doing so creates the risk of burn injury. The areas near the intake-exhaust vents also become quite hot. Never locate objects made of plastic or other heat-sensitive materials near or under the projector. Doing so creates the risk of deformation and discoloration of the object.

### ● Lens cover

Be sure to remove the lens cover before turning on the projector. Never leave the lens cover attached while the projector is in use.

### ● Location

Never locate the projector in any of the following types of locations. Doing so creates the risk of fire and electric shock.

- Near an area subject to strong vibration
- An area subject to large amounts of moisture or dust
- In a kitchen or other area exposed to oil smoke
- Near a heater, on a heated carpet, or in an area exposed to direct sunlight
- An area subject to temperature extremes (Operating temperature range is 5°C to 35°C (41°F to 95°F)).

### ● Heavy objects

Never place heavy objects on the projector or climb on top of the projector. Doing so creates the risk of fire and electric shock.

### ● Water

Never locate the projector in a bathroom or anywhere else there is the chance that it will be splashed with water.

### ● Unstable location



Never place the projector on an unstable surface or on a high shelf. Doing so can cause it to fall, creating the risk of personal injury.

## Safety Precautions

### ● Using the projector on a base with casters

Whenever using the projector on a base that has casters, make sure that you lock the casters when not moving the base.

### ● Lightening

During a lightening storm, do not touch the plug of the projector's power cord.

### ● Remote controller



Never try to take the remote controller apart or modify it in any way. Doing so creates the risk of electric shock, burn injury, and other personal injury. Be sure to leave all internal inspection, adjustment, and repair up to your original dealer or authorized CASIO service center.



Never allow the remote controller to become wet. Water creates the risk of fire and electric shock.

### ● Radio waves emitted by the wireless adapter (which is provided with some projector models)



Never use this product inside of an aircraft or medical facility, or in any other location where use of such devices is prohibited. Radio waves can have an effect on the operation of electronic equipment and medical equipment, and cause accidents.



Do not use this product in the vicinity of high-precision electronic instruments or electronic devices that handle weak radio signals. Radio waves can have an effect on the operation of such equipment, and cause accidents.

- If you are using a pace maker or any other electronic medical device, be sure to consult your physician or device manufacturer before using this product.

## Caution

### ● Power cord



Misuse of the power cord creates the risk of fire and electric shock. Make sure that you always observe the following precautions.

- When unplugging the power cord, always grasp the plug, and do not pull on the power cord.
- Insert the plug into the power outlet as far as it will go.
- After using the projector, unplug it from the power outlet.
- Unplug the projector from the power outlet if you do not plan to use it for a long time.
- At least once a year, unplug the power plug and use a dry cloth or vacuum cleaner to clear dust from the area around the prongs of the power plug.
- Never use detergent to clean the power cord, especially the power plug and jack.
- Before moving the projector, be sure to turn it off and unplug it from the power outlet first.

### ● Backup of important data



Be sure to keep separate written records of all data stored in projector memory. Memory data can be lost due to breakdown, maintenance, etc.

### ● During projection, make sure there is nothing in front of the lens blocking the light.

An object in front of the lens creates the risk of fire.

### ● Lens effect

Never have an aquarium or any other object that produces a lens effect in front of the projector while the light source unit is on. Such an object creates the risk of fire.

### ● Lens

Never touch the lens with your hand.

### ● Wireless adapter (provided with some projector models)



Keep the wireless adapter out of the reach of small children. Accidental swallowing of a wireless adapter can interfere with proper breathing and create a life-threatening situation.

## Battery Precautions



### Danger

 Should liquid leaking from an alkaline battery get into the eyes, immediately take the following steps.

1. Do not rub the eyes! Wash the eyes with clean water.
2. Contact a physician immediately. Failure to take immediate action can lead to loss of eyesight.

### Warning

Misuse of batteries can cause them to leak and stain the area around them, or to explode, creating the risk of fire and personal injury. Make sure that you always observe the following precautions.

-  • Never try to take batteries apart and do not allow them to become shorted.
- Never expose batteries to heat or throw them into fire.
- Never mix old batteries and new ones.
- Never mix batteries of different types.
- Never try to charge batteries.
-  • Take care that batteries are oriented correctly when you load them.

### Caution

Misuse of batteries can cause them to leak and stain the area around them, or to explode, creating the risk of fire and personal injury. Make sure that you always observe the following precaution.

-  • Use only the type of batteries that is specified for the remote controller.

### ● Dead batteries

Be sure to remove batteries from the remote controller as soon as they go dead.

-  • Remove batteries from the remote controller if you do not plan to use it for a long time.

### ● Disposing of batteries

Make sure that you dispose of used batteries in accordance with the rules and regulations in your local area.

## Lens Cover (XJ-ST145 and XJ-ST155 only)

### Warning

 The lens cover of this Data Projector uses a magnetic attachment. Because of this, it should not be used in the vicinity of anyone wearing a pacemaker or any other electric medical device. Should any problem arise, move the lens cover away from the person experiencing the problem and consult a physician.

### Caution

 Keep the lens cover away from floppy disks, magnetic cards, magnetic tapes, prepaid cards, checks, and any other media that uses magnetic recording. The lens cover can corrupt data recorded on magnetic media.

## Other

### Caution

Allowing dust to build up inside the projector for long periods without cleaning creates the risk of fire and breakdown. Contact your original dealer or authorized CASIO service center once a year about having the interior of the projector cleaned. Note that you will be charged for cleaning.

## Safety Precautions

---

### 3D Glasses

#### Warning



3D images should not be viewed by the types of individuals described below. Doing so creates the risk of loss of health.

- Individuals with heart disease
- Individuals with a history of photodermatitis
- Individuals with epileptic tendencies

#### Caution



Do not view 3D images if you are experiencing any of the symptoms described below.

- When you are in poor physical condition
- When you feel you are losing your health
- Should you ever experience fatigue, loss of health, or abnormal feelings while watching 3D images, stop watching. Continued watching could damage your health.
- Should the 3D image ever start appearing double or lose its three-dimensionality, stop watching. Continued watching can cause eye fatigue.



Avoid watching 3D images for very long periods. Doing so can cause eye fatigue.



Be sure to observe the following precautions when watching 3D images.

#### ● **Take care about nearby people and objects.**

Viewing 3D images can interfere with distance judgment, so you should take care about nearby people and objects when extending your arms or making sudden movements. Failure to do so creates the risk of material damage and personal injury.

#### ● **Use 3D glasses when viewing 3D images.**

Watching 3D images without 3D glasses can cause eye fatigue. Always use the specified 3D glasses whenever viewing 3D images.

#### ● **You need to wear your glasses or any other devices you normally use for vision correction.**

If you normally wear glasses or contact lenses, you should be wearing them when you watch 3D images with the 3D glasses. Failure to do so creates the risk of eye fatigue or abnormal vision.



The normal minimum age for viewing 3D images is six. When 3D images are being watched by a small child, a competent adult should be on hand to monitor the child, to ensure that the 3D images are suitable for the child, that the child does not watch the 3D images for too long an uninterrupted period, etc.



# Operating Precautions

## About the Light Source Unit

- The projector's light source unit uses a laser and LED.
- The life of the light source unit is rated at approximately 20,000 hours. The actual life will depend on use conditions, the settings configured on the setup menu, and differences between each individual light source unit.
- The light source unit is warranted for the period noted on the warranty certificate or for 6,000 hours, whichever comes first.
- The failure of the light source unit to light or a noticeable drop in light source unit brightness indicates the end of the light source unit's life. Contact your original dealer or authorized CASIO service center for replacement. Note that problems caused by unauthorized projector disassembly or modification are not covered by the warranty and are not eligible for repair by CASIO.

## Laser Precautions

This projector is a Class 1 laser device that conforms with IEC 60825-1.

- This projector has a built-in laser module. Disassembly or modification is very dangerous and should never be attempted.
- Any operation or adjustment not specifically instructed by the user's guide creates the risk of hazardous laser radiation exposure.

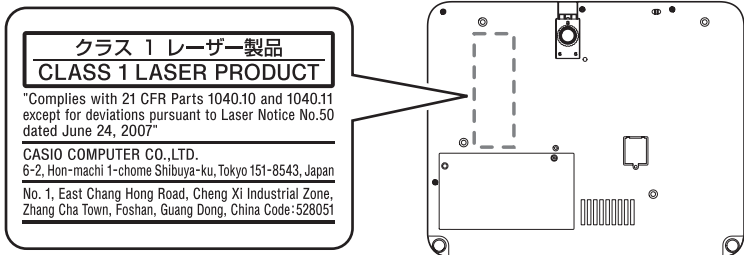

Bottom

### Other Precautions

This projector is made of precision components. Failure to observe the following precautions can result in inability to correctly save data and malfunction.

● **Never use or store the projector in the following locations. Doing so creates the risk of malfunction of and damage to the projector.**

- Locations subjected to electrostatic charge
- Locations subjected to temperature extremes
- Locations where there is extreme moisture
- Locations subjected to sudden temperature changes
- Locations where there is a lot of dust
- On a shaky, slanted, or otherwise unstable surface
- Locations where there is the danger of getting wet

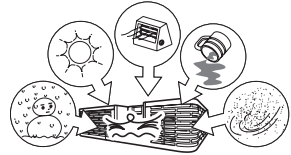

● **Avoid using the projector under the following conditions. Such conditions create the risk of malfunction of and damage to the projector.**

- Avoid areas subject to temperature extremes (operating temperature range is 5°C to 35°C (41°F to 95°F)).
- Never place heavy objects on the projector or climb on top of the projector.
- Never insert or allow foreign objects to drop into the projector.
- Never place a vase or any other container of water on top of the projector.



● **Whenever setting the projector down or performing any operation that involves moving or reorienting it, take care that you do not pinch your fingers under the projector.**

● **Never leave a dead battery inside the remote controller for a long time.**

A dead battery can leak, which leads to malfunction of and damage to the remote controller.

● **Clean with a soft, dry cloth.**

When very dirty, use a soft cloth that has been dampened in a weak solution of water and a mild neutral detergent. Wring all excess water from the cloth before wiping. Never use thinner, benzine, or any other volatile agent to clean the projector. Doing so can remove its markings and cause staining of the case.

● **Missing Screen Dots**

Though this projector is manufactured using the most advanced digital technology available today, some of the dots on the screen may be missing. This is normal, and does not indicate malfunction.

● **Never subject the projector to strong impact while it is projecting.**

If the projector is accidentally subjected to strong impact, the projection image will momentarily go blank. The image will reappear after some time, but it may be the wrong color or it may be accompanied by an error message.

If the projected image is the wrong color, re-select the current input source. If this does not return the projected image to its proper color, use the procedure under "To turn off the projector" on page E-15 to turn projector power off and then back on again.

If the image reappears with an error message, correct the problem in accordance with the indicator explanations under "Error Indicators and Warning Messages" in the User's Guide on the CD-ROM that comes with the projector.

### ● Keystone Correction and Image Quality

Performing keystone correction causes the image to be compressed before it is projected. This can result in distortion of the image or a loss of image quality. If this happens, change the orientation of the projector and/or screen so it conforms as much as possible to the illustration under “Setting Up the Projector” on page E-12.

If image quality is the highest priority, turn off auto keystone correction and position the projector so it is pointed straight at the screen.

- Even if your projector is still within the warranty period, you will be charged for repair if a problem is due to running the projector non-stop for very long periods (like 24 hours) or if the projector was set up and used without following the “Setup Precautions” on page E-13 of this manual.

### Precaution when Handling the Projector after Use

The projector’s front intake-exhaust vents and the area around the vents become very hot during operation, and will still be hot immediately after turning off the projector. Because of this, you should hold the sides of the projector as shown in the illustration whenever moving it.

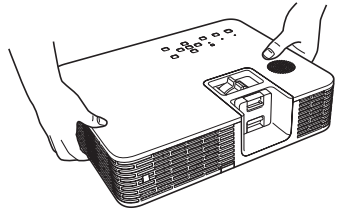

### Stowing the Projector in the Carrying Bag

Make sure the projector is no longer warm before stowing it in the carrying bag.

### Cleaning the Projector

- Periodically clean the projector exterior, lens, intake vents, and intake-exhaust vents on a regular basis.
- Dust and dirt tend to collect around the vents. Because of this, you should use a vacuum cleaner to clean away accumulated dust and dirt periodically.
- Continued use of the projector after dust has accumulated around the vents can cause overheating of internal components and lead to malfunction.

# Unpacking

As you unpack the projector, check to make sure that all of the items listed below are present.

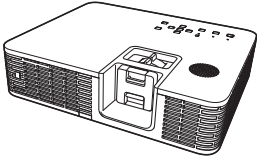

DATA PROJECTOR



Remote Controller  
(YT-120)

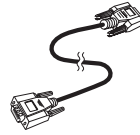

Mini D-Sub Cable

- Test Batteries (AAA-size × 2)
- AC Power Cord
- Carrying Bag
- CD-ROM
- Setup Guide
- "Read this first" Sheet
- Warranty
- Wireless adapter (Provided with models equipped with USB ports only.)

# General Guide

## CLASS 1 LASER PRODUCT

### ● XJ-H1600/XJ-H1650/XJ-H1700/XJ-H1750

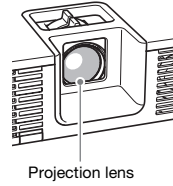
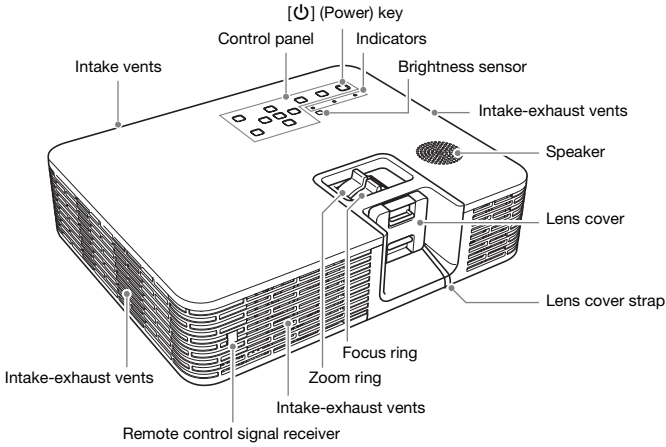

### ● XJ-ST145/XJ-ST155

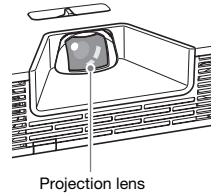
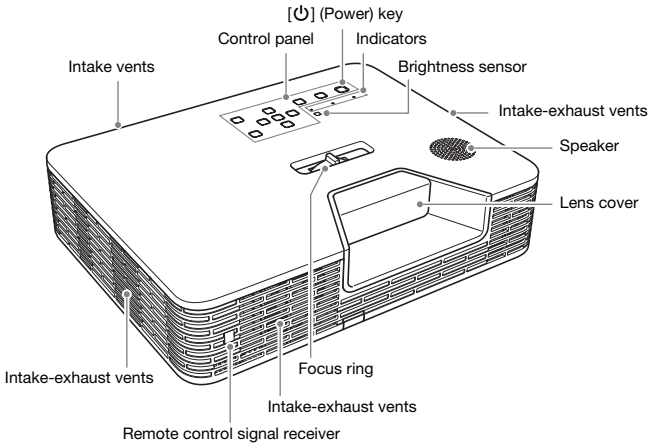

# Getting Ready

## Loading Remote Controller Batteries

### Important!

- Be sure to use alkaline batteries only.



### Caution

RISK OF EXPLOSION IF BATTERY IS REPLACED BY AN INCORRECT TYPE. DISPOSE OF USED BATTERIES ACCORDING TO THE INSTRUCTIONS.

1. Open the battery cover on the back of the remote controller.
2. Load two new batteries into the case, making sure that their positive (+) and negative (-) ends are facing correctly.

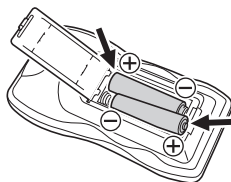
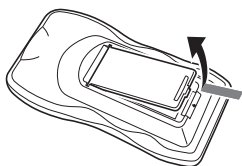

3. Close the battery cover on the back of the remote controller.

### Replacing Remote Controller Batteries

Open the battery cover on the back of the remote controller, replace the old batteries with new ones, and then close the battery cover.

### Important!

- To avoid running down the batteries, store the remote control unit so its buttons are not pressed inadvertently.

## Setting Up the Projector

Place the projector onto a table, desk, or stand that is level and firm, making sure you allow enough room around it. Best results can be obtained when the projector is pointed directly at the screen, and not at an angle.

### XJ-H1600/XJ-H1650/XJ-H1700/XJ-H1750

Screen

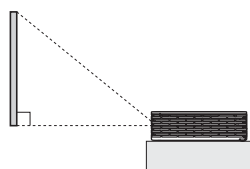

### XJ-ST145/XJ-ST155

Screen

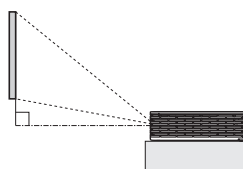

- The projector can be configured for projection from the back of a screen. For details, see the User's Guide on the CD-ROM that comes with the projector.

## Setup Precautions

- Use a conveniently located power outlet that you can reach easily when you need to unplug the projector.
- Do not allow any objects to be within the area indicated by the dashed line below, which is an area within 30cm (11.8 inches) of the projector. Keep all obstacles and other objects at least 30cm away from the projector's vents.
- Airflow from air conditioning equipment can blow the heat being exhausted from the area around the projector's lens in a way that causes heat ripples to appear in the projected image. If this happens, adjust the airflow of the air conditioning equipment or move the projector.

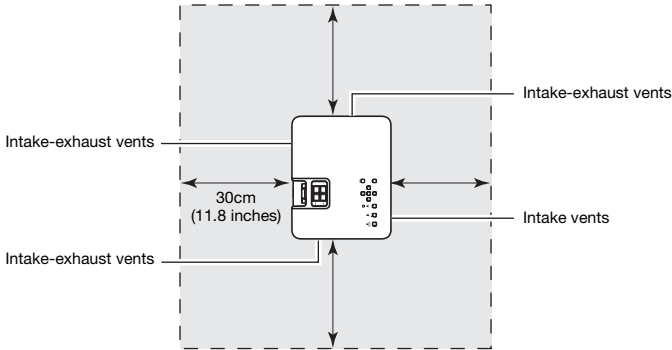

## Changing the Projector Elevation Angle

1. Lift up the front of the projector and press the release button ①.
  - This will cause the front foot ② to extend from the projector.

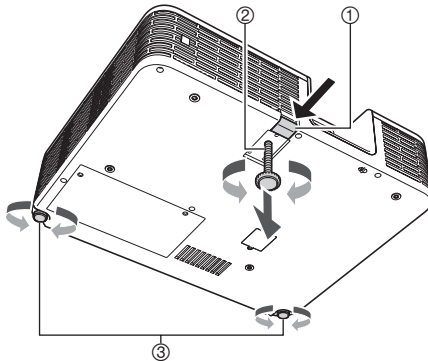

2. While holding down the release button, raise and lower the front of the projector. When the front foot is approximately the height you want, release the release button.
  - The front foot will lock at the position where you release the release button.

## Getting Ready

3. Make fine adjustments to the elevation angle of the projector by rotating the front foot.
4. Make fine adjustments to the horizontal tilt of the projector by rotating the rear feet ③.

### Important!

- To retract the front foot, hold down the release button and slide the front foot back into the projector. Never try to forcibly change the front foot position without pressing the release button.

## Connecting a Computer to the Projector

Connect the projector's COMPUTER IN 1 or COMPUTER IN 2 terminal to the RGB terminal of a computer as shown in the illustration below.

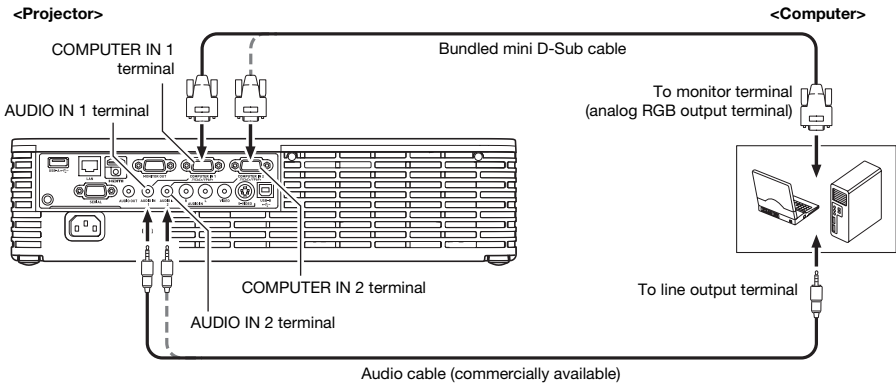

### Important!

- Always turn off the projector and the computer before connecting them.
- Take care so the volume level of the computer is not set too high.

### NOTE

- To connect to an external input source other than a computer (video device, etc.), see the User's Guide on the CD-ROM that comes with the projector.



# Starting and Stopping Projection

## To start projection

1. Use the bundled AC power cord to plug the projector into a power outlet.

### NOTE

- This product is also designed for IT power distribution system with phase-to-phase voltage 230V.

2. Turn on the computer that is connected to the projector.
3. If the projector lens cover is covering the lens, remove it.
  - XJ-H1600/XJ-H1650/XJ-H1700/XJ-H1750: Insert your fingers into its recesses and squeeze towards the middle.
  - XJ-ST145/XJ-ST155: The lens cover is held on by magnetic force, so simply pull to release it.
4. Press the [⏻] (Power) key.
  - The first time you turn on the projector, a “Language” window will appear in the center of the projection screen. Select the language you want.
5. Select the input source
  - Press the [INPUT] key to display a list of input sources. Use the [▼] and [▲] keys to select the projector terminal (Computer 1 or Computer 2) where the RGB output from the computer is connected. Finally, press the [ENTER] key.
6. Use the zoom ring of the projector’s lens to adjust the size of the projected image (XJ-H1600, XJ-H1650, XJ-H1700 and XJ-H1750 only).
7. Use the focus ring to adjust the focus.

### NOTE

- The projector has a keystone correction feature that prevents distortion of the projected image when projecting from an angle. The projector detects when it is at a vertical angle to the screen and performs keystone correction automatically. You can use the [KEystone +] and [KEystone -] keys to adjust keystone correction manually.

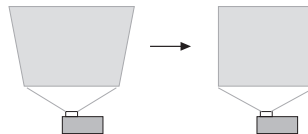

## To turn off the projector

1. Press the [⏻] (Power) key.
  - This causes the confirmation message to appear. If you do not turn off the projector the confirmation message will disappear automatically after about 10 seconds. The confirmation message will also disappear if you press the [ESC] key.
2. To turn off the projector, press the [⏻] (Power) key again in response to the confirmation message.
3. After checking to make sure that the POWER/STANDBY indicator has stopped flashing amber and remains lit, unplug the AC power cord from the power outlet.

# Using the CD-ROM

The CD-ROM contains software for each projector model and PDF files with User's Guides. In order to read the User's Guide, you need to have Adobe® Reader® installed on your computer.

## To view the contents of a User's Guide (PDF)

1. Place the CD-ROM that comes with the projector into your computer's CD-ROM drive.
2. Perform either of the following operations.
  - If the CD-ROM menu screen appears:
    - ① On the menu screen, click the [Open Folder] button to the right of "User's Guide".
    - ② When the User's Guide folder opens, open the folder that corresponds to the language you want to use.
  - If the CD-ROM menu screen does not appear:
    - ① On your computer, navigate to the CD-ROM and then open it.
    - ② Open the User's Guide folder and then open the folder that corresponds to the language you want to use.
3. Double-click the name of the manual you want to view.

Manual Name	Description	File Name
User's Guide	Contains detailed information about the projector.	UsersGuide_English.pdf
USB Function Guide (USB port models only)	Explains operations when connecting USB memory, a CASIO Multi Projection Camera (YC-400, YC-430), or a graphic scientific calculator to the USB port on the back of the projector.	USB_Guide_English.pdf
Wireless Function Guide (USB port models only)	Explains operations when establishing a wireless LAN connection between the projector and a computer and projecting the computer's display contents.	WirelessGuide_English.pdf

- Double-clicking a file name starts up Adobe Reader and displays the contents of the applicable manual.
- On some systems, the ".pdf" extension may not be displayed at the end of the file name.



















## Installing the Software (USB port models only)



The software described in the table below can be installed from the CD-ROM menu screen that appears when you place the CD-ROM that comes with the projector into your computer's CD-ROM drive. For details about installing the software, see the manuals in the "Refer to:" column of the table.

Software Name	Description	Refer to:
Wireless Connection 3	Software that makes it possible to establish a wireless connection between a projector and computer.	Wireless Function Guide (WirelessGuide_English.pdf)
EZ-Converter FA	Software that converts PowerPoint files to ECA or PtG files.	USB Function Guide (USB_Guide_English.pdf)
ArcSoft MediaConverter 3 for CASIO Projector	Software for converting movie files.	
Multi Projection Camera Update Software	Software for updating the firmware of the YC-400 Multi Projection Camera.	

# Indicators

Indicators keep you informed about the current operational status of the projector. The following shows what the indicators look like when operation is normal.

When the indicators appear like this:			It means this:
POWER/ STANDBY  Amber	LIGHT  Amber	TEMP  Amber	You have just plugged the AC power cord into a power outlet. Wait until the projector enters the standby state (see below) before trying to turn on power.
 Amber			Standby state: The AC power cord is plugged in and the projector is in standby.
 Green	 Amber	 Amber	Projector is warming up after being turned on.
 Green			Projector is on and standing by for use.
 Amber			Projector is performing internal power down processes.
 Green	 Green		"On (Auto)" or "On (Manual)" is selected for the projector's Eco Mode setting.

 : Lit       : Flashing       : Unlit

- When a warning message appears on the projection screen, or when the POWER, TEMP, and LIGHT indicators are lit or flashing in a pattern other than those shown above, it means that a projector error has occurred. For details about indicators and warning messages, see the User's Guide on the CD-ROM that comes with the projector.

# Troubleshooting

Check the following items whenever you experience any problem with the projector.

Problem	Cause and Recommended Action
Power does not turn on.	<ul style="list-style-type: none"> <li>● If the POWER/STANDBY indicator is not lit, the AC power cord is not connected correctly. Connect the AC power cord correctly.</li> <li>● If the TEMP or LIGHT indicator remains flashing or lit, it means some type of error has occurred. See "Error Indicators and Warning Messages" in the User's Guide (UsersGuide_English.pdf).</li> </ul>
No image is projected or the projected image is abnormal.	<ul style="list-style-type: none"> <li>● The computer or video device connected to the projector is not turned on or it is not outputting a video signal. Make sure the connected computer or video device is turned on, and perform the required operation on it to output a video signal.</li> <li>● The correct output source is not selected on the projector. On the projector, select the correct input source that corresponds to the connected device.</li> <li>● Images may not project correctly when you have the component output terminal of a video device connected to the COMPUTER IN (1 or 2) terminal of the projector. Connect to the VIDEO terminal or S-VIDEO terminal of the projector.</li> </ul>
Image color or display is very abnormal.	<p>The wrong option ("Component" or "RGB") may be selected for the "Input Settings → COMPUTER 1 terminal (or COMPUTER 2 terminal)" setting on the setup menu. The image will not be projected correctly if "Component" is selected while the projector's COMPUTER IN (1 or 2) terminal is connected to the RGB output terminal of a computer, or if "RGB" is selected while the projector's COMPUTER IN (1 or 2) terminal is connected to the component video output terminal of a video device. On the setup menu, select "Auto" for the "Input Settings → COMPUTER 1 terminal (or COMPUTER 2 terminal)" setting. See the User's Guide (UsersGuide_English.pdf).</p>
I can't understand messages or menus because they are the wrong language.	<p>Perform the following operation to select the language you want. See the User's Guide (UsersGuide_English.pdf).</p> <ol style="list-style-type: none"> <li>1. Press the [MENU] key to display the setup menu.</li> <li>2. If the input signal is HDMI, press [▼] four times and then press the [ENTER] key. If the input signal is not HDMI, press [▼] five times and then press the [ENTER] key.</li> <li>3. Press [▲] twice and then press the [ENTER] key to display the language selection menu.</li> <li>4. Use the [▼] and [▲] keys to move the highlighting to the language you want to select and then press the [ENTER] key.</li> <li>5. Press the [MENU] key to exit the setup menu.</li> </ol>
No sound	<ul style="list-style-type: none"> <li>● The projector's volume level setting may be too low or muted. Press the remote controller [VOLUME] key and then use [▼] and [▲] to adjust the volume level. See the User's Guide (UsersGuide_English.pdf).</li> <li>● The volume level setting of the device connected to the projector is too low or the other device is not outputting audio. Adjust the volume level of the connected device.</li> <li>● The audio output of the connected device may not be connected correctly to the projector's AUDIO IN (1 or 2) terminal or AUDIO IN L/R terminal. Check the connection, referring to one of the following (depending on the type of connected device): "Connecting a Computer to the Projector" in this manual or "Connecting to a Video Device" in the User's Guide (UsersGuide_English.pdf)</li> <li>● "Line" is selected for the setup menu "Option Settings 2 → Audio Out" setting. Change the "Audio Out" setting to "Speaker". See the User's Guide (UsersGuide_English.pdf).</li> </ul>

Problem	Cause and Recommended Action
Strange color	The input signal may not match projector settings. Try doing the following. See the User's Guide (UsersGuide_English.pdf). <ul style="list-style-type: none"> <li>- Use the [BRIGHT] key to adjust image brightness.</li> <li>- Use the [COLOR MODE] key to change the color mode.</li> <li>- On the setup menu, use "Image Adjustment 1 → Color Balance" to adjust the projection image color balance.</li> </ul>
Text is blurry.	<ul style="list-style-type: none"> <li>● The image may be out of focus. Rotate the focus ring to focus.</li> <li>● The current frequency and/or phase setting do not match the input signal. (Applies only when the input source is an RGB signal.) Press the [AUTO] key to execute an automatic adjustment operation.</li> <li>● On the setup menu, perform the "Image Adjustment 2 → Frequency" and "Image Adjustment 2 → Phase" adjustments. (Applies only when the input source is an RGB signal.) See the User's Guide (UsersGuide_English.pdf).</li> <li>● If the input source is a video camera or document camera, check to make sure there is no problem with the input source device.</li> </ul>
The message "Please input the password." appears and further operation is not possible.	The "Option Settings 1 → Power On Password" setting on the setup menu is turned on, so the projector is password protected. Input the correct password, and then press the [ENTER] key. See the User's Guide (UsersGuide_English.pdf).
The remote controller does not work.	<ul style="list-style-type: none"> <li>● The remote controller batteries may be dead. Replace the batteries.</li> <li>● The remote controller may be too far from the projector. Make sure the remote controller is within the allowable range when you operate it. See the User's Guide (UsersGuide_English.pdf).</li> </ul>
The TEMP or LAMP indicator is flashing or lit.	An error occurred. See "Error Indicators and Warning Messages" in the User's Guide (UsersGuide_English.pdf).
The light source unit does not light.	The light source unit has reached the end of its service life or it is malfunctioning. Contact your original dealer or authorized CASIO service center for replacement.

## **important!**

● Try performing the following steps, which may or may not return the projector to normal operation.

1. Unplug the AC power cord and wait for at least 10 minutes.
2. Plug the power cord back in and turn the projector back on again.

● If normal operation does not resume after you perform the above steps, take the projector to your retailer or authorized CASIO service center.

# Main Specifications

Model Name	XJ-H1600/ XJ-H1650	XJ-H1700/ XJ-H1750	XJ-ST145	XJ-ST155
Brightness (ANSI Lumens)	3500	4000	2500	3000
Environment	Operating Temperature: 5 to 35°C (41 to 95°F) Operating Humidity: 20 to 80% (non-condensation) Operating Altitude: 0 to 3,000 meters (0 to 10,000 feet) above sea level			
Power	Requirements 100-240V AC, 50/60Hz, 5.1A-2.2A		Requirements 100-240V AC, 50/60Hz, 5.1A-2.2A	
Approximate Dimensions	400 (W) × 323 (D) × 106 (H) mm (15.7" × 12.7" × 4.2")		420 (W) × 323 (D) × 106 (H) mm (16.5" × 12.7" × 4.2")	
Weight	Approximately 7.1kg (15.7lbs)		Approximately 7.1kg (15.7lbs)	

Specifications are subject to change without notice.

**GUIDELINES LAID DOWN BY FCC RULES FOR USE OF THIS UNIT IN THE U.S.A. (not applicable to other areas).**

### **NOTICE**

This equipment has been tested and found to comply with the limits for a Class B digital device, pursuant to Part 15 of the FCC Rules. These limits are designed to provide reasonable protection against harmful interference in a residential installation. This equipment generates uses and can radiate radio frequency energy and, if not installed and used in accordance with the instructions, may cause harmful interference to radio communication. However, there is no guarantee that interference will not occur in a particular installation. If this equipment does cause harmful interference to radio or television reception, which can be determined by turning the equipment off and on, the user is encouraged to try to correct the interference by one or more of the following measures:

- Reorient or relocate the receiving antenna.
- Increase the separation between the equipment and receiver.
- Connect the equipment into an outlet on a circuit different from that to which the receiver is connected.
- Consult the dealer or an experienced radio/TV technician for help.

### **FCC WARNING**

Changes or modifications not expressly approved by the party responsible for compliance could void the user's authority to operate the equipment.

Proper connectors must be used for connection to host computer and/or peripherals in order to meet FCC emission limits.

Connector cable....XJ-H1600/H1650/H1700/H1750/ST145/ST155 unit to PC

### **Declaration of Conformity**

Model Number: XJ-H1600/H1650/H1700/H1750/ST145/ST155

Trade Name: CASIO COMPUTER CO., LTD.

Responsible party: CASIO AMERICA, INC.

Address: 570 MT. PLEASANT AVENUE, DOVER, NEW JERSEY 07801

Telephone number: 973-361-5400

This device complies with Part 15 of the FCC Rules, Operation is subject to the following two conditions:

(1) This device may not cause harmful interference, and (2) this device must accept any interference received, including interference that may cause undesired operation.

## FCC Information

This device, IEEE 802.11g Wireless LAN USB Adapter, complies with Part 15 of the FCC Rules. Operation is subject to the following two conditions: (1) this device may not cause harmful interference, and (2) this device must accept any interference received; including interference that may cause undesired operation.

### Federal Communications Commission (FCC) Statement

This Equipment has been tested and found to comply with the limits for a Class B digital device, pursuant to Part 15 of the FCC rules. These limits are designed to provide reasonable protection against harmful interference in a residential installation. This equipment generates, uses and can radiate radio frequency energy and, if not installed and used in accordance with the instructions, may cause harmful interference to radio communications. However, there is no guarantee that interference will not occur in a particular installation. If this equipment does cause harmful interference to radio or television reception, which can be determined by turning the equipment off and on, the user is encouraged to try to correct the interference by one or more of the following measures:

- Reorient or relocate the receiving antenna.
- Increase the separation between the equipment and receiver.
- Connect the equipment into an outlet on a circuit different from that to which the receiver is connected.
- Consult the dealer or an experienced radio/TV technician for help.

**Warning: Changes or modifications to this unit not expressly approved by the party responsible for compliance could void the user authority to operate the equipment.**

Tested to comply with FCC standard. FOR HOME OR OFFICE USE.



### FCC RF Radiation Exposure Statement:

1. This equipment complies with FCC RF radiation exposure limits set forth for an uncontrolled environment, under 47 CFR 2.1093 paragraph (d)(2).
2. This Transmitter must not be co-located or operating in conjunction with any other antenna or transmitter.

The **IEEE 802.11g Wireless LAN USB Adapter** has been tested to the FCC exposure requirements (Specific Absorption Rate).

**FCC** Tested To Comply With FCC Standards  
FOR HOME OR OFFICE USE

#### FOR CALIFORNIA USA ONLY

Perchlorate Material – special handling may apply.  
See [www.dtsc.ca.gov/hazardouswaste/perchlorate](http://www.dtsc.ca.gov/hazardouswaste/perchlorate).

This Class B digital apparatus complies with Canadian ICES-003.  
Cet appareil numérique de la classe B est conforme à la norme NMB-003 du Canada.



**HDMI**<sup>®</sup>  
HIGH-DEFINITION MULTIMEDIA INTERFACE

**CASIO®**

**CASIO COMPUTER CO.,LTD.**  
6-2, Hon-machi 1-chome  
Shibuya-ku, Tokyo 151-8543, Japan

## Free Manuals Download Website

<http://myh66.com>

<http://usermanuals.us>

<http://www.somanuals.com>

<http://www.4manuals.cc>

<http://www.manual-lib.com>

<http://www.404manual.com>

<http://www.luxmanual.com>

<http://aubethermostatmanual.com>

Golf course search by state

<http://golfingnear.com>

Email search by domain

<http://emailbydomain.com>

Auto manuals search

<http://auto.somanuals.com>

TV manuals search

<http://tv.somanuals.com>